



This is a digital copy of a book that was preserved for generations on library shelves before it was carefully scanned by Google as part of a project to make the world's books discoverable online.

It has survived long enough for the copyright to expire and the book to enter the public domain. A public domain book is one that was never subject to copyright or whose legal copyright term has expired. Whether a book is in the public domain may vary country to country. Public domain books are our gateways to the past, representing a wealth of history, culture and knowledge that's often difficult to discover.

Marks, notations and other marginalia present in the original volume will appear in this file - a reminder of this book's long journey from the publisher to a library and finally to you.

Usage guidelines

Google is proud to partner with libraries to digitize public domain materials and make them widely accessible. Public domain books belong to the public and we are merely their custodians. Nevertheless, this work is expensive, so in order to keep providing this resource, we have taken steps to prevent abuse by commercial parties, including placing technical restrictions on automated querying.

We also ask that you:

- + *Make non-commercial use of the files* We designed Google Book Search for use by individuals, and we request that you use these files for personal, non-commercial purposes.
- + *Refrain from automated querying* Do not send automated queries of any sort to Google's system: If you are conducting research on machine translation, optical character recognition or other areas where access to a large amount of text is helpful, please contact us. We encourage the use of public domain materials for these purposes and may be able to help.
- + *Maintain attribution* The Google "watermark" you see on each file is essential for informing people about this project and helping them find additional materials through Google Book Search. Please do not remove it.
- + *Keep it legal* Whatever your use, remember that you are responsible for ensuring that what you are doing is legal. Do not assume that just because we believe a book is in the public domain for users in the United States, that the work is also in the public domain for users in other countries. Whether a book is still in copyright varies from country to country, and we can't offer guidance on whether any specific use of any specific book is allowed. Please do not assume that a book's appearance in Google Book Search means it can be used in any manner anywhere in the world. Copyright infringement liability can be quite severe.

About Google Book Search

Google's mission is to organize the world's information and to make it universally accessible and useful. Google Book Search helps readers discover the world's books while helping authors and publishers reach new audiences. You can search through the full text of this book on the web at <http://books.google.com/>

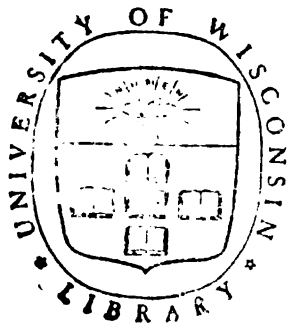

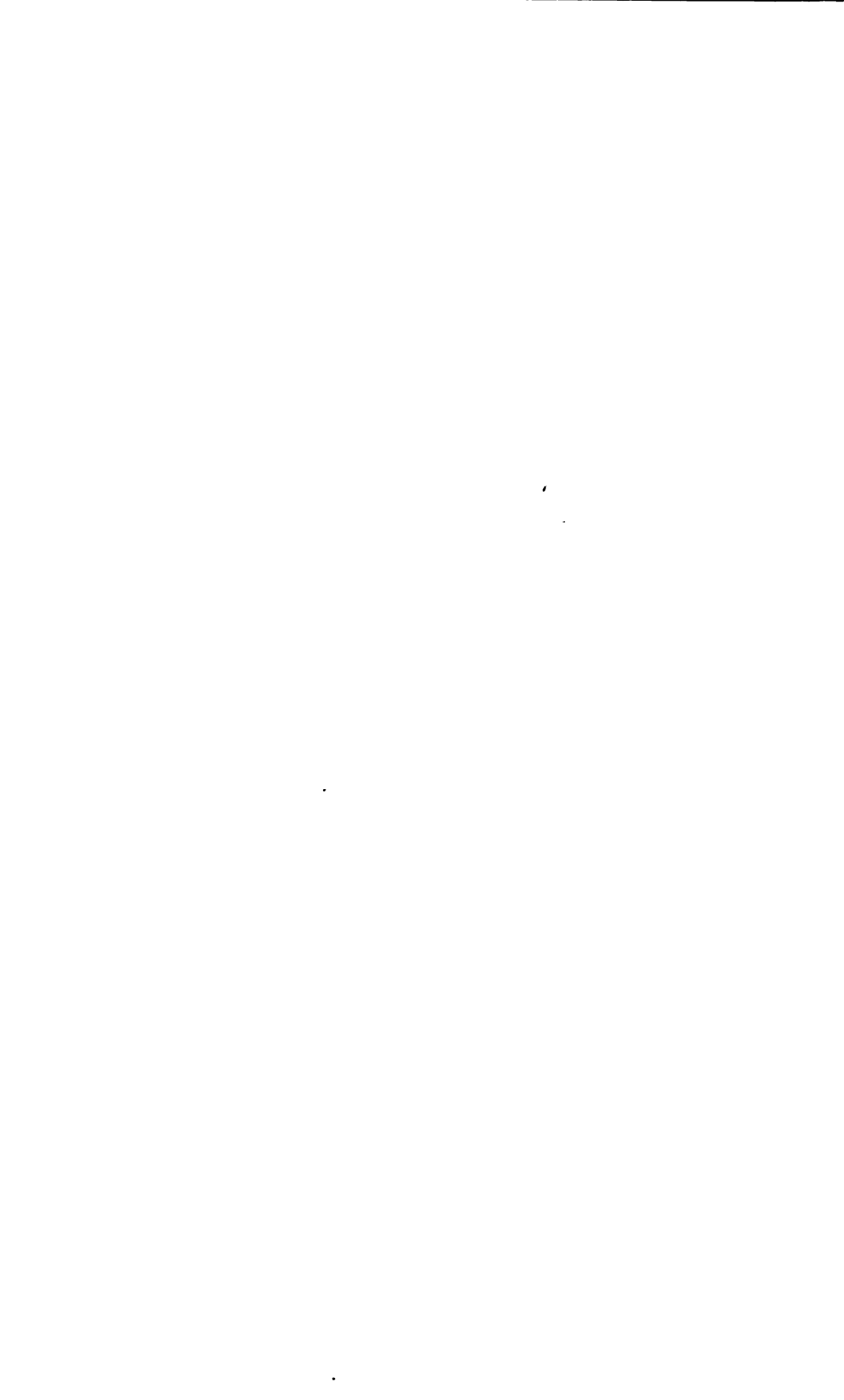

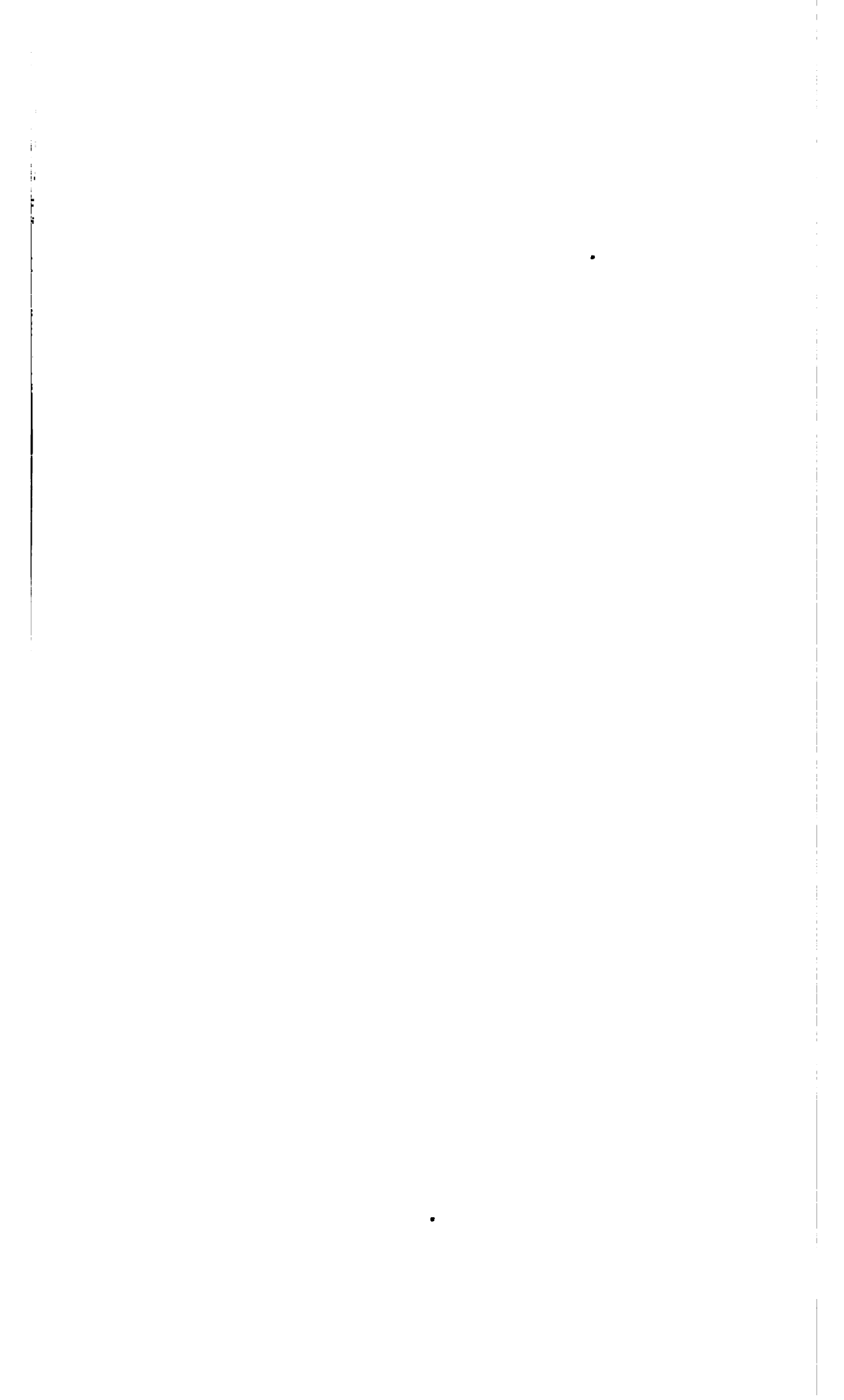

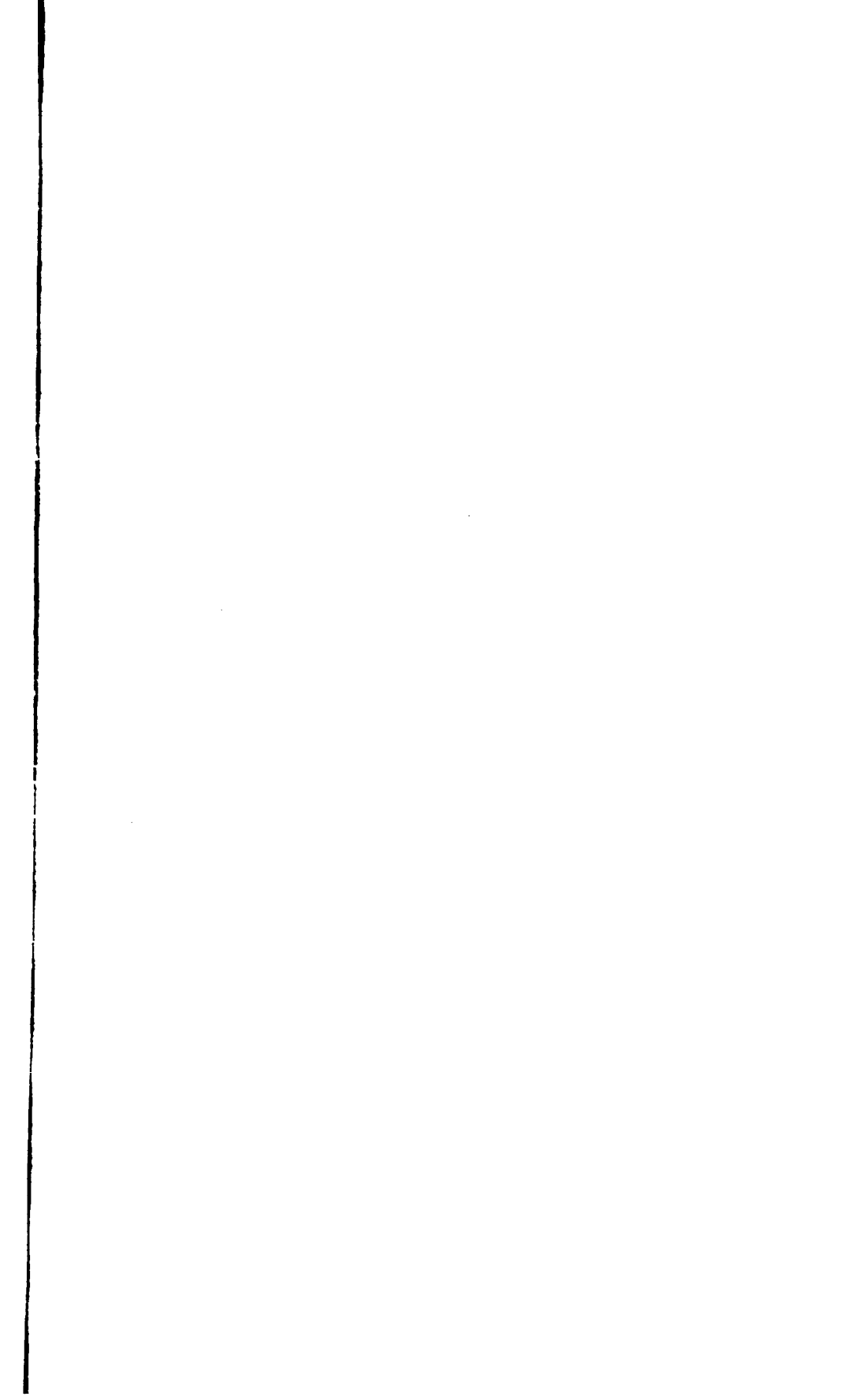



CYCLOPÆDIA

OF

BIBLICAL,

THEOLOGICAL, AND ECCLESIASTICAL

LITERATURE.

PREPARED BY

THE REV. JOHN M'CLINTOCK, D.D.,

AND

JAMES STRONG, S.T.D.

VOL. II.—C, D.



NEW YORK:
HARPER & BROTHERS, PUBLISHERS,
FRANKLIN SQUARE
1868.

Entered, according to Act of Congress, in the year one thousand eight hundred
and sixty-eight, by

HARPER & BROTHERS,

In the Clerk's Office of the District Court of the Southern District of New York.

BR
5112
2

P R E F A C E.

In the Preface to the first volume of this work it was stated that the department of Biblical Literature is exclusively in the charge of Dr. STRONG, who is responsible for all the articles in that field. It may be proper to add that this department embraces not merely Bible names, but also all branches of Biblical introduction, including such articles, for instance, as *Canon of Scripture, Commentary, Concordance, Criticism, Cross, I, II, &c.*; also, Biblical philology, manuscripts and versions, and many cognate subjects, such as *Cabala, Cosmogony, Cuneiform Inscriptions, Decalogue, etc.* In this department the Dictionaries of Kitto and Smith are freely used, all the important matter of both being incorporated into these pages, with references at the end to the authority cited. The range of this department, however, is greatly extended beyond the scope of these or any similar works heretofore published.

In Dr. M'CLINTOCK'S department, all verbal citations are noted by quotation marks. If this is omitted in any case, it is by accident. In this department, also, the names of the writers of special articles are indicated by their initials in the list at the end of the volume, as follows:

- W. W. A.—The Rev. W. W. ANDREWS, Wethersfield, Conn.
- G. F. C.—Professor G. F. COMFORT, Alleghany College.
- D. D.—The Rev. DANIEL DE VINNE, New York.
- R. D.—The Rev. ROBERT DAVIDSON, D.D., Huntingdon, L. I.
- F. W. F.—The Rev. F. W. FLOCKEN, Missionary of the Methodist Episcopal Church, Tultscha, Bulgaria.
- H. G.—Mr. HENRY GRAHAM, Middle Class, Drew Theological Seminary.
- G. F. H.—Professor GEORGE F. HOLMES, University of Virginia.
- R. D. H.—Professor R. D. HITCHCOCK, D.D., Union Theological Seminary, New York.
- H. H.—The Rev. H. HARBAUGH, D.D., late President of Theological Seminary, Mercersburgh, Pa.
- J. F. H.—The Rev. JOHN F. HURST, D.D., Mission Institute, Bremen, Germany.
- J. K. J.—The Rev. J. K. JOHNSTON, Canada.
- J. B. L.—The Rev. J. B. LOGAN, editor of *Western Cumberland Presbyterian*, Alton, Ill.
- J. W. M.—Professor J. W. MARSHALL, late of Dickinson College.
- B. H. N.—Professor B. H. NADAL, D.D., Drew Theological Seminary.
- W. K. P.—The Rev. W. K. PENDLETON, D.D., Bethany, Va.
- J. N. P.—JULES N. PROESCHEL, Paris, France.
- W. R. P.—The Rev. W. R. POWERS, Norfolk, N. Y.
- A. S. Q.—The Rev. A. S. QUINT, D.D., editor of *Congregational Quarterly*, Boston.
- A. S.—The Rev. ABEL STEVENS, D.D.
- E. de S.—The Rev. E. DE SCHWEINITZ, editor of the *Moravian*, Bethlehem, Pa.
- A. J. S.—Professor ALEXANDER J. SCHEM, New York.
- P. S.—The Rev. PHILIP SCHAFF, D.D., New York.
- C. C. T.—The Rev. C. C. TIFFANY, Protestant Episcopal Church, Fordham, N. Y.
- M. L. S.—Professor M. L. STOEVER, Pennsylvania College, Gettysburg.
- W. J. R. T.—The Rev. W. J. R. TAYLOR, D.D., Secretary of American Bible Society, New York.
- J. P. W.—The Rev. J. P. WESTERVELT, Paterson, N. J.
- H. C. W.—The Rev. H. C. WESTWOOD, D.D., Princeton, N. J.
- T. D. W.—The Rev. THEODORE D. WOOLSEY, D.D., President of Yale College.
- J. H. W.—J. H. WORMAN, A.M., Librarian of Drew Theological Seminary.

The greater part of the articles for this Cyclopædia are already prepared, nearly up to the end of the alphabet; but there are numerous subjects that can only be treated advantageously at or near the time of printing. All the articles are revised *de novo* as the work goes through the press, and the latest literature, in new books as well as in the journals of all nations, is consulted in this revision. The succeeding volumes may therefore be expected as rapidly as they can be carried through the press.

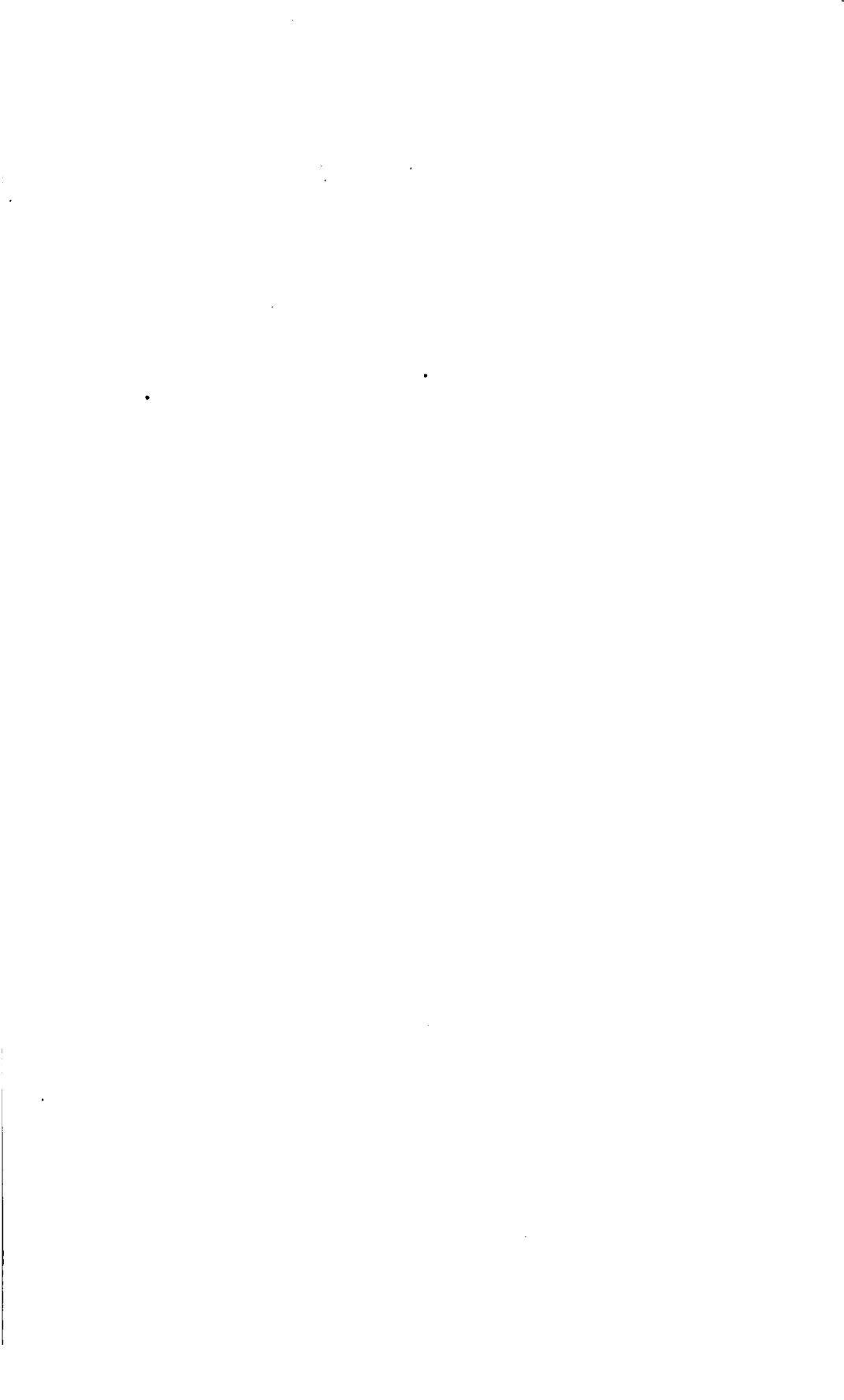

LIST OF WOOD-CUTS IN VOL. II

Cabalistic Diagrams.....	Page 2	3 <i>Chamaelo Africana</i>	Page 205	205 Oriental Outer-garment.....	Page 583
Coin of Caesarea Palestina.....	10	8 <i>Ovis Tragelaphus</i>	205	205 Oriental Travelling Dress.....	583
Cave at Banias.....	10	10 Ancient Egyptian Singers.....	208	208 Oriental Sleeves, Girded.....	583
Oriental Bird-cages.....	11	11 Ancient Egyptian War Car.....	214	214 Oriental Booths.....	584
Oriental Calamus.....	17	17 Egyptian War Chariot.....	215	215 Oriental Lodge in Melon-patch.....	584
Bad Cross of Calatrava.....	18	18 Egyptian Chariot-makers.....	215	215 Kurdish Summer Sleeping-place.....	584
Nun and Knight of Calatrava.....	18	18 Egyptian Chariot.....	215	215 Cotton-plant.....	585
Ancient Egyptian Caldron.....	19	19 Egyptian Chariot in Battle.....	216	216 Oriental Garden Bedstead.....	586
Figure of Ape.....	27	27 Assyrian Warriors in Chariot.....	216	216 Oriental Court-yard.....	540
The Calf Mosaic.....	27	27 Assyrian Royal Chariot.....	216	216 Oriental Pastry-cook.....	548
Egyptian Calf-Idol.....	28	28 Assyrian Chariot for the Chase.....	216	216 Oriental Turner.....	549
Coin of Calligula.....	29	29 Ancient Persian Chariot.....	216	216 Crane.....	550
Church of the Holy Sepulchre.....	27	27 Babylonian Chariot.....	217	217 Numidian Crane.....	550
Specimen of <i>Codex Cantabrigiensis</i>	48	48 Greek Chariot.....	217	217 Map of Crete.....	565
Hieroglyph of "Cambyzes".....	49	49 Roman Chariot.....	217	217 Crocodils.....	573
Bectrian Camel.....	50	50 Egyptian Chariot for three.....	217	217 Crosiers.....	575
Arabian Camel.....	50	50 Sister of Charity.....	219	219 Forms of Crosses.....	576
Baggage Camel.....	51	51 Denier of Charlemagne.....	220	220 Tablet of "Christ's Cross".....	581
Lady on a Camel.....	51	51 Ancient Egyptian Chase.....	223	223 Cross-bearer in Italy and Bohemia.....	581
Camels at Nilmrud.....	52	52 Ancient Winged Symbols.....	225	225 Daughter of the Cross, and Cross-bearer in France.....	583
Camel's Foot.....	53	53 Form of Cherub.....	227	227 Oriental Jackdaw.....	583
<i>Lanœmia Inermis</i>	59	59 Ancient Egyptian Chest.....	240	240 Ancient Asiatic Crowns.....	584
<i>Lanœmia Spinosæ</i>	60	60 Oriental Plane-tree.....	241	241 Ancient Assyrian Crowns.....	584
Specimen of <i>Codex Campianus</i>	60	60 Branch of Plane-tree.....	241	241 Other ancient Crowns.....	584
Hieroglyph of "Canaan".....	63	63 Oriental Mothers carrying Children.....	244	244 Ancient Egyptian Crowns.....	585
Map of Canaan.....	63	63 Map of China.....	247	247 Modern Oriental Crowns.....	585
Ancient Canaanite.....	65	65 The "Three Pure Ones".....	249	249 Isthmian Crowns.....	586
Ethiopian Queen.....	65	65 Chinese Worshipping.....	249	249 Oriental Travelling-flasks.....	585
Hieroglyph of "Candace".....	65	65 Coin of Chios.....	255	255 Common Cuckoo.....	588
"Candlestick" on Arch of Titus.....	70	70 Badge of Order of Christ.....	268	268 Eastern Black Cuckoo.....	589
"Golden Candlestick," 1.....	71	71 Star of Order of Christ.....	268	268 Syrian Cucumber.....	589
"Golden Candlestick," 2.....	71	71 Plan of ancient Basilica.....	283	283 Cumin.....	602
<i>Arundo Donax</i>	73	73 Plan of Durham Cathedral.....	287	287 Cuneiform Alphabet.....	603
<i>Andropogon Calamum</i>	73	73 <i>Cinnamomum Zeylanicum</i>	245	245 Cuneiform Names.....	604
Canon Regular.....	90	90 <i>Cinnamomum Cassia</i>	246	246 Egyptian Drinking-vessels.....	605
Coppery Spinosæ.....	99	99 Clisterian Monk and Nun.....	254	254 Assyrian Cups.....	605
Caper-berry.....	99	99 Modern Oriental Cithara.....	256	256 Cup from Nilmrud.....	605
Coin of Cappadocia.....	106	106 Citron Flower and Fruit.....	257	257 Cup from Pompell.....	606
Egyptian Captives.....	107	107 Citron-tree.....	259	259 Oriental Cups.....	606
Assyrian Captives.....	107	107 Coin of Claudius.....	271	271 Oriental Coffee-service.....	606
Assyrian Evacuation of captured City.....	108	108 Clear-story.....	273	273 Assyrian Mystical Cup.....	606
Assyrian Procession of Captives.....	108	108 Coin of Cleopatra and Antiochus.....	284	284 Assyrian Cup of Libation.....	606
Capychin Monk.....	114	114 Grypus.....	284	284 Assyrian Cup-bearer.....	607
Boat of Caracalla.....	115	115 Coin of Antony and Cleopatra.....	284	284 Awning at Teheran.....	611
Oriental Caravan.....	116	116 Specimen of <i>Codex Claromontanus</i>	289	289 Oriental Self-torture.....	619
Oriental Caravanserai.....	117	117 Plan of Chnidus.....	293	293 Figures with Castanets, from Herculanum.....	622
Interior of Caravanserai.....	118	118 Coin of Chnidus.....	293	293 Cymbals from Herculanum.....	622
Cardinal's Hat.....	120	120 Assyrian Game-cock.....	297	297 Ancient Egyptian Cymbals.....	622
"Barefooted" Carmelite.....	126	126 Egyptian Mummy-cases.....	401	401 Cypress-tree.....	623
Oriental Wooden Lock-maker.....	128	128 Babylonian Coffin.....	401	401 Cypress Branch and Cone.....	623
Ethiopian Princess in a Car.....	131	131 Bishop Ralph's Coffin.....	401	402 Specimen of <i>Codex Cyprius</i>	624
Carra of the "Tokkarti".....	131	131 Coin of Simon Maccabeus.....	402	402 Map of Cyprus.....	626
Ancient Egyptian Carts.....	132	132 Coin of Simon Bar-cochebas.....	402	402 Proconularian Coin of Cyprus.....	627
Syrian Farm-cart.....	132	132 Early Jewish Coin.....	402	405 Map of Cyrenaica.....	628
Assyrian Cart.....	133	133 Coins of Antigonus.....	403	425 Plan of Cyrene.....	629
Indian Cart.....	133	133 Specimen of <i>Codex Colbertinus</i>	405	425 Coins of Cyrene.....	629
Coin of Carthage.....	133	134 Ancient Egyptian Columns.....	425	448 Symbolical Figure of Cyrus.....	635
Plan of Carthage.....	134	134 Ancient Greek Columns.....	425	464 "Tomb of Cyrus".....	637
Carthian Monk and Nun.....	134	134 Cross of Order of Compostella.....	448	487 Assyrian Fish-god.....	643
<i>Leucus Cinnamomum</i>	139	139 <i>Hyrax Syriacus</i>	464	497 Babylonian Fish-god.....	643
<i>Cinnamomum Cassia</i>	140	140 Effigies of Constantine and Fausta.....	487	498 Fish-god at Nilmrud.....	643
Coin with Castor and Pollux.....	142	142 Ancient Egyptian Kitchen.....	497	499 Map of Vicinity of Damascus.....	648
Nubian Wild Cat.....	144	144 Royal Kitchen of Assyrians.....	498	503 Assyrian Assault of Damascus.....	649
Ancient Egyptian Cats.....	144	144 Coins of Cos.....	499	504 Coin of Damascus.....	650
Catacombs, 1.....	145	145 Branch of Coral.....	503	508 Map of the Tribe of Dan.....	654
Catacombs, 2.....	145	145 Stem and Zoophyte of Coral.....	504	508 Arab Dance.....	657
Catacombs, 3.....	146	146 Corinth restored.....	508	509 Oriental Dancing-girl.....	659
Bull of Palestine.....	163	163 Corinth and its Ports.....	508	509 Female Sacred Dance, from Egyptian Monuments.....	659
Syrian Sheep.....	164	164 Plan of Corinth.....	509	515 Male Dance in Figures among ancient Egyptians.....	660
<i>Capra Marmorica</i>	165	165 Coins of Corinth.....	509	520 Persian Gold and Silver Darics.....	675
Modern Egyptian Head-dress.....	166	166 Caspian Tern.....	515	521 Cuneiform and Hieroglyphical Forms of "Darius".....	676
Caves on the Jordan.....	167	166 Greater Cormorant.....	515	529 Cluster of Date-palm Fruit.....	682
Cedar of Lebanon.....	171	167 Hittite Ear-locks.....	518	530 Ancient Egyptian Cake.....	692
View of the Cedars.....	171	171 Ancient Cornets.....	520	530 Map of Dead Sea.....	710
Ancient Egyptian Ceilings.....	173	171 Cornice.....	521	530 Coin of Decius Trajanus.....	722
Modern Egyptian Ceiling, 1.....	173	173 Modern Egyptian Bastinado.....	521	530 Barbary Deer.....	726
Modern Egyptian Ceiling, 2.....	173	173 "Joseph's Brethren in Egypt".....	529	531 Coin of Apamea in Phrygia.....	735
Coin with Cenchres.....	178	178 "Jewish Captives" in Egypt.....	530	531 Coin of Delos.....	740
Ancient Egyptian Coners.....	181	181 "Teraethlith Prisoners" in Persia.....	530	532 Tetradrachm of Demetrius I.....	741
Ancient Egyptian Registration.....	182	182 "Natives of Palestine" in Egypt.....	530	532 Tetradrachm of Demetrius II.....	741
Ancient Egyptian Pendants.....	183	183 Costumes of Monks and Pilgrims.....	531	532 Coin of Demetrius III.....	743
Cuneiform of "Babylon".....	194	194 Oriental Costumes by Painters.....	531		
Map of Chaldean Empire.....	197	197 Dress of Desert Arabs.....	531		
Chaldean Diviner.....	208	208 Arab <i>Hyle</i>	532		
Oriental "Chamber on the Wall".....	204	204 Oriental Under-garment.....	532		
		204 Oriental Undress.....	532		

Man in the Den of Lions.....	Page 748	Statue of <i>Discobolus</i>	Page 819	Syrian Carrier-dove.....	Page 877
Roman <i>Denarii</i>	744	Ancient Egyptian Dinner-dish.....	820	Pyx in form of Dove.....	877
Zodiac of Denderah.....	744	Modern Oriental Dishes.....	820	Modern Persian Dove-cots.....	879
Ruins of Denderah.....	745	Ancient Assyrian Dish.....	820	Star of Bethlehem.....	880
Map of Denmark.....	746	Syrian Turk's Divan.....	825	Gold Daric.....	884
Dancing Dervishes.....	751	Priest of the Christian Doctrine.....	847	Athenian Drachma.....	884
Coin of Tigranes.....	779	Wild Persian Dog.....	852	Oriental Water-carrier.....	884
Ancient Diadems.....	779	Ancient Egyptian Dogs.....	853	An Egyptian.....	889
Portable Sun-dials.....	780	Ancient Assyrian Hunting-dog.....	853	A Bedouin.....	889
Dial of Ahas.....	781	Eastern Street-dogs.....	853	Egyptian of the upper Class.....	890
Face of Birs Nimroud.....	781	Dominican Monk.....	858	Egyptian of the lower Class.....	890
Indian Sun-dials.....	781	Dominican Nun.....	859	Egyptian Woman.....	890
Medals of Diana.....	782	Ancient Egyptian Doors.....	866	Woman of Upper Egypt.....	890
Coin with Diana's Temple.....	783	Ancient Egyptian Door-fixtures.....	866	Camel of the Hauran.....	894
Image of Diana.....	788	Modern Oriental Street-doors.....	866	Saddling a Dromedary.....	895
Coin of Ephesus and Smyrna.....	784	Oriental Door in Interior Court.....	867	Ancient Assyrians pursuing an Arab on a Dromedary.....	895
Roman Didrachm.....	791	Common Oriental Door.....	867	Assyrians loading a Camel.....	895
Ancient Egyptian Dinner-party.....	803	Modern Jewish <i>Mezuzah</i>	868	Specimen of <i>Codex Dublinensis</i>	905
Modern Oriental State Dinner.....	803	Eastern Door with Inscription.....	868	Model of ancient Egyptian House.....	928
Coin of Dioclesian.....	805	Arab Women Grinding Grain.....	876	Modern Persian Mansion.....	924
Coin with Diocuri.....	812	Rock-dove.....	877		

CYCLOPÆDIA

OF

BIBLICAL, THEOLOGICAL, AND ECCLESIASTICAL LITERATURE.

C.

Cab (כַּב, *kab*, a hollow vessel; Sept. *κάβος*), a measure for things dry, mentioned in 2 Kings vi, 25. The rabbins make it the sixth part of a *seah* (q. v.) or *seah*, and the eighteenth part of an ephah. This would be nearly two quarts English measure. See MEASURE.

Cábala, the title of the celebrated system of religious philosophy, or more properly theosophy, which has played so important a part in the theological and exegetical literature of both Jews and Christians ever since the Middle Ages. See PHILOSOPHY. The following account of it is chiefly compiled from Kitto's *Cyclopædia* and Herzog's *Real-Encyclopædie*.

I. *The Name*.—**KABBALA** (from the Heb. קַבָּלָה, *Kabbalah*, the received), properly denotes reception, then a doctrine received by oral tradition. The term is thus in itself nearly equivalent to "transmission," like the Latin *traditio* = *Massora*, for which last, indeed, the Talmud makes it interchangeable in the statement, "Moses received (קַבָּל) the Law on Mount Sinai, and transmitted (קָרַב) it to Joshua." The difference between it, however, and the word מְסֻרָה (from קָרַב, to deliver) is, that the former expresses the act of receiving, while the latter denotes the act of giving over, surrendering, transmitting. The Cabala is also called by some נִסְתָּוֵרִים, *secret wisdom*, because it pretends to be a very ancient and secret tradition, and חַן, *grace*, from the initials of these two words.

The term *Kabbalah* is employed in the Jewish writings to denote several traditional doctrines; as, for example, that which constituted the creed of the patriarchal age before the giving of the law; that unwritten ritual interpretation which the Jews believe was revealed by God to Moses on the mount, and which was at length committed to writing and formed the *Mishna*. Besides being applied to these and other similar traditions, it has also been used in, comparatively speaking, modern times, to denote a singular mystic mode of interpreting the Old Testament.

We are reminded by this indefinite title that among the Jews, as throughout the greater part of the East, human knowledge, whether historical or scientific, rested principally on a sort of *succession*, and the best claim for its reception was an unbroken chain of traditionary evidence. Hence the care with which Judaism established the regular consecution of the sacred custodians of truth, from Moses through Joshua and the so-called greater prophets, thence through Ezra and "the Great Synagogue" to the teachers of later times, subdividing at length into the various schools or periods of particular rabbis and their hereditary adherents. While, therefore, the truth was gradually exhibited in the writings of the Law, the Prophets, and the Talmud, the Cabala indicates the verbal exposition

of these, orally transmitted along with them, and not generally known to the people, but containing a deeper or more thoroughly initiated style of instruction. It thus came ultimately to designate a particular theologico-philosophical system, that arose and established itself in the bosom of Judaism, yet in a measure independent of, or rather supplementary to it.

II. *Original Documents*.—Instruction in Judaism being principally verbal and founded on memory, its phases of development could necessarily leave but little mark on history; and as such a philosophy would thus naturally, in process of time, become a mystery, at least in the view of posterity, the origin and progress of the Cabala are yet largely matters of conjecture, and it is even a subject of scientific controversy whether in its speculative form it can be distinctly traced earlier than the Middle Ages, although its leading principles appear to have been derived from ancient documents, the nature of which is still very imperfectly understood, such as the so-called revelations of Adam, Abraham, Moses, Ezra, etc. See APOCRYPHA. The Talmud, indeed (both in the *Mishna* and *Gemara* of the tract *Chagiga*, passim), makes mention of a doctrine imparted only to a few carefully selected persons, and even applies to it certain fanciful names (drawn from the phraseology of Gen. i, 1, and Ezek. i, 1), significant respectively of a speculative *cosmology* and a speculative *theology*; but it is uncertain whether these designate definite treatises, or, if so, whether these have in any identifiable form descended to modern times. The only works which can with any propriety claim to embody these earliest views are the following two, that became the acknowledged texts of the Cabala in the latter part of the Middle Ages; a third cabalistic treatise (called the סֵפֶר בַּחִיר, *Sepher Bachir*, or *Choice Book*), which is found in an edition of Amst. 1651, and attributed to a rabbi, Nechoniah Ben-Hakana, of the first century, has long ago been generally acknowledged to be fictitious, although a cabalistic work of the same title is mentioned as early as the fourteenth century.

The first of these is the *Book of Creation* (סֵפֶר יְצִירָה, *Sepher Yetzirah*, often reprinted, as ed. Steph. Rittangel, Amst. 1642, with a Latin translation and commentary; and the ed. of J. F. van Meyer, with a German translation and commentary, Leipz. 1830, 4to), ascribed to the renowned rabbi Akiba (A.D. 120). It is a rather short treatise, in oracular sentences, the language of which, more obscure in import than in form, does not resemble the Hebrew of the *Mishna*. As a book of the same title appears to be already mentioned in the *Gemara*, where wonderful power is ascribed to it, and as R. Saadias is said to have commented upon it as early as the tenth century, it is certain that we can ascend to a considerable antiquity in tracing its authority. See JEZIRAH.

The other and more important cabalistic text is the celebrated *Book of Light* (סֵפֶר הַזוֹהַר, *Sepher haz-Zohar*, from Dan. xii, 8), first printed at Cremona and Mantua in 1560, and since often reprinted, as at Sulzbach in 1684, fol., with various additions. Tradition ascribes this work to a contemporary of R. Akiba, namely, R. Simeon Ben Jochai, a teacher much praised in the Talmud for his great wisdom and legal knowledge, although nothing is there said directly of his writings. Incredulous criticism considers it as a production of the thirteenth century, the time of its first appearance in the history of literature, and ascribes it to a Spanish Jew, Moses of Leon. It appears, however, to be older than this, having probably originally appeared piecemeal in the East at intervals, the whole being completed in its present form about the eighth century. It includes certain special tracts or treatises, in which the author seems especially to develop his own sentiments, and which form, so to speak, the kernel of the science sought to be imparted. Three of these are designated by particular names (*The Book of Confidence*, and the *Greater and Less Collections*); the popular distinction made by the Jews, however, between a great and a small Zohar sometimes refers to the varying fullness of the editions merely. See ZOHAR.

III. *Fundamental Doctrines*.—These are somewhat differently expounded in the above-named books (to the separate articles on which the reader is therefore referred for full particulars), and most at large in the latter. The following, however, is a summary of the cabalistic views as expressed in the general writings of later authors of that school:

1. *Nature of the Deity*.—God is above everything, even above being and thinking. It cannot, therefore, be said of him that he has either a will, intention, desire, thought, language, or action, since these properties, which adorn man, have limits, whereas God is in every way boundless, because he is perfect. Owing to this boundlessness of his nature, which necessarily implies absolute unity and immutability, and that there is nothing without him, i. e. that the *τὸ πᾶν* is in him, he is called *EX-SOPH* = *without end, boundless*, and can neither be comprehended by the intellect nor described with words, for there is nothing which can grasp and depict him to us. In this incomprehensibility or boundlessness, God, or the *En-Soph* (אֵין סוֹפִין), is in a certain sense not existent (אֵין); since, as far as our mind is concerned, that which is incomprehensible does not exist. Hence, without making himself comprehensible, his existence could never have been known. He had, therefore, to become active and creative in order that his existence might become perceptible.

2. *Development of the Deity*.—But since, on the one hand, the will to create, which implies limit, and the circumscribed and imperfect nature of this world, preclude the idea of taking it as the direct creation of him who can have no will, nor produce anything but what is like himself, boundless and perfect; and since, on the other hand, the beautiful design and order displayed in the world, which plainly indicate an intelligent and active will, forbid us to regard it as the offspring of chance, the *En-Soph* must be viewed as the Creator of the world in an indirect manner, through the medium of ten "*Sephiroth*" or *intelligences*, which emanated from the *En-Soph*. The etymology and exact meaning of the word are obscure. It is the plur. סְפִירוֹת, *saphiroth*, of סְפִירָה, which R. Asariel, the first Cabalist, derives from סָפַר, *saphar*, to number; while later Cabalists derive it from סָפַר, *sappir*, the *sapphire*, from the word סָפַר, "declare," in Psa. xix, 1, or even from the Greek σφαῖρα, *spheres*.

From his infinite fullness of light the *En-Soph* sent forth at first one spiritual substance or intelligence; this intelligence, which existed in the *En-Soph* from all

eternity, and which became a reality by a mere act, contained the nine other intelligences or *Sephiroth*. Great stress is laid upon the fact that the first *Sephiroth* was not created, but was simply an emanation (אֵצְרִיבִילִית); and the difference between creation and emanation is thus defined, that in the former a diminution of strength takes place, while in the latter this is not the case. From the first *Sephiroth* emanated the second, from the second the third, from the third the fourth, and so on, one proceeding from the other, till the number ten. These ten *Sephiroth* form among themselves, and with the *En-Soph*, a strict unity, and simply represent different aspects of one and the same Being, just as the flame and sparks which proceed from the fire, and which appear different things to the eye, form only different manifestations of the same fire. Differing thus from each other simply as different colors of the same light, all the ten emanations alike partake of the *En-Soph*. They are boundless, and yet constitute the first finite things; so that they are both infinite and finite. They are infinite and perfect, like the *En-Soph*, when he imparts his fullness to them, and finite and imperfect when that fullness is withdrawn from them. The finite side of the emanation of the *Sephiroth* is absolutely necessary, for thereby the incomprehensible *En-Soph* makes his existence known to the human intellect, which can only grasp that which has measure, limit, and relation. From their finite side the *Sephiroth* may even be called bodily, and this renders it possible for the *En-Soph*, who is immanent in them, to assume a bodily form.

3. *Forms of his Development*.—The ten *Sephiroth*, every one of which has its own name, are divided into three groups of three *Sephiroth* each, respectively operating upon the three worlds, viz. the world of intellect (עוֹלָם הַמַּעְבָּל), the world of souls (עוֹלָם הַמַּמְטָה), and the world of matter (עוֹלָם הַמַּדְבָּר). I. The first group operates upon the intellectual world, and consists of *Sephiroth* 1, denominated כְּרוֹנָה or קְרוֹנָה, the *crown*, or the *inscrutable height*; 2, called חֻכְמָה, the *creative wisdom*; and 3, called בִּינָה, the *conceiving intellect*. The result of the combination of the latter two (as "father" and "mother") is likewise represented as בִּיעוּר, or *knowledge*, i. e. concrete thought, the universe of mind, the effect of *λόγος*. II. The second group exercises its power upon the moral world, and consists of *Sephiroth* 4, called חֶסֶד, infinite *grace* (also גְּדוּלָה, *greatness*); 5, called דִּין, or גְּבוּרָה, *divine justice*, or *judicial power*; and 6, which is called תְּפִלָּה, *beauty*, and is the connecting link between the opposite *Sephiroth* 4 and 5. III. The third group exercises its power upon the material world, and consists of *Sephiroth* 7, called יָצוּחַ, *firmness*; 8, called הוֹד, *splendour*; and 9, which is called יְסוּד, the *primary foundation*, and is the connecting link between the two opposite *Sephiroth*, 7 and 8. *Sephiroth* 10 is called תְּהוֹמָה, *kingdom*, and denotes *Providence* or the revealed Deity (שְׁכִינָה, *Shekinah*) which dwells in the midst of the Jewish people, goes with them and protects them in all their wanderings and captivities. The first triad is placed above, and the second and third triads, with the unit, are put below, in such a manner that the four *Sephiroth* called *crown, beauty, foundation, and kingdom*, form a central perpendicular line denominated the *middle pillar* (עַמּוּד אֲמִתִּי). This division yields three different forms in which the ten *Sephiroth* are represented by the Cabalists, and which we subjoin in order to make the description more intelligible. The first represents an inverted tree, called עֵץ הַחַיִּים, *the tree of life*, while the second and third are human figures, called אָדָם קַמְמוֹן, *the primeval man*. Yet, notwithstanding the different ap-

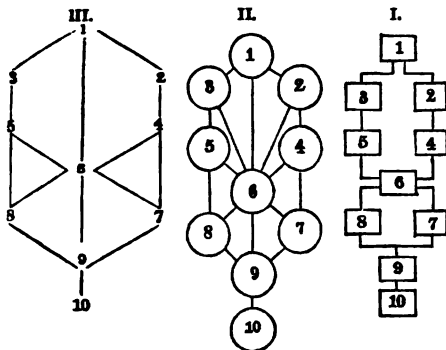

Cabalistic Diagrams of the "Sephiroth."

pearance of these three forms, the *Sephiroth* are so arranged that the three triads and the middle pillar are to be distinguished in each one of them.

4. *Processes of the Divine Development.*—These *Sephiroth*, or God through them, created the lower and visible world, of which everything has its prototype in the upper world. "The whole world is like a gigantic tree full of branches and leaves, the root of which is the spiritual world of the *Sephiroth*; or it is like a firmly united chain, the last link of which is attached to the upper world; or like an immense sea, which is being constantly filled by a spring everlastingly gushing forth its streams." The *Sephiroth*, through the divine power immanent in them, uphold the world which they have created, and transmit to it the divine mercies by means of twelve channels (צְנוּרוֹת). This transmission of the divine mercies can be accelerated by prayer, sacrifices, and religious observances; and the Jewish people, by virtue of the revelation, and the 613 commandments given to them (see SCHOOLS), have especially been ordained to obtain these blessings (שְׂמֵחַ) for the whole world. Hence the great mysteries of the Jewish ritual (סֵדֶר הַתְּפִלָּה); hence the profound secrets contained in every word and syllable of the formulæ of prayers; and hence the declaration that "the pious constitute the foundation of the world" (צְדִיק יְסֹד עוֹלָם). Not only does the *En-Soph* reveal himself through the *Sephiroth*, but he also becomes incarnate in them, which accounts for the anthropomorphisms of Scripture and the Hagada. Thus, when it is said that "God spake, descended upon earth, ascended into heaven, smelled the sweet smell of sacrifices, repented in his heart, was angry," etc., or when the Hagadic works describe the body and the mansions of God, etc., all this does not refer to the *En-Soph*, but to these intermediate beings. These *Sephiroth* again became incarnate in the patriarchs, e. g. *Sephiroth 4*, love was incarnate in Abraham; 5, power in Isaac; 6, beauty in Jacob; 7, firmness in Moses; 8, splendor in Aaron; 9, foundation in Joseph; 10, kingdom in David; and they constitute the chariot throne (כְּרִיבָה).

5. The *psychology* of the Cabala is one of its most important features. All human souls are pre-existent in the world of the *Sephiroth*, and are, without an exception, destined to inhabit human bodies, and pursue their course upon earth for a certain period of probation. If, notwithstanding its union with the body, the soul resists all earthly trammels, and remains pure, it ascends after death into the spiritual kingdom, and has a share in the world of *Sephiroth*. But if, on the contrary, it becomes contaminated by that which is earthly, the soul must inhabit the body again and again (עִירָבֵר, עִירָבֵר) till it is able to ascend in a purified state, through repeated trial (restricted by Nachmanides and the later cabalists to three transmigrations). The apparently undeserved sufferings which

the pious have sometimes to endure here below are simply designed to purify their souls. Hence God's justice is not to be impugned when the righteous are afflicted and the wicked prosper. This doctrine of the transmigration of souls is supported by an appeal to the injunction in the Bible, that a man must marry the widow of his brother if he died without issue, inasmuch as by this is designed, say the cabalists, that the soul of the departed one might be born again, and finish its earthly course. Very few new souls enter into the world, because many of the old souls which have already inhabited bodies have to re-enter those who are born, in consequence of their having polluted themselves in their previous bodily existence. This retards the great redemption of Israel, which cannot take place till all the pre-existent souls have been born upon earth, because the soul of the Messiah, which, like all other souls, has its pre-existence in the world of the spirits of the *Sephiroth*, is to be the last born one at the end of days, which is supported by an appeal to the Talmud (*Yebamoth*, 68, a). Then the great jubilee year will commence, when the whole pleroma of souls (אִצְרֵי הַיְשׁוּבוֹת), cleansed and purified, and released from earth, shall ascend, in glorious company, into heaven. See METEMPSYCHOSIS.

IV. *Origin, Date, Design, and Relations of the Cabala.*—The rise of Cabalism is involved in great obscurity. The Jews ascribe it to Adam, or to Abraham, or to Moses, or to Ezra, the last being apparently countenanced by 2 Esdr. xiv. 20-48. The opinions of Christian writers are as variously divided; and the Cabala is such a complex whole, and has been aggregated together at such distant periods, that no general judgment can apply to it. In its crude form it is undoubtedly to be attributed to the authors of the books *Jezirah* and *Zohar* above named, and therefore cannot be assigned an earlier date than these writings. Its fuller and more mature doctrines, however, as above delineated, are due to the speculations of later masters of this school. The account of this theosophy has been greatly obscured by modern writers, who, in their description of the Cabala, confound its doctrines with the Jewish mysticism propounded in the works called the *Alphabet of R. Akiba* (עֲבֵרָה דְּר' אֶקִיבָה, or אֲלֶפֶת בִּרְחַם דְּר' עֲבֵרָה, the *Description of the Body of God* (שִׁעוֹר קוֹמָה), and the *Delineation of the heavenly Temples* (חֵיכָלוֹת). Even the book *Jezirah* does not contain the doctrines of the Cabala as above expounded. All these productions, and others of a similar nature so frequently quoted by writers who give an analysis of the Cabala, know little or nothing of the *Sephiroth*, and of the speculations about the *En-Soph*, or the being of God, which constitute the essence of the Cabala. Nevertheless, these works are unquestionably to be regarded as having induced the more refined speculations of the Cabala, by the difficulty in which they placed the Jews in the south of France, and in Catalonia, who believed in them almost as much as in the Bible, and who were driven to contrive this system whereby they could explain to themselves, as well as to their assailants, the gross descriptions of the Deity, and of the plains of heaven, given in these Hagadic productions. Being unable to go to the extreme of the rigid literalists of the north of France and Germany, who, without looking for any higher import, implicitly accepted the difficulties and anthropomorphisms of the Bible and Hagada in their most literal sense; or to adopt the other extreme of the followers of Maimonides, who rejected altogether the Hagadic and mystical writings, and rationalized the Scriptures, it may be conjectured that Isaac the blind contrived, and his two disciples, Ezra and Azariel of Zerona, developed the modern system of Cabalism (about 1200-1280), which steers between these two extremes. By means of the *Sephiroth* all the anthropomorphisms in

the Bible, in the Hagada, and even in the *Shlar Koma*, are at once taken from the Deity, and yet literally explained; while the sacrificial institutions, the precepts, and the ritual of the Bible and Talmud, receive at the same time a profound spiritual import. The Cabala in its present state is therefore a hermeneutical system, which, in part at least, was instituted to oppose the philosophical school of Maimonides (q. v.).

The relationship between the Cabala and Neo-Platonism is apparent. The Cabala elevates God above being and thinking, and likewise denies all divine attributes; so does Neo-Platonism. The Cabala, like Neo-Platonism, places intelligent principles or substances between the Deity and the world. The Cabala teaches that the *Sephiroth*, which emanated from God, are not equal to God; Neo-Platonism teaches that the substances, thought, spirit, and nature (*νοῦς, ψυχή, and φύσις*), which proceeded from one being, are not equal to their origin (*οὐκ ἴσον δὲ τὸ ἀποδόν τῷ μείναντι*); and the Cabala has adopted the very same classification of the *Sephiroth* into the three great spheres of intelligence, animation, and matter. The comparison between the emanation of the *Sephiroth* from the *En-Soph*, and the rays proceeding from light to describe immanency and perfect unity, is the same as the Neo-Platonic figure to illustrate the emanations from the one Being (*ολοκ ἐκ φωτὸς τῆν ἰξ αὐτοῦ περικαυψιν*). The doctrine of the Cabala, that most of the souls which enter the world have occupied bodies upon this earth before, is Neo-Platonic (comp. Zeller, *Gesch. der Philosophie*, III, ii, 944). See NEO-PLATONISM.

V. *Later Processes of Cabalism*.—In the hands of the younger disciples of the cabalistic science, the secret knowledge was not only studied in its philosophical bearing, but also, and even rather, under two new aspects (which were not mentioned by their predecessors, and which carried it farther than it went at first, though by this we do not mean to say that it received any positively novel additions), namely, the practical application and the hermeneutical method. We find that in olden times secret philosophical science and magic went hand in hand. The sorcerer mentioned in Acts xiii was called by the Arab name of *סַיְלֵם*, the secret, i. e. learned; in Acts xix we read of books of magic which were at Ephesus; the sporadic mentions made of the Cabala in the Talmud are accompanied by descriptions of miracles. When R. Chahina and R. Oshia studied the book of Jezirah, we are told in the treatise *Sanhedrim* of the Gemara, they also made each time a three-year-old cow, and lived thereon. It is no wonder, then, if the Jewish cabalists of the latter part of the Middle Ages transmitted the conception of their science to their Christian adepts, not only as speculative (*סַפְרֵי הַמַּגִּיד*), but also as practical (*סַפְרֵי הַמַּעֲשֵׂה*), i. e. in plain English, that they connected with it the idea that a true cabalist must at the same time be a sorcerer. It is self-evident, however, that we must here distinguish between theosophic overstraining and mere juggling, although in actual practice the difference may sometimes have been hard to perceive. The effects hoped for or believed in magic were accordingly transmitted outwardly through amulets, talismans, exorcisms, images, signs, and such things, consisting of certain writings, names of angels, or mysterious letters, whose connection, however, always leads back to the name of God. This last, unpronounceable to the unconsecrated, but known to the cabalist, whether it consist of four (*יְהוָה*), twelve, or forty-two letters (numbers which result from combinations from the Sephir system), was, as such, called *שֵׁם הַמְּכֻלָּם*, the declared name; and he who knew how to use it was a *בַּעַל הַשֵּׁם*, or master of the name. The well-known implements of magic, such as Solomon's keys, the shield of David, etc., owe their origin to this line of ideas. Amateurs will find a very entertaining

account of these things in Eisenmenger's *Entdecktes Judenthum*, in Schudt's *Jewish Curiosities*, and other works of the same character. See AMULET.

The exegetical ingenuity of the Cabala is interesting to the theologian. The principle of the mystic interpretation of Scripture is universal, not particular to such or such schools, as every one will perceive in Church history, and even in the history of Greek literature. We find it in Philo, in the New Test., in the writings of the fathers, in the *Talmud*, and in the *Zohar*; and the more it departs from the spirit of the sacred text, the more had the latter to be brought to its support by distortions of its meaning. For such operation there are no known rules except the exigencies of the case and the subjective mass of the sense. See MYSTICISM. In the mean time, the Jews had already, by the arbitrary character of their alphabet, arrived at all manner of subtleties, of which we have already isolated examples in earlier writings, but which were especially established as a virtuosity in post-Zoharic times. From this arose the following species of cabalistic transformation: 1st. *גֵּמַטְרִיָּה*, *Gematria* (*γλωσσόγραφία*), i. e. the art of discovering the hidden sense of the text by means of the numerical equivalents of the letters. For example, in the first and last verses of the Hebrew Bible are found six N's, which, according to this method, means that the world is to last 6000 years. The numerical equivalent of the first word of Genesis is 918, which is also the number given by the words *בְּרִאשִׁית* (*by the law He formed it*, i. e. the world), from whence it follows that the law existed before the creation, and that the latter was accomplished through the former. If the second word of Genesis (*בְּרָא*) be added to the first, the result is 1116, which is also the equivalent of *בְּרִאשִׁית הַשָּׁנָה הַשְּׁמִינִי* (*in the beginning of the year it was created*), by which is known that God created the world in the beginning of the year—that is, in the season of Autumn. The antiquity of this method is already shown in Rev. xiii, 18, where the solution must be ciphered out with the aid of the Hebrew (or Greek) alphabet. It is also considered as *Gematria* when Biblical numbers—for instance, dimensions of buildings—are expressed in letters, and words again made of them. Still later came speculations on the greater, smaller, inverted, and suspended letters found in the Masoretic text; for instance, Deut. vi, 4; Gen. ii, 4; Num. x, 35; Judg. xviii, 30, in which some deep meaning is looked for, although they may perhaps have originally been but peculiar marks to aid memory. 2d. The particularly so-called "figurative" (*סַפְרֵי הַמַּגִּיד*) Cabala, *נוטריקון*, *Notarikon* (from Lat. *notare*, to extract), consists in framing with each letter of a word several new ones, e. g. from the first word of Genesis six can thus be framed: *בְּרָא*, *he made*; *קַרְקִיעַ*, the firmament; *אָרֶץ*, the earth; *שָׁמַיִם*, the heavens; *יָם*, the sea; *תְּהוֹמוֹת*, the abyss. We thus learn the correct scientific nature of the universe, besides the proper meaning of the text. Again, it consists in taking the first letters of several words to form a new one: e. g. Deut. xxx, 12, *מִי יַבְרִיכֵנוּ לְבָנֵי הַשָּׁמַיִם*, *who shall bring us to heaven?* Answer: *מִיכָאֵל*, *circumcision*. 3d. *תַּמְרוּחַ*, *Temurah* (*permutation*), the anagram, of two kinds. The simple is a mere transposition of the letters of a word: e. g. we thus learn that the angel in Exod. xliii, 28 (*מַלְאָכִי*, *my angel*) was the angel Michael (*מִיכָאֵל*). The more ingenious kind is that by which, according to certain established rules, each letter of the alphabet acquires the signification of another: as Aleph that of Tau, both that of Ayin. Then, again, the letters may be read forward and backward (which constitute the alphabet of *Atchabah*, *אֶתְבָּחָה*), or the first letter that of the twelfth, the sec-

cod of the thirteenth, and the reverse (making the alphabet called *Albam*, אָלְבָּם). See *ATEACH*. The more multifarious these trifles, the easier it is to arrive in every given case at a result, and the less wit or thought is required. Thus the Christian theology of the 17th century, which itself inclined to literal belief, and which, by its strong polemical aspect against the Jews, was led to a diligent study of the cabalistic arts, through them found everywhere in the Old Test. evidences of the Christian dogmas (e. g. Gen. i. 1, בְּרֵאשִׁית = שְׁלֵשָׁתָּה יְהוָה = i. e. *filii, spiritus, pater*; *tres unitus perfectus*).

In the 13th century we find evidence of a knowledge of the cabalistic ideas and methods in the works of the Spaniard Raymond Lullus; but with him, as well as among his direct and indirect followers, these elements of Judaic philosophy take the character of eccentricities and superstitions more than of grand speculative theory. Two centuries elapsed after this before the Cabala really entered the circle of Christian mental development. Its admission was prepared, on the one hand, by the overthrow of the worn-out scholasticism of Aristotle, and the consequent tendency toward Platonic ideas, although, of course, these latter were yet in their more elementary form, as they had been transmitted to Alexandria by Eastern influences; on the other hand, the same result was conduced by an awakening interest in the study of nature, which, it is true, was still in a poetic, dream-like infancy, but was the more inclined to entertain itself with mysteries, as it had discovered as yet but few natural laws. To these was, however, joined a third and more powerful influence, namely, the belief handed down by the fathers of the first centuries that all the wisdom of nations, and chiefly Platonic philosophy, actually took their origin in the Hebraic revelation; that, in a more extended sense than the popular religious histories admit, the Jewish people were the possessors and keepers of a treasury of wisdom and knowledge which time or zealous research could alone reveal. What wonder is it, then, if the assertion of the Cabalists that they possessed such a treasure found credence and gained them followers? The progress of Christians toward the Cabala was greatly helped by the conversion of a large number of Jews to Christianity, in which they recognised a closer relation to their Gnoetic views, and also by the Christians perceiving that Gnosticism could become a powerful instrument for the conversion of the Jews. Among the converted Jews we notice Paul Ricci, physician in ordinary to the Emperor Maximilian, and author of *Calpestis Agricultura*; Judas Ben Isaac Abrabanel (Leon Hebraeus), son of the renowned Portuguese exegist, and author of the *Dialogi de amore*. Among Christians we will only mention the two most important: John Pico della Mirandola and John Reuchlin; the former as a highly gifted and enthusiastic syncretist, author of *Conclusiones cabalisticæ secundum secretam disciplinam sapientie Hebr.* (1486); the other a faithful disciple of the classics, in connection with mysticism, but opposed to scholasticism and monachal torpidude, author of *De verbo mirifico* (1494); *De arte cabalistica* (1517). His, and some other writings of the same kind, are collected in the work *Artes Cabalisticæ h. e. recondite theologie et philosophiæ Scriptorum*, tom. i. (unicus), ex. bibl. J. Pistorii (Basle, 1587, fol.). The powerful preponderance of the religious and Church interests, as well as those of practical politics, which became perceptible in the first quarter of the 16th century, giving to the mind a positive impulse, and to studies a substantial foundation, arrested the further development of the Cabala; and when, in latter times, it was occasionally taken up again, it was rather with the view of giving a high-sounding, mysterious name to theories which had not strength enough to stand by themselves, than as a genuine resurrection of the old systems.

VI. *Literature*.—As a sort of accessory subject of the so-called Orientalism, and even of Biblical erudition, the Cabala is mentioned by the ancient archaeologues and isagogues (as Cuneus, *Respubl. Hebr.*; Walton, *Prolegg.*; Hottinger, *Theosaurus Philol.*; Leusden, *Philologus Hebr.*; Pfleifer, *Critica Sacra*, and many others); but they contain nothing of importance respecting it. Much more copious, though not yet complete, is the information contained in the works of Budens, *Philosophia Ebraeorum* (1708); Hacksplan, *Miscellanea*; Braum, *Selecta Sacra*, v; Reimmann, *Jüdische Theologie*. The work of Sommer, *Specimen theologiæ Sokaricæ* (Goth. 1784), is (like many others which Fabricius quotes in the *Bibliographia Antiq.* p. 246) only a polemic-apologetic attempt at tracing the Christian doctrine of the Trinity in the Cabala. Of a higher philosophic character are the works of Wachter, *Spinozismus im Judenthum*, and *Elucidarius cabalisticus s. reconditæ Ebraeorum philosophiæ brevis reconditio* (Amst. 1699), in which the polemic tone prevails. Next are Basnage, *Hist. des Juifs* (tom. iii), and Brucker, *Hist. Philosophiæ* (vol. ii), who, however, from insufficient study of the original sources, acknowledges himself unable to master its intricate history. Among later writers we find the well-known works of Tenenmann, Tiedemann, and Buhle. The line of the more recent monographic researches begins with Kleuker (Riga, 1786). But Christian writers, whose early knowledge of rabbinic literature has been fast waning, generally forsake it. Tholuck's treatise, *De ortu Cabalæ* (1837), treats only of a preliminary question. Lutterbeck, in the first volume of his *Neuest. Lehrbegriff*, has a very interesting chapter on the Jesirah and Zohar. Mollitor's extensive work, *Philos. d. Geschichte d. Tradition* (1827, pt. i-iii), is chiefly theoretical. Reuchlin (*De arte Cabalistica*, 1517) is still a valuable authority. One of the latest is Etheridge (*Jerusalem and Tiberias*, Lond. 1856, 12mo). Next to the extensive work of Ad. Franck, *La Kabbale ou la Philosophie religieuse des Hebreux* (Paris, 1842; tr. by Jellinek, Lpz. 1844), we name the *Philosophia Cabalistica et pantheismus* (1832) of M. Freystadt. See the *Eclectic Review*, Feb. 1856; *Christian Remembrancer*, April, 1862.

The earliest cabalist was Asariel, whose *Commentary on the Doctrine of the Sephiroth* (פְּרִישׁ פְּקוּר סְפִירוֹת) (חרבשׁ פְּקוּר סְפִירוֹת), in questions and answers, has been published (Warsaw, 1798; Berl. 1850); also his *Commentary on the Song of Songs* (Altona, 1764), usually ascribed to his pupil Nachmanides or Ramban (q. v.).

Among the most important cabalists we find Rabbi Moses Ben Nachman, author of the *Books of Faith and Hope* (אַמְרֵי חַיִּים וְיִשְׁעוֹת); R. Jose, of Castile, author of *אורייתא דאורייתא* (*Doors of Light*); R. Moses, of Cordova, *פְּרִישׁ רְמֹנִים* (*Garden of Pomegranates*); R. Isaac Loria, *סֵפֶר תְּמִלּוּלֵי נַפְשׁוֹ* (*Book of the Wanderings of Souls*); R. Chayim Vital, *עֵץ חַיִּים* (*Tree of Life*); R. Nastali Ben Jacob Elchanan, *עֵצֵק הַמַּלְאָכִים* (*Valley of the Kings*); R. Abraham Cohen, of Herrera (vulg. Iriya), *שַׁעַר הַשָּׁמַיִם* (*Door of Heaven*). Some of these works (translated into Latin) are to be found whole or in their principal parts in the *Kabbala Denudata* of Chr. Knorr, of Rosenroth (Sulzb. 1677, 8 vols. 4to), with all kinds of exegetical apparatus, and some texts from the *Zohar*. The cabalistic literature is fully noticed in Bartolucci's *Bibliotheca Magna Rabbinica* and in Wolff's *Bibliotheca Hebræa*, tom. ii and iv, though not in the correct order and construction; see also P. Beer, *Geschichte der Lehren aller Secten der Juden, und der Cabala* (Brünn, 1822, 2 vols. 8vo); Senet, *De Caballa Judaorum* (Roet. 1702); Sennert, *De Cabala* (Wittenb. 1655); and especially the copious list of expositions upon the works of Simon ben-Jochai, the reputed founder of Cabalism, given by Fürst, *Bibliotheca Judaica*, iii, 829 sq. We may specify the following: Zunz, *Gotteseh. Vorträge der Juden* (Berlin,

1832), p. 402 sq.; Landauer, in the *Literaturblatt des Orients*, vol. vii (1845); viii, 812 sq.; Joel, *Religions-philosophie des Sokrates* (Lpz. 1849); Jellinek, *Moses ben-Schem-Job de Leon* (Lpz. 1851); *Beiträge zur Gesch. der Kabbala* (Lpz. 1852); *Auswahl Kabbalischer Mystik* (Lpz. 1858); and *Philosophie und Kabbalah* (Lpz. 1854); Steinschneider, *Jewish Literature* (Lond. 1857), p. 104-115, 299-309; Munk, *Mélanges de Philosophie Juive et Arabe* (Par. 1859), p. 190 sq.; and especially the masterly analysis of the *Zohar* by Ignaz Stern, *Ben-Chananja*, i-v; the lucid treatise of Grätz, *Gesch. der Juden*, vii, 442-459; and the able review of it by Löw, *Ben-Chananja*, v, p. 825 sq. (also Lpz. 1868, p. 78-86). Ginsburg has lately published a compendious but copious and clear work entitled *The Kabbalah*, etc. (Lond. 1865), in which, however, he controverts the traditional view of the authorship by rabbi Akiba and Ben-Jochai, and assigns it an origin prior to the *Zohar*, which he attributes to Moses of Leon; considering this rather as the offspring than the parent of Cabalism.

Cabasillas, Nicolas, archbishop of Thessalonica in 1854, a firm supporter of the rights and independence of the Greeks against the Roman Church. In the Hætychastic controversy he took part with the monks of Mount Athos against Barlaam (q. v.). He wrote several works, among which are, 1. *Exposition of the Greek Liturgy* (Greek), translated into Latin by Herve, and given in the *Bibliotheca Patrum* under the title *Compendiosa interpretatio in Divinum Officium*: and, 2. *Περὶ τῆς ἐν Χριστῷ ζωῆς*, etc., *Life of Jesus Christ* (Ingoldst. 1804; a bad Latin version). This book is of value as illustrating the mystical tendency among the Byzantine writers. See Cave, *Hist. Lit.* anno 1350; *Stud. u. Krit.* 1843, p. 724; Gasz, *Die Mystik d. N. Kabasilas*, etc. (Greifsw. 1849); Walch, *Bibliotheca Theologica*, i, 640; ii, 570.

Cabasillas, Nilus, uncle of the preceding, a Greek theologian, and archbishop of Thessalonica in the first half of the 14th century. He wrote *Περὶ τῶν αἰτιῶν τῆς ἐκκλησιαστικῆς διαστάσεως*, first printed at London (n. d.), afterward, Greek and Latin, at Basel (1544); again at Frankfort (1555), and at Hainault (1608). In it he shows that the arbitrary claims of the papacy were the true cause of the schism between the East and West. He wrote also *Περὶ τῆς ἀρχῆς τοῦ Πάπα* (Francfort, 1555, 8vo; Hanover, 1608, with the works of Barlaam). Dupin says that these writings are "full of learning." The book on the papal supremacy was translated into English by Gressop (London, 1560, 8vo). Cabasillas died in 1350.—Hoefler, *Nouv. Biog. Générale*, viii, 15; Cave, *Hist. Lit.*, Wharton's Appendix; Dupin, *Eccles. Writers*, cent. xiv.

Cabassut (Cabassutius), JEAN, an eminent Roman canonist, was born at Aix, in Provence, 1604 or 1606, entered the congregation of the Oratory 1626, and died at Aix, aged eighty-one, Sept. 25, 1685. At Rome he was regarded as an oracle in every thing relating to the canon law and casuistry, and a good Oriental scholar. He wrote *Juris Canonici theoria et praxis* (4to, 1696, 1698, and by Gibert, with notes, etc., 1738); also *Historiarum, Conciliorum et Canonum invicem collatorum veterumque Ecclesie rituum, ab ipsis Ecclesie incunabulis ad nostra usque tempora, notitia ecclesiastica* (best ed. Lugd. 1685, fol.; again, Lyons, 1725; and in an abridged form, 1776, 8vo).—Landon, *Ecclesiastical Dictionary*, s. v.

Cab'bon (Heb. *Kabbon'*, קַבְבּוֹן, in Syriac, *a cake*; Sept. Καββών v. r. Καβρά and Καββά), a place in the "plain" of Judah, mentioned between Eglon and Lahmam (Josh. xv, 40); possibly the same with MACHBENAH (1 Chron. ii, 49). It is perhaps the modern ruined site *el-Kufeyr*, marked by Van de Velde (*Map*) at 10 miles south-east of Ashkelon.

Cabet. See COMMUNISM.

Cabin (כַּבִּינָה, *chanuth'*; Sept. merely Græcizes,

ἡ χερίδ), properly a vault or cell (so the margin) within the dungeon, and under ground, for the separate confinement of prisoners (Jer. xxxvii, 16). Others (Scheid, in the *Dis. Lugdun.* p. 968) understand it to mean a curved post, i. e. the stocks (comp. Jer. xx, 2, 8; xxix, 26). The idea conveyed in either case is that the prophet suffered the most severe and loathsome imprisonment. See PRISON.

Cabiz, also called **Aimé**, a learned Mohammedan who became noted for maintaining the superiority of Jesus Christ to Mohammed. Being summoned before the Divan, he silenced the two "cadilakers" of Roumelia and Anatolia. He was then set at liberty, but the sultan, having listened to the discussion, referred the matter to the mufti and cadi of Constantinople. This time Cabiz was found guilty, and sentenced to death. He was executed on Sept. 19, 1527. An edict published on occasion of his execution forbade all Mohammedans, under penalty of death, to prefer thenceforth the doctrine of Jesus Christ to that of Mohammed.—Hoefler, *Biographie Générale*, viii, 27.

Cabral, François, a Jesuit missionary, was born in 1528 at Covilhã, in Portugal, and entered the Society of Jesus at Goa. Appointed a missionary, he traversed great part of India and Asia. After spending several years as professor of theology at Goa, he was made vice-provincial in Japan. He baptized, in 1575, the king of Bungo, who several years before had received hospitably Francis Xavier, but was not converted until the arrival of Cabral. He passed over into China, where he labored abundantly, and thence returned to Goa, where he governed the house of the Professed thirty-eight years. He died at Goa, April 16, 1609.—Alegambe, *Script. Soc. Jesu*; Hoefler, *Nouv. Biog. Générale*, viii, 86.

Ca'bul (Heb. *Kabul'*, קַבְּוּל, according to etymology, *bound*, but signification uncertain [see below]), the name of a town and a district.

1. (Sept. Χαβῶλ, but other copies blend with the following words into Χαβασομίλ.) A city on the eastern border of the tribe of Asher, and apparently at the northern part, beyond Beth-Emek (Josh. xix, 27). It seems to correspond to the village *Chabolo* (Χαβωλώ) mentioned by Josephus (*Life*, § 43, 45) as on the confines of Ptolemais, in Galilee, 40 stadia from Jotapata. A fortress by the name of *Kabul* is mentioned by Arabian geographers in the district of Safed (Rosenmüller, *Analect. Arab.* iii, 20). Dr. Robinson, during his last visit to Palestine, accordingly found a village called *Kabul* on his way to Acho, situated "on the left, among the lower hills" (*Biblioth. Sacra*, 1853, p. 121; *Later Bibl. Res.* p. 88; for Talmudical notices, see Schwarz, *Palest.* p. 192).

2. (Sept. translates "ὄριον, boundary, but in neglect of the context, ver. 12, which favors the derivation of Simonis [*Onomast.* p. 417] and Hiller [*Onomast.* p. 435, 775], as i. q. "something exhaled, as nothing;" Josephus [*Ant.* viii, 5, 8] calls it Χαβαλῶν, and says [apparently from conjecture] that it is a Phœnician word indicative of *disatisfaction*.) A district containing "twenty cities," given to Hiram, king of Tyre, by Solomon, in acknowledgment of the important services which he had rendered toward the building of the Temple (1 Kings ix, 18). Hiram was by no means pleased with the gift, and the district received the name of *Ca-bul* (as if signifying *unpleasing*) from this circumstance. The situation of *Ca-bul* has been disputed; but we are content to accept the information of Josephus (*Ant.* viii, 5, 8), who seems to place it in the north-west part of Galilee, adjacent to Tyre. The foregoing town, named *Ca-bul* (Josh. xix, 27), being also in Galilee, it is possible that it was one of the twenty towns consigned to Hiram, who, to mark his dissatisfaction, applied the significant name of this one town to the whole district. The cause of Hiram's dislike to what Solomon doubtless considered a liberal gift is very uncertain.

It has been conjectured (Kitto; *Pictorial Bible*, note on 1 Kings ix, 13) that "probably, as the Phœnicians were a maritime and commercial people, Hiram wished rather for a part of the coast, which was now in the hands of Solomon, and was therefore not prepared to approve of a district which might have been of considerable value in the eyes of an agricultural people like the Hebrews. Perhaps the towns were in part payment of what Solomon owed Hiram for his various services and contributions."—Kitto, s. v. See **HIRAM**.

Cad'dis (Καδδῖς, or rather Γαδδῖς, as most texts read; so also Josephus, Γαδδῖς or Γαδῖς, *Ant.* xiii, 1, 2; derivation uncertain, see Grimm, *Handb.* in loc.), the surname (διακαλούμενος) of JOANNAN (q. v.), the eldest brother of Judas Maccabæus (1 Macc. ii, 2).

Cademann, JOHANN GEORG., a German theologian of the 17th century, was born at Oschatz, in Saxony, and studied at Jena and Wittenberg, where he took his degree in 1654. In 1666 he became pastor at Dahlen, and in 1676 archdeacon at Wurzzen, where he died, Dec. 28, 1687. Among his writings are *Disputatio de Causa Instrumentalis Justificationis* (Jena, 1650, 4to);—*Disp. de principiis Inmanarum Actioium* (Wittenb. 1664, 4to);—*De Justitia Distributiva* (1654, 4to);—*De Majestate* (1654, 4to).—Hoefler, *Nouv. Biog. Générale*, viii, 63.

Ca'dēs (Καδῆς v. r. Κηδῆς and Κεδῖς), a Græcized form (1 Macc. xi, 68, 73) of the name of KEDESH (q. v.) in Naphtali (Josh. xx, 7).

Ca'dēa-Bar'nē (Καδῆς Βαρνή), a Græcized form (Judith v, 14) of KADESH-BARNEA (q. v.).

Cad'miel (Καδμῖλος v. r. Καδύλος), one of the Levites whose "sons" returned from the captivity, and who assisted at the musical performances at the restoration of the temple worship (1 Esdr. v, 28, 58); evidently the KADMIEL (q. v) of the Heb. texts (Ezra ii, 40; Neh. vii, 43; xii, 24).

Cadonicì, GIOVANNI, an Italian theologian, was born at Venice in 1705, and became a canon of the church of Cremona. He was a man of learning, and opposed the pretensions of the court of Rome and the doctrines of the Molinists. In a curious work, entitled "An Exposition of this passage of St. Augustine, The Church of Jesus Christ shall be in subjection to secular princes," he shows that as princes are subject to the Church in things spiritual, so the Church is bound to obey them in things temporal; and that in ancient liturgies, as the Ambrosian, Mozarabic, etc., prayer was made, specially and by name, even for persecuting princes. He wrote also *Sentimens de St. Augustin* (1768); *De Animabus Justorum* (Rome, 1766, 2 vols. 4to). He died Feb. 27, 1786.—London, *Eccl. Dict.* s. v.; Hoefler, *Nouv. Biog. Générale*, viii, 74.

Cadytīs. See JERUSALEM.

Cæcilia. See CECILIA.

Cæcilian. See DONATISTS.

Cædmon or **Cedmon**, an Anglo-Saxon Benedictine and poet, born in Northumberland, died at Whitby in 676 or 680. He is the first person of whom we possess any metrical composition in our vernacular. It is a kind of ode, of eighteen lines, celebrating the praises of the Creator, preserved in Alfred's translation of Bede. "Bede gives the following account. Cædmon seems to have had the care of the cattle of the monks of Whitby. It appears to have been the custom of our Saxon forefathers to amuse themselves at supper with improvisatore descants accompanied by the harp, as is still practised at meetings of the Welsh bards. Cædmon, when the harp passed round among the guests, was fain, as it approached him, to shrink away from the assembly and retire to his own house. Once, after it had thus happened, as he was sleeping at night, some one seemed to say to him, 'Cædmon, sing

me something.' He replied, 'I cannot sing;' and he told how his inability to sing had been the cause of his quitting the hall. 'Yet thou must sing to me,' said the voice. 'What must I sing?' said he. 'Sing me the origin of things.' The subject thus given him, he composed the short ode in question. When he awoke, the words were fast in his mind. Cædmon in the morning told his vision and repeated his song. The effect was, that the abbess Hilda, and the learned men whom she had collected round her in her monastery at Whitby, believed that he had received from heaven the gift of song, and when on the morrow he returned with a poetic paraphrase of a passage of Scripture which they had given him to versify as a test of his inspiration, they at once acknowledged the verity, and earnestly besought him to become a member of their company. He composed numerous poems on sacred subjects, which were sung in the abbey. Sacred subjects were his delight, and to them he confined himself. He continued in the monastery for the remainder of his life, and there he died, as is conjectured, about 680. The authenticity of the little poem above mentioned is perhaps unquestionable. But, besides this, a very long Saxon poem, which is a metrical paraphrase on parts of the Scriptures, is attributed to Cædmon. An edition of it was printed at Amsterdam in 1656, under the care of Junius. Hickes expresses doubts whether this poem can be attributed to so early a period as the time of Cædmon. He thinks he perceives certain Dano-Saxonisms in it which would lead him to refer it to a much later period. It has been again printed, with a much more accurate text, by Mr. Thorpe, as a publication by the Society of Antiquaries (Lond. 8vo, 1832). Mr. Thorpe is of opinion that it is substantially the work of Cædmon, but with some sophistications of a later period, and in this opinion our best Anglo-Saxon scholars appear inclined to coincide."—*Penny Cyclopædia*, s. v.; Hoefler, *Biographie Générale*, viii, 84.

Cælestius. See CELESTIUS.

Cæularius, MICHAEL, patriarch of Constantinople (A. D. 1043-1059). He was one of the chief promoters of the great schism between the Eastern and Western churches. In 1054 Pope Leo IX sent legates to Constantinople to accommodate matters; but they, being displeasèd at the treatment they received, left a written letter of excommunication, directed against the patriarch, on the altar of the church of St. Sophia, and departed, having shaken off the dust from their feet. The ostensible causes of difference between the churches, as detailed in a letter written by Cæularius and Leo, archbishop of Acryda, to John, bishop of Trani, were the following: that the Latins consecrated with unleavened bread; that they added the words *Filioque* to the creed of the Church; that they taught that the souls of the faithful make expiation in the fires of Purgatory; and that in some other respects they differed in their customs from those of the East. After this outrage on the part of the Roman legates, Cæularius called together a synod at Constantinople 1054, and excommunicated them and their adherents. Cæularius himself was a man of ambitious views and arrogant disposition, and little likely to ward off the final rupture with Rome, which in fact took place. However, the Emperor Isaac Comnenius took umbrage at his behavior, and, A. D. 1059, having caused him to be seized, sent him to Præconnessus. Cæularius refused to resign the patriarchal throne as the emperor endeavored to compel him to do, but died shortly afterward in exile.—Baron, *Annales*, xi, A. D. 1054; Mosheim, *Ch. Hist.* cent. xi, pt. ii, ch. iii; Neander, *Ch. History*, lii, 580.

Cæsar (Græcized *Kaisar*; hence the Germ. title *Kaiser*, Russian *Csar*), a name assumed by or conferred upon all the Roman emperors after Julius Cæsar (who is said to have been so named from his having been born by a surgical operation, *cæsus*). In this way

it became a sort of title, like Pharaoh, and, as such, is usually applied to the emperors in the New Testament, as the sovereign of Judæa (John xix, 15; Acts xvii, 7), without their distinctive proper names. See also AUGUSTUS. It was to him that the Jews paid tribute (Matt. xxii, 17; Luke xx, 22; xxiii, 2), and to him that such Jews as were *cives Romani* had the right of appeal (Acts xxv, 11; xxvi, 82; xxviii, 19); in which case, if their cause was a criminal one, they were sent to Rome (Acts xxv, 12, 21; comp. Pliny, *Epp.* x, 97), where was the court of the emperor (Phil. iv, 22). The Cæsars mentioned in the New Testament are Augustus (Luke ii, 1), Tiberius (Luke iii, 1; xx, 22), Claudius (Acts xi, 28), Nero (Acts xxv, 8); Caligula, who succeeded Tiberius, is not mentioned. See each name. On Phil. iv, 22, see HOUSEHOLD.

Cæsare'a (Καϊάρια, in the Targum כַּיָּרִיָּא), the name of several cities under the Roman rule, given to them in compliment of some of the emperors; especially of two important towns in Palestine.

1. **CÆSARĒA PALESTĪNĒ** (Καϊάρεια ἢ Παλαιστίνης), or "Cæsarea of Palestine" (so called to distinguish it from the other Cæsares), or simply Cæsarea (without addition, from its eminence as the Roman metropolis of Palestine, and the residence of the procurator). The numerous passages in which it occurs (Acts viii, 40; ix, 80; x, 1, 24; xi, 11; xii, 19; xviii, 22; xxi, 8, 16; xxiii, 28, 83; xxv, 1, 4, 6, 18) show how important a place this city occupies in the Acts of the Apostles. It was situated on the coast of Palestine, on the line of the great road from Tyre to Egypt, and about half way between Joppa and Dora (Josephus, *War*, i, 21, 5). The journey of the apostle Peter from Joppa (Acts x, 24) occupied rather more than a day. On the other hand, Paul's journey from Ptolemais (Acts xxi, 8) was accomplished within the day. The distance from Jerusalem is stated by Josephus in round numbers as 600 stadia (*Ant.* xiii, 11, 2; *War*, i, 8, 5). The Jerusalem Itinerary gives sixty-eight miles (*Wes-seling*, p. 600; see Robinson, *Bib. Res.* iii, 45). It has been ascertained, however, that there was a shorter road by *Antipatris* than that which is given in the Itinerary—a point of some importance in reference to the night-journey of Acts xxiii. See ANTIPATRIS. The actual distance in a direct line is forty-seven English miles.

In Strabo's time there was on this point of the coast merely a town called "Strato's Tower," with a landing-place (*πρόσορμον ἔχων*), whereas, in the time of Tacitus, Cæsarea is spoken of as being the head of Judæa ("Judæa caput," Tac. *Hist.* ii, 79). It was in this interval that the city was built by Herod the Great (Josephus, *Ant.* xv, 9, 6; Strabo, xvi, 2, 27; Pliny, *H. N.* v, 15). The work was, in fact, accomplished in ten years. The utmost care and expense were lavished on the building of Cæsarea. It was a proud monument of the reign of Herod, who named it in honor of the Emperor Augustus. The full name was *Cæsarea Sebaste* (Καϊάρεια Σεβαστή, Joseph. *Ant.* xvi, 5, 1). It was sometimes called *Cæsarea Stratonis*, and sometimes also (from its position) *Maritime Cæsarea* (παράλιος, Joseph. *War*, iii, 9, 1, or ἡ ἐν τῇ θαλάττῃ, *id.* vii, 1, 8). The magnificence of Cæsarea is described in detail by Josephus in two places (*Ant.* xv, 9; *War*, i, 21). The chief features were connected with the harbor (itself called Σεβαστὸς λιμὴν, on coins and by Josephus, *Ant.* xvii, 5, 1), which was equal in size to the Piræus of Athens. The whole coast of Palestine may be said to be extremely inhospitable, exposed as it is to the fury of the western storms, with no natural port affording adequate shelter to the vessels resorting to it. To remedy this defect, Herod, who, though an arbitrary tyrant, did much for the improvement of Judæa, set about erecting, at immense cost and labor, one of the most stupendous works of antiquity. He threw out a semicircular mole, which protected the

port of Cæsarea on the south and west, leaving only a sufficient opening for vessels to enter from the north; so that, within the enclosed space, a fleet might ride at all weathers in perfect security. This breakwater was constructed of immense blocks of stone brought from a great distance, and sunk to the depth of 20 fathoms in the sea. Broad landing-wharves surrounded the harbor, and conspicuous from the sea was a temple dedicated to Cæsar and to Rome, and containing colossal statues of the emperor and the imperial city. Besides this, Herod added a theatre and an amphitheatre; and, when the whole was finished, he fixed his residence there, and thus elevated the city to the rank of the civil and military capital of Judæa, which rank it continued to enjoy as long as the country remained a province of the Roman empire (see Dr. Mansford, *Script. Geograph.*). Vespasian was first declared emperor at Cæsarea, and he raised it to the rank of a Roman "colony" (q. v.), granting it, first, exemption from the capitation tax, and afterward from the ground taxes (the real *ius Italicum*). The place was, however, inhabited chiefly by Gentiles, though some thousands of Jews lived in it (Joseph. *War*, iii, 9, 1; iii, 14; *Ant.* xx, 8, 7; *Life*, 11). It seems there was a standing dispute between the Jewish and Gentile inhabitants of Cæsarea to which of them the city really belonged. The former claimed it as having been built by a Jew, meaning King Herod; the latter admitted this, but contended that he built it for them, and not for Jews, seeing that he had filled it with statues and temples of their gods, which the latter abominated (Joseph. *War*, ii, 13, 7). This quarrel sometimes came to blows, and eventually the matter was referred to the Emperor Nero, whose decision in favor of the Gentiles, and the behavior of the latter thereupon, gave deep offence to the Jews generally, and afforded occasion for the first outbreak, which led to the war with the Romans (Joseph. *War*, ii, 14). One of the first acts of that war was the massacre of all the Jewish inhabitants by the Gentiles to the number of 20,000 (*id.* ii, 18, 1). This city was the head-quarters of one of the Roman cohorts (q. v.) in Palestine.



Coin of Cæsarea Palestine.

Cæsarea is the scene of several interesting circumstances described in the New Testament, such as the conversion of Cornelius, the first-fruits of the Gentiles (Acts x); the residence of Philip the Evangelist (Acts xxi, 8). It was here also, in the amphitheatre built by his grandfather, that Herod Agrippa was smitten of God and died (Acts xii, 21-23). From hence the apostle Paul sailed to Tarsus when forced to leave Jerusalem on his return from Damascus (ix, 80), and at this port he landed after his second missionary journey (xviii, 22). He also spent some time at Cæsarea on his return from the third missionary journey (xxi, 8, 16), and before long was brought back a prisoner to the same place (xxiii, 28, 83), where he remained some time in bonds before his voyage to Italy (xxv, 1, 4, 6, 18). After the destruction of Jerusalem, Cæsarea became the spiritual metropolis of all Palestine; but, since the beginning of the 5th century, when the land was divided into three provinces, Palestina Prima, Secunda, and Tertia, it became the capital of only the first province, and subordinate to the bishopric of Jerusalem, which was elevated into a patriarchate with the rights of primacy over "the three Palestines." Cæsarea is chiefly noted as the birthplace and episcopate of Eusebius, the celebrated Church historian, in

the beginning of the 4th century, and was conspicuous for the constancy of its martyrs and confessors in the various persecutions of the Church, especially the last (Euseb. *Hist. Eccl.* viii, s. f.). It was also the scene of some of Origen's labors and the birthplace of Procopius. It continued to be a city of some importance even in the time of the Crusades. It still retains the ancient name in the form of *Kaisariyah*, but has long been desolate. The most conspicuous ruin is that of an old castle at the extremity of the ancient mole. A great extent of ground is covered by the remains of the city. A low wall of gray stone encompasses these ruins, and without this is a moat now dry. Between the accumulation of rubbish and the growth of long grass, it is difficult to define the form and nature of the various ruins thus enclosed. Nevertheless, the remains of two aqueducts, running north and south, are still visible. The one next the sea is carried upon high arches; the lower one, to the eastward, carries its waters along a low wall in an arched channel five or six feet wide. The water is abundant and of excellent quality, and the small vessels of the country often put in here to take in their supplies. Cæsarea is, apparently, never frequented for any other purpose; even the high-road leaves it wide; and it has not been visited by most of the numerous travellers in Palestine. The present tenants of the ruins are snakes, scorpions, lizards, wild boars, and jackals.—Kitto; Smith. See G. Robinson's *Travels*, i, 199; Bartlett's *Jerusalem*, p. 6; Trull's *Josephus*, p. xlix; Conybeare and Howson's *Life and Epistles of St. Paul*, ii, 279; Rosenmüller, *Alterth.* II, ii, 326 sq.; Reland, *Palæst.* p. 670 sq.; Otho, *Lex. Rab.* p. 108 sq.; Thomson, *Land and Book*, ii, 284 sq.; Ritter, *Erdk.* xvi, 598 sq.; Wilson, *Bible Lands*, ii, 250 sq.; Prokesch, *Reise*, p. 28 sq.; Steber, *De Cæsarea Palestinæ Episcopis* (Lips. 1784); Wiltch, *Geography and Stat. of the Church*, i, 58, 214 sq.

CÆSAREA, CC^VNCILS OF. Several councils have been held at this place. The most important are, 1, in 334, an Arian council, against Athanasius; 2, in 338, in which Cyril (q. v.), bishop of Jerusalem, was deposed.—Smith, *Tables of Church Hist.*; Landon, *Manual of Councils*.

2. CÆSARĒA PHILIPPI, or "Cæsarea of Phillip" (*Καῖσαρία ἢ Φιλίππου*, so Joseph. *Ant.* xx, 8, 4; *War*, iii, 8, 7, 2, 1; Euseb. *Hist. Eccl.* vii, 17), as having been in later times much enlarged and beautified by Phillip the tetrarch (Joseph. *Ant.* xviii, 2, 1; *War*, ii, 9, 1), who called it Cæsarea in honor of Tiberius the emperor, adding the cognomen of Phillippi to distinguish it from Cæsarea of Palestine. It was also known as CÆSARĒA-PANĒAS (*Καῖσαρία Παναῖας* or *Παναῖς*, Joseph. *Ant.* xviii, 2, 8; *War*, ii, 9, 1; Ptolemy, v, 15, 21; Pliny, v, 15, 15; Sozomen, v, 21; on coins, *K. τὸ Πανίον* or *πρὸς Πανίον*; in Steph. Byz. incorrectly *πρὸς τῇ Παναῖδι*), or simply *Panias* (*Παναῖς*, *Παναῖς*, or *Παναῖς*, Hierocl. p. 716), its original name (Joseph. *Ant.* xv, 10, 8; comp. Pliny, v, 15; *Panaiç*; in Cedren. p. 805; Samar. *סְנַיָּב*); from the adjoining mountain *Panion* (*Πάνιον* or *Πανίον*), which, with the spring therein, was dedicated to the heathen Pan (Philostorg. vii, 3), and which latter name has alone been retained in the present name *Banias* (Burckhardt, i, 90; comp. *Targ. Jonath.* on Num. xxxiv, 11); being, according to many, no other than the early LAISH (q. v.) of Dan (*Judg.* xviii, 7, 29), or LESHEM (*Josh.* xix, 47; comp. Theodoret, *Quest.* in *Judic.* 26). Cæsarea Philippⁱ is mentioned only in the first two Gospels (Matt. xvi, 13; Mark viii, 27), and in accounts of the same transactions. The story of the early Christian writers that the woman healed of the issue of blood, and supposed to have been named Berenice, lived at this place, rests on no foundation (Euseb. *Hist. Eccl.* vii, 18; Sozom. v, 21; Theophan. *Chronogr.* 41; Phot. *Cod.* 271, p. 823).

This city lay about 120 miles north from Jerusalem,

and a day and a half's journey from Damascus, at the springs of the Jordan, and near the foot of Isabel Shrik, or the Prince's Mount, a lofty branch of Lebanon, forming in that direction the boundary between Palestine and Syria Proper. Here Herod the Great erected a temple to Augustus (Joseph. *Ant.* xv, 10, 8; comp. *War*, i, 21, 8). *Panias* became part of the territory of Philip, tetrarch of Trachonitis, who enlarged and embellished the town, and called it *Cæsarea Philippi*, partly after his own name and partly after that of the emperor (*Ant.* xviii, 2, 1; *War*, ii, 9, 1). Agrippa II followed in the same course of flattery, and called the place *Neronias* (*Ant.* xx, 9, 4). Josephus seems to imply (*Life*, 18) that many heathens resided here. Titus exhibited gladiatorial shows at Cæsarea Philippi after the downfall of Jerusalem, in which the Jewish prisoners were compelled to fight like gladiators, and numbers perished in the inhuman contests (*War*, vii, 2, 1). The old name was not lost. Coins of *Cæsarea Panæas* continued through the reigns of many emperors. Under the simple name of *Panæas* it was the seat of a Greek bishopric in the period of the great councils (the second bishop being present at the Council of Nice, and the last at the Council of Chalcedon in 451), and of a Latin bishopric of Phœnicia during subsequent Christian occupancy, when it was called *Belinas*. "During the Crusades," says Dr. Robinson, "it was the scene of various changes and conflicts. It first came into the possession of the Christians in 1129, along with the fortress on the adjacent mountain, being delivered over to them by its Israelite governor, after their unsuccessful attempt upon Damascus in behalf of that sect. The city and castle were given as a fief to the Knight Rayner Brus. In 1182, during the absence of Rayner, Baniās was taken, after a short assault, by the Sultan Ismail of Damascus. It was recaptured by the Franks, aided by the Damascenes themselves. In 1189 the temporal control was restored to Rayner Brus, and the city made a Latin bishopric, under the jurisdiction of the Archbishop of Tyre" (*Researches*, iii, 860).

The site is still called *Banias*, the first name having here, as in other cases, survived the second. It has now dwindled into a paltry and insignificant village, whose mean and destitute condition contrasts strikingly with the rich and luxuriant character of the surrounding country. Yet many remains of ancient architecture are found in the neighborhood, bearing testimony to the former grandeur of the place, although it is difficult to trace the site of the splendid temple erected here in honor of Augustus. The place itself is remarkable in its physical and picturesque characteristics, as well as in its historical associations. It was at the easternmost and most important of the two recognised sources of the Jordan, the other being at Tell el-Kady. The spring rises, and the city was built, on a limestone terrace in a valley at the base of Mount Hermon. On the north-east side of the present village, the river, held to be the principal source of the Jordan, issues from a spacious cavern under a wall of rock. Around this source are many hewn stones. In the face of the cliff, directly over the cavern and in other parts, several niches have been cut, apparently to receive statues. Each of these niches had once an inscription; and one of them, copied by Burckhardt, appears to have been a dedication by a priest of Pan. The situation is unique, combining in an unusual degree the elements of grandeur and beauty. It nestles in its recess at the southern base of the mighty Hermon, which towers in majesty to an elevation of 7000 or 8000 feet above. The abundant waters of the glorious fountain spread over the terrace luxuriant fertility and the graceful interchange of copse, lawn, and waving fields (Robinson, *Later Bib. Res.* p. 404).

About three miles north-east of Banias are the remains of an immense ancient castle, covering one of the spurs of Lebanon, about fifteen hundred feet above



Cave at Banias.

the plain and city. It is enclosed by walls of immense strength and thickness, and must have been an almost impregnable fortress. It is of Saracenic architecture; but many of the fine bevelled stones with which the noble round towers are constructed must have belonged to a far more ancient edifice. This castle received the name of *es-Subeibeh* about the time of the Crusades, perhaps from the half-gipsy Arab tribe of the same name that still inhabit the vicinity. A short distance east of this castle there is a very ancient ruin, surrounded by a thick grove of venerable oaks. There are also ruins west of Banias, consisting of columns, capitals, and foundations of buildings, together with canals that formerly conveyed the water of the brook, now crossed by a stone bridge. Above the fountain are Greek inscriptions in the rock, confirming the testimony of Josephus that Agrippa adorned Banias with royal liberality, and also sustaining the ancient statements that the fountain was held sacred to Pan (*Biblioth. Sacra*, 1846, p. 194). See Reland, *Palæst.* p. 918 sq.; Eckhel, *Doctr. Num.* iii, 839 sq.; Burckhardt, *Syria*, p. 87 sq.; Buckingham, ii, 814 sq.; Thomson, *Land and Book*, i, 344 sq.; Schwarz, *Palæst.* p. 144; *Mod. Traveller*, p. 327 sq., Am. ed.; Raumer, *Paläst.* p. 215; Wilson, *Land of Bible*, ii, 175 sq.; Porter, *Damascus*, i, 307 sq.

CÆSARIUS, ST., OF ARLES, was born in 469 at Chalon-sur-Saône. He early developed monkish tendencies, and privately withdrew from his parents to the monastery of Lerins, where he was appointed to the office of cellarer. Afterward, falling ill from extreme asceticism, he was obliged to remove to Arles, and was beloved by Eonius the bishop, whom, in 502, he succeeded in the see of Arles. He died in 542, leaving many homilies, containing evidence of much piety combined with great superstition. A volume of them was edited by Stephen Baluze (Paris, 1669, 8vo). The others are given in the *Biblioth. Patrum*, viii, 819, 860, and xxvii, 324. His *Regula Monachorum* (contained in *Holstenii Codex Regul. Monast.* Rome, 1661) was adopted by many convents, and often used by the founders of orders. Monks and nuns of St. Cæsarius existed until the rule of Benedict was generally adopted. A graphic sketch of his life and labors is given

by Neander, *Light in Dark Places*, p. 50.—Mosheim, *Ch. Hist.* i, 164, 166; Neander, *Ch. Hist.* ii, 261, 804, 660; *Cære, Hist. Lit.* anno 502.

CÆSARIUS OF HEISTERBACH, a preacher and historian of note, in 1199 became a Cistercian monk in the monastery of Heisterbach, in the diocese of Cologne. He became eventually prior of the convent of the Valley of St. Peter, near Bonn. He lived until the year 1227, but when he died is unknown. His writings are, 1. *De miraculis et visionibus sui temporis* (chiefly in Germany, Cologne, 1591, 8vo); the first edition is without name of place or date;—2. *Vita S. Engelberti archiep. Colon.* (Cologne, 1633, and in Surius, November 7th);—3. *Homilia*, edited under the title of *Fasciculi Moralitatis*, by Copenstein (Cologne, 1615);—4. *Catalogus Episcoporum Coloniensium*, published, with a continuation by another author, in vol. ii of the *Fontes Rerum German.* (1845);—5. An unedited *Vita S. Elizabetha* is preserved among the manuscripts of the library of Brussels. Many of his sermons are highly praised for their evangelical tone, as well as for their eloquence. His *De Miraculis* affords a graphic picture of the state of his times. See Kauffmann, *Cæsarius v. Heisterbach* (Köln, 1850); *Cave, Hist. Lit.* anno 1225; Herzog, *Real-Encyclop.* ii, 490.

CÆSARIUS OF NAZIANZUS, a younger brother of Gregory Nazianzen, was educated first at Alexandria, whence he proceeded to Constantinople, where he obtained high honors, resisted the attempts of the Emperor Julian to win him from the faith, and died under Valens in 368. He was distinguished for his proficiency in physics and mathematics. Gregory delivered his funeral sermon (*Oratio fnebris in laudem Cæsarii fratris*, Or. viii), in which his piety and devotion are lauded. According to Suidas, he wrote *contra Gentes*, and four Dialogues are given as his in the Latin editions of St. Gregory and in the *Bibliotheca Patrum*.—Ullmann, *Life of Gregory*, p. 182; *Cave, Hist. Lit.* anno 362.

Cæsennius. See PÆTUS.

Cage (כַּלְסוּב, *kelsoḅ*, φυλακί). Bird-cages are named in Jer. v, 27; Rev. xviii, 2; and are perhaps implied in Job xli, 5, where "playing with a bird" is

mentioned. See **BIRD**. In the first of these passages the Sept. renders it by *παγίς*, a *mare*, implying that it was used for holding decoys with which to entrap other birds until the cage was full—an idea which the derivation of the Heb. word confirms (from *צָבַר*, to *clasp* together by the shutting of the valves or trap). This interpretation is therefore better than that of the margin, “coop,” or that of the Talmud, “a place of fattening,” implying that it was used for holding wild or tame fowls until they became fit for the table. The same article is referred to in *Ecclus. xi, 30*, under the term *κάρταλλος*, which is elsewhere used of a tapering basket. See **FOWLING**. In *Rev. xviii, 2*, the Greek term is *φουλακί*, meaning a prison or restricted habitation rather than a cage. This just suffices to show that the ancient Israelites kept birds in cages; but we have no farther information on the subject, nor any allusions to the singing of birds so kept. The cages were probably of the same forms which we still observe in the East, and which are shown in the annexed engraving. It is remarkable that there is no



Modern Oriental Wicker Bird-cages.

appearance of bird-cages in any of the domestic scenes which are portrayed on the mural tablets of the Egyptians. In *Amos viii, 12*, the same word *kelub'* denotes a fruit-basket, so called, doubtless, from its resemblance to a cage. See **BASKET**.

Caians (I.), a name given by *Irenæus*, *Epiphanius*, and *Theodoret* to a sect of *Ophtes*, whom modern writers call more correctly *Cainites* (q. v.). (II.) A sect mentioned by *Tertullian*, which rejected the doctrine of baptism. It is doubtful whether this sect is identical with the preceding. *Tertullian* mentions a certain *Quintilla* as the founder, and some have concluded from this that the sect is identical with the *Quintillians* (q. v.).

Cai'aphas (*Καϊάφας*, perhaps from, the *Chald.* *קַיָּאָפָּא*, *depression*), called by *Josephus* (*Ant. xviii, 2, 2*) *Joseph Caiaphas* (*Ἰωσήφος, ὁ καὶ Καϊάφας*), was high-priest of the Jews in the reign of *Tiberius Cæsar*, at the beginning of our Lord's public ministry (*Luke iii, 2*), A. D. 25, and also at the time of his condemnation and crucifixion (*Matt. xxvi, 3, 57*; *John xi, 49*; *xviii, 13, 14, 24, 28*; *Acts iv, 6*), A. D. 29. The Procurator *Valerius Gratus*, shortly before his leaving the province (A. D. 25), appointed him to the dignity, which was before held by *Simon ben-Camith*. He held it during the whole procuratorship of *Pontius Pilate*, but soon after his removal from that office was deposed by the Proconsul *Vitellius* (A. D. 36), and succeeded by *Jonathan*, son of *Ananus* (*Joseph. Ant. xviii, 4, 3*). Some in the ancient Church confounded him with the historian *Josephus*, and believed him to have become a convert to Christianity (*Assemani, Biblioth. Orient. ii, 166*). His wife was the daughter of *Annas*, or *Ananus*, who had formerly been high-priest, and who still possessed great influence and control in sacerdotal matters, several of his family successively holding the high-priesthood. The names of *Annas* and *Caiaphas* are coupled by *Luke*, “*Annas and Caiaphas being the high-priests*,” and this has given occasion to no small amount of discussion. Some maintain that *Annas* and *Caiaphas* then discharged the functions of the high-priesthood by turns; but this is not reconcilable with the statement of *Josephus*. Others think that *Caiaphas* is called high-priest, because he then actually exercised the functions of the office, and that *Annas* is so called because he had formerly filled the situation. But it does not thus appear why, of those who held

the high-priesthood before *Caiaphas*, *Annas* in particular should be named, and not *Ishmael*, *Eliazar*, or *Simon*, who had all served the office more recently than *Annas*. Hence *Kuinöl* and others consider it as the more probable opinion that *Caiaphas* was the high-priest, but that *Annas* was his vicar or deputy, called in the Hebrew *סָגָן*, *sagan*. Nor can that office be thought unworthy of a man who had filled the pontifical office, since the dignity of *sagan* was also great. Thus, for instance, on urgent occasions he might even enter the *Holy of Holies* (*Lightfoot, Hor. Heb. ad Luc. iii, 2*). Nor ought it to seem strange or unusual that the vicar of a high-priest should be called by that name. For if, as it appears, those who had once held the office were after by courtesy called high-priests, with greater justice might *Annas*, who was both a pontifical person and high-priest's vicar, be so called. In fact, the very appellation of high-priest is given to a *sagan* by *Josephus* (*Ant. xvii, 6, 4*). (See the commentators on *Luke iii, 2*, particularly *Hammond*, *Lightfoot*, *Kuinöl*, and *Bloomfield*.) See **ANNAS**. *Caiaphas* belonged to the sect of the *Sadducees* (*Acts v, 17*). (See *Hecht, De Sadducæismo Caiaphæ*, *Bud. 1718*.)—*Smith, s. v.*; *Kitto, s. v.* See **HIGH-PRIEST**.

The wonderful miracle of raising *Lazarus* from the dead convinced many of the Jews that *Christ* was sent from God; and the chief priests and the Pharisees, alarmed at the increase of his followers, summoned a council, and pretended that their liberties were in danger; that the Romans would become jealous of them, and that their destruction was inevitable if something were not done at once to check his progress. *Caiaphas* was a member of the council, and expressed his decided opinion in favor of putting *Jesus* to death, as the only way of saving the nation from the evils which his success would bring upon them. His language was, “*Ye know nothing at all; nor consider that it is expedient for us that one man should die for the people, and that the whole nation perish not*” (*John xi, 49*). This counsel was wicked and unjust in the highest degree; but as there was no offence charged, it seemed the only plausible excuse for putting *Christ* to death. The high-priest's language on this occasion was prophetic, though he did not intend it so. The evangelist, in giving an account of this extraordinary occurrence, enlarges on the prophetic language of the high-priest, and shows the extent and blessedness of the dispensation of mercy through *Jesus Christ*. Nothing of this, however, was in the mind of the cruel and bigoted high-priest. After *Christ* was arrested, he was first taken before *Annas*, who sent him to his son-in-law *Caiaphas*, who probably lived in the same house; he was then arraigned before *Caiaphas*, and an effort was made to produce false testimony sufficient for his condemnation. This expedient failed; for though two persons appeared to testify, they did not agree, and at last *Caiaphas* put our Saviour himself upon oath that he should say whether he was indeed the *Christ*, the *Son of God*, or not. The answer was, of course, in the affirmative (q. v.), and was accompanied by a declaration of his Divine power and majesty. The high-priest pretended to be greatly grieved at what he considered the blasphemy (q. v.) of our Saviour's pretensions, and forthwith appealed to his enraged enemies to say if this was not enough. They answered at once that he deserved to die, and then, in the very presence of *Caiaphas*, and without any restraint from him, they fell upon their guiltless victim with insults and injuries. As *Caiaphas* had no power to inflict the punishment of death, *Christ* was taken from him to *Pilate*, the Roman governor, that his execution might be duly ordered (*Matt. xxvi, 3, 57*; *John xviii, 13, 28*). The bigoted fury of *Caiaphas* exhibited itself also against the first efforts of the apostles (*Acts iv, 6*).

Treatises more or less general on the character and conduct of *Caiaphas* in the above transaction have

been written in Latin by Baumgarten-Crusius (*Opusc.* p. 149 sq.), Hase (Brem. 1703, also in Iken's *Theaur.* ii, 549 sq.), Hecht (Buding. 1719), Haufen (Viteb. 1713), Hoder (Upsal, 1771), Hofmann (in *Menthenii Thea.* ii, 216-222), Lungershausen (Jen. 1695), Salzmänn (Argent. 1742), Scharbau (Lubeck, 1715), Schickendanz (Fctt. and V. 1772), Weber (Viteb. 1807), Seltner (Altorf, 1721); in French by Dupin (Paris, 1829). See also Evans, *Script. Biog.* ii, 257.

Caiet (or **Cayet**), PIERRE VICTOIRE PALMA, was born at Montrichard, in Touraine, in 1525. He became a Protestant under the instructions of Peter Ramus, at Paris; afterward studied theology at Geneva, and about 1582 was a minister in Poitou. Catharine of Bourbon made him her chaplain, and brought him to Paris. Here, under the influence of cardinal Duperron, he abjured Protestantism, Nov. 9, 1595, became professor of Hebrew and Oriental languages in the college of Navarre, and died March 10, 1610. He left many controversial works, on the motives which led to his conversion; on the Eucharist; on the Mass; on the Church and the Apostolical Succession, etc. His best known works are his *Chronologie Septénaire* and *Notennaire*, 1598-1604 (Paris, 1605, 8vo).—Hoefler, *Nov. Biog. Gén.* ix, 809.

Cain (Heb. *Ka' yin*, קַיִן, a lance [but see below]), the name of a man and of a city. See KENTITE; TUBAL-CAIN.

1. (Sept. and N. T. *Käin*. The root seems to be קַיִן, to beat, perhaps with allusion to the murder; the context, however, ver. 1, makes this = בָּרָא, to create, obtain; others, as Eusebius and Chrysostom, derive it from some root signifying *envy*; Von Bohlen, *Introd. to Gen.* ii, 85, seeks it in the Arabic *kayn*, a smith, from the arts introduced by the Cainites; Josephus *Græcizet it, Käic, -ioc, Ant.* i, 2, 2.) The first-born (B.C. apparently cir. 4170) of the human race, and likewise the first murderer and fratricide, B.C. cir. 4048. His history is detailed in Gen. chap. iv; the facts there given are in brief these: He was the eldest son of Adam and Eve; he followed the business of agriculture; in a fit of jealousy, roused by the rejection of his own sacrifice and the acceptance of Abel's, he committed the crime of murder, for which he was expelled from Eden, and led the life of an exile; he settled in the land of Nod, and built a city, which he named after his son Enoch; his descendants are enumerated, together with the inventions for which they were remarkable. Occasional references to Cain are made in the N. T. (Heb. xi, 4; 1 John iii, 12; Jude 11).

Among all the instances of crime, none impress the mind with a stronger feeling of horror than that of Cain. It is not, however, clear that he had fully premeditated taking the life of his brother, if, indeed, he was aware by what a slight accident death would ensue; for this was the first instance of human mortality. But it is certain that he had resolved upon some desperate outrage upon his brother's person, and he deliberately took occasion to perpetrate it. Abel, as most think, brought two offerings, the one an oblation, the other a sacrifice. Cain brought but the former—a mere acknowledgment, it is supposed, of the sovereignty of God—neglecting to offer the sacrifice, which would have been a confession of fallen nature, and, typically, an atonement for sin. It was not, therefore, the mere difference of feeling with which the two offerings were brought which constituted the virtue of the one or the guilt of the other brother. "The malignity of his temper showed itself in his unwillingness to ask his brother for a victim from among his herd. He offered before God an unlawful sacrifice," because a bloodless one, Heb. ix, 22 (Jarvis, *Church of the Redeemed*, p. 14). The circumstances connected with this offence are related in a brief but graphic manner in the Heb. text, the force of which is not well brought out in the Auth. Vers. (Gen. iv, 2-16). Abel, being a

herdsman, naturally brought at the end of the week (for the Sabbath was already a well-known institution) an offering of the first-born and fattest of his flocks, while Cain, as a husbandman (hence the greater severity of the curse which blasted his professional hopes), presented an oblation of vegetable productions. The undevout temper and wicked nature of Cain are sufficiently evinced by his resentment against the Almighty, as if partial to his brother (see below). The Divine Being condescends to expostulate with him on his unreasonable behavior, and to warn him of the danger of cherishing the jealousy which he seems to have already entertained against Abel: "If thou reformest, there is forgiveness [with me for thy past offences]; but if not, [then beware, for] sin crouches at thy door [like a wild beast ready to seize thee on the first opportunity], and against thee is its design; but do thou subdue it [i. e. thy evil disposition]." Instead of heeding this advice, however, the ill-natured man, taking the first occasion to narrate the circumstance to his brother (probably in an upbraiding manner), fell into the very snare of Satan against which he had been warned; his feelings became again excited, as they two were alone conversing in the open field, and, there being no one near to witness or avert the consequences, he suddenly turned against his brother, and by an angry blow (probably with some agricultural implement, in the formation of which he had doubtless already begun to exercise the mechanical ingenuity for which his descendants became famous) he laid him dead upon the ground. Instead of the penitence which the sight of his brother's blood ought to have inspired in his horror-stricken soul, the craven murderer insolently demands of the all-seeing God, when questioned as to his crime, "I know nothing about the matter; am I my brother's keeper?" But when conviction is fastened upon him, and the penalty announced, with the despairing but still impotent remorse of Judas, the guilty wretch exclaims, "My iniquity is too great for forgiveness! (וְדָרְלוּ עֵינַי מִקְּטוּלָה); Sept. *μὴ ζῶν ἢ αἴρια μοῦ τοῦ ἀπεθνήκαί μ'.*" for thou hast utterly driven me out this day from the face of the ground [of this pleasant region]," and I shall be in danger of starvation, and even of perishing by the hand of every stranger whom I may meet. (See Kitto's *Daily Bible Illustr.* in loc.; Fecht's *Hist. Aëlis et Caimi*, Rost. 1704.)

The punishment which attended the crime admitted of no escape, scarcely of any conceivable alleviation. "He lost the privileges of primogeniture, was deprived of the priesthood, banished from 'the presence' of the divine glory between the cherubim, shut out from the hopes of mercy, and, with his descendants, delivered over unprotected to the assaults of the great adversary" (Jarvis, *Church of the Redeemed*, p. 14). Cursed from the earth himself, the earth was doomed to a double barrenness wherever the offender should set his foot. Physical want and hardship, therefore, were among the first of the miseries heaped upon his head. Next came those of mind and conscience: "The voice of thy brother's blood crieth unto me from the ground." Nor did any retreat remain to him from the terrors of his own soul or those of Divine vengeance: "From thy face shall I be hid," was his agonizing and hopeless cry. The statement that "Cain went out from the presence of the Lord" represents him as abiding, till thus exiled, in some favored spot where the Almighty still, by visible signs, manifested himself to his fallen creatures. The expression of dread lest, as he wandered over the face of the earth, he might be recognised and slain, has an awful sound when falling from the mouth of a murderer. But he was to be protected against the wrath of his fellow-men; and of this God gave him assurance, not, says Shuckford, by setting a mark upon him, which is a false translation, but by appointing a sign or token which he himself might understand as a proof that he should not perish by the hand of another, as Abel had perished by his. This

sign was probably no other than the Divine denunciation uttered at the time against any one who should venture to do him injury, and which, being well known, would prove a sufficient *caesat*. As such it is referred to by his descendant Lamech (Gen. iv, 24). The passage may therefore be rendered, "Thus Jehovah appointed a token for Cain, so that no one who met him should slay him." What was the Divine purpose in affording him this protection it is difficult to determine. That it was not with the intention of prolonging his misery may be conjectured from the fact that it was granted in answer to his own piteous cry for mercy. Some writers have spoken of the possibility of his becoming a true penitent, and of his having at length obtained the Divine forgiveness (Ordob, *Cainus nos desperans*, Lips. 1706).—Kitto, s. v.

It may be worthy of observation that especial mention is made of the fact that Cain, having traveled into the land of Nod, there built a city; and further, that his descendants were chiefly celebrated for their skill in the arts of social life. In both accounts may probably be discovered the powerful struggles with which Cain strove to overcome the difficulties that attended his position as one to whom the tillage of the ground was virtually prohibited. The following points also are noticed in Smith's *Dict.* s. v.

(1.) The position of the "land of Nod." The name itself tells us little; it means *flight* or *exile*, in reference to ver. 12, where a cognate word is used: Von Bohlen's attempt to identify it with India, as though the Hebrew name *Hind* (הינד) had been erroneously read *han-Nod*, is too far fetched; the only indication of its position is the indefinite notice that it was "east of Eden" (ver. 16), which, of course, throws us back to the previous settlement of the position of Eden itself. Knobel (*Cosmos*, in loc.), who adopts an ethnological interpretation of the history of Cain's descendants, would identify Nod with the whole of Eastern Asia, and even hints at a possible connection between the names Cain and China. It seems vain to attempt the identification of Nod with any special locality; the direction "east of Eden" may have reference to the previous notice in iii, 24, and may indicate that the land was opposite to (Sept. *καθ' ἄκρον*) the entrance, which was barred against his return. It is not improbable that the east was further used to mark the direction which the Cainites took, as distinct from the Sethites, who would, according to Hebrew notions, be settled toward the west. Similar observations must be made in regard to the city Enoch, which has been identified with the names of the Hemlochí, a tribe in Caucasus (so Hase), Anecta, a town in Susiana (Huetius), Chanoge, an ancient town in India (Von Bohlen), and Iconium, as the place where the deified King Annacos was honored (Ewald): all such attempts at identification must be subordinated to the previous settlement of the position of Eden and Nod. See NOD.

(2.) The "mark set upon Cain" has given rise to various speculations, many of which would never have been broached if the Hebrew text had been consulted: the words probably mean that Jehovah gave a sign to Cain, very much as signs were afterward given to Noah (Gen. ix, 18), Moses (Exod. iii, 2, 12), Elijah (1 Kings xix, 11), and Hesekiah (Isa. xxxviii, 7, 8). Whether the sign was perceptible to Cain alone, and given to him once for all, in token that no man should kill him, or whether it was one that was perceptible to others, and designed as a precaution to them, as is implied in the A. V. is uncertain; the nature of the sign itself is still more uncertain (but see above). (See Kraft, *De Signo Caini*, in his *Obs. Sacr.* i, 8.) See MARK.

(3.) The narrative implies the existence of a considerable population in Cain's time; for he fears lest he should be murdered in return for the murder he had committed (ver. 14). Josephus (*Ant.* i, 2, 1) explains his fears as arising, not from men, but from wild beasts; but such an explanation is wholly unnecessary. The

family of Adam may have largely increased before the birth of Seth, as is indeed implied in the notice of Cain's wife (ver. 17), and the mere circumstance that none of the other children are noticed by name may be explained on the ground that their lives furnished nothing worthy of notice. These neighbors must, of course, have been the relatives of Cain, who had now branched out into a considerable community, and as his banishment would necessarily estrange him from them, he entertained the natural apprehension lest in the course of his remaining lifetime they might even become his enemies, especially as they would regard him as a murderer. See BLOOD-REVENGE. His wife must evidently have been one of his sisters (comp. "sons and daughters." Gen. v, 4). Tradition calls her *Save* (Epiph. *Her.* xxix, 6) or *Asura* (Malalas, p. 2); the Arabs call Cain himself *Kabel* by alliteration with the name of his brother (D'Herbelot, *Bibl. Or.* s. v. Cabil). See ADAM.

(4.) The character of Cain deserves a fuller notice. He is described as a man of a morose, malicious, and revengeful temper; and that he presented his offering in this state of mind is implied in the rebuke contained in Gen. iv, 7, which may be rendered thus: "If thou doest well (or, as the Sept. has it, *ὡς ὁφθαί* *προσετίγχε*), is there not an elevation (*ἡδονή*) [of the countenance] (i. e. perhaps *cheerfulness* and *happiness*)? but if thou doest not well [there is a *sinking* of the countenance], sin lurketh (as a wild beast) at the door, and to thee is its desire; but thou shalt rule over it." (So Gesenius and others; but see above.) The narrative implies therefore that his offering was rejected on account of the temper in which it was brought (Sticht, *De colloquio Dei cum Caino*, Alt. 1766). See ABEL.

(5.) The descendants of Cain are enumerated to the sixth generation. Some commentators (Knobel, Von Bohlen) have traced an artificial structure in this genealogy, by which it is rendered parallel to that of the Sethites; e. g. there is a decade of names in each, commencing with Adam and ending with Jabal and Noah, the deficiency of generations in the Cainites being supplied by the addition of the two younger sons of Lamech to the list; and there is a considerable similarity in the names, each list containing a Lamech and an Enoch, while Cain in the one = Cain-an in the other, Methusael = Methuselah, and Mehujael = Mahalaleel; the inference from this comparison being that the one was framed out of the other. It must be observed, however, that the differences far exceed the points of similarity; that the order of the names, the number of generations, and even the meanings of those which are noticed as similar in sound, are sufficiently distinct to remove the impression of artificial construction. (See Bochart, *Hieros.* i, 587.) See PATRIARCH.

(6.) The social condition of the Cainites is prominently brought forward in the history. Cain himself was an agriculturist, Abel a shepherd: the successors of the latter are represented by the Sethites and the progenitors of the Hebrew race in later times, among whom a pastoral life was always held in high honor from the simplicity and devotional habits which it engendered; the successors of the former are depicted as the reverse in all these respects. Cain founded the first city; Lamech instituted polygamy; Jabal introduced the nomadic life; Jubal invented musical instruments; Tubal-cain was the first smith; Lamech's language takes the stately tone of poetry; and even the names of the women, Naamah (*pleasants*), Zillah (*shadow*), Adah (*ornamental*), seem to bespeak an advanced state of civilization. But, along with this, there was violence and godlessness; Cain and Lamech furnish proof of the former, while the concluding words of Gen. iv, 26, imply the latter. See ANTEDILUVIANS.

(7.) The contrast established between the Cainites and the Sethites appears to have reference solely to the social and religious condition of the two races. On the one side there is pictured a high state of civiliza-

tion, unsanctified by religion, and productive of luxury and violence; on the other side, a state of simplicity which afforded no material for history beyond the declaration, "Then began men to call upon the name of the Lord." The historian thus accounts for the progressive degeneration of the religious condition of man, the evil gaining a predominance over the good by its alliance with worldly power and knowledge, and producing the state of things which necessitated the flood. See DELUGE.

(8.) Another motive may be assigned for the introduction of this portion of sacred history. All ancient nations have loved to trace up the invention of the arts to some certain author, and, generally speaking, these authors have been regarded as objects of divine worship. Among the Greeks Apollo was held to be the inventor of music, Vulcan of the working of metals, Triptolemus (see Hygin. 277) of the plough. A similar feeling of curiosity prevailed among the Hebrews; and hence the historian has recorded the names of those to whom the invention of the arts was traditionally assigned, obviating at the same time the dangerous error into which other nations had fallen, and reducing the estimate of their value by the position which their inventors held. See ART; ARTIFICER.

Additional treatises: Stockmann, *De Caino pramonto* (Jen. 1792); Danz, id. (ib. 1681, 1782); Bosenock, *De sacrificiis Caini et Abel* (Lips. 1781); Niemeyer, *Charakt.* lib. 57 sq.; Buttman, *Mythol.* i. 164 sq.; Otho, *Lex. Rab.* p. 109 sq.; Eisenmenger, *Entd. Judenk.* i. 462, 471, 882, 886; Hottinger, *Hist. Orientalis*, p. 26; *Hamb. verm. Biblioth.* ii. 945 sq.; Sack, in the *Brem. u. Verd. Biblioth.* i. iii, 61; Rosenmüller, *Scholäa*, in loc. Gen.; Philo, *Opp.* i. 186; Whately, *Prototypes*, p. 15; Dupin, *Nouv. Bibl.* p. 4; Kitto, *Daily Bible Illust.* in loc.; Evans, *Script. Biog.* ii. 1 sq.; Hunter, *Sac. Biog.* p. 17 sq. See MURDER.

2. (Heb., with the article, *hak-Ka'gin*, *קַיִן*, = "the lance;" but may be derived from *קַיִן*, *ken*, "a nest," possibly in allusion to its position; Sept. *Zakavaiu* v. r. *Zavwaktiu*, by including the name preceding; Vulg. *Accain*.) One of the cities in the low country (*Shefeleh*) of Judah, named with Zanoah and Gibeah (Josh. xv. 56); apparently the modern village *Fukin*, a short distance south-east of Hebron (Van de Velde, *Memoir*, p. 800), now a Mohammedan station, said to be the place where Lot stopped after his flight from Sodom (Robinson, *Researches*, ii. 190).

Ca'nan (Heb. *Ke'nan*, *קַיִן*), derivation ambiguous, as in the case of "Cain" [q. v.], and signifying either *possessor* [so Fürst] or *Jorgeman* [so Gesenius]; Sept. *Kaivav*, but *Kaivav* in Chron. and N. T.; Josephus *Kaivav*, *Ant.* i. 8, 4), the name of one or two men.

1. The fourth antediluvian patriarch, being the (oldest) son of Enos (who was 90 years of age at his birth), B.C. 8846. He was himself 70 years old at the birth of his (first) son Mahalaleel, B.C. 8776, after which he lived 840 years, and died B.C. 8081, aged 910 (Gen. v. 9-14). See LONGEVITY. The rabbinical tradition was that he first introduced idol-worship and astrology—a tradition which the Hellenists transferred to the post-diluvian Cainan. Thus Ephraem-Syrus asserts that the Chaldees in the time of Terah and Abram worshipped a graven god called Cainan; and Gregory Bar-Hebraeus, another Syriac author, also applies it to the son of Arphaxad (Mill, *Vindicia. of Genealogies*, p. 150). The origin of the tradition is not known; but it may probably have been suggested by the meaning of the supposed root in Arabic and the Aramean dialects, just as another signification of the same root seems to have suggested the tradition that the daughters of Cain were the first who made and sang to musical instruments (Gesenius, *Thesaur.* s. v. *קַיִן*). His name is Anglicized—"Kenan" in the Auth. Vers. at 1 Chron. i. 2.—Smith, s. v.

2. The son of Arphaxad, and father of Sala, accord-

ing to Luke iii. 85, 86, and usually called the second Cainan. He is also found in the present copies of the Sept. in the genealogy of Shem, Gen. x. 24; xi. 12 and 13 (where his history is given in full like the rest: "And Arphaxad lived 185 years, and begat Cainan. And Arphaxad lived after he begat Cainan 400 years, and begat sons and daughters. And he died. And Cainan lived 180 years, and begat Salah. And Cainan lived after he begat Salah 880 years, and begat sons and daughters. And he died"), and 1 Chron. i. 18 (though he is omitted in 1 Chron. i. 24), but is nowhere named in the Hebrew text, nor in any of the versions made from it, as the Samaritan, Chaldee, Syriac, Vulgate, etc. As the addition of his generation of 130 years in the series of names is of great chronological importance, and is one of the circumstances which render the Septuagint computation of time longer than the Hebrew, this matter has engaged much attention, and has led to great discussion among chronologers. See CHRONOLOGY. Some have suggested that the Jews purposely excluded the second Cainan from their copies, with the design of rendering the Septuagint and Luke suspected; others that Moses omitted Cainan, being desirous of reckoning ten generations only from Adam to Noah, and from Noah to Abraham. Some suppose that Arphaxad was father of Cainan and Salah—of Salah naturally, and of Cainan legally; while others allege that Cainan and Salah were the same person under two names. It is believed by many, however, that the name of this second Cainan was not originally in the text even of Luke, but is an addition of inadvertent transcribers, who, remarking it in some copies of the Septuagint, added it (Kuiniöl, *ad Luc.* iii. 86). Hales, though, as an advocate of the longer chronology, predisposed to its retention, decides that we are fully warranted to conclude that the second Cainan was not originally in the Hebrew text, at least, nor in the Septuagint and other versions derived from it (*Chronology*, i. 291). Some of the grounds for this conclusion are, 1. That the Hebrew and Samaritan, with all the ancient versions and targums, concur in the omission; 2. That the Septuagint is not consistent with itself; for in the repetition of genealogies in 1 Chron. i. 24, it omits Cainan and agrees with the Hebrew text; 3. That the second Cainan is silently rejected by Josephus, by Philo, by John of Antioch, and by Eusebius; and that, while Origen retained the name itself, he, in his copy of the Septuagint, marked it with an obelisk as an unauthorized reading. It certainly was not contained in any copies of the Bible which Berosus, Eupolemus, Polyhistor, Theophilus of Antioch, Julius Africanus, or even Jerome, had access to. Moreover, it seems that the intrusion of the name even into the Sept. is comparatively modern, since Augustine is the first writer who mentions it as found in the O. T. at all. Demetrius (B.C. 170), quoted by Eusebius (*Prep. Evang.* ix. 21), reckons 1860 years from the birth of Shem to Jacob's going down to Egypt, which seems to include the 130 years of Cainan. But in the great fluctuation of the numbers in the ages of the patriarchs, no reliance can be placed on this argument. Nor have we any certainty that the figures have not been altered in the modern copies of Eusebius, to make them agree with the computation of the altered copies of the Sept. 4. That the numbers indicating the longevity and paternity of this patriarch are evidently borrowed from those immediately adjoining, as is the name itself from that of the antediluvian patriarch. See Heidegger, *Hist. Patriarch.* ii. 8-15; Bochart, *Phaleg*, lib. ii, cap. 18; Mill's *Vindicia. of our Lord's Geneal.* p. 148 sq.; Rus, *Harmon. Evang.* i. 864 sq.; Michaelis, *De Chronolog. Moisis post diluv.* (in the *Commentat. Soc. Gott.* 1768 sq.; translated in the *Am. Bib. Repos.* July, 1841, p. 114 sq.); Vater, *Comment. sum Pent.* i. 174 sq. See GENEALOGY (OF CHRIST).

Cainites, a sect of Gnostics that sprung up about the year 130, and is classed with the Ophites (q. v.)

or Serpentinians. They held that *Sophia* (Wisdom) found means to preserve in every age in this world, which the Demiurge had created, a race bearing within them a spiritual nature similar to her own, and intent upon opposing the tyranny of the Demiurge. The Cainites regarded Cain as the chief of this race. They honored Cain, and the evil characters of Scripture generally, on the ground that, in proportion to the hatred such characters evinced of the laws of the God of this world (the Demiurge), the more worthily did they act as the sons of *Sophia*, whose chief work is to destroy the kingdom of the Demiurge. For the same reason, they honored Korah, Dathan, and Abiram, as well as the inhabitants of Sodom, and Judas Iscariot, whom they regarded as procuring the death of Christ from the purest motives; for he knew that this was the only possible way of effecting the destruction of the Demiurge's kingdom. Hippolytus mentions the Cainites in his *Philosophoumena*, viii, 12.—Neander, *CA. Hist.* i, 448; August. *De Heres.* cap. xviii; Tertull. *De Præscript.* cap. xlvii; Lardner, *Works*, viii, 560.

Caius (of the New Test.). See **GAIUS**.

Caius (emperor of Rome). See **CALIGULA**.

Caius or **Gaius**, a presbyter of the Church of Rome, who flourished about 210, in the time of Zephyrinus and Callistus. Photius calls him *καὶ τὸν ἰσχυρὸν*, a designation the meaning of which is not clear. When at Rome, he held a celebrated disputation with Proclus, the head of a sect of Montanists, which he afterward reduced to writing in the form of dialogues. Eusebius quotes fragments of this work in lib. ii, cap. 25, and also in lib. iii, cap. 28, and lib. vi, cap. 20. Caius also wrote a book called *The Labyrinth*, and another against Artemon, unless the former be the same with the work attributed to Origen, as Cave supposes. Eusebius gives an extract from the *Parvus Labyrinthus* against Artemon and Theodotus, lib. v, cap. 28. Photius also attributes to this Caius a Treatise on the Universe, but both this and the "Labyrinth" are now attributed to Hippolytus. See Bunsen, *Hippolytus and his Times*; also Origen or Hippolytus, in the *Meth. Quarterly Review*, 1851, p. 646; Landon, s. v. See **HIPPOLYTUS**.

Caius or **Gaius**, a Dalmatian, elected bishop of Rome in 288, and is said to have suffered martyrdom under Diocletian, April 21, 296. His epistle was edited, with notes, etc., by Cæs. Beccillus, a priest of the oratory of Urbino, and subjoined to the Acts of his Martyrdom, published at Rome in 1628.—Landon, s. v.

Caius, JOHN (*Keye* or *Key*, Latinized into *Caius*), M.D., was born at Norwich Oct. 6, 1510, and became successively first physician to Edward VI, Mary, and Elizabeth. He died July 20, 1578. He founded the college which bears his name at Cambridge for twenty-three students. He was a good classical scholar, and wrote many treatises on subjects connected with medicine and natural history. He published also a treatise on the antiquity of the University of Cambridge (which he states was founded by *one Cantaber*, 894 years before Christ), and another on the pronunciation of Greek and Latin. His tomb still remains in Caius College, with only this inscription, "Fui Caius."—Landon, s. v.

Cajetan (GAETANO TOMMASO DI VIO), cardinal, surnamed from Gaëta, where he was born, Feb. 20, 1469 (others say July 25, 1470). His proper name was Jacob, but he assumed that of Thomas in honor of Thomas Aquinas. At fifteen he became a Dominican, and in 1508 he was made general of his order. In 1517 Leo X made him cardinal, and also his legate in Germany, the principal object of his mission being to bring back Luther to the obedience of the Holy See before his separation was finally completed. Cajetan fulfilled his mission in a haughty and imperious manner, and nothing came of it. In 1519 he was appointed to the see of Gaëta, after which he was employed in other missions, and died at Rome in 1564. He published a *Ver-*

sion of the O. T. (*Libr. Vet. Test.*) (Lyons, 1689, 5 vols. fol.):—*In Summan Thomæ Aquinatis Comment.*:—*Opuscula* (among which is his treatise on the authority of the pope, in which he gives vent to the extreme views of ultra-montaniam, and which was referred by order of the faculty of Paris):—*Tractatus de comparatione papæ et concilii* (Venice, 1581). His works are collected, and somewhat modified (Lyons, 1689, fol.).—Mosheim, *CA. Hist.* iii, 28 note; Hofer, *Novæ Biog. Générale*, viii, 142; Horne, *Bibliog. Appendix*, pt. i, ch. i, sect. 4.

Cake (represented by several Heb. words; see below). The Hebrews used various sorts of cakes, which was the form usually given to Oriental bread (2 Sam. vi, 19; 1 Kings xvii, 12). See **LOAF**. They were leavened or unleavened. They also offered cakes in the Temple made of wheat or of barley, kneaded sometimes with oil and sometimes with honey. For the purposes of offering, these cakes were salted, but unleavened (Exod. xxix, 2; Lev. ii, 4). In Jer. vii, 18; xlv, 19, we read of the Hebrews kneading their dough "to make cakes to the queen of heaven" [see **ASHTORETH**], which appears to have been, from early times, an idolatrous practice, and was also the custom of the Greeks and Romans. The ancient Egyptians also made offerings of cakes to their deities. In Hosea vii, 8, Ephraim is called "a cake not turned." This figurative expression illustrates the mixture of truth and idolatry (Jews and Gentiles among the Ephraimites) by dough baked on one side only, and, therefore, neither dough nor bread. See **BREAD**.

1. *For secular Use.*—The ordinary (wheaten) bread of the Hebrews certainly had the shape of flat biscuits; and as this has been already sufficiently discussed under the article **BAKE**, we will here consider only those finer sorts, which appear to have been of more artificial manufacture. The terms for these are as follows:

(1.) *Ash-cakes*, אֲשֵׁרֹת, *uggoth*. See **ASH-CAKE**.

(2.) *Pancakes*, baked in oil in the מצות, *marche'sheth*, or *pot* (Lev. ii, 7; see Jarchi in Rosenmüller, ad loc.), perhaps like modern *dough-nuts*. See **FRYING-PAN**. Different are the מצות, *lebithoth* (2 Sam. xiii, 6-18; Sept. *κολληριδες*), cakes kneaded of dough (ver. 8), which, boiled in a deep pan, were emptied out from it tender, but not liquid (ver. 8, 9). The import of this last, from the etymology, is very uncertain (see Rödiger, *De interpret. Arab. libr. hist.* p. 94; Thenius on Sam. xiii, 6; Gesenius, *Theo.* p. 141). It was probably a kind of fancy cake, the making of which appears to have been a rare accomplishment, since Tamar was required to prepare it for Ammon in his pretended illness (2 Sam. xiii, 6).

(3.) *Hole-cakes*, חַלּוֹת, *challoth* (2 Sam. vi, 19), which were mingled with oil (מצות, *see Bähr, Symbol.* ii, 801), and baked in the oven (Lev. ii, 4).

(4.) *Wafers*, רֶקִיקִים, *rekikim* (Exod. xxix, 2; Lev. viii, 26; 1 Chron. xxiii, 29), made very thin (Gr. *λάγανα*), and spread with oil (מצות, *משחיתים*, Sept. *διακεχαρισμένα ἐν ἑλαίῳ*). See **WAFER**.

(5.) *Crackers*, the רֶקִיקִים, *nikkudim*, of 1 Kings xiv, 8, translated "cracknels" in the Authorized Version, an almost obsolete word, denoting a kind of crisp cake, q. d. "crumb-cake." The original would seem, by its etymology (if from רקק, *speckled*, spotted, Gen. xxx, 82 sq.), to denote something spotted or sprinkled over, etc. Buxtorf (*Lex. Talm.* col. 1886) explains thus: "Little circles of bread like the half of an egg, *Teremoth*, c. 5;" and in another place (*Epit. rad. Hebr.* p. 544), "Also the crackers, 1 Kings xiv, 8, commonly called *biscuit*, received their name because they were formed in little round slices as if stamped out, or because they were punctured in some peculiar manner." It is, indeed, not improbable that they may have been

a sort of biscuit, or small and hard-baked cakes, calculated to keep (for a journey or some other purpose) by reason of their excessive hardness (or perhaps being twice baked, as the word *biscuit* implies). Not only are such hard cakes or biscuits still used in the East, but they are, like all biscuits, *punctured* to render them more hard, and sometimes, also, they are sprinkled with seeds, either of which circumstances sufficiently meets the conditions suggested by the etymology of the Hebrew word. The existence of such biscuits is further implied in Josh. ix, 5, 12, where the Gibeonites describe their bread as having become as *hard as biscuit* (not "mouldy," as in the Authorized Version) by reason of the length of their journey. See CRACKNEL.

(6.) *Honey-cakes*, צֶמֶתִּים, *tsappichith' bid-bash'* (Exod. xvi, 31; Talm. רֵיבֵּשְׁתֵּיךָ, *Mishna, Challa*, i, 4), such as are still much relished by the Arabs. See HONEY. Different from these were the *raisin-cakes*, אֲשִׁישֵׁי אֲנָבִים, *ashishey anabim'* (Hos. iii, 1; Sept. *πέμματα μερά σραπίδας*, Authorized Version "flavons of wine"), probably a mass of dried grapes pressed into form; comp. the *lumps* ("cakes") of figs, דֵּבֵלִים, *debelim'*, in 1 Sam. xxv, 18. See FIG. The term אֲשִׁישֵׁי, *ashishek'* (as explained by the Targ. of Ps.-Jonathan at Exod. xvi, 31; also the *Mishna, Nedar.* vi, 10; see Gesen. *Thea.* i, 166 sq.), seems to denote the same kind of cakes as used for refreshment (Cant. ii, 5; 2 Sam. vi, 19; 1 Chron. xvi, 8). See FLAGON. A species of cake prepared with honey is thought (so Jerome) to be referred to in Ezek. xvi, 18 (see Rosenmüller, in loc.).

(7.) The *baked fragments of the offering*, חֲפֵצֵי תִּירֵים מִקֻּחַח, *tuppiney minchath' patim'* (lit. *cooings of the offering of [i. e. in] pieces*, Auth. Ver. "baken pieces of the meat-offering," Lev. vi, 21, i. e. cooked and prepared like the meat-offering, and then broken up into pieces; comp. Lev. ii, 4 sq.; vii, 9), are probably cooked pieces that were again kneaded up with oil and baked (comp. Wansleb in Paulus, *Sammel.* iii, 380; Bähr, *Symbol.* ii, 802). For this purpose use was made of a *frying-pan*, מַחֲבַת, *machabath'* (Lev. ii, 5, etc.), probably a flat iron plate (stew-pan or griddle), beneath which the fire was kindled (comp. Niebuhr, i, 284). See PAN.

(8.) The *thin cakes*, קַצֵּי־חֶמֶת, *kavonim'* ("cakes," Jer. vii, 18; xlv, 19), a sort of wafer used in heathen offerings, are rendered in the Sept. by the Græcized term *χαυίνας*, which is explained by Suidas and other ancient glossarists as signifying barley-cakes steeped in oil; compare the cakes and barley-meal used with sacrifices among the Greeks and Romans (see Smith's *Dict. of Class. Antiq.* s. v. *Sacrificium*). See QUEEN OF HEAVEN.

The only remaining Heb. words relating to the subject, or rendered "cake" in the Auth. Vers., are, קֶצֶב, *qab'*, a *cake*, i. e. whole piece (q. d. "slice") of bread (1 Kings xvii, 12; in Psa. xxxv, 16, in the phrase קֶצֶב־בִּלְבָב, *cake-buffoons, scurrus placenta*, mockers in feasts," i. e. table-jesters) and מַצֵּה, *matzah'* (Josh. v, 11; Judg. vi, 19, 20, 21; 1 Chron. xxiii, 29, etc.), *sweet* or unleavened bread, as usually rendered [see LEAVEN]; and צֶלֶל, *tselul'*, or צֶלֶלִים, *tselilim'* (Judg. vii, 18), a *round cake* of barley-bread. The חֲרִי, *chori'*, of Gen. xl, 16 (where it only occurs in the expression חֲרֵי חֲרִי, Sept. *καὶ χονδράων*, Vulg. *conistra farina*, Auth. Vers. "white baskets," marg. "baskets full of holes"), may signify either *white bread*, as made of fine flour (in the *Mishna, Edaioth*, iii, 10, חֲרִי is a species of bread or cake like the Arab. *chumawry*, white bread or flour), or it may refer to some peculiarity of the baskets merely. See BASKET. In the *Mishna, Challa*, xi, 4 sq., many other kinds of cake are referred

to, but the import of the words there employed is very uncertain. On the Greek cakes, see especially Athen. xiv, 644 sq. See generally Rau, *Diss. de re cibari Hebræor.* (Tr. ad Rh. 1769).—Winer, i, 686. See Foon.

2. *As sacrificial Offerings*.—The second chapter of Leviticus gives a sort of list of the different kinds of bread and cakes in use among the ancient Israelites, for the purpose of distinguishing the kinds which were from those which were not suitable for offerings. Of such as were fit for offerings, we find,

(1.) *Bread baked in ovens* (Lev. ii, 4); but this is limited to two sorts, which appear to be, first, the bread baked inside the vessels of stone, metal, or earthenware, as was customary. In this case the oven is half filled with small smooth pebbles, upon which, when heated and the fuel withdrawn, the dough is laid. Bread prepared in this mode is necessarily full of indentations or holes, from the pebbles on which it is baked. Second, the bread prepared by dropping with the hollow of the hand a thin layer of the almost liquid dough upon the outside of the same oven, and which, being baked dry the moment it touches the heated surface, forms a thin, wafer-like bread or biscuit. The first of these Moees appears to distinguish by the characteristic epithet of חֲלָלוֹת, *challoth'* (see above), *perforated, or full of holes* (Exod. xxix, 2; Lev. ii, 4; vii, 12; Num. vi, 15, etc.), and the other by the name of רֵקִיקִים, *relakim'*, *thin cakes*, being, if correctly identified, by much the thinnest of any bread used in the East. A cake of the former was offered as the first of the dough (Lev. vii, 26), and is mentioned in 2 Sam. vi, 19, with the addition of "bread"—*perforated bread*. Both sorts, when used for offerings, were to be unleavened (perhaps to secure their being prepared for the special purpose); and the first sort, namely, that which appears to have been baked inside the oven, was to be mixed up with oil, while the other (that baked outside the oven), which, from its thinness, could not possibly be thus treated, was to be only smeared with oil. The fresh olive oil, which was to be used for this purpose, imparts to the bread something of the flavor of butter, which last is usually of very indifferent quality in Eastern countries.

(2.) *Bread baked in a pan*—1st, that which, as is still usual, is baked in, or rather on, the *tajen*. This also, as an offering, was to be unleavened and mixed with oil. 2d. This, according to Lev. ii, 6, could be broken into pieces, and oil poured over it, forming a distinct kind of bread and offering. And, in fact, the thin biscuits baked on the *tajen*, as well as the other kinds of bread, thus broken up and remade into a kind of dough, form a kind of food or pastry in which the Orientals take much delight, and which makes a standing dish among the pastoral tribes. The ash-cake answering to the Hebrew אֻגָּה, *uggah'*, is the most frequently employed for this purpose. When it is baked, it is broken up into crumbs and re-kneaded with water, to which is added, in the course of the operation, butter, oil, vinegar, or honey. Having thus again reduced it to a tough dough, the mass is broken into pieces, which are baked in smaller cakes and eaten as a dainty. The preparation for the Mosaic offering was more simple, but it serves to indicate the existence of such preparations among the ancient Israelites.

(3.) *Bread baked upon the hearth*—that is to say, baked upon the hearth-stone, or plate covering the fire-pit, which frequently answers the purpose of an oven. This also was to be mixed with oil (Lev. ii, 7).

As these various kinds of baked bread were allowed as offerings, there is no question that they were the best modes of preparing bread known to the Hebrews in the time of Moses; and as all the ingredients were such as Palestine abundantly produced, they were such offerings as even the poorest might without much difficulty procure.—Kitto, s. v. Bread. See SHEW-BREAD.

Ca'lah (Heb. *Ke'lach*, קַלַח, *עִירוֹנוֹס* old age, as in Job v, 26; in pause *Ka'lach*, קַלַח; Sept. *Καλάχ*, Vulg. *Chale*), one of the most ancient cities of Assyria, whose foundation is ascribed to Asshur or Nimrod (Gen. x, 11). The place has been thought identical with the *Chalacé* (קַלַח, Sept. 'Αλαί) named elsewhere [see **HALAH**] (2 Kings xvii, 6; xviii, 11; 1 Chron. v, 26); but, on monumental evidence, the Rawlinsons (*Herod.* i, 368) regard the site of Calah as marked by the *Nimrud* ruins, which have furnished so large a proportion of the Assyrian antiquities. The Talmud (*Yoma*, x) locates it on the Euphrates, near Borsippa (בֹּרְסִיפָא). If at Nimrud, Calah must be considered to have been at one time (about B.C. 980-720) the capital of the empire. It was the residence of the warlike Sardanapalus and his successors down to the time of Sargon, who built a new capital, which he called by his own name, on the site occupied by the modern *Khorabad*. This place still continued under the later kings to be a town of importance, and was especially favored by Esarhaddon, who built there one of the grandest of the Assyrian palaces. In later times Calah gave name to one of the chief districts of the country, which appears as *Calacimé* (Καλακινή, Ptolem. vi, 1, 2), or *Calachéné* (Καλαχηνή, Strabo, xvi, p. 530, 736), in the geographers. Layard (*Nineveh and its Remains*, ii, 55) suggests that it may possibly be extant in the very extensive ruins called *Kaleh* Shergat, on the west side of the Tigris, above its junction with the Lesser Zab. But see **RESEN**. Less probable is the identification with *Chankam*, the former summer residence of the caliphs in Arabia or Babylonian Irak, according to Abulfeda, five days' journey north of Bagdad (in Anville, 63½° long., 84½° lat.), which, according to Assemani (*Bibl. Or.* III, ii, 418 sq., 753), is also called *Chalcha* (comp. Michaelis, *Suppl.* p. 767; Rosenmüller, *Akerth.* I, ii, 96). Ephraem Syrus (in loc. Gen.) understands the old Mesopotamian *Chetro* on the Tigris (Rosenmüller, *ib.* p. 120; but see Michaelis, *Spicileg.* I, 245 sq.). As it would seem to have been at some distance from Ninevah, the city of Resen lying between them, most earlier writers concur in placing it on the Great Zab (the ancient Lyous), not far from its junction with the Tigris, and Resen is placed higher up on the same river, so as to be between it and Ninevah (Bochart, *Phaleg*, iv, 22). See **ASSYRIA**.

Calamol'alus (Καλαμώαλος, Vulg. *Cliomus*), given (1 Esdr. v, 22) as the name of a place whose "sons" were restored after the exile; apparently a corrupt agglomeration of the names **ELAM**, **HARIM**, **LOD**, and **HADID** in the genuine text (Ezra ii, 31, 32).

Calámon. See **STACAMINA**.

Cal'amus occurs in three passages of the Auth. Vers. for the Heb. קַמֶח, *kameh'* (Sept. *κάλαμος*, elsewhere "reed"): Exod. xxx, 23, among the ingredients of the holy anointing oil; Cant. iv, 14, in an enumeration of sweet scents; and Ezra xxvii, 19, among the articles brought to the markets of Tyre. The term designates the marsh and river reed generally [see **REED**]; but in the places just referred to it appears to signify the *sweet flag* (κάλαμος ἄρωματικός, Dioscor. i, 17), an Oriental plant (*calamus odoratus*, Plin. xii, 12, 48), of which the Linnæan name is *Acorus calamus*. No doubt the same plant is intended in Isa. xliii, 24; Jer. vi, 20, where the Auth. Vers. has *sweet cane*. In the latter text the Heb. is קַמֶח יִשְׂרָאֵל, *kameh' hat-tob'* (i. e. *good cane*), and in Exod. xxx, 28, קַמֶח יִשְׂרָאֵל, *kameh' do'sem* (i. e. *odoriferous cane*). "A scented cane is said to have been found in a valley of Mount Lebanon (Polyb. v, 46; Strab. xvi, 4). The plant has a reed-like stem, which is exceedingly fragrant, like the leaves, especially when bruised. It is of a tawny color, much jointed, breaking into splinters, and having the hollow stem filled with pith like

a spider's web" (Kalisch on Exod. xxx, 28.) The calamus of Scripture is probably the reed by that name sometimes found in Europe, but usually in Asia (Theophrast. *Plant.* ix, 7; Pliny, xii, 12), and especially in India and Arabia (Diod. Sic. ii, 49; Pliny, xii, 48). It grows in moist places in Egypt and Judæa, and in several parts of Syria, bearing

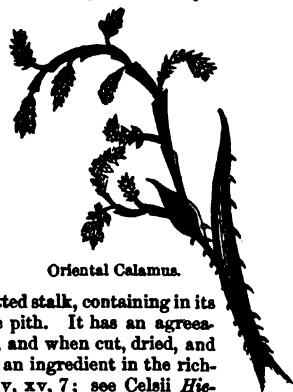

Oriental Calamus.

from the root a knotted stalk, containing in its cavity a soft white pith. It has an agreeable aromatic smell, and when cut, dried, and powdered, it forms an ingredient in the richest perfumes (Pliny, xv, 7; see Celsii *Hierob.* ii, 826 sq.). The plant from which the "calamus aromaticus" of modern shops is obtained appears to be a different species (*Penny Cyclopædia*, s. v. **ACORUS**). See **CANE**.

Calamus sacer (also called *pugillarior* or *fistula*), a tube made of gold or silver, with a larger orifice at one end than at the other, through which the consecrated wine was drawn into the mouth, the large end of the tube being inserted into the chalice. See **CHALICE**.

Calamy, Edmund, an eminent English divine, was born in London A.D. 1600, and took his B.A. degree at Pembroke Hall, Cambridge, in 1619. After spending some years as chaplain to the bishop of Ely, in 1626 he was made a lecturer at Bury St. Edmund's, where he continued until the publication of bishop Wren's "Articles," and the enforcement of the order for the reading of the "Book of Sports," compelled him to protest, and to leave the diocese. He then received the living of Rochford, but in 1639, having avowed himself a Presbyterian, he was made lecturer of St. Mary's, Aldermanbury, in London, which office he filled for twenty years. In the ecclesiastical controversies of the times he bore a prominent part. He joined with Marshall, Young, Newcome, and Spurstow in writing, under the title of *Smectymnus*, a reply to bishop Hall's "Divine Right of Episcopacy." As a preacher Mr. Calamy was greatly admired, and listened to by persons of the first distinction during the twenty years that he officiated in St. Mary's. His celebrity was so well established by his writings, as well as by the distinguished station which he occupied among the ministers in the metropolis, that he was one of the divines appointed by the House of Lords in 1641 to devise a plan for reconciling the differences which then divided the Church in regard to ecclesiastical discipline. This led to the Savoy Conference (q. v.), at which he appeared in support of some alterations in the Liturgy, and replied to the reasons urged against them by the Episcopal divines. As a member of the Westminster Assembly (q. v.), he earnestly opposed the execution of king Charles, and promoted the restoration of his son, who made him one of his chaplains, and offered him the see of Lichfield and Coventry, which he refused. When the Act of Uniformity was passed he resigned his preferment, but refused, like many others, to gather a congregation, preferring regularly to attend the church in which he had so long officiated. He died Oct. 29, 1668, of a nervous disorder occasioned by the sight of the misery caused by the fire of London. He published *The Godly Man's Ark*, *Sermons on Psal. cxix*, 72 (Lond. 1698, 17th ed. 12mo); *The Noble-man's Pattern* (Lond. 1648, 4to), and many single sermons, etc.—Jones, *Christ. Biog.* s. v.

Calamy, Edmund, D.D., grandson of the preceding, was born in London April 5, 1671. At the

age of seventeen he went to the University of Utrecht, where he was placed under the tuition of the distinguished professors De Vries and Grævius. In 1691, when Principal Carstairs was sent to Holland in quest of a gentleman to fill a professor's chair in the University of Edinburgh, he applied to Calamy, and pressed him to accept the situation; but he declined the honor, though soon afterward he returned to England, for the purpose of pursuing his studies in the Bodleian Library. In 1700 he began to preach among the Non-conformists, and in 1708 he took charge of a congregation in Westminster, which he held for many years. In 1708 he arranged for the press *Baxter's Life and Times*, which publication gave rise to a dispute between Calamy and Hoadley. In 1709 he was made D.D. by the universities of Edinburgh, Glasgow, and Aberdeen. After a laborious life, divided between preaching and writing, he died, June 3, 1732. Among his works are *Discourses on Inspiration* (Lond. 1710, 8vo);—*Sermons on the Trinity* (Lond. 1722, 8vo);—*Defence of moderate Non-conformity* (Lond. 1708-6, 3 vols. 8vo);—*The Non-conformist's Memorial* (Lond. 1721, 2 vols. 8vo);—*History of his Life and Times*, edited by Rutt (Lond. 1829, 2 vols. 8vo);—Jones, *Christ. Biog.* s. v.

CALAS, JEAN, an unfortunate merchant of Toulouse, of the Protestant religion. His son, Marc Antoine, hung himself in a fit of melancholy Oct. 13, 1761. The father was seized as guilty of the murder, on the ground that his son intended to embrace Romanism the next day. No proof could be offered against him, but the fanatical passion of the mob was roused. The corpse was honored as that of a martyr. "The clergy exerted all their influence to confirm the populace in their delusion. At Toulouse the White Penitents celebrated with great solemnity the funeral of the young man, and the Dominican monks erected a scaffold and placed upon it a skeleton, holding in one hand a wreath of palms, and in the other an abjuration of Protestantism. The family of Calas was, in consequence of the popular excitement, brought to trial for the murder, and several deluded and (most probably) some bribed witnesses appeared against them. A Catholic servant-maid, and the young man Lavaysse, were also implicated in the accusation. Calas, in his defence, insisted on his uniform kindness to all his children; reminded the court that he had not only allowed another of his sons to become a Catholic, but had also paid an annual sum for his maintenance since his conversion. He also argued from his own infirmity that he could not have prevailed over a strong young man, and referred to the well-known melancholy moods of the deceased as likely to lead to suicide; and, lastly, he pointed out the improbability that the Catholic servant-maid would assist in such a murder. But all his arguments proved unavailing, and the Parliament of Toulouse sentenced the wretched man—by a majority of eight against five—to torture and death on the wheel! With great firmness, and protestations of his innocence to the last, the old man died on the wheel, March 9, 1762. His property was confiscated. His youngest son was banished for life from France, but was captured by the monks, and compelled to abjure Protestantism. The daughters were sent to a convent" (Chambers, s. v.). The family of the unhappy man retired to Geneva, and Voltaire subsequently undertook to defend his memory. He succeeded in drawing public attention toward the circumstances of the case, and a revision of the trial was granted. Fifty judges once more examined the facts, and on March 9, 1765, the Parliament of Paris declared Calas altogether innocent. Louis XV ordered the property of Calas to be restored to his family, and made to the latter a present of 30,000 livres. The investigation at last led to the toleration edict of Louis XVI in 1787.—Bungener, *Priest and Huguenot*, vol. ii; Coquerel, *Histoire des Églises du Désert* (2 vols. Paris, 1841); Haag, *La France Protestante*, iii, 96; Coquerel, *Jean Calas et sa famille* (Paris, 1858, 12mo).

Calasanza, GIUSEPPE (*Josephus a matre Dea*), founder of the order of the *Piarists* (q. v.), was born in Aragon in 1556. He entered holy orders in 1562, and went to Rome, where he obtained the protection of Clement VIII, Paul V, and Gregory XV, the latter of whom, after the new order had been founded by Calasanza, named him general of it in 1622. He died in 1648, and was canonized in 1767. He is commemorated on August 27.—Fehr, *Geschichte d. Mönchsorden*, ii, 51.

Calasio, MARIO DI, named from a village of that name in the Abruzzo, where he was born in 1550. He became a Franciscan, and devoted himself to Hebrew, in which he soon became so great a proficient that Pope Paul V made him D.D. and professor of Hebrew at Rome. He is best known by his *Hebrew Concordance*, which occupied him during forty years, even with the aid of other learned men. He was about to commit this work to the press, when he died, in 1620. It appeared under the title *Concordantia Sacrorum Bibliorum Hebraica cum consentientis ling. Arab. et Syr.* (Rome, 1621, 4 vols. fol.). Another edition was published by Romaine at London in 1747, but it is not considered so accurate as that of 1621. • He is said to have died chanting the Psalms in Hebrew.—*Biog. Univ.* vi, 504.

Calatrava, a military order of Spain, named from the town of Calatrava, in New Castile. It had its origin in the following circumstances: When Alphonso, the father of Sanchez III, had taken the town of Calatrava, in 1147, from the Moors, he gave it to the Templars to defend; but when it was spread abroad in 1158 that the Arabs were about to attempt the recapture of the place, the Templars resigned it again to Sanchez, who thereupon presented it to Raymond, abbot of the Cistercian monastery of St. Mary. The Arabs, after all, did not attempt the place; but many of the warriors who had been drawn together for its defence (as well as many of the lay brethren of the convent) entered the Cistercian order, but under a habit more fit for military exercises than for those of monks. They were designated as the order of Calatrava. It was approved by Pope Alexander 1164, and confirmed by Gregory VIII 1187. The knights at first wore a white scapulary and hood, but in 1397 the Anti-pope Benedict XIII permitted them a secular dress, distinguished by a red cross *fleur-de-lisée*. In 1486, Ferdinand and Isabella obtained a bull from Pope Innocentius VIII, which reserved the nomination of the grand master to the pope. Adrian VI, however, annexed the grand mastership of this order to the crown of Spain. The knights made a vow of obedience, poverty, and conjugal chastity (for they were permitted to marry once), and were bound to maintain the immaculate conception of the Blessed Virgin. As a monastic order the institution has ceased to exist, but there are now said to be nearly eighty commanderies and priories in Spain, generally given as rewards of merit



Red Cross of Calatrava.



Nun and Knight of Calatrava, in public dress.

to political favorites. Since 1219 the order had also nuns, who had to prove, before being admitted, their descent from noble houses. They wore the dress of the Cistercian nuns, and their principal monastery was at Almagro. They are now likewise secularized.—*Hel-yot, Ordres Relig.* vol. i; Landon, *Ecol. Dict.* s. v.

Cal'col (1 Chron. ii, 6). See CHALCOL.

Calcutta, the capital of Bengal, and an episcopal see of the Church of England, on the Hoogly. The bishopric was erected in 1814, and the bishop is metropolitan of India. The incumbents have been, 1. Thomas Fanshaw Middleton, May 8, 1814; 2. Reginald Heber, June 1, 1823; 3. John T. James, June 4, 1827; 4. J. Matthias Turner, May 17, 1829; 5. Daniel Wilson, April 29, 1832, died 1858, who commenced the building of a cathedral church, and the foundation of a chapter; 6. George Edward Lynch Cotton, D.D., consecrated 1858; 7. Robert Milman, February 2, 1867. Calcutta has also been the centre of an important system of Protestant missions, both English and American. See INDIA.

Calderwood, DAVID, a Scotch divine, was born in 1575, and in 1604 became minister of the parish of Creading. When James I in 1617 sought to bring the Scottish Church into conformity with the Church of England, Calderwood was strenuous in opposition. Persecution and threats having failed to shake Calderwood, he was imprisoned, and afterward banished. He retired to Holland, where he published *Altare Damascenense seu ecclesie Anglicane politia*, etc. (L. Bat. 1623, best ed. 1708, 4to), in which he enters into a full examination of the principles of the Church of England, its government, ceremonies, and connection with the state. The work made a great impression at the time, and was translated into English under the title of *The Altar of Damascus, or the Pattern of the English Hierarchy and Church obruded upon the Church of Scotland* (1621, 12mo). A report having been spread that Calderwood was dead, a man named Patrick Scot published a pretended recantation, with the title "Calderwood's Recantation, directed to such in Scotland as refuse Conformity to the Ordinances of the Church" (London, 1622). Calderwood, in the mean time, had returned secretly to Scotland, where he lived some years in concealment. He collected the materials for a *History of the Kirk of Scotland*, which he left in MS., and which has been published by the Woodrow Society (Edinb. 1842-9, 8 vols. 8vo). From the materials of this work Calderwood wrote his *True History of the Church of Scotland from the Beginning of the Reformation unto the End of the Reign of James VI* (1678, fol.). He died about 1650.—*English Cyclopædia*.

Caldron, prop. a large cooking vessel, is the rendering in certain passages of the Auth. Vers. for the following words: 1. אַגְמוֹן, *agmon*' (Job xli, 20 [12]), a heated *kettle*, others a burning *reed* ("rush" elsewhere); 2. דָּד, *dad* (2 Chron. xxxv, 13; "pot," Job xli, 20 [12]; Psa. lxxxi, 6; "kettle," 1 Sam. ii, 14), a large *boiler* (also a "basket"); 3. כִּי, *sir* (Jer. lii, 18, 19; Ezek. xi, 8, 7, 11, elsewhere "pot"), the most general term for a kettle or basin (also a "thorn"); 4. כַּלְלָאֵךְ, *kallack'ath* (1 Sam. ii, 14; Mic. iii, 8), a pan

or pot (so called from *pouring*); 5. λήθηρ (2 Macc. vii, 8), a *kettle*, in this case a large caldron for torture. Metallic vessels of this description have been obtained from the ruins of Egypt, and still more lately two copper caldrons were discovered by Mr. Layard among the excavations at Nimroud (*Nin. and Bab.* p. 149 sq.), about 2½ feet in diameter, and 3 feet deep, resting upon a stand of brick work, with their mouths closed by large tiles, and containing a variety of smaller bronze objects. See Pot.

Caldwell, David, D.D., a Presbyterian minister, was born in Lancaster county, Pa., March 22, 1725, graduated at Princeton in 1761, and was licensed to preach by the New Brunswick Presbytery in 1768. Being ordained in 1765, he became pastor of the congregations of Buffalo and Alamance, N. C., in 1768. In 1776 he was a member of the Convention which formed the State Constitution, and some years later he declined the offer of the presidency of the University of North Carolina, by which institution he was made D.D. in 1810. He died in 1824, in his 100th year.—Sprague, *Annals*, iii, 268.

Caldwell, James, a Presbyterian minister, was born in Charlotte county, Va., 1784, graduated at Princeton in 1759, and in 1761 was ordained pastor of the Presbyterian church of Elizabethtown, N. J. At the Revolution he entered with spirit into the controversy, and was soon branded as a rebel; and on the formation of the Jersey brigade, he was at once selected as its chaplain. Throughout the war he suffered severely; toward the close of it, his church was burnt and his wife murdered by the enemy. The people reposed great confidence in him, and his labors, counsels, and exhortations were of great assistance to the cause he had espoused. This honored patriot was killed in 1781, at Elizabethport, by a drunken soldier named Morgan, who was tried, convicted, and hung upon the charge of murder. Caldwell was a man of unwearied activity and of wonderful powers of endurance. As a preacher he was uncommonly eloquent and pathetic.—Sprague, *Annals*, iii, 222.

Caldwell, Joseph, D.D., a Presbyterian minister, the author of a *System of Geometry* and a *Treatise of Plane Trigonometry*, was born in New Jersey A.D. 1778, graduated at Princeton 1791, and became Professor of Mathematics at the University of North Carolina in 1796, in which same year he was licensed as a Presbyterian minister. From 1804 till his death, in 1835, with an intermission of five years, he was President of the University, and to his exertions it owes the respectable position which it now occupies.—Sprague, *Annals*, iv, 173.

Caldwell, Merritt, A.M., Professor of Metaphysics, was born in Hebron, Me., Nov. 29, 1806. His early education, both religious and academical, was very carefully conducted, and he graduated with honor at Bowdoin College in 1828. In the same year he became principal of the Maine Wesleyan Seminary, Readfield. In 1834 he was elected Professor of Mathematics and Vice-president of Dickinson College, Pa. In 1837 he was transferred to the chair of Metaphysics and English Literature, which he occupied during the rest of his life. He soon became known as a strong thinker and excellent writer by his elaborate contributions to the *Methodist Quarterly Review*. Nor did his devotion to literature prevent him from taking an interest in the moral questions of the times; and in the cause of temperance especially his labors were abundant and even excessive. In 1846 he visited England as a delegate to the "World's Convention," which formed the "Evangelical Alliance," and took an active part in its proceedings. His health, which had previously been impaired, was apparently improved by his European tour, but in 1847 it failed again, and he died June 6, 1848. Professor Caldwell was a man of uncommonly firm and masculine character. As a pro-

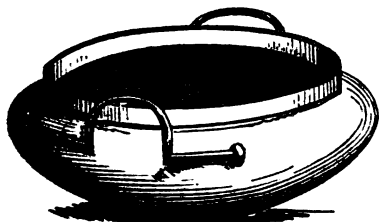

Bronze Caldron. From the Egyptian Remains in the British Museum.

fessor and college officer he had few superiors; as a writer, he was always clear, logical, and forcible. Many of his contributions to the periodical press were of rare excellence. He also published *Manual of Elocution, including Voice and Gesture* (Phila. 1848, 12mo, often reprinted), perhaps the best hand-book of the subject extant:—*Philosophy of Christian Perfection* (Phila. 1847, 18mo), “a model of clear thinking and forcible expression:”—*Christianity tested by eminent Men* (N. Y. 1852, 18mo):—*The Doctrine of the English Verb* (1887, 12mo).—*Methodist Quarterly Review*, 1852, p. 574.

Caldwell, Zenas, brother of Merritt, was born in Hebron, Oxford county, Me., on the 31st of March, 1800, graduated at Bowdoin College in 1824, and soon after leaving college took charge of the Academy of Hallowell. In 1825 he was licensed as a local preacher, and for most of the time of his connection with the Hallowell Academy he supplied the Methodist congregation in Winthrop. In the same year he was unanimously elected principal of the new Methodist Seminary at Kent's Hill, Readfield, Me., and proved himself abundantly adequate to any service that devolved upon him. But his whole work was to be performed within six months; his lungs became seriously affected, and he died triumphantly on Dec. 26, 1826. In 1855 a small duodecimo volume by the Rev. S. M. Vail, D.D., was published, containing a memoir and several of his productions, in prose and poetry.—*Sprague, Annals*, vii, 699 sq.

Ca'leb (Heb. *Kaleb'*, כִּלְבֵּי, appar. for כִּלְבֵּי, a dog), the name of two or three men. See also CAL-EB-EPH-RATAH; NEGBE-CAL-EB.

1. (Sept. Χαλίβ.) The last-named of the three sons of Hezron, Judah's grandson (1 Chron. ii, 9, where he is called CHELUBAI). His three sons by his first wife, Azubah or Jerioth (q. v.), are enumerated (ver. 18); he had also another son, Hur, by a later wife, Ephrath (ver. 19; perhaps only the oldest of several, ver. 50); besides whom another (his “first-born”) is named (ver. 42, by what wife is uncertain), in addition to several by his concubines Ephah and Maachah (ver. 46, 48). B.C. post 1856. The text is possibly corrupt, however, in some of these distinctions.

2. (Sept. Χαλίβ.) A “son of Hur, the first-born of Ephrath” above named (and therefore the grandson of the preceding), according to 1 Chron. ii, 60, where his sons are enumerated. B.C. ante 1658. Some, however, have identified him with the foregoing, supposing a corruption in the text.

3. (Sept. Χαλίβ, but Χαλίβ in 1 Chron. ii, 49; Eclus. xlii, 9; 1 Macc. ii, 56; v. r. Χαλούβ in 1 Sam. xxx, 14; Josephus Χαλίβος, Ant. iii, 14, 4, etc.) Usually called “the son of Jephunneh” (Num. xiii, 6, and elsewhere [see JEPHUNNEH]), sometimes with the addition “the Kenezite” (Num. xxxii, 12; Josh. xiv, 6, 14), from which some have hastily inferred that he may have been a foreigner, and only proselyted to Judaism. See KENAZ. Caleb is first mentioned in the list of the rulers or princes (N'שָׁרִים), called in the next verse (N'שָׁרִים) “heads,” one from each tribe, who were sent to search the land of Canaan in the second year of the Exode (B.C. 1657), where it may be noted that these officers are all different from those named in Num. i, ii, vii, x, as at that time phylarchs of the tribes. Caleb was one of these family chieftains in the tribe of Judah, perhaps as chief of the family of the Hezronites, at the same time that Nahshon, the son of Amminadab, was prince of the whole tribe. He and Oshera or Joshua, the son of Nun, were the only two of the whole number who, on their return from Canaan to Kadesh-Barnea, encouraged the people to enter in boldly to the land, and take possession of it, for which act of faithfulness they narrowly escaped stoning at the hands of the infuriated people. In the plague that ensued, while the other ten spies perished, Caleb and Joshua alone were spared. Moreover, while it was

announced to the congregation by Moses that, for this rebellious murmuring, all that had been numbered from twenty years old and upward, except Joshua and Caleb, should perish in the wilderness, a special promise was made to the latter that he should survive to enter into the land which he had trodden upon, and that his seed should possess it. Accordingly, forty-five years afterward (B.C. 1612), when some progress had been made in the conquest of the land, Caleb came to Joshua and reminded him of what had happened at Kadesh, and of the promise which Moses made to him with an oath. He added that though he was now eighty-five years old (hence he was born B.C. 1698), he was as strong as in the day when Moses sent him to spy out the land, and he claimed possession of the land of the Anakim, Kirjath-Arba, or Hebron, and the neighboring hill-country (Josh. xiv). This was immediately granted to him, and the following chapter relates that he took possession of Hebron, driving out the three sons of Anak; that he offered Achsah, his daughter, in marriage (comp. 1 Sam. xvii, 25; Hygin. Fab. 67) to whoever would take Kirjath-Sepher, i. e. Debir; and that when Othniel, his younger brother, had performed the feat, he not only gave him his daughter to wife, but with her the upper and nether springs of water which she asked for. After this we hear no more of Caleb, nor is the time of his death recorded. But we learn from Josh. xxi, 18, that, in the distribution of cities out of the different tribes for the priests and Levites to dwell in, Hebron fell to the priests, the children of Aaron, of the family of the Kohathites, and was also a city of refuge, while the surrounding territory continued to be the possession of Caleb, at least as late as the time of David (1 Sam. xxv, 8), being still called by his name (1 Sam. xxx, 14). His descendants are called *Calebites* (כִּלְבֵּי, *Kalibbi'*, 1 Sam. xxv, 8; Sept. translates as if a paronomasia were intended, *κνωτός*, Auth. Vera. “house of Caleb”). His name seems to be inserted in 1 Chron. ii, 49, by way of distinction from the others in the same list. See Ewald, *Isr. Gesch.* ii, 288 sq.

Ca'leb-eph'ratah, a name occurring only in the present text of 1 Chron. ii, 24, as that of a place where Hezron died (חֵזְרוֹן בְּכִלְבֵּי, *be-Kaleb' Ephra' thah*, in *Caleb to Ephrath*). But no such place is elsewhere referred to, and the composition of the name is a most ungrammatical one. Again, neither Hezron or his son could well have given any name to a place in Egypt, the land of their bondage, nor did Hezron probably die, or his son live, elsewhere than in Egypt. The present text therefore seems to be corrupt, and the reading which the Sept. and Vulg. suggest (ἵδεν Χαλίβ τις Ἐφραθά, *ingressus est Caleb ad Ephraika*) is probably the true one, viz., חֵזְרוֹן בְּכִלְבֵּי, meaning either “Caleb came to Ephrath,” i. e. Bethlehem-Ephrath, or, still better, “Caleb came in unto Ephrah.” The whole information given seems to be that Hezron had two wives, the first, whose name is not given, the mother of Jerahmeel, Ram, and Caleb or Chelubai; the second, Abiah, the daughter of Machir, whom he married when sixty years old, and who bare him Segub and Ashur. Also that Caleb had two wives, Azubah, the first, apparently the same as Jerioth, and Ephrah, the second, the mother of Hur; and that this second marriage of Caleb did not take place till after Hezron's death.—Smith, s. v. See NEGBE-CAL-EB.

Calendar, JEWISH. I. *Hebrew Lunar Calendar of Feasts and Fasts.*—The year of the Hebrews is composed of twelve (and occasionally of thirteen) lunar months, of thirty and twenty-nine days alternately. The year begins in autumn as to the civil year, and in the spring as to the sacred year. The Jews had calendars anciently wherein were noted all the feasts, all the fasts, and all the days on which they celebrated the memory of any great event that had happened to

the nation (Zech. viii, 19; Esth. viii, 6, in Græc.). These ancient calendars are sometimes quoted in the Talmud (Mishna, *Taanith*, 8), but the rabbins acknowledge that they are not now in being (see Maimonides and Bartenora, in loc.). Those that we have now, whether printed or in manuscript, are not very ancient (see Genebrar. *Bibliot. Rabbinc.* p. 819; Buxtorf, *Levit. Talmud.* p. 1046; Bartolocci, *Bibl. Rabbinc.* ii, 550; Lamy's *Introduction to the Scriptures*; and Plantav. *Iacog. Rabbim.* ad fin.). That which passes for the oldest is *Megillath Taanith*, "the volume of affliction," which contains the days of feasting and fasting heretofore in use among the Jews, which are not new observed, nor are they in the common calendars. We here insert the chief historical events, taken as well from this volume, *Taanith*, as from other calendars. The Jewish months, however, have been placed one lunation later than the rabbinical comparison of them with the modern or Julian months, in accordance with the conclusions of J. D. Michaelis, in his treatise published by the Royal Soc. of Göttingen. See MONTH. For the details, compare each month in its alphabetical place. See also *Critica Biblica*, vol. iv, and the following formal treatises: Clauder, *De forma anni Mosiaci-prophetica* (Viteb. 1716); Dresde, *Annus Judaicus* (Lips. 1766); Fischer, *De anno Hebræor.* (Viteb. 1710); Felsenstein, *De civit. Judæorum die* (Lips. 1702); Klauising, *De forma anni patriarcharum* (Viteb. 1716); Röschel, *id.* (Viteb. 1692); Lanshansen, *De mense vet. Heb. lunari* (Jen. 1718); Lund, *De mensibus Hebræor.* (Abon. 1694); Nagel, *De Calendario vet. Hebræor.* (Altorf, 1746); Selden, *De anno civit. Hebræor.* (Lond. 1644); Sommel, *De anno Hebræor. eccles. et civ.* (Lund. 1748); Strauch, *De anno Hebræor. ecclesiastico* (Viteb. 1655); Von Gumpach, *Ueber den alt. Jüdisch. Kalender* (Brüssel, 1848). See TIME.

ABIB or NISAN.

The first month of the sacred year, the seventh month of the civil year; it has thirty days, and answers generally to the moon of MARCH and APRIL.

- Day 1.—New moon; a fast for the death of the sons of Aaron (Lev. x, 1, 2).
- 18.—A fast for the death of Miriam, sister of Moses (Num. xx, 1); also in memory of the scarcity of water that happened, after her death, to the children of Israel in the desert of Kadesh (Num. xx, 9).
- On this day every one provided himself a lamb or a kid, preparatory to the following Passover.
- 14.—On the evening of this day they killed the paschal lamb; they began to use unleavened bread, and ceased from all servile labor.
- 15.—The solemnity of the Passover, with its octave; the first day of unleavened bread, a day of rest; they ate none but unleavened bread during eight days.
- After sunset they gathered a sheaf of barley, which they brought into the Temple (*Menachot.* vi, 3). Supplication for the reign of the spring (Geneb.).
- 16.—On the second day of the feast they offered the barley which they had provided the evening before, as the first-fruits of the harvest; after that time it was allowed to put the sickle to the corn.
- The beginning of harvest.
- From this day they began to count fifty days to Pentecost.
- 21.—The octave of the feast of the Passover; the end of unleavened bread. This day is held more solemn than the other days of the octave, yet they did not refrain from manual labor on it.
- 22.—A fast for the death of Joshua (Josh. xxiv, 29).
- 30.—Alternate of the first new moon of the succeeding month.
- The book called *Megillath Taanith* does not notice any particular festival for the month Nisan.

ZIF or IJAR.

The second ecclesiastical, or eighth civil month, contains twenty-nine days; corresponds to the moon of APRIL or MAY.

- Day 1.—New moon.
- 6.—A fast of three days for excesses committed during the feast of the Passover; that is, on the Monday, Thursday, and the Monday following (*Calendar Bartolocci*).
- 7.—The dedication of the Temple, when the Ammonians consecrated it anew, after the persecutions of the Greeks (*Megill. Taanith*, c. 9).
- 10.—A fast for the death of the high-priest Eli, and for the capture of the ark by the Philistines.

- 14.—The second Passover, in favor of those who could not celebrate the first, on the 15th of the foregoing month.
- 23.—A feast for the taking of the city of Gaza by Simon Maccabeus (*Calend. Scallig.*; 1 Macc. xiii, 43, 44); or for the taking and purification of the citadel of Jerusalem by the Maccabees (*Calendar of Sigonius*; 1 Macc. xiii, 49, 53; xvi, 7, 36); a feast for the expulsion of the Caraites out of Jerusalem by the Ammonians or Maccabees (*Meg. Taanith*; comp. TASSUR 23).
- 27.—A feast for the expulsion of the Gallileans, or those who attempted to set up crowns over the gates of their temples and of their houses, and even on the heads of their oxen and asses, and to sing hymns in honor of false gods. The Maccabees drove them out of Judæa and Jerusalem, and appointed this feast to perpetuate the memory of their expulsion (*Megill. Taanith*).
- 28.—A fast for the death of the prophet Samuel (1 Sam. xxv, 1).

SIVAN.

The third sacred, or ninth civil month; thirty days; the moon of MAY or JUNE.

Day 1.—New moon.

- 6.—Pentecost, the fiftieth day after the Passover—called also the Feast of Weeks, because it happened seven weeks after the Passover. We do not find that it had any octave.
- 15, 16.—A feast to celebrate the victory of the Maccabees over the people of Bethsan (1 Macc. v, 53; xii, 40, 41; *Megill. Taanith*).
- 17.—A feast for the taking of Cesarea by the Ammonians, who drove the pagans from thence, and settled the Jews there (*Megill. Taanith*).
- 22.—A fast in memory of the prohibition by Jeroboam, son of Nebat, to his subjects, forbidding them to carry their first-fruits to Jerusalem (1 Kings xii, 27).
- 25.—A fast in commemoration of the death of the rabbins Simeon, son of Gamaliel; Ishmael, son of Elisha; and Chanina, the high-priest's deputy.
- A fast in honor of the solemn judgment pronounced in favor of the Jews by Alexander the Great against the Ishmaelites, who, by virtue of their birthright, maintain a possession of the land of Canaan; against the Canaanites, who claimed the same as being the original possessors; and against the Egyptians, who demanded restitution of the vessels and other things borrowed by the Hebrews when they left Egypt (see *Megillath Taanith*); but the Gemara of Babylon (*Sanhedrim*, c. 11) puts the day of this sentence on Nisan 14 (comp. CHRISLU 21).
- 27.—A fast, because Rabbi Chanina, the son of Thardion, was burnt with the book of the law.
- 30.—Alternate of the first new moon of the following month.

TAMMUZ.

The fourth sacred, tenth civil month; twenty-nine days; moon of JUNE or JULY.

Day 1.—New moon.

- 14.—A feast for the abolition of a pernicious book of the Sadducees and Bethusians, by which they endeavored to subvert the oral law and all the traditions (*Megill. Taanith*).
- 17.—A fast in memory of the tables of the law broken by Moses (Exod. xxxii, 19).
- On this day the city of Jerusalem was taken; the perpetual evening and morning sacrifice was suspended during the siege of Jerusalem by Titus. Epitemon tore the book of the law, and set up an idol in the Temple; it is not said whether this happened under Nebuchadnezzar, Antiochus Epiphanes, or the Romans.

AB.

The fifth sacred, eleventh civil month; thirty days; moon of JULY or AUGUST.

- Day 1.—New moon; a fast for the death of Aaron, the high-priest.
- 5.—A commemoration of the children of Jethuel, of the race of Judah, who, after the return from the captivity, furnished wood to the temple (*Megill. Taanith*).
- 9.—A fast of the fifth month in memory of God's declaration to Moses, on this day, that none of the murmuring Israelites should enter the land of promise (Num. xiv, 29, 31).
- On the same day the Temple was taken and burnt; Solomon's Temple first by the Chaldeans; Herod's Temple afterward by the Romans.
- 18.—A fast, because in the time of Ahab the evening lamp went out.
- 21.—Xylophoria; a feast on which they stored up the necessary wood in the Temple (Selden; see Josephus, *Wars*, II, 17). Scalliger places this festival on the 22d of the next month.
- 24.—A feast in memory of the abolition of a law by the Ammonians, or Maccabees, which had been introduced by the Sadducees, enacting that both sons and daughters should alike inherit the estates of their parents (*Megill. Taanith*).
- 30.—Alternate of the first new moon of the following month.

ELUL.

The sixth sacred, twelfth civil month; twenty-nine days; moon of AUGUST or SEPTEMBER.

Day 1.—New moon.

7.—Dedication of the walls of Jerusalem by Nehemiah (Ezra xii, 27). We read in Neh. vi, 15, that these walls were finished Elul 26; but as there still remained many things to be done to complete this work, the dedication might have been deferred to the 7th of Elul of the year following (*Megill. Taanith*; Seid.).

17.—A fast for the death of the spies who brought an ill report of the land of promise (Num. xiv, 36).

A feast in remembrance of the expulsion of the Romans (rather the Greeks), who would have prevented the Hebrews from marrying, and who dishonored the daughters of Israel. When they intended to use violence toward Judith, the only daughter of Mattathias, he, with the assistance of his sons, overcame them, and delivered his country from their yoke; in commemoration of which deliverance this festival was appointed.

21.—Xylophoria; a feast in which they brought to the Temple the necessary provision of wood for keeping up the fire of the altar of burnt-sacrifice. The calendar of Scaliger places this feast on the 23d (see the 21st of the foregoing month).

22.—A feast in memory of the punishment inflicted on the wicked Israelites, whose insolence could not be otherwise restrained than by putting them to death; for then Judaea was in the possession of the Gentiles. They allowed these wicked Israelites three days to reform; but as they showed no signs of repentance, they were condemned to death (*Megill. Taanith*).

[From the beginning to the end of this month, the cornet is sounded to warn of the approaching new civil year.] See YEAR.

ETHANIM or TISRI.

The seventh sacred, first civil month; thirty days; moon of SEPTEMBER or OCTOBER.

Day 1.—New moon. Beginning of the civil year.

The Feast of Trumpets (Lev. xxiii, 24; Num. xxix, 1, 2).

8.—Fast for the death of Gedaliah (2 Kings xxv, 25; Jer. xli, 3).

The same day, the abolition of written contracts. The wicked kings having forbidden the Israelites to pronounce the name of God, when they were restored to liberty the Amosaeans or Maccabees ordained that the name of God should be written in contracts after this manner: "In such a year of the high-priest N., who is minister of the most high God" etc. The judges to whom these writings were presented decreed they should be satisfied, saying, for example, "On such a day, such a debtor shall pay such a sum, according to his promise, after which thy schedule shall be torn." But it was found that the name of God was taken away out of the writing; and thus the whole became useless and ineffectual; for which reason they abolished all these written contracts, and appointed a festival day in memory of it (*Megill. Taanith*, c. 7).

5.—The death of twenty Israelites. Rabbi Akiba, son of Joseph, dies in prison.

7.—A fast on account of the worshipping the golden calf, and of the sentence God pronounced against Israel in consequence of that crime (Exod. xxxii, 8-3, 34).

10.—A fast of expiation (Lev. xxiii, 19, etc.).

15.—The Feast of Tabernacles, with its octave (Lev. xxiii, 34).

21.—Hosanna-Rabba. The seventh day of the Feast of Tabernacles, or the Feast of Branches.

22.—The octave of the Feast of Tabernacles.

23.—The rejoicing for the law; a solemnity in memory of the covenant that the Lord made with the Hebrews in giving them the law by the mediation of Moses.

On this same day, the dedication of Solomon's Temple (1 Kings viii, 65, 66).

30.—Alternate of the first new moon of the following month.

MARCHESVAN or BUL.

The eighth sacred, second civil month; twenty-nine days; moon of OCTOBER or NOVEMBER.

Day 1.—The new moon, or first day of the month.

6, 7.—A fast, because Nebuchadnezzar put out the eyes of Zedekiah, after he had slain his children before his face (2 Kings xxv, 7; Jer. lii, 10).

19.—A fast on Monday and Tuesday [Thursday?], and the Monday following, to expiate faults committed on occasion of the Feast of Tabernacles (*Calendar*, ed. Bartolocci).

23.—A feast or memorial of the stones of the altar, profaned by the Greeks, which were laid aside in expectation of a prophet who could declare to what use they might be applied (1 Macc. iv, 48; *Megill. Taan.* c. 8).

26.—A feast in memory of some places possessed by the Cushites, which the Israelites recovered at their return from the captivity.

A dispute of Rabbim Jochanan, son of Zachai, against

the Sadducees, who pretended that the loaves of the first-fruits (Lev. xxiii, 17, 18) were not to be offered on the altar, but to be eaten hot (*Megill. Taan.* c. 9).

GHISLEU.

The ninth sacred, third civil month; thirty days; moon of NOVEMBER or DECEMBER.

Day 1.—New moon, or the first day of the month.

3.—A feast in memory of the idols which the Amosaeans threw out of the courts, where the Gentiles had placed them (*Megill. Taanith*).

6.—A fast in memory of the book of Jeremiah, torn and burnt by Jehoiakim (Ager. xxvii, 23).

7.—A feast in memory of the death of Herod the Great, son of Antipater, who was always an enemy to the sages (*Megill. Taan.* c. 11).

21.—The feast of Mount Gerizim. The Jews relate that when their high-priest Simon, with his priests, went out to meet Alexander the Great, the Cuthaeans or Samaritans went also, and desired this prince to give them the Temple of Jerusalem, and to sell them a part of Mount Moriah, which request Alexander granted. But the high-priest of the Jews afterward presenting himself, and Alexander asking him what he desired, Simon entreated him not to suffer the Samaritans to destroy the Temple. The king replied to him that he delivered that people into his hands, and he might do what he pleased with them. Then the high-priest and inhabitants of Jerusalem took the Samaritans, bored a hole through their heels, and, tying them to their horses' tails, dragged them along to Mount Gerizim, which they ploughed and sowed with tares, just as the Samaritan had intended to do to the Temple of Jerusalem. In memory of this event they instituted this festival (comp. SYVAN 25).

24.—Prayers for rain (*Calendar Bartolocci*).

25.—The dedication or renewing of the Temple, profaned by order of Antiochus Epiphaneus, and purified by Judas Maccabeus (1 Macc. iv, 53; 2 Macc. ii, 16; John x, 22). This feast is kept with its octave. Josephus says that in his time it was called the Feast of Lights, perhaps, he says, because this good fortune of restoring the Temple to its ancient use appeared to the Jews as a new day (*Ant.* xii, 11). But the Jewish authors give another reason for the name of lights. They report that when they were employed in cleansing the Temple, after it had been profaned by the Greeks, they found there only one small phial of oil, sealed up by the high-priest, which would hardly suffice to keep in the lamps so much as one night; but God permitted that it should last several days, till they had time to make more, in memory of which the Jews lighted up several lamps in their synagogues and at the doors of their houses. (See Seiden, *De Syned.* lib. iii, cap. 13.) Others affirm (as the *Scholastical History*, also Thomas Aquinas and Cardinal Hugo, on 1 Macc. iv, 52) that the appellation of the Feast of Lights was a memorial of that fire from heaven which inflamed the wood on the altar of burnt-offerings, as related in 2 Macc. i, 22.

Some think this feast of the dedication was instituted in memory of Judith. (See Sigon, *De Republ. Heb.* lib. iii, cap. 13.) But it is doubted whether this ought to be understood of Judith, daughter of Merari, who killed Holofernes, or of another Judith, daughter of Mattathias, and sister of Judas Maccabeus, who slew Nicanor, as they tell us. (See Ganz, *Zemach David*; Millenar, 4, an. 692, et apud Seiden, *De Synedris*, lib. iii, cap. 13, n. 11.) This last Judith is known only in the writings of the rabbins, and is not mentioned either in the Maccabees or in Josephus. But there is great likelihood that the Jews have altered the Greek history of Judith to place it in the time of Judas Maccabeus.

A prayer for rain. Time of sowing begins in Judaea.

30.—Alternate of the new moon of the following month.

TEBETH.

The tenth sacred, fourth civil month; twenty-nine days; moon of DECEMBER or JANUARY.

Day 1.—New moon.

8.—A fast, because of the translation of the law out of Hebrew into Greek. This day and the three following days were overcast by thick darkness.

The fast of the tenth month (*Calendar Bartolocci*).

9.—A fast for which the rabbins assign no reason.

10.—A fast in memory of the siege of Jerusalem by Nebuchadnezzar (2 Kings xxv, 1).

23.—A feast in memory of the exclusion of the Sadducees out of the Sanhedrim, where they had all the power in the time of King Alexander Jannaeus. Rabbi Simon, son of Shatach, found means of excluding them one after another, and of substituting Pharisees (*Megillath Taanith*). Comp. LEAR 23.

SHEBAT.

The eleventh sacred, fifth civil month; thirty days; moon of JANUARY or FEBRUARY.

Day 1.—New moon, or the first day of the month.

- 2.—A rejoicing for the death of King Alexander Jannæus, a great enemy to the Pharisees (*Megill. Taanith*).
- 4 or 5.—A fast in memory of the death of the elders who succeeded Joshua (Judg. ii, 10).
- 15.—The beginning of the year of trees; that is, from hence they begin to count the four years during which trees were judged unclean, from the time of their being planted (Lev. xix, 23-25). Some place the beginning of these four years on the first day of the month.
- 23.—A feast in memory of the death of one called Nicanor, who had ordered the placing images or figures in the Temple, which was forbidden by the law; but he died, and his orders were not executed. The Jews place this under the high-priest Simon the Just. It is not known who this Nicanor was (*Megill. Taanith*, c. 11).
- 25.—A fast for the war of the ten tribes against that of Benjamin (Judg. xx).
- They also call to remembrance the idol of Micah (Judg. xviii).
- 29.—A memorial of the death of Antiochus Epiphanes, an enemy of the Jews (1 Macc. vi, 1; *Megill. Taanith*).
- 30.—Alternate new moon of the next month.

ADAR

The twelfth sacred, sixth civil month; twenty-nine days; most of FEBRUARY or MARCH.

Day 1.—New moon.

- 7.—A fast, because of the death of Moses (Deut. xxxiv, 5).
- 8, 9.—The trumpet sounded by way of thanksgiving for the rain that fell in this month, and to pray for it in future (*Megillath Taanith*).
- A fast in memory of the schism between the schools of Shammai and Hillel (called *Taanith Tsadehim*).
- 12.—A feast in memory of the death of two proselytes, Holiannus and Pipus his brother, whom one Tyrinus or Turianus would have compelled to break the law, in the city of Laodicea; but they chose rather to die than to act contrary to the law (Selden, *De Synedr.* lib. iii, cap. 13, ex *Megill. Taanith*).
- 13.—Esther's fast; probably in memory of that of Eth. iv, 16 (Geneb. and Bartolocci).
- A feast in memory of the death of Nicanor, an enemy of the Jews (1 Macc. vii, 44; 2 Macc. xv, 30, etc.). Some of the Hebrews insist that Nicanor was killed by Judith, sister of Judas Maccabeus.
- 14.—The first Purim, or lesser Feast of Lots (Esth. ix, 21). The Jews in the provinces ceased from the slaughter of their enemies on Nisan 14, and on that day made great rejoicing; but the Jews of Shushan continued the slaughter till the 15th; therefore Mordecai settled the Feast of Lots on the 14th and 15th of this month.
- 15.—The great Feast of Purim or Lots; the second Purim. These three days, the 13th, 14th, and 15th, are commonly called the days of Mordecai, though the feast for the death of Nicanor has no relation either to Esther or to Mordecai.
- The collectors of the half shekel, paid by every Israelite (Exod. xxx, 13), received it on Adar 15 in the cities, and on the 25th in the Temple (Talmud, *Sheraitim*).
- 17.—The deliverance of the sages of Israel, who, flying from the persecution of Alexander Jannæus, king of the Jews, retired into the city of Koslik in Arabia; but, finding themselves in danger of being sacrificed by the Gentiles, the inhabitants of the place, they escaped by night (*Megill. Taanith*).
- 20.—A feast in memory of the rain obtained from God by one called Onias Ham-magel, during a great drought in the time of Alexander Jannæus (*Megill. Taanith*).
- 23.—The dedication of the temple of Zerubbabel (Ezra vi, 16). The day is not known, so some put it on the 18th; the *Calendar* of Sigonius puts it on the 23d.
- 28.—A feast in commemoration of the repeal of the decree by which the kings of Greece had forbidden the Jews to circumcise their children, to observe the Sabbath, and to decline foreign worship (*Megill. Taanith*, et *Gemar. Taanith*, c. 2).—Calmet, *Append.*

VE-ADAR

INTERCALARY MONTH.

When the year consists of thirteen lunar months, they place here, by way of intercalation, the second month of Adar, or Ve-Adar. See YEAR.

II. *Modern Julian Calendar of the Temperature and Agricultural Products of Palestine for each Month of the Year.*—These were first carefully collected by J. G. Buhle, in a prize essay presented to the Royal Society of Göttingen, printed in Latin among their transactions under the title *Calendarium Palestinæ (Economica)* (1785), and translated at large by Mr. Taylor in the *Fragments* added to his edition of Calmet's *Dictionary* (iii, 693 seq.), of which the subjoined synopsis is an abridgment. Much valuable information, similarly obtained from Oriental itineraries, combined with per-

sonal observation, may be found in Kitto's *Phys. Hist. of Palest.* vol. ii, ch. vii. See also the art. PALESTINE.

JANUARY.

Weather.—According to the seasons (q. v.) as divided among the Hebrews, this month is the second in winter, and the cold is more or less severe in different situations. There is frequently a considerable fall of snow, which, however, is speedily dissolved in most places. In the plain of Jericho the cold is little felt (Josephus, *War*, v, 4). Heavy rains now fall, especially in the night, which swell the rivers and lakes. Early in the day the thermometer is generally between 40° and 46°, and it does not rise above 5° or 4° in the afternoon. Toward the latter end of this month, when the sky is clear, it becomes so hot that travellers cannot, without some difficulty, prosecute their journey. The wind is generally north or east.

Productions.—All kinds of grain or corn are now sown. The beans are in blossom, and trees in leaf. Earliest appears the blossom of the almond here, even before it has leaves. If the winter be mild, the violet fig (of a longer shape than the summer fig, and gathered early in the spring) is still found on the trees, though they are stripped of their leaves. The mistletoe and the cotton-tree now flourish. Among the flowers and garden herbs of this month, the cauliflower, the blue and the white hyacinth, the gold-streaked daffodil, different violets, tulips in great variety, wormwood, the lentice-tree, anemones, ranunculuses, and colchicas, a kind of lily resembling the Persian when blown.

FEBRUARY.

Weather.—This is much the same as during the last month, except that toward the close, in southerly parts, the snow and rain begin to cease. Like the other features of the rainy season, this month is chiefly remarkable for heavy showers of rain and sometimes falls of snow. The sky is frequently covered with clear light clouds; the atmosphere becomes warm; the wind continuing north or east, but latterly changing westward. During the first 14 days the mercury usually stands between 42° and 47°.

Productions.—The latter crops are now appearing above ground, and a delightful verdure begins to be seen on every side. Barley continues to be sown till the middle of the month; beans acquire a husk, and are soon fit for use; cauliflower and parsnips are now gathered; the peach and early apple tree are blossoming, and a great variety of herbs are in flower, which, says a traveller, "render these parts so delightful that the beholder is often charmed and transported at the sight" (see Thomson's *Travels*, i, 187).

MARCH.

Weather.—In Palestine this month is the forerunner of spring, but rains, with thunder and hail, are not yet over (Pecock's *Travels*, ii, 11). The weather is generally warm and temperate, except on the mountains, and sometimes extremely hot, especially in the plain of Jericho (Thomson's *Travels*, ii, 27). In the middle of the month, the mercury stands at 52°, and nearer the close between 56° and 58° (Russel, *Aleppo*, p. 149, 150). Toward the end, the rivers are much swollen by rain and the thawing of snow upon the tops of mountains (Egmont and Heyman's *Travels*, i, 835). Earthquakes sometimes take place, and they are accounted for by Shaw in his *Travels*, p. 186.

Productions.—While the wheat is scarcely in ear, the barley is now ripe in Jericho (Shaw's *Travels*, p. 290, 291). Indian wheat, rice, and corn of Damascus are now sown in Lower Egypt (Thomson's *Travels*, ii, 169). Several kinds of pulse, as beans, lentils, and chick-peas, become ripe (*Itiner. B. Tudei*, p. 108). Every tree is at this time in full leaf (Russel's *Aleppo*, p. 10). The fig, the palm, etc., together with many shrubs and herbs, are now in blossom. The Jericho plum begins to ripen. The vine, having yielded its first clusters, is pruned. Various aromatic garden herbs are becoming fit for use.

APRIL.

Weather.—The "latter rains" (עֲרֵבֵי מַיִם) now fall, as Korte asserts (*Reise nach dem gelobten Lande*, p. 489); and Shaw asserts that none are observed after them until summer (*Travels*, p. 290). The rain ceases about the close of the month, and the sky generally becomes serene. The sun's heat is excessive in the plains of Jericho, but in other parts of Judæa the spring is now most delightful (Mandrell's *Jour.* p. 96). Concerning the meteorology of Palestine, some interesting observations are made by Martini (*Viaqit*, iii, 226) and Dr. Shaw (*Travels*, p. 299). The mercury advances from 60° to 66°.

Productions.—The time of harvest depends upon the duration of the rainy season. After the rains cease, the corn soon arrives at maturity, according to the situation. Wheat, sea or spelt, and barley, now ripen (Korte's *Rise*, p. 187; *Itiner. Hierosolym.* p. 98). The spring fig is still hard (Shaw, p. 290). The almond and orange trees now produce fruit (Maunder, p. 63), and the terebinth-tree ("oak," *Calist. Hierobot.* p. 84) is in blossom (Sandys, p. 176). A new shoot, bearing fruit, springs from that branch of the vine that was left in the former month, which must now be lopped (Brocard, *Descript. T. S.* p. 882). Syria and Palestine produce canes from which they obtain sugar (Ignatius von Rheinfelden, *Hierosolym. Fliegenfahrt*, p. 48, 47). Tulips, ranunculuses, anemones, etc., etc., are now in

flower at Aleppo and Tripoli (Thevenot, iii, 92; Rauwolf, i, 55). The grass is now very high, and the Arabs lead out their horses to pasture (Mariti, ii, 25, 28). The same is likewise done in Ferris (Chardin, ii, 12).

MAY.

Weather.—In this month the summer season commences, when the excessive heat of the sun renders the earth barren (Korte, p. 257). A few showers are observed about Aleppo, sometimes accompanied with hail and thunder (Russel, p. 151). At the beginning of the month the mercury reaches 70°; then it rises gradually from 76° to 80°, being greatly affected by the direction of the variable winds. The snows on Lebanon thaw rapidly now, but the cold is still very sharp on the summits (Maundrell, p. 236).

Productions.—The harvest is completed during this month. Wheat is now cut in Galilee (Hasselquist, p. 84). About the beginning of the month barley is generally ripe (Egmont and Heyman's *Travels*, ii, 27). Rice, however, is not quite ripe (Schwegler, p. 817). The early apples in Palestine now come to maturity, at least toward the end of this month (Pococke, ii, 126). The common early apples may now be gathered in the warmer situations, but the better varieties ripen later (Shaw's *Travels*, p. 129). Cotton is said to be sown in the Holy Land at this period (Hasselquist, p. 176). The early shoots of the vine, which had been lopped, now produce the later grapes (Brocard, *Descr. Ter. Sanct.* p. 382, 383). They still continue, after the harvest, to sow various garden herbs, part of which are unknown to us; and many of them, as cucumbers, cauliflowers, and others, come to maturity twice in the same year, in spring and autumn (Korte, p. 187). In Palestine the grass and herbs have grown to such a height this month, that when Thevenot was riding from Nazareth to Acre, on the 8th of May, they reached the girth of his saddle (*Voyages au Levant*, ii, 671).

JUNE.

Weather.—During this month the sky is generally clear, and the weather becomes extremely hot (Radzivil's *Peregrin. Hierosolym.* p. 37). As the month advances, the mercury gradually rises in the morning from 76° to 90°; in the afternoon it stands between 84° and 92° (Thevenot, iii, 102). The inhabitants pass their nights in summer upon the roofs of their houses, which are not rendered damp by any dew (Russel, p. 152). The summits of the mountains of Palestine are not, however, yet free from snow (Pococke, ii, 153).

Productions.—At Aleppo the corn is sometimes not all cut before the beginning of June; although Russel's testimony differs from this assertion of Thevenot's, yet Shaw says that in Africa the harvest sometimes lasts till the end of June (*Travels*, p. 123). The early figs, black and white, now ripen and immediately fall off. When they do not come to their proper size and maturity, they are called ⲓⲛⲓⲟⲩ, *shenou*, which names are used for unripe fruit in general. The process of caprification is now performed (Shaw, p. 296). Apples (a few of the earliest of the better sorts), plums, mulberries, cherries, etc., are also ripe in this month, but of the last there are very few trees in Palestine. The cedar gum, or *cedrium*, a clear white resin, which is said to have great medicinal virtue when hardened, distils spontaneously in the summer time, and without any incision being made, from the bark of the coniferous cedar. In extracting a greater quantity, they cut the bark (Arvieux, *Mém.* ii, 413, 414). Of the shrubs and herbs, the balm-tree is worthy of notice, which grows chiefly about Jericho. From this the Arabs, by making an incision, get the "Balm of Gilead" during this and two following months (Sandys, *Tour*, p. 197). The Arabs, as the summer advances, lead their flocks to the hills northward (De la Roque, *Voyage*, p. 174; Radzivil, p. 40).

JULY.

Weather.—All travellers who have been exposed to the open air this month affirm that the heat is now extremely intense. Radzivil found the brooks of the "valley of the terebinths" dried up on the 9th. At Jerusalem the heat is much less than about Jericho (*Peregrin. Hierosol.* p. 97, 98). The snow on the tops of mountains, thawing gradually during the summer, yields a large supply of water to the brooks below. It cannot, however, be affirmed that the snows on the summits of Lebanon are entirely dissolved every year (Korte, p. 419). The winds generally blow from the west, but, when they fall, the heat is excessive. The mercury usually stands, in the beginning of the month, at 80°, and toward the end at 86° or 86° (Russel, p. 152, 153).

Productions.—Grapes are now ripe about Aleppo, but remain till November or December (Korte, p. 571). Dates are to be found ripe at Jericho, but they seldom come to maturity at Jerusalem (Shaw, p. 297). Apple and pear trees present ripe fruit, but of an inferior kind. The nectarine yields a fruit most agreeable in flavor and immense in size (Shaw, p. 129, 130). The vintage begins in favored situations. The cauliflower and parsnip are sown this month (Russel, p. 25; Shaw, p. 126). The gourd called *citrus* ripens (Russel, p. 26). There is no longer a supply of pasturage for the cattle (Shaw, p. 150).

AUGUST.

Weather.—The sky is serene and fair during this month, and the heat is extreme (Schulz, *Letz. d. Höchst.* v, 373). The

mercury, until those days when the clouds rise, continues the same as in the last month; afterward it falls about 4° or 5°. So at Aleppo (Russel, p. 152). On the 18th snow is seen on the summits of Lebanon (Korte, *Reise*, p. 471).

Productions.—The first clusters of the vine, which blossomed at Antaraud in March, now come to maturity, and are ready for gathering (Brocard, p. 383). The fig, properly so called, which remains a long while on the tree, and is always reckoned, in the sacred writings, among summer fruit, may now be gathered at Algiers (Shaw, p. 129). The cultivated olive-tree yields ripe olives this month in the environs of Jericho (Tschudi, *Reise*). Pomegranates ripen. The shrub *al-Hemul*, brought out of Egypt into Palestine, puts forth leaves this month, and then fragrant blossoms, which the Turks, by various artificial methods, endeavor to produce sooner (Rauwolf, i, 55).

SEPTEMBER.

Weather.—The mercury remains the same at the beginning of this month as at the end of August, except that in the afternoon it rises (Russel, p. 14). Although the days are very hot, the nights are extremely cold (Schulz, p. 417-480). Rain falls toward the end of the month, but the rainy season generally commences now (Tschudi, p. 286).

Productions.—Russel says that the Syrians begin to plough about the end of this month (Aleppo, p. 16). The palm presents ripe dates now in Upper Egypt (Radzivil, p. 173). The pomegranate, pear, and plum trees are laden with fruit in this month in the gardens of Damascus (Schulz, p. 443). According to Korte, cotton, which was sown the year before, and has lain all the winter, is now gathered ripe (*Reise*, p. 576).

OCTOBER.

Weather.—The extreme heat is now abated, although still great in the daytime, the air being much refreshed by cold in the night, by which the dew, that is much more dense in this southern climate, is frozen (Korte, p. 257). The rains which now fall are called early or former rains (ⲓⲛⲓⲟⲩ, *prémios*), and come in frequent showers. The winds are seldom very strong, but variable. After the rains the mercury descends gradually to 60° (Russel's *Aleppo*, p. 166).

Productions.—Wheat is sown by the Arabs about Algiers in the middle of this month (Shaw, p. 125). Russel informs us that it is sown at Aleppo about the same time; so that it seems probable this is the time of sowing it in Palestine (Aleppo, p. 16). The third clusters of the vine, which in the month of May had produced another small branch, loaded with the later grapes, must be gathered this month (Brocard, p. 333). The olive-tree produces ripe olives toward the latter end of October in the empire of Morocco, and the pomegranate also now yields ripe fruit at the same place (Hist, p. 304, 307). Lettuces, endives, cresses, spinach, beets, etc., may be gathered at Algiers from this month till June (Shaw's *Travels*, p. 136).

NOVEMBER.

Weather.—If the rains have not already fallen, they certainly fall this month (Shaw's *Travels*, p. 200). The sun's heat, although not so great in the daytime, is, however, still violent; but the nights are very cold and uncomfortable for travellers, many of whom journey by night, carrying torches before them (Cotovic, *Itin. Hieros.* p. 334). The mercury, as the month advances, gradually falls from 60° to 50° (Russel, p. 156).

Productions.—This is the time for the general sowing of corn, as wheat, sear or spelt, and barley, in Palestine, at Aleppo, and in Lower Egypt (Korte, p. 189; Shaw, p. 128). Dates are still gathered in Egypt in the middle of this month (Thevenot, ii, 176). The trees till this period retain their leaves; and at Aleppo the vintage lasts to the 15th inst. (Russel, p. 14).

DECEMBER.

Weather.—This is the first winter month; the cold is piercing, and sometimes fatal to those not inured to the climate. Yet rain is more common than snow, which, when it falls, very quickly thaws (Korte, p. 585; Mariti, ii, 187). The winds, as in the last month, usually blow from the east or north. They are seldom violent. The mercury stands at 48°, and is subject to very slight alterations (Russel, p. 155, 156).

Productions.—Corn and pulse are sown during this month, as at the end of October. Sugar-canes now ripen, and are cut down at Cyprus (Cotovic, *Itin. Hieros.* p. 137). The grass and herbs are again springing out of the ground after the rains, and the Arabs now drive their flocks down from the mountains into the plains (Rauwolf, i, 118). See **AGRICULTURE**.

CALENDAR, ROMAN. For this in its most complete and final form, the world is indebted to Julius Cæsar, who, during his office as Pontifex Maximus, undertook the memorable task known as the "reform of the calendar." The Roman year had hitherto consisted of 355 days, with a month of thirty days intercalated every third year, so that the average length of the year was 365 days. This arrangement was attributed to Numa Pompilius, who added two months to the short year of Romulus; its regulation was left

to the pontiffs. If the intercalation had been regularly made, the Romans would have lost nearly one day in every four years, since the real length of the solar year is about 365 $\frac{1}{4}$ days; but the business was so carelessly executed that the difference between the civil and the solar year sometimes amounted to several months. Cæsar called on the astronomers, especially on Sosigenes of Alexandria, to rectify the discrepancy and prevent future error. It was determined to make the first of January of the Roman year U.C. 709 coincide with the first of January of the solar year which we call B.C. 45. But it was calculated that this Jan. 1 of the year U.C. 709 would be 67 days in advance of the true time; in other words, it would not concur with Jan. 1 of B.C. 45, but with Oct. 22 of B.C. 46. Two intercalary months, making together 67 days, were therefore inserted between the last day of November and the first of December of the year U.C. 708. An intercalary month of 28 days had already been added to February of that year, according to the old method. The Roman year 708 was thus made to consist in all of the prodigious number of 445 days (i. e. 355 + 28 + 67). It was hence scoffingly called "the year of confusion;" more justly it should be named, as Macrobius observes, "the last year of confusion." To prevent future errors, the year was lengthened from 355 to 365 days, each month except February being lengthened (by one or two days, nearly alternately), according to the rule which we still observe. But as the solar year consists of very nearly 365 $\frac{1}{4}$ days, it was manifestly necessary to add one day in every four years, and this was done at the end of February, as at present in our "leap year." Such was the famous *Julian Calendar*, which, with a slight alteration, continues in use in all Christian countries to the present day.

Gregorian Calendar.—The addition of one day for every four years would be correct if the solar year consisted exactly of 365 $\frac{1}{4}$ days, or 365 days and 6 hours; but, in fact, it consists of only 365 days, 5 hours, 47 minutes, 51 $\frac{1}{2}$ seconds; so that the Julian year is longer than the true solar year by about 12 minutes. Cæsar's astronomers are supposed to have been aware of this, but to have neglected it. Accordingly, in the year A.D. 1582, the beginning of the Julian year was found to be about 18 days behind the true time, the vernal equinox falling on the 11th instead of the 21st of March, its date at the Council of Nice, A.D. 325. The time of Easter, therefore, and of the other movable festivals, had been unsettled by the progressive recession of days, and it was matter of importance for ecclesiastical as well as civil purposes that the calendar should be rectified. Pope Gregory XIII (q. v.) therefore "ordained that ten days should be deducted from the year 1582, by calling what, according to the old calendar, would have been reckoned the 5th of October, the 15th of October, 1582; and in order that this displacement might not recur, it was further ordained that every hundredth year (1800, 1900, 2100, etc.) should not be counted a leap-year, except every fourth hundredth, beginning with 2000. In this way the difference between the civil and the natural year will not amount to a day in 5000 years. In Spain, Portugal, and part of Italy the pope was exactly obeyed. In France the change took place in the same year, by calling the 10th the 20th of December. In the Low Countries, the change was from the 15th of December to the 25th; but it was resisted by the Protestant part of the community till the year 1700. The Romanist nations in general adopted the *style* ordained by their sovereign pontiff; but the Protestants were then too much inflamed against Romanism in all its relations to receive even a purely scientific improvement from such hands. The Lutherans of Germany, Switzerland, and, as already mentioned, of the Low Countries, at length gave way in 1700, when it had become necessary to omit eleven instead of ten days. A bill to this

effect had been brought before the Parliament of England in 1685, but does not appear to have gone beyond a second reading in the House of Lords. It was not till 1751, and after great inconvenience had been experienced for nearly two centuries, from the difference of the reckoning, that an act was passed (24 Geo. II, 1751) for equalizing the style in Great Britain and Ireland with that used in other countries of Europe. It was then enacted that eleven days should be omitted after the 2d of September, 1752, so that the ensuing day should be the 14th." Russia still adheres to the Old Style, so that her reckoning is now 12 days behind that of the rest of Europe.

Calendar of the French Republic.—By a decree of the National Convention, on Nov. 24, 1793, it was ordained that a new era should date from the beginning of the Republic, Sept. 22, 1792; the midnight preceding which, being the autumnal equinox, was fixed upon as the epoch, from which the years were to be reckoned as Year One, Year Two, etc. The year was divided into 12 months, each of 30 days, to which new names were given, as *Vendémiaire* (vintage month), *Brumaire* (foggy month), *Frimaire* (frost month), etc. The months were divided into periods of 10 days, called *Primidi*, *Duodi*, *Triidi*, etc. The tenth day was to be the day of rest, the Christian Sabbath being done away. Five intercalary days were added for each year, viz. the festivals of *Genius*, *Labor*, *Action*, *Reward*, *Opinion*. In every fifth year there was to be an intercalary festival of *The Revolution*. This calendar went into use Nov. 26, 1793, and was abolished in 1805 by Napoleon, who ordered the Gregorian Calendar to be resumed on Jan. 1, 1806.—Carlyle, *French Revolution*, ii, 386; *Penny Cyclopædia*, s. v.; Chambers's *Encyclopædia*, s. v. See CHRONOLOGY.

CALENDAR, ECCLESIASTICAL.—I. A table of the order and series of days, weeks, months, and holy days in the year (so called from the *calendæ*, or first day of the Roman month). The oldest extant calendar containing the Christian festivals is that of Silvius (A.D. 448), published in the *Acta Sanctæ* June (vii, 176). There is a fragment of a Gothic calendar, supposed to be of the 4th century, covering the latter part of October and the whole of November, which gives seven days with saints' names. It may be found in *Mai, Scriptor. Veter. nova collectio*, v, l. See FEASTS and FASTS.

II. The *Fasti*, or catalogues in which different churches preserved the names of those saints whom they especially honored, as their bishops, martyrs, etc., to which they added the names of some other saints, but generally those of the neighboring churches. The calendars differed from the martyrologies in this, that the former contained but few names of saints unconnected with the particular church; the latter contained all the saints honored by the whole Church. The most ancient known calendar is that of the Roman Church, which, according to Baillet, was formed about the middle of the fourth century, under Pope Liberius, or, according to Chatain, in 386, under Pope Julius (Antwerp, 1634, ed. Boucher). See Landon, *Ecc. Dict.* ii, 486. The most copious work on the subject is Assemani, *Kalendaria Ecclesie Universæ* (Rom. 1755, 6 vols. 4to). The present Saints' Calendar of the Romish Church is very copious: it may be found, more or less complete, in the Roman almanacs from year to year.

The German Lutheran Church retained the Romanist Calendar (with the saints' days of that age) at the Reformation. Professor Piper constructed in 1850 an Evangelical Calendar for the use of the Evangelical Church of Germany, which is issued annually, full of biographical and other matter of interest, along with the calendar of feasts, *fasts*, etc. See Piper, *Die Verbesserung d. Evang. Kalenders* (Berlin, 1850).

The calendar of the Church of England, as it stands

in the large editions of the Prayer-book, consists of nine columns: the first contains the golden number or cycle of the moon; the second shows the days of the month in their numerical order; the third contains the Dominical or Sunday letter; the fourth the calends, nones, and ides (this was the Roman method of computation, and was used by the early Christians); the fifth contains the holy days of the Church, as also some festivals of the Romish Church, set down for public convenience rather than for reverence; and the remaining four contain the portions of Scripture and of the Apocrypha appointed for the daily lessons.

The list of saints' days and festivals includes a number of the Romish holidays, properly so called, viz.: Lucian, priest and martyr, Jan. 8; Hilary, bishop and confessor, Jan. 18; Prisca, virgin and martyr, Jan. 18; Fabian, bishop and martyr, Jan. 20; Agnes, virgin and martyr, Jan. 21; Vincent, deacon and martyr, Jan. 22; Blasius, bishop and martyr, Feb. 8; Agatha, virgin and martyr, Feb. 5; Valentine, bishop and martyr, Feb. 14; David, tutelar saint of Wales, March 1; Cedde or Chad, bishop, March 2; Perpetua, martyr, March 7; Gregory, bishop and confessor, March 12; Patrick, tutelar saint of Ireland, March 17; Edward, king of the West Saxons, March 18; Benedict, abbot, March 21; Richard, bishop, April 8; Ambrose, bishop, April 4; Alphege, archbishop, April 19; George, saint and martyr, April 28; Cross, invention of, May 8; John, saint, evangelist, May 6; Dunstan, archbishop, May 19; Augustine, archbishop, May 26; Bede, venerable, May 27; Nicomede, martyr, June 1; Boniface, bishop and martyr, June 5; Alban, saint and martyr, June 17; Edward, translation of, June 20; Mary, Virgin, visitation of, July 2; Martin, bishop and confessor, July 4; Swithin, bishop, July 15; Margaret, virgin and martyr, July 20; Magdalene, saint Mary, July 22; Anne, saint, July 28; Lammas Day, Aug. 1; Transfiguration of our Lord, Aug. 6; Jesus, name of, Aug. 7; Laurence, archdeacon and martyr, Aug. 10; Augustine, bishop of Hippo, Aug. 28; John Baptist, beheading of, Aug. 29; Giles, abbot and confessor, Sept. 1; Enurchus, bishop, Sept. 7; Mary, Virgin, nativity of, Sept. 8; Holy Cross, recovery of, Sept. 14; Lambert, bishop and martyr, Sept. 17; Cyprian, archbishop and martyr, Sept. 26; Jerome, priest and confessor, Sept. 30; Remigius, bishop, Oct. 1; Faith, virgin and martyr, Oct. 5; Denys, bishop and martyr, Oct. 9; Edward, translation of, Oct. 13; Ethelreda, virgin, Oct. 17; Crispin, saint and martyr, Oct. 25; Leonard, confessor, Nov. 6; Martin, bishop and confessor, Nov. 11; Britins, bishop, Nov. 18; Machutus, bishop, Nov. 16; Hugh, bishop, Nov. 17; Edmund, king and martyr, Nov. 20; Cecilia, virgin and martyr, Nov. 22; Clement I, bishop and martyr, Nov. 28; Catharine, virgin and martyr, Nov. 26; Nicholas, bishop, Dec. 6; Lucy, virgin and martyr, Dec. 18; O Sapientia, Dec. 16; Silvester, bishop, Dec. 31.

These are omitted in the calendar of the Protestant Episcopal Church, which retains only the scriptural festivals. Wheatly assigns the following reasons for their retention by the English Church:

"Some of them being retained upon account of our courts of justice, which usually make their returns on these days, or else upon the days before or after them, which are called in the writs *Vigil. Fest. or Crast.*, as in *Vigil. Martin, Fest. Martin, Crast. Martin*, and the like. Others are probably kept in the calendar for the sake of such tradesmen, handicraftsmen, and others, as are wont to celebrate the memory of their tutelar saints, as the Welshmen do of St. David, the shoemakers of St. Crispin, etc. And again, churches being in several places dedicated to some or other of these saints, it has been the usual custom in such places to have wakes or fairs kept upon those days, so that the people would probably be displeased if, either in this or the former case, their favorite saint's name should

be left out of the calendar. Besides, the histories which were writ before the Reformation do frequently speak of transactions happening upon such a holy day, or about such a time, without mentioning the month; relating one thing to be done at Lammas-tide, and another about Martinmas, etc., so that, were these names quite left out of the calendar, we might be at a loss to know when several of these transactions happened. But for this and the foregoing reasons our second reformers under queen Elizabeth (though all those days had been omitted in both books of king Edward VI, excepting St. George's Day, Lammas Day, St. Laurence, and St. Clement, which were in his second book) thought convenient to restore the names of them to the calendar, though not with any regard of their being kept holy by the Church."—Wheatly, *On Common Prayer*, ch. i; Procter, *On Common Prayer*, 62; Piper, in Herzog's *Real-Encyclopädie*, vii, 282; Coleman, *Ancient Christianity*, ch. xxvi, § 5; *Christian Remembrancer*, xi, 381.

Calendārum Festum, Feast of the Calends. This heathen festival was retained by many Christians, and is called *bota* and *vota*. It was in some periods celebrated, with great indecencies, under the names *festum kalendārum, festum hypodiakonorum, festum stultorum*. In later times, the people met masked in the churches, and, in a ludicrous way, proceeded to the election of a mock bishop, who exercised a jurisdiction over them suited to the festivity of the occasion. Fathers and councils long labored to restrain this license, but to little purpose. Tertullian, Chrysostom, and Augustine declaim, in the strongest terms, against this festival; and the Council in Trullo, A.D. 692, forbids the dancings which were used both by men and women, under the penalty of excommunication. In some instances the practice of sacrificing a calf was adopted, especially at the *bota*, a feast of the god Pan. The Council of Auxerre takes notice of the remains of some heathen superstition in France, in offering a hind or calf, which it designates a diabolical observation.—Bingham, *Orig. Eccl.* bk. xx; Farrar, *Eccl. Dict.* s. v.

Calendārum Fratres, or Calendar Brethren, a society formerly spread over France, Germany, and Hungary, and which is said to have originated in Saxony in the thirteenth century. It assembled in various places on the first day of each month to regulate the observance of the ensuing festivals, the distribution of alms, days of fasting, the burial of the dead, etc. It was, in fact, a sort of beneficial society, under the patronage of the bishop of the diocese. It afterward led to abuses, carousals, etc., and most of the societies were abolished at the Reformation. Some, however, were still in existence at the beginning of the nineteenth century. Even in the Protestant city of Brunswick a "caland" has nominally maintained itself. One caland ("the caland of princes at Kahla") consisted merely of members of princely houses; several (as, e. g. the caland at Bergen) of knights and members of the higher clergy; others of knights only. See Feller, *Dis. de Fratr. Kal.* (Frankf. 1692, 4to); Blumberg, *Ueber d. Calandbrüder* (Chemn. 1721); Ledebur, in vol. iv of the *Märkische Forschungen* (Berl. 1850).

Calf (prop. עֵבֶר, *e' gel, μόσχος*; fem. עֵבֶרָה, *eglah'*, δάμαλις; sometimes עֵבֶר, *par*, a steer or young bullock; also periphrastically עֵבֶר בֶּן יָמִים, *son of the herd*), the young of the ox species. See ΒΕΒΥΞ; BULL, etc. There is frequent mention in Scripture of calves, because they were made use of commonly in sacrifices. The "fatted calf" was regarded by the Hebrews as the choicest animal food. It was stall-fed, frequently with special reference to a particular festival or extraordinary sacrifice (1 Sam. xxviii, 24; Amos vi, 4; Luke xv, 23). The allusion in Jer. xxxiv, 18, 19, is to an ancient custom of ratifying a contract or covenant, in the observance of which an animal was slain

and divided, and the parties passed between the parts (comp. Homer, *Il.* iii, 208), signifying their willingness to be so divided themselves if they failed to perform their covenant (Gen. xv, 9, 10, 17, 18). The expression "calves of our lips," in Hos. xiv, 2, is figurative signifying the fruits of our lips (Wolf, *Juvenis laborans*, Viteb. 1711). As calves were used in sacrifices, the injunction requires us to render the sacrifice of prayer and praise to God, instead of the animal sacrifice (Heb. xiii, 15). See Wemyss, *Symbol. Dict.* s. v. Compare HELIPER.

CALF-WORSHIP.—This appears to have originated in Egypt, where we know that brutes of nearly all sorts were held in reverence by some one or another of the various nomes into which that country was divided. See ANIMAL WORSHIP. Of all these creatures, however, the calf, or rather bullock, seems to have been most generally adored, especially a peculiar description, or rather peculiarly-colored bull, to which, under the name of Apis or Mnevis, divine honors of the most extraordinary kind were paid throughout Egypt. It is from this form of idolatry that the scriptural examples of calf-worship are clearly derived. Yet it is possible that the commentators are not quite correct in supposing Apis to be the deity whose worship was imitated by the Jews, at least in the first instance. The Egyptians gave that name to a living bull which they worshipped at Memphis; but they also worshipped another living bull in the city of On, or Heliopolis, which they called *Mne*, or, according to the Greek form, *Mnevis*, and which they adored as the living emblem of the sun. Now the Israelites, from the circumstance of their living in the land of Goshen, in or near which Heliopolis was situated, and also from the connection of Joseph, the head of their nation, with one of the priestly families of that city, must have been well acquainted with its peculiar forms of idolatry. It is also very probable that many of them had joined in those rites during their sojourn. We might therefore naturally suppose that they would adopt them on this occasion; and the supposition that they did so is confirmed by a very curious fact, which has not yet been noticed, as bearing upon this question. Champollion has observed, in his *Pantheon Egyptien*, that Mnevis is said by Porphyry and Plutarch to have been a *black* bull, as Apis unquestionably was; but he assures us that this is not the case with regard to the existing remains of ancient Egypt; for, although in the Egyptian paintings Apis is either colored black or black and white, Mnevis, on the contrary, in the only figure of him hitherto discovered, is colored *bright yellow*, evidently with the intention of representing a *golden image*. This fact, though not a conclusive proof, affords a strong

presumption that the golden calf was made according to the usual form and color of the images of Mnevis. The annexed engraving represents this symbolical deity of Heliopolis as he is painted on the coffin of a mummy at Turin, the name being distinctly written in hieroglyphical characters, MNE, without the Greek termination. It differs in color only, and not in form, from another painting on the same coffin, which bears the name of Apis. Both have the same trappings—the sun's disk between the horns, surmounted by the plume of ostrich feathers, signifying justice, and the whip, the emblem of power; and both are accompanied by the serpent, representing the spirit of the gods. The bull Mnevis or Mne—for *vis* is merely a Greek termination—was sumptuously lodged in the city On or Heliopolis, and this is all that we find recorded of him in ancient writers. Far more ancient than Apis, the era of his consecration is lost, and perhaps forever. The only circumstance which is of importance, save that the Israelites fell into his worship, is that he appears to have represented the zodiacal sign which was depicted yellow, while, by a curious anomaly, Apis, whose attributes all coincide with those of the sun, was black. The worship paid to him, though lasting till the downfall of the Egyptian hierarchy, gradually diminished before the more important and popular rites of Apis, and little is said of Mnevis. The following account is chiefly from Kitto and Smith.

1. The most ancient and remarkable notice in the Scriptures on this head is that of the golden calf which was cast by Aaron while the Israelites were encamped at the foot of Sinai. In Exod. xxxii, 4, we are told that Aaron, constrained by the people, in the absence of Moses, made a molten calf of the golden ear-rings of the people, to represent the Elohim which brought Israel out of Egypt. He is also said to have "finished it with a graving-tool;" but the word חֲרָטָה, *che'ret*, may mean a *mould* (comp. 2 Kings v, 23, Auth. Vers. "bags;" Sept. θυλάκιος). Bochart (*Hieroz.* lib. ii, cap. xxxiv) explains it to mean, "he placed the ear-

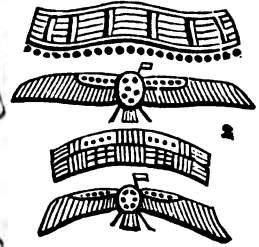

1. Bronze Figure of Apis. 2. The Marks on his Back.

rings in a bag," as Gideon did (Judg. viii, 24). Probably, however, it means that, after the calf had been cast, Aaron ornamented it with the sculptured wings, feathers, and other marks which were similarly represented on the statues of Apis, etc. (Wilkinson, iv, 848). It does not seem likely that the ear-rings would have provided the enormous quantity of gold required for a *solid* figure. More probably it was a wooden figure laminated with gold, a process which is known to have existed in Egypt. "A *gilded* ox covered with a pall" was an emblem of Osiris (Wilkinson, iv, 835). See GOLD.

To punish the apostasy, Moses burnt the calf, and then, grinding it to powder, scattered it over the water, where, according to some, it produced in the drinkers effects similar to the water of jealousy (Num. v). He probably adopted this course as the deadliest and most irreparable blow to their superstition (Jerome, *Ep.* 128; *Plut. De Is.* p. 362), or as an allegorical act (Job xv, 16),



Ancient Egyptian sacred Calf Mnevis.

or with reference to an Egyptian custom (Herod. ii, 41; Poli *Synopsis*, in loc.). It has always been a difficulty to explain the process which he used; some account for it by his supposed knowledge of a forgotten art (such as was one of the boasts of alchemy) by which he could reduce gold to dust. Gouget (*Origines des Loix*) invokes the assistance of natron, which would have had the additional advantage of making the draught nauseous. Baumgarten easily endows the fire employed with miraculous properties. Bochart and Rosenmüller merely think that he cut, ground, and filed the gold to powder, such as was used to sprinkle over the hair (Josephus, *Ant.* viii, 7, 8). There seems little doubt that the Heb. term here rendered "burnt" (בָּרָא, Sept. *karakaw*) properly has this signification (Hävernicks's *Introd. to the Pentat.* p. 292). Those commentators who have been at so great pains to explain in what manner Moses reduced the golden calf to such a state as to make it potable in water seem to have overlooked the consideration that, as the science of making gold leaf for gilding was already practised in Egypt, there could be no great difficulty, even if chemical processes had not then been discovered, in effecting the object. See METAL.

The legends about the calf are numerous. The suggestion is said by the Jews to have originated with certain Egyptian proselytes (Godwyn's *Mos. and Aar.* iv, 5); Hur, "the desert's martyr," was killed for opposing it; Abulfeda says that all except 12,000 worshipped it; when made, it was magically animated (Exod. xxxii, 24). "The devil," says Jonathan, "got into the metal and fashioned it into a calf" (*Lightfoot, Works*, v, 898). Hence the Koran (vii, 146) calls it "a corporeal calf, made of their ornaments, which loved." This was effected, not by Aaron (according to the Mohammedans), but by al-Sâmeri, a chief Israelite, whose descendants still inhabit an island of the Arabian Gulf. He took a handful of dust from the footsteps of the horse of Gabriel, who rode at the head of the host, and threw it into the mouth of the calf, which immediately began to low. No one is to be punished in hell more than forty days, being the number of days of the calf-worship (Sale's *Koran*, ed. Davenport, p. 7, note; and see Weil's *Legends*, p. 125). It was a Jewish proverb that "no punishment befalleth the Israelites in which there is not an ounce of this calf" (Godwyn, *ut sup.*). See AARON.

2. The next notice refers to an event which occurred ages after, when Jeroboam, king of Israel, returning from his long exile in Egypt, set up two idols in the form of a calf, the one in Dan (comp. Josephus, *War*, iv, i, 1) and the other in Bethel, the two extremes of his kingdom, to prevent the ten tribes from resorting to Jerusalem to worship, and so more effectually to separate them from the house of David. Temples were built and altars erected for these images; priests were appointed from all the tribes without distinction, and the priestly functions performed even by the monarch himself. The calves continued to be a snare to the people of Israel until the captivity. The calf at Dan was carried away by Tiglath-Pileser, and that of Bethel ten years after by his son Shalmaneser (1 Kings xv, 29; xvii, 18; Prideaux, *Connection*, i, 15). Jeroboam's sin is always mentioned whenever his name is used (1 Kings xi, 40; xii, 26-33; 2 Chron. xi, 15; Hos. viii, 5, 6; x, 5; xiii, 2). See JEROBOAM.

Bochart thinks that the ridiculous story of Celsus about the Christian worship of an ass-headed deity (called *Θαφασαυθ* ἢ *Ὀνίηλ*—a story at the source of which Tertullian, *Ὀνοκωϊτης*, *Apol.* 16; *Ad Nat.* i, 14, could only guess) sprang from some misunderstanding of such emblems as the golden calf (Münch. *Fel. Apol.* ix). But it is much more probable, as Origen conjectured, that the Christians were confounded with the absurd mystic *Ophians*, or Ophite Gnostics (Tacitus,

Hist. v, 4; Merivale, *Hist. of Emp.* vi, 564). See ASS'S HEAD.

Theory of this Idolatry.—This almost incomprehensible degradation of human reason was, more particularly in the first instance, no doubt the result of the debasing influences which operated on the minds of the Israelites during their sojourn in Egypt, where, amid the daily practice of the most degrading and revolting religious ceremonies, they were accustomed to see the image of a sacred calf, surrounded by other symbols, carried in solemn pomp at the head of marching armies, such as may still be seen depicted in the processions of Rameses the Great or Sesostria. The accompany-

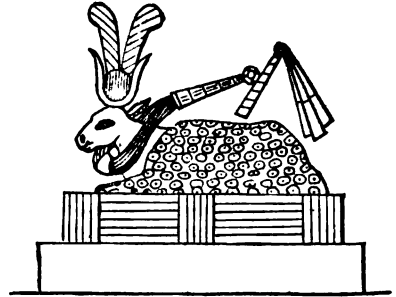

Ancient Egyptian Calf-Idol.

ing figure is a representation of a calf-idol, copied from the original collection made by the artists of the French Institute of Cairo. It is recumbent, with human eyes, the skin flesh-colored, and the whole afterwards covered with a white and sky-blue diapered drape; the horns are not on the head, but above it, and contain within them the symbolical globe surmounted by two feathers. Upon the neck is a blue and yellow yoke, and the flagellum, of various colors, is suspended over the back; the whole is fixed upon a broad stand for carrying, as here shown. The rendering of the Auth. Vers., which alludes to the image being finished with a graving-tool, is obviously correct, for all the lines and toolings of the covering cloth, of the eyes, and of the feathers must have required that manual operation (Exod. xxxii, 4). It is doubtful whether this idolatrous form is either Apis or Mnevis; it may perhaps represent the sun's first entrance into Taurus, or, more probably, be a symbol known to the Egyptians by an undeciphered designation, and certainly understood by the Edomites of later ages, who called it *bakumed* and *kharsuf*, or the calf, the mysterious *anima mundi*; according to Von Hammer (Pref. to *Ancient Alphabets*), the Nabathæan secret of secrets, or the beginning and return of every thing. With the emblems on the back, it may have symbolized the plural Elohim long before the cabalistical additions of this mysterious type had changed the figure. At the time of the departure of the Israelites from Egypt this may have been the Moloch of their neighbors, for that idol was figured with the head of a calf or steer. A similar divinity belonged to the earliest Indian, Greek, and even Scandinavian mythologies, and therefore it may be conceived that the symbol, enduring even to this day, was at that period generally understood by the multitude, and consequently that it was afterward revived by Jeroboam without popular opposition. Egyptian paintings illustrate the contempt which the prophet Hosea (x, 5) casts upon the practice of those whom he designates as "coming to sacrifice and kiss the calves." See BAAL.

α. Some regard the golden calf both of Aaron and Jeroboam as intended by the Jews for an Egyptian god. The arguments for this view are, 1. The ready apostasy of the Jews to Egyptian superstition (Acts vii, 43, and chap. v, passim; Lactant. *Inst.* iv, 10). 2. The fact that they had been worshippers of Apis (Josh. xxiv, 14), and their extreme familiarity with

his cultus (1 Kings xi, 40). 8. The resemblance of the feast described in Exod. xxxii, 5, to the festival in honor of Apis (Suidas, s. v. Ἀπίδος). Of the various sacred cows of Egypt, that of Isis, of Athor, and of the three kinds of sacred bulls, Apis, Basis, and Mnevis, Sir G. Wilkinson fixes on the latter as the prototype of the golden calf; "the offerings, dances, and rejoicings practised on that occasion were doubtless in imitation of a ceremony they had witnessed in honor of Mnevis" (*Anc. Egypt.* v, 197, see pl. 35, 36). The ox was worshipped from its utility in agriculture (*Plut. De Is.* 74), and was a symbol of the sun, and consecrated to him (*Hom. Od.* i, xii, etc.; Warburton, *Dis. Leg.* iv, 3, 5). Hence it is almost universally found in Oriental and other mythologies. 4. The expression, "an ox that eateth hay," etc. (*Psa.* cvi, 20, etc.), where some see an allusion to the Egyptian custom of bringing a bottle of hay when they consulted Apis (Gudwyn's *Mos. and Aar.* iv, 5). Yet these terms of scorn are rather due to the intense hatred of the Jews both to this idolatry and that of Jeroboam. Thus, in *1ob.* i, 5, we have one of Jeroboam's calves called "the heifer Baal" (ἡ δάμαλις Βάαλ), which is an unquestionable calumny; just as in the Sept. version of *Jer.* xvi, 15, "Apis, the chosen calf" (Ἄπις ὁ μύσχος σου ὁ ἐκλεκτός), is either a mistake or a corruption of the text (Bochart, *Hieroz.* ii, 28, 6, and Schleusner, s. v. Ἀπίς). See APIS.

5. According to others, the Jews in these cases simply adopted a well-known cherubic emblem, merely applying it as a symbol of Jehovah. See CHERUB. In support of this position it may be urged, 1. That it is obvious they were aware of this symbol, since Moses finds it unnecessary to describe it (*Exod.* xxxv, 18-22). 2. Josephus seems to imply that the calf symbolized God (*Ant.* viii, 8, 4). 3. Aaron, in proclaiming the feast (*Exod.* xxxii, 6), distinctly calls it a feast to Jehovah, and speaks of the god as the visible representation of Him who had led them out of Egypt. 4. It was extremely unlikely that they would so soon adopt a deity whom they had so recently seen humiliated by the judgments of Moses (*Num.* xxxiii, 4). 5. There was only one Apis, whereas Jeroboam erected two calves (but see Jahn, *Bibl. Arch.* § 464). 6. Jeroboam's well-understood political purpose was, not to introduce a new religion, but to provide a different form of the old, and this alone explains the fact that this was the only form of idolatry into which Judah never fell, since she already possessed the archetypal emblems in the Temple. 7. It appears from 1 Kings xii, 6, etc., that the prophets of Israel, though sanctioning the calf-worship, still regarded themselves, and were regarded, as "prophets of Jehovah." See GOLDEN CALF.

Calhoun, THOMAS P., a Cumberland Presbyterian minister, was born in Wilson county, Tenn., in 1823, studied theology in the seminary at Princeton, N. J., and was ordained in 1852. He was secretary for several years of the Board of Foreign and Domestic Missions of the Cumberland Presbyterian Church, and editor of the *Missionary*, a periodical of the Church. In the winter of 1858, while riding out, his horse became unmanageable, and running off a bridge, Mr. Calhoun was killed instantly.—Wilson's *Presbyt. Ann.* for 1860.

Caligula (so called from *caliga*, the foot-dress of a common soldier, which he wore while his father was in the camp in Germany), properly CAIUS CÆSAR, the third of the series of Roman emperors, was the youngest son of Germanicus, the nephew of Tiberius, by Agrippina. He was born Aug. 31, A. D. 12 (Suetonius, *Claud.* 8), and, after spending his youth among the soldiers in Germany (*Tacitus, Ann.* i, 41, 69; *Dio Cass.* lvi, 5), he was received into favor by Tiberius after the fall of Sejanus (A. D. 32), although his mother and brothers had been disgraced by that tyrant, whom he succeeded as emperor in March, A. D. 37. See TIBE-

RIUS. He is frequently mentioned (under the simple name "Caius") by Josephus, who speaks of his restoration of Agrippa I to his Jewish dominions (*Ant.* xviii, 7, 10) among the few acts of liberality that characterized the first months of his reign. After his recovery from illness, however, which his excesses had brought upon him, he gave way to his naturally brutal temper in so violent and irrational a manner as to be evidence of downright insanity, and was at length assassinated Jan. 24, A. D. 41. It does not appear that he molested the Christians. He commanded Petronius, governor of Syria, to place his statue in the Temple at Jerusalem for the purpose of adoration; but the Jews so vigorously opposed it that, fearing a sedition, he suspended the order (*Josephus, Ant.* xvii, 8). See Smith's *Dict. of Class. Ant.* s. v.; Conybeare and Howson's *St. Paul*, i, 110, 111.



Coin of Caligula, with his Head and that of Augustus (the latter crowned).

Cal'itas (Καλιτάς and Καλίρας), given as the name of one of the Levites who had taken foreign wives after the restoration from Babylon (1 Esdr. ix, 23, where he is also called COLIUS), and who assisted in expounding the law to the people (ver. 48); evidently the ΚΕΛΙΤΑ (q. v.) of the genuine texts (*Ezra* x, 28; *Neh.* viii, 7).

Calixtines (I). In the year 1420, the Hussites divided into two great factions, the Taborites and the Calixtines. The latter, who derived their name from the chalice (*calix*), asserted that communion in both kinds was essential to the sacrament. They are not generally ranked by Romanists among heretics, for many of them were persuaded by the concessions of the Council of Basle, in 1438, to be reconciled to the Roman pontiff. The reformation they aimed at extended principally to four articles: 1. To restore the cup to the laity. 2. To subject criminal clergymen to the civil magistrate. 3. To strip the clergy of their lands, lordships, and all temporal jurisdictions. 4. To grant liberty to all priests to preach the Word of God.—Mosheim, *Ch. Hist.* ii, 459; Farrar, *Eccles. Dict.* s. v. See BOHEMIA; HUSSITES.

(II.) Followers of George Calixtus. See CALIXTUS, GEORGE.

Calixtus I (or CALLISTUS), Pope, the son of Dionysius, and a Roman, succeeded Zephyrinus in 217 or 220. According to the *Acta Martyrum*, he was put to death by being drowned in a well, after suffering a long imprisonment, Oct. 14, 222, or Oct. 12, 223, but the story is doubtful. He was succeeded by Urban I. The new MS. of Hippolytus calls him a "heretic," a "servile and deceitful profligate, and an embezzler." In doctrine, according to Hippolytus, Calixtus was a Nöbian, or worse; in practice, a violator both of the ecclesiastical and the moral law. And yet he is a saint of the Romish calendar! He is said to have built the basilica of St. Mary *Trans Tiberim*, and the cemetery on the Appian Way now called the catacomb of St. Sebastian (where 174,000 martyrs are said to lie buried).—Ughellus, *Italia Sacra*, vol. i.; *Biog. Univ.*; *Math. Qu. Rev.* 1851, p. 649; Schaff, *Hist. of Christian Church*, i, 291, 447. See HIPPOLYTUS.

II, Pope, son of Guillaume, count of Burgundy, was made archbishop of Vienne in 1088, and elected pope Feb. 1, 1119, while in retirement at Cluny. He was judged likely to compose the troubles about investiture, which had agitated the Church for fifty years; and even Henry V appeared to join in the general satisfac-

tion. At the council held at Rheims in 1119 nothing, however, could be concluded to effect a reconciliation between Henry and the pope, and the former was formally excommunicated. In 1122, at the Diet of Worms (Sept. 28), an accommodation was agreed upon between the two parties, the emperor reserving to himself his right of giving to the elect the investiture of the regalia, while the pope, on his part, conferred the investiture by the cross and ring. In 1120 Calixtus returned to Rome, and re-established the papacy there. In 1123 he held a Lateran council, in which the edicts of the anti-pope Gregory VIII were annulled. He died Dec. 12, 1124.—Moesheim, *Ch. Hist.* cent. xii, pt. ii, ch. ii, § 5, 6; Landon, *Ecol. Dict.* ii, 494.

III, Pope, a Spaniard of Valencia, named Alphonso Borgia, who was elevated to the papacy April 8, 1455. He granted a commission to review the proceedings on the trial of Joan of Arc, which decided that she died a martyr for her religion and country. Calixtus did not canonize her, but permitted the celebration of certain expiatory ceremonies at her tomb. Calixtus made base use of his pontificate for the aggrandizement of his own nephews (or sons?), the Borgias. He proclaimed a crusade, collected immense sums, and sent an expedition against the Turks, which failed. He died Aug. 6, 1458.—Landon, *Ecol. Dict.* ii, 494.

Calixtus, GEORGE, perhaps the most independent and influential of the Lutheran divines of his age, was born at Medelbye (or Flensburg?), Schleswig, 1586. His proper name was Kallisoñ; his father was pastor at Medelbye. George was first taught by his father, then went to school at Flensburg, and finally studied at the University of Helmstädt, 1603-1607. After thorough culture, especially in the Aristotelian philosophy and in theology, he travelled into England and France on literary journeys (1609-13). On his return to Germany in 1614 he was appointed divinity professor at Helmstädt. The thesis of his inaugural was that kingdoms and states cannot safely coexist with the religion of Papists or Jesuits. For nearly half a century he led a life of unwearied literary activity at Helmstädt. Peaceful himself, the aim of his studies and efforts was to settle the disputes of the Christian parties, and it led him into endless controversies. Though a Lutheran all his life, his tendencies were Melancthonian, both by nature and education. "He had adopted the opinion of the peace-makers and Remonstrants that the essential doctrines of Christianity were held by all the churches, and desired to propagate this opinion, and to bring the adherents of all the churches to some nearer understanding." He wrote against all exclusive claims in any of the churches. Against Rome he wrote *De Pontif. Messis Sacrificio* (Franf. 1614); and numerous other publications to the same end followed it. In the Calvinistic doctrine he objected to predestination and the Calvinistic view of the Eucharist; but he did not hold these errors to be fundamental (*De Præcipuis Christ. Relig. Capitibus* [Helmstädt, 1618]); nor did rigid Lutheranism find any more favor with him, and he especially rejected the doctrine of the ubiquity of the body of Christ. His first publications gave umbrage to the strict Lutherans, who regarded him as lax in theology. In 1619 he published his *Epitome Theologiae*, which was warmly welcomed by his friends, but awakened new opponents among the rigidly orthodox. He applied Aristotle's philosophy to theology, dividing the science into three heads: (1) the *object*, man's best good, including holiness, immortality, etc.; (2) the *subject*, God, creation, apostasy, etc.; (3) the *means*, grace, redemption, the sacraments, etc. He also, in his *Epit. Theologiae Moralis* (1634), separated theology from ethics, giving the latter the form of an independent science. On this Dr. Pusey remarks, in his *Theology of Germany*, p. 84, that "the separation by Calixtus of the system of 'Christian moral' from 'Christian doctrine,' with which it had been hitherto interwoven, though in itself greatly to the advantage of the unity

of the latter science, seems to have produced at the time no effect but that of extinguishing even the sense of the necessity of presenting it in a form influential upon the Christian life." The very titles of his writings and those of his opponents would fill pages. His liberal views were styled Crypto-Papism, Philippism, Crypto-Calvinism, Babelism, and many other hard names, ending with Atheism. Especially after the Colloquy of Thorn, 1645, where he showed a strong disposition to compromise all minor differences in order to bring about a reunion of Lutherans, Reformed, and Romanists, the opposition of the high orthodox party to him and to the Helmstädt theologians, who were more or less imbued with his Syncretism, increased. See THORN, COLLOQUY OF. His followers were known both as *Syncretists* and *Calixtines*. The chief objection brought against him by the more candid of his opponents was that he maintained, 1. That the fundamental doctrines of Christianity, by which he meant those elementary principles whence all its truths flow, were preserved pure in all three communions (Romish, Lutheran, and Calvinistic), and were contained in that ancient form of doctrine known by the name of the Apostles' Creed. 2. That the tenets and opinions which had been constantly received by the ancient doctors during the first five centuries were to be considered as of equal truth and authority with the express declarations and doctrines of Scripture. 3. That the churches which received these points, and "held the additional tenets of the particular churches as non-essential, should at once come into peaceful relations, and thus pave the way for a future union of the churches." His opponents were legion, but the most bitter and persevering was Calovius (q. v.). Calixtus died March 19, 1656. A full list of his writings is given in his *Consultatio de tolerantia Reformatorum* (Helmst. 1697, 4to). An account of Calixtus, from the Puseyite stand-point, is given in the *Christian Remembrancer*, 1856, art. 1. See also Gasz, *Georg Calixtus u. d. Syncretismus* (Bresl. 1846); Gieseeler, *Ch. History*, pt. iv, div. i, ch. iv; Henke, *Calixtus u. s. Zeit* (1855-56, 2 vols. 8vo); *Bibliotheca Sacra*, April, 1865, art. vi; Mosheim, *Ch. History*, cent. xvii, sec. ii, pt. ii, ch. i; Dowling, *Life and Corr. of G. Calixtus* (Lond. 1863); Gass, *Prot. Dogmatik*, ii, 68. See SYNCRETISM.

Calker (בָּרֵק מַכְרֵם, *machalik' be' dek*, a repairer of the breach, as in 2 Kings xii, 8; xxii, 5; Sept. and Vulg. translate at random, οὐροί ενίοχου ρην βορλιν, *habuerunt nauitas ad ministerium variaz suppellectilis*), a workman skilled in stopping the seams of the deck or sides of a vessel, which appears to be the correct idea of the passages (Ezek. xxvii, 9, 27) where the inhabitants of Gebal (or Byblus) are said to have been employed in this capacity on the Tyrian vessels. See TYRE; NAVIGATION.

Call (usually קָרָה, *kara'*, *kallos*, both which words evidently contain the same root as their Engl. equivalent) signifies (besides its use in giving a name), i. To cry to another for help, and hence to pray. The first passage in which we meet with this phrase is in Genesis iv, 26, "Then began men to call upon the name of the Lord" (אָז הִזְבַּח לְקֶרֶה בְּשֵׁם יְהוָה, Sept. and Vulg. understand the first word as a pronoun referring to Enos, οὐτος ἔλασεν ἐπικαλεῖσθαι τὸ ὄνομα τοῦ Θεοῦ, *iste cepit invocare nomen Domini*), a phrase that has been understood by some as meaning that Jehovah's worshippers were then called by *His name*, but erroneously (comp. Gen. xii, 8; Psa. lxxix, 6; cv, 1; Isa. lxiv, 6; Jer. x, 25; Zeph. iii, 9). In both the Old and New Test., to call upon the name of the Lord imports invoking the true God in prayer, with a confession that He is Jehovah; that is, with an acknowledgment of his essential and incommunicable attributes. In this view the phrase is applied to the worship of Christ (Acts ii, 21; vii, 59; ix, 14; Rom. x, 12; 1 Cor. i, 2). See WORSHIP.

II. DIVINE CALL. (I.) The word "call" is used in Scripture with various significations, as applied to the Almighty with respect to men. 1. In its ordinary sense of "to name," to "designate" (of which examples are not necessary), and also in the sense of "to be," e. g. "He shall be called the Son of God" (Luke i, 35); "His name shall be called Wonderful" (Isa. ix, 6); that is, he shall be the Son of God, he shall be wonderful, and shall be thus acknowledged. 2. In the designation of individuals to some special office or function, e. g. the call of Bezaleel (Exod. xxxi, 2); the calling of the judges, prophets, etc. (e. g. Isa. xxii, 20; Acts xiii, 2). 3. In the designation of nations to certain functions, privileges, or punishments (Lam. ii, 22; Isa. v, 26), especially of Israel to be God's chosen people (Deut. vii, 6-8; Isa. xli, 9; xlii, 6; xliii, 1; xlvi, 12-15; li, 2; Hos. xi, 1). 4. To denote the invitation to sinners to accept the grace of God in the gift of His Son (Matt. ix, 13; xi, 28; xxii, 4; Luke xiv, 16, 17). 5. To denote the extent of the divine invitation, to Gentiles as well as Jews, showing the universality of the call (Rom. ix, 24, 25). 6. To denote a condition in life (1 Cor. vii, 20, etc.).

(II.) Two questions arise as to the divine call to men. (1.) Why do not all who receive it embrace it? and (2.) Why have not all mankind even yet had the invitation? In view of these questions, the old Lutheran divines speak of the *vocatio ordinaria directa* (the ordinary direct call) as being, 1. *Serius*, i. e. really meant as a call on God's part, as he desires and intends the salvation of all. This is opposed to the Calvinistic view, which maintains that only such as are predestined to salvation are really called. 2. *Efficax*, or better *Sufficiens*, i. e. always adequate to the conversion, not only of those who heed the call, but of those who disregard it; and therefore, 3. *Resistibilis*, resistible, and not compulsory (Quenstedt, *Theol. Did.* iii); and also, 4. *Universalis*, universal. God called all the human race (1.) in the promise of Christ to bruise the serpent's head (Gen. iii, 15), given to the race through our first parents; (2.) in Noah, the preacher of righteousness, a call to all his descendants (Gen. ix, 9; 2 Pet. ii, 5); (3.) in the Gospel commission (Matt. xxviii, 19; Mark xvi, 15; comp. Rom. x, 18; Col. i, 6; Acts xvii, 80). The commission extended to "all the world," and its execution is declared to have been accomplished in Acts xvii, 30; Rom. x, 18; Col. i, 6, 23. The question whether even America was reached by the first preaching of Christianity is treated by Moevius in his essay entitled *An ab Apostolis Evangelium etiam Americam fuerit Annuntiatum*. And where the *ἀποστολή* did not go, the *ἐκποστολή* did. As to the failure of men to receive and obey the divine call, it is not God's fault, but their own. He "calls," but they "will" not. In general, it may be assumed that wherever the Church of God is set up, men receive the divine call, and their responsibility is proportional to the degree of light which shines upon them (Matt. xi, 20-24; xxiii, 37; Luke xii, 47, 48). The same principle applies to the case of heathen. Here also lies the duty of the Church to send missions to the heathen.

(III.) The Calvinistic doctrine of *effectual calling* is thus set forth in the *Westminster Confession*:

"1. All those whom God hath predestinated unto life, and those only, he is pleased, in his appointed and accepted time, effectually to call, by his Word and Spirit, out of that estate of sin and death in which they are by nature, to grace and salvation by Jesus Christ; enlightening their minds spiritually and savingly to understand the things of God; taking away their heart of stone, and giving unto them a heart of flesh; renewing their wills, and by his *Almighty power determining them to that which is good*; and effectually drawing them to Jesus Christ, yet so as they come most freely, being made willing by his grace.

"2. This effectual call is of God's free and special grace alone, not from any thing at all foreseen in man,

who is altogether passive therein, until, being quickened and renewed by the Holy Spirit, he is thereby enabled to answer this call, and to embrace the grace offered and conveyed in it.

"8. Elect infants, dying in infancy, are regenerated and saved by Christ through the Spirit, who worketh when, and where, and how he pleaseth. So also are all other elect persons, who are incapable of being outwardly called by the ministry of the Word.

"4. Others not elected, although they may be called by the ministry of the Word, and may have some *common operations* of the Spirit, yet they never truly come unto Christ, and therefore cannot be saved; *much less can men not professing the Christian religion be saved in any other manner whatsoever, be they ever so diligent to frame their lives according to the light of nature, and the law of that religion they do profess; and to assert and maintain that they may is very pernicious, and to be detested.*"

The scriptural arguments for and against the doctrine are thus stated by Watson:

1. According to the Calvinistic view, "in the golden chain of spiritual blessings which the apostle enumerates in Rom. viii, 30, originating in the divine predestination, and terminating in the bestowment of eternal glory on the heirs of salvation, that of calling forms an important link. 'Moreover, whom he did predestinate, them he also called; and whom he called, them he also glorified.' Hence we read of 'the called according to his purpose,' Rom. viii, 28. There is indeed a universal call of the Gospel to all men; for wherever it comes it is the voice of God to those who hear it, calling them to repent and believe the divine testimony unto the salvation of their souls; and it leaves them inexcusable in rejecting it (John iii, 14-19); but this universal call is not inseparably connected with salvation; for it is in reference to it that Christ says, 'Many are called, but few are chosen' (Matt. xxii, 14). But the Scripture also speaks of a calling which is effectual, and which consequently is more than the outward ministry of the Word; yea, more than some of its partial and temporary effects upon many who hear it, for it is always ascribed to God's making his word effectual through the enlightening and sanctifying influences of his Holy Spirit. Thus it is said, 'Paul may plant, and Apollos water, but God giveth the increase' (1 Cor. iii, 6, 7). Again, He is said to have 'opened the heart of Lydia, that she attended to the doctrine of Paul' (Acts xvi, 14). 'No man can come unto Christ, except the Father draw him' (John vi, 44). Hence faith is said to be the gift of God (Eph. ii, 8; Phil. i, 29). The Spirit takes of the things of Christ and shows them to men (John xvi, 14), and thus opens their eyes, turning them from darkness to light, and from the power of Satan unto God (Acts xxvi, 18). And so God saves his people, not by works of righteousness which they have done, but according to his mercy, by the washing of regeneration and renewing of the Holy Spirit (Titus iii, 5). Thus they are saved, and called with a holy calling, not according to their works, but according to the divine purpose and grace which was given them in Christ Jesus before the world began (2 Tim. i, 9).

"2. To this it is replied that this whole statement respecting a believer's calling is without any support from the Scriptures. 'To call' signifies to invite to the blessings of the Gospel, to offer salvation through Christ, either by God himself, or, under his appointment, by his servants; and in the parable of the marriage of the king's son (Matt. xxii, 1-14), which appears to have given rise, in many instances, to the use of this term in the epistles, we have three descriptions of 'called' or invited persons. (1.) The disobedient, who would not come in at the call, but made light of it. (2.) The class of persons represented by the man who, when the king came in to see his guests, had not on the wedding garment, and with respect to whom

our Lord makes the general remark, 'For many are called, but few are chosen;' so that the persons thus represented by this individual culprit were not only 'called,' but actually came into the company. (3.) The approved guests—those who were both called and chosen. As far as the simple calling or invitation is concerned, all stood upon equal ground—all were invited; and it depended upon their choice and conduct whether they embraced the invitation and were admitted as guests. We have nothing here to countenance the notion of what is termed 'effectual calling.' This implies an irresistible influence exerted upon all the approved guests, but withheld from the disobedient, who could not, therefore, be otherwise than disobedient, or, at most, could only come in without that wedding garment, which it was never put into their power to take out of the king's wardrobe, and the want of which would necessarily exclude them, if not from the Church on earth, yet from the Church in heaven. The doctrine of Christ's parables is in entire contradiction to this notion of irresistible influence; for they who refused and they who complied but partially with the calling are represented, not merely as being left without the benefit of the feast, but as incurring additional guilt and condemnation for refusing the invitation. It is to this offer of salvation by the Gospel, this invitation to spiritual and eternal benefits, that St. Peter appears to refer when he says, 'For the promise is unto you and to your children, and to all that are afar off, even as many as the Lord our God shall call' (Acts ii, 89); a passage which declares 'the promise' to be as extensive as the 'calling,' in other words, as the offer or invitation. To this also St. Paul refers (Rom. i, 5, 6), 'By whom we have received grace and apostleship, for obedience to the faith among all nations, for his name;' that is, to publish his Gospel, in order to bring all nations to the obedience of faith; 'among whom ye are also the called of Jesus Christ;' you at Rome have heard the Gospel, and have been invited to salvation in consequence of this design. This promulgation of the Gospel, by the personal ministry of the apostle, under the name of *calling*, is also referred to in Gal. i, 6, 'I marvel that ye are so soon removed from him that called you into the grace of Christ,' obviously meaning that it was he himself who had called them, by his preaching, to embrace the grace of Christ. So also in chap. v, 13, 'For, brethren, ye have been called unto liberty.' Again (1 Thess. ii, 12), 'That ye would walk worthy of God, who hath called you,' invited you, 'to his kingdom and glory.'

"8. In our Lord's parable it will also be observed that the persons called are not invited as separate individuals to partake of solitary blessings; but they are called to 'a feast,' into a company or society, before whom the banquet is spread. The full revelation of the transfer of the Visible Church of Christ from Jews by birth to believers of all nations, was not, however, then made. When this branch of the evangelic system was fully revealed to the apostles, and taught by them to others, that part of the meaning of our Lord's parable which was not at first developed was more particularly discovered to his inspired followers. The calling of guests to the evangelical feast, we then more fully learn, was not the mere calling of men to partake of spiritual benefits, but calling them also to form a spiritual society composed of Jews and Gentiles, the believing men of all nations, to have a common fellowship in these blessings, and to be formed into this fellowship for the purpose of increasing their number, and diffusing the benefits of salvation among the people or nation to which they respectively belonged. The invitation, 'the calling,' of the first preachers was to all who heard them in Rome, in Ephesus, in Corinth, and other places; and those who embraced it, and joined themselves to the Church by faith, baptism, and continued public profession, were named, especially

and eminently, 'the called,' because of their obedience to the invitation. They not only put in their claim to the blessings of Christianity individually, but became members of the new Church, that spiritual society of believers which God now visibly owned as his people. As they were thus called into a common fellowship by the Gospel, this is sometimes termed their 'vocation,' as the object of this Church state was to promote 'holiness,' it is termed a 'holy vocation,' as sanctity was required of the members, they were said to have been 'called to be saints;' as the final result was, through the mercy of God, to be eternal life, we hear of 'the hope of their calling,' and of their being 'called to his eternal glory by Christ Jesus.'

"4. These views will abundantly explain the various passages in which the term *calling* occurs in the epistles: 'Even us whom he hath called, not of the Jews only, but also of the Gentiles' (Rom. ix, 24); that is, whom he hath made members of his Church through faith. 'But unto them which are called, both Jews and Greeks, Christ the power of God and the wisdom of God;' the wisdom and efficacy of the Gospel being, of course, acknowledged in their very profession of Christ, in opposition to those to whom the preaching of 'Christ crucified' was 'a stumbling-block' and 'foolishness' (1 Cor. i, 24). 'Is any man called (brought to acknowledge Christ, and to become a member of his Church), 'being circumcised? let him not become uncircumcised. Is any called in uncircumcision? let him not be circumcised' (1 Cor. vii, 18). 'That ye walk worthy of the vocation wherewith ye are called. There is one body and one Spirit, even as ye are called in one hope of your calling' (Eph. iv, 1, 4). 'That ye would walk worthy of God, who hath called you to his kingdom and glory' (1 Thess. ii, 12). 'Through sanctification of the Spirit, and belief of the truth, wherunto he called you by our Gospel, to the obtaining of the glory of our Lord Jesus Christ' (2 Thess. ii, 13, 14). 'Who hath saved us and called us with a holy calling; not according to our works, but according to his own purpose and grace, which was given us in Christ Jesus before the world began, but is now made manifest by the appearing of our Saviour Jesus Christ' (2 Tim. i, 9, 10). On this passage we may remark that the 'calling' and the 'purpose' mentioned in it must of necessity be interpreted to refer to the establishment of the Church on the principle of faith, so that it might include men of all nations; and so, as formerly, be restricted to natural descent. For personal election and a purpose of effectual personal calling could not have been hidden till manifested by the 'appearing of Christ,' since every instance of true conversion to God in any age prior to the appearing of Christ would be as much a manifestation of eternal election, and an instance of personal effectual calling, according to the Calvinistic scheme, as it was after the appearance of Christ. The apostle is speaking of a purpose of God, which was kept secret till revealed by the Christian system; and from various other parallel passages we learn that this secret, this 'mystery,' as he often calls it, was the union of the Jews and Gentiles in 'one body,' or Church, by faith.

"5. In none of these passages is the doctrine of the exclusive calling of a set number of men contained; and the Synod of Dort, as though they felt this, only attempt to infer the doctrine from a text already quoted, but which we will now more fully notice: 'Whom he did predestinate, them he also called; and whom he called, them he also justified; and whom he justified, them he also glorified' (Rom. viii, 30). This is the text on which the Calvinists chiefly rest their doctrine of effectual calling; and tracing it, as they say, through its steps and links, they conclude that a set and determinate number of persons having been predestinated unto salvation, this set number only are called effectually, then justified, and finally glorified. But this passage was evidently nothing to the purpose,

unless it had spoken of a set and determinate number of men as predestinated and called, independent of any consideration of their faith and obedience, which number, as being determinate, would, by consequence, exclude the rest. The context declares that those who are foreknown, and predestinated to eternal glory, are true believers, those who 'love God,' as stated in a subsequent verse; for of such only the apostle speaks; and when he adds, 'Moreover, whom he did predestinate, them he also called, and whom he called, them he also justified, and whom he justified, them he also glorified,' he shows in particular how the divine purpose to glorify believers is carried into effect through all its stages. The great instrument of bringing men to 'love God' is the Gospel; they are, therefore, called, invited by it, to this state and benefit; the calling being obeyed, they are justified; and being justified, and continuing in that state of grace, they are glorified. Nothing, however, is here said to favor the conclusion that many others who were called by the Gospel, but refused, might not have been justified and glorified as well as they; nothing to distinguish this calling into common and effectual; and the very guilt which those are every where represented as contracting who despised the Gospel calling shows that they reject a grace which is sufficient, and sincerely intended, to save them."—Watson, *Institutes*, ii, 352 sq.; Herzog, *Real-Encyclopädie*, ii, 104; Nitzsch, *Christliche Lehre*, § 141; Warren, *Systemat. Theologie*, p. 147.

III. A call to the ministry of the Gospel is regarded by Christians generally as proceeding from God; and the Church of England, the Protestant Episcopal Church, and the Methodist Episcopal Church, require of candidates for ordination an express profession that they trust they are so moved of the Holy Ghost. See MINISTRY.

IV. MINISTERIAL CALL is an invitation on the part of a congregation to a preacher to become their settled pastor. See INSTALLATION.

Callenberg, JOHANN HEINRICH, was born January 12, 1694, in Saxe-Gotha. He studied at Halle, giving special attention to the Oriental languages, to which he was originally led by becoming a member of the *Collegium Orientale Theologicum*, which was established at Halle in 1702. He had for special tutor Solomon Negri, a learned Orientalist from Damascus. He was appointed professor (*extraord.*) of philosophy in 1727, and professor (*ordina.*) of theology in 1739. He became deeply interested in Protestant missions to the East, especially among the Jews and Mohammedans. In 1728 he organized a school for the education of missionaries; and he afterward established, at his own expense, a printing-office for the publication of works in German, Arabic, and Hebrew for the furtherance of the missionary cause. His students went out over Europe as missionaries to the Jews, and some of them even to Asia and Africa. He printed in Arabic portions of the O. T., the whole of the N. T., Luther's *Shorter Catechism*, the *Imitation of Jesus Christ* (somewhat curtailed), portions of Grotius on the *Truth of the Christian Religion*, the *Elements of the Arabic Language*, and other works for the use of missionaries in the East. With a view to the conversion of the Jews, he wrote a *Kurze Anleitung zur Jüdisch-Teutschen Sprache* (Short Introduction to the Speech of the German Jews, 8vo, 1738), to which he added in 1786 a short dictionary of the corrupt Hebrew spoken among themselves by the Jews of Germany. In 1728-36 he published *Berichte von einem Versuch das Jüdische Volk zur Erkenntnis des Christlichen anzuleiten* (8 vols. 8vo); in 1733, *De Conversione Muhammedanorum ad Christum exposita tentatiqne* (12mo). He continued writing, translating, and printing a variety of works useful for the missionaries till his death, which occurred at Halle, July 16, 1760. The mere list of his publications would fill a column, but they are not of sufficient scientific value to require enumeration here. But the name of

Callenberg deserves always to be cherished in the Christian Church as that of one of the founders of Protestant missions, and of a devoted and self-sacrificing laborer in that cause.—Doering, *Die Gelehrten Theologen Deutschlands*, i, 221 sq.; Hofer, *Novæ Biographiæ Gmralis*, vii, 202; Ersch und Gruber, *Allgemeine Encyclopädie*, s. v.

Callender, Elisha, minister of the first Baptist church in Boston, was the son of Ellis Callender, who officiated as pastor of the First Baptist church in Boston for many years, dying about 1726, at about eighty years of age. The son, Elisha, was born in Boston, and graduated as bachelor of arts at Harvard College in 1710. He was baptized and admitted to church membership August 10, 1718, and was ordained as a Baptist minister May 21, 1718, and Drs. Increase and Cotton Mather and Mr. Webb, though of a different denomination, gave their assistance. It is said that Thomas Hollis (a Baptist) was so impressed by this catholic procedure when he heard of it in England, that he made his well-known benefactions to Harvard College in consequence. Mr. Callender abounded in labors not only in Boston, but throughout the commonwealth, till his death, March 31, 1788. He was the first American Baptist minister who had received a college education.—Sprague, *Annals*, vi, 84; Allen, *Biographical Dict.* s. v.

Callender, John, an eminent Baptist minister, nephew of Elisha Callender, was born about 1706, and graduated at Harvard College in 1728. He was ordained colleague with Mr. Peckham as pastor of the church at Newport, Oct. 13, 1731. Here he labored usefully for seventeen years, and died Jan. 26, 1748. He collected many papers relating to the history of the Baptists in this country, which were used by Backus. He published a *Historical Discourse on Rhode Island and Providence Plantations* (1789); also a *Sermon on the Ordination of Jeremiah Comdy* (1789); and a *Sermon on the Death of Mr. Clap, of Newport* (1745).—Sprague, *Annals*, vi, 87; Allen, *Biographical Dictionary*, s. v.

Calling (κλησις, *vocatio*), a term used in theology to designate the divine invitation to man to share in the gift of salvation. See CALL.

Callirrhōē (Καλλιρρόη, *beautiful stream*), the name given to certain warm springs on the eastern side of the Jordan, not far from, and flowing into, the Dead Sea, to which Herod the Great resorted during his last illness, by the advice of his physicians (Josephus, *Ant.* xvii, 6, 5). The same are probably meant by the *yeimim* (יַעַיִם, *Auth. Vers.* "mules") of Gen. xviii, 24. See ANAH. Pliny (v, 16) also describes them ("callidus fons medicus saluberrimus") as possessing medicinal properties (Reland, *Palaest.* p. 302, 378). In May, 1818, these springs were visited by Irby and Mangles. Of the valley of Callirrhōē they say (*Travels*, p. 467-469): "The whole bottom is filled, and in a manner choked up, with a crowded thicket of canes and aspens of different species, intermixed with the palm, which is also seen rising in tufts in the recesses of the mountain's side in every place whence the springs issue. In one place a considerable stream of hot water is seen precipitating itself from a high and perpendicular shelf of rock, which is strongly tinted with the brilliant yellow of sulphur deposited upon it. On reaching the bottom, we found ourselves at what may be termed a hot river, so copious and rapid is it, and its heat so little abated. For some way the temperature is kept up by the constant supplies of water that flow into the river. In order to visit these sources in succession, we crossed over to the right bank, and, ascending by the mountain side, we passed four abundant springs, all within the distance of half a mile, discharging themselves into the stream at right angles with its course. We judged the distance from the Dead Sea, by the ravine, to be about one hour and a half. Maclean says there was a city

of the same name in the valley of Callirrhōs, in which we think he must be wrong, since there is not space for a town in the valley as far as we saw it. That Herod must have had some lodging when he visited these springs is true, and there are sufficient remains to prove that some sort of buildings have been erected." According to Josephus, the fortress of Machærus, which was rebuilt by Herod, was upon this hot-water stream, and not far from the fountains. It is supposed that John the Baptist was imprisoned and beheaded in this fortress, and that the feast was also made at Machærus, which, besides being a strong-hold, was also a palace, built by Herod the Great, and that Herod himself was now on his route toward the territory of Aretas, with whom he was at war. The ruins of this fortress still exist (Josephus, *Ant.* xvii, 6, 5; xviii, 5, 2; *War.* i, 88, 5). The Zurka Main, which empties itself into the Dead Sea, visited and described by Seetzen (*Reise*, ii, 886 sq.), is described as a sweet and thermal stream, and is doubtless the outlet of the hot streams of Callirrhōs (Ritter, *Erdk.* xv, 572, 573). Lieut. Lynch, who explored it in 1848, says: "The stream, twelve feet wide and ten inches deep, rushes in a southerly direction with great velocity into the sea. Temperature of the air, 70°; of the sea, 78°; of the stream, 94°; one mile of the chasm, 95°. It was a little sulphureous to the taste. The stream has worn its bed through the rock, and flows between the perpendicular sides of the chasm, and through the delta, bending to the south, about two furlongs, to the sea. The banks of the stream along the delta are fringed with canes, tamarisks, and the castor-bean. The chasm is 122 feet wide at the mouth, and for one mile up, as far as we traced it, does not lessen in width. The sides of the chasm are about eighty feet high where it opens upon the delta, but within they rise in altitude to upward of 150 feet on each side, where the trap formation is exhibited. In the bed of the chasm there was one stream, on the south side, eight feet wide and two deep, and two small streams in the centre, all rushing down at the rate of six knots per hour. There were no boulders in the bed of the ravine, which in the winter must, throughout its width and high up the sides, pour down an impetuous flood. The walls of the chasm are lofty and perpendicular, of red and yellow sandstone, equally majestic and imposing, but not worn in such fantastic shapes nor of so rich a hue as those of the Arnon. Waded up about a mile, and saw a few date-palm-trees growing in the chasm. The turns about 200 yards apart, at first gently rounded, but subsequently sharp and angular. There was a succession of rapids, and a cascade of four, and a perpendicular fall of five or six feet. A little above the rapid trap shows over sandstone. The current was so strong that, while bathing, I could not, with my feet against the rock, keep from being carried down the stream; and, walking where it was but two feet deep, could with difficulty retain a foothold with my shoes off. At 7 P.M., bathed first in the sea and afterward in the stream—a most delicious transition from the dense, acrid water of the sea, which made our innumerable sores smart severely, to the soft, tepid, and refreshing waters of the Callirrhōs" (*Expédition*, p. 371). See also LASSA.

Callis'thenes (Καλλισθένης, a frequent Greek name), a partisan of Nicanor, who was burnt by the Jews on the defeat of that general in revenge for his guilt in setting fire to "the sacred portals" (2 Macc. viii, 88).—Smith, s. v. See NICANOR.

Callistus. See CALIXTUS I.

Calmet, AUGUSTINE, a learned Benedictine, of the congregation of St. Vannes, born at Mesnil-la-Horgne Feb. 26, 1672. He studied at Breuil, and after having pronounced the vows in Oct., 1689, he proceeded to make his course of philosophy at the abbey of St. Evre, and afterward devoted himself to Hebrew, which he studied under Fabre, a Reformed divine. In 1704 he

passed to the abbey of Munster, where he taught the young monks; and lectures which he there read to them formed the basis of his "Commentaries on the Old and New Testaments," which he wrote in Latin, but translated into French, and published in 1707 and 1716, in 23 volumes 4to. This work was followed by his *Histoire Sainte de l'Ancien et Nouveau Testament—History of the Old and New Testaments* (Paris, 1716, 2 vols. 4to), and his celebrated *Dictionary of the Bible*. In 1718 he was made abbot of St. Leopold's at Nancy, and ten years after he was removed to the abbey of Sénones, where he died (having refused a bishopric in *partibus*) Oct. 25, 1757. His *Life* was written by Fangé, his nephew (1768, 8vo), where a complete list of his numerous works will be found. The best edition (French) of the *Dictionnaire historique et critique de la Bible* is that of Paris, 1730 (4 vols. fol.). The best English editions are those of 1798 (4to, with additions) and of 1847 (edited by Taylor, 5 vols. 4to). His *Commentaire littéral sur tous les livres de l'Ancien et du Nouveau Testament* (reprinted at Paris, 1713, 26 vols. 4to, also 9 vols. fol.) was abridged, and published in 17 vols. 4to, at Avignon, 1767-1773; also translated into Latin, with the *Dissertations*, by Manse (Wirceb. 1789, 19 vols. 4to). Calmet's *Dictionary of the Bible* has, until lately, formed the basis of all subsequent works of the same kind. The best abridgment is that of Robinson, whose additions are perhaps, to the modern student, of more value than the original work.—*Biog. Univ.* vi, 559; *Landon, Eccles. Dict.* ii, 497. See DICTIONARIES (BIBLICAL).

Cal'neh (Heb. *Kalne'*, כַּלְנֶה; Sept. *Καλάνη*), the fourth of Nimrod's cities (Gen. x, 10), and probably not different from the CALNO (Heb. *Kaino'*, כַּיְנוֹ; Sept. *Καλάνη*) of Isa. x, 9, or the CANSHE (Heb. *Kanshe'*, כַּנְשֵׁה; Sept. *Κανία*) of Ezek. xxvii, 28. The word is thought to mean "the fort of the god Ana or Anu," who was one of the chief objects of Babylonian worship. According to the Chaldee translation, with which Eusebius and Jerome agree, this is the same place that was subsequently called *Ctesiphon*. It lay on the Tigris, opposite Seleucia, and was for a time the capital of the Parthians, and the winter residence of the Parthian kings (Strabo, xvi, p. 812; Cellarii *Notit.* ii, 774; see Bochart, *Phaleg*, iv, 18; Michaelis, *Spicileg.* i, 228). This opinion respecting Calneh derives some support from the circumstance that the district named Ctesiphon was called by the Greeks *Chalonitis* (Pliay, *Hist. Nat.* vi, 26, 27; Polyb. v, 44); but, on the other hand, this province does not appear to have extended so far west as Calneh must have lain. Ammianus Marcellinus (xxiii, 6, 28) states that it was the Persian king Pacorus (who reigned from A.D. 71 to 107) who changed the name of the city to Ctesiphon; but that name must have been more ancient, as it is mentioned by Polybius. In the time of the prophet Amos Calneh appears to have constituted an independent principality (Amos vi, 2; Sept. omits, v. r. *Καλάνη* or *Καλάνη*); but not long after it became, with the rest of Western Asia, a prey to the Assyrians (Isa. x, 9). About 150 years later, Calneh was still a considerable town, as may be inferred from its being mentioned by Ezekiel (xxvii, 28) among the places which traded with Tyre. We may gather from Scripture that in the eighth century B.C. Calneh was taken by one of the Assyrian kings, and never recovered its prosperity. Hence it is compared with Carchemish, Hamath, and Gath (Isa. x, 9; Amos vi, 2), and regarded as a proof of the irresistible might of Assyria. The site of Ctesiphon was afterward occupied by *El-Mada'in*, i. e. *the (two) cities*, of which the only remains are the ruins of a remarkable palace called *Tauk-kesra*, or "Arch of Khosroes," some mounds of rubbish, and a considerable extent of massive wall toward the river. (See Smith's *Dict. of Class. Geog.* s. v. Ctesiphon.)

More recent explorers have rendered it probable that

the site of Calneh is the modern *Niffer*, which was certainly one of the early capitals, and which, under the name of *Nopher*, the Talmud identifies with Calneh (see the *Yoma*). Arab traditions made Niffer the original Babylon, and said that it was the place where Nimrod endeavored to mount on eagles' wings to heaven. Similarly the Sept. speak of Calneh or Calno as "the place where the tower was built" (Isa. x, 9). Niffer is situated about sixty miles E.S.E. of Babylon, in the marshes on the left bank of the Euphrates. It has been visited and explored by Mr. Layard (*Nis. and Bab.* p. 468 sq.), and is thus described by Mr. Loftus (*Chaldea*, p. 101): "The present aspect of Niffer is that of a lofty platform of earth and rubbish, divided into two nearly equal parts by a deep channel—apparently the bed of a river—about 120 feet wide. Nearly in the centre of the eastern portion of this platform are the remains of a brick tower of early construction, the *débris* of which constitutes a conical mound rising seventy feet above the plain. This is a conspicuous object in the distance, and exhibits, when the brick-work is exposed, oblong perforations similar to those seen at Birs-Nimrud and other edifices of the Babylonian age. The western division of the platform has no remarkable feature, except that it is strewn with fragments of pottery, and other relics of a later period than the tower just alluded to. At the distance of a few hundred yards on the east of the ruins may be distinctly traced a low continuous mound, the remains probably of the external wall of the ancient city. As to the obelisk, the particular object of my visit, the Arabs positively declared that there was one, but none of them had seen it or could indicate its position on the mounds." See **CANEH**.

CAL'NO (Isa. x, 9). See **CALNEH**.

Calogéri. See **CALOVERS**.

Calovius (or **CALOV**), ABRAHAM, a celebrated Lutheran divine and controversialist, was born in 1612 at Mohrungen in Prussia. He studied at Königsberg and Rostock, and became Professor of Theology at Wittenberg, where he obtained great distinction as a lecturer and controversial theologian. He died Feb. 25, 1686. He was a violent opponent of George Calixtus, whose gentleness he by no means shared. Indeed, so bitter was Calov's zeal, that it has been said of him that "he was born for an inquisitor." He wrote with great ability against the Socinians. His most important work was his *Biblia Illustrata* (Dresden, 1719, 4 vols. fol.), which contains the whole of Grotius's *Annotations*, with severe criticisms on them. In dogmatic theology he prepared a vast *Systema Locorum Theologicorum* (1655-1677, 12 tom.). In the Syncretistic controversy (q. v.) he took the most conspicuous part. His writings are very voluminous, nearly all bitterly controversial, and now little read.—*Mosheim*, *Cl. Hist.* ii, 241; *Herzog*, *Real-Encyclop.* s. v.

Calovers or **Calogéri**. The word *Calogeri* is from the Greek (*καλόγεροι*), and means *good old men*. The name *Calovers* is of similar signification, and is generally given to the monks of the Greek Church. They are of the order of St. Basil, and consider it to be a sin to follow any other order than his. They are divided into three degrees: the novices, who are called *Archari*; the ordinary professed, called *Microchemi*; and the more perfect, called *Megalochemi*. They are likewise divided into *Cœnobites*, *Anchorites*, and *Recluses*. The *Cœnobites* are employed in reciting their offices from midnight to sunset; and as it is impossible, in so long an exercise, that they should not be overtaken with sleep, there is one monk appointed to awake them; and they are obliged to make three genuflexions at the door of the choir, and, returning, to bow to the right and left to their brethren. The *Anchorites* retire from the world, and live in hermitages in the neighborhood of the monasteries; they cultivate a little spot of ground, and never go out but on Sundays

and holidays, to perform their devotions at the next monastery. The *Recluses* shut themselves up in grottoes and caverns on the tops of mountains, which they never leave, abandoning themselves entirely to Providence. They live on the alms sent them by the neighboring monasteries. The *Calovers* have four Lenten. The first and greatest is that of the resurrection or Easter: it lasts eight weeks, and is called the *Grand Quarantain*. During this Lent the monks drink no wine; and such is their abstinence that, if they are obliged, in speaking, to name milk, butter, or cheese, they always add this parenthesis, "Saving the respect due to the holy Lent." The second Lent is that of the holy apostles, which begins eight days after Whitsunday: it generally continues three weeks, sometimes longer. During this Lent the monks are allowed to drink wine. The third Lent is that of the assumption of the Virgin: it lasts fourteen days, during which they abstain from fish, except on Sundays and on the transfiguration of our Lord. The fourth Lent is that of the Advent. The *Calovers*, in addition to the usual monkish habit, wear over their shoulders a square piece of stuff, on which are represented the cross and the other marks of Christ's passion, with these letters: IC. XC. NC. Ἰησοῦς Χριστός νικῶ, *Jesus Christ conquers*. The inscription was sometimes written thus: IC. XC. NI KA; and we find it occasionally arranged, especially on coins, in the form of a cross, thus,

IC.	XC.
NI	KA

 Visitors or exarchs are placed over them, who visit the convents only to draw from them sums of money which the patriarch demands. Yet, notwithstanding these monks are compelled to pay both to their patriarch and to the Turks, their convents are very rich. They have many monasteries in Asia, on Mount Sinai, and in Palestine; in Europe, near Athens, in Chios, and in Amourgo, one of the Sporades, also on Mount Athos. Those on Mount Athos are the most celebrated, and are twenty-three in number. There are female *Calovers*, or Greek nuns, who follow the rule of St. Basil. Their nunneries are always dependent on some monastery.—*Farrar*, *Ecol. Dict.* s. v. See **ATHOS**; **GREEK CHURCH**.

Cal'phi (ὁ Χαλφί, v. r. Χαλφεί, perhaps for *Alphaios* [q. v.], *Josephus Χαλφαίος*, *Ant.* xiii, 5, 7), father of Judas, which latter was one of the two captains (*ἀρχοντες*) of Jonathan's army who remained firm at the battle of Geneser (1 Macc. xi, 70).

Calvarista, or **MISSIONARY PRIESTS OF CALVARY**, a monastic congregation, established in 1690 by Hubert Charpentier, licentiate of the Sorbonne, on Mount Bethasam, in France, for propagating Romanism by missions. In 1688 they united with the Association for the Propagation of Faith, from which they separated again in 1650. In 1664 they were re-formed, and united with the congregation of St. Sulpice. The congregation disappeared in 1790, but arose again in 1826.

Cal'vary, a word occurring in the *Auth. Vers.* only in Luke xxiii, 38, and there not as a proper name, but arising from the translators having literally adopted the word *calvaria*, i. e. a bare skull, the Latin word by which the *cranium* of the evangelists is rendered in the Vulgate, *cranium*, again, being nothing but the Greek interpretation of the Hebrew **GOLGOTHA** (q. v.).

1. *Import of the Name*.—Many have held that Gologtha was the place of public execution, the Tyburn of Jerusalem, and that hence it was termed the "place of a skull." Another opinion is that the place took its name from its shape, being a hillock of a form like a human skull. It is true, there is no express mention of a mound in either of the narratives. See **CRUCIFIXION**. That the place, however, was of some such shape seems to be generally agreed, and the traditional term *mount*, applied to Calvary, appears to confirm this idea. Such a shape, too, it must be allowed, is in entire agreement with the name, that is,

"skull." To these considerations there are added certain difficulties which arise from the other explanation. So far as we know, there is no historical evidence to show that there was a place of public execution where Golgotha is commonly fixed, nor that any such place, in or near Jerusalem, bore the name Golgotha. Nor is the term Golgotha descriptive of such a place; to make it so, to any extent, the name should have been "skulls," or "the place of skulls." Equally unapt is the manner in which the writers of the Gospel speak of the place: Matthew calls it "a place called Golgotha; that is to say, a place of a skull;" Mark, "the place Golgotha, which is, being interpreted, the place of a skull;" Luke, "the place which is called Calvary;" John, "a place called of a skull, which is called in the Hebrew Golgotha." In truth, the context seems to show that the Roman guard hurried Jesus away and put him to death at the first convenient spot; and that the rather because there was no small fear of a popular insurrection, especially as he was attended by a crowd of people. This place, we may suppose, was not far from the judgment-hall, which was doubtless either near Fort Antonia or in the former palace of Herod. See PRÆTORIUM. In either case, the crucifixion would most naturally have occurred at the north-west of the city. Somewhere in the north, it is clear, they would execute him, as thus they would most easily effect their object. But if they chose the north, then the road to Joppa or Damascus would be most convenient, and no spot in the vicinity would probably be so suitable as the slight rounded elevation which bore the name of Calvary. That some hillock would be preferred it is easy to see, as thus the exposure of the criminal and the alleged cause of his crucifixion would be most effectually secured. Dr. Barclay is at great pains to show (*City of the Great King*, p. 78 sq.) that the vicinity of the garden of Gethsemane is the more probable location of Calvary, but his arguments are made up of a series of the most uncritical conjectures. Indeed, the very fact that of the arbitrary positions assigned by all those who (chiefly from an ultra Protestant prejudice apparently) reject the traditional site, no two agree, while all are alike destitute of any historical basis, is an important evidence in favor of the current identification. See JERUSALEM.

2. *Scriptural Notices of the Locality.*—The account in the evangelists touching the place of the crucifixion and burial of our Lord is as follows: Having been delivered by Pilate to be crucified, Jesus was led away, followed by a great company of people and women, who bewailed his fate. On the way the soldiers met one Simeon, a Cyrenian, coming out of the country, who was compelled to bear Jesus's cross. When they were come to the place which is called Calvary, there they crucified him. This place was nigh to the city; and, sitting down, they watched him there. They that passed by reviled him, wagging their heads and scoffing. Likewise also the chief priests mocked him, with the scribes and elders, and the people stood beholding. The soldiers, too, mocked him. There stood by the cross of Jesus his mother, and his mother's sister, and Mary Magdalene; and all his acquaintance, and the women that followed him from Galilee, stood afar off, beholding these things. *In the place where he was crucified there was a garden, and in the garden a new sepulchre hewn out in the rock; there laid they Jesus, and rolled a great stone to the door of the sepulchre.* The writer of the Epistle to the Hebrews adds that Jesus suffered *without the gate*, subjoining, "Let us therefore go forth to him without the camp (or the city), bearing his reproach" (Heb. xiii, 11, 13). We thus learn that the crucifixion and burial took place out of the city, and yet nigh to the city, apparently at the north-west, and probably just on the outer side of the second wall. It is also clear that the place was one around which many persons could assemble, near which wayfarers were passing, and the sufferers in which could be seen

or addressed by persons who were both near and remote; all which concurs in showing that the spot was one of some elevation, and equally proves that "this thing was not done in a corner," but at a place and under circumstances likely to make Calvary well known and well remembered alike by the foes and the friends of our Lord.

3. *Line of Tradition respecting the Spot.*—Was it likely that this recollection would perish? Surely, of all spots, Calvary would become the most sacred, the most endearing in the primitive Church. Nor did the Jew, with his warm gushing affections, feel on such a point less vividly than his fellow-men. "The tombs of the prophets," "the sepulchre of David," were, we read (Matt. xxiii, 29; Acts ii, 29), reverentially regarded and religiously preserved from age to age. That of "David's Lord" would assuredly not be neglected. It was a season of public religious festivity when our Lord suffered. Jerusalem was then crowded with visitors from foreign parts. Such, too, was the fact at the time of the effusion of the Holy Spirit. These pilgrims, however, soon returned home, and wherever they went many carried with them the news of the crucifixion of Jesus, and told of the place where he had been executed. Perhaps no one spot on earth had ever so many to remember it and know its precise locality as the place where Jesus died and rose again. First in Jerusalem, and soon in all parts of the earth, were there hearts that held the recollection among their most valued treasures. Accordingly, we learn from the passage in Hebrews that, far on in the first century, the tradition was preserved in so living a form as to be made the subject of a figurative illustration of Christian doctrine. The memory of distinguished places is among the least perishable of earthly things. Fathers would convey their knowledge and their impressions to sons; one generation and one Church to another. The passage in the Hebrews would tend to keep alive the recollection. Moreover, it was the fate of Jerusalem, after its capture by the Romans, to become a heathen city; even its name was changed into Colonia Ælia Capitolina. In the excess of their triumphant joy, the conquerors made Jupiter its patron god, and erected statues of Jupiter and Venus on the place where Jesus had been crucified (Sozomen, xi, 1). This was done perhaps not so much to insult as to conciliate. New-comers in religion have always availed themselves of established feelings, and therefore erected their sacred edifices on places already consecrated in the minds of the people. The mere fact of a temple to Venus standing on Calvary suffices to show that Calvary was the place where Jesus suffered. The temple thus takes up the tradition, and transmits it in stone and marble to coming ages. This continuation of the tradition is the more important, because it begins to operate at a time when the Christians were driven from Jerusalem. But the absence of the Christians from the Holy City was not of long duration, and even early in the third century we find pilgrimages from distant places to the Holy Land had already begun for the express purpose of viewing the spots which the presence and sufferings of the Saviour had rendered sacred and memorable (*Hist. Hierosol.*, p. 591; Euseb. *Hist. Eccles.* vi, 11). A century later, Eusebius (A.D. 315) informs us that Christians visited Jerusalem from all regions of the earth for the same object. Early in the fourth century, Eusebius and Jerome write down the tradition and fix the locality of Calvary in their writings. Eusebius was born at Cæsarea in Palestine about A.D. 270. In 315 he became a bishop in his native country, and died in 340. He was a learned man, and wrote a history of the Christian Church. About 380 he composed his *Onomasticon*, which was expressly devoted to the business of determining and recording the sites of holy and other places in Palestine. This work of Eusebius, written in Greek, Jerome afterward translated into Latin, and thus added his authority to

that of Eusebius. Jerome took up his residence in the Holy Land in the latter part of the fourth century, and remained there till his death. (For an estimate of the value of these geographical authorities, see Roland, *Palæst.* p. 467 sq.) Pilgrims now streamed to Jerusalem from all parts of the world, and that site was fixed for Golgotha which has remained to the present hour.

4. *Erection of the "Church of the Holy Sepulchre" over the Site.*—The acts of the Emperor Constantine and his mother Helena gave a permanent and public expression to this tradition. This empress, when very far advanced in life, visited Jerusalem for the express purpose of erecting a church on the spot where the Lord Jesus had been crucified. The preceding details show that the preservation of the memory of the locality was any thing but impossible. Helena would naturally be solicitous to discover the true spot, whence ensues the likelihood that she was not mistaken. She had previously heard that the holy places had been heaped up and concealed by the heathen, and resolved to attempt to bring them to light, *εἰς φῶς ἀγαγῆν* (Theoph. in *Chron.* p. 18). "On her arrival at Jerusalem, she inquired diligently of the inhabitants. Yet the search was uncertain and difficult, in consequence of the obstructions by which the heathen had sought to render the spot unknown. These being all removed, the sacred sepulchre was discovered, and by its side three crosses, with the tablet bearing the inscription written by Pilate" (Robinson, *Bibl. Res.* ii, 14; Theodoret, i, 17). This account of her proceedings, taken from one who labors to bring into discredit the whole of Helena's proceedings, and who is far too indiscriminate and sweeping in his hostility to the *primitive* traditions of the Church, shows sufficiently that Helena was cautious in her proceedings; that there did exist a tradition on the subject; that by that tradition the empress was guided; and that she found reason to fix the site of Calvary on the spot where the heathen had erected their temple and set up their profane rites. That no small portion of the marvellous, not to say legendary and incredible, is mixed up in the accounts which the ecclesiastical historians have given, we by no means deny; but we see no reason whatever, and we think

such a course very unphilosophical, to throw doubt sparingly over the whole, as (by no means in the best taste) does Dr. Robinson. However, on the site thus ascertained, was erected, whether by Constantine or Helena, certainly by Roman influence and treasure, a splendid and extensive Christian temple. Socrates (*Eccles. Hist.* i, 17) says, "The emperor's mother erected over the place where the sepulchre was a most magnificent church, and called it New Jerusalem, building it opposite to that old deserted Jerusalem" (comp. Euseb. *Vit. Const.* iii, 83). This church was completed and dedicated A.D. 335. It was a great occasion for the Christian world. In order to give it importance and add to its splendor, a council of bishops was convened, by order of the emperor, from all the provinces of the empire, which assembled first at Tyre and then at Jerusalem. Among them was Eusebius, who took part in the solemnities, and held several public discourses in the Holy City (Euseb. *Vit. Const.*; Robinson, ii, 18). The Church of the Holy Sepulchre was burnt by the Persians in A.D. 614. It was shortly after rebuilt by Modestus with resources supplied by John Eleemor, patriarch of Alexandria. The basilica or martyrion erected under Constantine remained as before. The Mohammedans next became masters of Jerusalem. At length Harûn er-Rashid made over to Charlemagne the jurisdiction of the holy sepulchre. Palestine again became the scene of battles and bloodshed. Muezz, of the race of the Fatimites, transferred the seat of his empire to Cairo when Jerusalem fell into the hands of new masters, and the holy sepulchre is said to have been again set on fire. It was fully destroyed at the command of the third of the Fatimite caliphs in Egypt, the building being razed to the foundations. In the reign of his successor it was rebuilt, being completed A.D. 1048; but instead of the former magnificent basilica over the place of Golgotha, a small chapel only now graced the spot. The Crusades soon began. The Crusaders regarded the edifices connected with the sepulchre as too contracted, and erected a stately temple, the walls and general form of which are admitted to remain to the present day (Robinson, ii, 61). So recently, however, as A.D. 1808, the church of the holy sepulchre was partly consumed by fire; but, being re-



Front View of the Church of the Holy Sepulchre.

built by the Greeks, it now offers no traces of its recent desolation.

5. *Objections to the Identification.*—The sole evidence of any weight in the opposite balance is that urged by Robinson, that the place of the crucifixion and the sepulchre are now found in the midst of the modern city. But, to render this argument decisive, it should be proved that the city occupies now the same ground that it occupied in the days of Christ. It is, at least, as likely that the city should have undergone changes as that the site of the crucifixion should have been mistaken. The identity of such a spot is more likely to be preserved than the size and relative proportions of a city which has undergone more violent changes than probably any other place on earth. The present walls of Jerusalem were erected so late as A. D. 1542; and Robinson himself remarks that a part of Zion is now left out (p. 67). If, then, the city has been contracted on the south, and if, also, it was after the death of Christ expanded on the north, what should we expect but to find Golgotha in the midst of the modern city?

Jerusalem, in the days of Christ, had two walls, termed the "first" and the "second." It is with the second wall that we are here chiefly concerned. It began at a tower, named Gennath, of the first wall, curved outward to the north, and ended at the castle of Antonia. The third wall embraced a wide suburb on the north and north-west. This comprehended a sort of new city, and was built in consequence of the large population which by degrees fixed their abode in the space which falls between the second and third walls. This wall was begun under Claudius, at least forty-one years after Christ (Josephus, *War*, v, 4, 2; comp. Tacit. *Hist.* v, 12). This third wall, then, did not exist in the time of our Lord; and Robinson allows that if the present site of the sepulchre fell without the second wall, all the conditions of the general question would be satisfied. Many travellers and antiquarians have decided that this was the case, while others, more numerous perhaps, but not better qualified to judge, have come to the opposite conclusion. See JERUSALEM (*Topography*). (It is worthy of remark that Dr. Kiepert, of Berlin, the most experienced cartographer probably, especially on this and kindred subjects, has vacillated on this point in the maps of his own construction, some of them including and others excluding the contested site along the course of the wall in question.) The whole question turns upon the position of the gate Gennath: if this was at the extreme north-west angle of Zion, then the second wall, in order to be at all "circling" (*κυκλοῦμενον*), could not well have excluded the site in question; but if, as is more probable, it was some distance east of the tower Hippicus (for while Josephus, *ut sup.*, expressly begins the first and third walls from this tower, he begins the second from this gate, situated along the northern part of the first wall), then the second wall could hardly have bent sufficiently to the west to include it. See GENNATH. The city bulged out on the north, as it contracted on the south, thus bringing Golgotha into its central parts. Robinson, however, asserts that the second wall must either have excluded the Pool of Hezekiah, which (as he thinks) was in the city, or included the site of the sepulchre, which was out of the city. This alternative, however, although by no means a fatal objection, is not absolutely necessary, as may be seen on reference to various plans of the city that have been constructed, in which the second wall leaves both where the Scriptures place them. See HEZEKIAH'S POOL. But the distance from the western point of the Temple to the present site of the sepulchre Robinson considers insufficient, it being only about a quarter of a mile. We know not that there is any thing in scriptural account which gives support to this notion. A distance of a quarter of a mile appears quite enough for the recorded events, to say nothing of the essential weakness

of such a position; for how can Robinson know that his measures extended along the same ground as our Lord was hurried over? But reason has already been given why the Jews should have taken no very protracted course.

Two or three additional facts in confirmation of the identity of the present place may finally be adduced. Buckingham (*Palest.* p. 288) says, "The present rock called Calvary, and inclosed within the Church of the Holy Sepulchre, bears marks in every part that is naked of its having been a round nodule of rock standing above the common level of the surface." Scholz (*De Golgotha situ*, p. 9) states that he traced the remains of a wall, which ran as the second wall on the plan runs, excluding Golgotha, and taking in the Pool of Hezekiah (Raumer, p. 352). It may also be remarked that, since the publication of Robinson's work, Raumer has put forth a piece (*Beiträge zur Bib. Geog.* 1845), in which he revises his *Palästina* so far as Robinson's ascertained results render necessary; but he remains of the same opinion in regard to the possibility of the present Church of the Sepulchre being out of the city. At most, a very few hundred yards only can the original Golgotha have lain from the present site, and the evidence in favor of its identity, if not decisive, is far stronger than any that has been adduced against it. At the best, then, very small is the reason for disturbing the convictions and distressing the hearts of the sincere believers who visit the Holy Sepulchre in order to give vent to their tearful gratitude and cherish their pious faith. A similar conclusion is warmly contended for by Dr. Olin (*Travels in the East*, ii, 276 sq.), and still more at length by Mr. Williams (*Holy City*, vol. ii, ch. i and ii). It is also ably examined and maintained by Thrupp (*Ancient Jerusalem*, Lond. 1855). It has, however, been either stoutly denied or lightly sneered at by many other writers, who may be styled as belonging to the modern anti-traditionary school. At the head of these is Dr. Robinson, who takes every occasion to impugn the authenticity of scriptural localities in general, as now pointed out.—Kitto, s. v. See GOLGOTHA.

CALVARY, THE, a name given in Roman Catholic countries to "a representation of the various scenes of the passion and crucifixion of our Lord, either in a chapel, or external to the church, as at St. Jacques, at Antwerp. It consists of three crosses with the figures of Christ and the thieves, usually as large as life, surrounded by a number of figures, representing the various personages who took part in the crucifixion. At Aix-la-Chapelle, the Calvary is a church on the top of a hill, surrounded by twelve sculptured stones, each marking an event which took place on the journey of the Saviour to Mount Calvary. The approach to the Calvary is called the *Via Dolorosa*, each of the stones marking what is called a station, at which the pious say a prayer in passing."—Chambers, *Encyclopædia*, s. v.

Calvary, Congregation of Our Lady of, an order of Benedictine nuns, originally founded at Poitiers by Antoinette of Orleans, of the house of Longueville. Pope Paul V confirmed this order in 1617; and in the same year the foundress took possession of a convent newly built at Poitiers, with twenty-four nuns of the order of Fontevrault. In 1620 Mary de Medicis removed these nuns to Paris, and established them near the Luxembourg Palace. The design of their establishment was to honor the mystery of the sorrows of the Virgin for the sufferings of Christ, and some or other of the nuns were compelled to be day and night before the cross. Toward the close of the last century the order counted about twenty convents, all of which were destroyed by the French Revolution. Since that time, a convent in Paris, and several more in other parts of France, have been restored.

Calvert, JOHN P., a Methodist Episcopal minister,

was born in Belmont county, Ohio, October 23, 1838; studied at the Ohio University, and was admitted on trial as a preacher in the Ohio Conference in 1858. When the American civil war broke out in 1861, no less than six of his brothers entered the army, and he soon after felt it his duty to follow them. At the battle of Shiloh, Aug. 7, 1862, he was wounded, and on the following Sunday he died. He had been very useful in the army, preaching and holding prayer-meetings whenever opportunity afforded.—*Minutes of Conferences, 1862, p. 133.*

Calves. See CALF.

Calvin, JOHN, one of the most eminent of the Reformers.

I. Sketch of his Life.—He was born at Noyon, July 10th, 1509, his father, Gerard Chauvin, being a notary. He was from the first educated for the Church, and before he was twelve years old was presented to a benefice in the Cathedral of Noyon. Six years after this he was appointed to a cure of souls at Montville, and thus, although not yet twenty, and not even in the minor orders, he was enjoying the title and revenues of a cure. "His father now changed his mind as to the destination of his son, and desired him to turn his attention to the law as the road to wealth. This change was not unacceptable to Calvin, who, from his perusal of the Scriptures—a copy of which was furnished him by Robert Olivetan, who was his fellow-scholar at Paris, and likewise a native of Noyon—had already been convinced of many of the errors of the Romish Church. He accordingly repaired to Orléans, where he studied under Peter Stella, and then to Bruges, where Andrew Alciat filled the chair of law, and where also Melchior Wolmar, the Reformer, taught him Greek. Here Calvin was confirmed in the doctrines of the Reformation, and began indeed to preach them in the villages. His father, however, dying, he returned to Noyon, but after a short period went to Paris, where, in 1532, he published commentaries on Seneca's two books, *De Clementia*.

"He now resigned his benefices, and devoted himself to divinity. In 1533, Cop, the rector of the University of Paris, having occasion to read a discourse on the festival of All Saints, Calvin persuaded him to declare his opinion on the new doctrines. This brought upon them both the indignation of the Sorbonne, and they were forced to leave the city. Calvin went to several places, and at length to Angoulême, where he got shelter in the house of Louis du Tallet, a canon of Angoulême, and supported himself some time by teaching Greek. There he composed the greater part of his *Institutes of the Christian Religion*, which were published in 1536. The Queen of Navarre, sister to Francis I, having shown him some countenance in respect for his learning and abilities, he returned to Paris in 1534 under her protection, but quitted France the same year, having first published *Psychopangchia*, to confute the error of those who held that the soul remained in a state of sleep between death and the resurrection. He retired to Basle, where he published the *Institutes* (1536), dedicated to Francis I in an elegant Latin epistle. The design of the *Institutes* was to exhibit a full view of the doctrines of the Reformers; and as no similar work had appeared since the Reformation, and the peculiarities of the Romish Church were attacked in it with great force, it immediately became popular. It soon went through several editions, was translated by Calvin himself into French, and has since been translated into all the principal modern languages. Its effect upon the Christian world has been so remarkable as to entitle it to be looked upon as one of those books that have changed the face of society. After this publication Calvin went to Italy, and was received with distinction by the Duchess of Ferrara, daughter of Louis XII. But, notwithstanding her protection, he was obliged to return to

France, but soon left it again, and in the month of August, 1536, arrived at Geneva, where the Reformed religion had been the same year publicly established. There, at the request of Farel, Viret, and other eminent Reformers, by whom that revolution had been achieved, he became a preacher of the Gospel, and professor, or rather lecturer on divinity. Farel was then twenty years older than Calvin, but their objects were the same, and their learning, virtue, and zeal alike, and these were now combined for the complete reformation of Geneva, and the diffusion of their principles throughout Europe. In the month of November a plan of Church government and a confession of faith were laid before the public authorities for their approval. Beza makes Calvin the author of these productions; but others, with perhaps greater reason, attribute them to Farel. There is little doubt, however, that Calvin was consulted in their composition, and still less that he lent his powerful aid to secure their sanction and approval by the people in the month of July, 1537. The same year the Council of Geneva conferred on Farel the honor of a Burgess of the city, in token of their respect and gratitude. But the popular will was not prepared for the severe discipline of the Reformers, and in a short time the people, under the direction of a faction, met in a public assembly and expelled Farel and Calvin from the place. Calvin repaired to Bern, and then to Strasburg, where he was appointed professor of divinity and minister of a French church, into which he introduced his own form of church government and discipline. In his absence great efforts were made to get the Genevese to return to the communion of the Church of Rome, particularly by Cardinal Sadolet, who wrote to them earnestly to that effect; but Calvin, ever alive to the maintenance of the principles of the Reformation, disappointed all the expectations of his enemies, and confirmed the Genevese in the new faith, addressing to them two powerful and affectionate letters, and replying to that written by Sadolet. While at Strasburg Calvin also published a treatise on the Lord's Supper (*Traité de la Sainte Cène*), in which he combated the opinions both of the Roman Catholics and Lutherans, and at the same time explained his own views of that ordinance. Here, too, he published his *Commentary on the Epistle to the Romans*. Calvin became acquainted with Castalio during his residence at Strasburg, and procured for him the situation of a regent at Geneva; and it was during his stay in this city that, by the advice of his friend Bucer, he married Idellet, the widow of a converted Anabaptist.

"In November of the same year he and Farel were solicited by the Council of Geneva to return to their former charge in that city; in May, 1541, their banishment was revoked, and in September following Calvin was received into the city amid the congratulations of his flock, Farel remaining at Neuchâtel. He immediately laid before the council his scheme of church government, and after it was adopted and published by authority (20th of November, 1541), he was unhesitating in its enforcement. His promptitude and firmness were now conspicuous; he was the ruling spirit in Geneva; and the Church which he had established there he wished to make the mother and seminary of all the Reformed churches. His personal labors were unceasing. Geneva, however, was the common centre of all his exertions, and its prosperity peculiarly interested him, though less for its own sake than to make it a fountain for the supply of the world. He established an academy there, the high character of which was long maintained; he made the city a literary mart, and encouraged the French refugees and others who sought his advice to apply themselves to the occupation of a printer or librarian; and having finished the ecclesiastical regimen, he directed his attention to the improvement of the municipal government of the place. That Calvin

should, in the circumstances in which he was now placed, show marks of intolerance toward others, is not surprising; and to seek a palliation of his guilt, we need not go back to the time when he belonged to the Church of Rome, nor yet to the notions of civil and religious liberty prevalent in his age. We have only to reflect on the constitution of the human mind, and the constant care necessary to prevent power in any hands from degenerating into tyranny. His conduct toward Servetus [see SERVETUS] has been justly condemned, yet the punishment of Servetus was approved of by men of undoubted worth, and even by the mild Melancthon. Nor was his treatment of Bolsec (q. v.) without reproach. In 1554 Calvin published a work in defence of the doctrine of the Trinity against Servetus (*Fidelis Expositio Errorum M. Serveti*), and to prove the right of the civil magistrate to punish heresy; Beza the same year published a work on the like subject, in reply to the treatise of Castallo. The state of Calvin's health prevented him going in 1561 to the Conference of Poissy (q. v.), an assembly which in his view promised to be of great consequence, and which was indeed remarkable in this respect, that from that time the followers of Calvin became known as a distinct sect, bearing the name of their leader. To the last he maintained the same firmness of character which had distinguished him through life. On his death-bed he took God to witness that he had preached the Gospel purely, and exhorted all about him to walk worthy of the divine goodness: his slender frame gradually became quite emaciated, and on the 27th of May, 1564, he died without a struggle, in the fifty-fifth year of his age. The person of Calvin was middle-sized and naturally delicate; his habits were frugal and unostentatious; and he was so sparing in his food that for many years he took only one meal in the day. He had a clear understanding, an extraordinary memory, and a firmness and inflexibility of purpose which no opposition could overcome, no variety of objects defeat, no vicissitude shake. In his principles he was devout and sincere, and the purity of his character in private life was without a stain."—*English Cyclopædia*.

It is impossible to contemplate without astonishment the labors of Calvin during the last twenty years of his life. He presided over the ecclesiastical and political affairs of Geneva; he preached every day, lectured thrice a week, was present at every meeting of the Consistory, and yet found time for a vast correspondence, and to continue his voluminous literary labors. Besides his printed works, there are now in the library of Geneva 2025 sermons in MS. His health during all this period was feeble, yet he continued his various toils almost up to the very day of his death. He chose to be poor, refusing on several occasions proposed additions to his very moderate salary, and is said uniformly to have declined receiving presents, unless for the sake of giving them to the poor. From his numerous publications it is believed that he derived no pecuniary profit; and yet, as was the case with Wesley, he was assailed on all sides as having amassed great wealth. "I see," said he, "what incites my enemies to urge these falsehoods. They measure me according to their own dispositions, believing that I must be heaping up money on all sides because I enjoy such favorable opportunities for doing so. But assuredly, if I have not been able to avoid the reputation of being rich during my life, death will at last free me from this stain." And so it was. By his last will Calvin disposes of his entire property, amounting to about two hundred and twenty-five dollars, and on the 27th day of May, 1564, being within a few weeks of fifty-five years of age, he calmly breathed his last in the arms of his friend Beza. He was buried, according to his own request, without pomp, and no monument marks his last resting-place. Calvin's intellect was of the very first class, at once acute, penetrating, profound, and comprehensive. His

cultivation was in harmony with it. Scaliger declares that at twenty-two Calvin was the most learned man in Europe.

"The first edition of his great work, *The Institutes of the Christian Religion*, was published when he was twenty-seven years of age; and it is a most extraordinary proof of the maturity and vigor of his mind, of the care with which he had studied the Word of God, and of the depth and comprehensiveness of his meditations upon divine things, that, though the work was afterward greatly enlarged, and though some alterations were even made in the arrangement of the topics discussed, yet no change of any importance was made in the actual doctrines which it set forth. The first edition, produced at that early age, contained the substance of the whole system of doctrine which has since been commonly associated with his name, the development and exposition of which has been regarded by many as constituting a strong claim upon the esteem and gratitude of the Church of Christ, and by many others as rendering him worthy of execration and every opprobrium. He lived twenty-seven years more after the publication of the first edition of the *Institutes*, and a large portion of his time during the remainder of his life was devoted to the examination of the Word of God and the investigation of divine truth. But he saw no reason to make any material change in the views which he had put forth; and a large proportion of the most pious, able, and learned men and most careful students of the sacred Scriptures, who have since adorned the Church of Christ, have received all his leading doctrines as accordant with the teaching of God's Word."—*Brit. and For. Evang. Review*, No. xxxiii.

As an expositor of the Scriptures and as a writer of systematic theology Calvin had few rivals in the Christian Church. His Latin style is better than that of any Christian writer since Tertullian. Even the Roman Catholic Audin says, "Never does the proper word fall him; he calls it, and it comes." In brevity, clearness, and good sense, his commentaries are unsurpassed. As a civilian, "he had few equals among his contemporaries. In short, he exhibited, in strong and decided development, moral and intellectual qualities which marked him out for one who was competent to guide the opinions and control the commotions of inquiring and agitated nations. Through the most trying and hazardous period of the Reformation he exhibited invariably a wisdom in counsel, a prudence of zeal, and, at the same time, a decision and intrepidity of character which were truly astonishing. In the full import of the phrase, he may be styled a benefactor of the world. Most intensely and effectually, too, did he labor for the highest temporal, and especially for the eternal interests of his fellow-men. He evidently brought to the great enterprise of the age a larger amount of moral and intellectual power than did any other of the Reformers." In the just language of the archbishop of Cashel (Dr. Lawrence), "Calvin himself was both a wise and a good man; inferior to none of his contemporaries in general ability, and superior to almost all in the art, as well as elegance of composition, in the perspicuity and arrangement of his ideas, the structure of his periods, and the Latinity of his diction. Although attached to a theory which he found it difficult in the extreme to free from the suspicion of blasphemy against God as the author of sin, he certainly was no blasphemer, but, on the contrary, adopted that very theory from an anxiety not to commit, but, as he conceived, to avoid blasphemy—that of ascribing to human what he deemed alone imputable to Divine agency."

II. *Calvin's theological Views*.—The following statements of Calvin's theology, which are believed to be impartial, are taken from Neander, *History of Dogmas*, vol. ii. (1) As to the Church, he says, "By the Church we understand not merely the *ecclesia visibilis*, but the

elect of God, to whom even the dead belong." Hence he distinguishes the idea of the outward Church as the peculiar Christian community through which alone we can obtain entrance to eternal life; out of its pale there is no forgiveness of sins, no salvation. The marks of this Church are, that it publishes the Word of God in its purity, and administers the sacraments purely according to their institution. The universal Church is so called inasmuch as it includes believers of all nations. Here the important point is not agreement in all things, but only in essential doctrines (*Instit.* lib. iv). (2) As to the *Sacraments* Calvin occupied a middle position. "On the one hand he protested against the notion of a magical influence, and on the other he held firmly to the objective. The sacraments are not mere signs, but signs instituted by God, which notify to men the Divine promise. They are the outward symbols by which God seals the promises of his grace to our conscience; they attest the weakness of our faith, and at the same time our love to Him. The sacraments effect this, not by any secret magical power, but because they are instituted for this end by the Lord; and they can only attain it when the inward agency of the Holy Spirit is added, whereby alone the sacraments find their way to the heart; they are therefore efficacious only for the predestinated." "Baptism is a seal of a covenant. Christ blessed children, commended them to their heavenly Father, and said that of such was the kingdom of heaven. If children ought to be brought to Christ, why should they not receive the symbol of communion with Christ? Also in the New Testament mention is made of the baptism of whole families, and the early use of infant baptism allows the conclusion that it had come down from the time of the apostles. Infant baptism is also important for the parents, as a seal of the Divine promise which is continued from them to their children; another reason is, that by baptism children are incorporated in the Church, and are so much the more commended to the other members. He believed in a certain influence in infant baptism, and answers the objection to it by saying that, although we cannot understand this effect, it does not follow that it does not take place. He appealed to the fact that John was filled with the Holy Spirit from his birth, and Christ from the beginning with the Divine nature. From his humanity the principle of sanctification must overflow to men, and this would hold good of children" (*Institutes*, bk. iv, ch. xvi). On the doctrine of the *Lord's Supper*, "he opposed those who explained the words 'eating the flesh of Christ and drinking his blood,' only of faith in Christ, and the right knowledge of him (*Institutes*, bk. iv, ch. xvii). Whoever received the Supper in faith was truly and perfectly a partaker of Christ. This communion was not merely a communion of spirit; the body of Christ, by its connection with the Divine nature, received a fulness of life which flowed over to believers. Calvin therefore admitted something supernatural, but thought that the event took place, not by virtue of the body of Christ, which, as such, could not be in several places, but by virtue of the power of the Holy Ghost—a supernatural communication which no human understanding could explain. This communion with Christ, by which he communicates himself and all his blessings, the Supper symbolically represents. The outward is indeed merely a sign, but not an empty sign; it really presents that which is signified by it, namely, the actual participation of the body of Christ by the power of the Holy Spirit. He explains the words of the institutions metonymically, in the sense that the sign is used for the thing signified; he denied any bodily presence of Christ; Christ does not descend to earth, but believers by the power of the Holy Spirit are raised to communion with him in heaven. Christ also descends to them not only by virtue of his Spirit, but also by the outward symbol;

the organ by which communion is attained is faith; he is presented to all, but received only by believers. The mere symbolical view depreciates the sign too much, and separates it from the sacrament; but by the other view the sign is exalted too much, and thereby the nature of the mystery itself is obscured." (8) Calvin's views on *Grace and Predestination* were so strongly pronounced that his name is now used to designate an entire system. He maintained the "doctrine of absolute predestination, which in him was connected with a one-sided tendency of Christian feeling and a rigid logical consequence.* Like Zuingli, he regarded predestination and predestination as of equal extent, and even established the former by the latter; God in no other way foresees the future but as he has decreed. Hence Calvin allowed no contingency even in the fall; he says, How could God, who effects all things, have formed the noblest of his creatures for an uncertain end? What then would become of his omnipotence? The Infrapartians must still allow such a predestination in the case of Adam's descendants. It cannot have been in a natural way that all lost salvation through the guilt of one. Yet he himself feels shocked at the thought; *decretum quidem horribile fateor*,† he says. Consequently, God created the greatest part of mankind in order to glorify himself in them by his punitive justice, and the smaller by the revelation of his love.‡ His opponents might give a reason why God, who could have made them dogs, created them in his own image. Ought irrational brutes also to argue with God? All doubts may be silenced by the thought that God's will is the highest law and cause. Yet he did not rest here. The idea of an absolute omnipotence of God, not conditioned by holiness, he looked upon as profane, and appealed to the incomprehensibility of this mystery. It is to be acknowledged that Calvin sought to evade the practically injurious consequences of the doctrine of absolute predestination, and especially exalted the revealed grace of God in the work of redemption. 'Men ought to keep to the Word of God alone; and, instead of inquiring respecting their own election, look to Christ, and seek in him God's fatherly grace.' Calvin labored very much to procure the universal acknowledgment of this doctrine in Switzerland, but met with serious opposition, among others, from the learned Sebastian Castellio (q. v.). In Geneva Calvin at last obtained the victory, and then soon came to an understanding respecting it with other Swiss theologians. He attempted, but in vain, to get Me-

* III, 21, 1.—Numquam liquido id decet persuasit erimus salutem nostram ex fonte gratuite misericordie Dei fluere, donec innotuerit nobis eterna eius electio, que hac comparatione gratiam Dei illustrat quod non omnes promissive adoptat in spem salutis, sed dat aliis, quod aliis negat. Hujus principii ignorantia quantum ex gloria Dei imminuat, quantum verus humilitatis detrahatur, palam est.

† III, 28, 7.—Iterum quero, unde factum est, ut tot gentes, una cum liberis eorum infantibus eterna morti involveret lapsus Adæ absque remedio, nisi quia Deo ita verum est? Hic obmutescere oportet tam diceas alioqui lingua. Decretum quidem horribile, fateor; inficiari tamen nemo poterit, quin præciserit Deus, quem exitum esset habiturus homo, antequam ipsum conderet, et ideo præciserit, quia decreto suo ita ordinarat. In præscientiam Dei ei quis hic invadebat, temere et inconeulte impingit. Quid enim, queso, est cur reus agatur celestis iudex, quia non ignoraverit quod futurum erat? In predestinationem competit in quid est in se jus ut spei que querimonie. Nec absurdum videri debet quod dico, Deum non modo primi hominis casum et in eo posterorum ruinam providisse; sed arbitrio quoque suo dispensasse. Ut enim ad ejus sapientiam pertinet omnium que futura sunt esse prescium sic ad potentiam, omnia manu sua regere ac moderari.

‡ III, 28, 1.—Contenta sit fidelis sobrietas hac Pauli admonitione (Rom. ix, 22) non esse causam litigandi cum Deo, si ab una parte volens ostendere iram et notam facere potentiam suam ferat in multa tolerantia et lenitate vasa iræ apparrata in interitum; ab altera autem notas faciat divitiis gloriæ sue erga vasa misericordie, que preparavit in gloriam. Minime tamen consentaneum est preparationem ad interitum alio transferre, quam ad arcum consilium Dei; quod etiam paulo ante in contextu aperitur, quod Deus exciterit Pharaonem. deinde quos vult induret. Unde sequitur abconditum Dei consilium obdurantibus esse causam.

lancton on his side. Melancthon called him the modern Zeno, who wanted to introduce a stoical necessity into the Church, and expressed himself very warmly against him (*Corpus Reformat.* vii, 982). When Calvin sent Melancthon his Confession of Faith, the latter was so excited that he struck his pen through the whole passage on predestination. Calvin remarked that this was very unlike his *ingenita mansuetudo*; that he could not imagine how a man of Melancthon's acuteness could reject this doctrine, and said, reproachfully, that he could not believe that he held the doctrines he professed with a sincere heart. On account of a doctrine to which speculation had by no means led him, he reproached him with judging *nimis philosophice* concerning free will."

Calvin professes to be only a borrower from St. Augustine (*Inst.* bk. iii, ch. xxiii, § 18); and he repudiates the consequences that have been charged upon his doctrine. For instance, he strenuously maintains that God is not the author of sin, that men act freely and accountably, and that election is a stimulus to good works rather than an opiate to inaction (*Inst.* bk. iii, ch. xxiii, § 8, 9, 12). See CALVINISM; PREDESTINATION.

III. *Literature.*—The best edition of the Latin works of Calvin is that of Amsterdam (1671, 9 vols. fol.). A new edition is now going on in the *Corpus Reformatorum*, under the title *Calvini Opera quæ supersunt omnia* (vols. i-v, Brunswick, 1864, 1867). An excellent and very cheap edition of the *Commentarii in N. T.*, edited by Tholuck, was published at Halle (1838-38, 7 vols. 8vo); one of the *Comm. in Psalmos* (1836, 2 vols.) and of the *Institutiones Religionis Christianæ* was likewise edited by Tholuck (Halle, 1834, 1835, 2 vols. 8vo); one of the *Comm. in lib. Genesios* (1838, 8vo) by Hengstenberg. Most of Calvin's writings have been translated into English; and a new and revised edition has been issued under the auspices of the "Calvin Translation Society," in very handsome style, yet cheap (Edinb. 51 vols. 8vo). Its contents are as follows: *Institutiones of the Christian Religion*, 8 vols.; *Tracts on the Reformation*, 8 vols.; *Commentary on Genesis*, 2 vols.; *Harmony of the last Four Books of the Pentateuch*, 4 vols.; *Commentary on Joshua*, 1 vol.; *Commentary on the Psalms*, 5 vols.; *Commentary on Isaiah*, 4 vols.; *Commentary on Jeremiah and Lamentations*, 5 vols.; *Commentary on Ezekiel*, 2 vols.; *Commentary on Daniel*, 2 vols.; *Commentary on Hosea*, 1 vol.; *Commentary on Joel, Amos, and Obadiah*, 1 vol.; *Commentary on Jonah, Micah, and Nahum*, 1 vol.; *Commentary on Habakkuk, Zephaniah, and Haggai*, 1 vol.; *Commentary on Zechariah and Malachi*, 1 vol.; *Harmony of the Synoptical Evangelists*, 8 vols.; *Commentary on John's Gospel*, 2 vols.; *Commentary on Acts of the Apostles*, 2 vols.; *Commentary on Romans*, 1 vol.; *Commentary on Corinthians*, 2 vols.; *Commentary on Galatians and Ephesians*, 1 vol.; *Commentary on Philippians, Colossians, and Thessalonians*, 1 vol.; *Commentary on Timothy, Titus, and Philemon*, 1 vol.; *Commentary on Hebrews*, 1 vol.; *Commentary on Peter, John, James, and Jude*, 1 vol. There are English translations of his *Institutiones* by John Allen (Lond. 1813, reprinted in several editions by the Philadelphia Presbyterian Board of Publication), and by Beveridge (Edinb. 1863, 8vo). Calvin's life was written in brief by Beza (Eng. ed. 1844, Edinb. Trans. Soc.; also Phila. 1836, 12mo) and Farel; but within the last few years several biographies have appeared. The most copious and elaborate is *Leben J. Calvin's*, von Paul Henry, D.D. (Hamb. 1835-1844, 3 vols. 8vo). The author procured for his work the inedited letters of Calvin, which are preserved in Geneva, and gives the most important of them in the appendices. A poor translation has been published, entitled *The Life of Calvin, translated from the German of Dr. Henry*, by H. Stebbing, D.D. (Lond. 1849, 2 vols. 8vo); it omits most of the notes and appendices which make up great part of Henry's work. A Roman Catholic biography by Audin (*His-*

toire, etc., de J. Calvin, par J. M. V. Audin, Paris, 2 vols. 1841) has the sole merit of a lively and piquant style. An English translation has been published in Baltimore (*History, etc., of John Calvin, translated from Audin*, by John M'Gill, 8vo); and it has also been translated into German (Augsb. 1843-44, 2 vols.), into Italian (in Pirotta's *Bibliot. Eccles.* vols. ix and x, Milan, 1843), and into other languages. A graphic but superficial biography has been published by Thomas H. Dyer (Lond. 1850; N. Y., Harpers, 1851). A biography, together with select writings of Calvin, was published by Stähelin (*J. Calvin. Leb. u. ausgewählte Schriften*, Elberfeld, 2 vols. 1860, 1863). There is a good sketch of Calvin's life, by Robbins, in the *Bibliotheca Sacra*, vol. ii, for 1845. On the theology of Calvin, see Gass, *Prot. Dogmatik*, vol. i, bk. i; art. CALVINISM; and *Revue Chrétienne*, 1863, p. 720; Cunningham, *The Reformers and Theology of the Reformation*, Essays, vi-x. See also Tulloch, *Leaders of the Reformation* (new ed. Lond. 1861); Bungener, *Calvin, his Life and Works* (Edinb. 1862, 8vo). *The Letters of Calvin*, from original MSS., were first edited by Bonnet and translated by Constable (Edinb. 1855, 4 vols. 8vo, repub. by Presbyterian Board [Philadelphia]). A new edition of the *Institutes* in French, *Institution de la Religion Chrétienne, en quatre livres*, appeared in Paris, 1859 (2 vols. 8vo). It contains an introduction by the editors, with a history of previous editions. See *Meth. Quart. Review*, Oct. 1850, art. iii; *Amer. Theol. Review*, Feb. 1860, p. 129; *North Brit. Review*, vol. xlii; *Brit. and Foreign Evang. Review*, No. xxxiii; *Biblioth. Sacra*, xiv, p. 125; Köstlin, in *Studien u. Kritiken*, 1858, i, ii.

Calvinism, properly, the whole system of theology taught by John Calvin, including his doctrine of the sacraments, etc. It is now, however, generally used to denote the theory of grace and predestination set forth in Calvin's *Institutes*, and adopted, with more or less modification, by several of the Protestant churches. See CALVINISTS.

I. *Calvin's own Views* (Supralapsarian).—These are set forth (from Neander) under the article CALVIN (q. v.). We give here simply such farther extracts from Calvin's own writings as are necessary to show his system.

(1.) "Predestination, by which God adopts some to the hope of life, and adjudges others to eternal death, no one desirous of the credit of piety dares absolutely to deny. But it is involved in many cavils, especially by those who make foreknowledge the cause of it. We maintain that both belong to God; but it is preposterous to represent one as dependent on the other. Predestination we call the eternal decree of God, by which he hath determined in himself what he would have to become of every individual of mankind. For they are not all created with a similar destiny; but eternal life is foreordained for some, and eternal damnation for others. Every man, therefore, being created for one or the other of these ends, we say he is predestinated either to life or to death." After having spoken of the election of the race of Abraham, and then of particular branches of that race, he proceeds: "Though it is sufficiently clear that God, in his secret counsel, freely chooses whom he will, and rejects others, his gratuitous election is but half displayed till we come to particular individuals, to whom God not only offers salvation, but assigns it in such a manner that the certainty of the effect is liable to no suspense or doubt." He sums up the chapter in which he thus generally states the doctrine in these words: "In conformity, therefore, to the clear doctrine of the Scripture, we assert that, by an eternal and immutable counsel, God hath once for all determined both whom he would admit to salvation, and whom he would condemn to destruction. We affirm that this counsel, as far as concerns the elect, is founded on his gratuitous mercy, totally irrespective of human merit; but that to those whom he devotes to condemnation, the gates

of life is closed by a just and irreprehensible, but incomprehensible judgment. In the elect, we consider calling as an evidence of election; and justification as another token of its manifestation, till they arrive in glory, which constitutes its completion. As God seals his elect by vocation and justification, so, by excluding the reprobate from the knowledge of his name and sanctification of his Spirit, he affords another indication of the judgment that awaits them."—*Institutes*, bk. iii, ch. xxi.

(2.) As to the theory that predestination depends on foreknowledge of holiness, Calvin says: "It is a notion commonly entertained that God, foreseeing what would be the respective merits of every individual, makes a correspondent distinction between different persons: that he adopts as his children such as he foreknows will be deserving of his grace, and devotes to the damnation of death others whose dispositions he sees will be inclined to wickedness and impiety. Thus they not only obscure election by covering it with the veil of foreknowledge, but pretend that it originates in another cause" (bk. iii, ch. xxii). Consistently with this, he a little further on asserts that election does not flow from holiness, but holiness from election: "For when it is said that the faithful are elected that they should be holy, it is fully implied that the holiness they were in future to possess had its origin in election." He proceeds to quote the example of Jacob and Esau, as loved and hated before they had done good or evil, to show that the only reason of election and reprobation is to be placed in God's "secret counsel." (Bk. iii, ch. xxiii.)

(3.) So, as to the ground of reprobation: "God hath mercy on whom he will have mercy, and whom he will he hardeneth." You see how he (the apostle) attributes both to the mere will of God. If, therefore, we can assign no reason why he grants mercy to his people but because such is his pleasure, neither shall we find any other cause but his will for the reprobation of others. For when God is said to harden, or show mercy to whom he pleases, men are taught by this declaration to seek no cause beside his will." (Ibid.) "Many, indeed, as if they wished to avert odium from God, admit election in such a way as to deny that any one is reprobated. But this is puerile and absurd, because election itself could not exist without being opposed to reprobation: whom God passes by he therefore reprobates; and from no other cause than his determination to exclude them from the inheritance which he predestines for his children." (Bk. iii, ch. xxiii.)

(4.) Calvin denies that his doctrine makes God the author of sin, asserting that the ruin of sinners is their own work: "Their perdition depends on the divine predestination in such a manner that the cause and matter of it are found in themselves. For the first man fell because the Lord had determined it should so happen. The reason of this determination is unknown to us. Man, therefore, falls according to the appointment of Divine Providence, but he falls by his own fault. The Lord had a little before pronounced every thing that he had made to be 'very good.' Whence, then, comes the depravity of man to revolt from his God? Lest it should be thought to come from creation, God approved and commended what had proceeded from himself. By his own wickedness, therefore, man corrupted the nature he had received pure from the Lord, and by his fall he drew all his posterity with him to destruction."

(5.) In much the same manner he contends that the necessity of sinning is laid upon the reprobate by the ordination of God, and yet denies God to be the author of their sinful acts, since the corruption of men was derived from Adam, by his own fault, and not from God. He exhorts us "rather to contemplate the evident cause of condemnation, which is nearer to us, in the corrupt nature of mankind, than search after a hidden and altogether incomprehensible one, in the

predestination of God." "For though, by the eternal providence of God, man was created to that misery to which he is subject, yet the ground of it he has derived from himself, not God, since he is thus ruined solely in consequence of his having degenerated from the pure creation of God to vicious and impure depravity." See especially *Institutes*, bk. iii, ch. xxiii, § 27, and ch. xxiv, § 8.

From the above passages it will be seen that Calvin went beyond the Augustinian theory of predestination, and held to the supralapsarian view. Supralapsarianism regards man, before the fall, as the object of the unconditional decree of salvation or damnation; Sublapsarianism, on the other hand, makes the decree subordinate to the creation and fall of man. According to Dr. Shedd's definition, "supralapsarianism holds that the decree to eternal bliss or woe precedes, in the order of nature, the decree to apostasy; infralapsarianism holds that it succeeds it" (*History of Doctrines*, ii, 192). The Supralapsarians hold that God decreed the fall of Adam; the Sublapsarians, that he permitted it. Some writers have maintained that Calvin was not a supralapsarian, but that view of his teaching is hardly tenable. Calvin terms "the exclusion of the fall of the first man from the divine predestination a *frigidum commentum*" (iii, ch. xxiii, § 7). So also, § 4, he says, "Quum ergo in sua corruptione perirent (homines), nihil aliud quam penas luunt ejusdem calamitatis, in quam ipsius predestinationem lapsus est Adam, ac posteros suos præcipites secum traxit. It is on this particular point that Calvin goes farther than Augustine, who did not include the fall of Adam in the divine decree" (Smith's Hagenbach's *History of Doctrines*, § 249). Amyraldus (q. v.) sought to reduce Calvin's system to sublapsarianism, but was effectually answered by Curcellæus in his tractate *de jure Dei in Creaturas*. But Fisher (*New Englander*, April, 1868, p. 306) holds that Calvin was not a supralapsarian. (See *Christ. Remembrancer*, Jan. 1856, art. iv; Warren, in *Methodist Quarterly Review*, July, 1857, art. i; Möhler, *Symbolism*, § 4.)

II. *Doctrines of Dort* (Infralapsarian).—The controversy with the Remonstrants on the five points (see ARMINIANISM; REMONSTRANTS) led to the clearer definition of the doctrines in question by the Synod of Dort, which refused to accept the supralapsarian view, at least in terms. See the *Confessions and Canons of the Synod of Dort* for the full statement. The following summing up is given by Watson, from Scott's *Synod of Dort*, of the five articles which constitute the standard of what is now generally called strict Calvinism:

(1.) "Of Predestination.—As all men have sinned in Adam, and have become exposed to the curse and eternal death, God would have done no injustice to any one if he had determined to leave the whole human race under sin and the curse, and to condemn them on account of sin; according to those words of the apostle, 'All the world is become guilty before God' (Rom. iii, 19, 28; vi, 23). That some, in time, have faith given them by God, and others have it not given, proceeds from his eternal decree; for 'known unto God are all his works from the beginning,' etc. (Acts xv, 18; Eph. i, 11). According to which decree he graciously softens the hearts of the elect, however hard, and he bends them to believe; but the non-elect he leaves, in his judgment, to their own perversity and hardness. And here, especially, a deep discrimination, at the same time both merciful and just; a discrimination of men equally lost, opens itself to us; or that decree of election and reprobation which is revealed in the word of God, which, as perverse, impure, and unstable persons do wrest to their own destruction, so it affords ineffable consolation to holy and pious souls. But election is the immutable purpose of God, by which, before the foundations of the world were laid, he chose, out of the whole human race, fall-

en by their own fault from their primeval integrity into sin and destruction, according to the most free good pleasure of his own will, and of mere grace, a certain number of men, neither better nor worthier than others, but lying in the same misery with the rest, to salvation in Christ, whom he had, even from eternity, constituted Mediator and head of all the elect, and the foundation of salvation; and therefore he decreed to give them unto him to be saved, and effectually to call and draw them into communion with him by his word and Spirit; or he decreed himself to give unto them true faith, to justify, to sanctify, and at length powerfully to glorify them, etc. (Eph. i, 4-6; Rom. viii, 30). This same election is not made from any foreseen faith, obedience of faith, holiness, or any other good quality and disposition, as a *prerequisite* cause or condition in the man who should be elected, etc. 'He hath chosen us,' not because we were, but 'that we might be holy,' (Eph. i, 4; Rom. ix, 11-13; Acts xiii, 48). Moreover, holy Scripture doth illustrate and commend to us this eternal and free grace of our election, in this more especially, that it doth testify all men not to be elected; but that some are non-elect, or passed by, in the eternal election of God, whom truly God, from most free, just, irrepensible, and immutable good pleasure, decreed to leave in the common misery into which they had, by their own fault, cast themselves; and not to bestow on them living faith, and the grace of conversion; but having been left in their own ways, and under just judgment, at length, not only on account of their unbelief, but also of all their other sins, to condemn and eternally punish them, to the manifestation of his own justice. And this is the decree of reprobation, which determines that God is in no wise the author of sin (which, to be thought of, is blasphemy), but a tremendous, incomprehensible, just judge and avenger."

(2.) "*Of the Death of Christ.*"—Passing over, for brevity's sake, what is said of the necessity of atonement in order to pardon, and of Christ having offered that atonement and satisfaction, it is added, "This death of the Son of God is a single and most perfect sacrifice and satisfaction for sins, of infinite value and price, abundantly sufficient to expiate the sins of the whole world; but because many who are called by the Gospel do not repent, nor believe in Christ, but perish in unbelief; this doth not arise from defect or insufficiency of the sacrifice offered by Christ upon the cross, but from their own fault. God willed that Christ, through the blood of the cross, should out of every people, tribe, nation, and language, efficaciously redeem all those, and those only, who were from eternity chosen to salvation, and given to him by the Father; that he should confer on them the gift of faith," etc.

(3.) "*Of Man's Corruption, etc.*"—All men are conceived in sin, and born the children of wrath, indisposed (*inerti*) to all saving good, propense to evil, dead in sin, and the slaves of sin; and without the regenerating grace of the Holy Spirit, they neither are willing nor able to return to God, to correct their depraved nature, or to dispose themselves to the correction of it."

(4.) "*Of Grace and Free-will.*"—But in like manner as, by the fall, man does not cease to be man, endowed with intellect and will, neither hath sin, which hath pervaded the whole human race, taken away the nature of the human species, but it hath depraved and spiritually stained it; so that even this divine grace of regeneration does not act upon men like stocks and trees, nor take away the properties of his will, or violently compel it while unwilling; but it spiritually quickens, heals, corrects, and sweetly, and at the same time powerfully, inclines it; so that whereas before it was wholly governed by the rebellion and resistance of the flesh, now prompt and sincere obedience of the Spirit may begin to reign; in which the renewal of our spiritual will, and our liberty, truly consist; in which manner (or for which reason), unless the admi-

nable Author of all good should work in us, there could be no hope to man of rising from the fall by that free will by which, when standing, he fell into ruin."

(5.) "*On Perseverance.*"—God, who is rich in mercy, from his immutable purpose of election, does not wholly take away his Holy Spirit from his own, even in lamentable falls; nor does he so permit them to glide down (*prolabi*) that they should fall from the grace of adoption and the state of justification; or commit the 'sin unto death,' or against the Holy Spirit; that, being deserted by him, they should cast themselves headlong into eternal destruction. So that not by their own merits or strength, but by the gratuitous mercy of God, they obtain it, that they neither totally fall from faith and grace, nor finally continue in their falls and perish."

The Confessions of the Reformed Church agree more or less closely with the statements of Dort, whether they preceded or followed it in date. See the *Confessio Gallica*, art. 12; *Confessio Belgica*, art. 16; *Form. Consensus Helvet.* arts. 4 and 19; *Conf. Helvet.* ii, 10. (See Winer, *Comp. Darstellung*, ix, 1; Hagenbach, *History of Doctrines*, § 249.) The *Westminster Confession* is the standard of the Church of Scotland, and of the various Presbyterian Churches in Europe and America. Its 8d article states *God's Eternal Decree* as follows:

"*Of God's Eternal Decree.*"—God from all eternity did, by the most wise and holy counsel of his own will, freely and unchangeably ordain whatsoever comes to pass; yet so as thereby neither is God the author of sin, nor is violence offered to the will of the creatures, nor is the liberty or contingency of second causes taken away, but rather established. Although God knows whatsoever may or can come to pass upon all supposed conditions, yet hath he not decreed anything because he foresaw its future, or as that which would come to pass upon such conditions. By the decree of God, for the manifestation of his glory, some men and angels are predestinated unto everlasting life, and others foreordained to everlasting death. These angels and men, thus predestinated and foreordained, are particularly and unchangeably designed, and their number is so certain and definite that it cannot be either increased or diminished. Those of mankind that are predestinated unto life, God, before the foundation of the world was laid, according to his eternal and immutable purpose, and the secret counsel and good pleasure of his will, hath chosen, in Christ, unto everlasting glory, out of his mere free grace and love, without any foresight of faith, or good works, or perseverance in either of them, or any other thing in the creature, as conditions, or causes moving him thereunto; and all to the praise of his glorious grace. As God hath appointed the elect unto glory, so hath he, by the eternal and most free purpose of his will, foreordained all the means thereunto. Wherefore they who are elected, being fallen in Adam, are redeemed by Christ, are effectually called unto faith in Christ, by his Spirit working in due season; are justified, adopted, sanctified, and kept by his power through faith unto salvation. Neither are any other redeemed by Christ, effectually called, justified, adopted, sanctified, and saved, but the elect only. The rest of mankind God was pleased, according to the unsearchable counsel of his own will, whereby he extendeth or withholdeth mercy, as he pleaseth, for the glory of his sovereign power over his creatures, to pass by, and to ordain them to dishonor and wrath for their sin, to the praise of his glorious justice."

The 17th article of the *Church of England* is as follows:

"*Of Predestination and Election.*"—Predestination to life is the everlasting purpose of God, whereby (before the foundations of the world were laid) he hath constantly decreed, by his counsel, secret to us, to deliver from curse and damnation those whom he hath chosen

in Christ out of mankind, and to bring them by Christ to everlasting salvation, as vessels made to honor. Wherefore they which be endued with so excellent a benefit of God be called according to God's purpose, by his Spirit working in due season: they, through grace, obey the calling: they be justified freely: they be made sons of God by adoption: they be made like the image of his only-begotten Son Jesus Christ: they walk religiously in good works; and at length, by God's grace, they attain to everlasting felicity. As the godly consideration of predestination and our election in Christ is full of sweet, pleasant, and unspeakable comfort to godly persons, and such as feel in themselves the working of the Spirit of Christ, mortifying the works of the flesh and their earthly members, and drawing up their mind to high and heavenly things, as well because it doth greatly establish and confirm their faith of eternal salvation to be enjoyed through Christ, as because it doth fervently kindle their love toward God; so, for curious and carnal persons, lacking the Spirit of Christ, to have continually before their eyes the sentence of God's predestination is a most dangerous downfall, whereby the devil doth thrust them either into desperation, or into wretchedness of most unclean living, no less perilous than desperation. Furthermore, we must receive God's promises in such wise as they be generally set forth to us in holy Scripture. And in our doings, that will of God is to be followed which we have expressly declared unto us in the Word of God."

It has always been a question in the Church of England whether the Articles are or are not Calvinistic. On this question, see Toplady, *Doctrinal Calvinism of the Church of England* (Works, vol. i and ii); Overton, *True Churchman* (2d ed. York, 1801); Laurence, *Bampton Lecture for 1804* (Oxford, 1805, 8vo); Cunningham, *The Reformers, Essay iv* (Edinb. 1862, 8vo); printed also in the *Brit. and For. Evang. Rev.* (No. 85); reprinted in the *Am. Theol. Review* (October, 1861, art. v); Hardwick, *History of Reformation*, ch. iv, p. 260.

The Lutheran Church never adopted the Calvinistic system. In the beginning, both Luther and Melancthon received the Augustinian theology; but as early as 1529 Melancthon expunged the passages supporting it from his *Loci Theologici*. Luther bestowed the highest praise on the last editions of the *Loci* (Luther's Works, 1846, vol. i, preface; see Laurence, *Bampton Lect. Sermon ii*, note 21). The Augsburg *Confessio Variata* (xx) says: "Non est hic opus disputationibus de predestinatione et similibus. Nam promissio est universalis et nihil detrahit operibus, sed exauscitat ad fidem et vere bona opera" (see Gieseler, *Church History*, iv, §§ 36, 37). In the German Reformed Church the strictly Calvinistic doctrine "never, as such, received any symbolical authority; and it was significantly left out of the Heidelberg Catechism, and handed over to the schools and scientific theology. At the same time, it was never rejected by the German Church, nor regarded with any thing like hostility." Appel, in the *Tercentenary Monument of the Heidelberg Catechism*, p. 327; Hase, *Church History*, § 364.

III. The Calvinistic system was still farther modified by the Federal Theology, or the THEOLOGY OF THE COVENANTS. Under the too exclusive influence of the doctrine of Predestination, it had assumed a scholastic character, from which it was in part relieved by the introduction of the idea of the *Covenant*, as a constructive principle of the system. John Cocceius, trained in the German Reformed theology (born at Bremen 1603, died 1699), first developed the system under this point of view, the effect of which was to introduce historical facts and elements, and a distinctive ethical idea (a covenant implying mutual rights), into the heart of the system, and to banish the idea of the divine sovereignty as mere will. Cocceius distinguished between, 1. The covenant before the Fall, the covenant of works; and, 2. The covenant after the

Fall, the covenant of grace. The latter covenant embraces a threefold economy: (1) The economy before the law; (2) The economy under the law; (3) The economy of the Gospel. See his *Summa Doctrina de Federe et Testamentis Dei*, 1648. Heppé says: "The fruit of his influence was to lead the Reformed theologians back to the freedom of the Word of God, delivering it from the bondage of a traditional scholasticism." This type of Calvinism was still farther developed in the writings of Braun, *Doctrina Fœderum* 1698; of Burmann of Utrecht († 1679), *Synopsis Theologia et Economica Fœderum Dei*, 1671; Heidanus of Leyden († 1678), *Corpus Theol. Christ.* 1687; and especially of Witsius of Leyden († 1708), whose *Economy of the Covenants* (1694) was translated into English (Lond. 1763; revised ed. Edinb. 1771, 1808; New York, 3 vols. 1798). This theology of the covenants also shaped, to a considerable extent, the Reformed system as it was adopted in England, Scotland, and America. It is clearly recognised in the Westminster Confession of Faith and Catechisms. Later writers divide the covenant of grace into two parts, viz. the covenant of redemption between the Father and the Son, and the covenant of grace between God and his people in Christ. On this important phase of the Calvinistic theology, see Ebrard, *Dogmatik*, i, 60 sq.; Gass, *Geschichte der Protest. Dogmatik*, Bd. 2, 1867; Schweizer, *Glaubenslehre der Evang. reformirten Kirche*, 2 Bde. 1844, and also his *Protestantische Centraldogmen*, 2 Bde. 1854; Schneckenburger, *Vergleichende Darstellung der lutherischen und reformirten Lehrbegriffe*, 1855; G. Frank, *Geschichte der Protest. Theol.* 2 Bde. 1865; also Heppé, *Dogmatik d. deutschen Protestantismus*, i, 204; *Dogmatik der evang.-ref. Kirche*, i, 278; and the article FEDERAL THEOLOGY.

IV. *Moderate Calvinists*.—This phrase designates those, especially in England and America, who, while adhering to the Calvinistic as contrasted with the Arminian system, have yet receded from some of the extreme statements of the former, especially upon the two articles of Reprobation and the Extent of the Atonement. See Dr. E. Williams, *Defence of Modern Calvinism*, 1812; *Sermon and Charges*, p. 128, and Appendix, p. 399. Dr. Williams says: "Reprobation, or 'predestination to death or misery as the end, and to sin as the means,' I call an 'impure mixture' with Calvinism, as having no foundation either in the real meaning of Holy Writ, or in the nature of things; except, indeed, we mean by it, what no one questions, a determination to punish the guilty." He calls this a "mixture," because its connection with predestination to life is arbitrary and forced; 'impure,' because the supposition itself is a foul aspersion upon the divine character."

The other point on which the moderate Calvinists modified the system is the nature and extent of the atoning work of Christ. Strict Calvinism asserts that the Lord Jesus Christ made atonement to God by his death only for the sins of those to whom, in the sovereign good pleasure of the Almighty, the benefits of his death shall be finally applied. By this definition, the extent of Christ's atonement, as a provision, is limited to those who ultimately enjoy its fruits; it is restricted to the elect of God. Both Strict and Moderate Calvinists agree as to the intrinsic worth of the atonement, and as to its final application. It has been asserted (e. g. by Amyraut, q. v.) that Calvin himself held to general redemption; and certainly his language in his *Comm. in Job*, iii, 15, 16, and in 1 *Tim.* ii, 5, seems fairly to assert the doctrine. Comp. Fletcher, *Works* (N. Y. ed. ii, 71); but see also Cunningham, *The Reformers* (Essay vii). As to the variations of the Calvinistic confessions, see Smith's Hagenbach, *History of Doctrines*, § 249. In the French Reformed Church, the divines of Saumur, Camero, Amyraldus, and Placeus maintained universal grace (see articles on these names). The English divines who attended

the Synod of Dort (Hall, Hale, Davenant) all advocated general atonement, in which they were followed by Baxter (*Universal Redemption; Methodus Theologica; Orme, Life of Baxter*, ii, 64). The "moderate" doctrine as to the nature of the atonement is, in brief, that it consists in "that satisfaction for sin which was rendered to God as moral governor of the world by the obedience unto death of his son Jesus Christ. This satisfaction preserves the authority of the moral government of God, and yet enables him to forgive sinners. That this forgiveness could not be given by God without atonement constitutes its necessity." See ATONEMENT. That Christ's atonement was sufficient for all, that it is actually applied only to the elect, and that it enhances the guilt of those who reject it, is now almost universally conceded by the different schools. But its universality, as a provision, is also asserted by the moderate Calvinists, with some modifications in the statement of its nature. The English views as to the nature of the atonement are presented in the following extracts: Dr. Magee (*On the Atonement*) says, "The sacrifice of Christ was never deemed by any, who did not wish to calumniate the doctrine of atonement, to have made God placable, but merely viewed as the means appointed by divine wisdom by which to bestow forgiveness. But still it is demanded, in what way can the death of Christ, considered as a sacrifice of expiation, be conceived to operate to the remission of sin, unless by the appeasing of a Being who otherwise would not have forgiven us? To this the answer of the Christian is, I know not, nor does it concern me to know, in what manner the sacrifice of Christ is connected with the forgiveness of sins; it is enough that this is declared by God to be the medium through which my salvation is effected: I pretend not to dive into the councils of the Almighty. I submit to his wisdom, and I will not reject his grace because his mode of vouchsafing it is not within my comprehension." Andrew Fuller, in his *Calvinistic and Socinian Systems compared* (Letter vii), strongly reprobates the idea of placating the Divine Being by an atonement, "contending that the atonement is the effect, and not the cause of divine love" to men; and insists "that the contrary is a gross misrepresentation of the Calvinists in general," though it must be confessed some Calvinists have given too much countenance to such an idea. Mr. Fuller adds, "If we say a way was opened by the death of Christ for the free and consistent exercise of mercy in all the methods which sovereign wisdom saw fit to adopt, perhaps we shall include every material idea which the Scriptures give us of that important event."

V. Farther modifications in the Calvinistic system have been made in this country through the influence of the so-called NEW-ENGLAND THEOLOGY, especially as set forth in the writings of Jonathan Edwards and his successors. In respect to original sin, the elder Edwards, in his work on that subject, advocated the mediate rather than the immediate imputation of Adam's first sin to his posterity. On the nature of virtue he introduced an important modification, in making *love to being* (in the two forms of love of benevolence and love of complacency) to constitute the essence of virtue. On the nature of the atonement he made no modification. He also distinguished more carefully than had previously been done between natural ability and moral inability, and this distinction was farther elaborated by the younger Edwards, who also represented the atonement as consisting in a satisfaction to the general rather than the distributive justice of God. Hopkins and Emmons carried out these views still farther, but under the influence (especially in the case of Emmons) of the supralapsarian scheme. These discussions extended from New England into the Presbyterian Church. The parties there known as Old and New School differ chiefly on the following articles: 1. Imputation of sin, whether it be immedi-

ate or mediate; 2. The nature and extent of the atonement; 3. Ability and inability.

For the history of the development of Calvinism, see REFORMED CHURCH. For the Antinomian and extreme supralapsarian developments of Calvinism, see ANTINOMIANISM; CRISP; HOPKINSIANS. For certain mitigated schemes of Calvinism, see AMYRALDIUM; BAXTER; CAMERO. On two of the principles which distinguish the so-called Moderate Calvinism, viz. (1.) the universality of the atonement, see ATONEMENT; REDEMPTION; (2.) The natural ability of all men to repent, see INABILITY; NEW-ENGLAND THEOLOGY.

VI. *Literature.* — The literature of the Calvinistic controversy is enormous. The principal books only can be named here: Calvin, *Institutiones*; Zwinglius, *Brevis Leagoge; Comm. de vera et falsa religione*; the Confessions of the Reformed Churches, given in Augusti, *Corpus Librorum Symbolicorum* (1828), or in Niemeyer, *Collectio Confessionum* (1840); the Westminster Confession (1648); the Decrees of the Synod of Dort (1619). The chief Calvinistic writers of the 16th and 17th centuries were Beza, Bullinger, Alstedt, Whitgift, Cartwright, Crisp, Perkins, Leighton, Baxter (moderate), Owen, Howe, Ridgely, Gomar, Alting, Rivetus, Heidegger, Turretin, Pictet. Of the 18th and 19th centuries the following are selected: Stapfer, Wytenbach, Gill, Toplady, Erakine, Dick, Hill, Breckinridge, Krummacher. Of the new American school: Edwards, Bellamy, Emmons, Dwight, West, Smalley, etc., whose influence was seen in England in the writings of Fuller, Ryland, Hall, Jay, Pye Smith, and Chalmers. The so-called Old Calvinism has produced few writers of late in England. It is ably defended in America by the Princeton theologians. For the historical treatment of the subject, see Gill, *Cause of God and Truth*, pt. iv; Neander, *History of Dogmas* (l. c.); Hagenbach, *Hist. of Doctrines* (ed. by Smith, § 219-222); Ebrard, *Christl. Dogmatik*, § 17-51, and § 556-565; Womack, *Calvinistic Cabinet Unlocked*; Watson, *Theol. Institutes*, pt. ii, ch. xxviii; Herrmann, *Geschichte der Prot. Dogmatik* (Leips. 1842); Gasa, *Geschichte der Prot. Dogmatik* (Berlin, 1854); Heppel, *Dogmatik der Evang.-Reform. Kirche* (Elberfeld, 1861); Mozley, *Augustinian Doctrine of Predestination* (Lond. 1855); *Christian Remembrancer*, Jan. 1856, 170 sq.; Nicholls, *Calvinism and Arminianism compared* (Lond. 1824, 2 vols. 8vo) is very full as to English writers, and abounds in valuable citations, but is destitute of scientific arrangement; Cunningham, *Historical Theology* (1862); Ditto, *Theology of the Reformation* (1862); Hill, *Lectures on Divinity*, chap. xi. For the later forms of Calvinism, especially in America, see Tyler, *History of the New Haven Theology* (1837); Beecher, *Views in Theology*; Rice, *Old and New Schools* (1853); Bangs, *Errors of Hopkinsianism* 1815; Hodgson, *New Divinity* (1839); Fisk, *The Calvinistic Controversy*; and especially, on the whole subject, Warren, *Systematische Theologie*, § 24 (Bremen, 1865, 8vo). Polemical works against Calvinism: (a) *Lutheran, Chemnitz*, in his *Loci Theologici*; Dannbauer, *Hodomorica Spiritus Calvin* (1654); Feuerborn, *Epitome Error. Calv.* (1651); (b) *Arminian and Methodist* (besides those above named): Arminius, Episcopius, Limborch, Curcellæus (writings generally); Wesley (*Works*, see Index); Fletcher, *Checks to Antinomianism*, etc.; Watson, *Theol. Institutes*, vol. ii; Goodwin, *Redemption Redeemed*; Foeter, *Calvinism as it is*; (c) *Later German writers*: Ebrard, in his *Dogmatik* (Königsberg, 1851, 2 vols. 8vo); Lange, *die Lehre der heil. Schriften von der freien und allgemeinen Gnade Gottes* (Elberf. 1631, 8vo). Writers on special topics, e. g. Election, Redemption, Predestination, etc., will be named under those heads respectively. See ARMINIANISM; ELBETION; FEDERAL THEOLOGY; GRACE; PREDESTINATION; SACRAMENTS.

Calvinists, (1.) a name formerly used on the Continent of Europe to designate all members of the so-

called *Reformed* churches, as distinguished from the *Lutheran* Church. It is still so used to a certain extent, especially in France and Austria.

(2.) It is now generally in use to designate those who receive the theological tenets of Calvin, without regard to Church or sect. See CALVIN; CALVINISM. In the early part of the 16th century the *Reformed* churches of Switzerland, Hungary, France, Germany, and Holland were all Calvinistic in this sense; now the proportion of Calvinists in some of them is small. The Presbyterian churches of England, Scotland, Ireland, and America are, with few exceptions, Calvinistic. So also are many of the Independent and Congregational churches, both in England and America. In the Church of England, and the Protestant Episcopal Church of the United States, Calvinism prevails to a certain extent, but statistics are wanting. Bishop Burgess remarks that "although the Church of England had been represented at the Synod of Dort, its clergy acquiesced not at all in the determination of that assembly, and the bishops who were there among the last of their order who have written upon the side which was there triumphant. The Calvinism of the Church grew fainter till it scarcely struggled. It was not so much overcome by direct assaults as supplanted through the more ecclesiastical spirit which predominated at the Restoration. For a century after, its voice was almost unheard, except along with the irregularities of Whitefield, and then it was much more than overbalanced by the Arminianism of Wesley. Within the last century it has been revived in the writings of many pious men, but can scarcely be viewed as having very largely affected the prevalent teaching of Episcopalians, either in Great Britain or in America" (*Bibliotheca Sacra*, 1868, p. 868). The Dutch Reformed Church, the larger part of the Baptists and of the Welsh Methodists, are also Calvinists.

Calvisius, SEYM, or Kalwitz, a celebrated chronologist, was born at Gorsleben, Thuringia, Feb. 20, 1666. He studied at Frankenhäusen and Magdeburg, where he gained his bread by singing in the streets, and laid by enough to support him at the Academy of Helmstädt, whither he went in 1679, and thence to Leipzig. He gained a profound knowledge of music, chronology, astronomy, and Hebrew. He died at Leipzig Nov. 23, 1615, leaving, besides other works, *Enodatio duarum questionum circa annum Nativitatis et tempus Ministerii Gregorici* (Erfurt, 1610, 4to); also, *Elenchus Calendarii Gregoriani* (Heidelberg, 1612). But his principal work is entitled *Opus Chronologicum*, "ex auctoritate potissimum Sancti Scripturæ et historicorum fide dignissimorum, ad motum luminarium cælestium tempora et annos distinguendum" (Frankfort, folio, 1604 and 1684). In this work he endeavored to supply the defects and correct the errors of Scaliger and other chronologists, by having recourse to astronomical calculations, in order to fix the precise time of different events. For this purpose he calculated more than one hundred and fifty eclipses. John Kepler, David Pareus, and others warmly attacked his work on its appearance, but Scaliger spoke of it in the highest terms, declaring it, in a letter to Isaac Casaubon, to be *accuratissimum chronicon*. Calvisius's works are inserted in the Roman Index.—Hoeser, *Biog. Générale*, viii, 278; Landon, *Eccles. Dictionary*, ii, 505.

Camaldules (*Camaldulani*, *Camaldulenses*, *Ordo Camaldulanus*), a religious order founded about 1009 by Romualdus, who built a monastery at Campo Maldoli, or Camaldoli, a village thirty miles east of Florence, and belonging to a lord named Maldoli, whence the order, some time after the death of Romualdus, took its name. Up to the end of the eleventh century they bore the name of their founder, and were called Romualdines. The monks observe the rule of St. Benedict, with some alterations and additions, and combine the cenobitic and eremitical life. At first they wore a

black dress; but Romualdus, having seen a vision of his monks mounting a ladder toward heaven, and all clothed in white, changed their habit from black to white. In the seventeenth and eighteenth centuries, the order was divided into five congregations, under so many generals or "majors," with about 2000 members. The life of these hermits was originally very severe; but, like most other orders, as it grew rich, it became corrupt. They were re-formed in 1481 by Eugene IV, and again in 1518. A new order, with a stricter rule, was formed by Gustiniani in 1520, and since that time both divisions exist independently. They appear never to have had an establishment in England. In France there was but one convent of Camaldules or Camaldoli, viz., at Grosbois, near Paris. They were of the congregation of "Our Lady of Consolation." The Camaldule cenobites, to whom Pope Gregory XVI belonged, have their principal convent at Rome, and a few more houses in Italy, with about one hundred members. The hermits are a little more numerous, counting upward of two hundred members, with two majors at Camaldoli and Monte Corona, near Perugia. Their convents are likewise all in Italy, with the exception of one in Poland. There was also a congregation of Camaldule nuns, founded by the fourth general of Camaldules, Rudolphus, in 1086, at Mucellano, in Tuscany. They had in the seventeenth century twenty-four convents, of which, in 1860, only two were left, at Rome and at Florence.—Fehr, *Gesch. der Möncheorden*, i, 68 sq.; Helyot, *Ord. Relig.* i, 577; Landon, *Ecc. Dict.* ii, 506.

Cambridge Manuscript (CODEX CANTABRIGIENSIS, from its present place of deposit), called also CODEX BEZÆ (from its depositor), usually designated as D of the Gospels and Acts, is one of the most important uncial MSS. of the N. T. It contains the Greek text, with a Latin translation on the opposite page, of the entire four Gospels (in the order Matthew, John, Mark, Luke) and Acts, with several gaps (Matt. i, 1-20; vi, 20-ix, 2; xxvii, 2-12; John i, 16-iii, 26; Acts viii, 29-x, 14; xxi, 1-20, 15-18 [which passage seems to have been extant in Wetstein's time]; xxii, 10-20, 29-xxviii, 81, in all which the Greek is wholly absent; and Matt. iii, 7-16; Mark xvi, 15-20; John xviii, 14-xx, 18, where the Greek has been supplied by a scribe not earlier than the tenth century; besides about as numerous omissions and similar restorations of the Latin, but mostly at different places from the foregoing), and a few verses of the catholic Epistles (John iii, 11-15, in the Latin only), which once stood entire between the Gospels and Acts. The MS. is a quarto volume, 10 inches high by 8 broad, consisting of 414 leaves (11 of them more or less mutilated, and 9 others by later hands), with but one column on each page, the Greek being on the left page and the Latin on the right. The vellum is not very fine. There are 86 lines on each page, and these are of unequal length, the MS. being arranged in clauses or *στίχοι*, and the corresponding ones in the Lat. and Gr. as nearly as possible opposite each other. It has not the large *κεφάλαια* or Eusebian canons, but only the Ammonian sections, and these often incorrectly placed, obviously by a later hand. The leaves are arranged in quires of 4 sheets (8 leaves) each, the numeral "signatures" of which are set by the first hand low in the margin at the foot of the last page of each. It originally consisted of upward of 64 quires, and one of the gaps, which omits 67, ending with 8 John, 11, would be too great a space for all the canonical Epistles merely. The first three lines of each book were written in bright red ink, which was also occasionally employed elsewhere by way of ornament. The characters betray a later age than Codices Alexandrinus, Vaticanus, and Ephraemi (A, B, and C), and capitals occur as in Codex Sinaiticus (N). Its Alexandrine forms would argue an Egyptian origin, but the fact of

ΣΖΗ : ΤΟ ΤΕ ΟΜΟΙΩΘΗΝ ΣΕΤΑΙ Η ΒΑΣΙΛΕΙΑ ΤΩ ΝΟΥ ΥΓΑΝΩΝ
 ΔΕ ΚΑ ΠΑΡΕΝΟΙΣ· ΑΙ ΤΙΝΕΣ ΛΑΒΟΥΣΑΙ
 ΤΑΣ ΛΑΜΠΑΔΑΣ ΕΑΥΤΩΝ
 ΕΞΗΛΘΟΝ ΕΙΣ ΑΠΑΝΤΗΣΙΝ ΤΟΥ ΝΥΜΦΙΟΥ

Specimen of the Codex Cantabrigiensis, from the fac-simile types of Kipling's edition (the Greek of Matt. xxv, 1: τοτε ομοιωθησεται η βασιλεια του ουρανου | δεκα παρηνοις· αι τινες λαβουσαι τας λαμπραδασ εαυτων | εξηλθον εις απαντησιν του νυμφιου |).

the Latin translation shows that it is a Western copy. It is assigned with great probability to the sixth century. It is chiefly remarkable for its bold and extensive interpolations, amounting to some six hundred in the Acts alone, on which account it has been cautiously employed by critics, notwithstanding its great antiquity. See CRITICISM (BIBLICAL).

This MS. was presented to Cambridge University in 1581 by Theodore Beza, who says he obtained it during the French wars in 1562, when it was found in the monastery of St. Irenæus at Lyons, and doubtless rescued by some Huguenot soldier. It seems to have been the same noted as β in the margin of Stephens's third edition. It was first completely examined by Patrick Young, the librarian of Charles I, and next collated by Usher for Walton's *Polyglot*. Dr. Kipling published it in full from fac-simile types, but with the uncritical insertion of many of the marginal readings by the second hand into the text (*Codex Theodori Beza Cantabrigiensis*, 1793, 2 vols. fol.). Scrivener has since reprinted it more carefully in ordinary types, with introduction, annotations, and exact fac-similes (*Codex Beza*, etc., Lond. 1864, 8vo).—Scrivener, *Introd.* p. 96 sq.; Tregelles in Horne's *Introd.* (new ed.), iv, p. 169 sq. See MANUSCRIPTS (BIBLICAL).

Cambridge Platform, a system^o of Church discipline agreed upon by the elders and messengers of the New England churches, assembled in synod at Cambridge, 1648. The object of the synod was to define accurately the ecclesiastical position of the New England churches. In matters of faith they were agreed, but there were differences in regard to Church government, some being inclined to a more strict Presbyterianism, some to a more loose Independency, while the great majority were Congregationalists.

As regards doctrine, the synod declared their adhesion to the Westminster Confession; but they did not accept that confession in regard to discipline, but proceeded to construct a platform, of which we give the following abstract: It declares that the form of Church government is one, immutable, and prescribed in the

Word of God. The Church in general consists of the whole company of the redeemed, but the state of the visible Church militant, walking in order, was before the law economical, or in families; under the law, national; since Christ, only congregational. "The matter of the visible Church in quality consists of saints by calling;" and in quantity "a church ought not to be of greater number than may ordinarily meet together conveniently in one place, nor fewer than can conveniently carry on church work." The saints must have a visible political union among themselves, and this form is the visible covenant whereby they give themselves up to the Lord, to the observing of the ordinances of Christ together in the same society. The *supreme power* in the Church belongs to Jesus Christ; subordinate power, as extraordinary, to apostles, etc.; as ordinary, to every particular church. The *officers* in a church are necessary to its well-being, but not to its existence. The extraordinary, as apostles, are temporary; the ordinary, which are elders (or bishops) and deacons, are perpetual. There is a difference between teaching and ruling *elders*. The ruling elder is to assist the teaching elder in ruling. The *deacon's* office is confined to temporalities. Church *officers* are elected by the church in which they are to minister, and the church may depose, as well as elect them, though the advice of neighboring churches in such case should be sought. Church officers are to be ordained *after* their election by the church; ordination is the solemn putting a man into his place, but does not constitute an officer. As the people may elect, they may also ordain; though, where there are elders, these, as representing the church, are to perform the service of imposition of hands. In respect to Christ, the head, the Church is a monarchy; in respect to the brotherhood, the body, it resembles a democracy; in respect to the Presbytery, it is an aristocracy. Church government or rule is placed by Christ in the officers of the church, who are subject to the power of the church, and who pronounce sentence with consent of the church.

In a right administration, all church acts proceed after the manner of a mixed administration. There are rules also for the support of church officers, admission and dismission of members, excommunication, etc., all based on the preceding principles; and it is declared that churches, though distinct and equal, ought to preserve church communion with each other, 1st, by way of mutual care; 2d, by way of consultation; 3d, by way of admonition; 4th, by way of participation in acts of worship, etc.; 5th, by way of recommendation; 6th, by way of relief and succor. In gathering a church, this communion should always be attended to.

Synods according to the pattern of Acts xv, though not necessary to the being, are useful for the well-being of the churches. They are constituted by the churches sending forth elders and other messengers to meet together in the name of Christ. A magistrate has power to call a synod, but the constituting of a synod is a church act. Synods are not to exercise church censures by way of discipline, but to debate and determine the principles on which such acts are based, and, so far as consonant with God's Word, they are to be received with reverence and submission. Synods are not permanent ecclesiastical bodies. An article on the power of civil magistrates in matters ecclesiastical completes the platform.—Savage's *Winthrop*, vol. ii; Boston ed. *Cambridge and Saybrook Platforms*; Shedd, *Hist. of Doctrines*, ii, 482. See CONGREGATIONALISTS.

Cambyses (Καμβύσης, a Grecized form of the old Persic *Kambujiya*, a "bard," Rawlinson, *Herodotus*, iii, 456), the second Persian monarch of the name, was the son of Cyrus the Great (but by what mother is disputed), whom he succeeded, B.C. 530. In the fifth year of his reign he invaded Egypt, taking offence, according to Herodotus (iii, 1), at the refusal of Amasia, the father of Psammenitus, the then reigning Egyptian

king, to give him his daughter in marriage; but the real cause of the campaign (comp. Herodotus, i, 77) was the ambition of Cambyses (see Dahlmann, *Herod.* p. 148) to accomplish the design of his father in recovering this portion of Nebuchadnezzar's conquests (see Jer. xliii; Ezek. xxix-xxxii; comp. Newton, *On the Prophecies*, i, 357). See CTRUUS. Egypt was subdued, according to Ctesias, through treachery; according to Pantenus (vii, 9), by intrigue; but according to Herodotus, in a pitched battle, after which the whole country, as also the Cyrenians and Barcans, submitted to him. He proceeded to execute his design of reducing Ethiopia also, but was compelled to retreat for want of provisions, his attack on Carthage having likewise failed through the refusal of his Phœnician allies to co-operate with him against their own colony. He was thus defeated in his plans, which doubtless contemplated the securing to Persia the caravan trade of the Desert (Herod. ii, 1; iii, 1-26; Ctesias, *Pers.* 9; Justin, i, 9; comp. Heeren's *African Nations*, i, 6). Diodorus says, indeed, that he penetrated as far as Meroë, and even founded that city, naming it after his mother; but this statement is equally incorrect (see Strabo, p. 790) with that of Josephus, who says he changed its name to Meroë in honor of his sister (*Ant.* ii, 10, 2). The conduct of Cambyses after this exhibited the darkest character of tyranny to such an extent that the Egyptians, whom he ruled with an iron sway (comp. Isa. xix, 4), attributed to him madness as the punishment of his impiety, and even the Persians ever after styled him the "despot" (*δеспότης*, Herod. iii, 89). Indeed, he appears to have been subject to epileptic fits from his birth (Herod. iii, 8), and his behavior evinced a violence of temper bordering upon frenzy. He is said to have married his own sisters, and to have brutally killed one of them for bewailing the execution of his own brother Smerdis by his order. His atrocities provoked an insurrection, headed by one of the Magian priests, who assumed the name of the murdered prince "Smerdis" (q. v.); and, as Cambyses was marching to put down the pretender, he died at Ecbatana of an accidental wound in the thigh, B. C. 521, leaving no heir (Herod. iii, 61 sq. Ctesias, *Excerpt. Pers.*, gives a somewhat different account of his end, and also makes his reign eighteen years; but Clemens Alexandrinus, *Strom.* i, 295, says he reigned ten years). See PERSIA. He is named *Kambyses* on the Persian tablet of the Behistun inscription (Rawlinson, *Herod.* ii, 492, 493). See CUNEIFORM INSCRIPTIONS. His name also appears on the Egyptian monuments in a royal cartouch. See HIEROGLYPHICS.



K a m b o s e s

Hieroglyph of Cambyses.

Cambyses is probably the "Ahasuerus" mentioned in Ezra iv, 6, as the Persian king addressed by the enemies of the Jews for the purpose of frustrating the rebuilding of the Temple, B. C. 529. Josephus also calls this monarch *Cambyses, the son of Cyrus*, and he gives the correspondence between the king and his Syrian viceroys in detail (*Ant.* xi, ii, 1 and 2), which he has evidently blended with that which took place with his successor, the pseudo-Smerdis ("Artaxerxes," Ezra iv, 7 sq.), since he does not name the latter, but only alludes to the usurpation of the Magians in the interval before the accession of Darius Hystaspis (*ib.* iii, 1). See AHASUERUS.

Camel (a word found in essentially the same form in all the Shemitic languages [Heb. *למך*, *gamal*; Syriac, the same; Chald. *gamala*; ancient Arabic, *jemel*, modern, *jamma*]; in the Greek [*κάμηλος*] and Latin [*camelus*], whence it has passed into the languages of

Western Europe; also in the Coptic *kamoul*. In Sanscrit it occurs as *kramāla* and *kramālakā*; and hence Schlegel traces the word to the root *kram* = to step. Bochart derives it from the root *למך*, to revenge, because the camel is vindictive and retains the memory of injuries [*animal μνησικακόν*]; but Gesenius considers it more likely that *למך* should have assumed the force of the cognate Arabic root *jamal*, to carry, an animal of the order *Ruminantia*, and genus *Camelus*. As constituted by most modern naturalists, it comprises two species positively distinct, but still possessing the common characters of being ruminants without horns, without muzzle, with nostrils forming oblique slits, the upper lip divided, and separately movable and extensible, the soles of the feet horny, with two toes covered by unguiculated claws, the limbs long, the abdomen drawn up, while the neck, long and slender, is bent down and up, the reverse of that of a horse, which is arched. According to other naturalists, however, the two-humped camel, sometimes called the Bactrian camel, is a variety only, not a distinct species (Patterson, *Introd. to Zoology*, p. 417). Camels have thirty-six teeth in all, of which three cuspidate on each side above, six incisors, and two cuspidate on each side below, though differently named, still have all more or less the character of tusks. They have callosities on the breast-bone and on the flexures of the joints. Of the four stomachs, which they have in common with other animals chewing the cud, the ventriculus, or paunch, is provided with membranous cells to contain an extra provision of water, enabling the species to subsist for four or more days without drinking. But when in the desert, the camel has the faculty of smelling it afar off, and then, breaking through all control, he rushes onward to drink, stirring the element previously with a fore-foot until quite muddy. Camels are temperate animals, being fed on a march only once in twenty-four hours, with about a pound weight of dates, beans, or barley, and are enabled in the wilderness, by means of their long flexible necks and strong cuspidate teeth, to snap as they pass at thistles and thorny plants, mimosas and caper-trees. They are emphatically called "the ships of the desert;" having to cross regions where no vegetation whatever is met with, and where they could not be enabled to continue their march but for the aid of the double or single hunch on the back, which, being composed of muscular fibre, and cellular substance highly adapted for the accumulation of fat, swells in proportion as the animal is healthy and well fed, or sinks by absorption as it supplies the want of sustenance under fatigue and scarcity; thus giving an extra stock of food without eating, till by exhaustion the skin of the prominences, instead of standing up, falls over, and hangs like empty bags on the side of the dorsal ridge. Now when to these endowments are added a lofty stature and great agility; eyes that discover minute objects at a distance; a sense of smelling of prodigious acuteness, ever kept in a state of sensibility by the animal's power of closing the nostrils to exclude the acrid particles of the sandy deserts; a spirit, moreover, of patience, not the result of fear, but of forbearance, carried to the length of self-sacrifice in the practice of obedience, so often exemplified by the camel's bones in great numbers strewing the surface of the desert; when we perceive it furnished with a dense wool to avert the solar heat and nightly cold while on the animal, and to clothe and lodge his master when manufactured, and know that the female carries milk to feed him, we have one of the most incontrovertible examples of Almighty power and beneficence in the adaptation of means to a direct purpose that can well be submitted to the apprehension of man; for, without the existence of the camel, immense portions of the surface of the earth would be uninhabitable, and even impassable. Surely the Arabs

are right: "Job's beast is a monument of God's mercy!"

1. The Bactrian camel (*camelus Bactrianus* of authors) is large and robust; naturally with two hunches, and originally a native of the highest table-lands



Bactrian Camel.

of Central Asia, where even now wild individuals may be found. The species extends through China, Tartary, and Russia, and is principally imported across the mountains into Asia Minor, Syria, and Persia. It is seldom seen at Aleppo (Russel, *N. H. Aleppo*, ii, 170). One appears figured in the processions of the ancient Persian satrapies among the bas-reliefs of Chehel Minar, where the Arabian species is not seen. It is also this species which, according to the researches of Burckhardt, constitutes the brown Taous variety of single-hunched Turkish or Toorkee camels commonly seen at Constantinople, there being a very ancient practice among breeders, not, it appears, attended with danger, of extirpating with a knife the foremost hunch of the animal soon after birth, thereby procuring more space for the pack-saddle and load. It seems that this mode of rendering the Bactrian cross-breed similar to the Arabian camel or dromedary (for Burckhardt misapplies the last name) is one of the principal causes of the confusion and contradictions which occur in the descriptions of the two species, and that the various other intermixtures of races in Asia Minor and Syria, having for their object either to create greater powers of endurance of cold or of heat, of body to carry weight, or to move with speed, have still more perplexed the question. From these causes a variety of names has arisen, which, when added to the Arabian distinctions for each sex, and for the young during every year of its growth, and even for the camels nursing horse-foals, has made the appellatives exceedingly numerous. We notice only—

2. The Arabian camel or dromedary (*camelus dromedarius* or *Arabicus* of naturalists, בְּכֵר, *be'ker*, and female and young בְּכֵרָה, *bitrah*), both "dromedary," Isa. lx, 6; Jer. ii, 28) is properly the species having naturally but one hunch, and considered as of Western Asiatic or of African origin, although no kind of camel is figured on any monument of Egypt (Wilkinson, *Anc. Eg.* i, 234), not even where there are representations of live-stock such as that found in a most ancient tomb beneath the pyramid of Gizeh, which shows herdsmen bringing their cattle and domesticated animals to be numbered before a steward and his scribe, and in which we see oxen, goats, sheep, asses, geese, and ducks, but neither horses nor camels. That they were not indigenous in the early history of Egypt is countenanced by the mythical tale of the priests describing "the flight of Typhon, seven days' journey upon an ass." We find, however, camels mentioned in Genesis xii; but being placed last among the cattle given by Pharaoh to Abraham, the fact seems to show that they were not considered as the most important

part of his donation. This can be true only upon the supposition that but a few of these animals were delivered to him, and therefore that they were still rare in the valley of the Nile, though soon after there is abundant evidence of the nations of Syria and Palestine having whole herds of them fully domesticated. These seem to imply that the genus *Camelus* was originally an inhabitant of the elevated deserts of Central Asia, its dense fur showing that a cold but dry atmosphere was to be encountered, and that it came already domesticated, toward the south and west, with the oldest colonies of mountaineers, who are to be distinguished from earlier tribes that subdued the ass, and perhaps from others still more ancient, who, taking to the rivers, descended by water, and afterward coasted and crossed narrow seas. Of the Arabian species two very distinct races are noticed; those of stronger frame but slower pace used to carry burdens varying from 500 to 700 weight, and travelling little more than twenty-four miles per day; and those of lighter form, bred for the saddle with single riders, the fleetest serving to convey intelligence, etc., and travelling at the rate of 100 miles in twenty-four hours. They are designated by several appellations, such as *Deloul*, the best coming



Arabian Camel.

from Oman, or from the Bishareens in Upper Egypt; also *Hejin* by the Turks, and still other names (e. g. *Ashaary*, *Maherry*, *Reches*, *Badees* at Herat, Rawahel, and Racambel) in India, all names more or less implying swiftness, the same as *δρομας*, *swift*; the difference between them and a common camel being as great as that between a high-bred Arab mare and an English cart-horse (Layard, *Nineveh* and *Bab.* p. 292). Caravans of loaded camels have always scouts and flankers mounted on these light animals, and in earlier ages Cyrus and others employed them in the line of battle, each carrying two archers. The Romans of the third and fourth centuries of our era, as appears from the "*Notitia*," maintained in Egypt and Palestine several *ala* or squadrons mounted on dromedaries; probably the wars of Belisarius with the northern Africans had shown their importance in protecting the provinces bordering on the desert; such was the *ala dromedariorum Antana* at Ammata in the tribe of Judah, and three others in the Thebais (comp. 1 Sam. xxx, 17). Bonaparte formed a similar corps, and in China and India the native princes and the East India Company have them also.

It is likely the word אַחַשְׁתְּרָסִים, *achashteranim*' (Eth. viii, 10, 14), rendered "camels," more properly signifies *mules* (being explained by the addition "sons of mares," mistranslated "young dromedaries"), and implies the swift postage or conveyance of orders, the whole verse showing that all the means of dispatch were set in motion at the disposal of government (see the dissertation on this word by Schelhorn, in the *Misc. Lips.* x, 231-44). On the other hand, רֶכֶשׁ, *re'esh* (translated "mules" in the above pas-

sage, and rendered "dromedary" in 1 Kings iv, 28; "swift beast" in Mic. i, 18), we take to be one of the many names for running camels (as above), used to carry expresses; or post-horses, anciently *Asandî* or *Asandî*, now *Chupper* or *Chuppaw*, which, according to Xenophon, existed in Persia in the time of Cyrus, and are still in use under different appellations over all Asia. The *kirkaroth'* (קִּרְקָרוֹת, rendered "swift beasts") of Isa. lxxi, 20, were probably also a kind of dromedary.

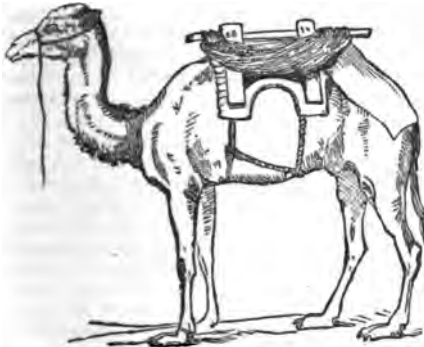

Camel for Baggage.

All camels, from their very birth, are taught to bend their limbs and lie down to receive a load or a rider. They are often placed circularly in a recumbent posture, and, together with their loads, form a sufficient rampart of defence against robbers on horseback. The milk of she-camels is still considered a

very nutritive cooling drink (Aristot. *Hist. Anim.* vi, 25, 1; Pliny, *N. H.* xi, 41; xxviii, 9), and when turned it becomes intoxicating (such, according to the Rabbins [Rosenmüller, *Not. ad Hieroz.* i, 10], was the drink offered [Judg. iv, 19] by Jael to Sisera [comp. Josephus, *Ant.* v, 5, 4]). Their dung supplies fuel in the desert and in sandy regions where wood is scarce; and occasionally it is a kind of resource for horses when other food is wanting in the wilderness. Their flesh, particularly the hunch, is in request among the Arabs (comp. Prosp. Alp. *H. N. Æg.* i, 226), although forbidden to the Hebrews, more perhaps from motives of economy, and to keep the people from again becoming wanderers, than from any real uncleanness. Camels were early a source of riches to the patriarchs, and from that period became an increasing object of rural importance to the several tribes of Israel, who inhabited the grazing and border districts, but still they never equalled the numbers possessed by the Arabs of the desert. In what manner the Hebrews derived the valuable remunerations obtainable from them does not directly appear, but it may be surmised that by means of their camels they were in possession of the whole trade that passed by land from Asia Minor and Syria to the Red Sea and Egypt, and from the Red Sea and Arabia toward the north and to the Phœnician sea-ports. On swift dromedaries the trotting motion is so hard that to endure it the rider requires a severe apprenticeship; but riding upon slow camels is not disagreeable, on account of the measured step of their walk; ladies and women in general are conveyed upon them in a kind of wicker-work sedan, known as the *takht-ravan* of India and Persia. In some cases this piece of female equipage presents almost a formidable appearance.



A Shammar Lady on a Camel.

The camels which carried the king's servants or guests, according to Philostratus, were always distinguished by a gilded boss on the forehead. The camel, being a native of Asia, from the earliest ages to the present day has been the chief means of communication between the different regions of the East, and from its wonderful powers of endurance in the desert has enabled routes to be opened which would otherwise have been impracticable. "Their home is the desert; and they were made, in the wisdom of the Creator, to be the carriers of the desert. The coarse and prickly shrubs of the wastes are to them the most delicious food, and even of these they eat but little. So few are the wants of their nature, that their power of going

without food, as well as without water, is wonderful. Their well-known habit of lying down upon the breast to receive their burdens is not, as is often supposed, merely the result of training; it is an admirable adaptation of their nature to their destiny as carriers. This is their natural position of repose, as is shown, too, by the callosities upon the joints of the legs, and especially by that upon the breast. Hardly less wonderful is the adaptation of their broad cushioned foot to the arid sands and gravelly soil which it is their lot chiefly to traverse. . . . As the carriers of the East, the 'ships of the desert,' another important quality of the camel is their sure-footedness" (Robinson, *Researches*, ii, 682-635). The present geograph-

ical distribution of the camel extends over Arabia, Syria, Asia Minor to the foot of the Caucasus, the south of Tartary, and part of India. In Africa it is found in the countries extending from the Mediterranean to the Senegal, and from Egypt and Abyssinia to Algiers and Morocco. A number of camels have lately been imported into the United States, designed for transportation in the arid plains of the extreme southwestern territories; but the result of the experiment is yet doubtful (Marsh, *The Camel*, etc. Bost. 1856). (For a farther view of the natural history of the camel, see the *Penny Cyclopædia*, s. v.) See DROMEDARY.

The camel is frequently mentioned in Holy Scripture. It was used not only in Palestine, but also in Arabia (Jud. vii, 12), in Egypt (Exod. ix, 8), in Syria (2 Kings viii, 9), and in Assyria, as appears from the

a wife for Isaac portrays the habits of a nomad people, perhaps most of all when Rebekah, like an Arab damsel, lights off her camel to meet Isaac (xxiv). Jacob, like Abraham, had camels (xxx, 43): when he left Padan-aram he "set his sons and his wives upon camels" (xxxi, 17); in the present he made to Esau there were "thirty milch camels with their colts" (xxxii, 15). In Palestine, after his return, he seems no longer to have kept them. When his sons went down to Egypt to buy corn, they took asses. Joseph sent wagons for his father and the women and children of his house (xlv, 13, 27; xlvii, 5). After the conquest of Canaan, this beast seems to have been but little used by the Israelites, and it was probably kept only by the tribes bordering on the desert. It is noticeable that an Ishmaelite was overseer of David's camels

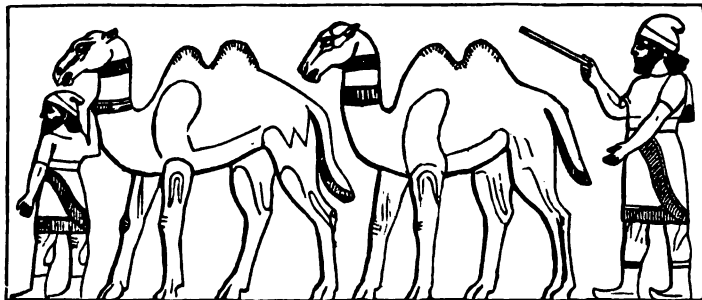

Two-humped Camels. From the Black Obelisk at Nimrud.

sculptures of Nineveh (see Layard, *Nineveh and Bab.* p. 582). It was used at an early date both as a riding animal and as a beast of burden (Gen. xxiv, 64; xxxvii, 25). It was likewise used in war (1 Sam. xxx, 17; Isa. xxi, 7; comp. Pliny, *N. H.* viii, 18; Xenoph. *Cyrop.* vii, 1, 27; Herod. i, 80; vii, 86; Livy, xxxvii, 40). Of its hair coarse garments were manufactured (Matt. iii, 4; Mark i, 6). The Jews were not allowed to eat its flesh (Lev. xi, 4; Deut. xiv, 7). The prophet Isaiah foretells the great increase and flourishing state of the Messiah's kingdom, by the conversion and accession of the Gentile nations, by comparing the happy and glorious concourse to a vast assemblage of camels (lx, 6). He also predicts the march of the army of Cyrus to the conquest and destruction of Babylon by an allusion to a chariot of camels (xxi, 7); and the folly and presumption of those is remarked upon (xxx, 6) who, in the time of their trouble, carried treasures on camels into Egypt to purchase the assistance of that people, and acknowledged not the Lord their God, who alone could save and deliver them.

In the history of the Hebrews, however, the camel was used only by nomad tribes. This is because the desert is the home of the Arabian species, and it cannot thrive in even so fine a climate as that of the valley of the Nile in Egypt. The Hebrews in the patriarchal age had camels as late as Jacob's journey from Padan-aram, until which time they mainly led a very wandering life. With Jacob's sojourn in Palestine, and, still more, his settlement in Egypt, they became a fixed population, and thenceforward their beast of burden was the ass rather than the camel. The camel is first mentioned in a passage which seems rather to tell of Abraham's wealth (Gen. xii, 16, as xxiv, 35), to which Pharaoh doubtless added, than to recount the king's gifts. If the meaning, however, is that Pharaoh gave camels, it must be remembered that this king was probably one of the shepherds who partly lived at Avaris, the Zoan of Scripture; so that the passage would not prove that the Egyptians then kept camels, nor that they were kept beyond a tract, at this time, and long after, inhabited by strangers. The narrative of the journey of Abraham's servant to fetch

(1 Chron. xxvii, 80). On the return from Babylon the people had camels, perhaps purchased for the journey to Palestine, but a far greater number of asses (Ezra ii, 67; Neh. vii, 69). There is one distinct notice of the camel being kept in Egypt. It should be observed, that when we read of Joseph's buying the cattle of Egypt, though horses, flocks, herds, and asses are spoken of (Gen. xlvii, 17), camels do not

occur: they are mentioned as held by the Pharaoh of the exodus (Exod. ix, 8), but this may only have been in the most eastern part of Lower Egypt, for the wonders were wrought in the field of Zoan, at which city this king then doubtless dwelt. It is in the notices of the marauding nomad tribes that wandered to the east and south of Palestine that we chiefly read of the camel in Scripture. In the time of Jacob there seems to have been a regular traffic between Palestine, and perhaps Arabia, and Egypt, by camel caravans, like that of the Ishmaelites or Midianites who bought Joseph (Gen. xxxvii, 25, 28). In the terrible inroad of the Midianites, the Amalekites, and the Bene-Kedem, or children of the East, "both they and their camels were without number; and they entered into the land to destroy it" (Judg. vi, 5; comp. vii, 12). When Gideon slew Zebah and Zalmunna, kings of Midian, he "took away the ornaments [or "little moons"] that [were] on their camels' necks" (viii, 21), afterward mentioned, with neck-chains (see Kitto, *Phys. Hist. of Pal.* p. 891; comp. Stat. *Thebaid*, ix, 687), both probably of gold (ver. 26). We also find other notices of the camels of the Amalekites (1 Sam. xv, 8; xxx, 17), and of them and other and probably kindred peoples of the same region (xxvii, 8, 9). In the account of the conquest by the Reubenites, the Gadites, and the half tribe of Manasseh, of the Hagarites beyond Jordan, we read that fifty thousand camels were taken (1 Chron. v, 18-28). It is not surprising that Job, whose life resembles that of an Arab of the desert, though the modern Arab is not to be taken as the inheritor of his character, should have had a great number of camels (Job i, 8; xlii, 12; comp. Aristot. *Hist. Anim.* ix, 87, 5). The Arabian Queen of Sheba came with a caravan of camels bearing the precious things of her native land (1 Kings x, 2; 2 Chron. ix, 1). We read also of Benhadad's sending a present to Elieha "of every good thing of Damascus, forty camels' burden" (2 Kings viii, 9). Damascus, be it remembered, is close to the desert. In the prophets, likewise, the few mentions of the camel seem to refer wholly to foreign nations, excepting where Isaiah speaks of their use, with asses, in a caravan bearing presents from the Israelites to the Egyptians (xxx, 6). He alludes

to the camels of Midian, Ephah, and Sheba, as in the future to bring wealth to Zion (lx, 6). The "chariot of camels" may be symbolical (xxi, 7), or it may refer to the mixed nature of the Persian army. Jeremiah makes mention of the camels of Kedah, Hazor, and the Bene-Kedem (xlix, 28-33). Ezekiel prophesies that the Bene-Kedem should take the land of the Ammonites, and Rabbah itself should be "a resting-place for camels" (xxv, 1-5; see Buckingham, *Trav.* p. 829).—Kitto, *Cyclop.* s. v.; Smith, *Dict.* s. v.

The camel is classed by Moses among unclean animals (Lev. xi, 4), "because he cheweth the cud, but divideth not the hoof." Michaelis justly remarks, that in the case of certain quadrupeds a doubt may arise whether they do fully divide the hoof or ruminates. "In such cases," he says, "to prevent difficulties, a legislator must authoritatively decide; by which I do not mean that he should prescribe to naturalists what their belief should be, but only to determine, for the sake of expounders or judges of the law, what animals are to be regarded as ruminating or parting the hoof." This doubt arises in the case of the camel, which does ruminates, and does in some sort divide the hoof; that is, the foot is divided into two toes, which are very

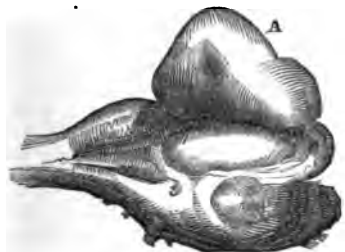

Inside of a Camel's Foot. A is the cushion on which the animal treads, shown as lifted out of its bed.

distinctly marked above, but below the division is limited to the anterior portion of the foot, the toes being cushioned upon and confined by the elastic pad upon which the camel goes. This peculiar conformation of the foot renders the division incomplete, and Moses, for the purposes of the law, therefore decides that it divides not the hoof. Perhaps in this nicely balanced question the determination against the use of the camel for food was made with the view of keeping the Israelites distinct from the other descendants of Abraham, with whom their connection and coincidence in manners were otherwise so close. The interdiction of the camel, and, of course, its milk, was well calculated to prevent them from entertaining any desire to continue in Arabia, or from again devoting themselves to the favorite occupation of nomade herdsmen, from which it was obviously the intention of many of the laws to wean them. In Arabia a people would be in a very uncomfortable condition who could neither eat camel's flesh nor drink its milk. Of the constant use of its milk by the Arabs travellers frequently speak; and if we wanted a medical reason for its interdiction, it might be found in the fact that to its constant use is attributed the obstructions and indurations of the stomach, which form one of the most common complaints of the Arabs. They do not kill the camel, or any other animal, for ordinary food; but when a camel happens to be lamed in a caravan, it is killed, and a general feast is made on its flesh. Camels are also killed on great festival occasions, and sometimes to give a large entertainment in honor of a distinguished guest. Sometimes also a man vows to sacrifice a camel if he obtain this or that blessing, as, for instance, if his mare brings forth a female; and in that case he slaughters the animal, and feasts his friends on the flesh. Burckhardt (*Notes on the Bedouins*) mentions the rather remarkable fact that the Arabs know no remedy against the three most dangerous dis-

eases to which camels are subject; but they believe that the Jews in their sacred books have remedies mentioned, which they withhold through hatred and malice. The flesh of the camel is coarse grained, but is rather juicy and palatable when the animal is young and not poorly fed. It is inferior to good beef, although at first it might readily be mistaken for beef; but it is at least equal, if not superior, to horse-flesh (Kitto, *Pict. Bible*, note in loc.).

To pass a camel through the eye of a needle was a proverbial expression which our Lord employed in his discourse to the disciples to show how extremely difficult it is for a rich man to forsake all for his cause and obtain the blessings of salvation (Matt. xix, 24; Mark x, 25; Luke xviii, 25; see the treatises on this passage, in Latin, of Clodius [Viteb. 1665], Pfeiffer [Regiom. 1679], Fetzlen [Viteb. 1678]). Many expositors are of opinion that the allusion is not to the camel, but to the cable by which an anchor is made fast to the ship, changing *κάμηλος*, a camel, to *κάμιλος*, a cable; but for this there is no critical foundation; and Lightfoot and others have shown that to speak of a camel, or any other large animal, as going through the eye of a needle was a proverbial expression, much used in the Jewish schools, to denote a thing very unusual or very difficult. There is a similar expression in the Koran: "The impious, who, in his arrogancy, shall accuse our doctrine of falsity, shall find the gates of heaven shut; nor shall he enter there till a camel shall pass through the eye of a needle. It is thus that we shall recompense the wicked." Roberts mentions a parallel proverb used in India to show the difficulty of accomplishing any thing: "Just as soon will the elephant pass through the spout of a kettle."

Another proverbial expression occurs in Matt. xxiii, 24: "Strain at (*στραλίζω*) a gnat and swallow a camel." Dr. Adam Clarke proves that "at" has been substituted for "out," by a typographical error in the edition of 1611, in our version, "out" occurring in Archbishop Parker's of 1568. The reference is to a custom the Jews had of filtering their wine, for fear of swallowing any insect forbidden by the law as unclean. The expression is, therefore, to be taken hyperbolically, and, to make the antithesis as strong as possible, two things are selected, the smallest insect and the largest animal. The proverb is applied to those who are superstitiously anxious to avoid small faults, and yet do not scruple to commit the greatest sins.

CAMELS' HAIR (*τριχες καμήλου*), a material of clothing. John the Baptist was habited in raiment of camels' hair (Matt. iii, 4; Mark i, 6), and Chardin states that such garments are worn by the modern dervishes. There is a coarse cloth made of camels' hair in the East, which is used for manufacturing the coats of shepherds and camel-drivers, and also for the covering of tents (Harnar, *Obs.* ii, 487; comp. *Ælian*, *Nat. Hist.* xvii, 84). It was doubtless this coarse kind which was adopted by John. By this he was distinguished from those residents in royal palaces who wore soft raiment. Elijah is said in the English Bible to have been "a hairy man" (2 Kings i, 8); but it may mean "a man dressed in hair"—that is, camels' hair. In Zech. xiii, 4, "a rough garment"—that is, a garment of a hairy manufacture—is characteristic of a prophet. (See *Manufactures of the Ancients*, N. Y. 1848, p. 812 sq.; Hackett's *Illustra. of Script.* p. 96.)

CAMELEON. See CHAMELEON.

Camerarius, JOACHIM, one of the most scholarly men of the sixteenth century, was born at Bamberg, April 12, 1500. The original name of his family was Liebhart, which was changed into the Latin Camerarius (Chamberlain) because his ancestors had been chamberlains at the court of the bishops of Bamberg. He was sent to the University of Leipzig, where he studied Greek under Richard Croke

and Peter Mosellanus. He evinced an extraordinary passion for that language, and in 1524 put forth his first work, a Latin translation of one of the Orations of Demosthenes. He was at that period at Wittenberg, whither he had been drawn by the fame of Luther and Melancthon. In 1526 he went into Prussia, and in the year following was nominated by Melancthon to fill the office of Greek and Latin professor in the new college at Nuremberg. The senate of Nuremberg deputed him, in 1530, to attend the diet of Augsburg, where he aided Melancthon in the disputes, and in preparing the material afterward used in the *Apologia Confessionis*. See CONFESSIONS. In 1535 the Duke of Württemberg gave him the direction of the new University of Tübingen. In 1541 he was charged by Henry of Saxony with reforming the University of Leipzig, of which he was afterward appointed rector. Here he laboured zealously for the Reformation, and at the same time was one of the most laborious classical and theological teachers of the age. With his friend Melancthon he took an active part in the negotiations concerning the Interim, and for his willingness to make concessions was severely censured by the opponents of the Interim. In 1554 he was a deputy to the Diet of Naumburg, and in 1555 to the Diet of Augsburg, from where he went to Nuremberg to aid in adjusting the Osiandrian controversy. In 1568 the Emperor Maximilian, who had called him to Vienna to consult him about some important state affairs, wished to retain him as his councillor, but Camerarius declined the offer on account of his infirmities. He died at Leipzig in April, 1574. Camerarius was grave and reserved even toward his own children. He hated nothing so much as untruthfulness, and did not even tolerate it in jests. The extent of his knowledge, the purity of his morals, the energy of his character, his sweet and persuasive eloquence, obtained for him the esteem of all those who knew him. He left five sons, all of whom distinguished themselves as scholars or in other high positions. A list of his numerous writings will be found in Nicéron, *Mémoires*, t. xix. Among his works in theology and exegesis are, 1. *Synodica*, i. e. *de Nicenâ Synodo* (Leipzig, 1543, 4to).—2. *Disputatio de piis et catholicis atq. orthodoxis precibus et invocationibus Numinis Divini* (Argentor. 1560, 8vo).—3. *Chronologia secundum Græcorum rationem, temporibus expositis, auctore Nicephoro Archiep. Constantino, conversa in linguam Lat.* (Basle, 1561, fol.; Leipzig, 1574 and 1583, 4to).—4. *Historia de Jesu Christi ad mortem pro genere humano accessione, etc.* (Leipzig, 1563).—5. *Narrat. de P. Melancthonis ortu, vita, etc.*, which contains an entire history of the Reformation (1566; best ed. by Strobel, Halle, 1777, 8vo).—6. *Notatio figurarum sermonis in iv libris Evangeliorum, etc.*: *Notatio in Apostolicis scriptis et in librum Actuum et Apocalypsoas* (these two works were published together at Cambridge in 1642, under the title *Commentarius in Novum Fœdus*; and at Frankfurt in 1712, with the title *Ezechiele Nov. Test.*).—7. *Homilia* (Leipzig, 1573).—8. *Historica narratio de Fratrum orthodoxorum ecclesiis in Bohemia, Moravia et Polonia* (Heidelb. 1605, 8vo). He also published a collection of the letters of Melancthon (Leipzig, 1569), which contain much valuable information of the times of the Reformation.—Hoefler, *Nov. Biog. Générale*, viii, 319; Landon, *Ecol. Dictionary*, ii, 506.

Camero, or **Cameron, John**, one of the greatest Protestant divines of France in the seventeenth century, and founder of the "moderate" school of Calvinism, was born in Glasgow 1579 or 1580. Before he was twenty he began to lecture in Greek at the University of Glasgow; in 1600 he went to France; and in 1602 he was made professor of philosophy at Sedan. The Church of Bordeaux defrayed his expenses for four years in studying theology at Paris, Geneva, and Heidelberg. In 1608 he became pastor at Bordeaux, where he preached with great success until 1618, when

he became professor of theology at Saumur; but on the dispersion of the University in 1621 by the civil wars he returned to Glasgow, where he taught a short time, and in 1624 was chosen professor of theology at Montauban, France, where he was killed, in a political tumult, in 1625.

Camero's theology was modified Calvinism. He opposed "the imputation of the active righteousness of Christ," and "the non-concurrence of the human will with the grace of God in man's conversion." He "adopted from Arminius the doctrine of universal redemption, and the duty of presenting the offer of salvation, without restriction, to all men." His views were adopted and developed by Amyraut, Placcæus, and Cappellus (q. v.), especially the view that God does not "move the will physically, but only morally, in virtue of its relations to the judgment and intellect." His doctrine, however, is far removed from Arminianism, as is shown by his colloquy with Tilenus—*Amica Collatio de Gratia et Volent. Humana concursu* (Leyden, 1621) [see TILENUS]—and also by his *Defensio de Gratia et Libero Arbitrio* (Saumur, 1624, 8vo). His doctrine of universal grace may be thus summed up: (1) "that God desires the happiness of all men, and that no mortal is excluded by any divine decree from the benefits that are procured by the death, sufferings, and gospel of Christ; (2) that, however, none can be made a partaker of the blessings of the Gospel, and of eternal salvation, unless he believe in Jesus Christ; (3) that such, indeed, is the immense and universal goodness of the Supreme Being, that He refuses to none the power of believing, though he does not grant unto all His assistance and succor, that they may wisely improve this power to the attainment of everlasting salvation; and that, in consequence of this, multitudes perish through their own fault, and not from any want of goodness in God." Those who embraced this doctrine were called *Universalists*, because they represented God as willing to show mercy to all mankind; and *Hypothetical Universalists*, because the condition of faith in Christ was necessary to render them the objects of this mercy. See AMYRAUT. His writings are collected under the title *Opera, partim ab auct. edita, partim post ej. obiit. vulgata* (Genev. 1658, fol.).—Calder, *Life of Episcopius*, 456; Hook, *Ecol. Biog.* ii, 407; Nichols, *Calvinism and Arminianism*, i, 202 sq.; Watson, *Theol. Inst.* ii, 215, 411; Smith's Hagenbach, *Hist. of Doctrines*, § 225, a.

Cameron, Archibald, a Presbyterian minister, was born in Scotland in 1771 or 1772. When young, he migrated with his parents to America. Little is known of his early years but that he spent some time at the Transylvania University (Kentucky), and completed his studies at Bardstovon, when he connected himself with the Prebyterian Church. In 1795 he was licensed, and, as a missionary, distributed his labors in the counties of Nelson, Shelby, and Jefferson. He was installed in 1796 over the churches of Akron and Fox Run, Shelby, and Big Spring in Nelson, and for several years the field of his labors embraced a circuit of from thirty to forty miles. Seven churches were organized by his instrumentality, and he was often obliged to swim the swollen streams to do his duty. During a revival in 1823 large additions were made to his churches, and from this time he supplied the congregations of Shelbyville and Mulberry. He died December 4, 1836. He published *The Faithful Steward* (1806):—*The Monitor, on Religious Liberty*, etc. (1806):—*An Appeal to the Scriptures*, etc. (1811):—*A Discourse between the Confession of Faith of the Presbyterian Church and a Preacher who holds the Doctrine of an Indefinite and Universal Atonement* (1814):—*A Defence of the Doctrines of Grace* (a series of Letters, 1816):—*A Reply to Questions on Predestination*, etc. (1822).—Sprague, *Annals*, iv, 168.

Cameron, Richard, founder of the "Cameronians" or "Covenanters," was born at Falkland, in the

county of Fife. He first acquired notice by his bold opposition to the measures of Charles II for enforcing the Episcopal form of worship on the Scottish people. The measures adopted by the government roused the people, and among those who gave fullest expression to the popular sentiments was Richard Cameron. He belonged to the extreme party, who held by the perpetually binding obligations of the Solemn League and Covenant [see COVENANTS], which were set aside at the restoration of Charles II. Along with some others, he strenuously resisted the measures that reinstated the Episcopal Church in Scotland, and that proscribed the meetings for public worship of unauthorized religious bodies. Contrary to law, he persisted in preaching in the fields, and became obnoxious to government, to which, indeed, he finally assumed an attitude of defiance. Not only were his doctrines obnoxious to the government, but many of his brethren of the clergy dreaded his zeal, which they considered extreme, and at a meeting held in Edinburgh in 1677 they formally reprovved him. He retired to Holland, but soon returned; and on the 22d of June, 1680, in company with about twenty other persons, he entered the town of Sanguhar in Dumfriesshire, and at the market-cross proclaimed that Charles Stuart had, by his perjuries, his tyrannical government, and his usurpation, forfeited all right and title to the crown. The party kept together in arms for a month; but on the 20th of July, while lying at Airdsmoss in Kyle, they were surprised by a large body of horse and foot, and in the skirmish which followed Cameron was killed, and his followers were dispersed or taken prisoners. A neat monument has been recently placed on the spot where Cameron fell, replacing an old and plainer structure.—*English Cyclopædia*; Chambers' *Encyclopædia*; Hetherington, *Hist. of Church of Scotland*, II, 106 sq.; *Biog. Presbyteriana* (Edinb. 1885, vol. i). See COVENANTERS.

Cameronians (1.), the mitigated Calvinists, who followed the opinions of John Camero (q. v.). (2.) The anti-prelatical party in Scotland, so called from Richard Cameron (q. v.). See COVENANTERS.

Cameronists. See CAMERONIANS.

Camisards (from the French *camise*, a peasant's jacket), a sect of fanatics (made such by oppression) in France toward the end of the seventeenth century. The predictions of Brousson (q. v.) and Jurieu, as to the coming downfall of the papacy and the end of the world seem to have given a bent to the minds of the Protestants of Dauphiné and Vivarais. "In 1688 five or six hundred Protestants of both sexes gave themselves out to be prophets, and inspired of the Holy Ghost. They had strange fits, which came upon them with faintings, as in a swoon, which made them stretch out their arms and legs, and stagger. They struck themselves with their hands; they fell on their backs, shut their eyes, and heaved their breasts. The symptoms answer to those produced by inspiring nitrous oxide, and, were the fact then discovered, we should have been tempted to suspect imposture. They remained a while in trances, and, coming out of them, declared that they saw the heavens open, the angels, paradise, and hell. Those who were just on the point of receiving the spirit of prophecy dropped down, not only in the assemblies, but in the fields, and in their own houses, crying out *Mercy*. The least of their assemblies made up four or five hundred, and some of them amounted to even three or four thousand. The hills resounded with their loud cries for mercy, and with imprecations against the priests, the pope, and his anti-Christian dominion, with predictions of the approaching fall of popery. All they said at these times was heard and received with reverence and awe." The government finally interfered with a violence which naturally increased the disorder. In 1702 a number of the Camisards were put to death with torture. A war arose, in which Cavalier, a young

baker, became prominent as an able leader. The Marshal de Montrevel was sent by the court to quell these disturbances, and, after him, Marshal Villars; and, after a long series of the most barbarous massacres and perfidious cruelties, these wretched people were finally, in 1705, put down. Cavalier submitted, and afterward went to England. Ravance, Catinat, and Francézé, three of their leaders, were burned alive, and Vilas and Jonquet, also commanders of their forces, together with two merchants who assisted them, broken on the wheel. Many of these Camisards fled to England. See Smedley, *Reformed Religion in France*, vol. iii, ch. xxv; *Theatre Sacré des Cévennes* (London, 1707, by Max Misson, the chief source of information); *The Wars of the Cévennes under Cavalier* (Dublin, 1726); Schulz, *Geschichte der Camisarden* (Weimar, 1790); Court, *Hist. des troubles des Cévennes* (Villefranche, 1760); *Histoire des Camisards* (Lond. 1744); Peyrat, *Hist. des Pasteurs du Desert* (Paris, 1842); Hoffmann, *Gesch. des Auführers in den Cévennes* (Nördlingen, 1887). See FRENCH PROPHETS.

Cammerhof, JOHN FREDERICK, one of the first bishops of the Moravian Church in America, was born near Magdeburg, Germany, July 28, 1721. Entering the Moravian ministry, he was sent to America as assistant to the presiding bishop, and arrived at a time when the Church at Bethlehem was a centre of missionary activity among the American Indians. "In all the mission stations in Pennsylvania and New York Cammerhof was active, proclaiming the crucified one with great power to the wild warriors, and through the agency of faithful interpreters, among whom was the famous missionary David Zeisberger, inviting them in eloquent appeals to look up and see their salvation finished." He won the confidence of the Indians, especially of the Delawares and the Six Nations, and in 1748 he was formally adopted by the Oneidas as a member of their tribe. In 1750 he attended an Iroquois council at Onondago, N. Y., travelling by canoes up the Susquehanna for 18 days, and thence on foot through the wild mountain regions of Southern New York a fortnight more. The journey broke down his constitution, and he died at Bethlehem, April 28, 1771.—*The Moravian*, Sept. 26, 1861.

Ca'mon (Heb. *Kamon*, קָמוֹן, perhaps full of stalks or grain; Sept. *Kamoun* v. r. *Καμών*), the place in which Jair (q. v.) the Judge was buried (Judg. x, 5). As the scriptural notices of him all refer to the country east of Jordan, there is no reason against accepting the statement of Josephus (*Ant.* v, 7, 6) that Camon (*Καμών*) was a city of Gilead. In support of this is the mention by Polybius (v, 70, 12) of a *Camus* (*Καμουός*, for *Καμουών*) in company with Pella and other trans-Jordanic places taken by Antiochus (Reland, *Palest.* p. 679; Ritter, *Erdk.* xv, 1026). Eusebius and Jerome (*Onomast.* s. v. *Καμών*, Camon) evidently confound it with the *Cyamon* (Judith vii, 8) in the plain of Esdrælon; and this has misled Schwarz (*Palest.* p. 238). It is possibly the modern *Reimuz* (comp. the Sept. reading *Rhamon*), four and a half miles west-north-west of Jerash or Gerass (Van de Velde's Map).

Camp (מַחֲנֵה, *machaneh*'), an encampment, whether of troops or nomades, especially of the Israelites in the desert; hence also put for *troops* or a *company* itself; once מַחֲנֵהוֹתָי, *machanoth*'), *camp*, i. e. place of encampment, 2 Kings vi, 8; *καταβολή*, Heb. xiii, 11, 18; Rev. xx, 9; elsewhere "castle"). Of the Jewish system of encampment the Mosaic books have left a detailed description. From the period of the sojourn in the wilderness to the crossing of the Jordan the twelve tribes were formed into four great armies, encamping in as many fronts, or forming a square, with a great space in the rear, where the tabernacle of the Lord was placed, surrounded by the tribe of

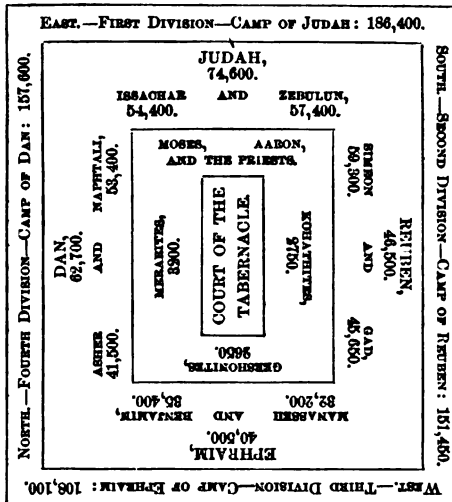

Diagram of the Camp of the Israelites during the Exode.

Levi and the bodies of carriers, etc., by the stalls of the cattle and the baggage: the four fronts faced the cardinal points while the march was eastward, but, as Judah continued to lead the van, it follows that, when the Jordan was to be crossed, the direction became westward, and therefore the general arrangement, so far as the cardinal points were concerned, was reversed. It does not appear that, during this time, Israel ever had lines of defence thrown up; but in after ages, when only single armies came into the field, it is probable that the castral disposition was not invariably quadrangular; and, from the many positions indicated on the crests of steep mountains, the fronts were clearly adapted to the ground and to the space which it was necessary to occupy. The rear of such positions, or the square camps in the plain, appear from the marginal reading of 1 Sam. xvii, 20, and xxvi, 5, to have been enclosed with a line of carts or chariots, which, from the remotest period, was a practice among all the nomade nations of the north. (D'Aquino, *Le Camp des Israelites*, Par. 1623, 1624.) —Kitto, *Cyclop. s. v.* Encampments. For a more general treatment of the subject, from a military point of view, see ENCAMP.

Campanarium or **CAMPANILE** (Lat. *campana*, bell), a bell-tower. The most striking campaniles are found in Italy, and they are those generally detached from the church, e. g. those of Florence, Cremona, Bologna, and Pisa. That of Florence, built by Giotto (1334), is a square 45 feet on each side and 267 feet high, in Italian Gothic, simple in design, but richly ornamented. In some instances these towers, on account of their great elevation and the narrowness of their base, have considerably deviated from the original perpendicular. The Campanile of Pisa, called *Torre Pendente* ("the leaning tower"), is the most remarkable of these, having a deviation of nearly 18 feet in a height of 150 feet. See BELL.

Campanella, THOMAS, was born in Calabria 1568, and entered the Dominican order 1594. He applied himself chiefly to metaphysics, and followed his countryman Telesio, who died in 1588 at Coenza, in his opposition to what was then taught in the schools under the name of Aristotelian philosophy. Campanella published his first work at Naples in 1591, entitled *Philosophia Sensibus demonstrata*. The schoolmen, and the monks especially, raised such a storm against Campanella that he left his native country. He was accused of sorcery, of being an adept of Raymond Lullus and of some cabalistic rabbins. His works

were seized and submitted to the Inquisition at Rome, which, however, gave him little trouble; but some time afterward (in 1598), being at Naples, he incautiously spoke against the government of the Spaniards, and, being thrown into prison, was put to the rack, and condemned to perpetual confinement. In 1626 Pope Urban VIII obtained for him his liberty, whereupon he repaired to Rome, and continued there some years; but finding that, the Spaniards were preparing fresh troubles for him, he fled into France, and landed at Marseilles in 1634. He passed the latter part of his life in the Dominican monastery at Paris, and died March 21, 1639. The number of his works is immense. Echard has given several catalogues, one of which contains eighty-two distinct works. Campanella was a man in whom every thing seems to have been extraordinary: his conduct, adventures, genius, habits of thought, style of writing, every thing was out of the usual track; hence he has been extravagantly praised, and as extravagantly abused and found fault with. In his moral character he was altogether beyond reproach; in his literary pursuits he was unwearied, excessively curious, and greedy of knowledge. He left many MSS. Among those that have been published, the following are deserving of notice: *Prodromus Philosophiæ Instauranda, seu de Natura Rerum* (Frankf. 1617);—*De Sensu Rerum et Magna Libri IV* (Frankf. 1620). This work was composed, as well as several others, by Campanella during his Neapolitan captivity, and was published in Germany by Adami, but the author published a second edition of it at Paris in 1636, which he dedicated to Richelieu. Father Mersenne wrote to refute the book as heretical, and Athanasius of Constantinople wrote against it in his *Anti-Campanella* (Paris, 1655);—*Realis Philosophiæ Epilogistica Partes IV* (Frankf. 1620);—*The Civitas Solis*, often reprinted separately, and translated into various languages;—*Apologia pro Galileo* (Frankf. 1662);—*De Predestinatione, Electione, Reprobatione, et auxiliis Divinae Gratiæ, Cento Thomisticus* (Paris, 1636). The author discusses some of the opinions of Thomas Aquinas, and supports those of Origen;—*Universalis Philosophiæ, Libri XVIII* (Paris, 1638). The following works of Campanella were published after his death, namely: *De Libris propriis et recta Ratione Studendi* (Paris, 1642, in which the author speaks of himself, his studies, and his works. It was edited by Naudé, who knew Campanella, and who speaks of him and his imprisonment in his *Considerations Politiques sur les Coups d'Etat*);—*De Monarchia Hispanica Discursus* (Amsterd. 1640). This, perhaps the most remarkable work of Campanella, was written by him during his confinement at Naples. It is an able sketch of the political world of that time (translated, *A Discourse touching the Spanish Monarchy*, Lond. 1654).—Tennemann, *Man. Hist. Phil.* § 817-819; *English Cyclopædia*.

Campanile, a name adopted from the Italian for a bell-tower. See CAMPANARIUM.

Campanites, a Socinian sect in Hungary, so named from Johannes Campanus (q. v.).

Campanus, JOHANNES, an anti-Trinitarian theologian of the 16th century. He was a native of the duchy of Julich, and in 1528 was appointed lecturer on theology at the University of Wittenberg. Here he seems to have imbibed Arian opinions, which he afterward developed openly. He avowed his opposition to Luther, and left Saxony for Julich. The Roman Catholic authorities imprisoned him at Cleves on a charge of having excited the peasantry by his preaching that the world was soon coming to an end, about 1535, and he is said to have remained in prison 25 years, and to have died between 1575 and 1580, out of his mind. He wrote a number of books, among which are *Wider alle Welt nach den Aposteln*, in which his peculiar views are set forth; reproduced in his *Göttliche und Heil. Schrift*.

He rejected the divinity of the Holy Spirit, and taught that the Son of God is of the same substance with the Father, but not coeternal. See Schelhorn, *Diss. de J. Campsano*, in his *Ameniti. Litterarum*, t. xi, l. 1; Mosheim, *Ch. History*, cent. xvi, § iii, pt. ii, ch. iv; Herzog, *Real-Encyclopædie*, i, 192; Dörner, *Person of Christ*, div. ii, vol. ii, p. 160.

Campbell, Alexander, founder of the Campbellites, or Disciples of Christ (q. v.), was born in the county of Antrim, Ireland, in the year 1789, and was educated, as was his father before him, at the University of Glasgow, Scotland—both of them as Presbyterian clergymen. Thomas Campbell, the poet, was a relative and classmate of his father. On the one side his ancestry was of Scotch origin, and on the other Huguenot French. He emigrated to America in 1809, two years after his father, and settled at first in Washington county, Penn., near the spot in West Virginia to which he soon afterward removed, and on which he lived during the remainder of his life. That spot, now the village of Bethany, was then a wild and secluded locality amid the hills. He was at first a minister of the "Secession" branch of Presbyterians, but was early led to the belief that "Christian union can result from nothing short of the destruction of creeds and confessions of faith, inasmuch as human creeds and confessions have destroyed Christian union;" and "that nothing ought to be received into the faith or worship of the Church, or be made a term of communion among Christians, that is not as old as the New Testament. Nor ought anything to be admitted as of divine obligation in the Church constitution or management save what is enjoined by the authority of our Lord Jesus Christ and his apostles upon the New Testament Church, either in express terms or by approved precedent." The promulgation of these opinions causing disturbance in the Presbyterian Church, he and his father abandoned it in 1810, and formed a new society at Brush Run, Penn. In 1812 he became convinced that immersion is the proper form of baptism, and he and his congregation were immersed. In connection with his father, the Rev. Thomas Campbell, he formed several congregations, which united with the Redstone Baptist Association, but protested against all human creeds as a bond of union, accepting the Bible alone as the rule of faith and practice. Being excluded from the fellowship of the Baptist churches in 1827, his followers began to organize into a separate body, which has since spread in all parts of the United States, especially in Virginia, Tennessee, and Kentucky. The number of disciples was estimated in 1864, altogether, at about 850,000 members, of whom only a small number belonged to Great Britain. See DISCIPLES OF CHRIST. In 1828 Mr. Campbell began the publication of *The Christian Baptist*, afterward merged in the *Millennial Harbinger*, of which he remained editor during his life. In 1840 he founded Bethany College, and he was its president to the day of his death. He was a member of the Virginia Constitutional Convention of 1829-30. It was in that body that he gave prophetic notice of what would ultimately be the course of Western Virginia, and of what he lived to see accomplished. In 1847 he visited Europe, receiving marked attentions from many of the political and religious leaders. On the slavery conflict he was "conservative." "Mr. Campbell never was the champion of American slavery. He believed, however, that the relation of master and slave had existed in Biblical times under the divine sanction, or, at all events, tolerance; and while he did not desire to be regarded as the apologist of American slavery, he contended that it should not be a test question of communion in the churches. His own slaves he had emancipated many years before."

His life was full of labors, well supported by a physical frame of athletic vigor. But in 1865 he began to fail, and he died at Bethany, March 4, 1866. He had

many of the great qualities of a reformer, and among them were personal energy and pugnacity. His career led him frequently into public "debates," the most important of which were as follows: "With the Rev. John Walker, a minister of the Secession-Presbyterian church in the State of Ohio, held at Mt. Pleasant in the year 1820. This debate created a great local interest throughout all that section of country, and was attended by a vast concourse of people. Next followed his debate with the Rev. William McCalla, on 'Christian Baptism,' held in Washington, Ky., in the year 1823; next his debate with Robert Owen, at Cincinnati, in the year 1828, on the Truth of Christianity; next his debate, in the same city, in the year 1836, with Archbishop Purcell, on the infallibility of the Church of Rome; and finally, in the year 1843, his debate with the Rev. Dr. N. L. Rice, held in the city of Lexington, Ky., the specific points of which were 'the action, subject, design, and administration of Christian baptism;' also, the 'character of spiritual influence in conversion and sanctification,' and the 'expediency and tendency of ecclesiastical creeds as terms of union and communion.'" Dr. Campbell was highly endowed as an orator; a noble presence, and a sonorous and powerful voice, gave effect to his vigorous thought, and fluent, energetic speech. Vast audiences gathered to hear him in his journeys through the West. He wrote largely, chiefly in his *Harbinger*; but he published also a summary of theology called the *Christian System* (often reprinted); a treatise on *Remission of Sin* (8d ed. 1846); *Memoirs of Thomas Campbell* (Cincinnati, 1861, 8vo). See also the article DISCIPLES OF CHRIST.—*Methodist* (N. Y.), No. 328; *American Christian Record*, 42 sq.; *Cincinnati Gazette*, March, 1866; Landis, *Rabbah Taken* (N. Y. 1844, 8vo). See CAMPBELL, THOMAS.

Campbell, Alexander Augustus, a Presbyterian minister, was born in Amherst county, Va., Dec. 30, 1789. He first studied medicine, and in 1811 graduated M.D. at Philadelphia. A violent attack of yellow fever was the means of his conversion, and he gave up the practice of medicine and applied himself to theology. He was licensed to preach by the Presbytery of North Alabama, April 2, 1822, and ordained as an evangelist Sept. 29, 1823. He was at first an itinerant, then for four years, from 1824, pastor at Tusculumbia and Russellville, Ala.; declining a call from the Church of Florence, Ala., he however remained there two years with great success, removing to Haywood county, West Tenn., in 1829-30, where he preached as a missionary. Having received a call from the Church in Jackson, Tenn., he was installed pastor Oct. 3, 1833; there he preached, lectured, edited a newspaper, and practiced medicine, principally among the Cherokee and Creek missionaries, at the same time, laboring faithfully until his death, May 27th, 1846. Mr. Campbell published a treatise on *Scripture Baptism* (1844).—Sprague, *Annals*, iv, 651.

Campbell, the Hon. Archibald, a bishop of the Scottish Episcopal Church, consecrated in 1711 at Dundee. On account of difficulties with his clergy as to "usages," he left Scotland in 1724 and returned to London, where he spent most of the remainder of his life. In his latter days he carried his nonjuring principles out by consecrating a bishop without any assistance. The date of his death is unknown. He is the author of several theological works, which are strongly Romanizing. Among them are, *The Doctrines of a Middle State between Death and the Resurrection, Of Prayers for the Dead*, etc. (Lond. 1718, fol.), and *The Necessity of Revelation* (Lond. 1789, 8vo). In his work on the Middle State, he teaches "that there is an intermediate or middle state for departed souls to abide in, between death and the resurrection, far different from what they are afterward to be in when our blessed Lord Jesus Christ shall appear at his second coming;

that there is no immediate judgment after death; that to pray and offer for, and to commemorate our deceased brethren, is not only lawful and useful, but also our bounden duty; that the intermediate state between death and the resurrection is a state of purification in its lower, as well as of fixed joy and enjoyment in its higher mansions; and that the full perfection of purity and holiness is not so to be attained in any mansion of Hades, higher or lower, as that any soul of mere man can be admitted to enter into the beatific vision, in the highest heavens, before the resurrection, and the trial by fire, which it must then go through."—Hook, *Ecl. Biography*, ii, 414.

Campbell, George, D.D., was born at Aberdeen, Dec. 25, 1719, and was educated at the Marischal College at Aberdeen. After leaving college he studied law, and was apprenticed to a writer to the Signet at Edinburgh; but, having a strong bent to theology, he obtained a release from his master, and studied theology at Edinburgh. In 1748 he was appointed to the pastoral charge of the parish of Banchory Ternan, near Aberdeen, and in 1755 he obtained a parish in Aberdeen. In 1759 he was made principal of the Marischal College. In 1763 he published his *Dissertation on Miracles*, in opposition to Hume, which was translated into several Continental languages (new ed. Edinb. 1823, 8vo). The book had an immense success, and procured for its author the degree of D.D. After his death appeared his *Lectures on Ecclesiastical History* (new ed. Lond. 1840, 8vo), which was answered by Skinner, bishop of Aberdeen. His most important work was his *Translation of the Four Gospels, with a Commentary*, which appeared not long before his death, and has been repeatedly republished. The best edition is that of Aberdeen (1814, 4 vols. 8vo); but there is a very good and cheap American edition (1837, 2 vols.). He wrote also *Lectures on the Pastoral Character* (Lond. 1811, 8vo); *Philosophy of Rhetoric* (1776, 8vo, numerous editions); *Lectures on Systematic Theology and Pulpit Eloquence* (Lond. 1807, 8vo, numerous editions). He retired from his college duties some years before his death, and received a pension of £300 a year from George III. He died April 7, 1796. The life of Dr. Campbell has been written by the Rev. G. S. Keith.—Darling, *Cyclopædia Bibliographica*, i, 567; Jamieson, *Cyclop. of Modern Religious Biography*, i, 99; Jones, *Christian Biography*, s. v.

Campbell, John, LL.D., was born in Edinburgh, March 8, 1708. His life was devoted to literature, and his publications were very numerous. He edited the "Biographia Britannica," and was one of the writers of the "Universal History." His title to mention in this work rests on the publication of *A Discourse on Providence* (1748, 8d ed. 8vo); *Thoughts on Moral and Religious Subjects* (1749, 8vo); *A new and complete History of the Holy Bible* (1783, 2 vols. folio).—*General Biog. Dictionary*, i, 119; Darling, *Cyclopædia Bibliographica*, i, 569.

Campbell, John, an Independent minister, was born at Edinburgh in March, 1766, and apprenticed to a goldsmith. About 1789, at which time he was actively engaged in measures for the extension of Sunday-schools, he began to prepare himself for the Christian ministry. He subsequently visited London to take charge of twenty-four young natives of Africa, who were brought from Sierra Leone to be instructed in Christianity, with a view to its introduction into their native land; and in 1804 he became pastor of the Independent Church in Kingsland, a charge which he retained until his death, April 4th, 1840. Mr. Campbell took an active part in the formation of the British and Foreign Bible Society, and several other important religious associations. In 1812 he made a journey to the stations of the London Missionary Society in South Africa, from which he returned in 1814. Of this journey he published an account (1815, 8vo).

In 1818–21 he revisited Africa, and found some interesting changes produced by the civilization introduced by the missionaries. The journal of his second visit appeared in 1822 (2 vols. 8vo). Mr. Campbell published numerous works, chiefly for the instruction of youth, and he was the founder, and for eighteen years the editor of the *Youth's Magazine*, a religious periodical of great utility.—Jamieson, *Religious Biog.* p. 100.

Campbell, Thomas, one of the founders of the religious denomination generally called "Disciples," was born Feb. 1, 1768, in Ireland, and descended from a family—the Campbells of Argyle—which makes a prominent figure in Scottish history. In 1798 he entered the ministry in connection with that branch of the Presbyterian Church which is known as Seceders, or Seceding Presbyteries. See PRESBYTERIANISM. In 1807 he emigrated to the United States, and was received at Philadelphia into the communion of the Associate Synod of North America. For about two years he supplied with ministerial labor the destitute churches of this connection in Western Pennsylvania. Shortly after, in 1809, he was joined by his son, Alexander Campbell (q. v.). Both father and son soon declared against the use of any human creed, confession of faith, or formularies of doctrine and church government; and when their views were rejected by the Seceders as a body, they drew up a "declaration and address," in which the pious of all the denominations in the vicinity were invited to form a union, with the word of the Bible as their only creed. A congregation on the basis of these principles was organized at Brush Run. See CAMPBELL, ALEXANDER. Thomas Campbell retained at first infant baptism, although his son Alexander pressed upon his attention "the incongruity of demanding an express precept or precedent for any positive church ordinance, and yet practicing infant baptism, for which neither the one nor the other could be produced." Gradually Thomas Campbell changed his views on the question of baptism; and on June 12, 1812, both he and his son Alexander, together with the members of their congregation, were immersed by Elder Luse, of the Baptist community. In 1813 they were received into Redstone Baptist Association, stipulating in writing that "no terms of union or communion other than the Holy Scriptures should be required." Henceforth Alexander Campbell took, instead of his father Thomas, the lead in the religious movement which at length eventuated in the formation of those who sympathized with them into a separate denominational connection. Thomas Campbell labored with great zeal, as an itinerant minister, for the dissemination of his views, until 1846, when old age compelled him to rest. He spent the remainder of his life at Bethany with his son Alexander. In 1850 he was deprived of his sight, but his intellect remained unclouded. He died January 4, 1854. See Alexander Campbell, *Memoirs of Elder Thomas Campbell* (Cincinnati, 1861, 8vo); and the articles CAMPBELL, ALEXANDER; DISCIPLES OF CHRIST.

Campbellism. See DISCIPLES OF CHRIST.

Campe, JOACHIM HEINRICH, a German clergyman and author, was born in 1746 at Deensen, in Brunswick; became, in 1773, military chaplain at Potsdam; in 1776, director of an educational institution in Dessau. In 1777 he established his own educational school at Trittow, near Hamburg, which he sold in 1783. In 1787 he was appointed school-councillor in Brunswick, and in 1805, canon. He died at Brunswick in 1818. He is one of the most famous German authors of juvenile works, especially works of travel. His work *Robinson der Jüngere* (Robinson the Younger) has been translated into all European languages, and its immense popularity in Germany may be inferred from the fact that a 60th edition of it was published in 1861. His writings, prepared in a rationalistic spirit, contributed largely to lead away

the youth of Germany from simple faith in Christianity. The complete edition of his juvenile works fills 37 volumes (*Sämmtliche Kinder und Jugendschriften*, 4th ed. Brunswick, 1829-32).—Pierer, *Universal-Lexikon*, s. v.; Hurst, *History of Rationalism*, p. 188.

Campegio (otherwise **CAMPEGGIO**, **CAMPEJUS**), **LORENZO**, Cardinal, was born in 1474, became professor of law at Padua, and, on the death of his wife, took orders as a priest. He became auditor of the Rota, bishop of Feltri, and nuncio in Germany. Leo X elevated him to the purple. In 1524 he was legate at the Nuremberg Diet, and there and elsewhere he exerted all his skill of intrigue against the Reformation with great success. In 1528 he was sent legate to Henry VIII (who, in a former mission, had made him bishop of Salisbury) to effect some settlement of the question of the divorce. Upon this occasion he was the bearer of a bull bestowing upon Wolsey the most ample powers to effect the divorce. These powers, however, were shortly withdrawn, and Campegio returned to Rome shorn of his bishopric of Salisbury. He was a man of great talents, and intimate knowledge of the ecclesiastical law. His letters are preserved in the collection entitled *Epistolæ miscellaneæ Singularium Libri X* (Basle, 1555, folio). There were seven prelates of this family.—*Biog. Univ.* vi, 638. See Burnet, *Hist. of Engl. Reformation*, vol. iii, passim.

Campen, James Van, one of the chiefs of the Anabaptists. After the expulsion of the sect from Germany he went to the Netherlands, and John Boccold (q. v.) appointed him, in 1534, bishop of Amsterdam. He was executed in 1584.

Campen, John de, was born at Campen, in Overysel, about 1490. He studied Hebrew under Reuchlin, and filled the Hebrew professorship at Louvain from 1519 to 1581, after which he travelled into Italy, Germany, and Poland. At Rome he was enrolled among the Hebraists of the pope. On his way back to Louvain he died of the plague, Sept. 7, 1588. He published *De naturâ litterarum et punctorum Hebraicorum ex variis Elia Levitæ opusculis libellus* (1520, 12mo); also *Psalmorum omnium juxta Hebraicam veritatem paraphrastica interpretatio* (1582, 16mo; trans. into English, Lond. 1585, 2mo).—*Paraphrasis in Salomonis Ecclesiastem*, and *Commentariolus in Epist. Pauli ad Rom.* et *Gal.* (Venice, 1534).—*Biog. Univ.* vi, 687; Landon, *Ecl. Dictionary*, i, 525.

Campen, Thomas Van. See **KAMPIS, THOMAS**.

Camphire (קמפר, *ko'pher*; Sept. *κίπρος*; Lat. *cyprus*, the *cyprus-flower*), rendered in our margin *cyress* (Cant. i, 14; iv, 13).

It is entirely different from the modern *gum camphor*, although the names appear to be etymologically connected. The latter is a product of a tree largely cultivated in the island of Formosa, the *Camphora officinarum*, of the Nat. order *Lauraceæ*. There is another tree, the *Dryobalanops aromatica* of Sumatra, which also yields camphor; but it is improbable that the substance secreted by either of these trees was known to the ancients. The plant in question is conceded to be the *el-Henna* of the Arabs (*Lawsonia inermis* and *spinosa* of Linnæus, which Lamarck and some other naturalists regard as the same species, and name it *Lawsonia alba*, alleging that the thorny ends of the branches characteristic of the latter are due only to old age; but each seems to retain its peculiar traits under cultivation), described by Dioscorides (i, 125) and Pliny (xii, 24) as growing in Egypt, and producing odoriferous flowers, from which was made the *oleum Cypræum*. Mariti remarks that "the shrub known in the Hebrew language by the name of *kopher* is common in the island of Cyprus, and thence had its Latin name;" also, that "the *Botrus Cypri* has been sup-

posed to be a kind of rare and exquisite grapes, transplanted from Cyprus to Engaddi; but the *Botrus* is known to the natives of Cyprus as an odoriferous shrub called *henna*, or *alkanna*." So R. Ben Melek (*ad Cant.* i, 14), as quoted and translated by Celsius (*Hierobot.* i, 228). If we refer to the works of the Arabs, we find both in Serapion and Avicenna reference from their *Hinna* to the description by Dioscorides and Galen of *Kypros* or *Cypros*. Sprengel states (*Comment. on Dioscor.* i, 124, note) that the inhabitants of Nubia call the henna-plant *Khofreh*; he refers to Delisle (*Flor. Egypt.* p. 12). If we examine the works of Oriental travellers and naturalists, we shall find that this plant is universally esteemed in Eastern countries, and appears to have been so from the earliest times, both on account of the fragrance of its flowers and the coloring properties of its leaves (see *Prosp. Alpin.* c. 15). It



Stem of the *Lawsonia inermis*, with enlarged view of the Flower, Pericarp, and Seed.

was especially abundant near Ashkelon (Pliny, xii, 51; Josephus, *War.* iv, 8, 8). Thus Rauwolf, when at Tripoli (*Travels*, iv), "found there another tree, not unlike unto our privet, by the Arabians called *Alkana* or *Henna*, and by the Grecians, in their vulgar tongue, *Schema*, which they have from Egypt, where, but above all in Cayre, they grow in abundance. The Turks and Moors nurse these up with great care and diligence because of their sweet-smelling flowers. They also, as I am informed, keep their leaves all winter, which leaves they powder and mix with the juice of citrons, and stain therewith against great holidays the hair and nails of their children of a red color, which color may perhaps be seen with us on the manes and tails of Turkish horses" (see also Belon, ii, 74). The variety called *Lawsonia spinosa* is larger than the other, growing to a height of from four to six feet; its flowers are less abundant and less fragrant, but have a more powerfully coloring property. In appearance both plants resemble myrtle; the flowers (which grow in clusters) are small and beautifully white, and exhale an agreeable odor. The women take great pleasure in them. They hold them in their hand, carry them in their bosom, and keep them in their apartments to perfume the air (comp. *Cant.* i, 18). To prepare the leaves for the use to which the plant is so generally applied by the women of Egypt, they are gathered about the commencement of spring, and, having been exposed to the air till thoroughly dry, are reduced to



Lawsonia Spinoza.

powder, which being afterward made into a paste, is then fit for use. This paste requires about five hours to dry upon whatever part it may be laid, and the red tinge it imparts is durable. It was anciently applied to the nails of the hands and feet, to the soles of the feet and the palms of the hands, and sometimes to the hair. Brides in Persia are still thus ornamented on the night before marriage (Sir Wm. Ouseley's *Travels in Persia*, iii, 565). From the appearance of the nails of mummies, there can be no doubt that it was used in the same manner by the Egyptians as it is by their descendants in the present day. The expression rendered in Deut. xxi, 12, in directing the treatment of a female captive, "pare her nails," is supposed to mean "adorn her nails," and would imply the antiquity of this practice, although others are of opinion that the marginal reading, "suffer to grow," is the more correct sense, as an act of mourning. See PAINT.

For the scientific classification of this plant, see the *Penny Cyclopædia*, s. v. *Lawsonia*. The shrub is figured and described by Sonnini, *Travels*, i, 164; see also Oedmann, *Sammf.* i, 91; vi, 102 sq.; Hasselquist, *Trav.* p. 508; Shaw, *Trav.* p. 108; Hartmann, *Hebræer.* ii, 856 sq.; Russel, *Aleppo*, i, 184; Mariti, p. 541; Forskål, *Flor.* p. 55; Burckhardt, *Arabia*, p. 442; Lane, *Mod. Eg.* i, 52; Rosenmüller, *Bib. Bot.* p. 138; Wilkinson, *Anc. Eg.* ii, 845. See BOTANY.

Camphuysen, THEODOR RAPHELSZ, a Dutch theologian, was born in 1680 at Gorkum. He was first a landscape painter, and rose to eminence in his art. Afterward, having devoted himself to theological studies, he became one of the leaders of the Socinians. He was expelled from his parish, Vleuten, and died at Doocum in 1626. He published *Theologische Wercke* (Amst. 1657, 8vo; 1672, 4to), and a rhymed translation of the Psalms in Dutch, 1680. A biography of Camphuysen was published by Kropman (Amsterdam, 1804).—Hoefer, *Biog. Générale*, viii, 899.

Campian, EDMUND, an English apostate and Jesuit, was born in London in 1540, and was educated at Christ's Hospital. He took his degrees at Oxford, where he made an oration before Queen Elizabeth on her visit to that University. Afterward he passed over into Ireland, and about 1671 proceeded to Douai, where he openly renounced the Reformed faith. He went to Rome, and was admitted a Jesuit in 1678. He was sent by Gregory XIII, along with the Jesuit Parsons, into England, in June, 1680. Here he performed all the duties of a zealous provincial, and diligently propagated his opinions. In 1681 he printed *Rationes 10 oblati certaminis in causâ fidei redditæ Academicis Angliæ*. It was afterward printed in English, and ably refuted by Whitaker. His activity at length drew upon him the attention of Walsingham, the Sec-

retary of State, and he was arrested, carried to the Tower, and put cruelly to the torture, which he bore courageously. On the 1st of December, 1681, he, together with several other Romish priests, was hanged at Tyburn on the charge of high treason. Other works of Campian are *Narratio de Divortio Henrici VIII* (Douai, 1622); *Epistola ad Mercurianum* (the general of the Jesuits; Antwerp, 1631); a *History of Ireland* (Dublin, 1638, fol.). A volume of *Orationes, Epistolæ*, and his treatise *De Imitatione Rhetorica*, were published in one volume at Ingolstadt (1602). His life was written by Paul Bombino, a Jesuit (best edition, Mantua, 1620, 8vo).—Hume, *History of England*, ch. xli; Hook, *Ecl. Biog.* iii, 428.

Campian Manuscript (CODEX CAMPIANUS, so called from the Abbé des Camps, who presented it to Louis XIV in 1707), a beautiful little Greek MS. of the four Gospels in very neat uncial letters, supposed to belong to the ninth or tenth century. It was used by Wetstein, re-examined by Scholz, copied by Tischendorf, and collated by Tregelles. It contains many good readings. Besides the indications of sections in the margin, there are also scholia, some of them in the most minute writing. Besides accents and breathings, the words are marked with a musical notation. The MS. is now in the Imperial Library at Paris (where it is numbered 48), and is known as M of the Gospels.—Scrivener, *Introduct. to N. T.* p. 110. See MANUSCRIPTS, BIBLICAL.

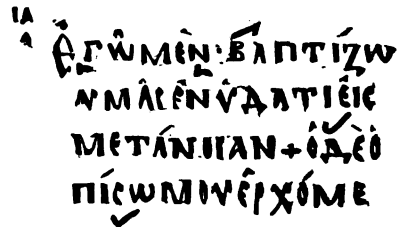

Specimen of the Codex Campianus (containing Matt. iii, 11: *Ἐγὼ μὲν βαπτίζω ὑμᾶς ἐν ὕδατι εἰς μετάνοιαν + ὁ δὲ ὀπίσω μου ἐρχομε*).

Camp-meeting, a name given to a certain class of religious meetings held in the open air. "The first camp-meeting in the United States was held in 1799, on the banks of Red River, in Kentucky. Two brothers by the name of M'Gee, one a Presbyterian and one a Methodist, being on a religious tour from Tennessee, where the former was settled, to a place called the 'Barrens,' near Ohio, stopped at a settlement on the river to attend a sacramental occasion with the Rev. Mr. M'Greedy, a Presbyterian. John M'Gee, the Methodist, was invited to preach first, and did so with great liberty and power. His brother and Rev. Mr. Hoge followed him with sermons, with remarkable effect. The Spirit was copiously poured forth upon the people, and produced tears of contrition and shouts of joy. Rev. Messrs. M'Greedy, Hoge, and Rankins, all Presbyterians, left the house, but the M'Gees were too powerfully affected themselves to flee, under circumstances of so much interest. John was expected to preach again; but when the time arrived, he arose and informed the people that the overpowering nature of his feelings would not allow of his preaching, and exhorted them to surrender their hearts to God. Cries and sobs were heard in every part of the house. The excitement was indescribable. When the noise of this extraordinary movement reached the surrounding country, the people rushed to see what these things meant, for they had never heard of the like before. By this means the meeting-house was immediately overflowed. An altar was therefore erected unto the Lord in the forest. This gave a new impulse to public interest, and many came from every direction, with provisions and other necessaries, for encampment, and

remained several days, dwelling in tents. It was a wonderful occasion. Sectarian divisions seemed to have been forgotten in the general concern for the prevalence of spiritual religion. The services were conducted by Presbyterians, Baptists, and Methodists. The result was unparalleled, and suggested another meeting of the kind, which was held on the Muddy River; and still another, on what was called the Ridge, both of which were attended by immense throngs. By a prudent estimate, it was reckoned that one hundred souls were 'added to the Lord' at the last-named meeting. From this unpremeditated beginning these meetings were extended, increasing in power and usefulness, under the special direction of Presbyterians and Methodists. Because of this union of sects in their support, they were called 'general camp-meetings.' It is said that the roads leading to the grove where they were held were literally crowded, and that entire neighborhoods were forsaken of their inhabitants. A Presbyterian minister calculated that there were at least twenty thousand persons present at one meeting held in Kentucky. At length, however, the Presbyterians gradually retired from the field; but the Methodists carried them into other parts of the country, till they became general in the connection. With more or less efficacy, they have been continued to the present time, not, however, without opposition on the part of some, and misgivings with many others in regard to their expediency" (*Essay on Camp-meetings*, p. 7-11).

The camp-meetings were introduced into England by Rev. Lorenzo Dow (q. v.), an earnest Methodist preacher, who, after laboring for some time in England as an independent itinerant, and finding, in 1807, a general religious interest in Staffordshire, suggested to the people the plan of camp-meetings. The people immediately adopted it. A flag was hoisted on Mow Hill; the population gathered to it from all the surrounding regions, and the first English camp-meeting was held. William Clowes and Hugh Bourne, who were among the most zealous and useful laymen in the revivals of that period, took an active part in the first meetings. Bourne vindicated them in a pamphlet, which called forth counter publications from the preachers of Burslem and Macclesfield circuits. As it was alleged that many excesses attended such outdoor services, the Wesleyan Conference, in 1807, declared, "It is our judgment that, even supposing such meetings to be allowable in America, they are highly improper in England, and likely to be productive of considerable mischief, and we disclaim connection with them." Their advocates, however, continued to hold them. Hugh Bourne, who aroused the people of Lancashire, Cheshire, and Staffordshire with his exhortations and prayers, was expelled in 1806 from the connection by the Burslem Quarterly Meeting; and, two years later, Clowes, who continued to attend the camp-meetings, was also expelled. Clowes commenced a course of home-missionary labors, giving up his business for the purpose. In 1810 the "Primitive Methodist" denomination was organized, which sanctioned the habit of preaching in camp-meetings, as well as in market-places and on the highways. See **METHODISTS, PRIMITIVE**. The Wesleyan Conference has never taken back its disapproval of the camp-meetings; but the Wesleyans in Ireland commenced to hold camp-meetings in 1860, and their organ, *The Irish Evangelist*, took ground in favor of them. See *An Essay on Camp-meetings* (N. Y. 1849); Stevens, *Hist. of Methodism*, iii, 224; Bangs, *History of M. E. Church*, ii, 161; Porter, *Compendium of Methodism*, p. 146, 468; Porter, *Camp-Meetings* (N. Y. 2Amo); *Meth. Quart. Review*, 1861, p. 562.

CAMUS, JEAN PIERRE, Bishop of Belley, was born at Paris in 1582, and was consecrated bishop Aug. 31, 1609. He devoted all his energies to the duties of his diocese, especially in reforming abuses, and endeavor-

ing to bring back the monks and nuns to a regular life. On the latter point he was rigid. In 1629 he resigned his see, and retired into the abbey of Aulnal, given to him by the king upon his resignation of his bishopric. He afterward entered the Hospital of Incurables of Paris, where he died, April 26, 1658. The number of his writings is immense; the Abbé Le Clerc attributes to him more than two hundred volumes, consisting of controversial, moral, and devout treatises, sermons, letters, and religious novels. He was a bitter and sarcastic foe of the Mendicant orders.—*London, Eccl. Dictionary*, ii, 526; Niceron, *Mémoires*, xxxvi, 92.

CANA (Kavā), a town in Galilee, not far from Capernaum, and on higher ground; it is memorable as the scene of Christ's first miracle (John ii, 1-11; iv, 46), as well as of a subsequent one (iv, 46-54), and also as the native place of the apostle Nathaniel (xxi, 2). This Cana is not named in the Old Testament, but is mentioned by Josephus as a village of Galilee (*Life*, § 16, 64; *War*, i, 17, 5). The site has usually been identified with the present *Kefr Kenna*, a small place about four miles north-east from Nazareth, on one of the roads to Tiberias. It is a neat village, pleasantly situated on the descent of a hill looking to the south-west, and surrounded by plantations of olive and other fruit-trees. There is a large spring in the neighborhood, enclosed by a wall, which, if this be the Cana of the New Testament, is doubtless that from which water was drawn at the time of our Lord's visit. It is also observable that water-pots of compact limestone are still used in this neighborhood, and some old ones are, as might be expected, shown as those which once contained the miraculous wine. Here are also the remains of a Greek church, said to stand over the house in which the miracle was performed, and—doubtless much older—the fountain from which the water for the miracle was brought (Mislin, iii, 448-446). The Christians of the village are entirely of the Greek Church. The "water-pots of stone" were shown to M. Lamartine, though at Willibald's visit, centuries before, there had been but one remaining (*Early Trav.* p. 16). In the time of the Crusades the six jars were brought to France, where one of them is said still to exist in the Musée d'Angers (see M. Didron's *Essays in the Annales Archéologiques*, xi, 5; xiii, 2). There is also shown a house said to be that of Nathaniel. Kefr Kenna has been visited and described by most travellers in Palestine. The tradition identifying this village with Cana is certainly of considerable age (see Hegesippus, p. 5). It existed in the time of Willibald (the latter half of the eighth century), who visited it in passing from Nazareth to Tabor; and again in that of Phocas (twelfth century; see *Beland*, p. 680). Saewulf, who visited Palestine in A. D. 1102, says, "Six miles to the N.E. of Nazareth, on a hill, is Cana of Galilee" (*Early Trav. in Pal.* p. 47). Marinus Sanutus, in the fourteenth century, describes Cana as lying north of Sepphoris, on the side of a high hill, with a broad fertile plain in front (*Gesta Dei*, p. 253). Quaresmius states that in his time (A. D. 1620) two Canas were pointed out (*Eucid.* ii, 852).—*Kitto*, s. v.; Smith, s. v.

There is a ruined place called *Kana el-Jellil*, about eight miles N. $\frac{1}{2}$ E. from Nazareth, which Dr. Robinson is inclined to regard as the more probable site of Cana. His reasons, which are certainly of considerable weight (especially the strict agreement of the name, "Cana of Galilee"), may be seen in *Biblical Researches*, iii, 204-208. They are combated by De Saulcy (*Narrative*, ii, 520). According to Thomson (*Land and Book*, ii, 121), few Moslems of the vicinity know of the epithet el-Jellil as applied to the place. Dr. Robinson says, "It is situated on the left side of the wady coming down from Jefat, just where the latter enters the plain el-Buttauf, on the southern declivity of a projecting tell, and overlooking the plain. The situation is fine.

It was once a considerable village of well-built houses, now deserted. Many of the dwellings are in ruins. There are also several arches belonging to modern houses, but we could discover no traces of antiquity" (*Later Bib. Researches*, p. 108).

The Old Testament mentions two other places by the same name (קָנָאן), one on the boundary between Manasseh and Ephraim (Josh. xvi, 8; xvii, 9, 10), the other in the tribe of Asher (Josh. xix, 28). The Syriac has *Katna* for the Cana of the Gospels; and this compares somewhat with the *Itah-kazin* (q. v.) on the border of Zebulun (Josh. xix, 18), which appears to have occupied the site of the present Kefr Kenna. Whether the Galilean village *Kamah* (קָמָה) mentioned in the Talmud (*Yuchas*, 57) is the same with Cana of Galilee, is uncertain (comp. *Otho, Lex. Rabb.* p. 115).

There are treatises on various points connected with Christ's first miracle at Cana, in Latin, by Brendel (Isenb. 1786), Bashuysen (Serv. 1726), Georgius (Viteb. 1744), Hebenstreit (Jen. 1698), Hoheisel (Gedan. 1782), Mayer (Gryph. 1708), Oeder (Onold. 1721), Sommel (Lund. 1773), Tabling (Brem. 1693), Vechner (Helm. 1640); and in German by Flatt (in *Stäking's Magaz.* xiv, 78 sq.).

Ca'naän (Heb. *Kena'an*, קָנָאן, perhaps *low*; Sept. and N. T. *Xaváav*; Josephus *Xaváavoc*), the name of a man and of a country peopled by his descendants.

1. The fourth son of Ham, and grandson of Noah (Gen. x, 6; 1 Chron. i, 8; comp. Josephus, *Ant.* i, 6, 4). B. C. post 2514. The transgression of his father Ham (Gen. ix, 22-27), to which some suppose Canaan to have been in some way a party, gave occasion to Noah to pronounce that doom on the descendants of Canaan which was, perhaps, at that moment made known to him by one of those extemporaneous inspirations with which the patriarchal fathers appear in other instances to have been favored. See BLESSING. That there is no just ground for the conclusion that the descendants of Canaan were cursed as an immediate consequence of the transgression of Ham, is shown by Professor Bush, who, in his *Notes on Genesis*, has fairly met the difficulties of the subject.—*Kitto, Cyclop.* s. v. See HAM.

The posterity of Canaan was numerous. His eldest son, Zidon, founded the city of the same name, and was father of the Sidonians and Phoenicians. Canaan had ten other sons, who were fathers of as many tribes, dwelling in Palestine and Syria (Gen. x, 15-19; 1 Chron. i, 18). It is believed that Canaan lived and died in Palestine, which from him was called the land of Canaan. See CANAANITE.

2. The simple name "Canaan" is sometimes employed for the country itself—more generally styled "the land of C." It is so in Zeph. ii, 5; and we also find "Language of C." (Isa. xix, 18); "Wars of C." (Judg. iii, 1); "Inhabitants of C." (Exod. xv, 15); "King of C." (Judg. iv, 2, 26, 24; v, 19); "Daughters of C." (Gen. xxviii, 1, 6, 8; xxxvi, 2); "Kingdoms of C." (Psa. cxxxv, 11). In addition to the above, the word occurs in several passages where it is concealed in the Auth. Vers. by being translated. These are, Isa. xxiii, 8, "traffickers," and xxiii, 11, "the merchant city;" Hos. xii, 2, "He is a merchant;" Zeph. i, 11, "merchant-people."—*Smith, Dict.* s. v. See COMMERCE.

LAND OF CANAAN (קְנָאן אֶרֶץ), according to some, from its being *low*; see 2 Chron. xxviii, 19; Job xl, 12, among other passages in which the verb is used), a name denoting the country west of the Jordan and Dead Sea (Gen. xiii, 12; Deut. xi, 80), and between those waters and the Mediterranean; specially opposed to the "land of Gilead"—that is, the high table-land on the east of the Jordan (Num. xxxiii, 26, 32; xxxiii, 51; Josh. xxii, 32; see also Gen. xii, 5; xxiii, 2, 19; xxxi, 18; xxxiii, 18; xxxv, 6; xxxvii, 1; xlviii, 4,

7; xlix, 80; Num. xiii, 2, 17; xxxiii, 40, 51; Josh. xvi, 2; Judg. xxi, 12). True, the district to which the name of "low land" is thus applied contained many very elevated spots: Shechem (Gen. xxxiii, 18), Hebron (xxiii, 19), Bethel (xxxv, 6), Bethlehem (xlviii, 7), Shiloh (Josh. xxi, 2; Judg. xxi, 12), which are all stated to be in the "land of Canaan." But, high as the level of much of the country west of the Jordan undoubtedly is, there are several things which must always have prevented it from leaving a marked impression of general elevation. These are, (1), that remarkable, wide, maritime plain over which the eye ranges for miles from the central hills, a feature of the country which cannot be overlooked by the most casual observer, and which impresses itself most indelibly on the recollection; (2), the still deeper and more remarkable and impressive hollow of the Jordan valley, a view into which may be commanded from almost any of the heights of Central Palestine; and, (3), there is the almost constant presence of the long high line of the mountains east of the Jordan, which, from their distance, have the effect more of an enormous cliff than of a mountain range—looking down on the more broken and isolated hills of Canaan, and furnishing a constant standard of height before which every thing is dwarfed. These considerations are based upon the supposition that the name was derived from the natural features of the country. But this is not countenanced by Scripture. Canaan was the son of Ham. He and his whole family colonized Western Syria, and while the whole region took his name, different sections of it were called after his sons (Gen. x, 15-20). Aram was a son of Shem, and his descendants colonized the country of Aram (Gen. x, 21-31). On the other hand, Aram cannot, at least absolutely, be termed a "highland region." It comprised the vast plains along the banks of the Euphrates, and westward to the Orontes and Anti-Libanus. Canaan, on the whole, however, is rather a hilly country, with strips of plain along the coast. In one passage it is distinguished from the low valley of the Jordan (Gen. xiii, 12). In short, the terms Aram and Canaan, if bestowed with any reference to the comparative elevation of the respective countries, have a merely relative significance; the latter lying nearer the sea-coast, while the former—especially that part of it where the Hebrew patriarchs originated—is situated toward the interior head-waters of the great river Euphrates. See ARAM.

The extent and boundaries of Canaan are given with tolerable exactness in the Bible. On the west, the sea was its border from Sidon to Gaza (Gen. x, 19). On the south it was bounded by a line running from Gaza to the southern end of the Dead Sea, including the Judæan hills, but excluding the country of the Amalekites (Gen. x, 19; Num. xiii, 29). The Jordan was the eastern boundary; no part of Canaan lay beyond that river (Num. xxxiii, 51; Exod. xvi, 35, with Josh. v, 12; xxii, 11. See *Reland, Palest.* p. 8 sq.). On the north, Canaan extended as far as Hamath, which was also the utmost boundary of the "land of promise" (Gen. xvii, 8; Num. xxxiv, 8). The coast from Sidon northward to Arvad, and the ridge of Lebanon, were inhabited by Canaanites, though they do not appear to have been included in Canaan proper (Gen. x, 15-19. See *Bochart, Opp.* i, 308 sq.; *Reland, Palest.* p. 8 sq.). For geographical and other details, see PALESTINE.

The word "Canaan," in a few instances, such as Zeph. ii, 5, and Matt. xv, 22, was applied to the low maritime plains of Philistia and Phœnicia (comp. Mark vii, 26; and see Gesenius on Isa. xxiii, 11). In the same manner, by the Greeks, the name *Xvā* was used for Phœnicia, i. e. the sea-side plain north of the "Tyrian ladder" (see the extract in *Reland, Palest.* p. 7, and Gesenius, *Theaur.* p. 696), and by the later Phœnicians, both of Phœnicia proper and of the Punic col-

oales in Africa (Kenrick, *Phœnicia*, p. 40, 42, 460). The name occurs in this sense on the Egyptian mon-



K a n a n a . land
Hieroglyph of Canaan.

uments as well as on Phœnician coins (Eckhel, *Doctr. Num.* iv, 409), and was not even unknown to the Carthaginians (Gesenius, *Gesch. d. Heb. Sprach.* p. 16). The Sept. in two cases, in like manner, renders the Hebrew by *χωρα των Φοινικων* (Exod. xvi, 85; Josh. v, 12; comp. v, 1), as they do "Canaanites" by *φοινικες*. Again, in Num. xiii, 29, "The Hittites, and the Jebusites, and the Amorites dwell in the mountains; and the Canaanites dwell by the sea, and by the coast of the Jordan." In 2 Sam. xxiv, 7, the Canaanites are distinguished from the Hivites, though the latter were descended from Canaan; and in several passages the Canaanites are mentioned with the Hittites, Amorites, Jebusites, etc., as if they constituted a special portion of the population (Exod. iii, 8; Dent. vii, 1; Josh. iii, 10). The most probable explanation of these limited applications of the name is, that while some of the tribes which inhabited Syria retained for their territories the name of their common ancestor Canaan, others preferred taking, as a distinctive appellation, the name of some subsequent head

or chief of the tribe. The very same practice prevails to this day among the great tribes of Arabia.—Smith, *Dict.* s. v.; Kitto, *Cyclop.* s. v. See CANAANITE.

CANAAN, LANGUAGE OF (קַנְאָנִי שְׂפָרָה, *lip of Canaan*), occurs Isa. xix, 18, where it undoubtedly designates the language spoken by the Jews dwelling in Palestine. That the language spoken by the Canaanites was substantially identical with Hebrew appears, 1. From the fact that the proper names of Canaanitish persons and places are Hebrew, and can be accounted for etymologically from the Hebrew as readily as Hebrew proper names themselves (thus we have Abimelech, Kirjath-Sapher, etc.); 2. Close as was the intercourse of the Hebrews with the Canaanites, there is no hint of their needing any interpreter to mediate between them, which renders it probable that their respective languages were so nearly allied to each other as to be substantially the same; 3. The remains of the Phœnician language, which was undoubtedly Canaanitish, bear the closest analogy to the Hebrew, and are best explained from it, which proves them to be substantially the same language (Bochart, *Geogr. Sacr.* ii, col. 699 sq., ed. 1682).

To account for this, some have supposed that the Canaanites and the Hebrews were of the same original stock, and that the account in Genesis of their being descended from different branches of the Noachic family is a fiction to be put to the account of national bigotry on the part of the writer. But this is a hypothesis utterly without foundation, and which carries its own confutation in itself; for, had national bigotry directed the writer, he would have excluded the Edomites, the Ammonites, the Moabites, from the Shemitic family, as well as the Canaanites; nay, he would hardly have allowed the Canaanites to claim descent from the righteous Noah. The list of the nations in Gen. xi is accepted by some of the most learned and unfettered scholars of Germany as a valuable and trustworthy document (Knobel, *Völkertafel der Genesis*, 1850; Bertheau, *Beiträge*, p. 174, 179). See ETHNOGRAPHY. But if these were different races, how came they to have the same language? Knobel thinks that the country was first occupied by a Shemitic race, the descendants of Lud, and that the Hamites were immigrants who adopted the language of the country into which they came (p. 204 sq.). On the other hand, Grotius, Le Clerc, and others, are of opinion that Abraham acquired the language of the country into which he came, and that Hebrew is consequently a Hamitic and not a Shemitic language (Grotius, *Dissert. de Ling. Heb.*, prefixed to his *Commentary*; Le Clerc, *de Ling. Heb.*; Beke, *Origines Biblicæ*, p. 230; Winning, *Manual of Compar. Philology*, p. 275): by some later writers Abraham's native tongue is supposed to have been Indo-Germanic or Arian. On the contrary, most maintain that Abraham retained the use of the primeval language, and brought it with him to Canaan; contending that, had he borrowed the language of the country into which he came, the result would have been a less pure language than the Hebrew, and we should have found in it traces of idolatrous notions and usages (Hävernick, *Einleit.* 151, E. T. p. 183; Pareau, *Inst. Interp.* p. 25, E. T. i, 27). This last is the oldest opinion, and there is much to be urged in its favor. It leaves, however, the close affinity of the language of Abraham and that of the Canaanites unaccounted for. The hypothesis that Abraham acquired the language of the Canaanites, and that this remained in his family, if admissible, would account not only for the affinity of the Hebrew and Phœnician tongues, but for the ease with which Abraham and his son made themselves understood in Egypt, and for the affinity of the ancient Egyptian and several modern African languages with the Hebrew. (See Bleek, *Einleit. ins A. T.* p. 61 sq.; J. G. Müller, in *Herzog's Real-Encyclop.* vii, 240.)—Kitto, s. v.



Map of Canaan, with the Aboriginal Nations.

Ca'naänite (Heb., usually in the sing., and with the art., *hak-Kanaäni'*, כְּנַעֲנִי, i. e. accurately according to Hebrew usage [Gesenius, *Heb. Gram.* § 107], "the Canaanite;" but in the *Auth. Vers.*, with few exceptions, rendered as plural, and therefore indistinguishable from כְּנַעֲנִים, *Kanaänim*, which also, but not frequently, occurs; Sept. generally *Xαναναίος* [or *Xαναναίος*]; but *Φοινιξ*, Exod. vi. 15; comp. Josh. v. 1; Vulg. *Chanaanæus*), properly a designation of the descendants of Canaan, the son of Ham and grandson of Noah, inhabitants of the land of Canaan and the adjoining districts. See CANAAN.

I. *Component Tribes*.—1. These are most frequently enumerated in the formula used in the command and statement of their extermination by the Israelites, which, however, assumes the following different shapes:

(1) Six nations: the Canaanites, Hittites, Amorites, Perizzites, Hivites, and Jebusites. This is the usual form, and, with some variation in the order of the names, it is found in Exod. iii. 8, 17; xxiii. 28; xxxiii. 2; xxxiv. 11; Deut. xx. 17; Josh. ix. 1; xii. 8; Judg. iii. 5. In Exod. xiii. 5, the same names are given with the omission of the Perizzites.

(2) With the addition of the Girgashites, making up the mystic number seven (Deut. vii. 1; Josh. iii. 10; xxiv. 11). The Girgashites are retained and the Hivites omitted in Neh. ix. 8 (comp. Ezr. ix. 1).

(3) In Exod. xxiii. 28, we find the Canaanite, the Hittite, and the Hivite.

(4) The list of ten nations in Gen. xv. 19-21 (where the Kenites, the Kenizites, and the Kadmonites are added), includes some on the east of Jordan, and probably some on the south of Palestine.

(5) In 1 Kings ix. 20, the Canaanites are omitted from the list.

2. Besides these there were several tribes of the Canaanites who lived beyond the borders of the Promised Land northward. These were the Arkites, Sinites, Arvadites, Zemarites, and Hamathites (Gen. x. 17, 18), with whom, of course, the Israelites had no concern. There were also other tribes of Canaanitish origin (or possibly other names given to some of those already mentioned), who were dispossessed by the Israelites. The chief of these were the Amalekites, the Anakites, and the Rephaim (or "giants," as they are frequently called in our translation). See each of these, as well as the foregoing, in their alphabetical place.

II. *Geographical Distribution*.—In this respect the term "Canaanite" is used in two senses, a limited and a wide application.

1. For the tribe of "the Canaanites" only—the dwellers in the lowland, i. e. "who dwelt by the sea and by the coasts of Jordan" (Num. xiii. 29). The whole of the country west of Jordan might, as we have seen, be in some sense called a "lowland" as compared with the loftier and more extended tracts on the east; but there was a part of this western country which was still more emphatically a "lowland." (a) There were the plains lying between the shore of the Mediterranean and the foot of the hills of Benjamin, Judah, and Ephraim—the Shephelah, or plain of Philistia, on the south; that of Sharon, between Jaffa and Carmel; the great plain of Esdraelon, in the rear of the bay of Akka; and, lastly, the plain of Phœnicia, containing Tyre, Sidon, and all the other cities of that nation. (b) But separated entirely from these was the still lower region of the Jordan Valley, or Arabah (q. v.), the modern *Ghadr*, a region which extended in length from the sea of Cinneroth (Gennesareth) to the south of the Dead Sea about 120 miles, with a width of from 8 to 14. The climate of these sunken regions, especially of the valley of the Jordan, is so peculiar, that it is natural to find them the special possession of one tribe. "Amalek"—so runs one of the earliest and

most precise statements in the ancient records of Scripture—"Amalek dwells in the land of the south; and the Hittite, and the Jebusite, and the Amorite dwell in the mountains; and the Canaanite dwells by the sea, and by the side of Jordan" (Num. xiii. 29). This describes the division of the country a few years only before the conquest. But there had been little or no variation for centuries. In the notice which purports to be the earliest of all, the seats of the Canaanite tribe—as distinguished from the sister tribes of Zidon, the Hittites, Amorites, and the other descendants of Canaan—are given as on the sea-shore from Zidon to Gaza, and in the Jordan Valley to Sodom, Gomorrah, and Lasha (afterward Callirrhoe), on the shore of the present Dead Sea (Gen. x. 18-20). In Josh. xi. 3, at a time when the Israelites were actually in the western country, this is expressed more broadly. "The Canaanite on the east and the west" is carefully distinguished from the Amorite who held "the mountain" in the centre of the country. In Josh. xiii. 2, 3, we are told with more detail that "all the 'circles' (מְבָרָה) of the Philistines . . . from Sihor (? the *Wady el-Ariah*) unto Ekron northward, is counted to the Canaanite." Later still, the Canaanites are still dwelling in the upper part of the Jordan Valley—Bethshean; the plain of Esdraelon—Taanach, Ibleam, and Megiddo; the plain of Sharon—Dor; and also on the plain of Phœnicia—Achoch and Zidon. Here were collected the chariots which formed a prominent part of their armies (Judg. i. 19; iv. 8; Josh. xvii. 16), and which could indeed be driven nowhere but in these level lowlands (Stanley, *Sinai and Palest.* p. 184).

The plains which thus appear to have been in possession of the Canaanites, specially so called, were not only of great extent; they were also the richest and most important parts of the country, and it is not unlikely that this was one of the reasons why—

2. The name "Canaanite" is also applied as a general name for the non-Israelite inhabitants of the land, as we have already seen was the case with "Canaan." Instances of this are Gen. xii. 6; Num. xxi. 3, where the name is applied to dwellers in the south, who in xiii. 29, are called Amalekites; Judg. i. 10, with which comp. Gen. xiv. 18, and xiii. 18, and Josh. x. 5, where Hebron, the highest land in Palestine, is stated to be Amorite; and Gen. xiii. 12, where the "land of Canaan" is distinguished from the very Jordan Valley itself. See also Gen. xxiv. 8, 37; comp. xxviii. 2, 6; Exod. xiii. 11; comp. 5. But in many of its occurrences it is difficult to know in which category to place the word. Thus, in Gen. i. 11: if the floor of Atad was at Bethhoga, close to the west side of the Jordan, "the Canaanites" must be intended in the narrower and stricter sense; but the expression "inhabitants of the land" appears as if intended to be more general. Again, in Gen. x. 18, 19, where some believe the tribe to be intended, Gesenius takes it to apply to the whole of the Canaanite nations. But in these and other similar instances, allowance must surely be made for the different dates at which the various records thus compared were composed; and, besides this, it is difficult to estimate how accurate a knowledge the Israelites may have possessed of a set of petty nations, from whom they had been entirely removed for four hundred years, and with whom they were now again brought into contact only that they might exterminate them as soon as possible. Again, before we can solve such questions, we ought also to know more than we do of the usages and circumstances of people who differed not only from ourselves, but also possibly in a material degree from the Orientals of the present day. The tribe who possessed the ancient city of Hebron, besides being, as shown above, called interchangeably Canaanites and Amorites, are in a third passage (Gen. xxiii) called the children of Heth, or Hittites (comp. also xxvii. 46, with xxviii. 1, 6). The Canaanites

who were dwelling in the land of the south when the Israelites made their attack on it may have been driven to these higher and more barren grounds by some other tribes, possibly by the Philistines who displaced the Avites, also dwellers in the low country (Deut. ii, 28). See Kurtz, *Hist. of the Old Covenant*, vol. 1, § 45.—Smith, *Dict. s. v.*

III. *History of the Canaanites' Race.*—The Israelites were delivered from Egypt under Moses, in order that they might take possession of the land which God had promised to their fathers. This country was then inhabited by the descendants of Canaan, as described above. These nations, and especially the six or seven so frequently mentioned by name, the Israelites were commanded to dispossess and utterly to destroy (Exod. xxiii, 23; Num. xxxiii, 53; Deut. xx, 16, 17). The destruction, however, was not to be accomplished at once. The promise on the part of God was that he would "put out those nations by little and little," and the command to the Israelites corresponded with it; the reason given being "lest the beasts of the field increase upon thee" (Exod. xxiii, 29; Deut. vii, 22).

The destructive war commenced with an attack on the Israelites by Arad, king of the Canaanites, which issued in the destruction of several cities in the extreme south of Palestine, to which the name of Hormah was given (Num. xxi, 1-8). The Israelites, however, did not follow up this victory, which was simply the consequence of an unprovoked assault on them; but turning back, and compassing the land of Edom, they attempted to pass through the country on the other side of the Jordan, inhabited by a tribe of the Amorites. Their passage being refused, and an attack made on them by Sihon, king of the Amorites, they not only forced their way through his land, but destroyed its inhabitants, and, proceeding onward toward the adjoining kingdom of Bashan, they in like manner destroyed the inhabitants of that district, and slew Og, their king, who was the last of the Rephaim, or giants (Deut. iii, 11). The tract of which they thus became possessed was subsequently allotted to the tribes of Reuben and Gad, and the half tribe of Manasseh. See EXODE.

After the death of Moses, the Israelites crossed the Jordan, and, under the conduct of Joshua, took possession of the greater part of the Promised Land, and destroyed its inhabitants. Several cities, however, still held out, particularly Jebus, afterward Jerusalem, which was not taken till the time of David (2 Sam. v, 6), and Sidon, which seems never to have yielded to the tribe of Asher, to whom it was nominally allotted (Judg. i, 81). Scattered portions also of the Canaanitish nations escaped,* and were frequently strong enough to harass, though not to dispossess, the Israelites. The inhabitants of Gibeon, a tribe of the Hivites, made peace by stratagem, and thus escaped the destruction of their fellow-countrymen. Individuals from among the Canaanites seem, in later times, to have united themselves, in some way, to the Israelites, and not only to have lived in peace, but to have been capable of holding places of honor and power: thus Uriah, one of David's captains, was a Hittite (1 Chron. xi, 41). In the time of Solomon, when the kingdom had attained its highest glory and greatest power, all the remnants of these nations were made tributary, and bond-service was exacted from them (1 Kings ix, 20). The Girgashites seem to have been either wholly destroyed or absorbed in other tribes. We find no mention of them subsequent to the book of Joshua; and the opinion that the Gergesenes, or Gadarenes, in the time of our Lord, were their descendants, has little evidence, except the similarity of names, to support it (Rosenmüller, *Scholia in Gen. x, 16*; Reland, *Palæstina*, i, 27, p. 138). The Anakites were completely destroyed by Joshua except in three cities, Gaza, Gath, and Ashdod (Josh. xi, 21-23); and the powerful nation of the Amalekites, many times de-

feated and continually harassing the Israelites, were at last totally destroyed by the tribe of Simeon (1 Chron. iv, 43). Even after the return of the Jews from the Babylonian captivity there were survivors of five of the Canaanitish nations, with whom alliances had been made by the Jews, contrary to the commands which had been given them. Some of the Canaanites, according to ancient tradition (see D'Herbelot, *Biblioth. Orient. s. v. Falastin*), left the land of Canaan on the approach of Joshua, and emigrated to the coast of Africa (to Armenia, according to Ritter, *Erdk. vii, 585*). Procopius (*De Bello Vandalico*, ii, 10) relates that there were in Numidia, at Tigis (Tingis), two columns, on which were inscribed, in Phœnician characters, "We are those who fled from the face of Joshua, the robber, the son of Naue." (See Bochart, *Phaleg*, i, 24; Michaelis, *Laws of Moses*, art. 81, vol. i, p. 176, Smith's transl.; Bachiene, i, ii, 1 sq.; Michaelis, *Spicileg.* i, 166 sq.; Hamelsveld, iii, 81 sq.)—Kitto, *Cyclop.* s. v. See PHœNICIA.

IV. *Characteristics.*—Beyond their chariots (see above) we have no clew to any manners or customs

of the Canaanites. Like the Phœnicians, they were probably given to commerce, and thus the name doubtless became in later times an occasional synonym for a merchant (Job xli, 6; Prov. xxxi, 24; comp. Isa. xxiii, 8, 11; Hos. xii, 2; Zeph. i, 11. See Kenrick, *Phœnicia*, p. 232). Under the name *Kanaan* they appear on the Egyptian monuments, distinguished by a coat of mail and helmet, and the use of spears, javelins, and a battle-axe similar to that of Egypt (Wilkinson, i, 403, abridgm.).

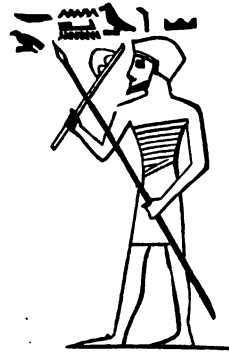

Canaanite Enemies of the Ancient Egyptians.

Of the language of the Canaanites little can be said. On the one hand, being—if the genealogy of Gen. x be rightly understood—Hamites, there could be no affinity between their language and that of the Israelites who were descendants of Shem. On the other is the fact that Abram and Jacob, shortly after their entrance to the country, seem able to hold converse with them, and also that the names of Canaanite persons and places which we possess are translatable into Hebrew. Such are Melchizedek, Hamor, Shechem, Sisera, Ephraim, and also a great number of the names of places. (For an examination of this interesting but obscure subject, see Gesenius, *Hebr. Spr.* p. 223-225.) See CANAAN, LANGUAGE OF.

The "Nethinim," or servants of the Temple, seem to have originated in the dedication of captives taken in war from the petty states surrounding the Israelites. See NETHINIM. If this was the case, and if they were maintained in number from similar sources, there must be many non-Israelite names in the lists of their families which we possess in Ezra ii, 48-54; Neh. vii, 46-56. Several of the names in these catalogues, such as Sisera, Mehunim, Nephushim, are the same as those which we know to be foreign, and doubtless others would be found on examination. The Gibeonites especially were native Canaanites, who, although reduced to a state of serfdom, were allowed to exist among the Israelites. See GIBONITE.

V. *Conquest of Canaan.*—The arbitrary and forcible invasion of the land of Canaan by the Israelites, the violent and absolute dispossession of its inhabitants by them, and the appropriation of their property—above all, the avowed purpose and actual warfare of utter extermination on their part respecting those who had never misused them, against whom they

could neither exhibit nor pretend to any such claim as is acknowledged as a cause of hostility or right to the soil among civilized nations, has given grave offence to modern rationalists, and occasioned no little difficulty to pious believers in the economy of the Old Testament. The example has even been pleaded in justification of the shameful outrages committed by Christians upon the North-American Indians, as it was by the Spaniards in their savage campaigns against the peaceful and highly cultivated Mexicans and Peruvians; nor can it be doubted that the relentless spirit evinced in the sanguinary history of the Exode was largely reflected in the stern and martial zeal of Cromwell and the Puritans. Without attempting to vindicate all the details of the war under Joshua, which in some instances (e. g. in the circumstances attending the punishment of Achan [q. v.], who, by reason of his complicity with the Canaanites in respect to the ban against them, was regarded as a traitor, and dealt with summarily, as by a court-martial, or rather by "lynch-law") appears to have transcended even the rigorous programme contemplated in its inception, although it probably went no farther in severity than the rude judgment of those charged with or engaged in the execution of the scheme deemed needful for the ends in view, we are yet called upon to investigate the grounds upon which the measure, as a whole, has been defended or may be justified; and this is the more imperative, inasmuch as the warfare and occupation themselves were not simply *suffered* while in progress, or passed over as unavoidable after their occurrence, but positively, repeatedly, and strictly enjoined, with all their essential features of so-called atrocity or injustice, by special divine command, accompanied by the most awful sanctions direct from heaven itself. The question properly relates to two somewhat distinct points: 1. The right of the Israelites to the territory itself, and, 2. The morality of warfare in which no quarter was to be given, and no property of the enemy to be spared; the consideration of these, however, is so connected, both in the similarity of the objections and the common ground of vindication, that we may most conveniently treat them together.

"Many have asserted, in order to alleviate the difficulty, that an allotment of the world was made by Noah to his three sons, and that by this allotment the Land of Promise fell to the share of Shem; that the descendants of Ham were therefore usurpers and interlopers, and that, on this ground, the Israelites, as the descendants of Shem, had the right to dispossess them. This explanation is as old as Epiphanius, who thus answered the objection of the Manicheans. Others justify the war on the ground that the Canaanites were the first aggressors—a justification which applies only to the territory on the other side of the Jordan. Michaelis, to whom we must refer for a lengthened investigation of the subject (*Laws of Moses*, § 29, vol. i, p. 111-179, Smith's transl.), dissatisfied with these and other attempted apologies, asserts that the Israelites had a right to the land of Canaan as the common pasture-land of their herdsmen, in consequence of the undisturbed possession and appropriation of it from the time of Abraham till the departure of Jacob into Egypt; that this claim had never been relinquished, and was well known to the Canaanites, and that therefore the Israelites only took possession of that which belonged to them. The same hypothesis is maintained by Jahn (*Hebrew Commonwealth*, ch. ii, § x, Stowe's transl.). In the Fragments attached to Taylor's edition of Calmet's *Dictionary* (iv, 95, 96) another ground of justification is sought in the supposed identity of race of the Egyptian dynasty under which the Israelites were oppressed with the tribes that overran Canaan, so that the destruction of the latter was merely an act of retributive justice for the injuries which their compatriots in Egypt had

inflicted on the Israelites. To all these and similar attempts to justify, on the ground of *legal right*, the forcible occupation of the land by the Israelites, and the extermination (at least to a great extent) of the existing occupants, it is to be objected that no such reason as any of these is hinted at in the sacred record. The right to carry on a war of extermination is there rested simply on the divine command to do so. That the Israelites were instruments in God's hand is a lesson not only continually impressed on their minds by the teaching of Moses, but enforced by their defeat whenever they relied on their own strength. That there *may* have been grounds of justification, on the plea of human or legal right, ought not, indeed, to be denied; but it is, we imagine, quite clear, from the numerous attempts to find what these grounds were, that they are not stated in the Old Testament; and to seek for them as though they were necessary to the justification of the Israelites, seems to be an abandonment of the high ground on which alone their justification can be safely rested—the express command of God.

"It may be said that this is only shifting the difficulty, and that just in proportion as we exculpate the Israelites from the charges of robbery and murder, in their making war without *legal* ground, we lower the character of the Being whose commands they obeyed, and throw doubt on those commands being really given by God. This has indeed been a favorite objection of infidels to the divine authority of the Old Testament. Such objectors would do well to consider whether God has not an absolute right to dispose of men as he sees fit, and whether an exterminating war, from which there was at least an opportunity of escape by flight, is at all more opposed to our notions of justice than a destroying flood, or earthquake, or pestilence. Again, whether the fact of making a chosen nation of *His* worshippers the instrument of punishing those whose wickedness was notoriously great, did not much more impressively vindicate his character as the only God, who 'will not give his glory to another, nor his praise to graven images,' than if the punishment had been brought about by natural causes. Such considerations as these must, we apprehend, silence those who complain of injustice done to the Canaanites. But then it is objected further that such an arrangement is fraught with evil to those who are made the instruments of punishment, and, as an example, is peculiarly liable to be abused by all who have the power to persecute. As to the first of these objections, it must be remembered that the conduct of the war was never put into the hands of the Israelites; that they were continually reminded that it was for the wickedness of those nations that they were driven out; and, above all, that they themselves would be exposed to similar punishment if they were seduced into idolatry, an evil to which they were especially prone. As to the example, it can apply to no case where there is not an equally clear expression of God's will. A person without such a commission has no more right to plead the example of the Israelites in justification of his exterminating or even harassing those whom he imagines to be God's enemies, than to plead the example of Moses in justification of his promulgating a new law purporting to come from God. In a word, the justification of the Israelites, as it appears to us, is to be sought in this alone, that they were clearly commissioned by God to accomplish this work of judgment, thus at once giving public testimony to, and receiving an awful impression of His power and authority, so as in some measure to check the outrageous idolatry into which almost the whole world had sunk" (Kitto, *Cyclop.* s. v.).

See Kitto, *Pict. Hist. of the Jews*, i, 886 sq.; also *Daily Bible Illustr.* ii, 285 sq.; Bp. Sherlock, *Works*, v; Drew, *Script. Studies*, p. 122 sq.; Paley, *Sermoes*, p. 429; Mill, *Sermoes* (1845), p. 117; Simeon, *Works*, ii.

596; Scott, *The Extirpation of the Canaanites* (Sermons, i, 296 sq.); Pittman, *Destruction of the Canaanites* (Easter Sermon, i, 481 sq.); Bp. Mantz, *Extirpation of the Canaanites* (Sermons, iii, 185 sq.); Benjotin, *Vindication*, etc. (Lond. 1797); Stiebritz, *De justitia belli adv. Canaanitas* (Hal. 1759); Robert, *Cassia belli Israelitici adv. Canaanicos* (Marb. 1778); Nonne, *De justitia armorum Israelitarum adv. Canaanicos* (Brem. 1756); Schubert, *De justitia belli in Canaanicos* (Greifsw. 1767); Hengstenberg, *Authenticity of the Pentateuch*, ii, 567 sq.

CANAANITE, or rather **CANANITE** (Received Text [with the Codex Sinaiticus], δ *Kanavairns*; Codex A, *Kanavairns*; Lachm. with B C, δ *Kanavairos*; D, *Xanavairos*; Vulg. *Chanaanus*), the designation of the apostle ΣΙΜΩΝ, otherwise known as "Simon Zelotes." It occurs in Matt. x, 4; Mark iii, 18. This word does not signify a descendant of Canaan, that being in the Greek both of the Sept. and the N. T. *Xanavairos* = קַנְנַתִּי (comp. Matt. xv, 22 with Mark vii, 26). Nor does it signify, as has been suggested, a native of Kana, since that would probably be *Kavirns*. But it comes from the Heb. קַנְנַתִּי, *kanna'*, zealous, or rather from the Chaldees קַנְנַתִּי, *Kanna'*, or Syriac *Kanengeh*, by which the Jewish sect or faction of "the Zealots"—so prominent in the last days of Jerusalem—was designated (see Buxtorf, *Lex. Talm.* col. 2060). This Syriac word is the reading of the Peshito version. The Greek equivalent is Ζηλωτής, *Zelotes*, and this Luke (vi, 15; Acts i, 13) has correctly preserved. Matthew and Mark, on the other hand, have literally transferred the Syriac word, as the Sept. did frequently before them. There is no necessity to suppose, as Mr. Cureton does (*Nitrian Rec.* lxxxvii), that they mistook the word for *Kena'angah* = *Xanavairos*, a Canaanite or descendant of Canaan. The Evangelists could hardly commit such an error, whatever subsequent transcribers of their works may have done. But that this meaning was afterward attached to the word is plain from the readings of the Codex Bezae (D) and the Vulgate above. The spelling of the A. V. has doubtless led many to the same conclusion; and it would be well if it were altered to "Kananite," or some other form (as was done in the late revision by the Am. Bib. Society, whose "standard" text had "Cananite") distinguished from the well-known one in which it now stands.—Smith, *Dict.* s. v. See **ZELOTES**.

Cancellarii (**CHANCELLORS, LAY**), one of the inferior classes of servants of the ancient Church and clergy. "The precise nature of their duties is doubtful. Bingham supposes them to have had some such office in the Church as those of the same name in the state, and that they acted as guards of the judge's consistory. Others suppose them to have been identical with the *judices* or *defensores*, whose duty it was to watch over the rights of the Church, to act as superintendents of the *copiata*, and to see that all clerks attended the celebration of morning and evening service in the Church."—Bingham, *Orig. Eccles.* bk. iii, ch. xi, § 6; Farrar, *Ecl. Dict.* s. v.

Cancelli, a lattice or balustrade; the rail separating the altar from the nave, in ancient churches, was called *cancelli*. See **CHANCEL**.

Cancellus, a word occasionally used in the meaning of *pulpit*. As the size of churches increased, preaching in the chancel became very difficult, and it often happened that the officiating bishop or presbyter was inaudible on account of his great distance from the people. Hence a custom was introduced of placing a *suggesum*, or pulpit, from which the preacher delivered the sermon, in front of the partition which divided the chancel from the nave. It was therefore called, in consequence of its position, *cancellus*.—Farrar, *Ecl. Dict.* s. v.

Can'dacæ (*Kandāch*: Hiller compares the Ethiopic קַנְנַתִּי, *he ruled*, and קַרְ, *a slave*, as the Ethiopian kings are still in Oriental phrase styled "prince of servants") [Simonis, *Onom.* N. T. p. 88]; but the name itself is written קַנְנַתִּי, *chandaki*, in Ethiopic; comp. Ludolf, *Hist. Æth.* iii, 2, 7), was the name of that queen of the Ethiopians (*ἡ βασίλισσα Αἰθίοπων*) whose high treasurer (ἐνοπιχός, "eunuch," i. e. chamberlain) was converted to Christianity under the preaching of Philip the Evangelist (Acts viii, 27), A. D. 80. The country over which she ruled was not, as some writers allege, what is known to us as Abyssinia; it was that region in Upper Nubia which was called by the Greeks *Merōs*, and is supposed to correspond to the present province of Atbara, lying between 13° and 18° north latitude. From the circumstance of its being nearly enclosed by the Atbara (Astaboras or Tacasse) on the right, and the Bahr el-Abiad, or White River, and the Nile on the left, it was sometimes designated the "island" of Merōs; but the ancient kingdom appears to have extended at one period to the north of the island as far as Mount Berkal. The city of Merōs stood near the present Assour, about twenty miles north of Shendy; and the extensive and magnificent ruins found not only there, but along the upper valley of the Nile, attest the art and civilization of the ancient Ethiopians. These ruins, seen only at a distance by Bruce and Burckhardt, have since been minutely examined and accurately described by Cailliaud (*Voyage à Merōs*), Ruppel (*Reisen in Nubien*, etc.), and other travellers. Merōs, from being long the centre of commercial intercourse between Africa and the south of Asia, became one of the richest countries upon earth; the "merchandise" and wealth of Ethiopia (Isa. xlv, 14) was the theme of the poets both of Palestine and Greece; and, since much of that affluence would find its way into the royal coffers, the circumstance gives emphasis to the phrase *πάσης τῆς γῆς*, "all the treasure" of Queen Candace. It is further interesting to know, from the testimonies of various authors (comp. the "Queen of Sheba," who visited Solomon, and see Josephus, *Ant.* viii, 6, 5), that for some time both before and after the Christian era, Ethiopia Proper was under the rule of female sovereigns, who all bore the appellation of "Candace," which was not so much a proper name as a distinctive title, common to every successive queen, like "Pharaoh" and "Ptolemy" to the kings of Egypt, and "Cæsar" to the emperors of Rome. Thus Pliny (*Hist. Nat.* vi, 29) says that the centurions whom Nero sent to explore the country reported "that a woman reigned over Merōs called *Candace*, a name which had descended to the queens for many years." Strabo also (p. 820, ed. Casaub.) speaks of a warrior-queen of Ethiopia called Candace, in the reign of Augustus, the same whom Dion Cassius (liv, 5) describes as queen of the "Ethiopians living above (*ὑπὲρ*) Egypt." In B. C. 22 she had invaded Egypt, and soon afterward insulted the Romans on the Ethiopian frontier of Egypt. Caius Petronius, the governor of the latter province, marched against the Ethiopians, and, having defeated them in the field, took Pselca, and then crossing the sands which had long before proved fatal to Cambyzes, advanced to Premnis, a strong position. He next attacked Napata, the capital of Queen Candace, took and destroyed it; but then retired to Premnis, where he left a garrison, whom the warlike queen assailed, but they were relieved by Petronius. She was still later treated favorably by Augustus. She is said to have lost one eye (see Smith's *Dict. of Class. Biog.* s. v.). This Napata, by Dion called Tenape, is supposed to have stood near Mount Berkal, and to have been a kind of second Merōs; and there is still in that neighborhood (where there are likewise many splendid ruins) a village which bears the very similar name of *Meracō*. Eusebius, who flourished in

the fourth century, says that in his day the queens of Ethiopia continued to be called Candace (*Hist. Eccl.* ii, 1, 10). A curious confirmation of the fact of female sovereignty having prevailed in Ethiopia has been remarked on the existing monuments of the country.



Ancient Ethiopian Queen triumphing over Captives.

Thus, on the largest sepulchral pyramid near Assour, the ancient Meroë (see Cailliaud, plate xlv), a female warrior, with the royal ensigns on her head, drags forward a number of captives as offerings to the gods; on another compartment she is in a warlike habit, about to destroy the same group. Heeren, after describing the monuments at Naga, or Naka, southeast of Shendy, says, "It is evident that these representations possess many peculiarities, and that they are not pure Egyptian. The most remarkable difference appears in the persons offering. The queens appear with the kings; and not merely as presenting offerings, but as heroines and conquerors. Nothing of this kind has yet been discovered on the Egyptian reliefs, either in Egypt or Nubia. It may therefore with certainty be concluded that they are subjects peculiar to Ethiopia. Among the Ethiopians, says Strabo (p. 1177), the women also are armed. Herodotus (ii, 100) mentions a Nitocris among the ancient queens of Ethiopia. Upon the relief [on the monument at Kalabshé] representing the conquest of Ethiopia by Sesostris, there is a queen, with her sons, who appears before him as a captive" (Heeren, *On the Nations of Africa*, ii, 899). The name Candace, or *Kandakai*, appears on the Egyptian mon-



K n d a h h a i. fem.
Hieroglyph for Candace.

uments on a royal cartouche, followed by the determinative sign for a woman. It is singular enough, that when Bruce was at Shendy, the government of the district was in the hands of a female called *Sittina*, i. e. the lady or mistress. He says, "There is a tradition there that a woman, whose name was Hendaqué, once governed all that country, whence we might imagine that this was part of the kingdom of Candace; for, writing this name in Greek letters, it will come to be no other than Hendaqué, the native or mistress of Chendi or Chandi" (*Travels to discover the Source of the Nile*, iv, 529; comp. i, 505). It is true that, the name *Kandaké* being foreign to the Jews, it is in vain to seek with Calmet for its etymology in Hebrew, but the conjectural derivation proposed by Bruce is wholly inadmissible; nor is the attempt (see above) of Hiller to trace its meaning in the Ethiopic

language much more satisfactory. De Dieu asserts, on the authority of ecclesiastical tradition, that the proper name of the queen mentioned in the Acts was *Lacaea*, and that of her chamberlain *Judäck*. It is not unlikely that some form of Judaism was at this period professed to a certain extent in Ethiopia, as well as in the neighboring country of Abyssinia. Irenæus (iii, 12) and Eusebius (*Hist. Eccl.* ii, 1) ascribe to Candace's minister her own conversion to Christianity, and the promulgation of the Gospel throughout her kingdom; and with this agrees the Abyssinian tradition that he was likewise the apostle of Tigré, that part of Abyssinia which lay nearest to Meroë; it is added that he afterward preached the Gospel in Arabia Felix, and also in the island of Ceylon, where he suffered martyrdom. (See Tillemont, *Mem. Hist. Eccl.* tom. ii; Bagnage, *Exercitatio anti-Baron.* p. 118; Ludolf, *Comment. ad Hist. Æthiop.* p. 89; Wolf, *Cursus*, ii, 118; *American Presb. Review*, April, 1865.)—Kitto, *Cyclop.* s. v. See ETHIOPIAN EUNUCH.

Candīdus, an Arian writer, who flourished about 364, and is the author of a book addressed to Marius Victorinus, *de Generatione Divinā*, which, together with the answer of Victorinus, is extant. It will be found in Zeigler's Commentary on Genesis (Basle, 1648, fol.). A fragment of an epistle of Candidus to Victorinus is preserved by Mabillon, *Analecta*, iv, 155.—Cave, *Hist. Lit.*, Anno 864; Landon, *Eccl. Dict.* s. v.

Candle, נֵר, a lamp, as elsewhere rendered; λύχνος, a light, as elsewhere.

I. Houses in the East were, from the earliest times, lighted up with lamps, and those of the Hebrews probably resembled such as we find depicted in the tombs at Thebes. Job, describing the destruction of a family among the Arabs, and the rendering one of their habitations desolate, says, "The light shall be dark in his tabernacle, and his candle shall be put out with him" (xviii, 6; xxi, 17). On the other hand, when God promises to give David a lamp always in Jerusalem, it is an assurance that his house should never become desolate. In the language of Jeremiah, to extinguish the light in an apartment is a convertible phrase for total destruction (Job xxv, 10). A burning lamp is, on the other hand, a symbol of prosperity (Job xxix, 8). Maillet, in his *Lettres d'Égypte*, says, "The houses in Egypt are never without lights; they burn lamps all the night long, and in every occupied apartment. So requisite to the comfort of a family is this custom reckoned, that the poorest people would rather retrench a part of their food than neglect it." Roberts, in illustration of the passage, "I will search Jerusalem with candles" (Zeph. i, 12), remarks, "Does a man declare his innocence of any crime, the accusers say, 'We will search thee with lamps;' 'Yes, yes, I will look into that affair with lamps;' 'What, have your lamps gone out? You see I am not guilty.'" See LAMP.

There are monographs bearing on this subject as follows: D. W. Müller, *De perennibus vel lucernis* (Altorf, 1705); J. J. Müller, *De vet. λυχνοκαίῃ* (Jen. 1661); Schurzfleisch, *De luminibus sacris* (in his *Controv.* xxv); Stockhausen, *De cultu et usu luminum antiquo* (Tr. ad Rh. 1726). See CANDLESTICK.

II. *Candles in Christian Worship*.—1. *Roman Church*.—The practice was probably derived from heathen and Jewish worship. Some Roman writers ascribe its origin to the early Christians, who, prevented by persecution from worshipping in daylight, held their meetings under ground, where artificial light was needed (Claude de Vert, *Explication des Cérémonies de l'église*). Others (e. g. Bergier, *Dict. de Théologie*, s. v.) quote the book of Revelation, wherein mention is made of "candles" and golden "candlesticks," in support of the usage, and also the *Apostolical Canons* (Can. 4), where mention is made of "oil for the holy lamp." Bergier also cites Jerome (*contra Vigilantium*, c. 8) in support of the use of lights in worship; but the pas-

sage cited simply speaks of a usage in the Eastern Church of lighting candles when the Gospels were read as a symbol of joy at receiving the light. Jerome expressly says the usage did not exist in the West, though he seems to justify the lighting of candles and lamps before the tombs of the martyrs. See LAMPS. The use of candles in the worship of the Roman Church is defended on the ground that they symbolize Christ as the "true light," and also of the injunction of Christ to his followers to be "the lights of men" (Matt. v, 14, 16).

The principal solemnities in the Roman Church at which candles are used are the mass, the administrations of the sacraments, the benedictions and processions. They are also frequently employed before the statues and images of the saints, and many use them at their private devotions, especially while praying for the dead. Numerous liturgical prescriptions regulate their use. They must be, except in cases of emergency, of wax, and their color is generally white or yellow, but rarely red. The *Paschal candle* is a large candle to which five grains of incense are attached in the form of a cross; in most Roman Catholic churches it is lighted with a newly-made fire on Easter eve. Alban Butler says that "Ennodius, bishop of Pavia (6th century), has left us two forms of prayer for the blessing of this candle. From him we learn that droppings or particles of the wax thereof, after Low Sunday, were distributed among the people, who burnt them in their houses against the influence of evil spirits, in which there was no superstition if the effect was not certainly expected, because it was hoped for and asked of God through the public prayers and blessings of the Church, directed for that end (!) The paschal candle is an emblem of Christ rising from the dead, the light of the world, and is a sign which announces to us the joy and glory of his resurrection. The five grains of frankincense fixed in it symbolically represent his five precious wounds, and the embalming of his body at his burial, and again in the grave, by the devout persons who brought spices to his monument. This great candle anciently gave light during the watching in the church on Easter-eve in the night. The *triple candle* arising from one stock signifies the Trinity of persons in one God, or the light of the Triune God shining to the world through Christ. This only burns during the office of holy Saturday morning; after which it is taken away, and no more made use of, not even on Easter-day."—Butler, *Feasts and Fasts* (Treat. vi, ch. viii).

2. In the Protestant Churches.—The Lutheran Church, after the Reformation, retained the use of lights on the altar; the Reformed churches abolished it. In the Church of England, the "Injunctions of Edward VI" (1547) forbade the use of lights, "except of two lights upon the high altar before the sacrament, which, for the signification that Christ is the very true light of the world, they shall suffer to remain still." In cathedral churches these two lights were generally kept on the altar, but not lighted; and the great writers and leaders of the Church of England wrote against the use of lights as tending to idolatry. So the Homily "On the Peril of Idolatry" quotes Lactantius as follows: "Seemeth he to be in his right mind who offereth up to the Giver of all light the light of a wax candle for a gift? He requireth another light of us, which is not smoky, but bright and clear, even the light of the mind and understanding. Their (the heathen) gods, because they be earthly, have need of light, lest they remain in darkness; whose worshippers, because they understand no heavenly thing, do draw religion, which they use, down to the earth." The Homily adds: "Thus far Lactantius, and much more, too long here to write, of candle-lighting in temples before images and idols for religion; whereby appeareth both the foolishness thereof, and also that in opinion and act we do agree altogether in our candle

religion with the Gentile idolaters." The Homily goes on to show that this candle worship is closely connected with superstition and idolatry. Jeremy Taylor says of the Papists: "This is plain by their public and authorized treatment of their images; they consecrate them; they hope in them; they expect gifts and graces from them; they clothe them and crown them; they erect altars and temples to them; they kiss them; they bow their head and knee before them; they light up tapers and lamps to them, which is a direct consumptives sacrifice; they do to their images as the heathen do to theirs; these are the words of Irenæus, by which he reproves the folly of some that had got the pictures of Christ and Pythagoras, and other eminent persons." In the so-called "Tractarian" revival of Romish usages in 1832 and the following years, the practice of putting candles on "the altar," and lighting them on certain festival days, was resumed. In the recent "Ritualistic" revival (1865) the practice has become quite common in the hands especially of young curates of a Romanizing turn. They defend the legality of the practice on the ground that the rubric preceding the "order for morning and evening prayer throughout the year" admits the use of "all ornaments of the church that were in this Church of England by the authority of Parliament in the second year of the reign of Edward VI;" while the Injunction, cited above, allows two lights to be kept on the altar. On the other side it is argued (1) that in the Church of England there is properly no altar, but only a communion table; (2) that, in fact, the two lights spoken of were never lighted in the early days after the Reformation, even in the cathedrals in which they were retained; and (3) that the use of candles is only a part of an idolatrous system of worship. See LAMPS; CANDLEMAS.

III. For the popish ceremony of "cursing with bell, book, and candle," see BELL.—Boissonnet, *Dictionnaire des Cérémonies*, s. v. *Cierge, Chandelier*; Martigny, *Dict. des Antiquités Chrétienues*, s. v. *Cierge*; Bingham, *Orig. Eccles.* bk. xiv, ch. iii, § 11; Goode, *Ceremonial of the Church of England*, § 9; Hook, *Church Dictionary* (defends candles), s. v. *Lights on the Altar*.

Candlemas, in the Roman Church, the feast of the purification of the Virgin Mary, held on the 2d of February, the fortieth after Christmas, and therefore celebrated as that on which the purification of the Virgin took place (Luke ii, 22). The Greek Church called it *ἡκαβάριον*, *festum occurus*, the feast of the meeting (see Luke ii, 25); also *festum presentationis Simeonis et Annæ*; *festum Simeonis*; the feast of the presentation of Simeon and Anna, or simply of Simeon. The name *festum candellarum* or *luminum*, the feast of lights (or Candlemas), came into use at a later period, after the introduction of candles into the service of the processions in honor of the Virgin. On this day the Romanists consecrate all the candles and tapers which they use in their churches during the whole year. At Rome the pope performs that ceremony himself, and distributes wax candles to the cardinals and others, who carry them in procession through the great hall of the pope's palace. Luther retained the festival as "a festival of our Lord Jesus Christ, who on this day manifested himself when he was borne into the Temple at Jerusalem and presented to the Lord." In many Lutheran churches it is still celebrated. In the Church of England the festival was abandoned in the second year of Edward VI.

The ceremonies observed on this festival are probably derived from the Februar or purificatory rites of paganism, which occurred on the same day, and which are briefly described by Ovid (*Fast.* ii). Pope Sergius (A. D. 641) has the credit of transferring this "false maumetry and untrue belief," as it is styled by Bacon, in his *Reliques of Rome*, to "God's worship." This pontiff hallowed the feast "thorowe all Christendome; and every Christian man and woman of covenable age

is bound to come to church and offer up their candles, as though they were bodily with our Lady; hoping for this reverence and worship that they do to our Lady to have a great reward in heaven." The following explanation is given by Pope Innocent III: "Why do we carry lighted candles at this festival? The answer may be derived from the book of Wisdom, where it is said (ch. xiv, 28) that the heathen offered sacrifices at night (*sacrificia obscuro*). The Gentiles, indeed, had devoted the month of February to the infernal deities, because, as they ignorantly believed, it was at the beginning of this month that Pluto had ravished Proserpine. Ceres, her mother, had, according to their belief, sought her through Sicily for a whole night by the light of torches kindled at the flames of *Ætna*. In commemoration of this, they every year, at the beginning of February, travelled the city during the night bearing lighted torches, whence this festival was called *amburbale*. But the holy fathers, being unable to abolish this custom, decided that lighted candles should be carried in honor of the blessed Virgin Mary; and thus what was formerly done for Ceres is done to-day in honor of the Virgin, and what was done formerly for Proserpine is now done in the praise of Mary" (Innocent III, *Opera*, "Serm. I. in fest. purif. Mariæ," fol. xlvii, col. 2, ed. Colonia, 1552).

The following are the prayers for the hallowing of candles upon Candlemas-day, copied from "The Doctrine of the Mass-book," 1564. The asterisks indicate crossings: "O Lord Jesus Christ, * bless thou this creature of a *waxen taper* at our humble supplication, and by the virtue of the holy cross pour thou into it an heavenly benediction; that as thou hast granted it unto man's use for the expelling of darkness, it may receive such a strength and blessing, through the token of thy holy cross, that in what places soever it be lighted or set, the Devil may avoid out of those habitations, and tremble for fear, and fly away discouraged, and presume no more to inquiet them that serve thee, who with God." etc. Then follow other prayers, in one of which occur these passages: "We humbly beseech thee that thou wilt vouchsafe to * bless and sanctify these candles prepared unto the uses of men, and health of bodies and souls, as well on the land as the waters." "Vouchsafe * to bless and * sanctify, and with the candle of heavenly benediction to lighten these tapers; which we thy servants taking in the honor of thy name (when they are lighted), desire to bear," etc. "Here let the candles be sprinkled with holy water." The service concludes with this Rubric: "When the hallowing of the candle is done, let the candles be lighted and distributed."

"The festival of St. Agatha, which commences on Candlemas-day in Sicily, strongly resembles the February rites. Lighted tapers form a distinguishing part of the ceremonial; and the memory of Proserpine is still cherished, though under another superstition, by kindling a blazing pine torch near the very spot to which the mythological legend assigned the scene of Pluto's amorous force. An account of this festival will be found in Blunt's *Vestiges of Ancient Manners in Italy*."—Bingham, *Orig. Eccles.* bk. xx, c. viii, § 4; Augusti, *Denkwürdigkeiten*, Thl. iii, p. 79; Siegel, *Altenthümer*, iii, p. 826; Eadie, *Eccles. Dictionary*, s. v.; Chambers, *Book of Days*, i, 212 sq.; Brand, *Popular Antiquities*, i, 24 sq.

Candlestick (מְנוֹרָה, *menorah*; Chald. מְנוֹרָתָא, *nebrahtak*; Sept. and N. T. λυχνία, properly a *lamp-stand*, as in Matt. v, 15), the candelabrum which Moses was commanded to make for the tabernacle, after the model shown him in the mount. Its form is chiefly known to us by the passages in Exod. xxv, 81-40; xxxvii, 17-24; on which some additional light is thrown by the Jewish writers, and by the representation of the spoils of the Temple on the arch (q. v.) of Titus at Rome, the only veritable monument extant



The Golden "Candlestick" as it now appears on the Arch of Titus.

of the kind (Prideaux, *Connection*, i, 166). It is called in Lev. xxiv, 4, "the pure," and in Eccles. xxvi, 19, "the holy candlestick." So Diodorus Siculus describes it (x, 100, ed. Bip.) as "the so-called immortal light perpetually burning in the fane" (ὁ ἀθάνατος—λεγόμενος λύχνος καὶ καύμενος ἀδιλείπτως ἐν τῷ ναῷ).

The material of which it was made was fine (חֹרֶט, "pure") gold, of which an entire talent was expended on the candelabrum itself and its appendages. The mode in which the metal was to be worked is described by a term (רֹפְעָה, "beaten [rather turned] work," Sept. *ροπερή*, Vulg. *ductile*) which appears to mean wrought with the hammer, as opposed to cast by fusion. Josephus, however, says (*Ant.* iii, 6, 7) that it was of cast gold (κεχρυσμένη), and hollow. The structure of the candelabrum, as far as it is defined in the passages referred to, consisted of a base (בִּיָּד, Joseph. *βίσις*; according to Maimonides, three feet high); of a shaft (גִּבְעוֹן, *reed*, i. e. stem) rising out of it; of six arms, which came out by threes from two opposite sides of the shaft; of seven lamps, which were supported on the summits of the central shaft and the six arms, terminating in seven heads all in one row [?], standing parallel to one another, one by one, in imitation of the planets (Whiston's *Josephus*, l. c.); and of three different kinds of ornaments belonging to the shaft and arms. These ornaments are called by names which mean *cups*, *circlets*, and *blowoms*: "four bowls made like unto almonds, with their knobs and their flowers." The cups (כַּפֵּי, Sept. *καρτήρες*, Vulg. *scyphi*) receive, in verse 83, the epithet *almond-shaped* (it being uncertain whether the resemblance was to the *fruit* or to the *flowers*). Three such cups are allotted to every arm, but four to the shaft: two-and-twenty in all. See *BOWL*. Of the four on the shaft, three are mentioned as if set severally under the spots where the three pairs of arms set out from the shaft. The place of the fourth is not assigned; but we may conceive it to have been either between the base and the cup below the lowest tier of arms, or, as Bähr prefers, to have been near the summit of the shaft. As for the name of the second ornament, the circlets (כַּתְרֵי, Sept. *κατάρια*), the word only occurs in two other places in the Old Testament (*Am.* ix, 1; *Zeph., 14), in which it appears to mean the capital of a column; but the Jewish writers generally (cited in Ugo lini *Theaur.* xi, 917) concur in considering it to mean *apples* in this place. Josephus, as he enumerates four kinds of ornaments, and therefore two of his terms must be considered identical, may be supposed to have understood *globes*, or *pomegranates* (σφαίρα, *πόσειδος*,*

Antiq. iii, 6). But as the term here used is not the common name for pomegranates, and as the Sept. and Vulgate render it *σφαειρωσῆς*, and *sphaerula*, it is safest to assume that it denotes bodies of a spherical shape, and to leave the precise kind undefined. Bähr, however, is in favor of *apples* (*Symbolik*, i, 414). See Knor. The name of the third ornament (שִׁבְרֵי הַקִּיבִּיץ, *kipiv, kibit*) means *blossom, bud*; but it is so general a term that it may apply to any flower. The Sept., Vulg., Josephus, and Maimonides understand it of the lily, and Bähr prefers the flower of the almond. It now remains to consider the manner in which these three ornaments were attached to the candelabrum. The obscurity of verse 33, which orders that there shall be "three almond-shaped cups on one arm, globe and blossom, and three almond-shaped cups on the other arm, globe and blossom, and so on all the arms which come out of the shaft," has led some to suppose that there was only one globe and blossom to every three cups. However, the fact that, according to verse 34, the shaft (which, as being the principal part of the whole, is here called the *candelabrum* itself), which had only four cups, is ordered to have globes and blossoms (in the plural), is a sufficient proof to the contrary. According to Josephus, the ornaments on the shaft and branches were 70 in number, and this was a notion in which the Jews, with their peculiar reverence for that number, would readily coincide; but it seems difficult, from the description in Exodus, to confirm the statement. It is to be observed that the original text does not define the height and breadth of any part of the candelabrum; nor whether the shaft and arms were of equal height; nor whether the arms were curved round the shaft, or left it at a right angle, and then ran parallel with it. The Jewish authorities maintain that the height of the candelabrum was eighteen palms, or about five feet; and that the distance between the outer lamps on each side was about $8\frac{1}{2}$ feet (Jahn, *Bibl. Arch.* § 329). Bähr, however, on the ground of harmonical proportion with the altar of incense and table of shew-bread, the dimensions of which are assigned, conjectures that the candelabrum was only an ell and a half high and broad. The Jewish tradition uniformly supports the opinion that the arms and shaft were of equal height, as do also Josephus and Philo (*l. c.*; *Quis Rer. Div. Her.* § 44), as well as the representation on the Arch of Titus. Scacchius has, however, maintained that they formed a pyramid, of which the shaft was the apex. The lamps themselves were doubtless simply set upon the summits of the shafts, and removed for the purpose of cleaning. As the description given in Exodus is not very clear, we abbreviate Lightfoot's explanation of it. "The foot of it was gold, from which went up a shaft straight, which was the middle light. Near the foot was a golden dish wrought almondwise, and a little above that a golden knob, and above that a golden flower. Then two branches, one on each side, bowed, and coming up as high as the middle shaft. On each of them were three golden cups placed almondwise on sharp, scallop-shell fashion, above which was a golden knob, a golden flower, and the socket. Above the branches on the middle shaft was a golden boss, above which rose two shafts more; above the coming out of these was another boss, and two more shafts, and then on the shaft upward were three golden scallop-cups, a knob, and a flower, so that the heads of the branches stood an equal height" (*Works*, ii, 397, ed. Pitman). Calmet remarks that "the number 7 might remind them of the Sabbath:" we have seen that Josephus gives it a somewhat Egyptian reference to the number of the planets, but elsewhere (*War*, vii, 5, 5) he assigns to the 7 branches a merely general reference to the Jewish hebdomadal division

of time. The whole weight of the candlestick was 100 minas (see Lamy, *De Tab. Fœd.*). It has been calculated to have been worth \$25,380, exclusive of workmanship.



Usual representation of the "Golden Candlestick," the arms being all in the same plane.

of time. The whole weight of the candlestick was 100 minas (see Lamy, *De Tab. Fœd.*). It has been calculated to have been worth \$25,380, exclusive of workmanship.

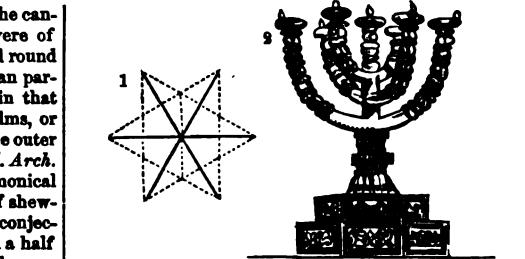

Different arrangement of the branches of the "Golden Candlestick." 1. Plan; 2. Elevation.

This candelabrum was placed in the Holy Place, on the south side (i. e. to the left of a person entering the tabernacle), opposite the table of shew-bread (*Exod.* xxvi, 35). Its lamps, which were supplied with wick (? of cotton) and half a log (about two wine-glasses) of pure olive oil only, were lighted every evening, and extinguished (as it seems) every morning (*Exod.* xxvii, 21; xxx, 7, 8; *Lev.* xxiv, 8; 1 *Sam.* iii, 3; 2 *Chron.* xiii, 11). Although the tabernacle had no windows (*Exod.* xxx, 8; *Macc.* iv, 60), there is no good ground for believing that the lamps burnt by day in it, whatever may have been the usage of the second Temple. It has also been much disputed whether the candelabrum stood lengthwise or diagonally as regards the tabernacle; but no conclusive argument can be adduced for either view. According to Josephus, it was placed in an oblique position (ἀοξῆς), so that the lamps looked to the east and south (*Ant.* iii, 6, 7; *Exod.* xxv, 37). As the lamp on the central shaft was by the Jewish writers called the *western*, or *evening lamp*, some maintain that the former name could not be applicable unless the candelabrum stood across the tabernacle, as then only would the central lamp point to the west. Others, again, adhere to the latter signification, and build on a tradition that the central lamp alone burnt from evening to evening, the other six being extinguished by day (Reland, *Antiq.* i, 5, 8). The priest in the morning trimmed the lamps with

golden snuffers (כִּנְדִּילָיִם; *κινυοσπίτες*; *forcipēs*), and carried away the snuff in golden dishes (כִּנְדִּיָּוִת; *κινυοθήματα*; *acerra*, Exod. xxv, 88). When carried about, the candlestick was covered with a cloth of blue, and put with its appendages in badger-skin bags, which were supported on a bar (Num. iv, 9).

In Solomon's Temple, instead of this single candelabrum (or besides it, as the Rabbins say, but what became of it is not known; see Keil, *Tempel Sol.* p. 109), there were ten of pure gold (whose structure is not described, although *flowers* are mentioned: 1 Kings vii, 49; 2 Chron. iv, 7), one half of which stood on the north and the other on the south side of the Holy Place. These are said to have formed a sort of railing before the veil, and to have been connected by golden chains, *under* which, on the day of atonement, the high priest crept. They were carried away to Babylon (Jer. lii, 19). In the Temple of Zerubbabel there appears to have been only one candelabrum again (1 Macc. i, 21; iv, 49, 50). It is probable that it also had only seven lamps. At least, that was the case in the candelabrum of the Herodian temple, according to the description of Josephus (*War*, vii, 5). This candelabrum is the one which, after the destruction of Jerusalem, was carried with other spoils to Rome, where, after the triumph of Titus, it was deposited in the Temple of Peace, and, according to one story, fell into the Tiber from the Milvian bridge during the flight of Maxentius from Constantine, Oct. 28, 312 A. D.; but it probably, in A. D. 455, became a part of the plunder which Genseric transported to Carthage (Gibbon, iii, 291). It was, however, again, about A. D. 583, recaptured from the Vandals by Belisarius, and carried to Constantinople, and was thence sent off to Jerusalem (2d ed. iv, 24), from which time it has disappeared altogether. It is to this candelabrum that the representation on the Arch of Titus at Rome (see Fleck, *Wissenschaftl. Reise*, I, i, pl. 1) was intended to apply; and although the existence of the figures of eagles and marine monsters on the pediment of that lamp tends, with other minor objections, to render the accuracy of that copy questionable (as it is unlikely that the Jews should have admitted any such graven images into their temple), yet there is reason to believe that in other points it may be relied upon as a reasonably correct representation of the Herodian candelabrum. Reland has almost devoted a valuable little work to this subject, *De Spoliis Templi Hierosolym. in Arcu Titiano* (2d ed. by Scholze, 1775), p. 82 sq. See also Stellmann, *De candelabro aureo* (Brem. 1700); Schlichter, *De Lychnucho sacro* (Hal. 1740); Döderlein, *De Candelabris Judeorum sacris* (Viteb. 1711); Ugolino, *De Candelabro* (*Thesaur.* xi). See CANDLE.

From the fact that the golden candelabrum was expressly made "after the pattern shown in the mount," many have endeavored to find a symbolical meaning in all its ornaments, especially Meyer and Bähr (*Symbol.* i, 416, sq.). Generally it was "a type of preaching" (Godwyn's *Moses and Aaron*, ii, 1), or of "the light of the law" (Lightfoot, l. c.). Similarly candlesticks are elsewhere made types of the Spirit, of the Church, of witnesses (Zech. iv [see Scholze, *De Lychnucho*, Altona, 1741]; Rev. ii, 5; xi, 4; comp. Wemyss, *Clav. Symbol.* s. v.). When our Lord cried "I am the light of the World" (John viii, 12), the allusion was probably suggested by the two large golden chandeliers, lighted in the court of the women during the Feast of Tabernacles, which illuminated all Jerusalem (Wetstein, *ad loc.*), or perhaps to the lighting of this colossal candlestick, "the more remarkable in the profound darkness of an Oriental town" (Stanley, *Sinai and Palest.* p. 420).—Kitto, *Cyclop.* s. v.; Smith, *Dict.* s. v.; Winer, *Realwört.* s. v. Leuchter; Fairbairn, *Dict.* s. v. See LANTERN.

Cane, the rendering in only two passages (Isa. xliii, 24; Jer. vi, 20) of the Heb. word כִּנְדִּיָּוִת, *kaneh'*,

from which, indeed, the modern term (Chald., Syr., and Arab. essentially the same; Gr. *κάννη*, Lat. *canna*) appears to have been derived, signifying properly a reed (as usually translated), i. e. the tall sedgy plant with a hollow stem (from כִּנְנָק, to erect), growing in moist places (1 Kings xiv, 15; Job xl, 21; Isa. xix, 6; xxxv, 7; so Psa. lxxviii, 31, *beast of the reeds* [A. V. "multitude of spearmen"], i. e. the crocodile); also the sweet-flag (Ezek. xxvii, 19; Cant. iv, 14; fully Exod. xxx, 23); also the cultivated reed used as a staff (Ezek. xxix, 6; Isa. xxxvi, 6); hence a measuring reed or rod (Ezek. xl, 3, 5; xlii, 16-19); also a simple stalk of grain (Gen. xli, 5, 22); likewise the upper *bone* of the arm (Job xxxi, 22); the rod or beam of a balance, put for the balance itself (Isa. xlvi, 6); the shaft or stem of the sacred candelabrum (Exod. xxx, 31; xxxvii, 17), as well as its branches or tubes (Exod. xxxv, 32, 33, 35, etc.). As the name of a plant, the word designates in Scripture three kinds of the genus *Arundo*, of which the following account is chiefly compiled from Kitto's *Cyclop.* s. v. Kaneh.

1. *Common Cane.*—In most of the passages of the Old Testament the word *kaneh* seems to be applied strictly to reeds of different kinds growing in water—that is, to the hollow stems or culms of grasses, which are usually weak, easily shaken about by wind or by water, fragile, and breaking into sharp-pointed splinters. Thus, in 1 Kings xiv, 15, "As a reed is shaken in the water;" Job xl, 21, "He lieth in the covert of the reed;" Isa. xix, 6, "And they shall turn the rivers far away; and the reeds and flags shall wither." Also in ch. xxxv, 7; while in 2 Kings xviii, 21; Isa. xxxvi, 6; and Ezek. xxix, 7, there is reference to the weak and fragile nature of the reed: "Lo, thou trustest in the staff of this broken reed, on Egypt, whereon if a man lean, it will go into his hand, and pierce it."

The Greek word *κάλλαμος* appears to have been considered the proper equivalent for the Hebrew *kaneh*, being the term used by Matthew (xii, 20) when quoting the words of Isaiah (xlii, 3), "A bruised reed shall he not break." The Greek word Latinized is well known in the forms of *calamus* and *calmus*. Both seem to have been derived from the Arabic *kalm*, signifying a "reed" or "pen," and forming numerous compounds, with the latter signification, in the languages of the East. It also denotes a weaver's reed, and even cuttings of trees for planting or grafting. Or they may all be derived from the Sanscrit *kalm*, having the same signification. The German *kalm*, and the English *haulm*, usually applied to the straw or stems of grasses, would seem to have the same origin. The Greek *κάλλαμος* and the Latin *calamus* were used with as wide a signification as the Oriental *kalm*, and denoted a reed, the stalk or stem of corn, or any thing made therefrom, as a pen, an arrow, a reed pipe. *Κάλλαμος* is also applied to any plant which is neither shrub, bush (*βύβλος*), nor tree (*δένδρον*) (see Liddell and Scott's *Greek Lex.*). So *calamus* means any twig, sprig, or scion (Pliny, xvi, 14, 24). The term *κάλλαμος* occurs very frequently in the New Testament, and apparently with the same latitude of meaning: thus, in the sense of a reed or culm of a grass Matt. xi, 7; Luke vii, 24, "A reed shaken by the wind;" of a pen in 3 John 18, "But I will not with pen and ink write unto thee;" Matt. xxvii, 29, "Put a reed in his right hand;" ver. 30, "Took the reed and smote him on the head;" and in Mark xv, 19, it may mean a reed or twig of any kind. So also in Matt. xxvii, 48, and Mark xv, 36, where it is said that they filled a sponge with vinegar, and put it on a reed, while in the parallel passage, John xix, 29, it is said that they filled a sponge with vinegar, and put it upon *hyssop*, and put it to his mouth; from which it is probable that the term *κάλλαμος* was applied by both the Evangelists to the stem of the plant named hyssop, whatever this may have been, in like manner as Pliny

(xxiv, 14, 75) applies the term *calamus* to the stem of a bramble.

In later times the term cane has been applied more particularly to the stems of the *Calamus rotang*, and other species of ratan canes, which we have good grounds for believing were unknown to the ancients, notwithstanding the opinion of Sprengel (*Hist. Rei Herb.* i, 171), "Ctesias makes two kinds of 'calamus,' the male without pith, the female with it, the latter without doubt the *Calamus rotang*, the other our *Bambusa*, as Pliny restates (xvi, 86)." See FLAG.

2. *Cultivated Cane*.—Of this Dioscorides describes the different kinds in his chapter *περι καλάμου* (i, 114). 1. *Κάλαμος ὁ ναστός*, or the *Arundo farcta*, of which arrows are made (*Arundo arenaria*?). 2. The female, of which reed pipes were made (*A. donax*?). 3. Hol-



Arundo Donax.

low, with frequent knots, fitted for writing, probably a species of *Saccharum*. 4. Thick and hollow, growing in rivers, which is called *donax*, and also *Cypria* (*Arundo donax*). 5. *Phragmites* (*Arundo phragmites*), slender, light-colored, and well known. 6. The reed called *Phleos* (*Arundo ampeledemos Cyrillii*). (*Flora Neapol.* t. xii.) These are all described (l. c.) immediately before the papyrus, while *κάλαμος ἀρωματικός* is described in a different part of the book, namely, in ch. 17, along with spices and perfumes. The Arabs describe the different kinds of reed under the head of *Kusûb*, or *Kussûb*, of which they give *Calamus* as the synonymous Greek term.

From the context of several of the above passages of Scripture in which *kaneh* is mentioned, it is evident that it was a plant growing in water; and we have seen, from the meaning of the word in other languages, that it must have been applied to one of the true reeds, as, for instance, *Arundo Egyptiaca* (perhaps only a variety of *A. donax*), growing on the banks of the Nile. In the New Testament *κάλαμος* seems to be applied chiefly to plants growing in dry and even barren situations, as in Luke vii, 24, "What went ye into the wilderness to see—a reed shaken by the wind?" To such passages, some of the species of reed-like grasses, with slender stems and light flocculent inflorescence, formerly referred to *Saccharum*, but now separated as distinct genera, are well suited. See REED.

3. *Sweet Cane*.—This is designated in Heb. by *קנה בושם* (*Bo'sem*), reed of fragrance,

Exod. xxx, 28), or *KANEH HAT-TOB'* (*קנה טוב*), good or fragrant reed, Jer. vi, 20). It is probably intended also by *kaneh* ("reed") simply in Cant. iv, 14; Isa. xliii, 24; and Ezek. xxvii, 17, as it is enumerated with other fragrant and aromatic substances. Finally, it was brought from a far country (Jer. vi, 20; Ezek. xxvii, 19): Dan also, and Javan, going to and fro, carried bright iron, cassia, and calamus to the markets of Tyre.

The best description by ancient writers of this plant is that of Dioscorides (i, 17), who calls it the *aromatic reed* (*κάλαμος ἀρωματικός*), and immediately after as a *rush* (*σχοίνος*). He states it to be a produce of India, of a tawny color, much jointed, breaking into splinters, and having the hollow stem filled with pith like the web of a spider; also that it is mixed with ointments and fumigations on account of its odor. Hippocrates was acquainted with apparently the same substance (*κάλαμος εὐώδης* and *σχοίνος εὐσμος*), which Theophrastus, Polybius (v, 46), and Strabo (xvi, 2) describe as growing in Cœle-Syria, where modern travelers, however, have observed only common or scentless flags. Bochart, indeed, doubts whether the Scriptural plant could have been brought from India (*Hieroz.* pt. ii, l. v, c. 6); but Dr. Vincent maintains that this trade was then fully open (*Periplus of the Erythraean Sea*, ii, 365). Hence Dr. Royle (*Illustr. of Himal. Botany*, p. 425) identifies the "sweet cane" of Scripture with the *Andropogon calamus* (*aromaticus*), a



Andropogon Calamus Aromaticus.

plant extensively cultivated in India, from which an oil, deemed to be the famous *spikenard* of antiquity, is extracted (Royle, *Essay on Hindoo Medicine*, p. 83, 142; Hackett, *On the Spikenard of the Ancients*, p. 84; *Calcutta Med. Trans.* i, 367). See CALAMUS.

Cange, Du. See DUCANGE.

Canisius, Henricus, or de Nondt, nephew of Petrus, was born at Nimeguen, studied at Louvain, and taught the canon law in the University of Ingolstadt, where he died in 1610. The work by which he is best known is his *Antiquæ Lectiones* (1601, 1602, 1603, 6 vols.), republished by Basnage in 1725 (7 vols.), with notes, and with the Greek text in addition to the Latin version, which Canisius had given alone. Canisius also published *Summa Juris Canonici; Commentarium in Regulas Juris; Praelectiones academicae; De decimis primitiis, et usuris; De sponsalibus et matrimonio*: all collected and published by Bouvet in his *Opera Ca-*

sonica Canisii (Louvain, 1649). — *Biog. Univ.* vii, 12; *Landon, Ecol. Dictionary*, ii, 584.

Canisius, Petrus, of Nimeguen, a Jesuit, born May 8, 1524, entered the order of the Jesuits in 1543, became professor and rector of the University of Ingolstadt in 1549, and rector of the college of the Jesuits in Vienna in 1551. He used his influence with the emperor Ferdinand I for the suppression of Protestantism. As the first German "provincial" of the Jesuits, he established colleges of the order at Prague, Augsburg, Dillingen, and Fribourg (in Switzerland), at which latter place he died, Dec. 21, 1597. Canisius was one of the most prominent opponents of the Reformation in Germany, and the arrest of the reformatory movement in Austria and Bavaria is for a large part owing to his labors and his influence. In order to counteract the influence of the catechisms of Luther, and other works of the founders of Protestantism, he wrote his *Summa Doctrinae Christianae* (1584; with a commentary by P. Busæus, Cologne, 1586, and Augsburg, 1838 sq. 4 vols.; new edition, Landshut, 1842), which was translated into nearly all languages (Greek, Prague, 1612; Greek-Latin, Augsburg, 1612), and a shorter catechism, entitled *Institutiones Christianae pietatis* (1566), which, until the middle of the 18th century, served as the basis of popular instruction in the Catholic schools of Germany, and has, even in modern times, again come into use (new editions: Landshut, 1833; Mainz, 1840). See CATECHISM; also *Theol. Quartalschrift*, 1863, Heft 8, p. 446. Canisius also edited the letters of Jerome, Leo the Great, and Cyril of Alexandria, and compiled a Catholic Prayer-book (*Manuale Catholicum*, Antwerp, 1580; Augsburg, 1841; German, 8th edit. Landshut, 1829). The Protestants called him "the Austrian Dog," while the Jesuits praised him as the second apostle of Germany, and even endeavored to obtain his beatification. Their efforts, for a long time unfruitful, were at length crowned with success during the pontificate of Pius IX, who placed Canisius on the list of the "Beati." Biographies of Canisius were published in Latin by Raderus and Sacchini (Munich, 1629); in French by Dorigny (Paris, 1708); in Italian by Langore and Foli-gatti; in German by Werfer (in *Leben ausgezeichnete Catholicen*, Schaffhausen, 1852, 2 vols.).

Canker (γάγγραινα), a gangrene (2 Tim. ii, 17), mortification; a disease which spreads by degrees over the whole body. To such a putrid state of the system the apostle compares the corrupt doctrines of Hymeneus and Philetus.

Canker-worm (קָרְבָּן, *ye' lak*, feeding, Joel i, 4; ii, 25; "caterpillar," Psa. cv, 84; Jer. ii, 14, 27; Sept. βροϋχος, *s. e.* locust-grub; but *akppi*, locust, in Jer.; Chald. קָרְבָּן, winged locust; Syr. creeping locust) is generally referred to some hairy or caterpillar-like species of locust (Jer. ii, 27, קָרְבָּן, *bristly*, Auth. Ver. "rough"). Possibly it merely describes the locust in a certain stage of its growth, viz. just when it emerges from the caterpillar state and obtains the use of its wings; see Nah. iii, 16, "the canker-worm has thrown off" (צָרְבָּן, *A. V. spoiled*) its scales [or "expanded its wings"] and flown away; thus corresponding to the description by Jerome (in loc. Nah.) of the *attelabus* (ἀττὲλαβος), or "wingless locust" (Credner, *Joel*, p. 805; see Bochart, *Hieroz.* ii, 445). See LOCUST.

Canne, JOHN, a Baptist minister, was born in England about the year 1590 or 1600. In early life he was a minister in the Established Church, but joined the Baptists not far from 1630. He was for some time pastor of the church in Southwark, London, being successor to Mr. Hubbard, its first pastor. He was banished to Holland, where (not considering baptism a prerequisite to communion) he succeeded Ainsworth (q. v.) as pastor of his church in Amsterdam, and was

deservedly popular. While in banishment in 1634, he published a work on the *Necessity of Separation from the Church of England*. In 1640 he returned on a visit to England, and founded the Baptist Church in Broadmead, Bristol. Mr. Canne was equally eminent for learning, piety, knowledge of the Scriptures, and zeal for reformation. Canne's most important labor is his selection of marginal references to the Bible. He was the author of three sets of notes, which accompanied three editions of the Bible. His great ambition was "to make the Bible its own interpreter."—Ivimey, *English Baptists*; Jamieson, *Cyclop. of Biography*, 106; Neal, *History of the Puritans*.

Can'neh (Heb. *Kanneh*, כַּנְנֶה, one codex fully כַּנְנֶה; Sept. *Xaváa*, v. r. *Xaváav*; Vulg. *Chene*), doubtless a contracted form (Ezek. xxvii, 28) for the earlier *CALNEH* (q. v.) of Gen. x, 10.

Cannon JAMES S., D.D., an eminent minister of the Reformed Dutch Church, was born in Curaçoa, Jan. 28, 1776, and was educated under Dr. Peter Wilson and Rev. Alex. Miller at Hackensack, N. J. He was licensed to preach in 1796 by the Classis of Hackensack, and shortly after became pastor of the Reformed Dutch Church of Millstone and Six-mile Run, finally devoting his whole service to the latter church. His pastoral industry was remarkable, yet he wrote and committed to memory all his sermons. During part of his pastoral work he had to preach one sermon in Dutch and one in English every Sunday. In 1826 he was chosen Professor of Pastoral Theology and Ecclesiastical History in the Seminary at New Brunswick, and here he spent the remainder of his life, a laborious student, and a faithful and successful teacher. "His views of truth were more distinguished by exactness and solidity than by any far-reaching power; and yet, when he had discussed a subject, there was little left to be said." A large number of ministers were trained by Dr. Cannon. He died in great peace, July 25, 1852. After his death, the substance of his course of instruction was published under the title *Lectures on Pastoral Theology* (New York, 1858, 8vo). "The subjects embraced in the lectures are: 'The qualifications for the pastoral office,' 'pastoral duties,' 'the administration of the sacraments,' 'catechetical instruction,' 'visitation of the sick,' 'pastoral visitation,' 'religious declension,' 'extension of the Church,' 'instruction by example.' Dr. Cannon's discussion of the sacraments is particularly able, clear, and conclusive."—*N. Brunswick Review*, May, 1854, p. 104; *Bibliotheca Sacra*, April, 1854, p. 420.

CANON OF SCRIPTURE, as the phrase is usually employed, may be defined as "the Authoritative Standard of Religion and Morals, composed of those writings which have been given for this purpose by God to men." A definition frequently given of the Canon is, that it is "the Catalogue of the Sacred Books;" while Semler (*Von Freser Untersuchungen des Canons*), Doederlein (*Institutio Theol. Christ.* i, 68), and others, define it as "the List of the Books publicly read in the meetings of the early Christians;" both these, however, are defective, and the latter is not only historically incorrect, but omits the essential idea of the divine authority of these Scriptures. The account which we here give is chiefly compiled from the articles on the subject in Kitto's *Cyclopædia* and Smith's *Dictionary of the Bible*.

I. *Origin and uses of the term "Canon."*—1. In classical Greek, the word (*Kanv*, akin to *κῆν*, a "reed," [comp. Gesen. *Theos.* s. v.] *κάνη, κάνα, καννα* [*canalis, channel*], *CANE, canon*) signifies, (1) Properly, a straight rod, as the rod of a shield, or that used in weaving (*laciatorium*), or a carpenter's rule. (2) Metaphorically, a testing rule in ethics (comp. Aristot. *Eth. Nic.* iii, 4, 5), or in art (the *Canon* of Polyctetus; *Luc. de Salt.* p. 946 B), or in language (the *Canons* of

Grammar). The gift of tongues (Acts ii, 7) was regarded as the "canon" or test which determined the direction of the labors of the several apostles (Severian. *ap. Cram. Cat. in Act. ii, 7*). Chronological tables were called "canons of time" (Plut. *Sol. 27*); and the summary of a book was called *kanón*, as giving the "rule," as it were, of its composition. The Alexandrine grammarians applied the word in this sense to the great "classical" writers, who were styled "the rule" (ὁ *Kanón*), or the perfect model of style and language. (3) But, in addition to these active meanings, the word was also used passively for a measured space (at Olympia), and, in later times, for a fixed tax (Du Cange, s. v.).

2. In ecclesiastical usage, the word occurs in the Sept. in its literal sense (Jud. xiii, 6), and again in Aquila (Job xxxviii, 5). In the N. T. it is found in two places in Paul's epistles (Gal. vi, 16; 2 Cor. x, 13-16), and in the second place the transition from an active to a passive sense is worthy of notice. In patristic writings the word is commonly used both as a rule in the widest sense, and especially in the phrases "the rule of the Church," "the rule of faith," "the rule of truth." In the fourth century, when the practice of the Church was farther systematized, the decisions of synods were styled "Canons," and the discipline by which ministers were bound was technically "the Rule," and those who were thus bound were styled *Canonici* ("Canons"). In the phrase "the canon (i. e. fixed part) of the mass," from which the popular sense of "canonize" is derived, the passive sense again prevailed. (See below.)

3. As applied to *Scripture*, the derivatives of *kanón* are used long before the simple word. The Latin translation of Origen speaks of *Scriptura Canonica* (*de Princ. iv, 33*), *libri regulares* (*Comm. in Matt. § 117*), and *libri canonizati* (*id. § 28*). In another place the phrase *haberi in Canone* (*Prolog. in Cant. s. f.*) occurs, but probably only as a translation of *kanonizēsbai*, which is used in this and cognate senses in Athanasius (*Ep. Fest.*), the Laodicene Canons (*ἀκανόνιστα*, *Can. lix*), and later writers (*Isid. Pelus. Ep. cxiv*; comp. *Aug. de doct. Chr. iv, 9* [6]; and as a contrast, *Anon. ap. Euseb. H. E. v, 28*).

The first direct application of the term *kanón* to the Scriptures seems to be by Amphilochois (cir. 380), in his Catalogue of the Scriptures, where the word indicates the rule by which the contents of the Bible must be determined, and thus secondarily an index of the constituent books. Among Latin writers the word is commonly found from the time of Jerome (*Prolog. Gal.*) and Augustine (*De Civ. xvii, 24*; xviii, 38), and their usage of the word, which is wider than that of Greek writers, is the source of its modern acceptance.

The uncanonical books were described simply as "those without," or "those uncanonized" (*ἀκανόνιστα*, *Com. Leod. lix*). The apocryphal books, which were supposed to occupy an intermediate position, were called "books read" (*ἀναγιγνωσκόμενα*, *Athan. Ep. Fest.*), or "ecclesiastical" (*ecclesiastici*, *Rufin. in Synod. Apost. § 33*), though the latter title was also applied to the canonical Scriptures, which (Leont. *de Sect. ii*) were also called "books of the Testament" (*ἱερά-θηκα βιβλία*), and Jerome styled the whole collection by the striking name of "the holy library" (*Bibliotheca sancta*), which happily expresses the unity and variety of the Bible (Credner, *Zur Gesch. d. Kan. § 1*; Westcott, *Hist. of Canon of N. T. App. D*).

II. *The Jewish Canon*.—1. According to the command of Moses, the "book of the law" was "put in the side of the ark" (Deut. xxxi, 25 seq.), but not in it (1 Kings viii, 9; comp. Joseph. *Ant. iii, 1, 7*; v, 1, 17); and thus, in the reign of Josiah, Hilkiah is said to have "found the book of the law in the house of the Lord" (2 Kings xxii, 8; comp. 2 Chron. xxxiv, 14). This "book of the law," which, in addition to the direct precepts (Exod. xxiv, 7), contained general exhorta-

tions (Deut. xxviii, 61) and historical narratives (Exod. xvii, 14), was farther increased by the records of Joshua (Josh. xxiv, 26), and other writings (1 Sam. x, 25). From these sacredly guarded autographs copies were taken and circulated among the people (2 Chron. xvii, 9). At a subsequent time collections of proverbs were made (Prov. xxv, 1), and the later prophets (especially Jeremiah; comp. Kueper, *Jerem. Libror. ss. interp. et vindex*, Berol. 1887) were familiar with the writings of their predecessors, a circumstance which may naturally be connected with the training of "the prophetic schools." It perhaps marks a farther step in the formation of the Canon when "the book of the Lord" is mentioned by Isaiah as a general collection of sacred teaching (xxxiv, 16 [where it is implied that his own writings were to be added to those previously regarded as sacred; see Gesenius, *Comment. in loc.*]; comp. xxix, 18) at once familiar and authoritative; but it is unlikely that any definite collection either of "the Psalms" or of "the Prophets" existed before the Captivity. At that time Zechariah speaks of "the law" and "the former prophets" as in some measure co-ordinate (Zech. vii, 12); and Daniel refers to "the books" (Dan. ix, 2) in a manner which seems to mark the prophetic writings as already collected into a whole. Shortly after the return from Babylon, the Levites read and expounded the word of the Lord to the people (Neh. viii, 1-8; ix, 1-8).

2. Popular belief assigned to Ezra and "the great synagogue" the task of collecting and promulgating the Scriptures as part of their work in organizing the Jewish Church. Doubts have been thrown upon this belief (Rau, *De Synag. magna*, 1726; comp. Ewald, *Gesch. d. V. Jer. iv, 191* [see below]); but the statement is in every way consistent with the history of Judaism, and with the internal evidence of the books themselves. The later embellishments of the tradition, which represent Ezra as the second author of all the books (2 Esdras), or define more exactly the nature of his work, can only be accepted as signs of the universal belief in his labors, and ought not to cast discredit upon the simple fact that the foundation of the present Canon is due to him. Nor can it be supposed that the work was completed at once; so that the account (2 Macc. ii, 18) which assigns a collection of books to Nehemiah is in itself a confirmation of the general truth of the gradual formation of the Canon during the Persian period. The work of Nehemiah is not described as initiatory or final. The tradition omits all mention of the law, which may be supposed to have assumed its final shape under Ezra, but says that Nehemiah "gathered together the [writings] concerning the kings and prophets, and the [writings] of David, and letters of kings concerning offerings," while "founding a library" (2 Macc. i. c.). The various classes of books were thus completed in succession; and this view harmonizes with what must have been the natural development of the Jewish faith after the Return. The constitution of the Church and the formation of the Canon were both, from their nature, gradual and mutually dependent. The construction of an ecclesiastical polity involved the practical determination of the divine rule of truth, though, as in the parallel case of the Christian Scriptures, open persecution first gave a clear and distinct expression to the implicit faith.

The foregoing tradition occurs in one of the oldest books of the Talmud, the *Pirke Aboth*; and it is repeated, with greater minuteness, in the Babylonian Gemara (*Baba Bathra*, fol. 13, 2. See the passages in Buxtorf's *Tiberias*, lib. i, c. 10; comp. Wachner, *Antiq. Heb. i, 18*). The substance of it is that, after Moses and the elders, the sacred books were watched over by the prophets, and that the Canon was completed by Ezra, Nehemiah, and the men of the Great Synagogue. The earliest form in which this appears is in the fourth book of Esdras, a work dating from the end of the first

or beginning of the second century after Christ. Here it is asserted that Ezra, by divine command and by divine aid, caused to be composed 94 books by three men (Vulg. 204 books by five men) in forty days, 70 of which, wherein "is a vein of understanding, a fountain of wisdom, and a stream of knowledge," were to be given to the wise of the people, while the rest were to be made public, that "both the worthy and the unworthy might read them" (xiv, 42-47). These twenty-four thus made public are doubtless the canonical books. The statement is very vague; but that this is its reference is rendered probable by the appearance in the writings of some of the Christian fathers of a tradition that the sacred writings, which had been lost during the exile, were restored by Ezra in the time of Artaxerxes by inspiration (Clemens Alex., *Strom.* I, 22, p. 410; Potter; Tertullian, *De cultu fem.* i, 8; Irenæus, *adv. Her.* iii, 21 [25], etc.). Against this tradition it has been objected that it proves too much, for it says that the men of the Great Synagogue wrote the later books, such as the twelve minor prophets, etc. But that by writing is here meant, not the original composing of these books, but the ascription (the *to*-writing) of them to the sacred Canon, may be inferred, partly from the circumstance that, in the same tradition, the men of Hezekiah are said to have written the Proverbs, which can only mean that they copied them (see Prov. xxv, 1) for the purpose of inserting them in the Canon, and partly from the fact that the word here used (כֹּתְבֵי) is used by the Targumist on Prov. xxv, 1 as equivalent to the Heb. קִרְיָ, *to transcribe*. An attempt has also been made to discredit this tradition by adducing the circumstance that Simon the Just, who lived long after Ezra, is said, in the *Pirke Aboth*, to have been one of the members of the Great Synagogue; but to this much weight cannot be allowed, partly because Simon is, in the passage referred to, said to have been one of the *remnants* of the Great Synagogue, which indicates his having outlived it, and principally because the same body of tradition which states this opinion makes him the *successor* of Ezra; so that either the whole is a mistake, or the Simon referred to must have been a different person from the Simon who is commonly known by the title of "Just" (comp. Othonis *Lex. Rabbin. Philol.* p. 604, Gen. 1675; Hävernick's *Einleitung in das A. T.* Th. i, Abt. I, i, 48). Or we may adopt the opinion of Hartmann (*Die Enge Verbindung des Alt. Test. mit d. Neuen*, p. 127) that the college of men learned in the law, which gathered round Ezra and Nehemiah, and which properly was the Synagogue, continued to receive accessions for many years after their death, by means of which it existed till the time of the Maccabees, without our being required to suppose that what is affirmed concerning its doings in the time of Ezra is meant to refer to it during the entire period of its existence. Suspicions have also been cast upon this tradition from the multitude of extravagant wonders narrated by the Jews respecting the Great Synagogue. But such are found in almost every traditionary record attaching to persons or bodies which possess a nationally heroic character; and it is surely unreasonable, because a chronicler tells one or two things which are incredible, that we should disbelieve all besides that he records, however possible or even probable it may be. To this it may be added that there are some things, such as the order of daily prayer, the settling of the text of the Old Testament, the establishment of the traditional interpretation of Scriptures, etc., which must be assigned to the period immediately after the Captivity, and which presuppose the existence of some institute such as the Great Synagogue, whether this be regarded as formally constituted by Ezra or as a voluntary association of priests and scribes (Zunz, *Gottesdienstlichen Vorträge der Juden*, p. 88). Moreover there are some passages of Scripture (e. g. 1 Chron.

iii, 28, 24) which belong to a period somewhat later than any of the canonical writers. See EZRA.

This tradition, again, is confirmed by the following circumstances: (a.) The time in question was the latest at which this could be done. As the duty to be performed was not merely that of determining the genuineness of certain books, but of pointing out those which had been divinely ordained as a rule of faith and morals to the Church, it was one which none but a prophet could discharge. Now in the days of Nehemiah and Ezra there were several prophets living, among whom we know the names of Haggai, Zechariah, and Malachi; but with that age expired the line of prophets which God had appointed "to comfort Jacob, and deliver them by assured hope" (Ecclus. xlix, 10). On this point the evidence of Josephus, the apocryphal books, and Jewish tradition, is harmonious (comp. Joseph. *cont. Apion.* i, 8; 1 Macc. iv, 46; ix, 27; xiv, 41; Jerome, *ad Jes.* xlix, 21; Vitringa, *Obs. Sac.* lib. vi, cap. 6, 7; Hävernick, *Einleit.* i, 1, 27; Hengstenberg, *Beiträge zur Einleit. ins A. T.* i, 245). As the men of the Great Synagogue were thus the last of the prophets, if the Canon was not fixed by them, the time was passed when it could be fixed at all. (b.) That it was fixed at that time appears from the fact that all subsequent references to the sacred writings presuppose the existence of the complete Canon, as well as from the fact that of no one among the apocryphal books is it so much as hinted, either by the author or by any other Jewish writer, that it was worthy of a place among the sacred books, though of some of them the pretensions are in other respects sufficiently high (e. g. Ecclus. xxxiii, 16-18; 1, 28). Josephus, indeed, distinctly affirms (*cont. Ap.* l. c.) that, during the long period that had elapsed between the time of the close of the Canon and his day, no one had dared either to add to, or to take from, or to alter any thing in the sacred books. This plainly shows that about the time of Artaxerxes, to which Josephus refers, and which was the age of Ezra and Nehemiah, the collection of the sacred books was completed by an authority which thenceforward ceased to exist. See SYNAGOGUE, GREAT.

3. The persecution of Antiochus (B.C. 168) was for the Old Testament what the persecution of Diocletian was for the New, the final crisis which stamped the sacred writings with their peculiar character. The king sought out "the books of the law" (τὰ βιβλία τοῦ νόμου, 1 Macc. i, 56) and burnt them; and the possession of a "book of the covenant" (βιβλίον διαθήκης) was a capital crime (Joseph. *Ant.* xii, 5, 4). But this proscription of "the law" naturally served only to direct the attention of the people more closely to these sacred books themselves. After the Maccabean persecution the history of the formation of the Canon is merged in the history of its contents. The Bible appears from that time as a whole, though it was natural that the several parts were not yet placed on an equal footing, nor regarded universally and in every respect with equal reverence (comp. Zunz, *D. Gottesd. Vortr.* d. *Jud.* p. 14, 25, etc.).

But while the combined evidence of tradition and of the general course of Jewish history leads to the conclusion that the Canon in its present shape was formed gradually during a lengthened interval, beginning with Ezra and extending through a part or even the whole (Neh. xii, 11, 22) of the Persian period (B.C. 458-332), when the cessation of the prophetic gift pointed out the necessity and defined the limits of the collection, it is of the utmost importance to notice that the collection was peculiar in character and circumscribed in contents. All the evidence which can be obtained tends to show that it is false, both in theory and fact, to describe the O. T. as "all the relics of the Hebrew-Chaldaic literature up to a certain epoch" (De Wette, *Einl.* § 8), if the phrase is intended to refer to the time when the Canon was completed.

The epilogue of Ecclesiastes (xii, 11 sq.) speaks of an extensive literature, with which the teaching of Wisdom is contrasted, and "weariness of the flesh" is described as the result of the study bestowed upon it. It is impossible that these "many writings" can have perished in the interval between the composition of Ecclesiastes and the Greek invasion, and the Apocrypha includes several fragments which must be referred to the Persian period (Buxtorf, *Tiberias*, c. 10 sq.; Hottinger, *Thea. Phil.*; Hengstenberg, *Beiträge*, i; Hävernick, *Einkl. i*; Oehler, art. *Kanon d. A. T.* in Herzog's *Encyclop.*).

4. The division of the O.-T. Canon into three parts, "the Law," "the Prophets," and "the Writings" (תּוֹרָה נְבִיאִים כְּתוּבִים), is very ancient; it appears in the prologue to Ecclesiastics, in the New Testament, in Philo, in Josephus, and in the Talmud (Surenhusii Βιβ. Karaλλ. p. 49). Respecting the principle on which the division has been made, there is considerable difference of opinion. All are agreed that the first part, the Law, which embraces the Pentateuch, was so named from its containing the national laws and regulations. The second embraces the rest of the historical books, with the exception of Ruth, Esther, Ezra, Nehemiah, and the Chronicles; and the writings of the prophets, except Daniel and Lamentations. It is probable that it received its name *a parte potiori*, the majority of the books it contains being the production of men who were *professionally* prophets. That this criterion, however, determined the omission or insertion of a book in this second division, as asserted by Hengstenberg (*Authent. des Daniel*, p. 27), and by Hävernick (*Einkl. I*, sec. 11), cannot be admitted; for, on the one hand, we find inserted in this division the book of Amos, who was "neither a prophet nor a prophet's son;" and on the other, there is omitted from it the Book of Lamentations, which was unquestionably the production of a prophet. The insertion of this book in the last rather than in the second division has its source probably in some liturgical reason, in order that it might stand beside the Psalms and other lyric poetry of the sacred books. It is more difficult to account for the insertion of the book of Daniel in the third rather than in the second division; and much stress has been laid on this circumstance, as affording evidence unfavorable to the canonical claims of this book. But it is not certain that this book *always* occupied its present position. Is it not possible that for some reason of a mystical or controversial kind, to both of which sources of influence the Jews during the early ages of Christianity were much exposed, they may have altered the position of Daniel from the second to the third division? What renders this probable is, that the Talmudists stand alone in this arrangement. Josephus, Sirachides, Philo, the New Testament, all refer to the Hagiographa in such a way as to induce the belief that it comprised only the *poetical* portions of the Old Testament—the psalms, hymns, and songs; while in all the catalogues of the Old-Testament writers given by the early fathers, up to the time of Jerome, Daniel is ranked among the prophets, generally in the position he occupies in our common version. In the version of the Sept., also, he is ranked with the prophets next to Ezekiel. Nor does Jerome agree with the Talmud in all respects, nor does one class of Jewish rabbis agree with another in the arrangement of the sacred books. All this shows that no such fixed and unalterable arrangement of the sacred books, as that which is commonly assumed, existed anterior to the fifth century of the Christian *æra*, and proves very distinctly that the place then assigned to Daniel by the Talmudists was not the place he had during the preceding period, or originally occupied. See DANIEL, BOOK OF. As respects the name given to the *third* division, the most probable account of it is, that at first it was fuller—

viz., "the other writings," as distinguished from the Law and the Prophets (comp. the expression τὰ ἄλλα βιβλία, used by the Son of Sirach, *Eccclus. Prol.*); and that in process of time it was abbreviated into "the writings." This part is commonly cited under the title *Hagiographa* (q. v.).

5. The O.-T. Canon, as established in the time of Ezra, has remained unaltered to the present day. Some, indeed, have supposed that, because the Sept. version contains some books not in the Hebrew, there must have been a double Canon, a Palestinian and an Egyptian (Semler, *Apparat. ad liberaliorem V. T. interpret.* § 9, 10; Corrodi, *Beleuchtung der Gesch. des Jüdisch. u. Christlich. Kanons*, p. 155-184; Augusti, *Einleit. ins. A. T.* p. 79); but this notion has been completely disproved by Eichhorn (*Einkl. i*, 28), Hävernick (*Einkl. i*, § 16), and others. All extant evidence is against it. The Son of Sirach, and Philo, both Alexandrian Jews, make no allusion to it; and Josephus, who evidently used the Greek version, expressly declares against it in the passage above referred to (*Ap. i*, 8). The earlier notices of the Canon simply designate it by the threefold division already considered. The Son of Sirach mentions "the Law, the Prophets, and the other books of the fathers;" and again, "the Law, the Prophecies, and the rest of the books;" expressions which clearly indicate that in his day the Canon was fixed. In the New Test. our Lord frequently refers to the Old Test. under the title of "The Scriptures," or of "The Law" (*Matt. xxii*, 42; *xxii*, 29; *John x*, 30, etc.); and in one place he speaks of "the Law of Moses, the Prophets, and the Psalms" (*Luke xxiv*, 44); by the third of these titles intending, doubtless, to designate the Hagiographa, either after the Jewish custom of denoting a collection of books by the title of that with which it commenced, or, as Hävernick suggests, using the term *ψαλμοί* as a general designation of these books, because of the larger comparative amount of lyric poetry contained in them (*Einkl.* § 14). Paul applies to the Old Test. the appellations "the Holy Writings" (*γραφαὶ ἁγία*, *Rom. i*, 2); "the Sacred Letters" (*ἱερὰ γράμματα*, *2 Tim. iii*, 15), and "the Old Covenant" (*ἡ παλαιὰ διαθήκη*, *2 Cor. iii*, 14). Both our Lord and his apostles ascribe divine authority to the ancient Canon (*Matt. xv*, 8; *John x*, 84-86; *2 Tim. iii*, 16; *2 Peter i*, 19-21, etc.); and in the course of the New Test. quotations are made from all the books of the Old except Ruth, Ezra, Nehemiah, Esther, Canticles, Lamentations, and Ezekiel, the omission of which may be accounted for on the simple principle that the writers had no occasion to quote from them. Coincidences of language show that the apostles were familiar with several of the apocryphal books (Bleek, *Ueber d. Stellung d. Apokr. in der Stud. u. Krit.* 1863, p. 267 sq.), but they do not contain one authoritative or direct quotation from them, while, with the exception of Judges, Eccles., Cant., Esther, Ezra, and Nehemiah, every other book in the Hebrew Canon is used either for illustration or proof. Philo attests the existence in his time of the *ἱερὰ γράμματα*, describes them as comprising laws, oracles uttered by the prophets, hymns, and the other books by which knowledge and godliness may be increased and perfected (*De Vita Contemplat. in Opp.* ii, 275, ed Mangey); and quotations from or references to the most of the books are scattered through his writings. The evidence of Josephus is very important; for, besides general references to the sacred books, he gives a formal account of the Canon as it was acknowledged in his day, ascribing five books, containing laws and an account of the origin of man, to Moses, thirteen to the Prophets, and four, containing songs of praise to God and ethical precepts for men, to different writers, and affirming that the faith of the Jews in these books is such that for them they would suffer all tortures and death itself (*cont. Apion.* i, 7, 8; Eichhorn, *Einleit.* i, § 50; Jahn, *Introductio*, p. 50). The popular belief

TABLE II.—QUOTATIONS OF THE APOCRYPHA AS SCRIPTURE.

The quotations in brackets are doubtful either as to the reference, or as to the character assigned to the book quoted.

	1, 2 Maccabees.	Baruch.	Ecclesiasticus.	Wisdom.	Tobit.	Judith.	Additions to Esther.	Additions to Daniel.
I. Greek writers.								
CLYDEMS ROM..	[Ep. ad Cor. 37.]	[Ep. ad Cor. 55.]		
FOLTOAF.....	[Ep. ad Phil. 10.]			
BARBARAS.....	[Ep. c. 6.]				
IRENEUS.....	Adv. hær. v, 85, 1	[Adv. hær. iv, 88, 8.]	[Adv. hær. i, 30, 11.]	Adv. hær. iv, 5, 2; 28, 3.
CLEM. ALEX. . .	[Stromat. v, 14.]	Prod. i, 10; ii, 3.	Strom. iii, 5, etc.	Stromat. iv, 16; vi, 11, 14, 15, etc.	Strom. ii, 28; vi, 12.	Strom. ii, 7.	Prop. Eccl. 1.
ORIGEN.....	De Princ. ii, 1, 5.	Sel. in Psa. cxxv. Sel. in Jer. xxxi.	Commentar. in Joan. xxxii, 14.	a. Cels. iii, 79; v, 29; Hom. septe.	Ep. ad Afric. 18. De Orat. 11.	[Hom. ix, in Jud. 1.]	Ep. ad Afric. 14.	Ep. ad Afric. etc.
HIPPOLYTUS...	[De Antioch. 49.]	Adv. d. Noët. 5.	In Comf. Prod.	[In Dam. p. 697, ed. Migne.]	Sel. in Jer. 28.	Com. in Dam. p. 639 sq., ed. Migne. [Conv. xl, 3.]
METHIDIUS....	Cons. viii, 3.	Cons. i, 3, etc.	Cons. i, 3, etc.	[Cons. xl, 3.]	
ATHANASIUS...	c. Arian. i, 416.	c. Arian. i, 418.	c. Arian. i, 518.	c. Arian. i, 122.	c. Arian. iii, 580.
EUSEBIUS.....	Dem. Ev. vi, 19.	Præp. Ev. i, 9.	
CYRIL HERMO.	Cat. xi, 15.	[Cat. xxiii, 17.]	Cat. ix, 2.	Cat. ii, 16, etc.
GERON. NAR..	Orat. xxxvi, 8.
BASEL.....	Adv. Euseb. iv, 16.	Adv. Euseb. v, 2.	Hom. xii. in Prov. 18.
EPIPHANIUS...	Hær. lvii, 9, etc.	Hær. xxiv, 6, etc.	Hær. xxvi (Gnost.) 15, etc.	Ancoor. 28, 24.
CHRYSOSTOM...	In Psa. xlix, 8.	De Laz. ii, 4.	In Psa. cix, 7.	
II. Latin writers.								
TERTULLIAN...	Scorp. 8.	[De præc. hær. 7.]	Adv. Herm. 44.
CYRILL.....	Ep. 59 [55], 4.	Testim. ii, 6.	Testim. ii, 1; De Mortal. 9.	Test. ii, 14; De Mortal. 23.	De Orator. Dom. 23.	De Orator. Dom. 8.
HILARIUS PROT.	In Pa. lxviii, 19. De Trtn. iv, 142.	In Pa. lxxvi, 9, etc.	In Pa. cxviii, 2, 8.	In Pa. cxxxix, 7.	In Pa. cxxv, 6.	In Psa. lii, 19, etc.
AMROBIUS....	In Pa. cxviii, 18, 2.	De bono mortis, 8. [Dial. c. Pelag. i, 33.]	De Sp. S. iii, 18, 185, etc. [Dial. c. Pelag. i, 33.]	Lib. de Tobia, 1.	De Sp. S. iii, 6, 89.
JEROME.....
LUCIFER.....	Demon. para. p. 956 sq.	Pro Athan. i, 960, ed. Migne.	Pro Athan. i, 871.	Demon. para. p. 956.	Pro Athan. ii, 894 sq.
OPTATUS.....	De Sch. Don. iii, 3.	De Sch. Don. ii, 25.	
AUGUSTINE....	De Civ. xviii, 24.	In Pa. lxviii, 8, etc.	In Pa. lvii, 1.	Ser. cccxlii.

2. Up to the date of the Council of Trent (q. v.), the Romanists allow that the question of the Canon was open, but one of the first labors of that assembly was to circumscribe a freedom which the growth of literature seemed to render perilous. The decree of the Council "on the Canonical Scriptures," which was made at the 4th session (April 8th, 1546), at which about 53 representatives were present, pronounced the enlarged Canon, including the apocryphal books, to be deserving in all its parts of "equal veneration" (pari pietatis affectu), and added a list of books "to prevent the possibility of doubt" (ne cui dubitatio suboriri possit). This hasty and peremptory decree, unlike in its form to any catalogue before published, was closed by a solemn anathema against all who should "not receive the entire books, with all their parts, as sacred and canonical" (Si quis autem libros ipsos integros cum omnibus suis partibus, prout in ecclesia catholica legi consueverunt et in veteri vulgata Latina editione habentur, pro sacris et canonicis non susceperit . . . anathema esto, Conc. Trid. Sess. iv). This decree was not, however, passed without opposition (Sarpi, p. 189 sq. ed. 1655, though Pallavacino denies this); and, in spite of the absolute terms in which it is expressed, later Romanists have sought to find a method of escaping from the definite equalization of the two classes of sacred writings by a forced interpretation of the subsidiary clauses. Du Pin (Dissert. prælim. i, 1), Lamy

(App. Bibl. ii, 5), and Jahn (Eisn. in d. A. T. i, 141 sq. ap. Reuss, § 387) endeavored to establish two classes of proto-canonical and deutero-canonical books, attributing to the first a dogmatic, and to the second only an ethical authority. But such a classification, however true it may be, is obviously at variance with the terms of the Tridentine decision, and has found comparatively little favor among Romish writers (comp. [Herbst] Walte, Eisn. ii, 1 sq.). See DEUTERO-CANONICAL.

3. The reformed churches unanimously agreed in confirming the Hebrew Canon of Jerome, and refused to allow any dogmatic authority to the apocryphal books, but the form in which this judgment was expressed varied considerably in the different confessions. The Lutheran formularies contain no definite article on the subject, but the note which Luther placed in the front of his German translation of the Apocrypha (ed. 1534) is an adequate declaration of the later judgment of the Communion: "Apocrypha, that is, books which are not placed on an equal footing (nicht gleich gehalten) with Holy Scripture, and yet are profitable and good for reading." This general view was further expanded in the special prefaces to the separate books, in which Luther freely criticised their individual worth, and wholly rejected 2 and 4 Estras as unworthy of translation. At an earlier period Carlstadt (1520) published a critical essay, De canonicis scripturis

libellus (reprinted in Credner, *Zur Gesch. d. Kan. p. 291 sq.*), in which he followed the Hebrew division of the canonical books into three ranks, and added *Wisd.*, *Ecclus.*, *Judith*, *Tobit*, 1 and 2 *Macc.*, as Hagiographa, though not included in the Hebrew collection, while he rejected the remainder of the Apocrypha, with considerable parts of Daniel, as "utterly apocryphal" (*plane apocryphi*; Credn. p. 389, 410 sq.).

4. The Calvinistic churches generally treated the question with more precision, and introduced into their symbolic documents a distinction between the "canonical" and "apocryphal," or "ecclesiastical" books. The Gallican Confession (1561), after an enumeration of the Hieronymian Canon (Art. 3), adds (Art. 4) "that the other ecclesiastical books are useful, yet not such that any article of faith could be established out of them" (*quo [sc. Spiritu Sancto] suggerente docemur, illos [sc. libros Canonicos] ab aliis libris ecclesiasticis discernere, qui, ut sint utiles, non sunt tamen ejusmodi, ut eis constitutus possit aliquis fidei articulus*). The Belgic Confession (1561?) contains a similar enumeration of the canonical books (Art. 4), and allows their public use by the Church, but denies to them all independent authority in matters of faith (Art. 6). The later Helvetic Confession (1562, Bullinger) notices the distinction between the canonical and apocryphal books, without pronouncing any judgment on the question (Niemeyer, *Litr. Symb. Eccles. Ref.* p. 468). The Westminster Confession (Art. 3) places the apocryphal books on a level with other human writings, and concedes to them no other authority in the Church.

5. The English Church (Art. 6) appeals directly to the opinion of St. Jerome, and concedes to the apocryphal books (including [1571] 4 *Esdras* and the Prayer of Manasses) a use "for example of life and instruction of manners," but not for the establishment of doctrine; and a similar decision is given in the Irish Articles of 1615 (Hardwick, *ut sup.* p. 341 sq.). The original English Articles of 1552 contained no catalogue (Art. 5) of the contents of "Holy Scripture," and no mention of the Apocrypha, although the Tridentine decree (1546) might seem to have rendered this necessary. The example of foreign churches may have led to the addition upon the later revision. The Methodist Episcopal Church has adopted the same Canon of Scripture, but entirely omits the Apocrypha (*Discipline*, pt. i, ch. 1, § 2, Art. 5); and those books, as they stand in the Hebrew Canon and Greek Testament, are alone received by the evangelical churches of America.

6. The expressed opinion of the later Greek Church on the Canon of Scripture has been modified in some cases by the circumstances under which the declaration was made. The "Confession" of Cyril Lucar, who was most favorably disposed toward the Protestant churches, confirms the Laodicene Catalogue, and marks the apocryphal books as not possessing the same divine authority as those whose canonicity is unquestioned (Kimmel, *Mon. Fvd. Eccles. Or.* i, 42). In this judgment Cyril Lucar was followed by his friend Metrophanes Critopolus, in whose confession a complete list of the books of the Hebrew Canon is given (Kimmel, ii, 105 sq.), while some value is assigned to the apocryphal books in consideration of their ethical value; and the detailed decision of Metrophanes is quoted with approval in the "Orthodox Teaching" of Platon, Metropolitan of Moscow (ed. Athens, 1836, p. 59). The "Orthodox Confession" simply refers the subject of Scripture to the Church (Kimmel, p. 159; comp. p. 123). On the other hand, the Synod at Jerusalem, held in 1672, "against the Calvinists," which is commonly said to have been led by Romish influence (yet comp. Kimmel, p. lxxxviii), pronounced that the books which Cyril Lucar "ignorantly or maliciously called apocryphal" are "canonical and Holy Scripture," on the authority of the testimony of the ancient Church ([Kimmel,] Weissenborn, *Dosithe. Confess.* p. 467 sq.). The Constantino-

politan Synod, which was held in the same year, notices the difference existing between the Apostolic, Laodicene, and Carthaginian Catalogues, and appears to distinguish the apocryphal books as not wholly to be rejected. The authorized Russian Catechism (*The Doctrine of the Russian Church*, etc., by Rev. W. Blackmore, Aberd. 1845, p. 87 sq.) distinctly quotes and defends the Hebrew Canon on the authority of the Greek fathers, and repeats the judgment of Athanasius on the usefulness of the apocryphal books as a preparatory study in the Bible; and there can be no doubt that the current of Greek opinion, in accordance with the unanimous agreement of the ancient Greek Catalogues, coincides with this judgment.

7. The history of the Syrian Canon of the O. T. is involved in great obscurity from the scantiness of the evidence which can be brought to bear upon it. The Peshito was made, in the first instance, directly from the Hebrew, and consequently adhered to the Hebrew Canon; but as the Sept. was used afterward in revising the version, many of the apocryphal books were translated from the Greek at an early period, and added to the original collection (Assemani, *Bibl. Or.* i, 71). Yet this change was only made gradually. In the time of Ephrem (cir. A. D. 370) the apocryphal additions to Daniel were yet wanting, and his commentaries were confined to the books of the Hebrew Canon, though he was acquainted with the Apocrypha (Lardner, *Credibility*, iv, 427 sq.; see Lengerke, *Daniel*, p. cxli). The later Syrian writers do not throw much light upon the question. Gregory Bar Hebraeus, in his short commentary on Scripture, treats of the books in the following order (Assemani, *Bibl. Orient.* ii, 282): the Pentateuch, Josh., Judg., 1 and 2 Sam., Psa., 1 and 2 Kings, Prov., *Ecclus.*, *Eccl.*, Cant., *Wisd.*, Ruth, *Hist. Sus.*, Job, Isa., 12 Proph., Jer., Lam., Ezek., Dan., *Bel.* 4 Gosp., Acts . . . 14 Epist. of Paul; omitting 1 and 2 Chron., Ezra, Neh., Esther, *Tobit*, 1 and 2 *Macc.*, *Judith*, (*Baruch?*), *Apocalypse*, Epist. James, 1 Pet., 1 John.

In the Scriptural Vocabulary of Jacob of Edessa (Assemani, ii, 499), the order and number of the books commented upon is somewhat different: Pent., Josh., Judg., Job, 1 and 2 Sam., David (i. e. Psa.), 1 and 2 Kings, Isa., 12 Proph., Jer., Lam., *Baruch*, Ezek., Dan., Prov., *Wisd.*, Cant., Ruth, Esth., *Judith*, *Ecclus.*, Acts, Epist. James, 1 Pet., 1 John, 14 Epist. of Paul, 4 Gosp.; omitting 1 and 2 Chron., Ezra, Neh., *Eccl.*, *Tobit*, 1 and 2 *Macc.*, *Apoc.* (comp. Assemani, *Bibl. Orient.* iii, 4, note).

The Catalogue of Ebed-Jesu (Assemani, *Bibl. Orient.* iii, 5 sq.) is rather a general survey of all the Hebrew and Christian literature with which he was acquainted (*Catalogus librorum omnium Ecclesiasticorum*) than a Canon of Scripture. After enumerating the books of the Hebrew Canon, together with *Ecclus.*, *Wisd.*, *Judith*, *add. to Dan.*, and *Baruch*, he adds, without any break, "the traditions of the Elders" (*Mishna*), the works of Josephus, including the Fables of *Æsop* which were popularly ascribed to him, and at the end mentions the "book of *Tobias and Tobit*." In like manner, after enumerating the 4 Gosp., Acts, 3 Cath. Epist. and 14 Epist. of Paul, he passes at once to the Diatessaron of Tatian, and the writings of "the disciples of the apostles." Little dependence, however, can be placed on these lists, as they rest on no critical foundation, and it is known from other sources that varieties of opinion on the subject of the Canon existed in the Syrian Church (Assemani, *Bibl. Orient.* iii, 6, note).

One testimony, however, which derives its origin from the Syrian Church, is specially worthy of notice. Junilius, an African bishop of the 6th century, has preserved a full and interesting account of the teachings of Paulus, a Persian, on Holy Scripture, who was educated at Nisibis, where "the Divine Law was regularly explained by public masters" as a branch of

common education (Junli. *De part. leg. Prof.*). He divides the books of the Bible into two classes, those of "perfect" and those of "mean" authority. The first class includes all the books of the Hebrew Canon with the exception of 1 and 2 Chron., Job, Canticles, and Esther, and with the addition of *Ecclesiasticus*. The second class consists of Chronicles (2), Job, Ecdras (2), Judith, Esther, and *Maccabees* (2), which are added by "very many" (*plurimi*) to the canonical books. The remaining books are pronounced to be of no authority, and of these Canticles and Wisdom are said to be added by "some" (*quidam*) to the Canon. The classification as it stands is not without difficulties, but it deserves more attention than it has received (comp. Hody, p. 653; Gallandi *Biblioth.* xii, 79 sq. The reprint in Wordsworth, *On the Canon*, App. A, p. 42 sq., is very imperfect).

8. The Armenian Canon, as far as it can be ascertained from editions, follows that of the Sept., but it is of no critical authority; and a similar remark applies to the Ethiopic Canon, though it is more easy in this case to trace the changes through which it has passed (Dillmann, *Ueber d. Aeth. Kan.*, in Ewald's *Jahrbuch*, 1858, p. 144 sq.).

See, on this branch of the subject, in addition to the works above, Schmid, *Hist. ant. et vindic. Can. S. Vet. et Nov. Test.* (Lips. 1775); [H. Corrodi], *Versuch einer Beleuchtung . . . d. Bibl. Kanons* (Halle, 1792); Movers, *Loc. quidam Hist. Can. V. T. illustrati* (Breslau, 1842). The great work of Hody (*De biblior. test.* Oxon. 1706) contains a rich store of materials, though even this is not free from minor errors. Stuart's *Critical History and Defence of the Old-Test. Canon* is rather an apology than a history. See APOCRYPHA.

IV. *The Canon of the New Testament.*—The history of the N.-T. Canon presents a remarkable analogy to that of the Canon of the O. T. The beginnings of both Canons are obscure from the circumstances under which they arose; both grew silently under the guidance of an inward instinct rather than by the force of external authority; both were connected with other religious literature by a series of books which claimed a partial and questionable authority; both gained definiteness in times of persecution. The chief difference lies in the general consent with which all the churches of the West have joined in ratifying one Canon of the N. T., while they are divided as to the position of the O.-T. Apocrypha.

1. An ecclesiastical tradition (Photius, *Bibl. Cod.* p. 254) ascribes to the apostle John the work of collecting and sanctioning the writings which were worthy of a place in the Canon; but this tradition is too late, too unsupported by collateral evidence, and too much opposed by certain facts, such as the existence of doubt in some of the early churches as to the canonicity of certain books, the different arrangement of the books apparent in catalogues of the Canon still extant, etc., for any weight to be allowed to it. A much more probable opinion, and one in which nearly all the modern writers who are favorable to the claims of the Canon are agreed, is, that each of the original churches, especially those of larger size and greater ability, collected for itself a complete set of those writings which could be proved, by competent testimony, to be the production of inspired men, and to have been communicated by them to any of the churches as part of the written word of God; so that in this way a great many complete collections of the N.-T. Scriptures came to be extant, the accordance of which with each other, as to the books admitted, furnishes irrefragable evidence of the correctness of the Canon as we now have it. This opinion, which in itself is highly probable, is rendered still more so when we consider the scrupulous care which the early churches took to discriminate spurious compositions from such as were authentic—the existence, among some, of doubt regarding certain of the N.-T. books,

indicating that each Church claimed the right of satisfying itself in this matter—their high veneration for the genuine apostolic writings—their anxious regard for each other's prosperity leading to the free communication from one to another of whatever could promote this, and, of course, among other things, of those writings which had been intrusted to any one of them, and by which, more than by any other means, the spiritual welfare of the whole would be promoted—the practice of the fathers of arguing the canonicity of any book, from its reception by the churches, as a sufficient proof of this—and the reason assigned by Eusebius (*Hist. Eccles.* iii, 25) for dividing the books of the N. T. into *ὁμολογούμενοι* and *ἀντιλεγόμενοι*, viz. that the former class was composed of those which the universal tradition of the churches authenticated, while the latter contained such as had been received by the majority, but not by all (Storch, *Comment. Hist. Crit. de Libb. N. Testamenti Canonis*, etc. p. 112 sq.; Olshausen's *Echtheit der IV. Evang.* p. 489). In this way we may readily believe that, without the intervention of any authoritative decision, either from an individual or a council, but by the natural process of each body of Christians seeking to procure for themselves and to convey to their brethren authentic copies of writings in which all were deeply interested, the Canon of the New Testament was formed.

2. The first certain notice which we have of the existence of any of the New-Testament writings in a collected form occurs in 2 Pet. iii, 16, where the writer speaks of the epistles of Paul in such a way as to lead us to infer that at that time the whole or the greater part of these were collected together, were known among the churches generally (for Peter is not addressing any particular church), and were regarded as on a par with "the other Scriptures," by which latter expression Peter plainly means the sacred writings both of the Old and the New Testament, as far as then extant.—That John must have had before him copies of the other evangelists is probable from the *supplementary* character of his own gospel.—In the anonymous Epistle to Diognetus, which is, on good grounds, supposed to be one of the earliest of the uninspired Christian writings, the writer speaks of the Law, the Prophets, the Gospels, and the Apostles (§ xi, ed. Hefele).—Ignatius speaks of "betaking himself to the Gospel as the flesh of Jesus, and to the apostles as the presbytery of the Church," and adds, "the prophets also we love," thus showing that it was to the Scriptures he was referring (*Ep. ad Philadelphenos*, § v, ed. Hefele).—Theophilus of Antioch speaks frequently of the New-Testament writings under the appellation of *αἱ ἅγια γραφαί*, or *ὁ θεῖος λόγος*, and in one place mentions the Law, the Prophets, and the Gospels as alike divinely inspired (*ad. Autol.* iii, 11).—Clement of Alexandria frequently refers to the books of the New Testament, and distinguishes them into "the Gospels and Apostolic Discourses" (*Quis Dives Sacerus?* prope fin.; *Stromat.* sæpissime).—Tertullian distinctly intimates the existence of the New-Testament Canon in a complete form in his day by calling it "Evangelicum Instrumentum" (*adv. Marc.* iv, 2), by describing the whole Bible as "totum instrumentum utriusque Testamenti" (*adv. Prax.* c. 20), and by distinguishing between the "Scriptura Vetus" and the "Novum Testamentum" (*Ibid.* c. 18).—Irenæus repeatedly calls the writings of the New Testament "the Holy Scriptures," "the Oracles of God" (*adv. Har.* ii, 27; i, 8, etc.), and in one place he puts the evangelical and apostolical writings on a par with the Law and the Prophets (*Ibid.* i, 8, § 6). From these allusions we may justly infer that before the middle of the third century the New-Testament Scriptures were generally known by the Christians in a collected form, and revered as the word of God. That the books they received were the same as those now possessed by us is evident from the quotations from them furnished by the early fa-

thers, and which have been so carefully collected by the learned and laborious Lardner in his *Credibility of the Gospel History*. The same thing appears from the researches of Origen and Eusebius, both of whom carefully inquired, and have accurately recorded what books were received as canonical by the tradition of the churches or the church writers (*ἐκκλησιαστικῆ παράδοσις*), and both of whom enumerate the same books as are in our present Canon, though some of them, such as the Epistles of James and Jude, the 2d Ep. of Peter, the 2d and 3d of John, and the Apocalypse, they mention that though received by the majority, they were doubted by some (Euseb. *H. E.* iii, 25; vi, 24). Besides these sources of information, we have no fewer than ten ancient catalogues of the New-Testament books still extant. Of these, six accord exactly with our present Canon, while of the rest three omit only the Apocalypse, and one omits, with this, the Epistle to the Hebrews (Lardner's *Works*, vol. iv and v, 8vo; Horne's *Introduction*, i, 70, 8th edition).

8. The history of the N.-T. Canon may be conveniently divided into three periods. The first extends to the time of Hegesippus (c. A.D. 170), and includes the era of the separate circulation and gradual collection of the apostolic writings. The second is closed by the persecution of Diocletian (A.D. 303), and marks the separation of the sacred writings from the remaining ecclesiastical literature. The third may be defined by the third Council of Carthage (A.D. 397), in which a catalogue of the books of Scripture was formally ratified by conciliar authority. The first is characteristically a period of tradition, the second of speculation, the third of authority; and it would not be difficult to trace the features of the successive ages in the course of the history of the Canon. For this, however, we have not room in detail, but must refer to the foregoing statements in support of this remark, the truth of which is farther sustained by the history of the times.

TABLE III.—THE CHIEF CATALOGUES OF THE BOOKS OF THE NEW TESTAMENT.

Only "disputed" books are noticed, or such as were in some degree recognized as authoritative. The symbols are used as in Table I.

	Epistle to Hebrews.	Jude.	James.	1, 2 John.	3 Peter.	Apocalypse.	Epistle of Barnabas.	Shepherd of Hermas.	Epistle of Clement.	Apocalypse of Peter.
I. CONCILIAR CATALOGUES.										
[Laodicea].....	L. c. <i>supr.</i>
Carthage.....	L. c. <i>supr.</i>
Apostolic (Concl. Quinisext.).....	L. c. <i>supr.</i>
II. ORIENTAL CATALOGUES.										
<i>(a) Syria.</i>										
Peshito Version.....	
Junilius.....	?	?	?	?	?	?	?	?	?	L. c. <i>supr.</i>
Joann. Damasc.....	L. c. <i>supr.</i>
Ebed Jesu.....	L. c. <i>supr.</i>
<i>(b) Palestine.</i>										
Eusebius.....	?	?	?	?	?	?	?	?	?	H. E. iii, 25.
Cyrril of Jerusalem.....	L. c. <i>supr.</i>
Epiphanius.....	<i>Adver. hæret.</i> lxxxi, 5.
<i>(c) Alexandria.</i>										
Origen.....	?	?	?	?	?	?	.	.	.	<i>Ap. Euseb. H. E.</i> vi, 25.
Athanasius.....	†	L. c. <i>supr.</i>
<i>(d) Asia Minor.</i>										
Gregor. Naz.....	L. c. <i>supr.</i>
Amphilochius.....	?	?	?	?	?	?	.	.	.	L. c. <i>supr.</i>
<i>(e) Constantinople.</i>										
Chrysostom.....	<i>Synopsis S. S.</i> vi, 318 a.
Leontius.....	L. c. <i>supr.</i>
Nicophorus.....	?	?	†	L. c. <i>supr.</i>
III. OCCIDENTAL CATALOGUES.										
<i>(a) Africa.</i>										
<i>Cod. Clarom.</i>	()	• Tischdf. <i>Cod. Clar.</i> p. 463 sq.
Augustine.....	L. c. <i>supr.</i>
<i>(b) Italy.</i>										
<i>Can. Murat.</i>	†	• <i>Hist. N. T. Canon</i> , p. 558 sq.
Philastrus.....	<i>Hæret.</i> 88 (80).
Jerome.....	<i>Ad Paul. Ep.</i> 53, § 8 (l, 543, Migne).
Rufinus.....	†	L. c. <i>supr.</i>
Innocent.....	L. c. <i>supr.</i>
(Gelasius)	L. c. <i>supr.</i>
Caesiodorus (<i>Vet. Trans.</i>).....	†	<i>De inatit. dte. Litt.</i> 14.
<i>(c) Spain.</i>										
Isidors of Sev.....	<i>De Ord. Libr. S. S. init.</i>
<i>Cod. Brev.</i> 206.....	†	Hody, p. 649.

The persecution of Diocletian was directed in a great measure against the Christian writings (Lact. *Instit.* v, 2; *de mort. persec.* 16). The influence of the Scriptures was already so great and so notorious that the surest method of destroying the faith seemed to be the destruction of the records on which it was supported. The plan of the emperor was in part successful. Some were found who obtained protection by the surrender of the sacred books, and at a later time the question of the readmission of these "traitors" (*traditores*), as they were emphatically called, created a schism in the Church. The Donatists, who maintained the sterner judgment on their crime, may be regarded as maintaining in its strictest integrity the popular judgment in Africa on the contents of the Canon of Scripture which was the occasion of the dissension; and Augustine allows that they held, in common with the Catholics, the same "canonical Scriptures," and were alike "bound by the authority of both Testaments" (*August. c. Cresc.* i, 81, 57; *Ep.* 129, 5). The only doubt which can be raised as to the integrity of the Donatist Canon arises from the uncertain language that Augustine himself uses as to the Epistle to the Hebrews, which the Donatists may also have countenanced. But, however this may have been, the complete Canon of the N. T., as commonly received at present, was ratified at the third Council of Carthage (A.D. 397), and from that time was accepted throughout the Latin Church (Jerome, Innocent, Rufinus, Philastrius), though occasional doubts as to the Epistle to the Hebrews still remained (*Isid. Hisp. Proem.* § 85-109). It will be perceived that there was no dispute as to the authentic and inspired character of most of the books, and as to the remainder there exist very respectable testimonies even in this early age (see Table IV). See ANTILEGOMENA.

4. At the era of the Reformation the question of the N.-T. Canon again assumed great importance. The hasty decree of the Council of Trent, which affirmed the authority of all the books commonly received, called out the opposition of controversialists, who quoted and enforced the early doubts. Erasmus, with characteristic moderation, denied the apostolic origin of the *Epistle to the Hebrews*, 2 Peter, and the *Apocalypse*, but left their canonical authority unquestioned (*Præf. ad Antilegom.*). Luther, on the other hand, with bold self-reliance, created a purely subjective standard for the canonicity of the Scriptures in the character of their "teaching of Christ," and while he placed the Gospel and first Epistle of John, the Epistles of Paul to the Romans, Galatians, Ephesians, and the first Epistle of Peter, in the first rank as containing the "kernel of Christianity," he set aside the *Epistle to the Hebrews*, *Jude*, *James*, and the *Apocalypse* at the end of his version, and spoke of them and the remain-

TABLE IV.—REFERENCES TO THE ANTILEGOMENA UP TO THE BEGINNING OF THE THIRD CENTURY.
 The sign § marks a verbal citation; * a direct quotation; † an explanation of doubt; () an uncertain reference; † a clear rejection; [] that the evidence is suspicious, or inconclusive as to the authority assigned to the book.

	Epistle to the Hebrews.	Jude.	James.	§, § John.	§ Peter.	Apostolyp.	Epistle of Barnabas.	Shipping of Hermas.	Epistle of Clement.	Apostolyp. of Peter.
CLAUDENIUS ROM....	1 Ep. 84, etc. (Compare Jerome, De vit. et. 10.)	1 Ep. 10, 88, etc.	(1 Ep. 11.)
POYGAR.....	(1 Apol. 4, 19, 68.)	(1 Ep. 8.)
JOS. M. MARTI.....	(Euseb. H. E. v, 36.)	(Athe. hebr. iv, 19, 2.)
IRENEUS.....	(Euseb. H. E. v, 36.)
CHARLES ALBERT.....	1 Strom. vi, 8, § 99, Comp. Euseb. H. E. vi, 14.	1 Strom. iii, 2, § 11, Comp. Euseb. H. E. vi, 14.	(Comp. Euseb. H. E. vi, 14.)	Comp. Strom. ii, 10, § 68.	(Comp. Euseb. H. E. vi, 14.)	1 Ath. hebr. v, 1, § 6, Comp. Euseb. H. E. vi, 14, § 107.	1 Strom. ii, 4, § 11, etc. Comp. Euseb. H. E. vi, 14.	1 Ath. hebr. iv, 20, § 181.	1 Strom. i, 29, § 107, etc. Comp. Euseb. H. E. vi, 14.	1 Strom. iv, 11, § 107, etc. Comp. Euseb. H. E. vi, 14.
THEOPHILUS.....	2 De pudicit. 90 (Barnabas.)	De heb. stud. 8
ORIGEN.....	1 Ap. Euseb. H. E. vi, 38, etc.	Comment. in Matt. § x § 17; § 14, § xvii, 3.	Comment. in 1 Cor. xix, 6. § 1. Sed. in Ps. xxx.	[Hom. in Job. vii, 1.]	1 Hom. in Job. vii, 1; in Rom. i, 4. Comp. Sed. in Ps. iii.	1 Ap. Euseb. H. E. vi, 38.	1 Oede. i, 18.	1 De princ. ii, 1. Comp. in Rom. xvi, 14.	1 Sed. in Esak. viii.
DIONYSIUS ALEX.....	1 Ap. Euseb. H. E. vi, 41.	1 Comment. in Luc. xii, 46.
CYRILLUS.....	(† De arch. myst. 11.)
HIPPOLYTUS.....	(† Ploek 181.)
METHODIUS.....	1 De Resurr. s. p. 389 (ed. Migne), Cont.
EUSEBIUS.....	1 Red. Proph. i, 90, etc. Comp. H. E. iii, 8.	1 H. E. iii, 28.	1 H. E. iii, 28.	1 H. E. iii, 28.	1 H. E. iii, 28.	1 H. E. iii, 28.	1 H. E. iii, 28.	1 H. E. iii, 28.	1 H. E. vi, 18, § 5.	1 H. E. iii, 28.

ing Antilegomena with varying degrees of disrespect, though he did not separate 2 Peter and 2, 3 John from the other Epistles (comp. Landerer, art. *Kanon* in Herzog's *Encyclop.* p. 295 sq.). The doubts which Luther rested mainly on internal evidence were variously extended by some of his followers (Melancthon, *Cestus. Magdeb.*, Flacius, Gerhard; comp. Reuss, § 384); and especially with a polemical aim against the Romish Church by Chemnitz (*Exam. Conc. Trid.* i, 78). But while the tendency of the Lutheran writers was to place the Antilegomena on a lower stage of authority, their views received no direct sanction in any of the Lutheran symbolic books which admit the "prophetic and apostolic writings of the Old and

New Testaments" as a whole, without further classification or detail. The doubts as to the Antilegomena of the N. T. were not confined to the Lutherans. Carlstadt, who was originally a friend of Luther and afterward professor at Zurich, endeavored to bring back the question to a critical discussion of evidence, and placed the Antilegomena in a third class "on account of the controversy as to the books, or rather (ut certius loquar) as to their authors" (*De Can. Script.* p. 410-12, ed. Credn.). Calvin, while he denied the Pauline authorship of the *Epistle to the Hebrews*, and at least questioned the authenticity of 2 Peter, did not set aside their canonicity (*Præf. ad Hebr.*; *ad 2 Petr.*); and he notices the doubts as to James and Jude only to dismiss them.

5. The language of the Articles of the Church of England with regard to the N. T. is remarkable. In the Articles of 1552 no list of the books of Scripture is given; but in the Elizabethan Articles (1562, 1571) a definition of Holy Scripture is given as "the canonical books of the Old and New Testament, of whose authority was never any doubt in the Church" (Art. vi). This definition is followed by an enumeration of the books of the O. T. and of the Apocrypha; and then it is said summarily, without a detailed catalogue, "all the books of the N. T., as they are commonly received, we do receive and account them for canonical" (*pro canonicis habemus*). A distinction thus remains between the "canonical books" and such "canonical books as have never been doubted in the Church;" and it seems impossible to avoid the conclusion that the framers of the Articles intended to leave a freedom of judgment on a point on which the greatest of the Continental reformers, and even of Romish scholars (*Sixtus Sen. Biblioth. S. i, 1; Cajetan, Pref. ad Epp. ad Hebr., Jac., 2, 3 John, Jud.*) were divided. The omission cannot have arisen solely from the fact that the Article in question was framed with reference to the Church of Rome, with which the Church of England was agreed on the N.-T. Canon, for all the other Protestant confessions which contain any list of books give a list of the books of the New as well as of the Old Testament (*Conf. Belg. 4; Conf. Gall. 3; Conf. Fid. 1*). But, if this license is rightly conceded by the Anglican Articles, the great writers of the Church of England have not availed themselves of it. The early commentators on the Articles take little (Burnet) or no notice (Beveridge) of the doubts as to the Antilegomena; and the chief controversialists of the Reformation accepted the full Canon with emphatic avowal (Whitaker, *Disp. on Scripture*, cxiv, p. 105; Fulke's *Defence of Eng. Trans.* p. 8; Jewel, *Defence of Apol.* ii, 9, 1).

6. The judgment of the Greek Church in the case of the O. T. was seen to be little more than a reflection of the opinions of the West. The difference between the Roman and Reformed churches on the N. T. were less marked; and the two conflicting Greek confessions confirm, in general terms, without any distinct enumeration of books, the popular Canon of the N. T. (*Cyr. Luc. Conf. i, p. 42; Doct. Confess. i, p. 467*). The Confession of Metrophanes gives a complete list of the books, and compares their number—thirty-three—with the years of the Savior's life, that "not even the number of the sacred books might be devoid of a divine mystery" (*Metroph. Critop. Conf. ii, 105*, ed. Kimm. et Weissenb.). At present, as was already the case at the close of the 17th century (Leo Allatius, *ap. Fabric. Bibl. Græc. v, App. p. 88*), the Antilegomena are reckoned by the Greek Church as equal in canonical authority in all respects with the remaining books (*Catechism*, *ut sup.*).

V. *Authority of the present Canon of Scripture.*—1. The assaults which have been made, especially during the present century, upon the authenticity of the separate books of the O. and N. Test., are noticed under the special articles. The general course which they have taken is simple and natural. Semler (*Untersuch. d. Kan. 1771-5*) first led the way toward the later subjective criticism, though he rightly connected the formation of the Canon with the formation of the Catholic Church, but without any clear recognition of the providential power which wrought in both. Next followed a series of special essays, in which the several books were discussed individually, with little regard to the place which they occupy in the whole collection (Schleiermacher, Bretschneider, De Wette, etc.). At last an ideal view of the early history of Christianity was used as the standard by which the books were to be tried, and the books were regarded as results of typical forms of doctrine, and not the sources of them (F. C. Baur, Schwegler, Zeller). All true sense of historic evidence was thus lost. The growth of the Church was left

without explanation, and the original relations and organic unity of the N. T. were disregarded.

2. In order to establish the Canon of Scripture, it is necessary to show that all the books of which it is composed are of divine authority; that they are entire and inerrant; that, having them, it is complete without any addition from any other source; and that it comprises the whole of those books for which divine authority can be proved. It is obvious that, if any of these four particulars be not true, Scripture cannot be the sole and supreme standard of religious truth and duty. If any of the books of which it is composed be not of divine authority, then part of it we are not bound to submit to, and consequently, as a whole, it is not the standard of truth and morals. If its separate parts be not in the state in which they left the hands of their authors, but have been mutilated, interpolated, or altered, then it can form no safe standard; for, in appealing to it, one cannot be sure that the appeal is not made to what is spurious, and what, consequently, may be erroneous. If it require or admit of supplementary revelations from God, whether preserved by tradition or communicated from time to time to the Church, it obviously would be a mere contradiction in terms to call it complete, as a standard of the divine will. And if any other books were extant, having an equal claim, with the books of which it is composed, to be regarded as of divine authority, it would be absurd to call it the sole standard of truth, for in this case the one class of books would be quite as deserving of our reverence as the other.

3. Respecting the evidence by which the Canon is thus to be established, there exists considerable difference of opinion among Christians. Some contend, with the Romanists, that the authoritative decision of the Church is alone competent to determine the Canon; others appeal to the concurrent testimony of the Jewish and early Christian writers; and others rest their strongest reliance on the internal evidence furnished by the books of Scripture themselves. We cannot say that we are satisfied with any of these sources of evidence exclusively. As Michaelis remarks, the first is one to which no consistent Protestant can appeal, for the matter to be determined is of such a kind that, unless we grant the Church to be infallible, it is quite possible that she may, at any given period of her existence, determine erroneously; and one sees not why the question may not be as successfully investigated by a private individual as by a Church. The concurrent testimony of the ancient witnesses is invaluable as far as it goes; but it may be doubted if it be sufficient of itself to settle this question, for the question is not entirely one of facts, and testimony is good proof only for facts. As for the internal evidence, one needs only to look at the havoc which Semler and his school have made of the Canon, to be satisfied that where dogmatical considerations are allowed to determine exclusively such questions, each man will extend or curtail the Canon so as to adjust it to his own preconceived notions. As the question is one partly of fact and partly of opinion, the appropriate grounds of decision will be best secured by a combination of authentic testimony with the evidence supplied by the books themselves. We want to know that these books were really written by the persons whose names they bear; we want to be satisfied that these persons were commonly reputed and held by their contemporaries to be assisted by the Divine Spirit in what they wrote; and we want to be sure that care was taken by those to whom their writings were first addressed, that these should be preserved entire and uncorrupt. For all this we must appeal to the testimony of competent witnesses as the only suitable evidence for such matters. But, after we have ascertained these points affirmatively, we still require to be satisfied that the books themselves contain nothing obviously incompatible with the ascription to their authors of the divine assistance, but,

on the contrary, are in all respects favorable to this supposition. We want to see that they are in harmony with each other; that the statements they contain are credible; that the doctrines they teach are not foolish, immoral, or self-contradictory; that their authors really assumed to be under the divine direction in what they wrote, and afforded competent proof of this to those around them; and that all the circumstances of the case, such as the style of the writers, the allusions made by them to places and events, etc., are in keeping with the conclusion to which the external evidence has already led. In this way we advance to a complete moral proof of the divine authority and canonical claims of the sacred writings. See EVIDENCES.

(1.) The external evidence of the several books, in turn, relates to three principal points: (a.) Their genuineness; in other words, the fact that we have the actual works which have heretofore been known by these names, without essential defect, corruption, or interpolation. This is the province of criticism (q. v.) to show, as has been done by an irrefragable chain of documentary testimony. (b.) Their authenticity (q. v.), or that they are the production of the respective authors asserted or believed, which is a question wholly of historical investigation, aided by grammatical comparison; and this has been shown respecting the most of them in as positive a manner as in the case of any other equally ancient writings. (c.) Their inspiration (q. v.); the most essential point of the three is this relation, an element which, although confessedly obscure and difficult to adjust in every respect with their human features, especially in the absence of any similar experience in modern times, is yet capable of twofold proof: 1st, from statements and implication of revelation contained in the books themselves, showing that they are a divine communication; and, 2dly, from the concurrent voice of the ancient as well as modern body of believers. This last argument is undoubtedly the chief one, of an external character, that must be relied upon in defence of the authority of the Holy Scriptures, and it may well be claimed as a sufficient satisfaction to all rightly constituted minds, [1] that these books, both singly and as a whole, were so generally and early recognised as of divine authority by those who had the best opportunity to judge of their claims, by reason of proximity in time and place to their origin and intimacy with their authors, while, at the same time, they exhibited their caution and freedom from prejudice by rejecting many other more pretentious ones as unworthy their acceptance; and [2] that the universal Church, with few and unimportant exceptions, has ever since not only cordially acquiesced, but firmly retained, in the face of almost every conceivable effort that the ingenuity or force of those of an opposite opinion could bring to bear upon the question, the same traditional persuasion; nor [3] has any really unanswerable difficulty yet been alleged in the way of such a belief.

(2.) With the external evidence furnished above in favor of the sacred Canon, the internal fully accords. In the Old Testament all is in keeping with the assumption that its books were written by Jews, sustaining the character, surrounded by the circumstances, and living at the time ascribed to their authors; or, if any apparent discrepancies have been found in any of them, they are of such a kind as farther inquiry has served to explain and reconcile. The literary peculiarities of the New Testament, its language, its idioms, its style, its allusions, all are accordant with the hypothesis that its authors were exactly what they profess to have been—Jews converted to Christianity, and living at the commencement of the Christian era. Of both Testaments the theological and ethical systems are in harmony, while all that they contain tends to one grand result—the manifestation of the power and perfection of Deity, and the restoration of

man to the image, service, and love of his Creator. The conclusion from the whole facts of the case can be none other than that the Bible is entitled to that implicit and undivided reverence which it demands as the only divinely appointed Canon of religious truth and duty.

VI. *Literature.*—For the later period of the history of the N.-T. Canon, from the close of the second century, the great work of Lardner (*Credibility of the Gospel History*, in his *Works*, i-vi, ed. Kippis, 1788; also 1838, 10 vols. 8vo) furnishes copious materials. For the earlier period his criticism is necessarily imperfect, and requires to be combined with the results of later inquiries. Kirchoffer's collection of the original passages which bear on the history of the Canon (*Quellenammlung*, etc., Zürich, 1844) is useful and fairly complete, but frequently inaccurate. The writings of F. C. Baur and his followers often contain very valuable hints as to the characteristics of the several books in relation to later teaching, however perverse their conclusions may be. In opposition to them Thiersch has vindicated, perhaps with an excess of zeal, but yet, in the main, rightly, the position of the apostolic writings in relation to the first age (*Versuch zur Herstellung*, etc., Erlangen, 1845; and *Erwiderung*, etc., Erlang. 1846). The section of Reuss on the subject (*Die Gesch. d. heil. Schriften N. T.*, 2d ed. Braunsch. 1858; also in French, *Histoire du Canon*, Strasbourg, 1863, 8vo), and the article of Landerer (*Herzog's Encyclop.* s. v.), contain valuable summaries of the evidence. Other references and a fuller discussion of the chief points are given by Westcott in *The History of the Canon of the N. T.* (Camb. 1855). In addition to the works named throughout this article, the following may also be consulted: Cosin, *Scholastical History of the Canon* (4to, London, 1657, 1672, 1683; also *Works*, iii; iv, 410); Du Pin, *History of the Canon and Writers of the Books of the Old and New Test.* (2 vols. folio, London, 1699, 1700); Ens, *Bibliotheca Sacra, sive Diatribe de Librorum Nov. Test. Canonis* (12mo, Amstel. 1710); Storch, *Comment. Hist. Crit. de Lib. Nov. Test. Canonis* (8vo, Fr. ad Vi. 1755); Schmid, *Hist. Antiq. et Vindicatio Canonis V. et N. Test.* (8vo, Lips. 1775); Jones, *New and full Method of settling the Canonical Authority of the New Test.* (8 vols. Ox. 1827); Alexander, *Canon of the Old and New Test. ascertained* (12mo, Princeton, 1826; Lond. 1828, 1831); Stuart, *Old-Test. Canon* (12mo, Andover, 1845; Edinb. and Lond. 1849); Wordsworth, *Hulsean Lectures* (8vo, London, 1848); Gausson, *Le Canon des Saintes écritures au double point de vue de la science et de la foi* (Lausanne, 1860, 2 vols.; Engl. translation, *The Canon of Scripture*, etc. [London, 1862, 8vo]); *Bibliotheca Sacra*, xi, 278; Credner, *Gesch. d. neutest. Canon* (edit. Volkmar, Berlin, 1860); Hilgenfeld, *Kan. der N. T.* (Halle, 1863); Hofmann, *Die heilige Schrift. N. T.*, etc. (Nördlingen, 1862, pt. i). See BIBLE.

CANON, ECCLESIASTICAL (κανών, *rule*, see the foregoing article, § 1), a term used in various senses, as follows:

CANON, a clerical title.

1. The roll or church register in which, in the ancient Church, the names of the clergy were written was called the *canon*; and the clergy were hence called *canonici* (Bingham, *Orig. Eccl.* bk. i, ch. v, § 10). In Cyril (*Præf. Catech.* n. 8), the presence of the clergy is expressed by the words *κανονικῶν παρουσία*. See also **CANONICE**.

2. *Cathedral Canons.*—Chrodegangus, bishop of Metz, about A.D. 755, gave a common cloister-life law to his clergy, and thus originated the proper *vita canonica*, as attached to a cathedral church. (See **CHAPTER**.) Originally canons were only priests or inferior ecclesiastics who lived in community, residing near the cathedral church to assist the bishop, depending entirely on his will, supported by the reve-

nues of the bishopric, and living in the same house, as his counsellors or domestics. They even inherited his movables till A. D. 817, when this was prohibited by the Council of Aix-la-Chapelle. By degrees these communities of priests, shaking off their dependence, formed separate bodies, of which the bishops were still the head. In the tenth century there were communities of the same kind, established even in cities where there were no bishops: these were called collegiates, as the terms "college" and "congregation" were used indifferently. Under the second race of French kings the canonical life spread over the country, and each cathedral had its *chapter* distinct from the rest of the clergy (Farrar, s. v.). Benedict XIII (1889) endeavored to secure a general adoption of the rule of Augustine by the canons, which gave rise to the distinction between *canons regular* (i. e. those who follow that rule) and *canons secular* (those who do not). See CANONS, REGULAR. As demoralization increased, the canons were filled by younger sons of nobles, without ordination, for the sake of the revenues. The *expectancies* (q. v.) of canons became objects of traffic, as advowsons (q. v.) now are in the English Church. The Reformation abolished most of the chapters and canons in Germany: a few remain at Brandenburg, Merseburg, Naumburg, and Meissen.

In the Church of England, *canons* or *prebendaries* are clergymen who receive a stipend for the performance of divine service in a cathedral or collegiate church. See CHAPTER; DEAN.

CANON OF THE MASS (*canon Missæ*), a part of the mass or communion service of the Church of Rome. The office of the mass is divided into three parts: (1) from the introit to the preface; (2) which contains the *canon*, from the *Sanctus* to the time of communion; and (3) the thanksgiving. The second is considered the *essential* part, being that which contains the consecration of the elements. The Greeks call it *ἀναφορά*, probably because of the exhortation of the priest at the commencement to the people, *sursum corda*. In the Roman liturgy the canon begins at the words *Te igitur*, etc. In the Roman Church the form of the canon remains the same at every mass. It is sometimes, by ancient writers, called the *actio*. It is also known by the name *secretæ*, or *secretum*, because the priest is ordered to say it in a low voice; and, according to Goar, the same practice is observed in the East. (See *Conc. Trident. sess. 22, can. 9.*)—Martene, *De ant. Rit.* i, 144; Landon, *Ecl. Dict.* s. v.; Procter *On Common Prayer*, 819. See MASS.

CANON LAW, CANONS OF DISCIPLINE, CANONS AND DECREETS OF ROME. The canons or rules of discipline of the Romish Church form a body of law which has been accumulating for centuries. They are made up of the so-called Apostolical Canons, of decrees of councils, and of decrees and rules promulgated by the popes. The different collections of these are, 1. For the early ages, the so-called "Apostolical Canons," the Greek "Collections" in the *Codex Canonum*; 2. For the Middle Age, up to Gratian's time, a number of collections; 3. From the twelfth century onward, the decretals of Gratian, of Gregory IX, and Boniface VIII, the Clementines, the Extravagants, and the *Corpus Juris Canonici*.

I. *Early Ages*.—(I.) CANONS APOSTOLICAL, a collection of canons (in number seventy-six or eighty-five, according to the different methods of division), not to be attributed, as the name implies, to the apostles. Beveridge, in his *Codex Can. Ecl. Prim.*, seeks to show that these canons are the synodal rules and regulations made in councils anterior to the Council of Nicæa, in which view Petrus de Marca, Dupin, and others agree. Daillé (*De Pseudepigraphiæ Apostolicæ*) considers them the work of the fifth century. That they are not of apostolical origin is very clear from the use in them of terms and mention of ceremonies quite unknown in the apostolic age, as well as from

the fact that they were never even cited under the name of apostolical before the Council of Ephesus, if, indeed, we ought not, as some think, to read in the acts of that council, instead of "the canons of the apostles," "the canons of the fathers." Previously to this synod they are cited as *Canones Patrum, Canones antiqui* or *ecclesiastici*. Bellarmine and Baronius claim apostolical authority for only the first fifty canons. Pope Gelasius (*Distinct. xv, can. Sancta Romana*) plainly declares, *Liber Canonum Apostolorum apocryphus est*; but the authenticity of the passage is doubted. It is the opinion of Beveridge (*Cod. Canonum Eccles. Primitivæ*, Lond. 1678) that the Apost. Canons were enacted in different synods about the close of the second century and beginning of the third; and that the collection was made soon after, but since that time interpolated; and that the compiler of the collection cannot be ascertained. Dr. Schaff sums up the whole case in the following judicious passages: "The contents of the so-called Apostolical Canons are borrowed partly from the Scriptures, especially the Pastoral Epistles, partly from tradition, and partly from the decrees of early councils at Antioch, Neo-Cæsarea, Nice, Laodicea, etc. (but probably not Chæcedon, 451). They are therefore evidently of gradual growth, and were collected either after the middle of the fourth century or not till the latter part of the fifth, by some unknown hand, probably also in Syria. They are designed to furnish a complete system of discipline for the clergy. Of the laity they say scarcely a word. The eighty-fifth and last canon settles the canon of the Scripture, but reckons among the New Testament books two epistles of Clement and the genuine books of the pseudo-Apostolical Constitutions. The Greek Church, at the Trullan Council of 692, adopted the whole collection of eighty-five canons as authentic and binding, and John of Damascus even placed it on a parallel with the epistles of the apostle Paul, thus showing that he had no sense of the infinite superiority of the inspired writings. The Latin Church rejected it at first, but subsequently decided for the smaller collection of fifty canons, which Dionysius Exiguus, about the year 500, translated from a Greek manuscript."—Schaff, *Church History*, vol. i, § 114.

Although these canons have special reference to discipline, they are not entirely silent on the subject of dogmas, morals, and the ceremonial of worship. They clearly distinguish between the orders of bishop and priest, affirm the superiority of the former, speak of an altar and a sacrifice in the Church of Christ, and prescribe matters to be observed in the administration of baptism, the eucharist, penance, ordination, with many other things evincing a late date. They may be found in Labbel *Concilia*, vol. i, and in Cotelerii *Patr. Opera*, i, 199; also in Uitzén, *Constitutiones Apostolicæ* (Rostock, 1858, 8vo); in English, in Chase, *Constitutions and Canons of the Apostles* (New York, 1848, 8vo), and in Hammond, *Canons of the Church* (N. Y. 1844, p. 188 sq.). See Krabbe, *De Codice Canonum*, etc., translated by Chase, in *Bibliotheca Sacra*, iv, 1; Mosheim, *Commentaries*, cent. i, § 51; Bunsen, *Hypolytus* (Engl. transl. vols. v–vii); and the article CLEMENTINES.

(II.) *Greek Collections*: CODEX CANONUM. 1. The first mention of a *Codex Canonum* is found in the Acts of the Council of Chalcedon (A. D. 451), where a number of canons of previous councils (Nice, Ancyra, Antioch, Laodicea, and Constantinople) were approved. Other collections existed at the time, and others, again, followed, but none were considered as law for the whole Church. The so-called *Codex Canonum Ecclesie Universæ* (Book of the Canons) was first published by Justellus (Paris, 1610, 8vo), reproduced in the *Bibliotheca Juris Canon. Vet.*, op. Voelli et Justelli (Paris, 1661, vol. i), and also in Migne, *Patrol. Cours. Complet.* (Paris, 1848, vol. lxxvii). It is not authentic; the title and arrangement are Juteau's, and the work is only

an unsuccessful attempt of his to make an authentic Greek Codex from the old collections and MSS.

2. In the fifth century we find the *Western Church* recognizing the authority of the Greek canons, and there are three principal collections of them, viz.:

(1) The *Spanish* or *Isidorian* (erroneously so called because found in Isidor of Seville's later collection). It contained the canons of Nice, Ancyra, Neo-Cæsarea, and Gangra. As to its date, we know for certain only this much, that this translation of the Nicene canons was known in Gaul A.D. 489 (*Concil. Regense*, c. 8), and that of the Ancyran canons was quoted in the *Concil. Epauensis*, A.D. 517. A later translation, adding the canons of Antioch, Constantinople, and Chalcedon to those above named, was compiled toward the end of the fifth century. It was first published from an Oxford MS. under the title *Codex Ecclesie Romanæ* (ed. Paschas. Quesnell, in *Opp. Leonis*, Par. 1675, t. ii.)

(2) The so-called *Versio* or *translatio præica*, first published by Justellus in the *Bibliotheca jur. Canon.* i, 276, from an incomplete MS., and afterward, in more complete form, by Ballerini (*Opp. Leonis*, iii, 478).

(3) The translation and collection made by Dionysius Exiguus (q. v.), made probably at Rome toward the end of the fifth century. He afterward (about A.D. 510?) made a second collection, adding a number of papal decretals. These were merged into one, and the codex thus formed was generally accepted throughout the Church. Pope Adrian (A.D. 774) presented an enlarged copy of it to Charlemagne, and it became the basis of the French canon law. In this enlarged form it is designated as the *Adriano-Dionysian Codex*. It may be found in the *Biblioth. Jur. Can.* i, 101, and in Migne's *Patrol. Lat.* (Par. 1848, vol. lxvii).

II. *Middle Age*.—1. In *Africa* the Nicene canons were supplemented by those of native councils, especially of Carthage (q. v.). Fulgentius Ferrandus (q. v.), in 547, composed the *Breviatio Canonum*, adding African decisions up to 427: it was published by Pithou (Paris, 1588), and in Migne, *Patrolog.* (1848, vol. lxvii, p. 949). Cresconius, an African bishop, about 690 issued a *Concordia Canonum* (*Bibl. Jur. Can.* i, App. p. 36). 2. In *Spain* a Codex existed in the sixth century, which was afterward the basis of the pseudo-Isidorian Decretals. In the seventh century it assumed the form in which we know it (*Codex Canonum Eccl. Hisp.* (Madrid, 1806, fol.); and part ii. *Epistola decretales*, etc. *Rom. Pontificum* (Madrid, 1821, fol.)). It contains canons of the Greek, African, French, and Spanish councils and synods, with Papal decrees from Damasus to Gregory I. It does not appear that Isidor of Seville really had any share in preparing the collection which, after the discovery of the fraudulent decretals (see PSEUDO-ISIDORIAN), was known by his name. A new edition of the fraudulent decretals appeared in 1863, viz. *Decretales Pseudo-Isidoriana*, etc., ed. Paulus Hinschius (Leipzig, 2 vols. 8vo).

3. In the *British Islands* and in the *Anglo-Saxon* Church native canons prevailed, of which we have no early records. D'Achery has gathered the fragments of an *Irish* Codex of the eighth century in his *Spicilegium*, i, 491 sq., which contains Greek, African, Gallic, and Spanish canons, as well as native ones. See also Speiman, *Concilia, decreta*, etc. in *re eccl. orbis Britannici* (Lond. 1639-64, 2 vols. fol.).

4. In *France* the Spanish collection came into use in the eighth century, along with the Adriano-Dionysian mentioned above. In the ninth century many of the forged decretals from the pseudo-Isidorian collection were mingled with the authentic canons. The confusion led to several new collections: (1) *Citronum collectio*, in 861 titles, toward the end of the eighth century; (2) *Collectio Acheriana* (perhaps of the beginning of the ninth century); (3) the *Penitentialis* of bishop Haltagur of Cambrai, A.D. 925. Besides these there were numerous small collections, called *Capitula Episcoporum*.

The great increase of the worldly power of the clergy under the Carolingian dynasty necessitated more copious and complete collections of the canons. Among the more important we name (1) the *Collectio Anselmo dedicata* (888-897, 12 vols.), of Italian origin. It includes the pseudo-Isidorian decretals, and also the *Institutes of Justinian*, which for the first time now appear in the canon law collections. (2) Regini's *Libri duo de causis Synodaliibus et discip. eccles.* was compiled about A.D. 906, and includes also some of the false decretals. It is important for its account of the acts of German councils. (3) Burchard's *Liber decretorum collectarium* (1012-1023), in 20 books. To strengthen the authority of certain canons, Burchard ascribes them to too early dates, and his errors, followed by Gratian, have been incorporated into later books. The nineteenth book, treating of penitential discipline, one of whose titles is *Consuetudines superstitiosæ*, throws much light on the state of society in that age. Several editions exist: the latest is in Migne, *Patrolog.* vol. 140 (Paris, 1858). (4) Important *manuscript* collections of the eleventh century are the *Collectio duodecim partium* (after 1023); that of *Anselm of Lucca* (died 1086), in 18 books; two collections of *cardinal Deusdedit*, each in 4 books (1086-1087), in which the valuable archives of the Lateran were employed. (5) To *Ivo of Chartres* (died 1117) two collections are ascribed, viz.: the *Decretum*, in 17 books, and the *Pannormia*, in 8 books, of which the former seems to be a collection of materials for the latter. They are given by Migne, *Patrolog. Lat.* vol. cxxi. There are several other MS. collections of minor importance.

III. *From the Twelfth Century*.—1. *Gratian's*. The want of a collection containing all canons and decretals of general interest, omitting merely local ones, and having a good arrangement, began to be universal about the twelfth century. GRATIAN, a monk of the convent of St. Felix, in Bologna, undertook to supply it. His work is now known as the *Decretum Gratiani*. It was compiled from all preceding books and many MSS. It is divided into three parts. The first part is subdivided into 101 *Distinctiones*, and each of these into canons. Of the *distinctiones*, 81 relate to the clergy, and this part of the book is called by Gratian himself *Tractatus ordinandorum*. Part II contains 86 *causæ*, or points of law, subdivided into *questiones*, each of which is answered by *canones*. Part III, *De consecratione*, contains the sacraments, in five *Distinctiones*. In this work Gratian not only made a collection of the different canons in a certain order, but presented all the canons treating upon one subject under that head. The *decretum*, with all its shortcomings—for it was not yet a complete work—soon superseded all other collections. But what mostly helped to gain for this *decretum* its position is, that Gratian's comments and elucidations resulted in the formation of a new school of canonists and decretalists at Bologna. This made the *decretum* known to all the churches, and brought it into such high esteem that the popes themselves quoted it, though it was not received by them as an official codex.

2. *Other Collections before Gregory IX.*—The papal decretals after the twelfth century became so abundant on points of discipline that the collection of Gratian, however complete at first, soon ceased to be so, and new collections were made. We mention only the principal ones.

(1) The *Breviarium extravagantium* of Bernardus of Pavia († bishop of Pavia 1218), compiled in 1190, and containing newer decretals not in Gratian's *Decretum*, and therefore called *extra decretum vagantes*, for which he made use of several minor collections posterior to Gratian, e. g. the *Appendix Concilii Lateranensis*, etc. His divisions under the titles *Index*, *Indicium*, *Clerus*, *Comnubia* (Sponsalia), and *Crimen* were adopted in subsequent collections. The *Summa* of this work, written by Bernardus himself, was approved

of by the Bologna school. As this was the first collection of *Extravagantes*, it is known as *Volumen primum*, or *Compilatio prima*.

(2.) The compilation of *Petrus Colliacinus*, made by order of Innocent III, containing the decretals of Innocent during the first eleven years of his reign (1198-1210). It was approved by the Bologna canonists, and known as *Compilatio tertia*. The decretals of the popes, from Alexander III (1181) to Celestin III (1198), were compiled by Gilbertus and Alanus, two Englishmen, but were not received at Bologna until they were revised and completed by Johannes Gallensis, which was admitted and known as *Compilatio secunda*.

(3.) The *Compilatio quarta* was made after the fourth Lateran Council (1215), and contains the decretals of Innocent after 1210. These four compilations are given by Labbé, *Antiquæ collectiones decretalium cum Ant. August. et I. Cujacii not. et emend.* (Paris, 1609-1621).

3. *Decretal of Gregory IX.*—In 1280 Gregory IX directed his chaplain, Raymond of Pennaforte, to make a new collection of decretals, suppressing many superfluous parts of the old collections, and arranging the whole systematically. This *Decretalium Gregorii IX compilatio* was in 1284 sent by the pope to the University of Bologna, with the bull *Volentes igitur*, superseding the older compilations, although two of them had been published by popes. The new collection was introduced into university instruction as well as general practical use. Appendices and supplements were added by Innocent IV (1245), Alexander IV, Urban IV, Clement IV, and Gregory X.

4. *Decretal of Boniface VIII.*—In 1298 a new collection, including the post-Gregorian decretals, was published by Pope Boniface VIII under the title *Liber sextus*, because it was a completion of the five books of Gregory. After the publication of the *Liber sextus* Boniface issued a series of decretals (among which we find the celebrated *Unam sanctam* against Philip of France in 1302), as did also his successor, Benedict XI. These were united under the style of *Constitutiones extravaganantium libri sexti*, with comments by cardinal Johannes Monachus.

5. *The Clementines.*—In 1318 Pope Clement V published *Liber septimus*, which included constitutions of the General Synod of Vienna (1311) and his own decretals, in five books, and sent it to the University of Orleans. Here he seems to have stopped its circulation, intending to replace it by a new collection, which was completed under his successor, John XXII, who sent it to the Universities of Paris and Bologna. It became a full authority in the Church, under the name *Clementines* (*Constitutiones Clementine*). With the Clementines the code of canon law, as such, may be said to have been completed, as "the power of the popes has not since been sufficient to give the force of law to their enactments throughout Christendom." Later laws have been added from papal decretals, decisions of Trent, etc., but they have never obtained legal authority.

6. *Corpus Juris Canonici.*—The *Decretum Gratiani*, Gregorian collection, *Liber sextus*, and *Constitutiones Clementine*, were afterward, however, collected under the joint appellation of *CORPUS JURIS CANONICI*. The Paris edition, edited by Chappuis (1499-1502), divides the *Extravagantes* into two parts; first, *Extravagantes Joannis P. XXII*, contains 20 decretals of John XXII, under 14 titles, arranged in the usual system; the second, or *Extravagantes communes*, embraces 74 decretals, from Urban IV (1261-1264) to Sixtus IV (1471-1484). There have been many editions of the *Corpus Juris Canonici*; among them may be named that of Lancelotti (Cologne, 1783, 2 vols. 4to); of Boehmer and Richter (Lips. 1839, 2 vols. 4to). The Paris edition of 1687 (2 vols. 4to) is much esteemed.

Petrus Matthews, of Lyon, compiled in 1590 a *Liber*

septimus decretalium, in 5 vols., containing decretals from Sixtus IV to Sixtus V (1585-1590), and forming a sort of supplement to the *Extravagantes communes*; but the work was not sanctioned. Gregory XIII gave orders for the compilation of an authentic *Liber septimus*, which was completed under Clement VIII (1598). It contains the dogmatic decisions of the Synods of Florence and Trent, but was soon after withdrawn. No attempts have since been made to collect the decretals of the succeeding popes.

Prevalence of the Canon Law in Modern Times.—"The canon law, borrowing from the Roman civil law many of its principles and rules of proceeding, has at different times undergone careful revision and the most learned and scientific treatment at the hands of its professors, and was very generally received in those Christian states which acknowledge the supremacy of the pope; and it still gives ecclesiastical law, more or less, to Roman Catholic Christendom, although its provisions have in many countries been considerably modified by the *Concordats* (q. v) which the popes now and then find it expedient to enter into with Roman Catholic sovereigns and governments, whose municipal system does not admit of the application of the canon law in its integrity. Indeed, the fact of its main object being to establish the supremacy of the ecclesiastical authority over the temporal power is sufficient to explain why, in modern times, it is found to conflict with the views of public law and government, even in the case of the most absolute and despotic governments."

In the Protestant Church of Germany the canon law is still the basis of the common Church law. Luther burned the *Corpus Juris* at Wittenberg (Dec. 20, 1520); but, nevertheless, the canon law was afterward taught in the universities, and its rules as to benefices, marriage, etc., became the basis of ecclesiastical law in the German Protestant Church (Herzog, *Real-Encyclopædie*, s. v.). Calvin calls the legislation of the Roman Church "an overgrown and barbarous empire;" and maintains that Church laws bind the conscience only as they are Christ's laws (*Institutes*, bk. iv, ch. 10).

In England, the canon law, even in Roman Catholic times, never obtained so firm a footing as on the Continent. Hook (*Church Dictionary*, s. v. Canon) says that "as to the Church of England, even at that time, when the papal authority was at the highest, none of these foreign canons, or any new canons, made at any national or provincial synod here, had any manner of force if they were against the prerogative of the king or the laws of the land. It is true that every Christian nation in communion with the pope sent some bishops, abbots, or priors to those foreign councils, and generally four were sent out of England; and it was by those means, together with the allowance of the civil power, that some canons made there were received here, but such as were against the laws were totally rejected. Nevertheless, some of these foreign canons were received in England, and obtained the force of laws by the general approbation of the king and people (though it may be difficult to know what these canons are); and it was upon this pretence that the pope claimed an ecclesiastical jurisdiction, independent of the king, and sent his legates to England with commissions to determine causes according to those canons, which were now compiled into several volumes, and called *jus canonicum*: these were not only enjoined to be obeyed as laws, but publicly to be read and expounded in all schools and universities as the civil law was read and expounded there, under pain of excommunication to those who neglected. Hence arose quarrels between kings and several archbishops and other prelates who adhered to those papal usurpations. There was, however, a kind of national canon law in England, composed of *legative* and *provincial* constitutions, adapted to the particular necessities

of the English Church. The legative constitutions were ecclesiastical laws enacted in national synods, held under the cardinals Otho and Othobon, legates from Pope Gregory IX and Pope Clement IV, in the reign of king Henry III, about the years 1220 and 1268. The provincial constitutions are principally the decrees of provincial synods, held under divers archbishops of Canterbury, from Stephen Langton, in the reign of Henry III, to Henry Chicheley, in the reign of Henry V, and adopted also by the province of York in the reign of Henry VI. At the dawn of the Reformation, in the reign of Henry VIII, it was enacted in Parliament that a review should be had of the canon law; and till such review should be made, all canons, constitutions, ordinances, and synodals provincial being then already made, and not repugnant to the law of the land or the king's prerogative, should still be used and executed. And as no such review has yet been perfected, upon this enactment now depends the authority of the canon law in England, the limitations of which appear, upon the whole, to be as follows: that no canon contrary to the common or statute law, or the prerogative royal, is of any valdkity; that, subject to this condition, the canons made anterior to the parliamentary provision above mentioned, and adopted in our system (for there are some which have had no reception among us), are binding both on clergy and laity; but that canons made since that period, and having no sanction from the Parliament, are, as regards the laity at least, of no force." See CANONS OF THE CHURCH OF ENGLAND.

Before the Reformation, degrees were as frequent in the canon law as in the civil law. Many persons became graduates in both, or *juris utriusque doctores*; and this degree is still common in foreign universities. But Henry VIII, in the twenty-seventh year of his reign, issued a mandate to the University of Cambridge to the effect that no lectures on canon law should be read, and no degree whatever in that faculty conferred in the university for the future. It is probable that Oxford received a similar prohibition about the same time, as degrees in canon law have ever since been discontinued in England (*Penny Cyclopædia*, vi, 244).

In Scotland, Presbyterian though the ecclesiastical system of that country be, the old Roman canon law still prevails to a certain extent. "So deep hath this canon law been rooted," observes Lord Stair, in his *Institutes of the Scotch Law*, "that even where the pope's authority is rejected, yet consideration must be had to these laws, not only as those by which Church benefices have been erected and ordered, but as likewise containing many equitable and profitable laws, which, because of their weighty matter, and their being once received, may more fitly be retained than rejected." In two old Scotch acts of Parliament, made in 1540 and 1551, the canon law is used in conjunction with the Roman law to denote the common law of the country, the expression used being "the common law, both canon, civil, and statutes of the realms" (*Chambers's Encyclopædia*, s. v.).

In the United States the Roman Catholic Church is ruled by the Roman canon law, and also by the decrees of national and provincial councils, and by the regulations set forth by the bishops, subject to the revision of Rome.

See, on the subject of this article generally, the following authorities; Herzog, *Real-Encyclopædie*, vii, 308 sq.; Blackstone, *Commentaries*, i, 88; Knight, *Political Dictionary*, s. v.; Denoux, *Theol. Scolastique*, ii, 204 sq.; Cunningham, *Historical Theology*, vol. ii, ch. xv; Hagenbach, *Theol. Encyclopædie*, § 112; Walter, *Fontes juris Ecclesiastici* (Bonn, 1862); Boehmer, *Institut. Juris Canonici* (Hal. 1770, 5th ed.).

CANONS OF THE CHURCH OF ENGLAND. The authority of the English canons rests upon "the statute 25 Henry VIII, commonly called the act of

submission of the clergy, by which they acknowledged that the convocation had been always assembled by the king's writ; and they promised, *in verbo sacerdotis*, not to attempt, claim, or put in use, or enact, promulge, or execute any new canons in convocation without the king's assent or license. Then follows this enacting clause, viz.: That they shall not attempt, allege, or claim, or put in use any constitutions or canons without the king's assent." The first book of English canons was published in Latin in 1571, archbishop Parker and the bishops of Ely and Winchester being the principal agents in its construction, though "all the bishops in both provinces in synod, in their own persons or by proxy, signed it." These canons underwent various modifications, until, in 1604, bishop Bancroft collected a hundred and forty-one canons out of the articles, injunctions, and synodical acts passed and published in the reigns of Edward VI and Elizabeth, which were adopted by the Convocation of that year. These canons, which at first appeared in Latin, we have in English, under the title of "Constitutions and Canons Ecclesiastical." The code of canons was amplified in 1606, and finally completed by the addition of seventeen more in 1640. They do not constitute the law of the land, because they were not made pursuant to the statute 25 Henry VIII, since they were made in a convocation, sitting by the king's writ to the archbishops, after the Parliament was dissolved. After the Restoration, when an act was passed to restore the bishops to their ordinary jurisdiction, a proviso was made that the act should not confirm the canons of 1640. This clause makes void the royal confirmation. Hence we may conclude that canons should be made in a convocation, the Parliament sitting; that, being so made, they are to be confirmed by the sovereign; and that without such confirmation they do not bind the laity, much less any order or rule made by a bishop alone, where there is neither custom nor canon for it. See Burn, *Ecclesiastical Law*, App. to vol. iv. The canons are also given by Hammond, *The Definitions of Faith and Canons of Discipline*, etc. (New York, 1844, 12mo). See Cardwell, *Synodalia* (Oxford, 1842, 2 vols. 8vo); Hall, *Inquiry on the Canons and Articles* (London); Eden, *Church Dictionary*, s. v.; Hook, *Church Dictionary*, s. v. See ENGLAND, CHURCH OR.

CANONS OF THE PROTESTANT EPISCOPAL CHURCH (of America), the law or discipline of that Church. The canons are of two kinds: (1.) "The constitution and canons of the General Convention, forming a code for the uniform government of every diocese and every church;" (2.) "The constitutions and canons of the several dioceses, of force only within their several precincts, and generally subordinate to the power of the General Convention." The canons are liable to be repealed or altered by the successive Conventions. They are given by Hammond, *Definitions of Faith and Canons of Discipline* (N. York, 1844, p. 283 sq.). There is also a *Digest of the Canons* by Dr. Hawks and Judge Hoffman (N. Y. 1860); see also Hoffman, *Treatise on the Law of the Protestant Episcopal Church* (N. York, 1850); *Digest of the Canons for the Government of the Protestant Episcopal Church*, adopted in the General Conventions of 1859, 1862, and 1865 (Boston, 1866, 8vo). See PROTESTANT EPISCOPAL CHURCH.

CANONS REGULAR, a class of monastic orders in the Roman Catholic Church. The class comprises those canons (q. v.) who not only live in common, and under the same rule, but also bind themselves by either simple or solemn vows, and who therefore really constitute what is called in the Roman Church a "religious" order (see ORDER, RELIGIOUS). The "canons" owe their origin to Chrodegang (q. v.), who established them on a monastic basis; but after the tenth century the common life began to cease among a large portion of them. In the eleventh and twelfth centuries many

attempts were made to restore their monastic character, and a number of congregations were founded. The most important among them were the Premonstratenses (q. v.), the congregation of St. Geneveva (q. v.), St. Rufus (q. v.), and of St. Victor (q. v.) in France, the Gilbertine canons (q. v.) in England, and the canons of the Holy Cross, or sometimes also called



Canon Regular of England.

canons of the Holy Sepulchre, at Jerusalem. All the congregations followed either the rule of St. Augustine, or composed their rule out of those of Augustine and Benedict. They were very numerous in England, where they were introduced about 1105, and where they had, at the time of their dissolution, 175 houses (including those of the canoneses). Their habit was a long black cassock, with a white rochet over it, and over that a black cloak and hood. In 1519 cardinal Wolsey undertook the reformation of all the congregations of regular

canons existing in England, in virtue of a bull of Leo X. He ordered them to hold general chapters every third year, and to restore a rigid discipline. A few years after they were suppressed, together with all other English monasteries. In Ireland the regular canons were so numerous that they counted as many houses as all other orders together. One of the most celebrated reformers of the order in France was bishop Ivo of Chartres († 1115); yet he did not found an independent congregation. The *Congregation of St. Lawrence*, near Oulx, in the Dauphiné, which was founded in 1050 by Gerard Charbrerius, spread especially in Savoy and south-eastern France. At the end of the eighteenth century they had nearly disappeared. The superior of the monastery of St. Lawrence, which still existed, bore the title of provost, possessed episcopal jurisdiction in his provostry, and was only dependent on the pope. The *Congregation of Marbach*, in Alsace, was established about 1100 by Manegold de Lutembach, and is said by some writers to have had, at one time, about 800 monasteries. Very numerous was the *Congregation of Arouaise*, established about the same time by three hermits, one of whom was made a cardinal. It spread over England, Scotland, Flanders, and Poland. A reformed congregation of the *Regular Canons of Lorraine* (called the "Congregation of our Saviour") was established by Pierre Fourier in 1624, but many of the other congregations refused to recognize it. The most celebrated and numerous of the congregations in Italy, next to that of Lateran (see *LATERAN*), was the *Congregation of our Saviour (of Bologna)*, founded by Stephen Cioni in 1408, which possessed, in the eighteenth century, three monasteries in the city of Rome. Few orders of the Roman Church have been oftener and more generally pervaded by gross abuses and corruptions than the regular canons. The greater number of the French congregations were extinguished by the French Revolution. A new congregation of regular canons "of the Sacred Heart" (generally called, after the street in Paris in which they had their first house, the *Congregation of Picpus*) was founded in 1823 by abbé Coudrin (see *PICPUS*, *Congregation of*). See Helyot, *Ordres Religieux*, i, 761 sq.; Fehr, *Geschichte der Mönchsorden*, i, 55 sq.; ii, 27 and 408.

Canoneses (*Canonissæ*), a class of female orders the Roman Church, organized after the model of the

regular canons (q. v.), observing the rule of St. Augustine, and living in common. They are first found in the seventh century. They took no solemn vows, but were to remain unmarried, were generally governed by an abbeas, and were under the spiritual direction of the canons. These female societies, like the canons (q. v.), fell into irregularities; gave up the common life, and their property fell mostly into the hands of the nobility, who provided for some of their daughters by canonical livings. Reformed congregations were frequently instituted, sometimes following the reformed congregations of the canons, sometimes being independent of them. Reformatory movements were particularly extensive at the close of the twelfth century, when the Beghards (q. v.) and Beguines (q. v.) made their appearance in many towns of the Netherlands. Those who did not bind themselves by a monastic rule were called secular canoneses (*Canonissæ seculares*, or also *Domicellæ*), and they were almost exclusively found in the institutions of noble ladies. Many of them married and then resigned their benefices. The Reformation in Germany did not abolish the houses of the canoneses, but changed most of them into asylums for the unmarried daughters of the Protestant nobility. Celebrated houses ("stifter") of this class were at Gandersheim, Herford, Quedlinburg, Gernrode, etc., and after their model even new Protestant houses were founded at Halle, Altenburg, Frankfurt, and in other places, especially in Mecklenburg and Westphalia. See Helyot, *Ordres Religieux* (Paris, 1847), i, 789.

Canonissæ, virgins who devoted themselves to the celibate before the monastic life was known, and therefore before there were monasteries to receive them; and called *canonice* (canonical virgins), because their names were enrolled in the canon or *matricula* of the Church, that is, in the catalogue of ecclesiastics. They differed from the monastic virgins in this, that they lived privately in their fathers' houses, and had their maintenance from them, or, in case of necessity, from the Church; but the others lived in communities, and upon their own labor; so that it is now out of dispute, says Bingham, that, as the ascetics for the first three hundred years were not monks, so neither were the sacred virgins of the Church nuns confined to a cloister, as in after ages.—Bingham, *Orig. Eccl. bk. vii, ch. iv, § 1*.

Canonical hours, certain stated hours of the day assigned to prayer and devotion. Such are Nocturna, Matins, Lauds, Nones, Vespers, and Complini. It is not known at what period these hours were settled in the early Church. The Apostolical Constitutions direct prayers to be said at dawn, and at the third, sixth, and ninth hours, as well as at evening. In England the canonical hours are from eight to twelve in the forenoon, before or after which marriage cannot lawfully be performed in any church.—Bingham, *Orig. Eccles. bk. xiii, ch. ix, § 8*; Procter *On Common Prayer*, p. 10. See *BREVIARY*.

Canonical obedience is that submission which, by the ecclesiastical laws, inferior clergy are to pay to their bishops, and members of religious orders to their superiors.

Canonist, a professor of, or a writer upon, the Canon Law (q. v.).

Canonization, in the Roman and Greek churches, the act and ceremony of proclaiming a deceased person who has previously been *beatified* (see *BEATIFICATION*) a saint, and enrolling such a one in the catalogue of saints to be honored. In the *Roman* Church this is done by the pope only, who, after examination, "declares the person in question to have led a perfect life, and that God hath worked miracles at his intercession, either during his life or after his death, and that, consequently, he is worthy to be honored as a saint, which implies permission to exhibit his relics, to

invoke him, and to celebrate mass and an office in his honor." In the Greek Church the ceremony of canonization takes place only in the presence of the patriarch, who, having assembled his bishops for this purpose in synod, causes the testimonies of the witnesses in favor of the person to be canonized to be examined. A thousand witnesses are required. The trouble and expense incident to this process are so great that canonizations in the East are few.

Anciently the reverence due to "saints" was thought to be fulfilled by putting the name of the saint on the Sacred Diptychs, or *Album Sanctorum*, or erecting oratories or churches under the invocation of the saint. "Canonization in the Roman sense was not known before the tenth century, but some hold that the first canonization was celebrated by Leo III, A. D. 804; and, from the close correspondence of its ceremonies with those which were performed at the apotheosis or deification of the ancient Romans, it is with great probability supposed to derive its origin thence. In consequence of the multiplication of saints during the Dark Ages, the canonizing of any deceased Christians was prohibited by a solemn ordinance in the ninth century, unless it were done with the consent of the bishop. This edict occasioned a new accession of power to the Roman pontiff, as it ultimately vested in him the exclusive right of canonizing whomsoever he pleased. John XV was the first pope who exercised this assumed right, and who, in the year 995, with great formality, enrolled Udalric, bishop of Augsburg, among the number of the saints. Before a beatified person can be canonized four consistories are held. In the first the pope causes the petition of the parties requesting the canonization to be examined by three auditors of the rota, and directs the cardinals to revise all the necessary instruments; in the second the cardinals report the matter to the Roman pontiff; in the third, which is a public consistory, the cardinals pay their adoration to the pope. One person, called the devil's advocate, says all he can against the person to be canonized, raises doubts on the genuineness of the miracles said to be wrought by him, and exposes any want of formality in the procedure. It is said that the ingenuity and eloquence of the devil's advocate nearly prevented the canonization of cardinal Borromeo in the seventeenth century. But another advocate makes a pompous oration in praise of the person who is to be created a saint, in which he largely expatiates on the miracles said to have been wrought by him, and even pretends to know from what motives he acted. In the fourth and last consistory, the pope, having convened all the cardinals, orders the report concerning the deceased to be read, and then proceeds to take their votes, whether he is to be canonized or not. Previously to pronouncing the sentence declaring the beatified party to be a saint, the pope makes a solemn protestation that, by this act of canonization, he does not intend to do anything contrary to faith, or to the Catholic [Romish] Church, or to the honor of God. On the day appointed for the ceremony the church of St. Peter at Rome is hung with tapestry, on which are emblazoned the arms of the pope, and of the sovereign or prince who desires the canonization, and is also brilliantly illuminated. Thousands of devout members of the Romish communion fill that capacious edifice, eager to profit by the intercessions of the new saint with the Almighty. During the ceremony of canonizing, the pope and cardinals are all dressed in white. The expenses, which are very considerable, are defrayed by the royal or princely personage at whose request the beatified person is enrolled among the saints. The coat of canonizing the saints Pedro de Alcantara and Maria Maddalena di Pazzi, under the pontificate of Clement IX, amounted to sixty-four thousand scudi" (or dollars) (Eadie, *Eccles. Dict.* s. v.). No person can be canonized until at least fifty years after death, nor if he be believed to have passed into

purgatory, nor if he be a baptized infant dead before reaching years of discretion, except in cases of martyrdom. The act of *beatification* precedes that of canonization. See BEATIFICATION.

The worship of "canonized saints" is enjoined by the Council of Trent (Sess. xxv, *De invocatione*, etc.). Many Romanists have declared against this superstition; and the Protestant churches reject it as idolatrous. Canonization is a relic of Paganism. In the thirteenth century a Dualist came very near being canonized. In 1269 there died at Ferrara a wealthy citizen, Armanno Pungilovo, whose extraordinary charities endeared him to the poor, while his austere and exemplary life procured him a general reputation of sanctity. He was buried in the cathedral, in the presence of an immense crowd, who lamented their benefactor; and such was the public veneration that miracles were soon wrought, or appeared to be, on the spot where he was buried. An altar was built over his remains, and statues were erected in his honor throughout the churches of the diocese. The bishop and chapter of Ferrara proceeded to an investigation of the miracles wrought at his tomb, as a preliminary step to applying for his canonization, and professed themselves satisfied of the veracity of persons who testified that they had themselves been cured—some of blindness, others of paralysis. What was the general consternation when the Dominican Aldobrandini, inquisitor general of Lombardy, brought forward irresistible evidence that the deceased was a member of the Catharists (q. v.); that his house had been for years the asylum of their teachers; and that he had both received and administered the *consolamentum* (q. v.). The clergy of Ferrara were slowly and unwillingly convinced, the people not at all; but, after repeated investigations, and a delay of more than thirty years, those remains, which had well-nigh been proposed to the adoration of the faithful, were dug up with ignominy and burned to ashes. See Heilmann, *Consecratio Sanctorum*, etc. (Hal. 1754, 4to); Elliott, *Delinication of Romanism*, bk. iv, ch. iv; Hurd, *Religious Rites and Ceremonies*, 244; Ferraris, *Promta Bibliotheca*, s. v. *Veneratio Sanctorum*, ix, 119 sq.; Chemnitz, *Examen Concil. Trident.* pt. ii, loc. 6; pt. iii, loc. 4; Herzog, *Real-Encyclopädie*, vii, 826; Eadie, *Eccles. Dictionary*, s. v.; Hook, *Ch. Dictionary*, s. v.

Canopy (*κωνοπέριον*, from *κωνή*, a *gnat*; Vulg. *conopeum*): (1) In the O. T. the term employed for the hanging of the couch of Holofernes (Judith x, 21; xiii, 9; xvi, 19), where alone it occurs in the Bible, although, perhaps, from the "pillars" of the litter described in Cant. iii, 10, it may be argued that its equipage would include a canopy. It probably retained the mosquito-nets or curtains in which the name originated, although its description (Judith x, 21) betrays luxury and display rather than such simple usefulness. Varro (*R. R.* ii, 10, 8) uses the term (*quæ in conopeis jacent*) of languid women very much as the book of Judith (*ἀναπαυόμενος . . . ἐν τῷ κωνοπέριῳ*) describes the position of a luxurious general. (For farther classical illustration, see Smith, *Dict. of Ant.* s. v. *Conopeum*.) It might possibly be asked why Judith, whose business was to escape without delay, should have taken the trouble to pull down the canopy on the body of Holofernes? Probably it was an instance of the Hebrew notion that blood should be instantly covered (comp. 2 Sam. xx, 12; Levit. xvii, 13) [see BLOOD], and for this purpose the light bedding of Syria was inadequate. See B.D. Tent furniture also is naturally lighter, even when most luxurious, than that of a palace, and thus a woman's hand might unfix it from the pillars without much difficulty.—Smith, s. v.

(2) In ecclesiastical use, see BALDACHIN.

Canstein, KARL HILDEBRAND, Marquis of, was born Aug. 15, 1667, at Lindenburg, in Germany, studied law at Frankfurt on the Oder, travelled much in

Europe, and in 1698 was appointed page of the elector of Brandenburg. He afterward served as a volunteer in the Netherlands. A dangerous sickness obliged him to leave the military service, and led him to a religious life, in which he was greatly helped by Spenser (q. v.). His wish to spread the Bible among the poor led him to form the idea of printing it with stereotype plates. Thus originated the famous institution, called in German *Die Cansteinsche Bibelanstalt*. He lived to see 100,000 Testaments and 40,000 Bibles sold from the establishment. It is still continued on a very large scale; the books are furnished at cost prices (about twenty-five cents for the Bible and eight for the Testament). Up to 1854, 4,612,000 Bibles and 2,680,000 Testaments had been sold. He edited a *Harmonie der 4 Evangelisten* (2d ed. 1727, fol.), and also wrote *Lebensbeschreibung Spensers* (Life of Spenser), the edition of which by Lange, 1740, contains a biography of Canstein, who died at Halle, Aug. 19, 1719. See also Niemeyer, *Geschichte der Cansteinschen Bibelanstalt* (Halle, 1827, 8vo); Plath, *Leben von Canstein* (1861, 8vo); Bertram, *Geschichte der Cansteinschen Bibelanstalt* (1868, 8vo); *Jahrbücher f. Deutsche Theologie*, ix, 892. — Hoefer, *Nouv. Biog. Générale*, viii, 510; Herzog, *Real-Encyclopädie*, ii, 552.

Canterbury (*Canstaria Dorobernum*), the capital of the county of Kent, a cathedral city and the seat of an archbishop, who is the metropolitan of all England. It is 56 miles from London, E. S. E., on the road to Dover. When Augustine became archbishop of this see, A. D. 597, king Ethelbert granted his palace here to the archbishop and his monks, who thereupon began to build a monastery, converting an ancient church in the neighborhood (said to have been used by the Roman Christians) into his cathedral church. Cuthbert, the eleventh archbishop, A. D. 740, added a church to the east of this. In the course of ages it received numerous additions, until it assumed its present magnificent form. Among those who helped to repair, enlarge, and rebuild it were archbishops Odo (A. D. 940), Lanfranc (1070), and Anselm (1098). In 1174 the choir was destroyed by fire, and in order to the rebuilding of it a number of French and English artificers were summoned. Among the former was a certain William of Sens, and to him, a man of real genius, the work was intrusted. The church was rich in relics: Plegmund had brought hither the body of the martyr Blasius from Rome; there were the relics of St. Wilfred, St. Dunstan, and St. Elphege; the murder of Thomas Becket (q. v.) took place in the north transept, Dec. 29, 1170. The total exterior length of the cathedral is 545 feet, by 156 in breadth at the eastern transept. The crypt is of greater extent and loftier—owing to the choir being raised by numerous steps at the east end—than any other in England. The archbishop of Canterbury is primate of all England, metropolitan, and first peer of the realm. He ranks next to royalty, and crowns the sovereign. His ecclesiastical province includes all England, except the six northern counties. Among his privileges, he can confer degrees in divinity, law, and medicine. His seats are at Lambeth and Addington Park. He is patron of 149 livings. The present archbishop is Charles Thomas Longley, translated to the see in 1862.—London, *Ecl. Dictionary*, s. v.; Chambers, *Encyclopædia*, s. v.

Cantharus (a cup or pot). In the atrium of ancient churches there was commonly a fountain or cistern, in which worshippers could wash their hands and faces before entering the church. Eusebius says that in the court over against the church were placed fountains (*κρήναι*) of water, as symbols of purification, for such to wash as entered into the church (*De Orat. c. xi*). Paulinus, bishop of Nola, calls this fountain *cantharus* (*Epist. xii, ad Sever.*). In some places, according to Dufresne, the fountain was surrounded with lions, whose mouths water spouted; whence the place

is also called by some ecclesiastical writers *leontarium*. It is also called *πηγήναιον*, *κολυμβήτριον*, both of which signify a fountain. Tertullian exposes the absurdity of men going to prayers with washed hands while they retained a filthy spirit and polluted soul. Some of the Roman Catholic writers pretend to justify their use of holy water from the existence of this ancient custom. It is, however, more probable that it owes its origin to the Grecian rite called *περιβατήρια*, or *lustral sprinklings*.—Bingham, *Orig. Eccles.* bk. viii, ch. iii, § 6, 7.

Cantharas (*Κανθάρας*), a person mentioned by Josephus (*Ant.* xx, 1, 8) as having been deposed from the Jewish high-priesthood by Herod, king of Chalcis, to make room for Joseph, the son of Canu, A. D. 45; he is elsewhere (*Ant.* xix, 6, 2) identified with the SIMON (q. v.) who had before enjoyed that honor, as the son of (Simon, the son of) Boëthius, father-in-law of Herod the Great (*Ant.* xv, 9, 8). See HIGH-PRIEST.

Canticle (*song*), applied commonly to sacred songs chanted in the Church, such as the *Benedicite*.

Canticles, or Solomon's Song (called in ver. 1 *Shir hash-Shirim*, שִׁיר הַשִּׁירִים, *Song of the Songs*, a Heb. superlative; Sept. *ᾠσμα ᾠμάτων*, Vulg. *Canticum Canticum*), entitled in the A. V. "THE SONG OF SOLOMON." No book of the O. T. has been the subject of more varied criticism, or been more frequently selected for separate translation than this little poem. It is one of the five *megilloth* or rolls placed in most Jewish MSS. of the Scriptures immediately after the Pentateuch, but in the Heb. printed copies it constitutes the fourth of the *Ketubim* or *Hagiographa* (q. v.). (See Davidson in Horne's *Introd.* new ed. ii, 790 sq.) See BIBLE.

I. Author and Date.—By the Hebrew title it is ascribed to Solomon; and so in all the versions, and by the majority of Jewish and Christian writers, ancient and modern. In fact, if we except a few of the Talmudical writers (*Baba Bathra*, R. Moses Kimchi; see Gray's *Key*), who assigned it to the age of Hezekiah, there is scarcely a dissentient voice down to the close of the last century. More recent criticism, however, has called in question this deep-rooted and well-accredited tradition. Among English scholars Kennicott, among German Eichhorn and Rosenmüller, regard the poem as belonging to the age of Ezra and Nehemiah (Kennicott, *Diss.* i, p. 20–22; Eichhorn, *Isagogen in V. T.* pt. iii, § 647, p. 581 sq., 2d ed.; Rosenm. *Schol. in V. T.*) Kennicott based his opinion upon the uniform insertion of the ׀ in all the copies, in the name of David (דָּוִד). The name, however, occurs only once (iv, 4); and the insertion of the letter in this solitary instance is easily accounted for by a supposed error in transcription. At any rate, the insertion of the ׀ would not bring the Canticles so far down as the time of Ezra, since we find the same peculiarity in Hos. iii, 5, and Amos vi, 5 (Gesenius, *Theaur.* s. v.) The charge of Chaldaism has been vigorously pressed by Rosenmüller, and especially by Eichhorn. But Gesenius (*Heb. Gr.* § 2) assigns the book to the golden age of Hebrew literature, and traces "the few solitary Chaldaisms" which occur in the writings of that age to the hands of Chaldee copyists. Gesenius has moreover suggested an important distinction between Chaldaisms and *dialectic* variations indigenous to Northern Palestine, where he conjectures that Judges and Canticles were composed. The application of this principle is sufficient to eliminate most of the Chaldaisms alleged by Eichhorn (e. g. שִׁיר לְדָוִד); while the occurrence of similar forms in Phœnician affords an indication of other intrusive forces besides the Aramean acting upon the Biblical Hebrew. Nor is the suggestion of Gesenius that the book was written in Northern Palestine, and consequently tinged with a local coloring, inconsistent with the opinion which places it among the "one thousand and five" songs of Solomon (1 Kings iv, 82).

Comp. 1 Kings ix, 19 with 2 Chron. viii, 6, where the buildings of Lebanon are decidedly contrasted with those of Jerusalem, and are not, therefore, to be confounded with the "house of the forest of Lebanon" (1 Kings vii, 2), which was probably in Jerusalem. By a farther comparison of these passages with Robinson (*Bibl. Res.* iii, 441), who describes remains of massive buildings as still standing on Lebanon, it will appear probable that Solomon had at least a hunting-seat somewhere on the slopes of that mountain (comp. Cant. iv, 9). In such a retreat, and under the influence of its scenery, and the language of the surrounding peasantry, he may have written Canticles. Artistically this would have been in keeping with the general conditions of pastoral poetry. In our own language such compositions are not unfrequently accommodated to rustic ideas, and sometimes to provincial dialects. If, moreover, it should be urged that Chaldaisms are not provincialisms, it may be replied that Solomon could scarcely be ignorant of the Aramaean literature of his own time, and that he may have consciously used it for the purpose of enrichment (*Gesen. Heb. Gr.* § 2, 4).

The title, though it is possibly too flattering to have come from the hand of Solomon, must have existed in the copy used by the Sept., and consequently can lay claim to a respectable antiquity. The moral argument put forward by the supporters of the most recent literal interpretation, and based upon the improbability of Solomon's criminating himself (see below), is not very conclusive. Even on the theory of those interpreters his conduct might be traced to a spirit of generous self-accusation; and, at any rate, it need not be exalted above the standard which was likely to flourish in the atmosphere of a court such as his. On the whole, then, it seems unnecessary to depart from the plain meaning of the Hebrew title.

Supposing the date fixed to the reign of Solomon, great ingenuity has been employed by the Rabbinical and some Christian writers in determining at what period of that monarch's life the poem was written (see *Poli Synops. Præf. ad Cant.*). The point at issue seems to have been whether Solomon ever repented after his fall. If he did, it was contended that the ripeness of wisdom exhibited in the Song seemed the natural growth of such an experience; if he did not, it was urged that no other than a spiritually-minded man could have composed such a poem, and that therefore it must have been written while Solomon was still the cherished of God. Then, again, it was a mooted point whether the composition was the product of Solomon's matured wisdom, or the fresh outburst of his warm and passionate youth; whether, in fact, the master element of the poem were the *literal* form or the *allegorical* meaning. In either view of its interpretation, however, the only historical occasion in the life of Solomon for a poem like this is his marriage with the daughter of Pharaoh, B.C. 1008 (1 Kings iii, 1); a reference that is strongly corroborated by the probable date of Psalm xiv, which indeed may be regarded as the *key* of the Canticles themselves. An old commentator (*Woken, Wittamb. 1729*) holds that the bride was "Nicaule," the queen of Sheba, and that she formed a connubial intimacy with Solomon during her stay in Palestine. See SOLOMON.

II. *Form.*—This question is not absolutely determined by the Hebrew title. The rendering of שירי רועות, mentioned by Simonis (*Lex. Heb.*), "series of songs" (comp. *συστά, chain*), and adopted by Paulus, God, and other commentators, can scarcely compete with that of Gesenius, "Song of Songs, i. e. the most beautiful of songs" (comp. *Ps. xlv, 1, שירי יודית*, "a delightful song;" comp. also Theocr. *Idyl. viii, προσφαιδὸς μίλος*). The non-continuity which many critics attribute to the poem is far from being a modern discovery (comp. the Lat. "Cantica cantico-

rum," and the Chaldee paraphrase, "the songs and hymns which Solomon, the prophet, the king of Israel, uttered in the spirit of prophecy before the Lord"). Ghislerius (16th century) considered it a drama in five acts. One of the first separate translations published in England is entitled "The Canticles, or Balades of Solomon, in English metre" (1549); and in 1596 appeared Solomon's Song in eight eclogues, by J. M. [Jervase Markham]; the number of eclogues in this latter production being the same as that of the idylls into which the book was afterward divided by Jahn. Down to the 18th century, however, the Canticles were generally regarded as continuous.

Gregory Nazianzus calls it "a bridal dramatic song" (*συμφικὸν δράμα τε καὶ ἄσμα*). According to Patrick, it is a "pastoral eclogue" or a "dramatic poem;" according to Lowth, "an epithalamium, or *δαμωτικός* nuptialis of a pastoral kind." Michaelis and Rosenmüller, while differing as to its interpretation, agree in making it continuous, "carmen amatorium." A modified continuity was suggested by Bossuet, who divided the Song into seven parts, or scenes of a pastoral drama, corresponding with the seven days of the Jewish nuptial ceremony (Lowth, *Prælect. xxx*). Bossuet is followed by Calmet, Percy, Williams, and Lowth; but his division is impugned by Taylor (*Fragm. Calmet*), who proposes one of six days, and considers the drama to be *post-nuptial*, not *ante-nuptial*, as it is explained by Bossuet. (See below.) The entire nuptial theory has been severely handled by J. D. Michaelis, and the literal school of interpreters in general. Michaelis attacks the first day of Bossuet, and involves in its destruction the remaining six (*Not. ad Lowth Præf. xxxi*). It should be observed that Lowth makes it a drama, but only of the *minor* kind, i. e. dramatic as a dialogue, and therefore not more dramatic than an idyll of Theocritus or a satire of Horace. The fact is that he was unable to discover a plot; and it seems clear that if the only dramatic element in Canticles be the dialogue, the rich pastoral character of its scenery and allusions renders the term *drama* less applicable than that of *idyll*. Bossuet, however, extravagantly claims it as a regular drama, with all the proprieties of the classic model; and if with Lowth we recognise a chorus completely sympathetic and assistant, it is difficult to see how we can avoid calling the poem a drama: but in all the translations of the *allegorical* school which are based upon the dramatic idea, the interference of the chorus is so infrequent or so indefinite, the absence of anything like a dramatic progress and development sufficient to enlist the sympathy of a chorus is so evident, that the strongly-marked *idyllic* scenery could not far outweigh the scarcely perceptible elements of dramatic intention. The idyllic theory is confirmed by the use of a similar form among the Arabians, under the name of "Cassides" (Sir W. Jones, *Poes. As. Comment.* iii).

By the reactionary allegorists, of whom Rosenmüller may be considered the representative, the Song of Solomon has either been made absolutely continuous, or has been divided with reference to its spiritual meaning rather than its external form (e. g. Hengstenberg and Prof. Burrows).

The supposition that the Canticles supplied a model to Theocritus seems based on merely verbal coincidences, such as could scarcely fail to occur between two writers of *pastoral* poetry (comp. Cant. i, 9; vi, 10, with Theocr. xviii, 80, 86; Cant. iv, 11, with Theocr. xx, 26, 27; Cant. viii, 6, 7, with Theocr. xxiii, 28-26; see other passages in *Pol. Sym.*; Lowth, *Præf.*; Gray's *Key*). In the essential matters of *form* and of *ethical* teaching the resemblance does not exist.

III. *Meaning.*—The schools of interpretation may be divided into three: the *mystical*, or *typical*; the *allegorical*, and the *literal*.

1. The *mystical* interpretation is properly an offshoot of the *allegorical*, and probably owes its origin to the

necessity which was felt of supplying a *literal* basis for the speculations of the allegorists. This basis is either the marriage of Solomon with Pharaoh's daughter, or his marriage with an Israelitish woman, the Shulamite. The former (taken together with Harmer's variation) was the favorite opinion of the mystical interpreters to the end of the 18th century: the latter has obtained since its introduction by Good (1808). The mystical interpretation makes its first appearance in Origen, who wrote a voluminous commentary upon the Canticles. Its literal basis, minus the mystical application, is condemned by Theodoret (A.D. 420). It reappears in Abulpharagius (1226-1286), and was received by Grotius. As involving a literal basis, it was vehemently objected to by Sanctius, Durham, and Calovius, but approved of and systematized by Bossuet, indorsed by Lowth, and used for the purpose of translation by Percy and Williams. The arguments of Calovius prevented its taking root in Germany; and the substitution by Good of an Israelitish for an Egyptian bride has not saved the general theory from the neglect which was inevitable after the reactionary movement of the 19th-century allegorists.

2. *Allegorical*.—Notwithstanding the attempts which have been made to discover this principle of interpretation in the Sept. (Cant. iv, 8); Jesus Sirach (xlvii, 14-17); Wisd. (viii, 2), and Josephus (c. *Apion*, i, § 8), it is impossible to trace it, with any certainty, farther back than the Talmud (see Ginsburg, *Introd.*). According to the Talmud, the *beloved* is taken to be God; the *loved one*, or bride, is the *congregation of Israel*. This general relation is expanded into more particular detail by the Targum, or Chaldee Paraphrase, which treats the Song of Songs as an allegorical history of the Jewish people from the exodus to the coming of the Messiah and the building of the third temple. In order to make out the parallel, recourse was had to the most extraordinary devices: e. g. the reduction of words to their numerical value, and the free interchanging of words similar to each other in sound. Elaborate as it was, the interpretation of the Targum was still farther developed by the mediæval Jews, but generally constructed upon the same allegorical hypothesis. It was introduced into their liturgical services; and during the persecutions of the Middle Ages its consoling appeal to the past and future glories of Israel maintained it as the popular exposition of a national poem. It would be strange if so universal an influence as that of the scholastic philosophy had not obtained an expression in the interpretation of the Canticles. Such an expression we find in the theory of Ibn Caspe (1200-1250), which considers the book as representing the union between the *active intellect* (intellectus agens), and the *receptive or material intellect* (intellectus materialis). A new school of Jewish interpretation was originated by Mendelssohn (1729-1786), which, without actually denying the existence of an allegorical meaning, determined to keep it in abeyance, and meanwhile to devote itself to the literal interpretation. At present the most learned rabbis, following Löwesoehn, have abandoned the allegorical interpretation altogether (Hexheimer, 1848; Philipsson, 1854).

In the Christian Church, the Talmudical interpretation, imported by Origen, was all but universally received. It was impugned by Theodore of Mopsuestia (360-429), but continued to hold its ground as the orthodox theory till the revival of letters, when it was called in question by Erasmus and Grotius, and was gradually superseded by the typical theory of Grotius, Bossuet, Lowth, etc. This, however, was not effected without a severe struggle, in which Sanctius, Durham, and Calovius were the champions of the *allegorical* against the *typical* theory. The latter seems to have been mainly identified with Grotius (Pol. *Syn.*), and was stigmatized by Calovius as the heresy of The-

odore Mopsuestia, condemned at the second council of Constantinople, and revived by the Anabaptists. In the 18th century the allegorical theory was reasserted, and reconstructed by Puffendorf (1776) and the reactionary allegorists, the majority of whom, however, with Rosenmüller, return to the system of the Chaldee Paraphrase.

Some of the more remarkable variations of the allegorical school are: (a.) The extension of the Chaldee allegory to the Christian Church, originally projected by Aponius (7th century), and more fully wrought out by De Lyra (1270-1840), Brightman (1600), and Cocceius (1608-1699). According to De Lyra, chaps. fi-vii describe the history of the Israelites from the exodus to the birth of Christ; chap. vii ad fin. the history of the Christian Church to Constantine. Brightman divides the Canticles into a history of the *Legal* and a history of the *Evangelical* Church: his detail is highly elaborate; e. g. in Cant. v, 8, he discovers an allusion to Peter Waldo (1160), and in verse 18 to Robert Trench (1290). (b.) Luther's theory limits the allegorical meaning to the contemporaneous history of the Jewish people under Solomon. (c.) According to Ghislerius and Corn. a Lapide, the bride is the Virgin Mary. (d.) Puffendorf refers the spiritual sense to the circumstance of our Saviour's death and burial.

3. The *literal* interpretation seems to have been connected with the general movement of Theodore Mopsuestia (360-429) and his followers, in opposition to the extravagances of the early Christian allegorists. Its *scheme* was nuptial, with Pharaoh's daughter as the bride. That it was by many regarded as the only admissible interpretation appears from Theodoret, who mentions this opinion only to condemn it. Borne down and overwhelmed by the prolific genius of mediæval allegory, we have a glimpse of it in Abulpharagius (see above), and in the MS. commentary (Bodl. Oppenh. Coll. No. 625), cited by Mr. Ginsburg, and by him referred conjecturally to a French Jew of the 12th or 18th century. This commentary anticipates more recent criticism by interpreting the Song as *celebrating the humble love of a shepherd and shepherdess*. The extreme literal view was propounded by Castellio (1544), who rejected it from the Canon. Following out this idea, Whiston (1728) recognised the book as a composition of Solomon, but denounced it as *foolish, lascivious, and idolatrous*. Nearly the same view is entertained by Dr. Clarke in his *Commentary*. Meanwhile the *nuptial* theory was adopted by Grotius as the literal basis of a secondary and spiritual interpretation, and, after its dramatical development by Bossuet, long continued to be the standard scheme of the mystical school. Bossuet's idea of this poem was that it is a regular drama, or pastoral eclogue, consisting of seven acts, each act filling a day, concluding with the Sabbath, inasmuch as the bridegroom on this day does not, as usual, go forth to his rural employments, but proceeds from the marriage chamber into public with his bride. The following are Bossuet's divisions of the plots:

First day	Chap. 1-ii, 6.
Second day	“ ii, 7-17.
Third day	“ iii-v, 1.
Fourth day	“ v, 2-vi, 9.
• Fifth day	“ vi, 10-vii, 11.
Sixth day	“ vii, 12-viii, 3.
Sabbath	“ viii, 4-14.

In 1808 this scheme was reconstructed by Good, with a Jewish instead of an Egyptian bride; and his version is still the most elegant. For the most ingenious and completely elaborated form in which this theory has been developed, see the new translation in scenic form by Taylor in his edition of *Calmet's Dict.*; also more lately by Horner in the *Methodist Quart. Review*, July, 1862. See THEATRICAL REPRESENTATIONS.

The *purely literal* theory, opposed on the one hand to the allegorical interpretation, and on the other to Castellio and Whiston, owes its origin to Germany. Michaelis (1770) regarded the Song as an exponent of

wedded love, innocent and happy. But, while justifying its admission into the Canon, he is betrayed into a levity of remark altogether inconsistent with the supposition that the book is inspired (Not. *ad Lovth*, *Præf.*). From this time the scholarship of Germany was mainly enlisted on the side of the literalists. The literal basis became thoroughly dissociated from the mystical superstructure, and all that remained to be done was to elucidate the true scheme of the former. The most generally received interpretation of the modern literalists is that which was originally proposed by Jacobi (1771), adopted by Herder, Ammon, Umbreit, Ewald, etc., and more recently by Prof. Meier of Tübingen (1854), and in England by Mr. Ginsburg, in his learned translation (1857). According to the detailed application of this view as given by Mr. Ginsburg, the Song is intended to display the *victory of humble and constant love over the temptations of wealth and royalty*. The tempter is Solomon; the object of his seductive endeavors is a Shulamite shepherdess, who, surrounded by the glories of the court and the fascinations of unwonted splendor, pines for the shepherd-lover from whom she has been involuntarily separated. In this scheme the drama is divided into five sections, indicated by the thrice-repeated formula of adjuration (ii, 7; iii, 5; viii, 4), and the use of another closing sentence (v, 1).

Section 1 (ch. I-II, 7): scene, a country-seat of Solomon. The shepherdess is committed to the charge of the court ladies ("daughters of Jerusalem"), who have been instructed to prepare the way for the royal approach. Solomon makes an unsuccessful attempt to win her affections.

Sec. 2 (ii, 8-III, 5): the shepherdess explains to the court ladies the cruelty of her brothers, which had led to the separation between herself and her beloved.

Sec. 3 (III, 6-v, 1): entry of the royal train into Jerusalem. The shepherd follows his betrothed into the city, and proposes to rescue her. Some of her court companions are favorably impressed by her constancy.

Sec. 4 (v, 2-viii, 4): the shepherdess tells her dream, and still further engages the sympathies of her companions. The king's fatteries and promises are unavailing.

Sec. 5 (viii, 5-14): the conflict is over; virtue and truth have won the victory, and the shepherdess and her beloved return to their happy home, visiting on the way the tree beneath whose shade they first plighted their troth (vii, 6). Her brothers repeat the promises which they had once made conditionally upon her virtuous and irreproachable conduct.

Even in Germany, however, a strong band of reactionary allegorists have maintained their ground, including such names as Hug, Kaiser, Rosenmüller, Hahn, and Hengstenberg. On the whole, their tendency is to return to the Chaldee paraphrase, a tendency which is specially marked in Rosenmüller. In England the battle of the literalists has been fought by Dr. Pye Smith (*Congreg. Mag.* for 1837, 88); in America by Prof. Noyes, who adopts the extreme *erotic* theory, and is unwilling to recognise in Canticles any moral or religious design. It should be observed that such a sentiment as this of Dr. Noyes is utterly alien to the views of Jacobi and his followers, who conceive the recommendation of virtuous love and constancy to be a portion of the very highest moral teaching, and in no way unworthy of an inspired writer.

The allegorical interpretation has been defended in America by Professors Stuart and Burrowes. The *internal* arguments adduced by the allegorists are substantially the same with those urged by Calovius against the literal basis of the mystical interpretation. The following are specimens: (a.) Particulars not applicable to Solomon (v, 2). (b.) Particulars not applicable to the wife of Solomon (i, 6, 8; v, 7; vii, 1, comp. i, 6). (c.) Solomon addressed in the second person (viii, 12). (d.) Particulars inconsistent with the ordinary conditions of decent love (v, 2). (e.) Date twenty years after Solomon's marriage with Pharaoh's daughter (comp. Cant. iv, 4, and 1 Kings vi, 38). It will readily be observed that these arguments do not in any way affect the literal theory of Jacobi.

For *external* arguments the allegorists depend principally upon *Jewish tradition and the analogy of Oriental*

tal poetry. The value of the former, as respects a composition of the 10th century B.C., is estimated by Michaelis (*Not. ad Lovth*) at a very low rate. For the latter, it is usual to refer to such authors as Charadin, Sir W. Jones, D'Herbelot, etc. (see Rosenm. *Asiatic*). Rosenmüller gives a song of Hafiz, with a paraphrase by a Turkish commentator, which unfolds the spiritual meaning. For other specimens of the same kind, see Lane's *Egyptians*, ii, 215 sq. On the other hand, the objections taken by Dr. Noyes are very important (*New Transl.*). It would seem that there is one essential difference between the Song of Solomon and the allegorical compositions of the poets in question. In the latter the allegory is more or less avowed, and distinct reference is made to the Supreme Being; in the former there is nothing of the kind. But the most important consideration adduced by the literalists is the fact that the Canticles are the production of a different country, and separated from the songs of the Sufis and the Hindoo mystics by an interval of nearly 2000 years. To this it may be added that the Song of Solomon springs out of a religion which has nothing in common with the pantheism of Persia and India. In short, the conditions of production in the two cases are utterly dissimilar. But the literalists are not content with destroying this analogy; they proceed farther to maintain that allegories do not generally occur in the sacred writings without some intimation of their secondary meaning, which intimation in the case of the Canticles is not forthcoming. They argue, from the total silence of our Lord and his apostles respecting this book, not indeed that it is uninspired, but that it was never intended to bear within its poetic envelope that mystical sense which would have rendered it a perfect treasury of reference for Paul when unfolding the spiritual relation between Christ and his Church (see 2 Cor. xi, 2; Rom. vii, 4; Eph. v, 28-32). Again, it is urged that if this poem be allegorically spiritual, then its spiritualism is of the very highest order, and utterly inconsistent with the opinion which assigns it to Solomon. The philosophy of Solomon, as given in Ecclesiastes, is a philosophy of indifference, apparently suggested by the exhaustion of all sources of physical enjoyment. The religion of Solomon had but little practical influence on his life; if he wrote the glowing spiritualism of the Canticles when a young man, how can we account for his fearful degeneracy? If the poem was the production of his old age, how can we reconcile it with the last fact recorded of him, that "his heart was not perfect with the Lord his God?" For the same reason it is maintained that no other writer would have selected Solomon as a symbol of the Messiah. The excessively amative character of some passages is designated as almost blasphemous when supposed to be addressed by Christ to his Church (vii, 2, 8, 7, 8); and the fact that the dramatic persons are three is regarded as decidedly subversive of the allegorical theory.

The strongest argument on the side of the allegorists is the matrimonial metaphor so frequently employed in the Scriptures to describe the relation between Jehovah and Israel (Exod. xxxiv, 16; Num. xv, 89; Psa. lxxiii, 27; Jer. iii, 1-11; Ezek. xvi, xxiii, etc.). It is fully stated by Prof. Stuart (*O. T. Canon*). On the other hand, the literalists deny so early a use of the metaphor. They contend that the phrases describing spiritual fornication and adultery represent the literal fact; and that even the metaphor, as used by the prophets who lived after Solomon, implies a wedded relation, and therefore cannot be compared with the ante-nuptial affection which forms the subject of Canticles.—Smith, *Dict. of Bible*, s. v.

On the whole, a combination of the moderately literal interpretation with the general allegorical idea seems to be the true one, by which, under the figure of chaste conjugal love (probably that of Solomon and the Egyptian princess), set forth in Oriental style and

warmth [see MARRIAGE], the union of Jehovah and his Church is represented after the analogy of a parable (q. v.). All attempts, however, hitherto made to carry the explanation into detail, especially in the application of the language to the phenomena of individual religious experience, have been signal failures, having been, indeed, rather the offspring of a sensuous

fanaticism or over-wrought enthusiasm, than of sound devotion or sober interpretation. See ALLEGORY. Taking, therefore, the ground figure of connubial as typical of divine union to be intended to be represented in this general expression only by this unique specimen of sacred phantasmagoria, we may venture to arrange it dramatically somewhat as follows:

Time.	Place.	Persons.	Subject.	Passage.
1. Morn. Eve.	Antechamber of palace. Audience-room of palace.	Bride and ladies. Bride, groom, and attendants.	The welcome to the future home. The first interview.	i. 2-5. i. 9-11, & ii. 1-17.
2. Morn. Eve.	Palace window. Private chamber.	Bride and groom. Bride.	The invitation, in serenade. The search, in fancy.	iii. 1-4. iii. 5-11.
3. Morn. Eve.	Front of palace. Palace garden.	Bride, groom, and ladies. Bride and groom.	The return from parade. The visit and excursion.	iv. 1-v. 1. v. 2-vi. 3.
4. Morn. Eve.	Private chamber. Palace apartment.	Bride and ladies. Bride, groom, and visitors.	The dream. The reception-party.	vi. 4-15. vii. 1-5.
5. Morn. Eve.	Private chamber. Private apartment.	Bride and ladies. Bride and groom.	The toilette. The mutual avowal.	viii. 6-viii. 8. viii. 9-14.
6. Morn. Eve.	Public apartment. Private apartment.	Bride, groom, and witnesses. Bride, groom, and brothers.	The espousal. The dowry.	viii. 4-7. viii. 9-14.

IV. *Canonicity*.—It has already been observed that the book was rejected from the Canon by Castello and Whiston, but in no case has its rejection been defended on external grounds. It is found in the Sept., and in the translations of Aquila, Symmachus, and Theodotion. It is contained in the catalogue given in the Talmud, and in the catalogue of Melito; and, in short, we have the same evidence for its canonicity as that which is commonly adduced for the canonicity of any book of the O. T.

V. *Commentaries*.—The following are the exegetical works expressly on the whole of this book, a few of the most important being indicated by an asterisk (*) prefixed: Origen, *Homilia*, etc. (in *Opp.* iii. 12, 23, 94); Theophilus, *Fragmenta* (in Grabe's *Spicilegium*, ii. 228); Eusebius, *Expositio* [Gr. and Lat.] (in Meursii *Opera*, viii. 125); Polychronus and Psellus, *Expositiones* (ed. Meursius, Lugd. 1617, 4to); Athanasius, *Homilia* (in *Opp.* iii. 37); also *Fragmenta* (ib. i. 1, 1006); *Gregory Nyssen, *Explanatio* (in *Opp.* i. 468; also *Bibl. Patr.* Gall. vi. 645); Ambrose, *Commentarius* (in *Opp.* i. 1546); Epiphanius, *Commentarius* (ed. Foggini, Rom. 1750, 4to); Philo Carpathus, *Interpretatio* (Lat. in *Bibl. Max. Patr.* v. 661; Gr. and Lat. in *Bibl. Patr.* Gall. ix. 718; also *Enarratio*, ed. Gr. and Lat. Giacomelli, Rom. 1772, 4to); Theodoret, *Explanatio* (Rom. 1568, fol.; Ven. 1574, 4to; also in *Opp.* II. i. 1; tr. in "Voice of the Church"); Cassiodorus, *Expositio* (in *Opp.* ii. 479); Gregory the Great, *Expositio* (in *Opp.* III. ii. 397); Justus Orgetitanus, *Explicatio* (in *Bibl. Max. Patr.* ix. 781); Isidore, *Expositio* (in *Opp.* p. 608); Apponius, *Expositio* (in *Bibl. Max. Patr.* xiv. 98); Lucas, *Summariola* (in *Bibl. Max. Patr.* xiv. 128); Udalricus, *Scholia* (ib.); Bede, *Expositio* (in *Opp.* iv. 714; also *Works* by Giles, ix. 186); Alcuin, *Compendium* (in *Opp.* I. ii. 391); Angelomanus, *Enarrationes* (in *Bibl. Max. Patr.* xv); Bruno Astensis, *Cantica* (in *Opp.* i.); Anselm, *Enarrationes* (in *Opp.* ed. Picard); Rupertus Tuitiensis, *Commentaria* (in *Opp.* i. 986); Bernard, *Sermones* (in *Opp.* I. ii. 2649; also ib. II. i. 555); Irimperius, *Commentarius* (Pez, *Theaur.* II. i. 369); Aquinas, *Commentarius* (in *Opp.* i.); Honorius Augustodunensis, *Commentarius* (in *Opp.*; also *Bibl. Patr. Max.* xx. 968); Jarchi's annotations [Heb.] (in Buxtorf's Rabbinical Bible, q. v.); Rashi's פירוש (in the Rabbinical Bibles; also with Lat. tr. by Genebrard, Par. 1570 and 1585, 8vo; with notes by Breithaupt, Gotha, 1714, 4to; in Jewish-German by Bresch, Cremona, 1560, fol., and since); R. S. ben-Meir (Rashbam), פירוש (first published Lpz. 1855, 8vo); *Aben-Ezra, פירוש (in Frankfurter's Rabbinical Bible; in Lat. by Genebrard, Paris, 1570 and 1858, 8vo); Alscheich, פירוש דעם פירוש (Ven. 1591 and 1606, 4to, and since); Nachmani (or rather Aarial, A. D. cir. 1200), פירוש [Cabalistic] (Altona, 1764, 4to; including comments by Ibn-Tamar, Johan-

nish. 1857, 8vo); Arama, פירוש (in the Amst. Rabb. Bible, which likewise contains the three following); De Bafioles, פירוש (R. de Trento, 1560, 4to); Joab ben-Jachya, פירוש (Bologna, 1588, fol.); Is. Jaabez, פירוש (Belvidere, n. d. fol.); Holkot, *Note* (Ven. 1509, fol.); Nic. de Argentina, *Expositiones* (Pez, *Bibl. Accet.* xi. xii); Thomas Perellensis, *Commentarius* (Pez, *Theaur.* ii. 508); Perez, *Expositio* (in *Exp. Psalm.*); Radulphus Fontanellensis, *Commentaria* (Hommy, *Suppl.* p. 276); Gerson, *Tractatus* (in *Opp.* iv. 27); *Luther, *Enarratio* (Vitemb. 1538, 1539, 8vo; also in *Opp.* Latin ed. Vit. iv. 49; ed. Jen. iv. 226; Germ. ed. Lips. vii. 1; ed. Hal. v. 2385); Zwingle, *Complanatio* (in *Opp.* iii); Marloratus, *Expositio* (in *lib. Psalm.* etc.); Beza, *Sermons* (tr. by Harinar, Oxf. 1587, 4to); Hall, *Paraphrase* (in *Works*, i. 245, etc.); Theresa, *Explicationes* (in *Œuvres*, p. 829); Jansen, *Annotaciones* (in *Psalmi*, etc.); Maldonatus, in *Cont.* (in *Commentarii*, p. 165); Mercer, *Commentarii* (in *Jobus*, etc.); Wilcocks, *Exposition* (in *Works*); à Lapide, in *Cont.* (in *Commentarii*); Homes, *Comment.* (in *Works*); Castell, *Annotaciones* (in Walton's *Polyglot*, vi); Tegellath, *Expositio* (Ven. 1510, fol.); Halgrin, *Expositio* (Par. 1521, fol.); Guidacer, *Commentarius* (Par. 1531, 8vo); Arboreus, *Commentarius* (Paris, 1537 and 1558, fol.); Titelmann, *Commentarii* (Antw. 1547, 8vo, and later); Alkabez, פירוש אוריאל (Ven. 1552, 4to); Nannius, *Scholia* (Lon. 1554, 4to); Ab. ben-Isaac (Tamak), פירוש (with others, Sabinotta, 1558, 12mo; Prague, 1611, 4to); Strigel, *Scholia* (Lips. 1665, 8vo); Almoenino, פירוש (Salonica, 1572; Ven. 1597, 4to); Mercer, *Commentarius* (Gen. 1578; L. B. 1651, fol.); Ibn-Jaisch, פירוש מקורי (Constant. 1576, fol.); Genebrard, *Observationes* (Par. 1579, 4to; also his *Paraphrasis*, ib. 1585, 8vo); Arepol, פירוש שלום (Safet, 1579, 4to; also in אגרות שמואל, Ven. 1598); Saadias, פירוש (from the Arab. with others on the same book, Constpl. n. d. 4to; first separately, Prague, 1608, 4to, etc.); Brocardus, *Interpretatio* (L. B. 1580, 8vo); Garzia, *Expositio* (Complut. 1581, fol., and later); De la Huerga, *Commentarius* (Complut. 1582, fol.); Damianus, *Commentarius* (Venice, 1585, 4to); Almoncirus, *Commentarius* (Complut. 1588, 4to); Blackney, *Commentarius* (Ven. 1591, 4to); Rosseti, *Commentarius* (Ven. 1594, 4to); Janson, *Commentarius* (Lond. 1598, 1604; Ingolstadt, 1605, 8vo); Gyffard, *Sermons* (Lond. 1598, 8vo); Brucioli's commentary (in Italian, Ven. 1598, 8vo); Sotomajor, *Interpretatio* (Olyssip. 1599, Paris, 1606, fol.; also *Nota*, ib. 1611, 4to); Jesu Maria, *Interpretatio* (Rom. 1601, 8vo, and later); De Pineda, *Prælectio* (Hisp. 1602, 4to); Clapham, *Exposition* (Lond. 1608, 8vo); Del Rio, *Commentarius* (Ingolst. 1604, fol.; Par. 1607, Lugd. 1611, 4to); Loanz, פירוש הידריים [Cabalistic] (Basel, 1606, 1612, 4to); Tuccius, *Annotaciones*

(Lugd. 1606, 4to); James, *Expositio* (Oxf. 1607, 4to); Eleazar ben-Jehuda (Garmisa), *יין ירין* [Cabalaistic] (Cracow, 1608, 4to); Veronius, *Philothia* (Frib. 1609, 4to); Ghisler, *Interpretatio* (Rom. 1609, fol., and later); Mat, *מזמור* (Prague, 1612, fol.); Schärtlein's commentary [Jewish-Germ.] (Prague, 1612, 4to); Sanctius, *Commentarius* (Lugd. 1616, 4to); Nigidius, *Expositio* (Rom. 1616, Ven. 1617, 4to); Ferrarius, *Commentaria* (Lugd. 1616, Mediol. 1666, 4to); Lafado, *מזמור* [Spanish] (Venice, 1619, 4to); Argall, *Commentarius* (Lond. 1621, 4to); Gebhard or Wesener, *Explicatio* (1624, 4to); Cantacuzenus, *Expositio* (Rom. 1624, fol.); Cathius, *Paraphrasis* (Antw. 1625, 8vo); Ainsworth, *Annotations* (Lond. 1627, fol.; also in German, F. ad O. 1692, Berl. 1735, 8vo); Malder, *Commentarius* (Antw. 1628, 8vo); Peregrine, *Applicatio* (Lond. 1631, 8vo); Douce, *Commentary* (Lond. 1631, 8vo); Carlos, *Traducion* (Hamb. 1631, 4to); *Gerhard, *Erklärung* (Jen. 1631, Lub. 1644, Lpz. 1652, 1666, 4to); Sberlog, *Commentarius* (Lugd. 1633-40, 8 vols. fol.); Durlfeld, *Interpretatio* (Rint. 1633, 8vo; 1643, 4to); Folioth, *Expositio* (Lond. 1638, 4to); Hellpron, *מזמור* (Lubl. 1639, fol.); Sibbs, *Sermons* (Lond. 1639, 1641, 4to; also in *Works*, iii, 1); Petrus, *Paraphrasis* (Hafn. 1640, 4to); Arestius, *Votations* (Mediol. 1640, 4to); Sibel, *Commentarius* (Davent. 1641, 4to); Pintus, *Commentarius* (Lugd. 1642, fol.); De Salazar, *Expositiones* (Lugd. 1642, fol.); Colton, *Exposition* (Lond. 1642, 8vo); Brightman, *Commentary* (Lond. [also in Lat. Basil.] 1644, 4to); Besson, *Lucubrations* (Lugd. 1646, fol.); De Ponte, *Expositio* (Paris, 1646, 2 vols. fol.); Trap, *Commentary* (Lond. 1650, 4to); Robotham, *Exposition* (Lond. 1652, 4to); Fromond, *Commentaria* (Lovan. 1652, 1657, 4to); De Raiaa, *Commentarius* (Gen. 1656, fol. vol. i); De la Place, *Exposition* (Saum. 1656, 8vo; in Lat. Franck. 1699, 1705, 2 vols.); Guild, *Explicatio* (Lond. 1658, 8vo); Roeper, *Predigtas* (Jen. 1662, 4to); Hammond, *Paraphrasis* (Lond. 1662, 8vo); Udeman's exposition (in Dutch, Amst. 1665; in Germ. Lunenb. 1667, 8vo); *Tyrham, *Clavis* (Edinb. 1668; Lond. 1669; in Dutch, Utr. 1681; in Germ. Lpz. 1695, 4to); Durham, *Exposition* (Lond. 1668, 4to; Edinb. 1724, 4to; Aberdeen, 1840, 12mo, etc.); Grönwegen's commentary (in Dutch, Delv. 1670; in Germ. Frctf. 1711, 4to); Collinges, *Sermons* (Lond. 1676-83, 2 vols. 4to); De Sales, *Explicatio* (in *Œuvres*, xiv); *De Veil, *Explicatio* (Lond. 1679, 8vo); Dillherr, *Adnotationes* (Vratisl. 1680, 8vo); Senert, *Nota* (Vitemb. 1681, 1689, 4to); Franco-Serrano, *מזמור* (Amst. 1683, 8vo); Guion's commentary (in French, Leyd. 1688, 8vo; in Germ. Frctf. 1706, 12mo); Schütten, *Commentarius* (Lips. 1688, 4to); Auratus, *Expositio* (Lugd. 1689, 1698, 8vo); Bourdaloue, *Exposition* (Paris, 1689, 12mo); Heunisch, *Commentarius* (Lips. 1689, 4to); Lydius, *Verklar.* (Amst. 1690 and 1719, 8vo); Anonymous, *Explicatio* (Paris, 1690, 8vo); Bossuet, *Nota* (Paris, 1698, 8vo; also in *Œuvres*, xxi, 801); Geschwend, *Nota* (Jen. 1699, 8vo); Marck, *Commentarius* (Amst. 1703, 4to); Hamon, *Explicatio* (Par. 1706, 4 vols. 12mo); Anonymous, *Spiritual Songs* (10th ed. Lond. 1708, 8vo); Adam, *Erklärung* (Lpz. 1708, 4to); Seebach, *Erklärung* (Leipzig, 1710, 8vo); Anonymous, *Explicatio* (Paris, 1717, 12mo); Hellenbroek, *Verklar.* (Amst. 1718, 1720, 2 vols. 4to); Michaelis, *Adnotationes* (Hal. 1720, 4to); Anon. (after Neumann), *Erklärung* (Breslau, 1720, 8vo); Wacter, *Anmerkungen* (Memm. 1722, 4to); Mill, *Canon auctoritas*, etc. (Ultras. 1725, 4to); Kerr, *Paraphrasis* (Edinb. 1727, 12mo; also in *Pres. Scot.* i); Stennet, *Versio* (in *Works*, iv); Gill, *Exposition* (Lond. 1728, fol.); Peterzen, *Erklärung* (Bud. 1728, 8vo); Woken, *Commentatio* (Vitemb. 1729, 4to); Terne, *Kern. d. Hoh.* (Lpz. 1732, 8vo); Reinhard, *Commentarius* (Lemg. 1743, 8vo); Moses ben-Hillel, *מזמור* (Zolk. 1745, 8vo); Enskine, *Paraphrasis* (in *Works*, x, 309, 560); Bland,

Versio (Lond. 1750, 8vo); Anonymous, *Erklärung* (Berl. 1751, 4to); Schöber, *Umschreibung* (Augsb. 1752, 8vo); Anon. *Erklärung* (Lpz. 1756, 1777, 1788, 8vo); Anonymous, *Paraphrasen* (Halle, 1756, 8vo); Hanssen, *Betrachtungen* (Hamb. 1756, 4to); Semler, *Vorstellungen* (Hal. 1757, 8vo); Wilhelm, *Anmerkungen* (Lpz. 1764, 8vo); Bp. Percy, *Commentary* (Lond. 1764, 8vo); Harmer, *Outlines* (Lond. 1768, 8vo); *Jacobi, *Erklärung* (Calle, 1771, 8vo); Anton, *Erklärung* (Lpz. 1778, 8vo; also *Nota*, Vitob. and Lips. 1798, 1800, 8vo); Van Kooten, *Observationes* (Tr. ad Rh. 1774, 4to); Neunhöfer, *Anmerkungen* (Brem. and Lpz. 1775, 8vo); Mrs. Bowdler, *Commentary* (Edinb. 1775, 8vo); Green, *Notes* (in *Poets of O. T.*); Luderwald, *Erklärung* (Wolfenbüttel, 1776, 8vo); Von Pufendorf, *Erklärung* (Brem. 1776, 4to); Hezel, *Erklärung* (Lpz. and Bresl. 1777, 8vo); Zinck, *Commentarius* (Augsb. 1778, 4to); Lessing, *Interpretatio* (Lips. 1779, 8vo); Herder, *Interpretatio* (Lips. 1779, 8vo; also in *Werke*, iii, Stuttg. 1852); Hufnagel, *Ueber's H. L.* (in Eichhorn's *Repertorium*, pt. vii-xi, Lips. 1780-2; also *Erläuterung*, Erlang. 1784, 8vo); Kleuker, *Sammlung* (Hamm. 1780, 8vo); Francis, *Notes* (Lond. 1781, 4to); Romaine, *Discourses* (in *Works*, v, i); Jones, *Inquiry* (in *Works*, iii, 851); Skinner, *Essay* (in *Works*, ii); Schlez, *Anmerkungen* (Augsb. 1782, 8vo); Rupert, *Observationes* (in *Symbola*, I, ii, Gott. 1782, 1792); Döderlein, *Übersetzung* (Nürnberg, 1784, 1792, 8vo); Hodgson, *Translation* (Lond. 1785, 4to); Paulus, *Ueber's H. L.* (in Eichhorn's *Repert.* xvii, 1785); Velthusen, *Catena* (Helmst. 1786, 8vo; also *Schweesternhandel*, Braunsch. 1786, 8vo; also *Amethyst*, ib. eod. 8vo); Anonymous, *Versio* (Flor. 1786, 8vo); Lederer, *Singspiel* (Burgh. 1787, 8vo); Leone, *Observazioni* (Turin, 1787, 8vo); *Mendelssohn, *מזמור*, etc. (with other commentators, Berl. 1788; Prague, 1808, 8vo; with Germ. text, Braunsch. 1789, 8vo); Anonymous, *Erklärung* (Hamb. 1788, 8vo); Lindemann, *Erklärung* (in Keil, *Analekten*, III, i, 1-80); Anonymous, *Anmerkungen* (Basel, 1789, 8vo); Ammon, *Liebesgedicht* (Lpz. 1790, 8vo); Galicho, *מזמור* (Lagh. 1790, 4to); Libowitz, *מזמור* (Koresz, 1791, 8vo); Beyer, *Anmerkungen* (Marb. 1792, 8vo); Ständlin, *Idyllen*, etc. (in Paulus, *Memorabilien*, ii, Jena, 1792); Gaab, *Erklärung* (Tübingen, 1795, 8vo); Birs, *מזמור* (Grodno, 1797, 4to); Schyth, *Commentarius* (Havn. 1797, 8vo); Brieglob, *Erläuterung* (Amst. 1798, 8vo); Joseph ben-Abraham *מזמור* (Grodno, 1798, 8vo); Asulal, *מזמור* (Grodno, 1800, fol.); Williams, *Commentary* (Lond. 1801, 1828, 8vo); *Good, *Notes* (Lond. 1808, 8vo); Anonymous, *Liebeslieder* (in *Journal für Kath. Theol.* I, ii, Erf. and Lpz. 1808); Polozk, *מזמור* (Grodno, 1804, 4to); Frost, *Carm. eroticum* (Hafn. 1805, 8vo); Justi, *Hochgedinge* (in *Blumen*, i, 287, Marburg, 1809); Löwiso, *מזמור* (Vien. 1811, 4to); Wilna, *מזמור* (Prague, 1811, 4to [liturgical]); also *מזמור* [partly cabalistic], Warsaw, 1842, 4to); Fry, *Notes* (Lond. 1811, 1825, 8vo); Hug, *Deutung*, etc. (Frey. and Consz. 1813, 4to; also *Erläuterung*, Freyb. 1815, 4to); Jacob-Lissa, *מזמור* (Dyrenfurt, 1815-19, 4to); Davidson, *Remarks* (Lond. 1817, 8vo); Kistmaker, *Illustratio* (Monast. 1818, 8vo); *Umbreit, *Erklärung* (Gött. 1820, Heidelb. 1828, 8vo); Taylor, *Minstrel* (Glasgow, 1820, 12mo); Clarke, *Targum* (in *Commentary*, iii); Hawker, *Commentary* (Lond. 8vo); Lowth, *Prælect.* xxx, xxxi (with the notes of Michaelis and the animadversions of Rosenmüller, Oxon. 1821); Kaiser, *Collectio-Geang* (Erlang. 1825, 8vo); *Ewald, *Anmerkungen* (Gött. 1826, 8vo); Bartholmæ, *Erläuterungen* (Nürnberg. 1827, 8vo); Döpke, *Commentar* (Lpz. 1829, 8vo); *Rosenmüller, *Scholæ* (Lips. 1830, 8vo); Cuniz, *Hist. d. P. Interpretation*, etc. (Strassb. 1834, 4to); Rebenstein, *Erläuterung* (Berl. 1834, 8vo); Blau, *Versuch* (Culm, 1838, 8vo); Krummacher, *Sermons* (Lond.

1839, 8vo; from the German, 3d ed. Elberf. 1830, 8vo); Barham, *S. of S.* (in *Bible*, ii); *Uhleemann, *De interp., ratione*, etc. (Berlin, 1839, 4to); Schick (Wasziliszob), מְדַבֵּר וְשׂוֹרֵר (Warsaw, 1840, 8vo); Hirzel, *Erklärung* (Zur. and Fauenf. 1840, 12mo); Magnus, *Bearbeitung* (Halle, 1842, 8vo); Isaak-Aaron, מְדַבֵּר וְשׂוֹרֵר (Wilna, 1843, 8vo); Ulrich, *Commentar* (Berlin, 1845, 8vo); Edelmann, מְדַבֵּר (Danz. 1845, 8vo); Avrillon, *Affections*, etc. (Lond. 1845, 12mo); Stowe, in *Am. Bib. Repos.* Apr. 1847 (reprinted in *Jour. Sac. Lit.* Jan. 1852); Brown, *Discourses* (pt. i, Lond. 1848, 18mo); Böttcher, *Erklärung* (Lpz. 1849, 8vo); *Dellitsch, *Auslegung* (Lpz. 1851, 8vo); Goltz, *Auslegung* (Berl. 1851, 8vo); Mundt, *Ueber's H. L.* (in *Literaturgesch.* i, 153, 1849); Anonymous, *Reflections* (Lond. 1851, 12mo); *Hengstenberg, *Auslegung* (Berlin, 1853, 8vo); Burrowes, *Commentary* (Phila. 1853, 12mo); Clay, *Lectures* (Lond. 1853, 12mo); Meier, *Erklärung* (Tübingen, 1854, 8vo); Forbes, *Commentary* (Lond. 1854, 32mo); Hitzig, *Erklärung* (in *Exeg. Handb.* xvi, Lpz. 1855, 8vo); Blaubach, *Erläuterung* (Berl. 1855, 8vo); Newton, *Comparison*, etc. (3d ed. 1855, 8vo); Hölemann, *Krone*, etc. (Lpz. 1856, 8vo); *Ginsburn, *Commentary* (Lond. 1857, 8vo); Walker, *Meditations* (London, 1857, 18mo); *Weiss, *Exposition* (Edinb. 1858, 12mo); Schuler, *Erläuterung* (Wurz. 1858, 8vo); Anonymous, *Uebersetzung* (Ulm, 1858, 8vo); Weissbach, *Erklärung* (Lpz. 1858, 8vo); Vaibinger, *Erklärung* (in *Dicht. Schriften d. A. B.* iv, Stuttgart, 1858, 8vo); Anonymous, *Explanation* (Lond. 1858, 8vo); Anonymous, *Translation* (Lond. 1858, 8vo); Malbim, מְדַבֵּר וְשׂוֹרֵר (Bucharest, 1860, 8vo); Anonymous, *Commentary* (Lond. 1860, 12mo); Rénan, *Traduction* (Par. 1860, 8vo); Stuart, *Exposition* (Lond. 1860, 8vo; also *Key*, Lond. 1861, 12mo); Withington, *Explanation* (Boston, 1861, 12mo); Thrupp, *Translation* (Lond. 1862, 8vo); Mendelstarm, *Erläuterung* (Berl. 1862, 4to); Horowitz, *Anmerkungen* (Vienna, 1863, 12mo); Houghton, *Essay* (Lond. 1865, 8vo); Diedrich, *Erläuterung* (Neu-Rupping, 1865, 8vo). See SOLOMON (*Books of*).

Cantor (*singer*), an ancient ecclesiastical order so called, and a title still given to the master of the choir in many churches, as, in modern use, *precentor*. The Councils of Cologne, A. D. 1260 and 1536, give to the chanter, or *cantor*, the title of *chorespiscopus*, or bishop of the choir. The cantor is also the same with the primicerius. The order of cantores appears to be of great antiquity, and is mentioned in the Canons called Apostolical, Nos. 26, 43, and 69, and in the Liturgy of St. Mark, which was written before the fourth century (Renaudot, *Liturg. Orient. Coll.* tom. i, pref. p. xxxv, and p. 151). The Council of Laodicea, can. 15, forbids any to sing in church except the singers or cantores whose names were inscribed on the canon of the church, and whose proper place was in the *ambo*. By can. 23 it forbade the cantores to wear the stole or *orarium*. The Roman writers endeavor to prove that the lector and cantor were the same, but they are everywhere spoken of in the ancient canons as distinct orders. There is no reason to believe this order to be of higher than ecclesiastical institution only. The cantor might be ordained even by a priest (*Con. Carth.* 4, cap. 10). This order is still retained in the Oriental Church. — Bingham, *Orig. Eccl.* bk. iii, ch. vii; Landon, *Eccl. Dict.* s. v.

Canus or Cano, MELCHIOR, a distinguished Spanish theologian, was born at Tarançon in 1523, and entered the Dominican order at Salamanca, where he studied theology under Francisco Vittoria, whom he succeeded in 1546 in the theological chair, after having served brilliantly as professor at Valladolid and Alcala. He formed a party in opposition to Carranza, afterward archbishop of Toledo, to whose disgrace he greatly contributed. When the Jesuits endeavored to settle at Salamanca, Canus vehemently denounced

them as the precursors of Antichrist, and so successfully that it was not until he had gone to the Canaries that they could establish themselves in Salamanca. He was made bishop of the Canaries by Paul III, but resigned, and retired into a convent of his order, of which he became, in 1554, provincial for the province of Spain. He died at Toledo, Sept. 30, 1560. His chief and best-known work is his *Locorum Theologicorum libri xii*, relating to the sources whence polemical theologians may derive proofs of their opinions and arguments (Salamanca, 1562, fol.). It may be found, with his other writings, in his *Opera, edit. novis.* (Basani, 1776, 4to).—Hoeser, *Novw. Biog. Générale*, viii, 494.

Canute. See DENMARK.

Cap (or BONNET, *pileolus*), in clerical dress. Cardinal Richelieu is said to be the first who wore the *calotte*, or cap, in France. The red cap is peculiar to the college of cardinals. The bonnet or cap worn by the Jesuits, Barnabites, Theatines, and by the Italians generally, is three-cornered and square, and worn without the cape. See VESTMENTS OF THE CLERGY.

Caparcotia (Καπαρκωτία, a name of which the initial element is evidently the Heb. כַּפָּרִי See CAPHAR-), a town located by Ptolemy (iv, 16) in Galilee, and mentioned (*Caparcotana*) in the *Peutinger Table* as situated between Scythopolis and Cæsarea Palestine (Reland, *Palæst.* p. 461, 687), 24 R. miles from the former and 28 from the latter. It was discovered by Burckhardt (*Travels*, p. 551) in the modern *Kefr-Kud*, a village about one hour [1½] west of Jenin, among the hills (Robinson, *Researches*, iii, 159), and half an hour west of Burkin (Wolcott, in the *Biblioth. Sacra*, 1843, p. 76; Robinson, *Later Researches*, p. 121), situated on an eminence, with a high wely north of the village, called Sheik Zeit, and visible from a great distance all around (Van de Velde, *Memoir*, p. 301).

Capellus. See CAPELLUS.

Caper-plant (צְבִינְיָה, *abiyonah*, from צָבָה, to *desire*, Sept. κάππαρις) is mentioned only once in the Bible (Eccles. xii, 5): "When the almond-tree shall flourish, and the grasshopper shall be a burden, and *desire* shall fail; because man goeth to his long home." The word here translated *desire* has been considered for this opinion are that the rabbins apply the plural (צְבִינְיָה, *abiyonah*: see *Berachoth*, xxxvi, 1) to the small fruit of trees and berries, as well as to that of the caper-bush (Buxtorf, *Lex. Talm.* col. 12); that the caper-bush is common in Syria and Arabia (see Galen, *Facult. Alim.* ii, 34); that its fruit was in early times eaten as a condiment, being stimulating in its nature, and therefore calculated to excite desire (Plutarch, *Quæst. Symp.* vi, 2; Pliny, *Hist. Nat.* xiii, 23; xx, 15; comp. xiii, 44; xx, 69; Dioscor. ii, 204); that as the caper-bush grows on tombs, it will be liable to be destroyed when these are opened; and, finally, that as Solomon speaks here in symbols and allegories, we must suppose him to deviate from the course he had apparently prescribed to himself if he were to express in plain words that "desire shall fail," instead of intimating the same thing by the failure of that which is supposed to have been used to excite desire. Celsius (*Hierobot.* i, 210) argues, on the contrary, that Solomon in other places, when treating of the pleasures of youth, never speaks of capers, but of wine and perfumes; that, had he wished to adduce anything of the kind, he would have selected something more remarkable; that capers, moreover, instead of being pleasantly stimulant, are acrid and hurtful; and though occasionally employed by the ancients as condiments, were little esteemed by them; and, finally, that the word *abiyonah* of the rabbins is distinct from the *abiyonah* of this passage, as is admitted even by Ursinus (*Arbor. Bâlicum*, xxviii, 1). The caper-plant, however, is often mentioned in the Talmud (*Maaseroth*, iv, 6; *Demai*, i,

1) by the terms *צפף*, *tselaph'*, *צפף*, *nisphah'*, and even *צפף*, *kaphris'* (Buxtorf, col. 1919, 1881, 2098). But as the Septuagint, the Vulgate, the Syriac, and the Arabic translations have understood the *caper-bush* to be meant, it is desirable to give some account of it, especially as, from its ornamental nature, it could not but attract attention. There are, moreover, some points in its natural history which have been overlooked, but which may serve to show that in the passage under review it might without impropriety have been employed in carrying out the figurative language with which the verse commences (see Plenk, *Plant. Med.* p. 420; Sprengel, *Hist. rei herb.* i, 14).

The caper-plant belongs to a tribe of plants, the Capparidaceæ, of which the species are found in considerable numbers in tropical countries, such as India, whence they extend northward into Arabia, the north of Africa, Syria, and the south of Europe (Forsk., *Flor.* p. 99; Shaw, p. 395). The common caper-bush—*Capparis spinosa*, Linn. (the *C. sativa* of Persoon)—is



Caper-plant (*Capparis spinosa*), with enlarged view of the Pericarp.

common in the countries immediately surrounding the Mediterranean. Dioscorides describes it as spreading in a circular manner on the ground, in poor soils and rugged situations; and Pliny "as being set and sown in stony places especially." Theophrastus states that it refuses to grow in cultivated ground. Dioscorides farther states that it has thorns like a bramble, leaves like the quince, and fruit like the olive—characters almost sufficient to identify it. The caper is well known to the Arabs, being their *kibbur*, and designated also by the name *ahuf* or *azyf*. The bark of the root, which is still used in the East, as it formerly was in Europe, no doubt possesses some irritant property, as it was one of the five aperient roots. The unexpanded flower-buds, preserved in vinegar, are well known at our tables as a condiment by the name of capers. Parts of the plant seem to have been similarly used by the ancients. The caper-plant is showy and ornamental, growing in barren places in the midst of the rubbish of ruins, or on the walls of buildings. It was observed by Ray on the Temple of Peace at Rome, and in other similar situations. It forms a much-branched, diffuse shrub, which annually loses its leaves. The branches are long and trailing; smooth, but armed with double curved stipular spines. The leaves are alternate, roundish or oblong-oval, a little fleshy, smooth, of a green color, but sometimes a little red-

dish. The flowers are large and showy, produced singly in the axils of the leaves, on stalks which are larger than the leaves. The calyx is four-leaved, coriaceous; the petals are also four in number, white, and of an oval roundish form. The stamens are very numerous and long; and their filaments, being tinged with purple and terminated by the yellow anthers, give the flowers a very agreeable appearance. The ovary is borne upon a straight stalk, which is a little longer than the stamens, and which, as it ripens, droops and forms an oval or pear-shaped berry, inclosing within its pulp numerous small seeds. Many of the caper tribe, being remarkable for the long stalks by which their fruit is supported, conspicuously display, what also takes place in other plants, namely, the drooping and hanging down of the fruit as it ripens. As, then, the flowering of the almond-tree, in the first part of the verse in question, has been supposed to refer to the whitening of the hair, so the drooping of the ripe fruit of a plant like the caper, which is conspicuous on the walls of buildings and on tombs, may be supposed to typify the hanging down of the head before "man goeth to his long home" (see the *Penny Cyclopædia*, s. v. Capparidaceæ).—Kitto, s. v. Abiyonah. See Hyssop.



Caper-berry.

Caper'naüm (*Καπερναούμ*; Lachm. [with Codex B] *Καφαρναούμ*, as if *נחום* *קריה*, "village of Nahum" [from some unknown person of that name]; Syriac, Curetonian *Kaaphar Nachum*, Peshito *Kaphar Nachum*; Vulg. *Capharnaum*), the name of a Galilean city familiar as that of the scene of many acts and incidents in the life of Christ (see Stuart, *Capernaum as the Scene of Christ's Miracles*, 2d ed. London, 1864). There is no mention of Capernaum in the O. T. or Apocrypha, but the passage Isa. ix, 1 [viii, 28] is applied to it by Matthew. The word *Caphar* in the name perhaps indicates that the place was of late foundation. See **CAPHAR-**. There is named, however, by the rabbins (Midrash, *Kohelith*, fol. 89, col. 4) a place called *Kephar-Nachum* (*כפר נחום*), which Reland (*Palæst.* p. 689) presumes to be the Capernaum of the Gospels (see Otho, *Lex. Rab.* p. 118). Josephus also mentions a remarkable fountain, called by the natives *Cupharnum* (*Καφαρναούμ*), watering the fertile "plain of Gennesareth" (*War.* iii, 10, 8); as also a village by the name of *Cepharnome* (*Κεφαρνώμη*) in the same region (*Life*, 72). Ptolemy also (v, 16, 4) calls it *Capernaum* (*Καπαρναούμ*). Another Capernaum is mentioned by William of Tyre (*De Bello Sacr.* x, 26) on the Kishon, six leagues from Cæsarea.

After the expulsion of Jesus from Nazareth (Luke iv, 16-21; Matt. iv, 13-16), where he was "brought up," Capernaum became emphatically his "own city;" it was when he returned thither that he is said to have been "at home" (Mark ii, 1; such is the force of *ἐν οἴκῳ*—A. V. "in the house"). Here he chose the evangelist Matthew or Levi (Matt. ix, 9). The brothers Simon-Peter and Andrew belonged to Capernaum (Mark i, 29), and it is perhaps allowable to imagine that it was on the sea-beach near the town (for, doubtless, like true Orientals, these two fishermen kept close to home), while Jesus was "walking" there, before "great multitudes" had learned to "gather together unto him," that they heard the quiet call which was to make them forsake all and follow him (Mark i, 16, 17; comp. 28). It was here that Christ worked the miracle on the centurion's servant (Matt. viii, 5; Luke vii, 1), on Simon's wife's mother (Matt. viii, 14; Mark i, 30; Luke iv, 38), the paralytic (Matt. ix, 1; Mark ii, 1; Luke v, 18), and the man afflicted with an unclean spirit (Mark i, 33; Luke iv, 38). The son of the nobleman (John iv, 46) was, though resident at Capernaum, healed by words which appear to have been spoken in Cana of Galilee. At Capernaum occurred the emblem-

atical incident of the child (Mark ix, 38; Matt. xviii, 1; comp. xvii, 24); and in the synagogue there was spoken the remarkable discourse of John vi (see verse 59). The infidelity and impenitence of the inhabitants of this place, after the evidence given to them by our Saviour himself of the truth of his mission, brought upon them this heavy denunciation: "And thou, Capernaum, which art exalted unto heaven, shalt be brought down to hell; for if the mighty works which have been done in thee had been done in Sodom, it would have remained unto this day," etc. (Matt. xi, 23). See GALILEE, SEA OF.

According to the notices of its situation in the N. T. Capernaum was on the western shore of the Sea of Galilee (*την παραθαλασσίαν*, Matt. iv, 18; comp. John vi, 24), and, if recent discoveries are to be trusted (Cureton's *Nitrian Rec. John vi, 17*), was of sufficient importance to give to that sea, in whole or in part, the name of the "Lake of Capernaum." (This was the case also with Tiberias, at the other extremity of the lake. Comp. John vi, 1, "the Sea of Galilee—of Tiberias.") It was in or near the "land of Genesareth" (Matt. xiv, 34, compared with John vi, 17, 21, 24), that is, the rich, busy plain on the west shore of the lake, which we know from the descriptions of Josephus and from other sources to have been at that time one of the most prosperous and crowded districts in all Palestine. See GENESARETH. Yet it was not far from the entrance of the Upper Jordan into the lake (Lightfoot, *Hor. Hebr.* p. 189). Being on the shore, Capernaum was lower than Nazareth and Cana of Galilee, from which the road to it was one of descent (John ii, 12; Luke iv, 81), a mode of speech which would apply to the general level of the spot, even if our Lord's expression, "exalted unto heaven" (*ὑψηλοτέρα*, Matt. xi, 23), had any reference to height of position in the town itself. It was of sufficient size to be always called a "city" (*πόλις*, Matt. ix, 1; Mark i, 88); had its own synagogue, in which our Lord frequently taught (John vi, 59; Mark i, 21; Luke iv, 88, 88)—a synagogue built by the centurion of the detachment of Roman soldiers which appears to have been quartered in the place (Luke vii, 1; comp. 8; Matt. viii, 8). But besides the garrison there was also a customs station, where the dues were gathered both by stationary (Matt. ix, 9; Mark ii, 14; Luke v, 27) and by itinerant (Matt. xvii, 24) officers (though the latter passage probably refers rather to the ecclesiastical or temple tax than to the Roman or secular one). If the "way of the sea" was the great road from Damascus to the south (Ritter, *Erdk.* xv, 839), the duties may have been levied not only on the fish and other commerce of the lake, but on the caravans of merchandise passing to Galilee and Judea. It was also near the border between the tribes of Zebulun and Naphtali (Matt. iv, 18). The doom which our Lord pronounced against Capernaum and the other unbelieving cities of the plain of Genesareth has been remarkably fulfilled. In the present day no ecclesiastical tradition even ventures to fix its site; and the contest between the rival claims of the two most probable spots is one of the warmest, and at the same time the most difficult to decide, in sacred topography.

1. Dr. Robinson (*Bibl. Researches*, iii, 288-294) exposes the errors of all previous travellers in their various attempts to identify the site of Capernaum; and from a hint in Quaresimus, he is rather inclined to look for it in a place marked only by a mound of ruins, called by the Arabs *Khan Minyeh*. This is situated at the north-eastern extremity of the fertile plain (now called El Ghuweir) on the western border of the Lake of Genesareth, to which the name of "the land of Genesareth" is given by Josephus (*War*, iii, 10, 8). This plain is a sort of triangular hollow, formed by the retreat of the mountains about the middle of the western shore. The base of this angle is along the shore, and is about one hour's journey in length, whereas it

takes an hour and a half to trace the inner sides of the plain. In this plain Josephus places a fountain called Capernaum: he says nothing of the town; but if it can be collected from the scriptural intimations that the town of Capernaum was in this same plain (from a comparison of Mark vi, 47, with John vi, 19, it appears that it was at least six miles from the N.E. shore), it may be safely concluded that the fountain was not far from the town, and took its name therefrom. In this plain there are now two fountains, one called 'Ain et-Tin, the "Spring of the Fig," near the northern extremity of the plain, and not far from the lake. It is surrounded by vegetation and overhung by a fig-tree, from which it derives its name. Near this are several other springs, the water of which is said to be brackish; but Burckhardt, who rested for some time under the great fig-tree, describes the water of the main source as sweet. This is the fountain which Dr. Robinson inclines to regard as that which Josephus mentions under the name of Capernaum. M. De Saulcy, however, contends, in his usual confident manner, against the conclusion of Dr. Robinson (*Narrative*, ii, 857-865). In the new edition of his *Researches* (iii, 848), Dr. Robinson reviews the arguments and reaffirms his position. Three miles south, toward the other extremity of the plain, is the other large spring, called 'Ain el Mudaawarah, the "Round Fountain"—a large and beautiful fountain rising immediately at the foot of the western line of hills. This Pococke took to be the Fountain of Capernaum, and Dr. Robinson was at one time disposed to adopt this conclusion. The "Round Fountain" is a mile and a half from the lake, to which it sends a considerable stream with fish. Whichever of these fountains be that of Capernaum, we should look for some traces of an ancient town in the vicinity, and, finding them, should be justified in supposing that they formed the remains of Capernaum. The only ancient remains of any kind near the Round Fountain are some large volcanic blocks strewn over the plain, or piled together with little architectural order. But near the 'Ain et-Tin is the low mound of ruins, occupying a considerable circumference, which, if Capernaum were situated in this plain, offer the best probability of being the remains of the doomed city; and if these be all its remains, it has, according to that doom, been brought low indeed. Near the fountain is also a khan, which gives the name of Khan Minyeh to the spot. This khan is now in ruins, but was once a large and well-built structure. Close on the north of this khan, and of the fountain, rocky hills of considerable elevation come down quite to the lake, and form the northern termination of the plain. It is important to add that Quaresimus expressly states that in his day the place called by the Arabs *Menich* (i. e. Minyeh) was regarded as marking the site of Capernaum (*Elucid. Terr. Sanct.* ii, 864). The mention by Josephus (*Life*, 72) of a village called *Kepharnome*, situated between the mouth of the Jordan and Tarichea, will agree with either location of Capernaum. Willibald, however (*Vita*, 16, 17), passed successively, on his way from Tiberias to the Upper Jordan, through Magdala, Capernaum, Bethsaida, and Chorazin, which would locate Capernaum at the southern end of the plain, if (as appears true) this also contained Chorazin. The latter may have been immediately on the shore, and Capernaum at a little distance from it (Luke ix, 57; comp. Matt. viii, 18, 19), as is the case at the southern spring, but not the northern. The arguments in favor of *Khan Minyeh* may be found in Robinson's *Researches* (new ed. ii, 403 sq.; iii, 844-858). They are chiefly founded on Josephus's account of the fountain and of his visit to Cepharnome, which Dr. R. would identify with the mounds near the khan, and on the testimonies of successive travellers from Arculfus to Quaresimus, whose notices Dr. R. interprets—often, it must be confessed, not without difficulty—in reference to

Khan Minyeh. The fountain Capharnaum, which Josephus mentions (*War*, iii, 10, 8) in a very emphatic manner as a chief source of the water of the plain of Gennesareth and as abounding with fish, would, however, certainly answer better to the "Round Fountain" than to a spring so close to the shore and so near one end of the district as is 'Ain et-Tin. The claim of Khan Minyeh is also strongly opposed by a later traveller (Bonar, p. 437-41), as also by Van de Velde (*Memoir*, p. 301, 302) and Thomson (*Land and Book*, i, 542 sq.). Another objection to the site of Khan Minyeh is that the ancient town of Cinnereth appears to have lain north of Capernaum, and in this same plain of Gennesareth [see CINNERETH]; from which it is most natural to infer that Capernaum lay at the southern end of the plain (at 'Ain el Muda warah), and Cinnereth at the northern ('Ain et-Tin). In that case, the approach of Christ and his disciples to Capernaum through the plain of Gennesareth (Matt. xiv, 84) was from the north, the direction most likely in coming from their last point on the north-eastern shore of the lake; for then the disciples would have fallen short of their destination, owing to the head wind, and, after landing, first traversed the plain. The site of Abu Shusheh, however, is in some respects more likely to have given name to the plain, if that of the ancient Cinnereth, which will thus be distinguished from the localities of Capernaum and Chorazin. See BETHSAIDA.

2. Three miles north of Khan Minyeh is the other claimant, *Tell Hém*, containing ruins (very extensive, according to Bonar, p. 415 sq.) of walls and foundations covering a space of half a mile long by a quarter wide, on a point of the shore projecting into the lake, and backed by very gently rising ground. The shapeless remains are piled up in confusion all along the shore, and are much more striking than those of any other city on this part of the lake. With two exceptions, the houses were all built of basalt, quite black and very compact, but rudely cut. The stones of the temple, synagogue, or church, whatever it may have been, are of beautiful marble, cut from the mountains to the north-west (Thomson, i, 540). The ruins are described by Robinson (*Researches*, iii, 297 sq.). Rather more than three miles farther north is the point at which the Jordan enters the north of the lake. The arguments in favor of Tell Hém date from about 1675. The principal one is the name, which is maintained to be a relic of the Hebrew original—"Caphar" having given place to "Tell." Dr. Wilson also ranges Josephus on this side (*Lands of the Bible*, ii, 189-149). See also Ritter (*Erzk.* xv, 385-343), who supports the same locality, as do also Van de Velde, Bonar, and Thomson. Against Tell Hém, on the other hand, the following arguments seem almost conclusive: (1) It is not near the boundary-line between Zebulun and Naphtali, as appears to be required by Matt. iv, 13. (2) It is not likely to have been on the highway to Damascus (see above), for the mountains are so near the shore as to preclude this, while a thoroughfare still exists through the plain at the south. (3) It is rather too near the head of the lake for the scriptural notices, and apparently in the wrong direction from the plain of Gennesareth. (4) It does not by any means so well suit the indications in Josephus of the position of the spring of Capharnaum and village of Cepharnome: for [1] the latter was near a swampy ground (evidently, from the numerous springs, in the loamy plain), and at no great distance from Tiberias (or, at farthest, Tarichæa); [2] the fountain was a prominent feature in the plain of Gennesareth, which extended along the lake for three miles, apparently midway. To these arguments it may again be replied: (a) The language of the Evangelist respecting the proximity of the boundary-line is not to be taken so strictly, since none of the places in question were really situated on the border. (b) There is room enough for a road along the shore by Tell Hém, for the shortest route to the head of the

lake actually lies through it. (c) The Scripture notices most in question relate to the miracle of the feeding of the five thousand, the scene of which may have been on the shore south-east of Bethesda, beyond Jordan, and in that case Christ's return to Capernaum may have been from the south through the plain of Gennesareth. (d) The misadventure of Josephus may have happened at the mouth of the Upper Jordan, and the place into which he was borne was a "village" merely, not a large city like Capernaum, although the name of the latter may naturally have included adjacent localities, as we know it was extended to the entire plain.

On the whole, therefore, it seems best to decide in favor of Tell Hém as the site of Capernaum, in view of the similarity of name, and the existence of extensive ruins there; and this conclusion is greatly confirmed by the almost certain position of Chorazin at Bir-Kerazeh, a little to the N.W. (See *Journal Sac. Lit.* Oct. 1854, p. 162 sq.; July, 1855, p. 354 sq.; *Bibl. Sacra*, April, 1855, p. 263 sq.; *Lond. Athenæum*, Feb. 24, March 31, 1856; *Stud. u. Krit.* 1867, iv). See CHORAZIN.

CAPERS, WILLIAM, D.D., a bishop of the Methodist Episcopal Church South, was born in St. Thomas's Parish, S. C., Jan. 26, 1790. In 1805 he entered the sophomore class at the South-Carolina College, but left college before the time of graduation, and began the study of law. He entered the itinerant ministry in the South-Carolina Conference in 1809, and located in 1815. He was readmitted to the Conference in 1818, and was first elected to General Conference in 1820, and was sent as delegate from the American Methodist Church to the British Wesleyan Conference in 1828. His subsequent posts of duty were, professor of Evidences of Christianity in Columbia College, 1835; editor of the Southern Christian Advocate, 1836-40; missionary secretary of the southern division of the Methodist Episcopal Church, 1840-44; superintendent of colored missions in the Southern States in 1844. In May, 1844, Dr. Capers attended the General Conference held at New York as one of the delegates of the South-Carolina Conference. This was the year in which the great anti-slavery agitation in the Methodist Episcopal Church came to its crisis in the division of that body. Dr. Capers took the Southern view of the question, and from that time till the close of his life he was identified with the Methodist Episcopal Church South. At the General Conference of that Church held in 1844 he was elected bishop. The remainder of his life was spent in the discharge of the bishop's office, which he filled with pre-eminent dignity, diligence, and success. Dr. Capers came of a Huguenot family, and his father did gallant service in the Revolution. His house was one of the homes of Asbury and the early Methodist preachers. In the ministry his rise was rapid, and his usefulness and popularity constantly increased. His eloquence in the pulpit was sanctified by the unction of the Holy Ghost, and, though generally smooth and graceful, was at times powerful, and even overwhelming. He was always refined and elevated in thought and life, and labored with earnest fidelity for his Master's cause. His activity of mind and perseverance, together with the weight of his moral power, gave him great influence in his Conference and in the Church. He died in Anderson, S. C., Jan. 29, 1855. He left no literary remains except an autobiography (prefixed to Dr. Wightman's *Life of Capers*); *Catechisms for the Negro Missions*; *Short Sermons and True Tales for Children* (edited by Dr. Summers, Nashville, 18mo).—Summers, *Sketches of Eminent Itinerants*, p. 75; Wightman, *Life of W. Capers, D.D.* (Nashville, 1859, 12mo); Sprague, *Annals*, vii, 460.

Cape Town, the capital of the English possessions at the Cape of Good Hope, erected into a bishop's see of the English Church in 1847. The see owes

its existence to the munificence of Miss Burdett Coutts. The first bishop was Robert Gray, D.D., of Stockton, consecrated at Westminster, June 29, 1847, who is still the incumbent. The bishop of Cape Town is the metropolitan of the Anglican dioceses in South Africa, of which, in 1867, there were the following, besides Cape Town: Natal, established 1868; Mauritius, 1854; Graham's Town, 1856; St. Helena, 1862; Orange River State, 1863; Central Africa, 1863. The Wesleyan missions in the district of Cape Town embraced, in 1866, 10 circuits, 25 chapels, 12 other preaching-places, 9 missionaries and assistant missionaries, 201 subordinate paid and unpaid agents, 1510 members, 211 on trial for membership, 2680 scholars in Sunday-schools, and 6988 attendants on public worship. The Roman Catholics have at Cape Town a vicar apostolic (bishop in partibus), whose diocese embraces about half a dozen churches.—Landon, *Ecol. Dict.* ii, 560. See AFRICA.

Caphar- (the Latinized form of the Heb. prefix קָפַר, *Kefar*, the "construct form" of קָפַר, from the root of the same form signifying "to cover," Gesenius, *Thesaur.* p. 707), one of the numerous words employed in the Bible (and still oftener in later or rabbinical Hebrew) to denote a village or collection of dwellings smaller than a city (Reland, *Palæst.* p. 516). See *Id.*—Stanley proposes to render it by "hamlet" (*Palæst. App.* § 87), to distinguish its occurrences from those of *Chavvah*, *Chater*, *Bayith*, and other similar words. As an appellative it is found only three times: 1 Chron. xvii, 25, Cant. vii, 11, and 1 Sam. vi, 18 (in the last the pointing being different, *Ko'pher*, קֹפֶר); but in neither is there anything to enable us to fix any special force to the word. In names of places, it occurs in CHEPHAR-AMMONAI, CHEPHIRAH, CAPHAR-SALAMA, and those here following; also CAPHARNAUM, CAPHARCOTIA, etc. But the number of places compounded therewith mentioned in the Talmud shows that the name became a much commoner one at a time subsequent to the Biblical history. See the words beginning with KEFHAR-. In Arabic, the corresponding local epithet *Kefr* is in frequent use (see the lists in Robinson's *Researches*, iii, Append.).—Smith, s. v.

Capharäbis (Καφαραβίς), a town of Idumæa, with a very strong wall, surrendered by the citizens to Cerealis, the general of Vespasian, after a siege thus rendered unexpectedly short (Josephus, *War*, iv, 9, 9). Reland (*Palæst.* p. 684) thinks it the *Kefar-Bish* (q. v.) of the rabbins; but Schwarz refers it to the *Kefar-Abus* (כַּפַּר אַבּוּס) of the Jerusalem Talmud (*Sanhedr.* ii), and finds it in the well near Gedor, in Wady Surar (meaning apparently that marked on Van de Velde's *Map* a little south-east of Ekron), which he says is still called "the Spring of Abis." This position, however, seems too northerly.

Caphârath. See KEFHAR-ÄKKO.

Capharbartöcha (prob. for כַּפַּר בְּרֵכָה, *village of blessing*; but different from the "valley of blessing" [see BERACHAH], named in 2 Chron. xx, 26), a place mentioned by Jerome (*Ep.* 86) as overlooking the desert of Sodom, and traditionally held to be the place where Abraham interceded with Jehovah for the guilty cities of the plain (Gen. xviii, 16; xix, 28). The name also occurs (in various forms) in several other ancient notices (Reland, *Palæst.* p. 685). It is probably the modern *Benj Naim*, an eminence on very high ground, three or four miles east of Hebron, commanding an extensive view of the Dead Sea (Robinson, *Researches*, ii, 189). The tomb of Lot has been shown there since the days of Mandeville (*Trav.* p. 68).

Capharcotia. See CAPHARCOTIA.

Caphardagon. See BETH-DAGON.

Caphareocho. See KEFHAR-ÄKKO.

Capharetæa, a village of Samaria, the native place of the heretic Menander, according to Justin

Martyr (Καπαρηταί, *Apol.* ii), but Eusebins (*Ecol. Hist.* iii, 26) cites the name somewhat differently (Καπαρταία), and Theodoret (*Compend. Hæret. Fab.* ii) has *Chabra* (Χαβρα); so that the place is altogether doubtful.

Caphargamäla (prob. *village of the camel*), a village said to have been situated 20 miles from Jerusalem; the native place of the presbyter Lucian, who wrote the memoir concerning the remains of St. Stephen, about the fifth century (Reland, *Palæst.* p. 688); but thought by Cotovicus (*Itin.* p. 284) to be the name of a person. See CAPHARSALAMA.

Capharnätum. See CAPHARNAUM.

Caphararia. See CAPHARORSA.

Capharorsa, a place (Καπαρόρσα for Καπαρόρσα) named by Ptolemy as a town of Idumæa west of the Jordan, and thought by Reland (*Palæst.* p. 690) to be the *Caphararia* (or *Ceperaria*) placed in the *Peutinger Table* between Jerusalem and Ashkelon. See CEPERARIA. It is possibly the same with CAPHAR-ZACHARIA (q. v.).

Capharsäba. See ANTIPATRIS.

Capharsaläma (Καφαρσαλαμά v. r. Καφαρσαλαμά, appar. for כַּפַּר שָׁלוֹם, "village of peace"), a place where Nicanor's troops were cut to pieces by Judas Maccabæus (1 Macc. vii, 81). Josephus, in the parallel account (*Ant.* xii, 10, 4), calls it a village (κώμη Καφαρσαλαμά). Reland suggests (*Palæst.* p. 690) that it may have been the same with the *Caphar Gamala* (q. v.) where the presbyter Lucian was born, or the *Caphar-semelia* mentioned in his writings. He also adduces an allusion from the Talmud (*Aboda Sara*, folio 44, col. 4) to a wine-growing village, *Kefar-Salam* (כַּפַּר שָׁלוֹם), doubtless the same. From the fugitives in the above battle having taken refuge in the "city of David," it would appear to have been near Jerusalem; hence it is possible that it was the village near *Siloam* (q. v.), the Arabic name of which is *Kefr-selwân*. Ewald places it north of Ramla, on the Samaritan boundary (*Gesch. Isr.* iv, 368, note), but this is quite arbitrary.

Caphar-Sorech. See SOREK.

Caphartöba. See KEFHAR-TEBI.

Caphar-Zachariæ ("village of Zacharias"), a place mentioned by Sozomen (*Hist. Ecol.* ix, 17) as lying in the region of Eleutheropolis, and apparently visited by Willibald on his way from Gaza to Hebron (*Travels*, p. 20, Bohn). It seems to have been different from the Bath-Zacharias (q. v.) of the Apocrypha (1 Macc. vi, 82) and Josephus (*Ant.* xii, 9, 4). It is probably the modern *Kefr Zekaria* (Robinson, *Researches*, ii, 84), a village on the north side of Wady Surot, opposite Tell Zacharia, about half way between Jerusalem and Ashkelon (Van de Velde, *Narrative*, ii, 192). See CAPHARORSA.

Caphen'atha (Καφενάθα), a place apparently close to and on the east side of Jerusalem, which was repaired by Jonathan Maccabæus (1 Macc. xii, 87). The name seems to be derived from כַּפְתִּינָה, *kaph-nitha*, the Chaldee word for the *unripe date* (Buxtorf, *Lex. Talm.* col. 1071), and thus has a remarkable correspondence with the names of Bethany (house of dates), Bethphage (house of figs), and of the Mount of Olives itself, on which the three were situated—all testifying to the ancient fruitfulness of the place (comp. Schwarz, *Palæst.* p. 256).

Caphëthra (Καφεθρά), a pretentious little town (ψευδοπολίτευον) in Upper Idumæa, apparently not far from Capharabis (q. v.), taken and burnt by Cerealis, the general of Vespasian (Josephus, *War*, iv, 9, 9). The name occurs with considerable variety in the texts (Καφεθραμίς, etc., Hudan, in loc.), and Petrus Apollonius (*De excid. Hieros.* iii, 65) gives it simply

as *Caphira*, from which it seems possible that the scriptural **CHAPHIRAH** (q. v.) may be intended.

Caph'ra (*Καφίρα*), a place whose inhabitants returned from Babylon (1 Esdr. v, 19); evidently the **CHAPHIRAH** (q. v.) of the Hebrew text (Ezra ii, 26).

Caph'thorim (1 Chron. i, 12). See **CAPHTORIM**.

Caph'tor (Heb. *Kaph'tor*, קַפְתּוֹר in Deut.), a *chaplet*, as in Amos ix, 1, etc.; Sept. *Καππαδοκία*, Vulg. *Cappadocia*, a maritime country thrice mentioned as the primitive seat of the Philistines (Deut. ii, 23; Jer. xlvii, 4; Amos ix, 7), who are once called **Caphtorim** (Deut. ii, 23), as of the same race as the Mizraite people of that name (Gen. x, 14; 1 Chron. i, 12). There has been a great diversity of opinion with regard to the exact situation of that country (see *Simonis, Oson. V. T. p. 441*). See **CAPHTORIM**.

1. The general opinion that **Caphtor** was *Cappadocia* (not the city *Cappadocia*, or *Caphtora* in Phœnicia, see *Schultz, Leit. v, 466*) is, upon the whole, founded more on the ancient versions of the Bible, such as the Septuagint and the Targums, than on any sound argument (see *Bochart, Phaleg, iv, 82*; *Miller, Syntagm. Hermeneut. p. 167 sq.*; *Strauss, ad Zephaniak, p. 47*). Against this opinion have been urged: (1) The authority of *Josephus (Ant. i, 6, 2)*, who seems to seek **Caphtor** somewhere between *Egypt* and *Ethiopia*; (2) that the **Caphtorim** came originally from *Egypt*, from which *Cappadocia* is so far removed that it seems highly improbable that an *Egyptian* colony should first have emigrated thither, and then again removed to *Palestine*, still more remote; (3) that **Caphtor** and *Cappadocia* are very dissimilar names (but see *Heeren in the Comment. Soc. Gott. xiii, 33*; *Jablonsky, Opusc. iii, 1 sq.*; *Gesenius, Thesaur. p. 709*; *Köster, Erläuter. p. 157 sq.*) even in sound; (4) that **Caphtor** is (Jer. xlvii, 4) designated as an island (כִּפְתּוֹר), though כִּפְתּוֹר sometimes also signifies a coast. See **CAPPADOCIA**.

2. Others again, as *Calmet (Dissert. sur l'Origine des Philistins, p. 321)*, and still more *Lackemacher (Ober. Phil. p. 2, 11 sq.)*, have tried to prove that the **Philistines** derived their origin from the island of *Crete* (so *Rosenmüller, Alterth. II, ii, 368*; *iii, 385*; *Movers, Phön. i, 28*; *Lengerke, Ken. i, 194*; *Ewald, Gesch. Isr. i, 380*; *Tuch, Gen. p. 243*; *Hitzig, Zu Zeph. ii, 5*; *Bertheau, Isr. Gesch. p. 187*; *Knobel, Gen. p. 110*; *Delitzsch, Gen. p. 290*; *Fürst, Handb. s. v.*), because—(1) **Caphtor** is with *Jeremiah* an island; (2) the proper name of the **Philistines** is כִּרְתִּים, *Kerethim*, "Cherethites" (*Ezek. xxv, 16*; *Zeph. ii, 5*; 1 Sam. x, 14); (3) a city *Aptera* existed in *Crete* (*Strabo, x, 479*; *Pliny, iv, 20*). The *Sept.*, however, evidently makes a distinction between the **Caphtorim** and **Cherethim**; nor is it probable either that a small island like *Crete* should be able to send forth thus early so large a body of emigrants as must have landed on the territories of the *Avim*, so as to be able to expel them and take possession of their country, or that the *Phœnicians* would allow a seafaring race like the *Cretons* to settle in their vicinity (see *Höck, Kreta, p. 367*). See **CRETES**.

3. By far more probable is *Calmet's* previous opinion (found in the first edition of his *Comment. on Genesis*, but which he afterward recalled), that **Caphtor** is the island of *Cyprus*. From the geographical situation of that island, it may have been known to the *Egyptians* at a very early period, and they may have sent colonies thither, who afterward removed, from some reason or other, to the southern coast of *Palestine* bordering on *Egypt*. *Swinton (Inscr. Cũ. Oxon. 1760, p. 78, 86)* actually found on that island an ancient *Phœnician* coin, with the inscription which he read "Kaddor" (כַּדְדוֹר), not very unlike **Caphtor**; but in the *Allgemeine Lit. Zeitung (Leips. 1825, i, 440)* it has been proved that *Swinton* was mistaken in the reading of that inscription (see *Gesenius, Mon. Phœn. ii, 320*). Opposed to this identification also is the fact that the

Cyprians are elsewhere (Gen. x, 4) called **Chittim** (q. v.). See **CYPRUS**.

4. A still more probable identification is with certain parts of *Egypt*: either (1) the coast of the *Egyptian Delta* (*Stark, Gaza, p. 76*); (2) *Damietta* (*Saadias, Arab. Vers.*, which has "Dimyat"; *Haine, Obs. Sac. ii, 6, 10*); or (3) part of *Morocco* west of *Egypt* (*Quatremère, Jour. des Savans, 1846, p. 265*). The position of the country, since it was peopled by *Mizraites*, may naturally be supposed to be in *Egypt*, or near to it in *Africa*, for the idea of the south-west of *Palestine* is excluded by the migration of the *Philistines*. In *Jer. xlvii, 4*, the expression כִּפְתּוֹר אִי ("country of **Caphtor**") has a wider signification than an insular location; for the term אִי denotes any maritime land, whether coast or island, as in the expression *Gentile shores* (אִי הַגּוֹיִם), Gen. x, 5), by which the northern coasts and the islands of the *Mediterranean* seem to be intended, the former, in part at least, being certainly included. It must be remembered, however, that the *Nile* is spoken of as a sea (ים) by *Nahum* in the description of *No*, or *Thebes* (iii, 8). It is also possible that the expression in *Jer.* merely refers to the maritime position of the *Philistines* (comp. *Ezek. xxv, 16*), and that **Caphtor** is here poetically used for **Caphtorim**. *Forster (Epist. ad Michael. p. 17 sq.)* thinks that the **Caphtorim** had lived on the *Egyptian* coast, somewhere about *Damietta* (comp. *Benjamin of Tudela, p. 121, Bohn*). From hence he supposes a colony of that people, and their brethren and easterly neighbors, the *Casluhim*, had gone forth, in the period between the first wars of the world (described in Gen. xiv) and the birth of *Isaac*, and settled on the southern coast of *Palestine*, under the name of *Philistines*, after having expelled the *Avim* (q. v.), who lived about *Gaza*. But in subsequent times, *Forster* thinks, these new *Philistines* had again sent a colony who conquered the province of *Lapethus*, in the island of *Cyprus*. This colony he identifies with the *Ethiopian*s, who lived, according to *Herodotus* (vii, 88), upon the island. "Following out these suggestions, *Reginald Stuart Poole* (in the *Encyclopædia Britannica*, 8th ed., article *Egypt, p. 419*), after a conjecture in *Heinii Dissert. Sacr. p. 210 sq.*, has proposed to recognise **Caphtor** in the ancient *Egyptian* name *Coptos* (Κοπτός), which, if literally transcribed, is written in the hieroglyphics *Kebsu*, probably pronounced *Kubi* (*Brugsch, Geogr. Inscr. pl. xxxviii, No. 899, 900*), whence *Coptic Kepto*, Arab. *Kufi*. The similarity of name is so great that it alone might satisfy us, but the correspondence of *Αἰγυπτος*, as if *Ala γυπτος*, to כִּפְתּוֹר, unless אִי refer to the *Philistine* coast, seems conclusive. We must not suppose, however, that **Caphtor** was *Coptos*: it must rather be compared to the *Coptite* nome, probably in primitive ages of greater extent than under the *Ptolemies*, for the number of nomes was in the course of time greatly increased. The **Caphtorim** stand last in the list of the *Mizraite* peoples in *Gen.* and *Chron.*, probably as dwellers in *Upper Egypt*, the names next before them being of *Egyptian*, and the earliest names of *Libyan* peoples. See **EGYPT**.

"The migration of the *Philistines* is mentioned or alluded to in all the passages speaking of **Caphtor** or the **Caphtorim**. It thus appears to have been an event of great importance, and this supposition receives support from the statement in *Amos*. In the lists of *Gen.* and *Chron.*, as the text now stands, the *Philistines* are said to have come forth from the *Casluhim*—'the *Casluhim*, whence came forth the *Philistines* and the **Caphtorim**'—where the *Heb.* forbids us to suppose that the *Philistines* and **Caphtorim** both came from the *Casluhim*. Here there seems to have been a transposition, for the other passages are as explicit, or more so, and their form does not admit of this explanation. The period of the migration must have been very remote,

since the Philistines were already established in Palestine in Abraham's time (Gen. xxi, 32, 34). The evidence of the Egyptian monuments, which is indirect, tends to the same conclusion, but takes us yet farther back in time. It leads us to suppose that the Philistines and kindred nations were cognate to the Egyptians, but so different from them in manners that they must have separated before the character and institutions of the latter had attained that development in which they continued throughout the period to which their monuments belong. We find from the sculptures of Rameses III at Medinet Abû that the Egyptians, about 1200 B.C., were at war with the Philistines, the Tok-karu, and the Shayratana of the Sea, and that other Shayratana served them as mercenaries. The Philistines and Tok-karu were physically cognate, and had the same distinctive dress; the Tok-karu and Shayratana were also physically cognate, and fought together in the same ships. There is reason to believe that the Tok-karu are the Carians, and the Shayratana have been held to be the Cherethim of the Bible and the earlier Cretans of the Greeks, inhabiting Crete, and probably the coast of Palestine also (*Encyclop. Brit.* s. v. Egypt, p. 462). All bear a greater resemblance to the Egyptians than does any other group of foreign peoples represented in their sculptures. This evidence points, therefore, to the spread of a seafaring race cognate to the Egyptians at a very remote time. Their origin is not alone spoken of in the record of the migration of the Philistines, but in the tradition of the Phœnicians that they came from the Erythrean Sea [see ARABIA], and we must look for the primæval seat of the whole race on the coasts of Arabia and Africa, where all ancient authorities lead us mainly to place the Cushites and the Ethiopians. See CUSH. The difference of the Philistines from the Egyptians in dress and manners is, as we have seen, evident on the Egyptian monuments. From the Bible we learn that their laws and religion were likewise different from those of Egypt, and we may therefore consider our previous supposition as to the time of the separation of the peoples to which they belong to be positively true in their particular case. It is probable that they left Caphtor not long after the first arrival of the Mizraite tribes, while they had not yet attained that attachment to the soil that afterward so eminently characterized the descendants of those which formed the Egyptian nation. The words of the prophet Amos (ix, 7) seem to indicate a deliverance of the Philistines from bondage. The mention of the Ethiopians there is worthy of note: they are perhaps spoken of as a degraded people. The intention appears to be to show that Israel was not the only nation which had been providentially led from one country to another where it might settle, and the interposition would seem to imply oppression preceding the migration. It may be remarked that Manetho speaks of a revolt and return to allegiance of the Libyans, probably the Lehabim, or Lubim, from whose name Libya, etc., certainly came, in the reign of the first king of the third dynasty, Necherôphés or Necherôchis, in the earliest age of Egyptian history, B.C. cir. 2800 (Cory, *Anc. Frag.* 2d ed. p. 100, 101) (Smith, *Dict.* s. v.). See PHILISTINE.

Caph'torim (Heb. *Kaph'torim*, קַפְתֹּרִים; Gen. x, 14, Sept. Γαφθορείμ, Vulg. *Caph'torim*; Deut. ii, 23, Καπθάρδοες, *Cappadoces*, A. V. "Caphtorims;" 1 Chron. i, 12, Χαφορείμ v. r. Καφθορείμ, *Caph'thorim*, "Caphtorim"), the inhabitants of CAPHTOR (q. v.).

Capistranus, JOHANNES (*Giovanni de Capistrano*), a Franciscan, was born at Capistrano, in the Abruzzi, June 23, 1385. Political troubles, during which he was imprisoned, led him to quit the world, and to assume the Franciscan habit. He led a life of extreme austerity, sleeping only three hours a day, and eating but once daily, without touching flesh, for thirty-six years. He was made Inquisitor at Rome, especially against the

Fratricelli (q. v.); and Cave states that, "heading the army of Crusaders, as they were called, he endeavored to root out heresy by fire and sword, and actually burned to the ground eighty-six villages of the Fratricelli in Campania." Pope Eugenius IV sent him in 1439 as nuncio to Sicily, and employed him at the Council of Florence in seeking to effect a union between the Greek and Latin Churches. In 1448 Nicholas V sent him on a crusade into Bohemia and Hungary against the Hussites. After this he stirred up a crusade against the Turks, and in 1456, putting himself at the head of 100,000 men, raised for the relief of Belgrade, then besieged by Mohammed II, he carried the standard in the very foremost of the fight, and obtained a complete victory. He died Oct. 23, 1456, at Villach, in Carinthia. Alexander VII beatified him in 1690, and he was canonized by Benedict XIII in 1724. Among his works are: (1.) *De papa et conciliis, sive Ecclesie, auctoritate*, against the Fathers of Basle (Venice, 1580, 4to); and in the *Tractatus Juris* (Ibid. 1584, tom. xiii, pt. i, p. 82);—(2.) *Speculum clericorum*;—(3.) *Speculum conscientiarum*;—(4.) *De Canone penitentiali* (all three in the *Tract. Jur.*);—(5.) *De Ecclesiasticatione; Matrimonio; Judicio Universale; Antichristo*, etc.—Cave, *Hist. Lit.* vol. ii, App. p. 153; Hoefer, *Nouv. Biog. Générale*, viii, 580; Baillet, *Vies des Saints*, 23 Oct.; Gieseler, *Ch. History*, period iii, § 132; Wetzer u. Welte, *Kirchen-Lexikon*, ii, 324.

Capitation or POLL-TAX, among the Jews. Moses ordained (Exod. xxx, 18) that every Israelite should pay half a shekel for his soul, or person, as a redemption, "that there might be no plague among the people, when they were numbered." Many interpreters are of opinion that this payment was designed to take place as often as the people were numbered; and that this payment of the half shekel per head being evaded when David numbered his subjects, God punished the neglect with a pestilence (2 Sam. xxiv, 1). But it is more generally thought that Moses laid this tax on all the people, payable yearly, for the maintenance of the tabernacle, for the sacrifices, wood, oil, wine, flour, habits, and subsistence of the priests and Levites. In our Saviour's time the tribute was punctually paid. See DIDRACHMA. The Israelites, when returned from Babylon, paid one third part of a shekel to the Temple, being disabled, probably, at that time, by poverty, from doing more (Nehem. x, 32). The rabbins observe that the Jews in general, and even the priests, except women, children under thirteen years of age, and slaves, were liable to pay the half shekel. The collectors demanded it in the beginning of Nisan, but used no compulsion till the Passover, when they either constrained its payment or took security for it. After the destruction of the Temple, the Jews were compelled to pay the half shekel to the temple of Jupiter Capitolinus.—Calmet. See ASSESSMENT.

Capito, WOLFGANG FABRICIUS, an eminent coadjutor of Ecolampadius and Bucer in the Reformation, was born at Hagenau in 1478, studied medicine, and afterward theology, and became D.D. at Freiburg, 1506. His father's name was Köpfstein, and he was a blacksmith, whence the name Fabricius. For a while he was lecturer in the University of Freiburg, and in 1512 he became parish priest at Bruchsal, where he studied Hebrew with a converted Jew, made the acquaintance of Ecolampadius, and was led to the study of Luther's writings. Called to the cathedral at Basle, he there became intimate with Erasmus; and in his lectures to the students on Romans he showed reformatory tendencies. In 1520 he became chaplain to Albrecht, elector and archbishop of Mayence, whom he defended, gently, against one of Luther's attacks, on account of the traffic in indulgences. Luther (Jan. 17, 1522) sharply rebuked Capito as a time-server. Stung, and perhaps convicted, Capito abandoned Mayence (1523), and took up a prebend there which Leo X had

given him. At Strasburg Capito's prudence led him to moderate the zeal of Zell and other reformers; but he soon became himself ardent and earnest in the cause. From that time on he was one of the most efficient of all the coadjutors of Luther. In 1524 he married. In 1530 he took part in preparing the *Confessio Tetrapolitana* (q. v.). His timidity, however, often drew on him the reproaches of Luther. In 1535 he had an interview with Calvin, at which he endeavored to bring about such a modification of the Genevan views on the subject of the Lord's Supper as might lead to a better understanding with the Lutherans. He died of the plague in 1541. He wrote many works, among them a *Vita Ecolampadii, Enarrationes in Habacuc et Hoseam* (Strasb. 1526 and 1528), and *Responsio de missâ, matrimonio et jure magistratus in religionem* (1537). Capito was a very learned man, and was in advance of his contemporaries also in toleration. See Baum, *Capito und Butzer, Strasburg's Reformatoren* (8d vol. of *Leben und ausgewählte Schriften der Väter der reform. Kirche* [Elberfeld, 1860]); Adami, *Vit. Theolog.* 41; Herzog, *Real-Encyclopädie*, ii, 561; Middleton, *Evangelical Biography*, i, 147; *Biblioth. Sacra*, Jan. 1861.

Capitularies (*capitula*, chapters), a term applied especially to the statutes of the Frankish kings made in the assemblies of bishops and lords of the kingdom, and called *capitula* because published in chapters. The bishops reduced into the form of articles such rules as they deemed necessary, taken for the most part from the canons. The temporal lords also drew up on their part ordinances taken from the civil laws and customs, which the king afterward ratified and confirmed. These capitularies were in force throughout the kingdom. Those best known are the capitularies of Charlemagne and Louis le Debonnaire, which were first collected by Ansegis (q. v.) A.D. 827. The work is divided into four books, to which, about 845, Benedict, a deacon of Mayence, added some which Ansegis had omitted, together with the capitularies of Carloman and Pepin. In the eighth and following centuries, bishops were accustomed to give the names of capitularies to the rules which they drew up from the canons of councils for the regulation of their dioceses. Such capitularies had no force beyond the particular diocese for which they were made, except they were confirmed by a provincial synod, which made them binding on the whole province. Other prelates, however, sometimes adopted the capitularies of particular bishops. An edition of the early capitularies was printed by Baluze (Paris, 1677, 2 vols. 4to), reprinted and re-edited by Chiniac, 1780; the latest and best edition is found in Pertz, *Monum. Germ. Hist. (Legum)*, t. i, ii (Hanover, 1835-1837).—Farrar, *Ecol. Dict.* s. v.; Herzog, *Real-Encyclopädie*, ii, 563.

Capnia. See REUCHLIN.

Cappadocia (*Καππαδοκία*, explained by Herod. vii, 72, as Persic, and lately thought by Lassen to be found on inscriptions in the form *Katpadukla*; but Beufey, *Monatzenamen*, p. 117, interprets as *Kappadakja*, "province of good horses"), an ancient and the easternmost province of Asia Minor, bounded on the north by Pontus, on the east by the Euphrates and Armenia Minor, on the south by Mount Taurus (beyond which are Cilicia and Syria), and on the west by Phrygia and Galatia (Strabo, xii, p. 533 sq.; Ptolemy, v, 6; Pliny, vi, 8). The country is mountainous and abounds in water, and was celebrated for the production of wheat, for its fine pastures, and for its excellent breed of horses, asses, and sheep (Strabo, xii, 539; Solin. 47). The inhabitants were notorious for their dulness and vice (Isidor. Pelus. i, 281; iv, 197; Justin. xxxviii, 2; comp. Porphyrog. *Them.* i, 2). They were called "Syrians" (comp. Jablonsky, *De lingua Lyconum* in his *Opusc.* iii, 1 sq.; Gesen. *Mon. Phœn.* p. 11) in the age of Herodotus (i, 72; v, 49), and even in Strabo's days they bore the name of *Λευκόστροφαι*, or "White

Syrians" (xii, p. 544), in contradistinction to those dwelling beyond the Taurus, whose complexion was darkened by the sun (Strabo, xvi, 787). By the ancient interpreters (see Philo, *Opp.* ii, 676) they were thought to be meant by "the land of Caphtar" (q. v.); but the ancient name of Cappadocia was *Καπαδοκία* or *Katapatuka* (Rawlinson, *Journ. of the Asiat. Soc.* xi, 1, 96). Cappadocia was subjugated by the Persians under Cyrus, but after the time of Alexander the Great it had kings of its own, although tributary to the Seleucidæ. Its geographical limits on the west and north were variable. In early times the name reached as far northward as the Euxine Sea. The region of Cappadocia, viewed in this extent, constituted two satrapies under the Persians, and afterward two independent monarchies. One was Cappadocia on the Pontus, the other Cappadocia near the Taurus. Here we have the germ of the two Roman provinces of Pontus and Cappadocia. See PONTUS. Several of the monarchs who reigned in Cappadocia Proper bore the name of Ariarathes (q. v.). One of them is mentioned in 1 Macc. xv, 22. The last of these monarchs was called Archelaus (see Joseph. *Ant.* xvi, 4, 6). He was treacherously treated by the emperor Tiberius, who reduced his kingdom to a province A.D. 17, including what was anciently called Lesser Armenia (Tacit. *Ann.* ii, 42; Dio Cass. lvii, 17). Christianity was very early propagated in Cappadocia, for the apostle Peter names it in addressing the Christian churches in Asia Minor (1 Pet. i, 1). Cappadocians (prop. *Καππαδοκίαι*, also *Καππαδοκίαι*) were present at Jerusalem on the day of Pentecost (Acts ii, 9). The Jewish community in this region doubtless formed the nucleus of the Christian; and the former may probably be traced to the first introduction of Jewish colonists into Asia Minor by Seleucus (Josephus, *Ant.* xii, 3, 4). The Roman period, through the growth of large cities and the construction of roads, would afford increased facilities for the spread both of Judaism and Christianity. It should be observed that Cappadocia was easily approached from the direction of Palestine and Syria by means of the pass called the Cilician Gates, which led up through the Taurus from the low coast of Cilicia, and that it was connected, at least under the later emperors, by good roads with the district beyond the Euphrates (see *Penny Cyclopædia*, s. v.; Smith, *Dict. of Class. Geogr.* s. v.). See ASIA MINOR.



Coin of Cappadocia.

Cappadocia was one of the seven provinces assigned to the diocese of Pontus, at its erection, by Constantine the Great and Constantius. Under the emperor Valens the province of Cappadocia was divided into the provinces of Cappadocia Prima and Secunda, which last was by the emperor Justinian subdivided, the new province being styled Cappadocia Tertia, and having for its metropolitan see Mociussa, or, as it was thenceforward styled, Justinianopolis. The chief see of the second Cappadocia was Tyana, and of the first, Cæsarea, which last church was the mother and head of the whole Pontic diocese. See CÆSAREA.

Cappel (CAPPELLUS), Jacques, a learned French Protestant divine, was born at Rennes in March, 1570, of an ancient and honorable family, which produced many theologians, jurists, and statesmen in the fifteenth, sixteenth, and seventeenth centuries. He became pastor at Sedan, and in 1599 professor of Hebrew at the academy there, and afterward of theology, which post he held until his death, September 7, 1624. Among his numerous writings are, *Les Livres*

du Babel, ou l'histoire du Siège Romain (Sedan, 1616, 8vo); *Historia Ecclesiastica Centuria quinque* (Sedan, 1622, 4to). After his death appeared his *Observationes in N. T. exceptis Act. et Apocalypsa. procurante fratre Ludovico Cappello* (Amst. 1677, 4to):—*Observationes in libros Vet. Test.* (in L. Cappel's *Commentarii*, Amst. 1689, fol.). A list of his works is given by Nicéron, xxii, 405.—Hoefler, *Nouv. Biog. Générale*, viii, 615; Haag, *La France Protestante*, s. v.

Cappel (CAPPELLUS), Louis, younger brother of the foregoing, was born near Sedan, October 15, 1585. In 1609 the church in Bordeaux provided funds for him, and he spent four years in travel and study in England, Belgium, and Germany. In 1618 he became professor of Hebrew, and in 1633 (with Amyraldus and Placcus) was professor of divinity at Saumur. He was a pious Christian, a most learned theologian, and a thorough Protestant in a time of great trial. Besides his theological and exegetical writings, he is chiefly memorable for his controversy with Buxtorff concerning the antiquity of the vowel points. His view was published in his *Arcanum punctationis revelatum* (1623; reprinted in the appendix to his *Comm. et Nota Critica*, Amst. 1689). It was, that these points were invented by the Jews of Tiberias some six hundred years subsequently to the death of Christ; whereas Buxtorff held them to be coeval with the language. The opinion of Cappellus has since been generally received. His greatest work was the *Critica Sacra*, containing, among many other learned and valuable dissertations, a collection of various readings and errors which had crept into the text of the Bible. He was occupied thirty-six years upon this work, which the Protestants so much disliked that they hindered the impression of it, and it was not given to the public until 1650, when John, his son, who joined the communion of the Church of Rome, obtained leave of the king to print it. Buxtorff (the son) criticised it sharply, and also bitterly attacked Cappellus for his theory of the vowel points in his *Tractatus de Punctorum Origine*, etc. (Basel, 1648; 8d part 1651, 4to). Cappellus replied in a *Iusta defensio* (printed in later editions of the *Critica Sacra*). He farther published, on the text of the O. T., *Diatriba de veris et Antiquis Ebraeorum literis* (Amst. 1645, 12mo), in reply to Buxtorff. A new edition of the *Crit. Sac.* appeared at Halle (1775–86) in 8 vols. 8vo. In 1610 he visited Oxford. He died at Saumur, June 16, 1658. Among his other works are, *Historia Apostolica illustrata* (Geneva, 1634, 4to); and in the London edition of the *Critica Sacra*, 1660):—*Spicilegium post messem*, a collection of criticisms on the New Testament (Geneva, 1632, 4to):—*De critica nuper a se edita ad Rev. virum D. Jacob. Usserium, Armacenum in Hibernia Episcopum, Epistola Apologet.* (Salm. 1651, 4to):—*Commentarii et Nota Critica in Vet. Test.* (Amst. 1689, fol.). A full list is given by Haag, *La France Protestante*, iii, 199; in Nicéron, vol. xxii; and also in the edition, by his son, of his *Comment. et Nota Critica in V. T.* (Amst. 1689, fol.), which also gives biographical sketches, under the title *De Cappellorum Gene*, of the distinguished members of the Cappel family. His Correspondence with Usher is given in Parr's Collection of Usher's Letters. He also wrote *Chronologia Sacra* (1655, 4to), reprinted among the prolegomena of Walton's Polyglot.—Hoefler, *Nouv. Biog. Générale*, viii, 615; Herzog, *Real-Encyclopädie*, ii, 566.

Captain is the rendering, in the Auth. Vers., of numerous Heb. and several Greek words, of which the following only require special elucidation. For the קָרַי, *kari'*, rendered "captains," 2 Kings xi, 4, 19, see CHERETHITES.

(1.) As a purely military title, captain answers to קָרַי, *sar*, in the Hebrew army, and χιλιαρχος (*tribunus*) in the Roman. See ARMY. The "captain of the guard"

(στρατοπεδάρχης) spoken of in Acts xxviii, 16 was the Prætorian præfect. See CHRONOLOGY, p. 812, b.

(2.) קָרַי, *katsin'*, which is occasionally rendered captain, applies sometimes to a military (Josh. x, 24; Judg. xi, 6, 11; Isa. xxii, 3; Dan. xi, 18), sometimes to a civil command (e. g. Isa. i, 10; iii, 6): its radical sense is *division*, and hence *decision* without reference to the means employed: the term illustrates the double office of the שֹׁפֵט, *shophet'*, or dictator ("judge"). See JUDGE.

(3.) שָׂרֵי־כַרְיֹת, *shalish'* (Exod. xiv, 7; xv, 4; 2 Sam. xxiii, 8; 1 Kings ix, 22; 2 Kings ix, 25; x, 25; xv, 25; 1 Chron. xi, 11; xii, 18; 2 Chron. viii, 9; "lord," 2 Kings vii, 2, 17, 19; Ezek. xxiii, 23; "prince," Ezek. xxiii, 15), prop. a *third man*, i. e. one of three, Gr. τριστάρχης, a higher order of soldiers, who fought from chariots, *chariot-warriors* (Exod. xiv, 7; xv, 4; 1 Kings ix, 22; ἀναβάται, *parabatai*, Hom. *Iliad*, xxiii, 82; Eurip. *Supplic.* 679); employed also for the body-guard of kings (1 Kings ix, 22; 2 Kings x, 25; 1 Chron. xi, 11; xii, 18). The Sept. has τριστάρται, i. e. according to Origen and Gregory of Nyssa (in the *Catene*), "soldiers fighting from chariots," and so called because each chariot contained three soldiers, one of whom managed the horses, while the other two fought (comp. Ewald, *Gesch. Isr.* ii, 81). For although on the Egyptian monuments usually but one, or at most two appear in the war-chariots, yet occasionally, as certainly in the Assyrian bas-reliefs, in addition to the driver and the warrior, an armor-bearer or umbrella-bearer is depicted as standing in the chariot, who might properly be termed *ternarius*, or a *third man*. See CHARIOT. It is true the Hebrew army did not originally consist of cavalry, although chariots were in use among the Canaanites, and the first occurrences of the term שָׂרֵי־כַרְיֹת are in connection with the Egyptians; but at a later date a chariot-squadron was organized (1 Kings x, 26; comp. ix, 9; v, 6; 2 Sam. viii, 4). Consequently, it is not strange that among the battalions of David and Solomon (2 Sam. xxiii, 8) there should be named as a prominent hero the leader of these *shalishim* (שָׂרֵי־כַרְיֹת, or, rather, שָׂרֵי־כַרְיֹת: comp. Gesenius, *Lehrgeb.* p. 525; Bötticher, *Spec.* p. 88 sq.; Ewald, *German. Heb.* 5th ed. § 152, c. 177 a). Solomon's chariot-men (שָׂרֵי־כַרְיֹת) are mentioned (1 Kings ix, 22; 2 Chron. viii, 9) as next to the præfects of his chariot-force (שָׂרֵי־כַרְיֹת). After the times of Solomon there certainly were chariot-combatants (*eschararii*) as royal officers in the northern kingdom, and in the reign of Jehu runners and charioteers (שָׂרֵי־כַרְיֹת) formed, as it were, the king's Prætorian cohort (2 Kings x, 25); and the chief of these Prætorians (called by eminence שָׂרֵי־כַרְיֹת, or שָׂרֵי־כַרְיֹת) was among the most noble of the regal attendants (q. d. adjutant-general). Accordingly, Joram had an officer of this title, "on whose hand the king leaned" (2 Kings vii, 2, 17, 19); Jehu's charioteer was Bidkar (2 Kings ix, 26); and Pekah held this eminent office under Pekahiah (2 Kings xv, 25). Others, however (after Drusius), hold that the שָׂרֵי־כַרְיֹת was merely the third officer in rank after the king, or commanded a third part of the army (comp. the Roman *ternarius*). So the Greek glossarists (sp. Drusius ad *Ezech.* and in *Fragm. Vet. interpr. Gr.* p. 145; Schleusner, *Nov. Thesaur.* s. v. τριστάρχης; Dufresne, *Glossar.* s. v.; see Rosenmüller, *Scholia* ad Exod. xiv, 7). See CHIEF OF THREE.

(4.) The "captain of the Temple" (στρατηγός τοῦ ἱεροῦ), mentioned by Luke (Acts iv, 1; v, 24) in connection with the priests, was not a military officer, but superintended the guard of priests and Levites who kept watch by night in the Temple. The "captains" mentioned Luke xxii, 4, were probably his subalterns.

The office appears to have existed from an early date; the "priests that kept the door" (2 Kings xii, 9; xxv, 18) are described by Josephus (*Ant.* x, 8, 5) as "the officers guarding the Temple" (τοὺς φυλάσσοντας τὸ ἱερόν ἡγούμενας): a notice occurs in 2 Macc. iii, 4, of a prefect of the Temple (προσάρτης τοῦ ἱεροῦ); this officer is styled στρατηγός or captain by Josephus (*Ant.* xx, 6, 2; *War*, vi, 5, 8); and in the Mishna (*Middoth*, i, § 2) אִישׁ הַר הַבַּיִת, "the captain of the mountain of the Temple;" his duty, as described in the place last quoted, was to visit the posts during the night, and see that the sentries were doing their duty (comp. 1 Chron. ix, 11; 2 Chron. xxxi, 13; xxxv, 8, 9; Jer. xx, 1). See TEMPLE.

The rank or power of an Israelitish captain was designated by the number of men under his command, as captain of fifty, or captain of a thousand [comp. ΚΕΚΡΥΒΙΟΝ]; and the commander or chief of the whole army was called the captain of the host (q. v.). The divisions of the army were regulated in some measure

by the division of families, as the heads of families were usually officers. Captains of hundreds, or larger companies, were probably what would be called in modern phrase staff-officers, and formed the councils of war. See WAR. Sometimes distinguished men who were not Hebrews were promoted to high stations in the army (Deut. i, 15; 1 Chron. xiii, 1; 2 Chron. xxv, 5; 2 Sam. xxiii, 39). See OFFICER.

God is called *Captain* ("Prince") of the Host (יְהוָה מְצַדִּיק, Dan. viii, 11), not as equivalent to "Lord of Hosts," but because he is the head and protector of his people. So in the N. T. our Lord is called Captain of his people's salvation (ἀρχηγός τῆς σωτηρίας αὐτῶν, Heb. ii, 10), because he is the beginner, source, and author of their salvation, the head of his Church, which he conducts, with and in himself, to blessedness (comp. Josh. v, 14). See JERUSALEM.

Captive (properly שֶׁבִי, *shebi*; Gr. αἰχμάλωτος) is distinguished from a prisoner (q. v.) or one in bondage (q. v.). See CAPTIVITY. Various indignities and



Captives with "ropes on their heads." From the Egyptian Monuments.

cruelties were inflicted on those who had the misfortune to be taken captive in war. Those who surrendered were led out with halters as if for execution (1 Kings xx, 32). See BERSERK. On some occasions particular districts were marked out with a line of destruction (2 Sam. viii, 2). The victors set their feet upon the necks (q. v.) of the captured kings and nobles (Josh. x, 24), or mutilated their persons by cutting off their thumbs, toes, or ears (Judg. i, 7; 2 Sam. iv, 12; Ezek. xxiii, 25); and sometimes they put out their eyes (q. v.) by passing a red-hot iron over them, or literally scooped or dug them out of their sockets (2 Kings xxv, 7; Isa. lxi, 1). These cruelties are still practised under some of the despotic governments of the Eastern countries. See PUNISHMENT. It was the barbarous custom of the conquerors of those times to suspend their unhappy cap-



Ancient Assyrians flaying Captives alive.

tives by the hand (Lam. v, 12), and also to make them bow down that they might go over them (Isa. li, 28); sometimes they were thrown among thorns, were sawn asunder, beaten to pieces with threshing instruments, or had imposed upon them the severest and most laborious occupations (Judg. viii, 7; 2 Sam. xii, 31; 1 Chron. xx, 8). The soldiers who were taken were deprived of all their property and sold naked into servitude. When the city was taken by assault, all the men were slain; the women and children were carried away captive, and sold at a very low price (Isa. xx, iii, 4; xlvii, 8; 2 Chron. xxviii, 9-15; Psa. xlv, 12; Mic. i, 11; Joel iii, 8). See **STEGE**. Sometimes the

ment of tribute. But if in such a case the kings rebelled, they were treated with the greatest severity (Gen. xiv, 4-11; 2 Kings xxiii, 84; xxiv, 1-14; Isa. xxiv, 2; Jer. xx, 5, 6). See **TRIUMPH**.

Captivity (properly some form of the root *שָׁבַק*, *shabak'*, to take captive; but frequently expressed by other Heb. words). The following account is chiefly compiled from the articles in Kitto and Smith, a. v. The bondage (q. v.) of Israel in Egypt, and their subjugation at different times by the Philistines and other nations [see **JUDGES**], are sometimes included under the above title; and the Jews themselves, perhaps with reference to Daniel's vision (ch. vii), reckon their national captivities as four—the Babylonian, Median, Grecian, and Roman (Eisenmenger, *Entdecktes Judenthum*, i, 748). But the popular distinction usually confines the term to the conquest and dispersion of the "ten northern" tribes by the Assyrians, the subsequent deportation of the remaining "two tribes" by the Babylonians, and the final disruption of the entire Jewish polity by the Romans. See **CAPTIVE**.



Evacuation of a captured City. From the Assyrian Monuments.

conqueror stripped the wretched prisoners naked, shaved their heads, and made them travel in that condition, exposed to the heat of a vertical sun by day, and the chilling cold of the night. Nor were women exempted from this treatment (Isa. iii, 17). To them this was the height of indignity, as well as of cruelty, especially to those described by the prophets, who had indulged themselves in all manner of delicacies of living, and all the superfluities of ornamental dress, and even whose faces had hardly ever been exposed to the sight of men. Women and children were also exposed to treatment at which humanity shudders (Nah. iii, 5, 6; Zech. xiv, 2; Esth. iii, 18; 2 Kings viii, 12; Psa. cxxxvii, 9; Isa. xliii, 16, 18; 2 Kings xv, 16; Hos. xliii, 16; Amos i, 13). Sometimes the people were carried into captivity, and transplanted to distant countries: this was the case with the Jews (Jer. xx, 5; xxxix, 9, 10; xl, 7; 2 Kings xxiv, 12-16). In some cases the conquered nations were merely made tributary (2 Sam. viii, 6; 2 Kings xiv, 14). To be tributary, however, was considered a great ignominy, and was a source of reproach to the idol deities of the countries who were thus subjected (2 Kings xix, 8, 18). It was likewise a custom among the heathens to carry in triumph the images of the gods of such nations as they had vanquished (Isa. xlvi, 1, 2; Jer. xlviii, 7; Dan. xi, 8; Amos i, 15). Still farther to show their absolute superiority, the victorious sovereigns used to change the names of the monarchs whom they subdued (2 Kings xxiv, 17; 2 Chron. xxxv, 21, 22; xxxvi, 4; Dan. i, 7). The conquerors, however, were not always destitute of humanity. In many instances they permitted the conquered kings to retain their authority, only requiring from them the promise of good faith and the pay-

The word *Captivity*, as applied to the people of Israel, has been appropriated, contrary to the analogy of our language, to mean Expatriation. The violent removal of the entire population of a city, or sometimes even of a district, is not an uncommon event in ancient history. As a measure of policy, no objection to it on the ground of humanity was felt by any one, since, in fact, it was a very mild proceeding, in comparison with that of selling a tribe or nation into slavery. Every such destruction of national existence, even in modern times, is apt to be embittered by the simultaneous disruption of religious bonds; but in the ancient world, the positive sanctity attributed to special places, and the local attachment of Deity, made expatriation doubly severe. The Hebrew people, for instance, in many most vital points, could no longer obey their sacred law at all when personally removed from Jerusalem; and in many others they were forced to modify it by reason of their change of circumstances. Two principal motives impelled conquering powers thus to transport families in the mass: first, the desire of rapidly filling with a valuable population new cities, built for pride or for policy; next, the determination to break up hostile organizations, or dangerous reminiscences of past greatness. Both might sometimes be combined in the same act. To attain the former object, the skilled artisans would in particular be carried off; while the latter was better effected by transporting all the families of the highest birth, and all the well-trained soldiery. The Greeks used the special epithet *ἀνάσσωροι* for a population thus removed (Herod. vi, 98, *passim*).

I. ASSYRIAN CAPTIVITY OF "ISRAEL."—1. *Its Occurrence.*—The kingdom of Israel was invaded by three or four successive kings of Assyria. Pul or Sardanapalus, according to H. Rawlinson (*Outline of Assyrian History*, p. 14; but comp. G. Rawlinson, *Herodotus*, i, 466), imposed a tribute, B.C. cir. 762, upon Menahem (1 Chron. v, 26, and 2 Kings xv, 19). Tiglath-Pileser carried away, B.C. cir. 788, the trans-Jordanic tribes (1 Chron. v, 26) and the inhabitants of Galilee (2 Kings xv, 29; compare Isa. ix, 1)



Ancient Assyrian Procession of Captives.

to Assyria. Shalmaneser twice invaded (2 Kings xvii, 3, 5) the kingdom which remained to Hoshea, took Samaria, B. C. 720, after a siege of three years, and carried Israel away into Assyria. See HOSHEA. In an inscription interpreted by Rawlinson (*Herodotus*, i, 472), the capture of Samaria is claimed by king Sargon (Isa. xx, 1) as his own achievement. The cities of Samaria were occupied by people sent from Babylon, Cushah, Ava, Hamath, and Sepharvaim; and Halah, Habor, Hara, and the river of Gozan became the seats of the exiled Israelites. See ISRAEL, KINGDOM OF.

The theory of this history is, that in the time of these conquering monarchs Assyria was rapidly rising into power, and to aggrandize Nineveh was probably a great object of policy. It is therefore credible, as Tiglath-Pileser had received no particular provocation from the Israelites, that he carried off those masses of population to stock his huge city with. His successor Shalmaneser made the Israelitish king Hoshea tributary. When the tribute was withheld, he attacked and reduced Samaria, and, by way of punishment and of prevention, transported into Assyria and Media its king and all the most valuable population remaining to the ten tribes (2 Kings xvii, 6). That he did not carry off all the peasants is probable from the nature of the case; Hangstenberg, however, maintains the contrary (*Gossineness of the Pentateuch*, i, 71 sq. Edinb. tr.). The families thus removed were in a great measure settled in very distant cities, many of them probably not far from the Caspian Sea, and their place was supplied by colonies from Babylon and Susis (2 Kings xvii, 24). See ASSYRIA.

2. *Condition of the Assyrian Captives.*—This was probably not essentially different in its external circumstances from that of their Judaite brethren subsequently during the exile in Babylon. (See below.) We know nothing, except by inference from the book of Tobit (q. v.), of the religious or social state of the Israelitish exiles in Assyria. Doubtless the constant policy of seventeen successive kings had effectually estranged the people from that religion which centred in the Temple, and had reduced the number of faithful men below the 7000 who were revealed for the consolation of Elijah. Some priests at least were among them (2 Kings xvii, 28), though it is not certain that these were of the tribe of Levi (1 Kings xii, 81). The people had been nurtured for 250 years in idolatry in their own land, where they departed not (2 Kings xvii, 23) from the sins of Jeroboam, notwithstanding the proximity of the Temple, and the succession of inspired prophets (2 Kings xvii, 18) among them. Deprived of these checks on their natural inclinations (2 Kings xvii, 15), torn from their native soil, destitute of a hereditary king, they probably became more and more closely assimilated to their heathen neighbors in Media. And when, after the lapse of more than a century, they were joined by the first exiles from Jerusalem, very few families probably retained sufficient faith in the God of their fathers to appreciate and follow the instruction of Ezekiel. But whether they were many or few, their genealogies were probably lost, a fusion of them with the Jews took place, Israel ceasing to envy Judah (Isa. xi, 18); and Ezekiel may have seen his own symbolical prophecy (xxxvii, 15-19) partly fulfilled.

The nation thus transported by the monarchs of Assyria and Babylon were treated with no unnecessary harshness, even under the dynasty that captured them. So far were they from the condition of bondsmen (which the word "captive" suggests), that the book of Susanna represents their elders in Babylon as retaining the power of life and death over their own people (i, 26), when Daniel was as yet a very young man. The authority of that book cannot indeed be pressed as to the chronology, yet the notices given by Ezekiel (xiv, 1; xx, 1) concur in the general fact that they still held an internal jurisdiction over their own

members. At a later time, under the Seleucida, we have distinct proof that in the principal cities the Jews were governed by an officer (*ἰθράρχης*) of their own nation, as also in Egypt under the Ptolemies. The book of Tobit exhibits Israelites in Media possessed of slaves themselves (viii, 18); the book of Daniel tells us of a Jew in eminent political station, and that of Esther celebrates their power and consequence in the Persian empire. Under the Seleucida [see ANTIOCHUS] they were occasionally important as garrison-soldiers; and it may be suspected that, on the whole, their lot was milder than that of the other conquered nations among which they dwelt.

8. *Eventual Fate of the Exiles in Assyria.*—Many attempts have been made to discover the ten tribes existing as a distinct community. Josephus (*Ant.* xi, 6, 2) believed that in his day they dwelt in large multitudes somewhere beyond the Euphrates, in Arsareth, according to the author of 2 Eod. xiii, 45. Rabbinical traditions and fables, committed to writing in the Middle Ages, assert the same fact (Lightfoot, *Hor. Hebr.* in 1 Cor. xiv, Appendix), with many marvellous amplifications (Eisenmenger, *Ent. Jud.* vol. ii, ch. x; Jahn, *Hebrew Commonwealth*, App. bk. vi). The imagination of Christian writers has sought them in the neighborhood of their last recorded habitation; Jewish features have been traced in the Affghan tribes; rumors are heard to this day of a Jewish colony at the foot of the Himalayas; the Black Jews of Malabar claim affinity with them; elaborate attempts have been made to identify them with the Tartars (G. Fletcher, *Israel Redux*, Lond. 1677), and more recently with the Nestorians (Grant's *Nestorians*, N. Y. 1841), and in the seventeenth century with the Indians of North America. But, though history bears no witness of their present distinct existence, it enables us to track the footsteps of the departing race in four directions after the time of the Captivity: (1.) Some returned and mixed with the Jews (Luke ii, 36; Phil. iii, 5, etc.). (2.) Some were left in Samaria, mingled with the Samaritans (Ezra vi, 21; John iv, 12), and became bitter enemies of the Jews. (3.) Many remained in Assyria, and, mixing with the Jews, formed colonies throughout the East, and were recognised as an integral part of the Dispersion (see Acts ii, 9; xxvi, 7; Buchanan's *Christian Researches*, p. 212), for whom, probably ever since the days of Ezra, that plaintive prayer, the tenth of the *Shemoneh Esre*, has been daily offered, "Sound the great trumpet for our deliverance, lift up a banner for the gathering of our exiles, and unite us all together from the four ends of the earth." (4.) Most, probably, apostatized in Assyria, as Prideaux (sub ann. 677) supposes, and adopted the usages and idolatry of the nations among whom they were planted, and became wholly swallowed up in them. Dissertations on the Ten Tribes have been written by Calmet (*Commentaire Littéral*, vol. iii and vi) and others (the latest by J. Kennedy, Lond. 1855); also innumerable essays and disquisitions scattered in the works of travellers, and in the pages of various periodicals, mostly of a highly fanciful character. Every scriptural intimation respecting them, however, goes to show that they shared the ultimate history of their brethren of the kingdom of Judah transported to the same or adjoining parts. See below.

II. BABYLONIAN CAPTIVITY OF "JUDAH."—1. *Its Date.*—Sennacherib, B. C. 713, is stated (Rawlinson, *Outline*, p. 24; but comp. Demetrius ap. Clem. Alex. and *Stromata*, i, 21, incorrectly quoted as confirming the statement) to have carried into Assyria 200,000 captives from the Jewish cities which he took (2 Kings xviii, 18). Nebuchadnezzar, early in his reign, B. C. 606-562, repeatedly invaded Judæa, and finally besieged Jerusalem, carried away the inhabitants to Babylon, and destroyed the city and Temple. Two distinct deportations are mentioned in 2 Kings xxiv, 14, and xxv, 11; one in 2 Chron. xxxvi, 20; three in

Jer. lii, 28, 29, and one in Dan. i, 8. The two principal deportations were, (1) that which took place B.C. 598, when Jehoiachin, with all the nobles, soldiers, and artificers were carried away; and (2) that which followed the destruction of the Temple and the capture of Zedekiah, B.C. 588. The three which Jeremiah mentions may have been the contributions of a particular class or district to the general captivity; or they may have taken place, under the orders of Nebuchadnezzar, before or after the two principal deportations. The third is located by the date in B.C. 582. The captivity of certain selected children, B.C. 607, mentioned by Daniel (i, 3, 6), who was one of them, may have occurred when Nebuchadnezzar (q. v.) was colleague or lieutenant of his father Nabopolassar, a year before he reigned alone. The captivity of Ezekiel (q. v.) dates from B.C. 598, when that prophet, like Mordecai, the uncle of Esther (ii, 6), accompanied Jehoiachin.

There is a difficulty in the statement with which the book of Daniel opens, which is generally interpreted to mean that in the third year of Jehoiakim, Nebuchadnezzar besieged and captured Jerusalem, partially plundered the Temple, and carried off the first portion of the people into captivity, among whom was Daniel. The text, however, does not explicitly say so much, although such is the obvious meaning; but if this is the only interpretation, we find it in direct collision with the books of Kings and Chronicles (which assign to Jehoiakim an eleven years' reign), as also with Jeremiah xxv, 1. The statement in Daniel partly rests on 2 Chron. xxxvi, 6, which is itself not in perfect accordance with 2 Kings xxiv. In the earlier history, the war broke out during the reign of Jehoiakim, who died before its close; and when his son and successor Jehoiachin had reigned three months, the city and its king were captured. But in the Chronicles, the same event is made to happen twice, at an interval of three months and ten days (2 Chron. xxxvi, 6 and 9), and even thus we do not obtain accordance with the received interpretation of Daniel i, 1-8. It seems, on the whole, the easiest supposition that "the third year of Jehoiakim" is there a mistake for "the third month of Jehoiachin." Hengstenberg, however, and Hävernick defend the common reading, and think they reconcile it with the other accounts; which may not unreasonably be done by understanding the date in Dan. i, 1, to refer to the setting out of Nebuchadnezzar on the campaign in question. See JUDAH, KINGDOM OF.

There has been considerable difference of opinion as to how the 70 years of captivity spoken of by Jeremiah (xxv, 12; xxix, 10) are to be estimated. A plausible opinion would make them last from the destruction of the first Temple, B.C. 588, to the finishing of the second, B.C. 516; but the words of the text so specify "the punishing of the king of Babylon" as the end of the 70 years—which gives us the date B.C. 588—that many, with Jahn, cling to the belief that a first captivity took place in the third year of Jehoiakim, B.C. 605. But, in fact, if we read Jeremiah himself, it may appear that in ch. xxv he intends to compute the 70 years from the time at which he speaks (ver. 1, "in the fourth year of Jehoiakim," i. e. B.C. 604); and that in xxix, 10, the number "seventy years" is still kept up, in remembrance of the former prophecy, although the language there used is very lax. There seem, in fact, to be two, if not more, co-ordinate modes of computing the period in question, used by the sacred writers, one civil, and extending from the first invasion by Nebuchadnezzar to the decree of Cyrus B.C. 606-536), and the other ecclesiastical, from the burning of the Temple to its reconstruction (B.C. 588-517). See SEVENTY YEARS' CAPTIVITY.

2. *Its Extent.*—Jeremiah dates by the years of Nebuchadnezzar's reign, and estimates that in his seventh year 8023 were carried off, in his eighteenth 832, and in his twenty-third only 745, making in all, as the writer is careful to note, 4600 (Jer. lii, 28, etc.). The

third removal he ascribes to Nebuzaradan, the Babylonian general. That some misunderstanding here exists, at least in the numbers, appears undeniable; for 4600 persons was a very petty fraction of the Jewish people; and, in fact, 42,860 are stated to have returned immediately upon the decree of Cyrus (Ezra ii, 64). In 2 Kings xxiv, 8-16, we find 18,000 carried off at once, in the third month of king Jehoiachin, and in the eighth year of Nebuchadnezzar, which evidently is the same as the first removal named by Jeremiah. After this, the vassal king Zedekiah having rebelled, his city is beleaguered, and finally, in his eleventh year, is reduced by Nebuchadnezzar in person; and in the course of the same year, "the nineteenth of Nebuchadnezzar" (2 Kings xxv, 8), Nebuzaradan carries away all the population except the peasants. Perhaps we need not wonder that no mention is made in the book of Kings of the third deportation, for the account of the destruction was in a manner complete upon the second invasion. The first expatriation was directed to swell the armies and strengthen the towns of the conqueror; for of the 18,000 then carried away, 1000 were "craftsmen and smiths, all strong and apt for war," and 7000 of the rest are called "mighty men of valor." (Yet there is an uncertainty about verses 14 and 16 in 2 Kings xxiv. Probably here, as well as in Jer. liii, heads of families only are counted.) It was not until the rebellion of Zedekiah that Nebuchadnezzar proceeded to the extremity of breaking up the national existence. As the Temple was then burnt, with all the palaces and the city walls, and no government was left but that of the Babylonian satrap, this latter date is evidently the true era of the captivity. Previously Zedekiah was tributary, but so were Josiah and Ahaz long before; the national existence was still saved. See BABYLONIA.

3. *Its comparative Mildness.*—The captive Jews were probably prostrated at first by their great calamity, till the glorious vision of Ezekiel (i, 1) in the fifth year of the captivity revived and reunited them. The wishes of their conqueror were satisfied when he had displayed his power by transporting them into another land, and gratified his pride by inscribing on the walls of the royal palace his victorious progress and the number of his captives. He could not have designed simply to increase the population of Babylon, for his Assyrian predecessor had sent Babylonian colonists into Samaria. One political end certainly was attained—the more easy government of a people separated from local traditions and associations (see Gesenius on Isa. xxvi, 16, and compare Gen. xlvii, 21). It was also a great advantage to the Assyro-Babylonian king to remove from the Egyptian border of his empire a people who were notoriously well affected toward Egypt. The captives were treated not as slaves, but as colonists. There was nothing to hinder a Jew from rising to the highest eminence in the state (Dan. ii, 48), or holding the most confidential office near the person of the king (Neh. i, 11; Tobit i, 18, 22). The advice of Jeremiah (xxix, 5, etc.) was generally followed. The exiles increased in numbers and in wealth. They observed the Mosaic law (Esth. iii, 8; Tobit xiv, 9). They kept up distinctions of rank among themselves (Ezek. xx, 1). And though the assertion in the Talmud be unsupported by proof that they assigned thus early to one of their countrymen the title of Head of the Captivity (or captain of the people, 2 Eed. v, 16), it is certain that they at least preserved their genealogical tables, and were at no loss to tell who was the rightful heir to David's throne. They had neither place nor time of national gathering; no temple, and they offered no sacrifice. But the rite of circumcision, and their laws respecting food, etc., were observed; their priests were with them (Jer. xxix, 1); and possibly the practice of erecting synagogues in every city (Acts xv, 21) was begun by the Jews in the Babylonian captivity.

The captivity is not without contemporaneous liter-

ature. In the apocryphal book of Tobit, which is generally believed to be a mixture of poetical fiction with historical facts recorded by a contemporary, we have a picture of the inner life of a family of the tribe of Naphtali, among the captives whom Shalmaneser brought to Nineveh. The apocryphal book of Baruch seems, in Mr. Layard's opinion, to have been written by one whose eyes, like those of Ezekiel, were familiar with the gigantic forms of Assyrian sculpture. Several of the Psalms appear to express the sentiments of Jews who were either partakers or witnesses of the Assyrian captivity. Ewald assigns to this period *Psa.* xlii, xliii, lxxxiv, xvii, xvi, xlix, xxii, xxv, xxxviii, lxxxviii, xl, lxix, cix, li, lxxi, xxv, xxxiv, lxxxii, xiv, cx, cxxi, cxxiii, cxxx, cxxxi. Also in *Psa.* lxxx we seem to have the words of an Israelite, dwelling perhaps in Judæa (2 Chron. xv, 9; xxxi, 6), who had seen the departure of his countrymen to Assyria; and in *Psa.* cxxxvii an outpouring of the first intense feelings of a Jewish exile in Babylon. But it is from the three great prophets—Jeremiah, Ezekiel, and Daniel—that we learn most of the condition of the children of the captivity. The distant warnings of Jeremiah, advising and cheering them, followed them into Assyria. There, for a few years, they had no prophetic guide; till suddenly the vision of Ezekiel at Chebar (in the immediate vicinity of Nineveh, according to Layard, or, according to others, near Carchemish on the Euphrates) assured them that the glory which filled the Temple at Jerusalem was not hopelessly withdrawn from the outcast people of God. As Jeremiah warned them of coming woe, so Ezekiel taught them how to bear that which was come upon them. When Ezekiel died, after passing at least twenty-seven years (*Ezek.* xxix, 17) in captivity, Daniel survived even beyond the Return; and though his high station and ascetic life probably secluded him from frequent familiar intercourse with his people, he filled the place of chief interpreter of God's will to Israel, and gave the most conspicuous example of devotion and obedience to his laws.

4. *The Restoration from Babylon.*—The first great event in the Return is the decree of Cyrus, B.C. 536 (which was possibly framed by Daniel; see Milman, *Hist. of Jews*, ii, 8), in consequence of which 42,860 Jews of Babylon returned under Sheshbazzar, with 7887 slaves, besides cattle. This ended in their building the altar, and laying the foundation of the second Temple, fifty-three years after the destruction of the first. The progress of the work was, however, almost immediately stopped; for Zerubbabel, Joshua, and the rest abruptly refused all help from the half-heathen inhabitants of Samaria, and soon felt the effects of the enmity thus induced. That the mind of Cyrus was changed by their intrigues we are not informed, but he was probably absent in distant parts through continual war. There is some difficulty in Ezra iv as to the names Ahasuerus and Artaxerxes, yet the general facts are clear. When Darius (Hystaspis), an able and generous monarch, ascended the throne, the Jews soon obtained his favor. At this crisis Zerubbabel was in chief authority (Sheshbazzar, if a different person, perhaps being dead), and under him the Temple was recommenced in the second and finished in the sixth year of Darius, B.C. 520-517. Although this must be reckoned an era in the history, it is not said to have been accompanied with any new immigration of Jews. We pass on to "the seventh year of King Artaxerxes" (Longimanus), Ezra vii, 7, i. e. B.C. 459, when Ezra comes up from Babylon to Jerusalem, with the king's commendatory letters, accompanied by a large body of his nation. The enumeration in Ezra viii makes them under 1800 males, with their families; perhaps amounting to 5000 persons, young and old: of whom 113 are recounted as having heathen wives (*Ezra* x, 18-48). In the twentieth year of the same king, or B.C. 446, Nehemiah, his cup-bearer, gains his permis-

sion to restore "his fathers' sepulchres," and the walls of his native city, and is sent to Jerusalem with large powers. This is the crisis which decided the national restoration of the Jewish people; for before their city was fortified they had no defence against the now confirmed enmity of their Samaritan neighbors; and, in fact, before the walls could be built, several princes around were able to offer great opposition. See *SANBALLAT*. The Jewish population was overwhelmed with debt, and had generally mortgaged their little estates to the rich; but Nehemiah's influence succeeded in bringing about a general forfeiture of debts, or, at least, of interest; after which we may regard the new order of things to have been finally established in Judæa. See *NEHEMIAH*. From this time forth it is probable that numerous families returned in small parties, as to a secure home, until all the waste land in the neighborhood was reoccupied.

The great mass of the Israelitish race nevertheless remained in the lands to which they had been scattered. Previous to the captivity, many Israelites had settled in Egypt (*Zech.* x, 11; *Isa.* xix, 18), and many Jews afterward fled thither from Nebuzaradan (*Jer.* xli, 17). Others appear to have established themselves in Sheba (see *Jost's Geschichte*, etc.), where Jewish influence became very powerful. See *SHEBA*. Among those that returned to Judæa, about 80,000 are specified (*comp. Ezra* ii and *Neh.* vii) as belonging to the tribes of Judah, Benjamin, and Levi. It has been inferred (Prideaux, *sub* ann. 536) that the remaining 12,000 belonged to the tribes of Israel (*comp. Ezra* vi, 17). Also from the fact that out of the twenty-four courses of priests only four returned (*Ezra* ii, 86), it has been inferred that the whole number of exiles who chose to continue in Assyria was about six times the number of those who returned. Those who remained (*Esth.* viii, 9, 11), and kept up their national distinction, were known as The Dispersion (*John* vii, 85; *1 Pet.* i, 1; *James* i, 1); and in course of time they served a great purpose in diffusing a knowledge of the true God, and in affording a point for the commencement of the efforts of the evangelists of the Christian faith. See below, and *comp. RESTORATION (of the Jews)*.

5. *Effects of the Captivity.*—The exile was a period of change in the vernacular language of the Jews (see *Neh.* viii, 8, and *comp. CHALDEE LANGUAGE*) and in the national character. The Jews who returned were remarkably free from the old sin of idolatry: a great spiritual renovation, in accordance with the divine promise (*Ezek.* xxxvi, 24-28), was wrought in them. A new and deep feeling of reverence for at least the letter of the law and the institutions of Moses was probably a result of the religious service which was performed in the synagogues. At the same time their theosophical and dæmonological views were developed by their contact with Oriental systems, and perhaps by the polemics thereby engendered, and especially by their review of their own religious resources, and their more careful study of the didactic portions of the O.-T. Scriptures; certain it is that from this period we can date not only a fuller angelology [see *ANGEL*], but also more subtle philosophical distinctions [see *PHILOSOPHY*], and in particular a more distinct recognition of the great doctrines of the immortality of the soul, and even of the resurrection of the body, which we subsequently find so unquestioned by the orthodox Pharisees. See *SECTS (of the Jews)*. All this was the natural consequence of the absence of the ritual services of the Temple, which brought out the more spiritual elements of Mosaism, and thus was the nation better prepared for the dispensation of the Gospel. A new impulse of commercial enterprise and activity was also implanted in them, and developed in the days of the Dispersion (see *James* iv, 18), which they have continued to feel even to the present time. In fine, an innovation was effected upon the narrow and one-

aided notions of Judaism by the associations of the exile, which, although it resulted in the defection of many from the national faith (but of these few cared to return to their native land), yet—like the earlier Sojourn in Egypt (with which, in the glowing pictures of prophecy, it was often compared)—ended in the colonization of Palestine with a fresh and more thoroughly cultured population, yet more scrupulously devoted than ever to the theocratic cultus, who volunteered with pious zeal to lay anew the foundations of the Hebrew polity.

6. *The Dispersion, ἡ Διασπορά* (2 Macc. i, 27; James i, 1; 1 Pet. i, 1; John vii, 35; Josephus, *Ant.* xii, 1, 8, etc.; Sept. for דִּיּוּרָא , which it also renders *ἀρούκία*, *μεροικία*, *αἰχμαλωσία*), is the collective name given to all those descendants of the twelve tribes (James i, 1; τὸ δωδεκάφυλον , Acts xxvi, 7) who lived without the confines of Palestine (ἔξω , 1 Cor. v, 13, etc.); דִּיּוּרָא , $\text{מְדִינַת הַדִּיּוּרָא}$, Talmudic *Mishna*), during the time of the second Temple. The number of exiles, mostly of the tribe of Judah and Benjamin (Ezra i, 5, etc.), who availed themselves of the permission of Cyrus to return from their captivity in Babylon to the land of their fathers, scarcely exceeded, if indeed it reached, the number of 50,000 [the total stated both in Ezra and Nehemiah is, exclusive of the slaves, 42,360; but the sum of the items given—with slight differences—in both documents, falls short of 80,000]. Old Jewish authorities see in this surplus Israelites of the ten tribes (comp. *Seder Olam Rabbah*, ch. xxix), and among these few but the lowest and humblest, or such as had yielded to authority, were to be found (comp. Mishna, *Kidushin*, iv, 1; Gem. lxxi, 1). The great bulk of the nation remained scattered over the wide dominions of the Persian empire, preferring the new homes in which they enjoyed all the privileges of native-born subjects, and where they had in many cases acquired wealth and honors, to the dangers and difficulties of a recolonization of their former country. But while, by the hands of the despised minority who had bravely gone forth, was to be recreated not only the Temple, the visible centre of Judaism, but also the still more imposing and important edifice of the Jewish law and Jewish culture, to the much larger section which remained behind, and gradually diffused itself over the whole of the then known world, it was given to participate in the intellectual life and the progress in civilization of all the nations with whom their lot was cast. To the Dispersion is thus due the cosmopolitan element in Judaism which has added so vastly not only to its own strength and durability, but also, geographically at least, to the rapid spread of Christianity. So far, however, from the dispersion paving the way for the new faith by relaxing the rigor of Jewish law, written or oral—as has been assumed by some—one of the strongest ties by which these voluntary exiles were bound to Palestine and Jerusalem consisted in the very regulations and decisions on all ritual and legal points which they received from the supreme religious authorities, either brought back by their own delegates, or transmitted to them by special messengers from the Central Court, the Sanhedrim (Acts xxviii, 21). Generally it might be said of the whole *Diaspora*, as Philo (*Flacc.* § 7) said of that of Egypt: that while they looked upon the country in which they had been born and bred as their home, still they never ceased, so long as the Temple stood, to consider Jerusalem as the spiritual metropolis to which their eyes and hearts were directed. Many were the pilgrimages undertaken thither from their far-distant lands (Acts ii, 5, 9-11; Joseph. *War.* vi, 9, 8, etc.). The Talmud (*Jer. Meg.* iii, 75; comp. *Toe. Meg.* c. 2) speaks of no less than 380 synagogues in Jerusalem, besides the Temple, all belonging to different communities of the Dispersion (comp. also Acts vi, 9). Abundant and far exceeding the normal tax of half a shekel (*Shek.* vii,

4) were the gifts they sent regularly for the support of the holy place (gold instead of silver and copper, *Toe. Shek.* c. 2), and still more liberal were the monetary equivalents for sacrifices, propitiatory offerings ($\chi\iota\rho\tau\alpha$, Philo), for vows, etc., which flowed from all countries into the sacred treasury. The Sanhedrim again regulated the year, with all its subdivisions, throughout the wide circle of the Dispersion; the fact that the commencement of the new month had been officially recognised being announced either by beacon-fires to the adjoining countries, or by messengers to places more remote. That, in general, there existed, as far as circumstances permitted, an uninterrupted intercourse between the Jews abroad and those in Palestine cannot be doubted. Probably, owing to this very connection, two foreign academies only seem to have existed during the time of the second Temple; the youth of the Dispersion naturally preferring to resort to the fountain-head of learning and religious instruction in the Holy City. The final destruction of the Temple and Jerusalem was thus a blow hardly less sensibly felt by the Dispersion than by their brethren of Jerusalem themselves. From that time forward no visible centre bound the widely-scattered members of the Jewish nation together; nothing remained to them but common memories, common hopes, and a common faith.

(a.) Foremost in the two or three chief sections into which the Dispersion has been divided stands the Babylonian (ἄριθ Εὐφράτην , Josephus, *Ant.* xv, 3, 1), embracing all the Jews of the Persian empire, into every part of which (Esth. iii, 8)²—Babylonia, Media, Persia, Susiana, Mesopotamia, Assyria, etc.—they penetrated. The Jews of Babylonia proper prided themselves on the exceptional purity of their lineage—a boast uniformly recognised throughout the nation. What Judaea, it was said, was with respect to the Dispersion of other countries—as pure flour to dough—that Babylonia was to Judaea (Jerus. Talm. *Kid.* vi, 1). Herod pretended to have sprung from Babylonian ancestors (Joseph. *Ant.* xiv, 1, 8), and also bestowed the high-priesthood upon a man from Babylon (Joseph. *Ant.* xv, 2, 4). In the messages sent by the Sanhedrim to the whole Dispersion, Babylonia received the precedence (*Sanh.* 11); although it remained a standing reproach against the Babylonians that they had held aloof from the national cause when their brethren returned to Palestine, and thus had caused the weakness of the Jewish state (*Yoma*, 9); as indeed living in Palestine under any circumstances is enumerated among the (613) Jewish ordinances (*Nachmanides*, *Comm.* to Maimonides's *Sepher Hammizvoth*). The very territory of Babylonia was, for certain ritual purposes, considered to be as pure as Palestine itself. Very little is known of the history of the Babylonian *Diaspora*; but there is no reason to suppose that its condition was, under Persian as well as under Seleucid and Parthian rule, at most times other than flourishing and prosperous; as such we find that it was when it offered Hyrcanus "honors not inferior to those of a king" (Joseph. *Ant.* xv, 2, 2). Of Alexander the Great, Josephus records expressly that he confirmed the former privileges of the Jews in Babylonia (Joseph. *Ant.* xi, 8, 5), notwithstanding their firm refusal to assist in rebuilding the temple of Belus at Babylon (Hecat. ap. Joseph. *Ap.* i, 22). Two great cities, Niabis in Mesopotamia, and Nehardea on the Euphrates, where the moneys intended for transmission to Jerusalem were deposited (Joseph. *Ant.* xviii, 9, 1, 3, 4, etc.), as was the case also at Apamea in Asia Minor, Laodicea in Phrygia, Pergamus and Adramyttium in *Eolis*—seem to have been entirely their own, and for a number of years they appear even to have enjoyed the undisputed possession of a whole principality (*ib.* 5). Great calamities, however, befell them, both about this time under Mithridates (*ib.* 9), and later under Caligula, through the jealousy of the

Greeks and Syrians; and at both of these epochs they emigrated in large numbers. Whether they had in those times, as was afterward the case, a universally recognised ethnarch at their head, is open to doubt, although *Seder Olam Sutta* enumerates the names of fifteen generations of such, down to the third century. The ties which linked Babylonia to Palestine were perhaps closer than in the case of any other portion of the Dispersion, both on account of their greater proximity, which enabled them to communicate by beacons (Beth-Biltin being the last station on the frontiers; *Beot Hask.* ii, 7), and of their common Aramaic idiom. That this Dispersion was not without an influence on the development of the Zoroastrian religion (comp. Spiegel, *Intr. to Zendavesta*), which in its turn again influenced Judaism (and, at a later stage, Gnosticism), can hardly be doubted; at the same time, it was Babylonia which, after the final destruction of the Temple, by its numerous and far-famed academies, became for a long time the spiritual centre of the Jewish race, and was the seat of the prince of the Diaspora (Resh Gelutha). See BABYLON.

(b.) The second great and pre-eminently important group of the Dispersion we find in Egypt. Of the original immigrations from Palestine (comp. Zech. x, 11), and of those which took place in the times of the last kings of Judah (Jer. xli, 17, 42), we have no more certain traces than of those under Artaxerxes Ochus (Josephus, *Ap.* 1, etc.). It was only after Alexander the Great, who first settled 8000 Jewish soldiers in the Thebais, and peopled a third of his newly-founded city Alexandria with Jews, and Ptolemaeus, the son of Lagus, after him, who increased the number of Egyptian Jews by fresh importations from Palestine, that the Egyptian Dispersion began to spread over the whole country, from the Libyan desert in the north to the boundaries of Ethiopia in the south (Philo, *Fl.* ii, 528), over the Cyrenaica and parts of Libya (Joseph. *Ant.* xvi, 7, 2), and along the borders of the African coast of the Mediterranean. They enjoyed equal rights with their fellow-subjects, both Egyptian and Greek (*ισσοαυρία*, Joseph. *Ap.* ii, 4, etc.), and were admitted to the highest offices and dignities. The free development which was there allowed them enabled them to reach, under Greek auspices, the highest eminence in science and art. Their artists and workmen were sent for to distant countries, as once the Phœnicians had been (*Yoma*, iii, 8, a.; *Erach.* 10, b). In Greek strategy and Greek statesmanship, Greek learning and Greek refinement, they were ready disciples. From the number of Judæo-Greek fragments, historical, didactic, epic, etc. (by Demetrius, Malchus, Eupolemus, Artapan, Aristæus, Jason, Ezechielus, Philo the Elder, Theodotion, etc.; collected in Müller, *Fragm. Hist. Græc.* iii, 207-230), which have survived, we may easily conclude what an immense literature this Egyptian Dispersion must have possessed. To them is owing likewise the Greek translation of the Bible known as the Septuagint, which, in its turn, while it estranged the people more and more from the language of their fathers, the Hebrew, gave rise to a vast pseudo-apographical and apocryphal literature (Orphica, Sybillines, Pseudophocæa; poems by Linus, Homer, Hesiod; additions to Esther, Ezra, the Maccabees, Book of Wisdom, Baruch, Jeremiah, Susannah, etc.). Most momentous of all, however, was that peculiar Græco-Jewish philosophy which sprang from a mixture of Hellenism and Orientalism, and which played such a prominent part in the early history of Christianity. The administrative government of this Egyptian, or, rather, African Dispersion, which, no less than all other branches, for all religious purposes looked to Jerusalem as the head, was, at the time of Christ, in the hands of a Gerousia (*Sukkah*, 51, b; Philo, *Fl.* ii, 5, 28), consisting of seventy members and an ethnarch (alabarch), chosen from their own body, of priestly lineage. These sat at Alexandria, where two of the

five divisions of the city, situated on the Delta (the site best adapted for navigation and commercial purposes), were occupied exclusively by Jews (Josephus, *Ant.* xiv, 7, 2). Of the splendor of the Alexandrine temple, there is a glowing account in the *Jerus. Talm.* (*Suk.* 10, b); and when, in consequence of the Syrian oppression in Palestine, Onias, the son of the last high-priest of the line of Joshua, had fled to Egypt, where Ptolemy Philometor gave him an extensive district near Heliopolis, a new temple (Beth Chonyo) had arisen at Leontopolis (Joseph. *Ant.* xiii, 8, 2, f.), B.C. 180, which bade fair to rival the Temple of Jerusalem. Such, indeed, was the influence of the Jews in Egypt, whom Philo (*Fl.* 6) in his time estimates at a million, that this new temple was treated with consideration even by the Sanhedrim (*Menach.* 109, a). Their condition, it may easily be inferred, was flourishing both under the Seleucidian and Roman sway, but under Caligula, and still more under Nero (Joseph. *War.* ii, 18, 7), they, like their brethren in other parts of the Roman empire, suffered greatly from sudden outbursts of the populace, prompted and countenanced in some instances by their rulers. From Egypt the Diaspora spread southward to Abyssinia, where some remnants of it still exist under the name of the *Falasha*, and in all likelihood eastward to Arabia (Mishna, *Shab.* vi, 6), where we find a Jewish kingdom (Yemen) in the south (Tabari ap. Silv. de Sacy, *Mém. de l'Acad. de l'Inscr.* p. 78), and a large Jewish settlement (Chaibar) in Hejaz in the north. See ALEXANDRIA.

(c.) Another principal section of the Dispersion we find in Syria, whither they had been brought chiefly by Seleucus Nicator or Nicanor (Joseph. *Ant.* vii, 8, 1), when the battle of Ipsus, B.C. 301, had put him in possession of the countries of Syria Proper, Babylonia, Mesopotamia, Persia, Phœnicia, Palestine, etc. Under his and his successors' fostering rule they reached the highest degree of prosperity (*l. c.*), principally at Antioch on the Orontes, and Seleucia on the Tigris, and other great cities founded by Seleucus; and the privileges which this king had bestowed upon them were constantly confirmed up to the time of Josephus (*Ant.* xii, 8, 1). Antiochus Epiphanes, or Epimaneas, as he was called, seems to have been the only Syrian potentate by whom the Syrian dispersion was persecuted; and it was no doubt under his reign that they, in order to escape from his cruelty, began to emigrate in all directions—to Armenia, Cappadocia (Helena, the Jewish queen of Adiabene, Joseph. *Ant.* xx, 2), Cyprus, and over the whole of Asia Minor; Phrygia and Lydia alone possessed Jewish colonies of a previous date, planted there by Antiochus the Greek (Joseph. *Ant.* xii, 8, 4). Hence they dispersed themselves throughout the islands of the Ægean, to Macedonia, to Greece, where they inhabited chiefly the seaports and the marts of trade and commerce. See SYRIA.

(d.) Although, to use the words of Josephus (*Ant.* xiv, 7, 2), the habitable globe was so full of Jews that there was scarcely a corner of the Roman empire where they might not be found—a statement fully confirmed by the number of Roman decrees issued to various parts of the empire for their protection (Joseph. *Ant.* xiv, 10 sq.)—there is yet no absolute proof of their having acquired any fixed settlements in the metropolis itself anterior to the time of Pompey, who, after the taking of Jerusalem, carried back with him many Jewish captives and prisoners to Rome, B.C. 68. These, being generally either allowed to retire from the service, or ransomed, remained there as *Liberini*, and in time formed, by the addition to their number of fresh immigrants from Asia and Greece, a large and highly influential community, which occupied chiefly the Transiberine portion of the city, together with an island in the Tiber. Their prosperity grew with their numbers, and suffered but short interruptions under Tiberius (Suet. *Tib.* c. 86). The expulsion under Claudius (Suet. *Cl.* 25) and Caligula (Joseph. *Ant.* xviii, 6)

is contradicted (Dio Cass. ix, 6; Orosius, vii, 6). They built numerous synagogues, founded schools (even a short-lived academy), made proselytes, and enjoyed the full advantages of Roman citizens (in the decrees they are styled *πολίται Ρωμαίων, πολίται ημίτεροι Ιουδαίου*, Joseph. *Ant.* xiv, 10). The connection between the Roman Dispersion and Palestine was very close, especially so long as the young princes of the Herodian house were, in a manner, obliged to live in Rome. There is no doubt that to the influence of this powerful body, whose number, origin, strange rites and customs, attracted no small share of public notice (Tacitus, Suetonius, Cicero, Juvenal, Horace, Martial, Justinian, etc., *passim*), and to their access to the imperial court was due the amelioration of the condition of the Jewish people throughout every country to which the sway of Rome extended. It was also through Rome chiefly, both before, and still more after the final destruction of Jerusalem, that the stream of Jewish emigration was poured over the greater part of Europe. Of the world-wide influence of the Jewish Dispersion on Christianity, which addressed itself first of all to the former as a body (Acts xiii, 46; ii, 9, 11), farther mention will be found under the article *Jews*.

The most important original authorities on the Dispersion are Joseph. *Ant.* xiv, 10; xiv, 7; *Apion.* ii, 5; Philo, *Leg. ad Caium*; id. *Flaccum*. Frankel has collected the various points together in an exhaustive essay in his *Monatschrift*, Nov. Dec. 1863, p. 409-11, 449-51. Comp. Jost, *Gesch. d. Judenth.* p. 836, 844; Ewald, *Gesch. d. Volkes Isr.* iv. See *DISPERSED JEWS*.

III. *Subsequent States of Captivity.*—1. The extermination suffered by the Jewish inhabitants of Palestine under the Romans far better deserves the name of captivity; for, after the massacre of countless thousands, the captives were reduced to a real bondage. According to Josephus, in his detailed account (*War*, especially vi, 9, 3), 1,100,000 men fell in the siege of Jerusalem by Titus, and 97,000 were captured in the whole war. Of the latter number, the greatest part were distributed among the provinces, to be butchered in the amphitheatres, or cast there to wild beasts; others were doomed to work as public slaves in Egypt. Only those under the age of seventeen were sold into private bondage. See *JERUSALEM*. 2. An equally dreadful destruction fell upon the remains of the nation, which had once more assembled in Judæa, under the reign of Hadrian (A.D. 138), which Dion Cassius concisely relates; and by these two savage wars the Jewish population must have been effectually extirpated from the Holy Land itself, a result which did not follow from the Babylonian captivity. 3. Afterward, a dreary period of fifteen hundred years' oppression crushed in Europe all who bore the name of Israel, and Christian nations have visited on their head a crime perpetrated by a few thousand inhabitants of Jerusalem, who were not the real forefathers of the European Jews. 4. Nor in the East has their lot been much more cheering. With few and partial exceptions, they have ever since been a despised, an oppressed, and naturally a degraded people, though from them have spread light and truth to the distant nations of the earth. See *JEWS*.

IV. *Metaphorical Uses of the Term "Captivity."*—"Children of the captivity" is a common figure of speech denoting those who were in captivity, or perhaps sometimes literally their posterity (Ezra, iv, 1). "Turn again" (Psa. cxxvi, 1), "turn away" (Jer. xxix, 14), "turn back" (Zeph. iii, 20), or "bring again" (Ezek. xvi, 53) "the captivity," are figurative phrases, all referring to the Jewish nation in bondage and their return to Canaan. A similar expression is used in relation to individuals (Job xliii, 10): "The Lord turned the captivity of Job," i. e. he released him from the unusual sufferings and perplexities to which he had been in bondage, and caused him to rejoice again in the favor of God. "He led captivity captive," or

"he led captive those who had led others captive" (Eph. iv, 8), is a figurative allusion to the victory which our blessed Redeemer achieved over sin, the world, death, and hell, by which our ruined race are brought into bondage (Psa. lxxviii, 18; Rom. viii, 21; Gal. iv, 24; Heb. ii, 15; 2 Pet. ii, 19; Col. ii, 15). See *EXILE*.

Capuchins, monks of the strictest observance of the rule of St. Francis, called *Capuchini* on account of the great pointed *capuchon* (or cowls) which they wear. Matteo di Baschi, an Observant friar, of the convent of Monte Falcone, in the duchy of Urbino, in Italy, was the founder of this reformed order in 1525. Pretending that the Franciscans were no longer strict followers of St. Francis, as they wore a different cowl, did not let their beard grow, and had mitigated the vow of poverty, he, with the pope's permission, and accompanied by some others, retired into a solitary hermitage of the Camaldoli near Massacio. The reformed monks were much persecuted by the Franciscans, who drove them from place to place. In 1528 Pope Clement VII allowed them to put themselves under the obedience of the Conventuals, and to take the title of Friars Hermits Minors, with the right of electing a vicar general. Their first establishment was at Colmenzone, near Camerino. In 1529 they held the first general chapter at Alvacina, and drew up the rule of the new association, which received alterations and additions in 1536 and 1575. It enjoins, among other things, that the Capuchins shall perform divine service without singing; that they shall say but one mass each day in their convents; that they shall observe hours for mental prayer morning and evening, days for disciplining themselves, and days of silence; that they shall always travel on foot, and avoid ornament and costly furniture in their churches, contenting themselves with having the curtains of the altar of stuff and the chalices of tin. Pope Paul III, in 1536, gave them the name of *Capuchins of the Order of Friars Minor*, and subjected them to the visitation and correction of the Conventuals. In the same year the two founders and first vicars general of the order, Matteo di Baschi, and his friend Ludovico di Fossombrone, were excluded from the order for disobedience. The fourth vicar general, Ochino, one of the most famous preachers of Italy, became a Protestant in 1548. For a time the whole order was forbidden to preach, and threatened with suppression, but their submission and humble petitions averted this danger. From this time dates the development of their peculiar character, their rapid spread, and great influence in the Romish Church. A severe asceticism, a designed neglect of both mind and body, and a coarse, cunning eloquence, made them the favorite preachers of the lower classes of the people. The order has never produced great scholars, but has been joined sometimes by princes (e. g. Alfonso di Este, duke of Modena) and by statesmen tired of the world. In 1578 the order was introduced into France, in 1606 into Spain, and in 1619 their superior was permitted to take the name of General. In the last century they counted more than 60 provinces, 8 custodies, nearly 600 convents, and 25,000 members, without taking into account the missionaries in Brazil, Congo, Barbary, Egypt, and the East.

In 1856 the order had 89 provinces, 4 custodies, and



Capuchin Monk, without Cloak.

5 vicariates general in *partibus infidelium*, with about 11,900 members. A province must have at least 4 complete convents. Houses with less than four monks are called *residences*. The greatest number of provinces was, until 1859, in Italy; but, together with other monastic communities, nearly all the convents of the Capuchins have since been suppressed by the government of the kingdom of Italy. It has also convents or residences in France, Switzerland, Austria, Prussia, several other German states, Belgium, Holland, Ireland, England, Poland, Turkey, Greece, India, the Seychelles, and South America. In most of these countries the number of convents is on the increase. The *custodies* (with less than four convents) are in Ireland, Croatia, Lucca, and Westphalia. The latter, which comprises Prussia, Hanover, and Hesse-Darmstadt, was established in 1861. The first convent in England was founded in 1858 by Viscount Fielding. The *vicariates general* with episcopal jurisdiction are in Tunis, Abyssinia, Patna, Bombay, and Agra. In South America they have some residences, and are penetrating more and more into the interior. About 500 members are employed as foreign missionaries, and there is a seminary for preparing chosen young Capuchins for foreign missions in Rome.

There is likewise an order of Capuchin nuns (*Capuchines* or *Capucines*), also known as *Nuns of the Passion*, instituted by Maria Lorenza Longa, the widow of a noble Neapolitan. Their first establishment was at Naples, in 1538, when they took the third rule of St. Francis. They, however, soon quitted this for the more rigid rule of St. Clara. Of this order only a few convents are left, most of them in Italy and Switzerland, with a few in France, Bavaria, and South America. See *Annales Sacr. hist. ordinis minorum S. Francisci, qui Capucini nuncupantur* (Lugd. 1632); Wadding, *Annales ord. Minor. t. xvi*; Fehr, *Gesch. der Möncheorden, nach Henrion*, i, 308.

Capuciati or **CAPUTIATI**: (1.) A sect which arose about A.D. 1186, named from a cowl or cap which they wore as a badge. It was founded by one Durand, reputed to have been a carpenter (others say a butcher), who published that the Virgin had appeared to him and given him her image, and that of her Son, with this inscription: "O Lamb of God, that takest away the sins of the world, grant us peace!" adding that she directed him to take the image to the bishop of Puy, in order that he might form a society of all those who desired to restore peace in church and state; who should, in token of their belonging to such a society, wear a white hood, or capuche, with a leaden image like the pattern. Many persons in Burgundy joined the sect. They were put down by Hugo, bishop of Auxerre. (2.) Some of the Wicliffites, in England, also obtained the name of *Capuciati* about the year 1387, because they refused to uncover their heads before the Host.—Mosheim, *Ch. Hist. cent. xii, pt. ii, ch. v, § 15*; Bergier, *Dict. de Théologie*, i, 361.

CAR. See BETH-CAR; CARR; CART.

Cara (or **KARAH**), Joseph, son of Simeon Cara (q. v.), a celebrated Jewish commentator on the O. T., lived in the north of France toward the end of the eleventh century. Following the example of his uncle, Mensehem ben-Chelbo, Joseph Cara abandoned the allegorical mode of interpretation of which his own father was a great defender, and devoted his talents to a simple and grammatical interpretation of the Biblical text. His commentaries, which extend over nearly the whole Old Testament, are distinguished for logical sequence and lucid diction, but of most of them fragments only have thus far been printed. His glosses upon Rashi's commentary on the Pentateuch (*פרש"י תורה*) have mostly been printed by Geiger (*Zeitschr. iv, 138-40* [Stuttg. 1839]; see his *Beiträge zur jud. Lit.* p. 17 [ib. 1847]), and some of them under

the title *לקו"ש*, in his *נפטי נפטי* (Bresl. 1847), and *Parshandatha* (Leipzig, 1855). Fragments of his commentary on *The Prophets* (*פרש"י נביאים*) are given by De Rossi in his *Varia Lectiones* (Parma, 1785); *ק"פ על ד'*, by Leopold Duker (Eslingen, 1846); *נפטי נפטי*, by Geiger (Bresl. 1847). Fragments of the commentaries on *Ether*, *Ruth*, and *Lamentations* have been published by Dr. Adolph Jellinek (Leipzig, 1855). The commentary on *Lamentations* has been printed in Naples, 1849, and reprinted in the collection, *הדר"י הקב"ה* (Metz, 1849). The commentary on *Job* is reprinted in Frankel's *Monatschrift für Geschichte und Wissenschaft des Judenthums* (1856-58). His commentary on *Hosea* was published in Breslau, 1861. See Fürst, *Bibliotheca Judaica*, ii, 170; Kitto, *Cyclop.* i, 444.

Cara, Simeon, ben-Chelbo, also called R. Simeon had-Darshan, a celebrated Jewish commentator, lived in the eleventh century. He was a brother of the celebrated Mensehem ben-Chelbo, and received the name Kara (ק"ר) in the synagogue for his lesson on the Sabbath, and the name had-Darshan from his collecting and explaining (*הדר"ש*) the Midrashim. Cara is the author of the celebrated *Jalkut* (*ב"ר לקי"ט*), a collection of Midrashim on almost every verse of the Old Testament. He brought together a catena of traditional expositions from upward of fifty different works of all ages, many of which are of great value. Ten different editions of this work appeared between 1526 and 1805; one of the best and most convenient is that published at Frankfort on the Maine, 1687, folio. See Rapaport in the Hebrew annual called *Kerem Chemed* (*פר"מ חמ"ד*, vii, 4, etc.); Zunz, *Die Gottesdienstlichen Vorträge der Juden* (p. 295-308); Steinschneider, *Catalogus Librorum Hebraeorum in Bibliotheca Bodleiana* (Berlin, 1852-60, col. 2600, 2604; Kitto, *Cyclop.* i, 444).

Caraba'sion (*Καραβασίων* v. r. *Ῥαβασίων*, Vulg. *Marimoth*), a name given (1 Esdr. ix, 84) as one of the "sons" of Maani (Bani) that divorced his Gentile wife after the exile, and apparently corresponding to the CHELLUH (q. v.) of the Hebrew text (Ezra x, 85), although the list is here greatly corrupt.

Caracalla or **CARACALLUS** (properly **MARCUS AURELIUS ANTONINUS BASSIANUS**), a Roman emperor. He was son of the emperor Septimius Severus, and was born at Lyon, A.D. 188. The name Caracalla never appears on medals, but was a nickname from his long-hooded tunic, made in the fashion of the Gauls, and so called in their language. "After his father's death, A.D. 211, he ascended the throne as co-regent with his brother Publius Septimius Antoninus Geta, whom he afterward caused to be murdered. Having bribed the Prætorians to make him sole emperor, Caracalla next directed his cruelty against all the adherents of Geta, of whom twenty thousand of both sexes—including the great jurist Papinianus—were put to death. Innumerable acts of oppression and robbery were employed to raise supplies for the unbounded extravagance of the despot, and to pay his soldiers. In his famous constitution, he bestowed Roman citizenship on all his free subjects not citizens—who formed the majority, especially in the provinces—but simply in order to levy a



Bust of Caracalla.

greater amount of taxes on releases and heritages, which were paid only by citizens. In his campaigns he imitated at one time Alexander, at another time Sulla; while his main object was to oppress and exhaust the provinces, which had been in a great measure spared by the tyranny of former emperors. In 217 he was assassinated, at the instigation of Macrinus, prefect of the Prætorians, by one of his veterans named Martialis, on the 8th of April, 217, on the way from Edessa to Carrhæ. Historians paint the life of Caracalla in the darkest colors. Among the buildings of Caracalla in Rome, the baths—Thermæ Caracallæ—near Porta Copena, were most celebrated, and their ruins are still magnificent." Caracalla, cruel to mankind, was yet indifferent to religion, and during his reign no new persecutions were devised against the Christians. Spartianus (*Vita Caracalli*, l. 707) tells a story of his being greatly affected, at seven years of age, on hearing that a Jewish boy had been punished for his religion. From a passage in Tertullian (*ad Scapulam*, cap. 4) it is inferred that Caracalla had a Christian nurse.—Chambers's *Encyc.*; Lardner, *Works*, vii, 810–812; Gibbon, *Dec. and Fall* (ed. Milman), ch. vi.

Caraccioli, GALEAZZO, marquis of Vico, one of the earliest and most distinguished followers of the Reformation in Italy. Born in Naples, in 1517, of a noble family, which had given warriors to the field and cardinals to the Church, he began life with the most brilliant prospects. Married at twenty to Vittoria, daughter of the duke of Novera, he had by her six children. In 1541 he heard Peter Martyr, and after a long and painful investigation, in spite of the distressing conviction that he would have to leave family, friends, home, and wealth in abandoning Rome, he became a Protestant, and in 1551 escaped to Geneva. His father, his uncle cardinal Caraffa, his wife, and his children sought for many years to change his purpose, but in vain. In Geneva he acquired the entire confidence of Calvin, who dedicated to him his Commentary on 1 Corinthians (edit. *Tholuck*, p. 205). He died in great peace, 1586. His life, by Balbano, will be found in the *Museum Helveticum*, viii, 1748, p. 519; and, abridged, in Gerdes, *Specimen Italia Reformationis* (Lugd. Bat. 1765, 4to). See M'Crie, *Reformation in Italy*; Herzog, *Real-Encyclopædie*, ii, 574.

Caraites. See KARAITES.

Caramuel (*Juan de Lobkowitz*), a Spanish theo-

gian, was born at Madrid, May 23, 1606. He became a Cistercian, and after several preferences, among which was the abbey of Melrose, in Scotland, was made vicar general of the archbishopric of Prague. When the Swedes, in 1648, besieged the city, Caramuel, forgetting his episcopal character, set himself at the head of a body of ecclesiastics on the battle-field. His services were rewarded by the emperor with a collar of gold. In 1657 he was made bishop of Campagna, in Naples, which he resigned in 1678, but afterward became bishop of Vigevano, in the Milanese, where he died, Sept. 8, 1682. He was "a man of vast but ill-digested learning, with an ill-regulated imagination. His moral theology (*Theologia Moralit*, Louvain, 1643, fol.) is so universally decried that even Romanists have censured it. He taught that the commandments of the Decalogue are not immutable in their nature, and that God is able to change or dispense with them, as in cases of theft, adultery, etc.; he also held that the smallest degree of *probability* justified any criminal action." A list of his numerous writings (37 volumes) is given by Nicolas Antonio, *Bibliotheca Hisp. Nova*.—*Novo. Biog. Générale*, viii, 666.

Caranza. See CARRANZA.

Caravan, the Arabic name for a body of pilgrims or merchants travelling in the East. Orientals who have occasion to journey—whether for pleasure, religion, or profit—usually do so in companies, for the sake of society as well as protection. Hence the most motley associations may take place. They often consist of hundreds of persons, mostly mounted on camels, which (including those for baggage) frequently amount to several thousands. Such spectacles are common in all parts of Turkey, Persia, and Arabia, especially through the sandy deserts. They march at first disorderly, but after a short period of practice with great regularity, mostly by night, in companies which are each kept together by a large beacon-fire on the top of its own peculiar standard. Much time is consumed in packing and unpacking; but when this confused scene of preparation is over, they travel with great uniformity (see Ezek. xii, 8) from about eight P.M. till about midnight (Luke xi, 5, 6). In the cooler seasons they journey by day, only halting for a brief repast at noon. Seven or eight hours is the usual day's stage (Hornemann, p. 150), or about 17 to 20 miles. See TRAVELLER.



Modern Oriental Caravan.

1. *Commercial Caravans*.—The earliest of these on record is that to which Joseph was sold (Gen. xxxvii), consisting of Ishmaelites (ver. 25), Midianites (ver. 28), and Medanites (ver. 36, Heb.), who were on the high-road through Dothan to the mart of Egypt with the spices of India and Hadramaut (Vincent, *Commerce and Navigation of the Ancients*, ii, 262). Such often avail themselves at the present day of the second class of caravans mentioned below. See **COMMERCE**.

2. *Religious Caravans*.—Such companies of pilgrims pass regularly along the route (hence termed the *Haj*) to Mecca, four each year; one from Cairo, consisting of Barbars, a second of Turks from Damascus, a third of Persians from Babylon, and the fourth of the Arabians and Indians from Zibith, at the mouth of the Red Sea. They are under the strictest discipline, a chief or *basib* being in command, and five officers having respectively charge of the march, the halt, the servants and cattle, the baggage, and the commissariat. The *kybeer*, or guide, is also an indispensable companion—a person not only well acquainted with the route, the wells, the hostile or friendly tribes, and other features on the route, but also skilled in the signs of the weather, and an individual of general sagacity and fidelity. See **PILGRIM**.

These large travelling masses illustrate many features of the exodus of the Israelites from Egypt. They, too, had their leader, Moses, and were divided into twelve companies, each with its chief (Num. vii), and ranged under its distinctive banner (Num. ii, 2). They set out in tumult (Exod. xii, 11), but were soon reduced to almost military order, starting at the blast of trumpets (Num. x, 2, 5), under the guide of the fiery pillar (q. v.). Hence, too, the anxiety of Moses to secure the services of Hobab (q. v.) as guide. See **EXODE**.

The processions of Israelites to their national festivals at Jerusalem were probably made up very much after the caravan style, villages and acquaintances travelling together by companies. Hence the youthful Saviour was not missed until the party halted at night (Luke ii, 44) at a place which tradition fixes about three miles from Jerusalem (Munro, *Summer Ramble*, i, 265); for the first day's journey is always a short one.—Kitto, s. v. See **CARAVANSERAI**.

Caravanserai, the Arabic name of a building for the accommodation of strangers in sequestered places, while *khan* is the usual designation of a similar structure situated in or near towns. See **KEAN**.

In the days of the earlier patriarchs there seems to have been no such provision for travellers, for we find Abraham looking out for their entertainment (Gen. xxiii), and the visitors of Lot proposed to lodge in the street, apparently as a matter of course (Gen. xix, 2), just as modern Orientals often do, wrapped in their hykes, although in Arab towns generally the stranger is conducted by the sheik to the *menall*, where he is provided for the night (La Roque, *De la Palestine*, p. 124. In Egypt, however, there seems to have been some such building (Gen. xiii, 27), probably only a rude shed. The innkeepers in that country were usually women (Herod. ii, 98), just as in the days of the Hebrew spies (Josh. ii, 1); apparently women of easy virtue (Heb. xi, 81; James ii, 25), if not absolutely courtesans. See **HABLOT**. In the times of Christ and his apostles, inns must have been common in Palestine, yet the frequent injunction contained in the Epistles to entertain strangers (e. g. Heb. xiii, 2; Rom. xii, 8) show that they were very inadequate in their arrangements. See **HOSPITALITY**. They are mentioned in the N. T. under two names, *πανδοχείον*, or house for the reception of all kinds of guests, where the good Samaritan took the wounded stranger (Luke x, 34); probably a building like the modern comfortable and unfurnished ones on the great Eastern routes of travel, with a host (or janitor), however, who, on urgent occasions, will furnish supplies to the sick and

destitute. The other word is *κατάλυμα*, properly the upper room reserved in large houses for guests (Mark xiv, 14; Luke xxii, 11), and also applied to the place where the nativity occurred (Luke ii, 7). The tradition connects this event with a cave (Justin Martyr, *Dial. c. Tryph.* p. 808; Origen, *cont. Cels.*) and the spot, as such, is still pointed out. See **ΒΕΤΗΛΕΗΜ**. But this is opposed to all the circumstances and usages of the case. The exact distinction between this and the previous term has been matter of dispute, but the editor of the *Pictorial Bible* (note in loc.) suggests the most probable explanation, that the stable, in the retirement of which Mary brought forth the Saviour, was one of the stalls running along the outside of the building, behind the apartments destined for the guests; and that the "manger" (q. v.), or *φάρμη*, was not the crib or contrivance for this purpose known to us (for such are not used in the East), but simply the projection of the floor of the guest-room into the cattle-shed, which was probably lower on the ground (see Strong's *Harmony and Expos. of the Gospels*, p. 14). See **INN**.



Modern Oriental Caravanserai.

Oriental "inns," whether called khans or caravanserais, are not at all comparable, in point of comfort and convenience, with modern hotel accommodations, nor have they the least resemblance to the character and appurtenances of a respectable tavern. A khan is always to be found in the neighborhood of a town; and caravanserais, of various sizes and degrees of completeness, are generally disposed at regular stages along public roads, especially the mercantile and pilgrim thoroughfares, according to the character of the country. They have usually been built by rich merchants for trading purposes, or by wealthy devotees as an act of religious munificence. At a distance they resemble a castellated fort, but on a nearer approach are found to be a simple quadrangular building, enclosed by a high wall, usually about 100 yards on each side, and about 20 feet high, resting on a stone foundation. In the middle of the front there is a large arched entrance, with a porter's lodge on one or both sides, and apartments for the better class over it, surmounted by a dome. The interior is an open space for cattle, baggage, etc., with a well or fountain in the middle. Along the sides of this inner court-yard are piazzas opening every few yards into arched recesses or alcoves for travellers, having an inner door communicating with a small oblong chamber, sometimes lighted at the farther end, but entirely destitute of furniture, shelves, or closets. These cells are intended for dormitories, but travellers usually prefer the open door-way, which is either paved or level and hard earth, and raised two or three feet above the general area of the court. These sets of rooms have no communication with each other, but in the middle of the three sides there is a large hall for general assemblages; at the end of each side is a staircase for ascending to the flat roof for enjoying the breeze and the landscape. These lodging-chambers are thus usually on the ground-floor; but in the few buildings which have two stories, the lower rooms are used for servants, storage, etc., while the upper story serves for the travellers themselves. Sometimes also the porter's lodge affords a supply of commodities for their use, and cooks are occasionally found in attendance. Generally, however, the accommodations are of the most wretched description—bare walls, rooms filled with dirt and vermin, and no cooking apparatus to be obtained for love or money. The traveller must do all his own work, and even furnish his own subsistence. His baggage must supply his bed, his clothing must

be his covering. He is usually obliged to content himself with such cold food or fruits as he has himself brought. His outfit should therefore consist at least of the following articles: a carpet, a mattress, a blanket, two saucupans with lids, contained within each other; two dishes, two plates, etc., a coffee-pot, all of well-tinned copper; also a small wooden box for salt and pepper, a round leather table, which he suspends from his saddle, small leather bottles or bags for oil, melted butter, water, a tinder-box, a cocoanut cup,

some rice, dried raisins, dates, and, above all, coffee-berries, with a roaster and a wooden mortar to pound them: all this is in addition to such more substantial provisions as he may prefer or can conveniently carry. The porter in attendance can only be relied upon to show him his chamber, and perhaps furnish him with a key. In case of sickness, however, the latter is generally able to administer simple remedies, and may even set a broken limb.—Kitto, s. v. See CARAVAN.



Interior of a Caravanserai.

Carbuncle is the rendering in the Auth. Vers. of the following Heb. and Gr. words: 1. עֲבָדָךְ, *ekdach'*, only Isa. liv, 12 (Sept. κρύσταλλος, Vulg. [*lapis*] *sculptus*), some sparkling gem (from עָרַב, to inflame). 2. בְּרֵיקָה, *bare'keth*, only Exod. xxviii, 17, and xxxix, 10, as the third in the first row of the high-priest's breastplate (Sept. σμάραγδος, Vulg. *smaragdus*, i. e. emerald); or בְּרֵיקָה, *barekath'*, only Ezek. xxviii, 18 (Sept. ὀνύχιον, Vulg. *smaragdus*). From the etymology (עָרַב, to flash), we assume that a stone of a bright coruscant color is meant. Kallisch translates it *smaragd*, or emerald, and says it is a sort of precious corundum of strong glass lustre, a beautiful green color, with many degrees of shade, pellucid and doubly refractive. Pliny enumerates twelve species of emerald. They are not rare in Egypt (see Braun, *de Vest. Sacerdot.* p. 517 sq.). 3. ἄνθραξ, lit. a coal of fire, Tobit xiii, 17; Eccles. xxxii, 5. 4. The carbuncle is thought by many to be denoted by the word נֶפֶשׁ, *no'phek* ("emerald," Exod. xxviii, 18; xxxix, 11; Ezek. xxvii, 16; xxviii, 18). See EMERALD. Under the name "carbuncle" are comprehended several brilliant red stones of the clay family which resemble a glowing coal, such as the ruby, the garnet, the spinel, but particularly the *almadin*, that is, the noble Oriental garnet, a transparent red stone with a violet shade and strong glass lustre. Probably it is not so hard as the ruby, which, indeed, is the most beautiful and costly of the precious stones, of red color, but, at the same time, so hard that engravings cannot easily be made in it (Rosenmüller, *Alterth.* iv, 1, 34). In the present state of our knowledge respecting the ancient Hebrew mineralogy, it is impossible to determine with precision what particular gem is denoted by either of these terms, although they all evidently were precious stones of a brilliant fiery hue. See GEM.

Car'cas (Heb. כַּרְקָס, *Karkas'*, comp. the Sanscrit *karkaça*, *severs*; Sept. θαβάζ v. r. θαρσά, Vulg.

Charchas), the last named of the seven eunuchs ("chamberlains") in the harem of Ahasuerus (Xerxes), who were directed to bring queen Vashti into the royal convivial party (Esth. i, 10). B.C. 488.

Carcass (חֵרֶס, *cherech*, *cherech*, *cherech*, *cherech*, *cherech*), the dead body of a man or beast (Josh. viii, 29; Isa. xiv, 19; Heb. iii, 17, etc.). According to the Mosaic law, any Israelite became ceremonially unclean until the evening (and in turn rendered whatever he touched unclean, Hag. ii, 14; comp. Num. xix, 22), by (unwitting) contact, under any circumstances, with a dead animal of the "unclean" class (Lev. v, 2; xi, 8 sq.; comp. Deut. xiv, 8), or with any "clean" animal, in case it had not been regularly slain according to the prescribed mode (Lev. xi, 39 sq.). The eating of any (clean) beast that had died an accidental or natural death was still more strictly forbidden (Lev. xxii, 8; comp. Ezek. iv, 14; xlv, 81); but it might be sold as food to a foreigner (Deut. xiv, 2). Carrion was doubtless buried or buried. On the sepulture of persons found dead, see HOMICIDE. An unburied carcass (Jer. xxxvi, 30; Psa. lxxix, 8) was considered by the ancients the height of indignity and misfortune (Virgil, *Æn.* x, 559). See BURIAL. The Levitical enactments respecting all dead bodies evidently had their origin in sanitary reasons in a climate so liable to pestilence (Michaelis, *Mos. Recht*, iv, 309 sq.). On the incident of the beehive in the skeleton (Judg. xiv, 8), see BEE.—Winer, i, 2. On the allusion to the vulture's scent for putrid flesh, Matt. xxiv, 28 (Loder, *De cadavere Judææ, ab aquilis Romanis discerpendo*, Argent. 1715; Rechenberg, *De adagio Christi*, etc., Lips. 1696), see EAGLE. Comp. Wemys, *Symbol. Dict.* s. v.

Car'chamish (1 Esdr. i, 25). See CARCHEMISH.

Car'chemish (Heb. *Karkemish'*, פְּרֵקֶמֶשׁ, prob. *fort of Chemosh*; Sept. *Χαρμεις* v. r. *Καρκαμεις* in Jer., but omits in Chron. and Isa., *Καρκαμεις* in 1 Esdr. i, 5), mentioned in Isa. x, 9 among other places in Syria which had been subdued by an Assyrian king,

probably Tiglath-pileser. That Carchemish was a stronghold on the Euphrates appears from the title of a prophecy of Jeremiah against Egypt (xlvi, 2): "Against the army of Pharaoh-necho, king of Egypt, which lay on the river Euphrates, at Carchemish, and which Nebuchadnezzar, the king of Babylon, overthrew, in the fourth year of Jehoiakim, the son of Josiah, king of Judah," i. e. B. C. 606. According to 2 Chron. xxxv, 20, Necho had advanced with his ally Josiah, the father of Jehoiakim, against the Babylonians, on the Euphrates, to take Carchemish, B. C. 609. These two circumstances—the position of Carchemish on the Euphrates, and its being a frontier town, render it probable (see Layard, *Nineveh and Babylon*, p. 199) that the Hebrew name points to a city which the Greeks called *Καρχημις*, the Latins *Carcemium*, and the Arabs *Kerkemesh* (Schultens, *Index. Geogr. s. v.*; Ritter, *Erdk.* xi, 695); for this too lay on the western bank of the Euphrates, where it is joined by the Chaboras (comp. Bochart, *Phaleg*, iv, 21; Cellarii *Notit.* ii, 715 sq.; Michaelis, *Supplem.* p. 1352 sq.). It was a large city, and surrounded by strong walls, which, in the time of the Romans, were occasionally renewed, as this was the remotest outpost of their empire, toward the Euphrates, in the direction of Persia (Ammian. Marcell. xxiii, 5; Zozim. iii, 12; Procop. *Bell. Pers.* ii, 5; comp. Procop. *Edif.* i, 6; Ptolemy, v, 18, 6). Carchemish is named in the cuneiform inscriptions (q. v.), which show it to have been, from about B. C. 1100 to B. C. 850, a chief city of the Hittites, who were masters of the whole of Syria from the borders of Damascus to the Euphrates at Bir, or Bireh-jik; it is also mentioned on the Egyptian hieroglyphical sculptures (Layard, *ut sup.* p. 305, 538). At the point where the Khabur (the ancient Chebar) joins the Euphrates, there are large mounds on both banks of the former river, marking the sites of old cities, or perhaps of different sections of one great city. The mound on the right bank is crowned with a modern Arab village, called *Abu Serzi*, or "Father of Palaces" (Chesney, *Euph. Exp.* i, 118). It stands on a narrow wedge-shaped plain, in the fork of the two rivers. This corresponds exactly to Procopius's description of Circesium, who says that its fortifications had the form of a triangle at the junction of the Chabur and Euphrates (*Bell. Pers.* ii, 5). This seems to be the true site of Carchemish. It was visited by Benjamin of Tudela in the twelfth century, who found in it two hundred Jews (*Early Travels in Pal.* p. 93). According to others, however (following the Syriac and Arabic versions), it lay very much higher up the Euphrates, occupying nearly the site of the later *Mabug*, or Hierapolis. Dr. Hinks maintains, from his reading of the Assyrian inscriptions, that the true site of Carchemish is at or near *Bir*, on the opposite bank of the Euphrates, and about 200 miles higher up than it is generally thought to be (*Jour. Sac. Lit.* July, 1854, p. 408). Still less probable is the supposition that it is the *Cadytis* of Herodotus (see Heinius *Dissert. Sacr.* Amst. 1726, p. 28). See CALNEH.

Cardinal (*cardinalis*, principal; from *cardo*, a hinge), the title of an eminent class of dignitaries in the Roman Church, so styled as if the axle or hinge on which the whole government of the Church turns; or as they have, from the pope's grant, the hinge and government of the Romish Church. Pope Eugenius IV states the derivation from *cardo*, a hinge, as follows: *Sicut per cardinem volvitur ostium domus, ita super hos Sedes Apostolica, totius Ecclesie ostium, quiescit et sustentatur* (see Dufresne, s. v. *cardinalis*).

1. *Cardinal Priests, etc.*—In early days the name cardinal was used with great latitude in the Roman Church. Its first definite application was to the principal priests of the parishes of Rome; the chief priest of a parish, next to a bishop, being presbyter *cardinalis*, to distinguish him from the other priests who had no church. It is uncertain when the term was first

applied, but it seems that Stephen IV (770) was the first who selected seven bishops out of the number of the see of Rome, and gave them the title of cardinal, obliging them to say mass every Sunday in St. Peter's. Leo IV, in a council of Rome held in 858, calls them *presbyteros sui cardinalis*, and their churches *parochias cardinales*. At a subsequent period the priests and deacons of other cities of importance assumed the title of cardinal, to distinguish them from other priests and deacons over whom they claimed supremacy; but the popes subsequently ordained that none but those whom they had chosen should be honored with that title. Among those whom the popes thus appointed were the seven bishops *suburbicari*, who took their titles from places in the neighborhood of Rome. These bishops were called *hebdomadarii*, because they attended the pope for a week each in his turn. These cardinals took part with the Roman clergy in the election of the pope, who was generally chosen from their number. But it was not until the edict of Nicolas II, A. D. 1059 (see below), that the body of cardinals, as such, had a proper existence as a recognised branch of the ecclesiastical system.

2. *College of Cardinals.*—"The college of Cardinals, in its origin, was nothing else than the council which, according to the canons, every metropolitan was obliged to consult, and in which, during a vacancy, all the metropolitan powers resided, viz., the synod of provincial bishops, and the chapter of the metropolitan church; and it is not difficult to see that this college would share in the supreme glory of the see of Rome, in the same proportion as every other church participated in the honor of its particular metropolitan. It was not, however, for a long time that the cardinalate attained to its present excessive and usurped degree of power and dignity. In the Synod of Rome, under Benedict VIII, in 1015, the cardinals, priests, and deacons still signed after the bishops, and the cardinal-bishops after other bishops of older standing in the order than themselves; but in 1050 we find a vast change, for Humbertus, bishop of Silva Candida, who was a cardinal-bishop of the see of Rome, took precedence at Constantinople of the archbishop of Amalfi; and from that time we perceive the cardinal-bishops, and soon even the priests and deacons, arrogating to themselves that precedence over all other ecclesiastical dignitaries which they now possess. This, however, was not done without resistance. Thus, in 1440, the archbishop of Canterbury refused to allow to the cardinal-archbishop of York the precedence which he claimed; whereupon Pope Eugenius IV wrote to the former, reprehending him for his conduct, and declaring that the cardinalate had been instituted by St. Peter himself, and that the dignity of the cardinals, who, with the pope, governed the Universal Church, and sat in judgment upon bishops, was, past all doubt, greater than that of even patriarchs, who had jurisdiction over only a part of the Church, and from whom there lay an appeal to the see of Rome. The same dispute occurred between the cardinal-bishop of Cracow and the primate of Gnesna in 1449. As time went on, these arrogant pretensions of the college increased: we find the cardinals saying to Pope Pius, *Cardinales pares Regibus haberi*; so the cardinal of Pavia, in several places, *Cardinalem . . . cujus dignitas antefertur Regibus*. In 1561 the cardinals of Lorraine and Guise refused to give precedence to the princes of the blood royal. To such an excess had this arrogance and grasping at dignity attained in the sixteenth century, that the bishops at the Council of Lateran, under Leo X, in 1512, came to the resolution either to keep away altogether, or to negative every proposition, until their grievances were redressed.

"The Council of Rome, under Nicolas II, 1059, grants to the college of Cardinals, or rather (can. i) to the cardinal-bishops, the principal voice in the election of the pope; and, according to Peter Damianus, the

election of a pope contrary to the opinion of the cardinal-bishops was null. Pandolphus remarks, with regard to the election of Gelasius II, that although all the cardinals, clergy, and people had a voice in the election, the cardinal-bishops alone had the right of approving or disapproving the election, and consecrating the elect. None but cardinals are now eligible to the papacy. Pius IV seems to have been the first who restricted the election to the cardinals only" (Landon, *Eccle. Dictionary*, s. v.).

8. *Number of Cardinals*.—In 1381 there were twenty, and after the death of Clement VI, in 1362, the cardinals resolved that that number should not be exceeded. In 1378, at the election of Urban VI, there were twenty-three. The Council of Basle fixed the number at twenty-four, and the college itself appears to have been all along very jealous of an increase to its numbers. However, Leo X set the example of a large increase, creating in one day thirty-one new cardinals, in order to neutralize the opposition made to him by a cardinal who had formed a party in the college. The bull *Compacti*, in 1556, fixed the number at forty, and forbade to create more. But the college has since been enlarged to seventy members, the number at which it was finally fixed by the bull of Pope Sixtus V in 1586: six of these are bishops, fifty priests, and fourteen deacons. The number of cardinal-bishops was at first seven, but it was shortly afterward altered to six, at which it has ever since remained. These bishops, on Sundays and festivals, officiate as the pope's vicars at the altar of St. Saviour, in the church of Lateran, or assist the pontiff when he officiates in person. The cardinal-bishops in 1867 were Mario Mattei, bishop of Ostia and Velletri, July 2, 1832; Constantino Patrizi, bishop of Porto and St. Rufina, June 23, 1834; Luigi Amat, bishop of Palestrina, May 19, 1837; Anthony Cagiano de Azevedo, bishop of Frascati, Jan. 22, 1844; Girolamo d'Andrea, March 15, 1852; Ludovico Alfieri, bishop of Albano, April 21, 1845. A list of the cardinal-priests and cardinal-deacons is given in the *Almanac de Gotha* and in the Roman Catholic almanacs annually.

4. *Costume*.—The dress of a cardinal is a red soutane, a rochet, a short purple mantle, and a red hat. The cardinals began to wear the red hat at the Coun-

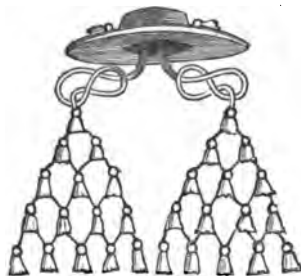

Cardinal's Hat.

cil of Lyons in 1245: the privilege was granted by Pope Innocent IV. Its color is designed to show that the cardinals are bound to shed their blood in the cause of the Church, if need be. A number of symbolical ceremonies accompany the investiture. The hat is given by the pope's own hands; and many cardinals who do not visit Rome die without ever having received it. The only exception is in favor of members of royal houses, to whom the hat is sent. As the cardinals, when dressed in the sacred vestments, could not wear the red hat, and had therefore no other distinction to mark the difference between them and prelates of an inferior rank except their place, Paul II permitted them to wear the red bonnet (*rubrum capitulum*), which previously had been the prerogative of the pontiff alone. They were also permitted the red habit by the same pope.

5. *The Style of the cardinals*, until the time of Urban VIII, was *Most Illustrious*; that pope, however, Jan. 10, 1630, granted to all the cardinals the title of *Eminence*. The cardinal-bishops are titled *Eminentissimi*. A carriage and livery servants are obligatory parts of the establishment of a cardinal.

6. *Form of making Cardinals*.—The pope alone can elevate any one to the cardinalate, which he does by declaring in the secret Consistory the names of those whom he proposes to make cardinals, saying *Habemus Fratres*. He afterward, in a public Consistory, puts the red bonnet on the head of the newly-appointed cardinal, signs him with the cross, and creates him cardinal, with the form of words following: *Ad laudem Omnipotentis Dei et Sanctae Sedis Apostolicae ornatum accipe galerum rubrum, insigne singularis dignitatis cardinalatus, per quod designatur, quod usque ad mortem et sanguinis effusione includitur, pro exaltatione Sanctae fidei, pace et quietate populi christiani, augmento et statu Sacrosanctae Romanae Ecclesiae te interpidum exhibere debes. In homine Patris †, et Filii †, et Spiritus Sancti †, Amen.*

7. *Duties, Privileges, etc., of Cardinals*.—The legal status of cardinals, and their relations to the papal see, are fixed by the *Ceremoniale Romanum*, by the decrees of Trent (*sess. xxvii, cap. 1, de Reform.*), by the bull of Sixtus V, *Religiosa Sancta*, April 18, 1587, and by later papal constitutions. By the canon of Trent, as above cited, it is decreed "that all and each of the particulars which have been elsewhere ordained, in the same synod, touching the life, age, learning, and other qualifications of those who are to be promoted to be bishops, the same are also to be required in the creation of cardinals of the holy Roman Church, even though they be deacons; whom the most holy Roman pontiff shall, as far as can conveniently be done, choose out of all the nations of Christendom, as he shall find persons competent. Finally, the same holy synod, moved by the so many most grievous difficulties of the Church, cannot avoid calling to mind that nothing is more necessary for the Church of God than that the most blessed Roman pontiff apply especially here that solicitude which, by the duty of his office, he owes to the universal Church, that he take unto himself, to wit as cardinals, men the most select only." No bastard, nor ecclesiastic who has not been a year in orders, can be chosen. Cardinals may be taken from any country, but the pope has always chosen a large majority of Italians. In October, 1866, of 59 cardinals, 39 were Italians by birth, 8 Frenchmen, 4 Spaniards, 4 Germans, 1 Croatian, 1 Belgian, 1 Portuguese, and 1 Irishman. The rank of cardinal is next to that of pope, and the pope is always chosen from their number. Since the time of Alexander III the right of electing the pope lies in the College of Cardinals. See POPE. The pope often employs cardinals as ambassadors, and the individual thus employed is styled *Legate a Latere*. A cardinal-legate acted, before the recent absorption of the Papal States by the kingdom of Italy, as governor of the northern provinces of the Papal States, which thence received the name of legations. The chief secretary of state, the *Camerlengo*, or minister of finances, the vicar of Rome, and other leading officials, are always chosen from among the cardinals. Their dignity is held to place them in the rank of European princes; and, so long as the temporal power of the popes lasted, they held civil as well as ecclesiastical offices. For the *Congregations*, i. e. papal commissions, which are under the direction of cardinals, see CONGREGATION, PAPAL.

8. *Literature*.—Ferraris, *Promta Bibliotheca*, ii, 99; Kleiner, *De Orig. et Antiq. etc. Cardinalium*; Buddens, *De Orig. Card. Dignitatis* (Jena, 1695, 4to); Bez, *De Orig. et Antiq. Cardinalium* (Heidelberg, 1767, 4to); *History of the Cardinals, to Pope Clement IX*, with the Italian (Lond. 1670, fol.); Augusti, *Denkwürdig.* p. 151; Thomassin, *Vet. et Nov. ecclesiae Disciplina* (vol. i, c.

118); Siegel, *Handbuch der Alterthümer*, i, 829; Coleman, *Christian Antiquities*, ch. iii, § 6; Herzog, *Real-Encyclopædie*, ii, 577. See CONGREGATION; CURIA; POPE.

Care'ah (2 Kings xxv, 28). See KARAH.

Carem (Καρέμ), one of the additional group of eleven cities of Judah (q. v.) interpolated by the Septuagint at Josh. xv, 59, and thought to be the present village *Am Karim*, about 1½ hour west of Jerusalem (Wilson, *Lands of Bible*, ii, 268; Schwarz, *Palest.* p. 96, 108; Robinson, *Later Bib. Res.* p. 367-9), but the position agrees better with that of BETH-HAOCEREM (q. v.).

Care's, JOHN, a minister of the German Reformed Church, was born in Northumberland county, Pa., in September, 1811. He studied theology in the Theological Seminary of the German Reformed Church at York, Pa. In 1832 he was licensed and ordained, and immediately became pastor of the German Reformed church in York, Pa., which post he occupied till his death, April 5, 1848. As a preacher, he was clear, compact, earnest, and solemn. In his manner, looks, and tones there was a peculiarity which belongs but to few—a kind of holy fascination which chained the hearer, and awed his conscience. Deep impressions were made wherever he preached; and for this, more than for any talents or learning he possessed, he was widely known and gratefully remembered. He possessed also the rare talent of preaching in both German and English with a correctness that made it impossible to determine which was his native tongue.

Carey, FELIX, son of Dr. William Carey, was born in 1786, assisted his father in his labors in Bengal, and died at Serampore in 1822. Among his works were, *Grammar and Dictionary of the Burman Language* (Serampore, 1814, 8vo); *Pali Grammar*; a Bengalee translation of the *Pilgrim's Progress*, etc. — Gorton, *Biog. Dictionary*, s. v.

Carey, WILLIAM, an eminent Baptist missionary, was born Aug. 17, 1761, at Paulersbury, Northamptonshire, England. His father was clerk of the parish, and master of a free school, in which his son received his elementary education. Having early embraced Baptist principles, he was in 1788 immersed in the river Nen, and afterward became pastor of a Baptist church in the village of Moulton. Here he was a diligent student, not only of theology, but also of natural history, botany, and modern languages. In 1787 he removed to Leicester, where he had every prospect of a useful and happy life. But his mind, long occupied with the duty of missionary exertions among the heathen, would not allow him to indulge the prospect of remaining at home. The cause of missions was his favorite theme; and having, at the urgent recommendation of his friends, Fuller, Ryland, and Sutcliffe of Olney, directed public attention to the subject through the press, steps were forthwith taken to commence practical operations among the Baptists. Chiefly through his exertions the Baptist Missionary Society was formed, Oct. 2, 1792. Mr. John Thomas, who had already spent some years in Bengal, and was imbued with a similar enthusiasm in the cause of missions to the heathen, had recently returned home. Carey volunteered for India, associated Thomas with him, and embarked June 18, 1793, accompanied by his wife and whole family, Mrs. Carey's sister having consented also to form one of the emigrants. Arrived in India, all their property was lost on the river Hooghly. Thus left destitute in a strange land, Carey retained unshaken faith in the providence of God. In 1794 he was employed by a Mr. Udney in an indigo factory, and was brought into close contact, in this sphere, with the natives. Here he spent five years, preaching, studying the Bengalee and Sanscrit languages, and establishing schools. Carey, having made satisfactory inquiries, resolved to establish his head-quar-

ters at Mudnabatty. The home society sent out two pious and excellent laborers—Marshman and Ward—the former of whom had been a teacher, the latter a printer. On their arrival at Calcutta in 1799, the Indian government refused permission to increase the missionary force at Mudnabatty, and accordingly forced them to break up that establishment at a great loss to their funds. Mr. Carey and his friends fixed their residence at the Danish settlement of Serampore, where, under the patronage of the governor, who was most friendly to the object of their mission, they enjoyed a tide of prosperity beyond their most sanguine expectations, and were placed in the centre of a much more numerous population, among whom they were free to carry on their work of Christian instruction. In 1801 the marquis of Wellesley, who founded the College of Fort William for instructing the youth in the Company's service in the vernacular languages of India, offered Carey the professorship of Bengalee. After considerable hesitation, and satisfactory evidence that the duties of this situation would not interfere with his missionary labors, Carey accepted the situation; and though the teaching of the Sanscrit and Mahratta languages, being subsequently devolved on the occupier of this chair, added greatly to the routine of his duties, he continued for thirty years—the whole period of its existence—to contribute to the usefulness and the fame of that institution. He now formed the acquaintance of learned pundits from all parts of India, through whom, in the course of years, he was enabled to translate the Scriptures into all the principal languages of Northern Hindostan. For the students in the college he had to compile grammars of the languages he taught them, and after many years he completed his voluminous Bengalee dictionary. All his philological researches were made subservient to the design of translating the Sacred Oracles into the vernacular languages of India. "The versions of the sacred Scriptures, in the preparation of which he took an active and laborious part, included the Sanscrit, Hindee, Brijbhassa, Mahratta, Bengalee, Voriga, Telinga, Kurnata, Maldivian, Gujaratee, Buloehee, Push-too, Punjabee or Shikh, Kashmeer, Assam, Burman, Pali or Magudha, Tamul, Cingalese, Armenian, Malay, Hindostanee, and Persian. In six of these tongues the whole Scriptures of the Old and New Testaments were printed and circulated; the New Testament appeared in twenty-three languages, besides various dialects, in which smaller portions of the sacred text were printed. The whole number of languages is stated at forty, and we are probably below the truth when we state that the Serampore press, under the auspices chiefly of Dr. Carey, was honored to be the instrument, in about thirty years, of rendering the Word of God accessible to three hundred millions of human beings, or nearly one third of the population of the world." He died June 9, 1834. See *Life of Carey*, by Enstace Carey (Lond. 1887, 2d ed. 12mo); Belcher, *Biography of Carey* (Phila. 1855, 18mo); Jamieson, *Cyclop. of Biography*, 103; Marshman, *Lives of Carey, Marshman, and Ward* (Lond. 1859, 2 vols. 8vo); *Christian Review*, i, 581.

Cargill, DONALD, one of the leaders of the Scotch Covenanters (q. v.), was born in Perthshire about 1610. He received his education at Aberdeen, entered the ministry of the Presbyterian Church, and was pastor of the Barony church at Glasgow. When the English Church was established in 1661, he refused to accept his charge from the archbishop, and also refused to leave Scotland when banished. After the battle of Bothwell Bridge, in which he took part, he fled to Holland, but returned to Scotland, and took part with the "Cameronians" (q. v.), or strict Presbyterians. Pursued by the military, he was surprised, with his friend, Henry Hall, at Queensferry, June 8, 1680, but he escaped, while Hall was mortally wounded. On Hall's person was found a "Declaration of

Principles," which caused a still hotter pursuit of Cargill. Cargill, Cameron, and others now prepared what is known as the "Sanquhar Declaration," because it was affixed to the market-cross at Sanquhar, June 22, 1680. Cargill was declared a traitor, and a price set on his head. In September he publicly "excommunicated" the king and others at Torwood. Hunted from place to place, he preached his last sermon on Dunsyre Common, July 10, 1681, and was arrested the same night at Covington Mill. He was tried and condemned, the casting vote being given by the duke of Argyll, who afterward bitterly repented this act. Cargill was executed at Edinburgh, July 27, 1681.—Hetherington, *History of the Church of Scotland*, vol. ii, ch. ii; *Biographia Presbyteriana*, ii (Edinburgh, 2d ed. 1835); *History of the Covenanters* (Presbyterian Board, Phila.), vol. ii, ch. iii; Hook, *Eccles. Biography*, ii, 486.

Car'ia (*Kapia*), the south-western district of Asia Minor (q. v.), washed on the S. by the Mediterranean and on the W. by the *Ægean* Sea, and indented by many bays and creeks. On the N. lay Lydia, eastward were Phrygia and Lycia, here separated by mountainous landmarks, yet without any fixed boundary, which continually fluctuated on the N., where the river *Mæander* formed not so much the political as the natural border (Strabo, xii, 577, 578; comp. xiii, 628). The S.W. angle of this region, having been settled by Dorian colonies, was sometimes distinguished from Caria by the name of *Doria* (Pliny, v, 29). Mountain ranges stretched through its entire territory, jutting out into promontories at the sea; yet considerable plains intervened, which were well watered, and fruitful in grain, oil, wine, etc. The inhabitants, composed of various mixed races (among which were some of Shemitic stock, Bertheau, *Isr. Gesch.* p. 193 sq.), were engaged, at least on the shore, in navigation and piracy (Herod. ii, 152; Thucyd. i, 4; Strabo, xiv, 662). A Jewish colony is referred to in the Apocrypha (1 Macc. xv, 22, 83) as being favorably addressed by the Romans in a decree which names the principal towns Halicarnassus (the birthplace of the historian Herodotus), Cnidus (mentioned in Acts xxvii, 7), to which may be added Miletus (comp. Acts xx, 15-28) and the same passage alludes to the fact that the Carians were then (B.C. 189) endowed with the privilege of Roman citizenship (Livy, xlix, 15), after having been for some time subject to Rhodes (comp. Ptolemy, v, 2; Mela, i, 16; Forbiger, *Alte Geogr.* ii, 204 sq.; Heeren, *Ideen*, I, i, 158 sq.). Somewhat later (B.C. 180) Caria became a province of the Roman empire (see Smith's *Dict. of Class. Geogr.* s. v.). Some antiquarians (see Verbrugge, *De num. plur. Hebr.* p. 68) have discovered the Carians in the O. T. under the name *Karim* (כָּרִים, 2 Kings xi, 4, 19), mentioned in connection with the *Raisim* (רַיִסִים, 2 Sam. xx, 28) as the life-guards of the Jewish kings; but these terms are rather to be taken as appellatives, executioners and couriers (Gesenius, *Theaur.* p. 671). See **CHEREHITE** and **PELETHITE**.

Carinthia and Carniola. The province of *Carinthia* (German, *Kärnten*), since 1836, has been an appanage of the dukes of Austria. In olden times it was included in Slavonia, and during the wars with Germany the first seeds of Christianity were sown. The princes of Carinthia had become Christians by the middle of the eighth century, yet the mass of the people did not embrace it before the latter part of the ninth century. In *Carniola* (German, *Krain*), which is also a duchy of Austria, Christianity was earlier propagated. Fortunatus, deacon of Hermagoras, first bishop of Aquileia, is said to have first introduced it in Laibach, and up to 1463 Laibach was an archdeaconry of Aquileia.

At the Reformation, Luther's doctrine spread rapidly through these two provinces, and Primus Truber (q. v.), who first promulgated them there, became canon

of Laibach in 1581; yet he had afterward to leave the country and retire to Wurtemberg, from whence he supplied his countrymen with evangelical books and tracts, partly in Slavonic and partly in Latin. In 1556 almost the whole population of both provinces had adopted the Reformation, and Truber went back in 1561, taking with him the first printer there had been in the country, John Mandel (Manlius). In 1597, a letter of prince-bishop Thomas Chrön to the pope shows that but one twentieth of the population, and that among the lower classes, adhered to Romanism. Yet want of unity among the ministers, and a growing tendency to indulge in scholastic and dogmatic discussions, opened the doors again to Rome, and in 1579 some of the ministers were driven away. The Roman Catholic element steadily increased until, in 1598, all the Protestant ministers were commanded by the emperor Ferdinand II to leave within fourteen days. In 1601 the same command was issued for the laity, who were to recant or emigrate within six weeks. Most preferred the latter alternative, and went into Bohemia, Hungary, and Germany. This state of things continued until the promulgation of the celebrated edict of toleration by Joseph II in 1781.

The denominational statistics of the two provinces were, according to the official census of 1857, as follows: *Carinthia*—Roman Catholics, 307,642; United Greeks, 3; Non-united Greeks, 1; Lutherans, 16,666; Reformed, 18. *Carniola*—Roman Catholics, 466,768; United Greeks, 278; Non-united Greeks, 294; Lutherans, 76; Reformed, 25; other sects, 1. There are three bishoprics: 1st, the see of Laibach, suffragan of the diocese of Görz, with 205 livings, 83 cures, 50 benefices, 676 secular priests, and 44 regular priests; 2d, the see of Gurk, belonging to the archbishopric of Salzburg, contains 204 livings, 72 cueneres, 11 bñces, and counts 421 secular priests, and 17 regular priests; 3d, the see of Lavant, suffragan of Salzburg, with 169 livings, 43 cures, 171 benefices, 405 secular priests, and 72 regular priests. In Carniola there are also 5 convents, occupied by 67 monks, and 2 by 55 nuns; in Carinthia there are 70 of the latter, and 8 convents.

The Lutherans are subject to the Superintendent at Vienna. They have in the district of Klagenfurth 2 circuits, with 2 ministers; and in that of Villach; 14 districts and 14 ministers. The latter districts are: 1, Oriach, 1415 persons; 2, Bleiberg, 1000; 3, Dornbach, 605; 4, Eisenstraten, 958; 5, Felfernitz, 621; 6, St. Peter, 1624; 7, Fresach, 1600; 8, St. Ruprecht, 1429; 9, Trebesing, 1250; 10, Fressdorf, 881; 11, Watschig, 1168; 12, Zlan, 1586; 13, Weisbrich, 1173; 14, Gnesau, 900; 15, Feldkirchen, 800.—*De conversione Carantanorum* (anonymous); Waldau, *d. Geschichte d. Protest. i. Oesterreich, Steyermark, Kärnten u. Krain* (Anspach, 1788, 2 vols.); Herzog, *Real-Encyclopädie*, vii, 208, from which this article is condensed.

Carleton, GEORGE, D.D., bishop of Chichester, was born at Norham, Northumberland, 1559. He was educated by Bernard Gilpin, by whom he was sent to Edmund Hall, Oxford, where he graduated A.B. in 1580, and A.M. in 1585. He remained in the college as fellow and master until 1616. In 1617 he was made bishop of Llandaff. In 1618 he was sent by James I, with Drs. Hall, Davenant, and Ward, to the Synod of Dort, where he defended episcopacy. On his return, the States sent a letter to king James highly commending him and the rest of the divines for their virtue, learning, piety, and love of peace. He was advanced to the see of Chichester in 1619, of which he continued bishop until his death in 1628. He was a man of solid judgment and various reading, particularly in the fathers and schoolmen; a strenuous opponent of Rome, and a steady Calvinist. He wrote *Twelve Examined* (Lond. 1611, 4to):—*Short Directions to know the true Church* (Lond. 1615, 12mo):—*Consensus Ecclesie Catholicae contra Tridentinos* (London, 1613, 8vo):—*Heroici Characteres* (Oxford, 1608, 4to):—*Vita*

B. Gelpini (in Bates, *Collection of Lives*, Lond. 1681), and several other works.—Middleton, *Evangelical Biography*, ii, 455; Hook, *Eccles. Biography*, iii, 440; *New and General Biog. Dictionary*, iii, 153.

Carlisle (*Carleolun*), a city in Cumberland, and an episcopal see of the Church of England. It belongs to the province of the archbishop of York. A monastery was commenced here about 1098, and afterward finished by king Henry I, who richly endowed it, and filled it with regular canons, and farther, at the request of archbishop Thurstan, erected it into a cathedral church. It was the only regular chapter in England composed of Augustinian canons, and who, with the consent of the pope and the king, enjoyed the right of electing their bishop. The priory was dissolved in January, 1540, and its site and manor given to maintain a dean, prebendaries, etc. The diocese is composed of parts of Cumberland and Westmoreland, and the chapter consists of a dean, archdeacon, chancellor, four canons, and three minor canons. The incumbent (1868) is Samuel Waldegrave, D.D., consecrated in 1860.—Landon, *Eccles. Dict.* s. v.

Carlstadt or **Carlostadt**, an eminent but violent coadjutor of Luther. His name was ANDREW BODENSTEIN, but he took his surname from his native place in Franconia. The date of his birth is unknown. He studied theology and the canon law at Rome. In 1504 he went to Wittemberg, and after taking several academic degrees and obtaining a great reputation for scholastic learning, he was in 1518 made professor of theology and archdeacon. His intimacy with Luther began in 1512. When Carlstadt came back from a stay at Rome, about 1515, and found that Luther's opinions were subverting scholasticism in the University, he at first opposed them violently, but afterward devoted himself to Biblical study, and became one of Luther's most zealous adherents. By some of his contemporaries his erudition is at this time highly spoken of, but Melancthon denied him either sound learning, genius, or piety. In escaping from scholasticism he seems to have gone to the opposite extreme of mysticism. In the celebrated Leipsic Disputation (June 27, 1519) he disputed with Eck (q. v.) upon "human freedom and divine grace." Luther, being drawn into the debate, surpassed the other disputants, and from this time the breach between Carlstadt and the great reformer openly manifested itself. The next year (1520) he published a treatise, *De canonicis Scripturis*, which, although defaced by bitter attacks on Luther, was nevertheless an able work, setting forth the great principle of Protestantism, viz. the paramount authority of Scripture. He also at this time contended for the authority of the epistle of St. James against Luther. On the publication of the bull of Leo X against the reformers, Carlstadt showed a real and honest courage in standing firm with Luther. His work on *Papal Somnolence* (1520) attacks the infallibility of the pope on the basis of the Bible. In 1521, during Luther's confinement in the Wartburg, Carlstadt had almost sole control of the reform movement at Wittemberg, and was supreme in the University. He attacked monachism and celibacy in a treatise *de celibatu, monachatu et viduitate*. His next point of assault was the *Mass*, and a riot of students and young citizens against the mass soon followed. On Christmas, 1521, he gave the sacrament in both kinds to the laity, and in German; and in January, 1522, he married. His headlong zeal led him to do whatever he came to believe right, at once and arbitrarily. But he soon outran Luther, and one of his great mistakes was in putting the O. T. on the same footing as the New. On Jan. 24, 1522, Carlstadt obtained the adoption of a new church constitution at Wittemberg, which is of interest only as the first Protestant organization of the Reformation. In 1523 he gave way to a fanaticism against academic learning, insisting that academical degrees were sin-

ful, and that the spirit was sufficient for the illumination of the faithful. The ferment increased until Wittemberg was in a storm, the University in danger of dissolution, and the timid Melancthon, although countenancing all the reasonable steps of Carlstadt, was nevertheless in great fear that his rashness would be disastrous to the reform. This is the culminating point of Carlstadt's influence. When Luther returned from the Wartburg, and found how things were going at Wittemberg, his eloquence and strength soon restored order, and Carlstadt's violence was rebuked and set aside. Carlstadt's vanity and ambition were mortified, and his influence at Wittemberg was broken. In 1523 he abandoned his academical honors and degree, left Wittemberg, and, calling himself a "*new layman*," went into the country. He soon published a number of mystical works, asserting the entire passivity of the human will in relation to predestined grace, and soon went almost to the verge of apostasy. He was especially fanatical in regard to the right to use "physical force," and treated with contempt Luther's consideration for the weakness of others. After his banishment from Wittemberg he obtained the pastorate of a church at Orlamünde, in Saxony, but after his discussion with Luther the elector banished him also from the state. Hence he went to Strasburg, and published several writings on the Eucharist, in which he opposed Luther's doctrine of the real (spiritual) presence, and coincided with Zwingle's views, which were also those of Ocolampadius, and are now held by most Protestants. On account of these tenets he was dismissed from Orlamünde in 1524, and from this date until 1534 he wandered through Germany, pursued by the persecuting opinions of both Lutherans and Papists, and at times reduced to great straits by indigence and unpopularity. But, although he always found sympathy and hospitality among the Anabaptists, yet he is evidently clear of the charge of complicity with Münstzer's rebellion. Yet he was forbidden to write, his life was sometimes in danger, and he exhibits the melancholy spectacle of a man great and right in many respects, but whose rashness, ambition, and insincere zeal, together with many fanatical opinions, had put him under the well-founded but immoderate censure of both friends and foes.

By these severe reverses the intemperate zealot was humbled. In 1530 Bucer sent him with warm commendations from Strasburg to Zurich, where, in 1532, he became a second time pastor of a church. In 1534 he was made professor of theology at Basel, and minister of St. Peter's, and, bating a dispute with Myconius, he lived in comparative quiet and comfort. He died of the plague on Christmas, 1541. It cannot be denied that in many respects he was apparently in advance of Luther, but his error lay in his haste to subvert and abolish the external forms and pomps before the hearts of the people, and doubtless his own, were prepared by an internal change. Biographies of him are numerous, and the Reformation no doubt owes him much of good for which he has not the credit, as it was overshadowed by the mischief he produced. See Füssli, *Andreas Bodenstein* (Frankfurt, 1776); Jäger, *And. Bodenstein von Carlstadt* (Stuttgart, 1856, 8vo); Mosheim, *Ch. Hist.* iii, 24, 32, 140; Merle D'Aubigné, *Hist. of Reformation*, iii, 179 sq.; Herzog, *Real-Encyclopædie*, ii, 395 sq.; Ranke, *History of the Reformation*, pt. ii, p. 163; Dorner, *Geschichte d. Prot. Theologie*, 1867, p. 121 sq.

Carmanian (Vulg. *Carmanianus*, for the Gr. text is not extant), an inhabitant of Carmania (occurring in the Bible only in 2 Esdr. xv, 80, where the Carmanians are predicted as the ravagers of Assyria), an extensive province of Asia along the northern side of the Persian Gulf, extending from Carpella (the present Cape Bomareek, or else C. Iask) on the E. to the river Bagradas (now Nabend) on the W., and comprehending the modern coast-line of Kirman, including Laris-

tan and Moghostan. See PERSIA. It was rugged, but fruitful, and inhabited by a warlike race (see Smith's *Dict. of Class. Geogr.* s. v.). They are described by Strabo (xv, p. 727) as worshipping Ares alone of all the gods, to whom they sacrificed an ass. None of them married till he had cut off the head of an enemy and presented it to the king, who placed it on his palace, having first cut out the tongue, which was chopped up into small pieces and mixed with meal, and in this condition, after being tasted by the king, was given to the warrior who brought it and to his family to eat. Nearchus says that most of the customs of the Carmanians, and their language, were Persian and Median. Arrian gives the same testimony (*Ind.* 38), adding that they used the same order of battle as the Persians. See ASIA.

Car'mè (Χαρμή v. r. Χαρμή), given (1 Esdr. v, 25) as the family head of 1017 Jews who returned from Babylon; evidently meaning the HARM (q. v.) of the Heb. texts (Ezra ii, 32; Neh. vii, 36).

Car'mel (Heb. *Karmel*, כַּרְמֶל, *park*, as in Isa. x, 18; xvi, 10; xxxix, 17; xxxiii, 15, 16; Jer. ii, 7; xlviii, 38 [also 2 Kings xix, 23; 2 Chron. xxvi, 10, in both which passages the A. V. incorrectly takes it for a proper name, "Carmel"]; hence *grits*, as a garden fruit, Lev. ii, 14; xxiii, 14; 2 Kings iv, 42), the name of a noted promontory (often with the art. [as in several of the above occurrences of the appellation], *hak-Karmel*, הַכַּרְמֶל, q. d. *the orchard*, Amos i, 2; ix, 8; Jer. iv, 26; Cant. vii, 6; fully "Mt. Carmel," *har hak-Karmel*, הַר הַכַּרְמֶל, q. d. *garden-mountain*, 1 Kings xviii, 19, 20; or without the art. Isa. xxxiii, 9; Nah. i, 4; Josh. xix, 26), and also of a town; both doubtless so called from their verdant fertility. The following account is compiled mostly from Kitto and Smith, s. v.

1. (Sept. usually *Kármηλος* [so Josephus, *Ant.* v, 1, 22, etc.; Tacitus, "Carmelus," *Hist.* ii, 78; also Suetonius, *Vespas.* 5, 1]; but *Καρμήλιον* in 1 Kings xviii, 19, 20; 2 Kings ii, 25; iv, 25 [so Josephus, *Ant.* xiii, 5, 4], and *Χερμέλ* in Josh. xii, 22). A prominent headland of lower or central Palestine, bounding southerly the Bay of Acre, and running out boldly almost into the waves of the Mediterranean, from which it stretches in a straight line, bearing about S.S.E. for a little more than twelve miles, when it terminates suddenly by a bluff somewhat corresponding to its western end, breaking down abruptly into the hills of Jenin and Samaria, which form at that part the central mass of the country. The average height is about 1500 feet; and at the foot of the mountain, on the north, runs the brook Kishon, and a little further north the river Belus. Mount Carmel consists rather of several connected hills than of one ridge, being at the W. end about 600, and at the E. about 1600 feet above the sea. The highest part is some four miles from the E. end, at the village of Esfeh, which, according to the measurements of the English engineers, is 1728 feet above the sea. The foot of the northern portion approaches the water closely, but farther south it retires more inland. The slopes are steepest on the northern side toward the Kishon (q. v.).

Carmel fell within the lot of the tribe of Asher (Josh. xix, 26), which was extended as far south as Dor (Tantura), probably to give the Asherites a share of the rich corn-growing plain of Sharon (comp. Josephus, *Ant.* v, 1, 22; *War.* iii, 8, 1). The king of "Jokneam of Carmel" was one of the Canaanitish chiefs who fell before the arms of Joshua (xii, 22). There is not in these earliest notices a hint of any sanctity attaching to the mount; but from the facts that an altar to Jehovah did exist there before the introduction of Baal worship into the kingdom (1 Kings xviii, 30); that Elijah chose the place for the assembly of the people, such assemblies being commonly held at holy

places; and from the custom, which appears to have been prevalent, of resorting thither on new-moon and sabbaths (2 Kings iv, 23), there seem to be grounds for believing that from very early times it was considered a sacred spot. In later times, Pythagoras was led to it by that reputation, according to his biographer Iamblichus (*Vit. Pythag.* c. 3, p. 40, 42, ed. Kiesel.), who himself visited the mountain; Vespasian, too, came thither to consult—so we are told by Tacitus (*Hist.* ii, 7), with that mixture of fact and fable which marks all the heathen notices of Palestine—the oracle of the god, whose name was the same as that of the mountain itself; an oracle without image or temple (see Smith's *Dict. of Classical Geogr.* s. v. Carmelus). But the circumstances that have made the name of Carmel most familiar are that here Elijah brought back Israel to allegiance to Jehovah, and slew the prophets of the foreign and false god; here at his entreaty were consumed the successive "fifties" out of the royal guard; and here, on the other hand, Elisha received the visit of the bereaved mother whose son he was soon to restore to her arms (2 Kings iv, 25, etc.) See ELISHA. The first of these three events, without doubt, took place at the eastern end of the ridge, at a spot called *el-Mukhrakah*, near the ruined village of el-Mansurah, first described by Van de Velde (*Journey*, i, 824 sq.). The tradition preserved in the convent, and among the Druses of the neighboring villages, the names of the places, the distance from Jezreel, the nature of the locality, the presence of the never-failing spring, all are favorable (see Stanley, *Sinai and Palest.* p. 345 sq.; Thomson, *Land and Book*, i, 223 sq.). The terrace on which the traditional structure stands commands a noble view over the whole plain of Esdraelon, from the banks of the Kishon down at the bottom of the steep declivity, away to the distant hill of Gilboa, at whose base stood the royal city of Jezreel. To the 850 prophets, ranged doubtless on the wide upland sweep, just beneath the terrace, to the multitudes of people, many of whom may have remained on the plain, the altar of Elijah would be in full view, and they could all see, in the evening twilight, that "the fire of the Lord fell, and consumed the burnt-sacrifice, and the wood, and the stones, and the dust, and licked up the water" (ver. 38). The people then, trembling with fear and indignation, seized, at Elijah's bidding, the prophets of Baal; "and Elijah brought them down to the brook Kishon, and slew them there." On the lower declivities of the mountain is a mound called Tell el-Kusis, "the Hill of the Priests," which probably marks the very scene of the execution. May not the present name of the Kishon itself have originated in this tragic event? It is called *Nahr el-Mokatta*, "the River of Slaughter." The prophet went up again to the altar, which was *near*, but *not upon* the summit of the mountain. While he prayed, he said to his servant, "Go up now, and look toward the sea." The sea is not visible from the terrace, but a few minutes' ascent leads to a peak which commands its whole expanse. Seven times did the servant climb the height, and at last saw the little cloud "like a man's hand" rising out of the sea. See ELIJAH.

According to the reports of most travellers, the mountain well deserves its Hebrew name (see above). Mariti describes it as "a delightful region," and says the good quality of its soil is apparent from the fact that many odoriferous plants and flowers, as hyacinths, jonquils, tazettes, anemones, etc., grow wild upon the mountain (*Travels*, p. 274 sq.). Otto von Richter (*Wallfahrten*, p. 64) gives a glowing account of its beauty and varied scenery. Mr. Carne also says, "No mountain in or around Palestine retains its ancient beauty so much as Carmel. Two or three villages and some scattered cottages are found on it; its groves are few, but luxuriant; it is no place for crags and precipices, or rocks of the wild goats; but its sur-

face is covered with a rich and constant verdure" (*Lett. &c.*, ii, 119). "There is not a flower," says Van de Velde, "that I have seen in Galilee, or on the plains along the coast, that I do not find here on Carmel . . . still the fragrant, lovely mountain that he was of old" (*Narrative*, i, 317, 8). "The whole mountain side was dressed with blossoms, and flowering shrubs, and fragrant herbs" (Martineau, p. 539). So Isaiah (xxxv, 2) alludes to "the excellency (splendid ornaments) of Carmel." So, on account of the graceful form and verdant beauty of the summit, the head of the bride in Cant. vii, 5 is compared to Carmel. It was also celebrated for its pastures, and is therefore ranked with Bashan in Isa. xxxiii, 9; Jer. l, 19; Amos i, 2; Mic. vii, 14; Nah. i, 4. Its conspicuous position is also compared with that of Tabor (Jer. xlvi, 18). Its great elevation is referred to in Amos ix, 8. A much less glowing account of Carmel is given, however, by many travellers whose visit has been later in the year—toward the end of summer or in autumn—and who consequently found everything parched, dry, and brown. (See Hackett's *Illustra. of Scripture*, p. 324-326.) The western extremity of the ridge—that, unfortunately, with which ordinary travellers are most familiar, and from which they take their impressions—is more bleak than the eastern. Its sides are steep and rocky, scantily covered with dwarf shrubs and aromatic herbs, and having only a few scattered trees here and there in the glens (*Crescent and Cross*, i, 64 sq.).

The structure of Carmel is in the main the Jura formation (upper oolite), which is prevalent in the centre of Western Palestine—a soft white limestone, with nodules and veins of flint. As usual in limestone formations, it abounds in caves ("more than 2000"—Mislin, ii, 46), often of great length, and extremely tortuous. See CAVE. At the west end are found chalk and tertiary breccia formed of fragments of chalk and flint (Russegger, in Ritter, *Erzk.* xvi, 712). On the north-east of the mount, beyond the Nahr el-Mokatta, plutonic rocks appear, breaking through the deposited strata, and forming the beginning of the basalt formation which runs through the plain of Esdrælon to Tabor and the Sea of Galilee (Ritter, *ib.*). The round stones known by the names of "Lapides Judaici" and "Elijah's melons" are the bodies known to geologists as "geodes." Their exterior is chert or flint of a lightish brown color; the interior is hollow, and lined with crystals of quartz or chalcedony. They are of the form, and often the size, of the large water-melons of the East. Formerly they were easily obtained, but are now very rarely found (Seetzen, ii, 181, 184; Parkinson's *Organic Remains*, i, 322, 451). The "olives" are more common. They are the fossil spines of a kind of echinus (*Cidaris glandifera*) frequent in these strata, and in size and shape are exactly like the fruit (Parkinson, iii, 46). The "apples" are probably the shells of the *cidaris* itself. For the legend of the origin of these "fruits," and the position of the "field" or "garden" of Elijah in which they are found, see Mislin, ii, 64, 65. The whole ridge of Carmel is deeply furrowed with rocky ravines, filled with such dense jungle as scarcely to be penetrable. Here jackals, wolves, hyenas, and wild swine make their lairs, and woodcocks find excellent cover; while in the open forest glades, partridges, quails, and hares sport about. In the sides of the mountain, especially round the convent and overhanging the sea, are great numbers of caves and grottoes, formed partly by nature and partly by art and industry in the soft calcareous rock. Carmel at one period swarmed with monks and hermits, who burrowed in these comfortless dens. Curious traditions cling to some of them, in part confirmed by the Greek inscriptions and names that may still be traced upon their walls. One of them is called the "Cave of the Sons of the Prophets," and is said to be that in which the pious Obadiah hid the prophets from the fury of the infamous Jezebel (1 Kings xviii,

4). In one tract, called the Monks' Cavern, there are as many as 400 caves adjacent to each other, furnished with windows, and with places for sleeping hewn in the rock. A peculiarity of many of these caverns is mentioned by Shulz (*Leitung*, v, 187, 382), that the entrances into them are so narrow that only a single person can creep in at a time; and that the caverns are so crooked that a person is immediately out of sight unless closely followed. This may serve to illustrate Amos ix, 8. To these grottoes the prophets Elijah and Elisha often resorted (1 Kings xviii, 19 sq., 42; 2 Kings ii, 25; iv, 25; and comp. perhaps 1 Kings xviii, 4, 18). At the present day is shown a cavern called the cave of Elijah, a little below the Monks' Cavern already mentioned, and which is now a Moslem sanctuary. Upon the north-west summit is an ancient establishment of Carmelite monks, which order, indeed, derived its name from this mountain. See CARMELITES. The order is said in the traditions of the Latin Church to have originated with Elijah himself (St. John of Jerus., quoted in Mislin, ii, 49), but the convent was founded by St. Louis, and its French origin is still shown by the practice of unfurling the French flag on various occasions. Edward I of England was a brother of the order, and one of its most famous generals was Simon Stokes of Kent (see the extracts in Wilson's *Bible Lands*, ii, 246; for the convent and the singular legends connecting Mount Carmel with the Virgin Mary and our Lord, see Mislin, ii, 47-50). By Napoleon it was used as a hospital during the siege of Acre, and after his retreat was destroyed by the Arabs. At the time of Irby and Mangley's visit (1817) only one friar remained there (Irby, p. 60). The old convent was destroyed by Abdallah Pasha, who converted the materials to his own use; but it has of late years been rebuilt on a somewhat imposing scale by the aid of contributions from Europe. Carmel is known by the name of *Jebel Kurmul* in Arabian writers. At present it seems to be called by the Arabs *Jebel Mar Elyas*, from the convent of Elias near its northern end. (See generally Phil. a S. Trinitate, *Oriental. Reisebeschreib.* iii, 1, p. 156 sq.; Reland, *Palæst.* p. 82 sq.; Hamesveld, i, 349; Schuber, *Reise*, iii, 205; Robinson, *Researches*, iii, 160, 189; Thomson, *Land and Book*, i, 498; Porter, *Handbook for Syria*, p. 371; Tristram, *Land of Israel*, p. 496.)

2. (Sept. $\chi\epsilon\rho\mu\lambda$ in Josh., δ $\chi\acute{\alpha}\rho\mu\lambda\omicron\varsigma$ in Sam. and Chron.) A town in the mountainous country of Judah (Josh. xv, 55), the residence of Nabal (1 Sam. xxv, 2, 5, 7, 40), and the native place of David's favorite wife, "Abigail the Carmelitess" (1 Sam. xxvii, 3; 1 Chron. iii, 1). This was doubtless the Carmel at which Saul set up a "place" (τ), a *hand*; compare 2 Sam. xviii, 18, "Absalom's place," where the same word is used) after his victory over Amalek (1 Sam. xv, 12). This Carmel, and not the northern mount, must also have been the spot at which king Uzziab had his vineyards (2 Chron. xxvi, 10). In the time of Eusebius and Jerome it was the seat of a Roman garrison (*Onomast.* s. v. $\chi\acute{\alpha}\rho\mu\lambda\omicron\varsigma$, Carmelus). The place appears in the wars of the Crusades, having been held by king Amalrich against Saladin in 1172 (William of Tyre, *De Bello Sacro*, 80; in *Gesta Dei per Francos*, p. 998). The ruins of the town, now *Kurmul*, still remain at ten miles below Hebron, in a slightly south-east direction, close to those of Maïn (Maon), Zif (Ziph), and other places named with Carmel in Josh. xv, 55. They are described both by Robinson (*Bib. Res.* ii, 195-201; *Bib. Sacr.* 1848, p. 60) and by Van de Velde (*Narrative*, ii, 77-79), and appear to be of great extent. They lie around the semicircular head and along the shelving sides of a little valley, which is shut in by rugged limestone rocks. The houses are all in ruins, and their sites are covered with heaps of rubbish and hewn stones. In the centre of the valley is a large artificial reservoir, supplied by a

fountain among the neighboring rocks. This is mentioned in the account of king Amalrich's occupation of the place, and now gives the name of *Karr el-Birkeh* to a ruined castle of great strength, situated westward of the reservoir, on high ground, the most remarkable object in the place. Its walls are ten feet thick; their sloping basement and bevelled masonry are evidently of Jewish origin, probably the work of Herod. The interior was remodelled, and the upper part rebuilt by the Saracens. Beside it are the ruins of a massive round tower. Around and among the ruins of the locality are the foundations of several old churches, showing that the town had at one period a large Christian population. (See Seetzen, *Reise*, iii, 8, 9; Porter, *Handbook for Syria*, p. 61; Schwarz, *Palest.* p. 106.) See CARMELITE.

Carmelite (Heb. *Karmelî*, כַּרְמֵלִי), the designation of Nabal (Sept. *Καρμῆλιος*, 1 Sam. xxvii, 3; xxx, 5; 2 Sam. i, 2) and his wife Abigail (Sept. *Καρμῆλια*, A. V. "Carmelites," 2 Sam. iii, 3; 1 Chron. iii, 1); as also of one of David's warriors, Hezrai (Sept. *Καρμῆλιος*, 2 Sam. xxiii, 35) or Hezro (Sept. *Καρμωδι*, 1 Chron. xi, 37); doubtless as being inhabitants of CARMEL (q. v.) in Judah (Josh. xv, 55).

Carmelites, the monastic order of "St. Mary of Mount Carmel." It was founded as an association of hermits by Berthold, count of Limoges, about 1156, on Mount Carmel, and received its first rule in 1209 from Albert, patriarch of Jerusalem, to whose diocese Mount Carmel belonged, which rule was sanctioned by Pope Honorius III in 1224. The rule was founded on that of St. Basil, and enjoined that the prior be elected unanimously or by majority; to have places in deserts, separate cells, common refectory; all to remain in their cells meditating by day and night, excepting when at fit hours, in church, etc.; to have all things common; no flesh allowed save to the sick; fast from Holyrood to Easter every day except to the sick; to observe chastity, to labor, and to keep silence from after Compline till Prime. The habit was at first white, as well as the mantle, of which the bottom was laced thick with yellow bands, an ornament suppressed by Honorius IV. They then assumed the robe of the Minims, and a white mantle. The Carmelites were also known by the name of *Barred* or *Barry Friars* (*Frères Barrez*), because of the *barred* dress of black and white which the Saracens, when they took possession of the East, compelled them to wear, instead of the white dress, white being with them a mark of distinction. They came to Europe in 1238, and had seven establishments in England. The first General Chapter was held in 1245 in England, after which, through the activity of their general, Simon Stock, and the protection of Innocent IV, they spread with great rapidity. From Innocent IV they received, in 1247, a new rule, which was better suited for their new situation, and which classed them among the mendicant orders. Intigated by the desire to excel their rivals, they invented the most absurd legends. They pretended that the prophet Elijah had been the founder of their order and the Virgin Mary a member, wherefore they called themselves *Frates Beata Maria de Monte Carmelo*. The succession of the generals of the order, according to their historians, has never been interrupted since the prophet Elijah. They were duly castigated and ridiculed for such pretensions by the Jesuits, and particularly by the learned Bollandist Papebroch. Still the Church never decided against them; Pope Innocent IV imposed silence on both parties, and the fables of the Carmelites can be read in their liturgical books to this day.

The great schism of the 14th century split also the order of the Carmelites, and completed their corruption and disorganization. Several attempts at a reformation were made, of which that of Thomas Con-

Mantua, was the most successful. Thomas himself (a celebrated penitentiary in France and in the Netherlands) was burned in Rome as a heretic, but his congregation soon extended widely, and received the privilege of electing a vicar general. Pope Eugenius IV mitigated the rule of Innocent IV in 1431, and endeavored to unite all the Carmelites, except the Congregation of Mantua, on this mitigated rule as a new basis. For the same purpose, the general received from Pius II, in 1459, the authority to proceed with regard to fast-days according to their own judgment. In 1462, general John Soreth tried to introduce a greater strictness of the rule into the whole order. His plans were approved by Pope Paul II, but the author was poisoned by discontented monks in 1471. The same Soreth established, in 1452, the first convent of Carmelite nuns. In 1476 Sixtus IV established the Tertiarians of the order. They received a rule in 1635, which was reformed in 1678.

The *Discalceate* Carmelites received their name from going barefooted, and took their rise in the 16th century. They professed the order as reformed by Theresa of Avila, in Spain, who, desiring a stricter rule than that which the Carmelites (farther mitigated by Eugenius IV in 1431) afforded, about 1562 established a new house at Avila under her reformed rule; and in 1577 the *Discalceats* were exempted from the jurisdiction of the Mitigated Carmelites. They were divided into two distinct bodies, those of Spain, who were composed of six provinces under one general, being the strictest. The others had seventeen provinces in France, Italy, Poland, Germany, Persia, etc. It is a rule with them that in every province there shall be a hermitage attached to some one monastery, in which hermitage shall be not more than twenty monks, who after three weeks return to the monastery, and are replaced by twenty other monks. Their manner of life is very austere (*Landon, Eccl. Dictionary*, s. v.).



Barefooted Carmelita.

The Spanish congregation has become nearly extinct in consequence of the suppression of all the monastic orders in Spain. In 1843 no more than fourteen convents belonging to it were left in South America. Their procurator general lived in the general house of the Italian congregation in Rome. At the same date the Italian congregation counted 63 convents, with about 900 members, in Italy, France, Belgium, Holland, Austria, Bavaria, Ireland, Poland, and Turkey. The Mitigated or Calceate Carmelites had convents in Italy, Austria, Bavaria, Ireland, and Poland, with about 600 members. In 1860 the Carmelite monks altogether numbered 125 houses in Italy; 12 in Germany, Holland, and Belgium; 12 in France, 8 in Ireland, 22 in Eastern Europe (Poland, Galicia, Russia, Hungary), 6 in Asia, 17 in Mexico and South America, and a few

in Spain. The number of members was estimated at about 4000. Since then the number has been reduced by the suppression of a number of convents in Italy. The Carmelite nuns of the reform of Theresa had, in 1843, about 90 houses in Italy; France, Belgium, England, Ireland, Bavaria, Prussia, Austria, Poland, North America (at Baltimore), South America, and India: 60 of these convents were in France. In 1860, Spain and Portugal had 15 houses; Italy, 19; France, 71; Germany, Holland, and Belgium, 28; Great Britain and Ireland, 15; Poland, 8; America, 7; Asia, 1; altogether, 160 houses, with about 3200 members.

A congregation of our Lady of Mount Carmel was founded in France in 1702. Its members are not obliged to enter a convent, but can pass their novitiate in the world. They have many institutions in France, principally devoted to teaching and the nursing of the sick, and have once a year a great gathering at Avanches for the purpose of a common spiritual retreat. There is also a congregation of Carmelites in the archdiocese of New Orleans, U. S., who teach four schools.—Manning, *Life of St. Teresa* (Lond. 1865), p. 161 sq.; Fehr, *Geschichte der Mönchsorden*, i, 856; ii, 841; P. Karl vom heil. Aloys, *Jahrbuch der Kirche* (Ratisbon, 1862).

Carmelitess (1 Sam. xxvii, 8; 1 Chron. iii, 1). See CARMELITE.

Carmi (Heb. *Karmi'*, קרמי, *wine-dresser*, otherwise *noble*; Sept. *Kappi*, but *Kappui* in Exod. vi, 14), the name of three men.

1. The last named of the four sons of Reuben (Gen. xlvii, 9; Exod. vi, 14). B. C. 1872. His descendants were called after him CARMITES (Num. xxvi, 6).

2. A son of Herron (Judah's grandson), and father of Hur (1 Chron. iv, 2); elsewhere called CALEB (ii, 18) or CHELUBAI (ii, 9). B. C. post 1856.

3. The son of Zimri or Zabdi, and father of the traitor Achan (Josh. vii, 1; 1 Chron. ii, 7). B. C. ante 1618. Some have erroneously identified him with the preceding; but the names in 1 Chron. iv, 2, are evidently in direct succession of father and son from Judah.

Carmite (Heb. *Carmi'*, קרמי for קרמי, Sept. *Kappi*), the patronymic of the descendants of the Benbenite Carmi (Num. xxvi, 6).

Carnahan, JAMES, D.D., president of Princeton College, was born Nov. 15, 1776, in Cumberland county, Pa. In November, 1798, he entered the junior class in the college of New Jersey, and received the first degree in the arts in September, 1800. He read theology under John M'Millan, D.D., in Western Pennsylvania. In 1801 he returned to Princeton as tutor, and resigned his tutorship in the fall of 1803. He was licensed by the presbytery of New Brunswick at Baskenridge in April, 1804, and preached in the vicinity of Hackettstown, Oxford, and Knowlton. January 5, 1805, he was ordained pastor of the united churches of Whitesborough and Utica, N. Y. In February, 1814, he moved for his health to Georgetown, D. C., and opened a school, teaching there for nine years. In May, 1823, he was chosen president of the college of New Jersey, was inaugurated on the 5th of August, 1823, and, after a service of thirty years, resigned in 1853, and his connection with the college was dissolved June, 1854. He was in different capacities connected with the college for thirty-five years, viz. two years as a student, two as a tutor, and thirty-one as president. "His character was distinguished by mildness, joined to firmness and vigor; his learning was extensive, and his practical ability in the ordinary affairs of life exceedingly acute. His labors were very useful in every department of activity—as a man, a Christian clergyman, the head of a most important educational institution, and an efficient co-operator in numerous schemes of benevolent enterprise." He

died in Newark, N. J., March 2, 1859.—*New York Observer*; Wilson, *Presb. Almanac*, 1860, p. 68.

Car'naïm (Καρναϊν v. r. Καρνεϊν, Vulg. *Carnaïm*), a large and fortified city in the country east of Jordan—"the land of Galaad"—containing a "temple" (τὸ ἱεῖμα ἐν Κ.). It was besieged and taken by Judas Maccabæus (1 Macc. v, 26, 43, 44). Under the name of CARNION (τὸ Καρνιον) the same occurrence is related in 2 Macc. xii, 21, 26, the temple being called the ATARGATEION (τὸ Ἀταργατίον). This enables us to identify it with ASHTEROTH-KARNALIM (q. v.).

Carnal (σαρκικός), fleshly, sensual. Wicked or unconverted men are represented as under the domination of a "carnal mind, which is enmity against God," and which must issue in death (Rom. viii, 6, 7). Worldly enjoyments are carnal, because they only minister to the wants and desires of the animal part of man (Rom. xv, 27; 1 Cor. ix, 11). The ceremonial parts of the Mosaic dispensation were carnal; they related immediately to the bodies of men and beasts (Heb. vii, 16; ix, 10). The weapons of a Christian's warfare are not carnal; they are not of human origin, nor are they directed by human wisdom (2 Cor. x, 4).—Calmet. See FLESH.

Carnelian. See SARDIUS.

Carneseccchi, PIETRO, an Italian reformer and martyr of the 16th century, was born in Florence, of a good family. His education and culture gained him the esteem of the best scholars of the time, such as Sadoletus and Bembo. He became secretary and prothonotary to Pope Clement VII, and had so much influence that it was said "the Church was governed by Carneseccchi rather than by Clement." At Naples he imbibed the Reformed doctrine from Valdes (q. v.), and in 1546 he was accused as a heretic and cited to Rome. Through the favor of Paul IV he escaped, but sought safety in France, where he remained at the court of Henry VI until 1552, when he thought he might return to Italy, and took up his abode at Padua. In 1557 he was summoned to Rome; but, failing to appear, he was excommunicated as a heretic, April 6, 1559. Pius IV, on his accession, removed the sentence of excommunication, without any recantation on the part of Carneseccchi. When Pius V became pope, Carneseccchi apprehended danger, and took refuge with Cosmo, grand-duke of Tuscany, who basely surrendered him on a demand in the pope's own writing. He was tried by the Inquisition, adhered steadfastly to the faith, and was condemned. On Oct. 8, 1567, he was beheaded, and his body afterward was consumed.—M'Crie, *Reformation in Italy*, chap. v (and authorities there given).

Carniola. See CARINTHIA.

Car'nion (2 Macc. xii, 21, 26). See CARNALIM.

Carnival, a period of festivity in Roman Catholic countries, beginning on the day after the Epiphany, and ending at the commencement of Lent, on Ash Wednesday, resembling the Lupercalia of the Romans and the Yule-feasts of the Saxons. Some derive the word from *caro* (*carnis*), flesh, and *vale*, to bid adieu, i. q. *farewell to flesh*; others from the Italian *carne*, flesh, and *avallare*, to swallow. In mediæval Latin it is called *carnelevamen*, *carnieprivium*. The Carnival owes its origin to the pagan festivals, and pious Roman Catholics themselves have testified their sense of the scandal which this season occasions. In Rome the Carnival is observed with revelry, masquerades, feasts, and grotesque processions. The Greeks have a similar period, which they call Ἀπόκριες, *Apocrees*; it comprehends the week preceding their Lent, during which, as Marinus says, "unusquisque pro facultate sua, laute et opiparè convivatur." A good account of the Roman Carnival is given in Appleton's *Cyclopædia*, iii, 447. See also Nicolai, *Comment. de Ritu Bacchana-*

liorum (Helmst. 1679, 4to); Zeuner, *Bacchanalia Christianorum* (Jena, 1699, 4to); Landon, *Eccles. Dict.* s. v.

Carob. See **HUSK.**

Carol, a hymn sung by the people at Christmas. "The Christmas carol may be traced to the primitive Church. Tertullian (*advers. Gentil.* 39) states that at their feasts it was customary for the Christians to place in the middle such as were able to sing, and call upon them to praise God in a hymn, either out of the Scriptures or of their own invention. Durand also informs us (*Rel.* vi, 86, 9) that it was usual for the bishops on Christmas day to make sport, and even to sing with their clergy; and this custom was an imitation of the *Gloria in excelsis* of the angels, as we learn from Jeremy Taylor—"These blessed choristers had sung their Christmas carol, and taught the Church a hymn to put into her offices forever, on the anniversary of this festivity." For the popular carols of England, see Brand, *Popular Antiquities*, i, 262 sq.; Chambers, *Book of Days*, ii, 747 sq.—Eadie, *Eccles. Dictionary*, s. v.; Sandys, *Christmas Carols, Ancient and Modern* (Lond. 1838, 8vo). See **MYSTERIES.**

Caroline Books (*Libri Carolini* or *Opus Carolinum*), four books written against decrees of the second Council of Nice on the adoration of images, contained in the *Capitulare Prolizum* of Charlemagne. These books were drawn up under the direction of Charlemagne, but their preparation has been ascribed to Angilram, bishop of Metz, Angilbert, and to Alcuin. Roger de Hoveden directly names the last, and the most probable opinion is that Alcuin was the writer. At all events, they were written before the Synod of Frankfort in 794, and were published in the name of Charlemagne during the sitting of that council. In the preface the emperor declares that he had undertaken the work "*Zelo Dei et veritatis studio, cum conhibentia regni sui sacerdotum.*" The great principles of these books are the following:

Lib. ii, c. 21: Solus igitur Deus colendus, solus adorandus, solus glorificandus est, de quo per Prophetam dicitur: "Exaltatum est nomen ejus solius" (Psa. cxlviii, 13): Cujus etiam Sanctis, qui triumphato diabolo eum eo regnant, sive quia viriliter certaverunt, ut ad nos incoluntis status ecclesie perveniret, sive quia eandem ecclesiam assiduis suffragiis et intercessionibus adjuvare noscuntur, veneratio exhibenda est: imagines vero, omni sui cultura et adoratione seclusa, utrum in basilicis propter memoriam rerum gestarum et ornamentum sint, an etiam non sint, nullum fidei catholice adferre poterunt prejudicium: quippe cum ad peragenda nostre salutis mysteria nullum penitus officium habere noscantur. Lib. iii, c. 16: Nam dum nos nihil in imaginibus spernamus preter adorationem, quippe qui in basilicis Sanctorum imagines non ad adorandum, sed ad memoriam rerum gestarum et venustatem parietum habere permittimus: Illi vero pene omnem nos credulitatis spem in imaginibus collocat; restat, ut nos Sanctos in eorum corporibus vel potius reliquiis corporum, seu etiam vestimentis veneremus, juxta antiquorum patrum traditionem: Illi vero parietes et tabulas adorantes in eo se arbitrentur magnum fidei habere emolumentum, eo quod operibus sint subiecti pictorum. Nam etsi a doctis quibusque vitari possit hoc, quod illi in adorandis imaginibus exercent, qui videlicet non quid sint, sed quid inuuant venerantur, indoctis tamen quibusque scandalum generant, qui nihil aliud in his preter id quod vident venerantur et adorant.

The Caroline books were first printed by Jean du Tillet, bishop of Meaux, under the assumed name of Eriphilus, or Elias Philyra (Paris, 1549, 8vo), at Cologne in 1555; by Goldastus, 1608; and in his *Constitution. Imperial.* tom. i; and, lastly, by Heumannus at Hanover (1731, 8vo), under the title *Augusti Concilii Niceni Secundi Censura.*—Palmer, *Treat. on the Church*, pt. iv, ch. x, § 4; Bergier, *Dict. de Théologie*, s. v. *Im-*

age; Gieseler, *Church History*, per. iii, § 12; Herzog, *Real-Encyclopädie*, vii, 429; Landon, *Eccles. Dict.* s. v. See **IMAGE-WORSHIP.**

Carlostadt. See **CARLSTADT.**

Carpenter, the rendering in the Auth. Vers. of the Heb. *כַּרְמֵל*, *charash* (2 Sam. v, 11; 1 Chron. xiv, 1; Isa. xlv, 18, etc.), as also of its Greek equivalent *πίκτων* (Matt. xiii, 55; Mark vi, 8; 1 Eedr. v, 14; Eccus. xxxviii, 27, etc.), a general name, applicable to an artificer in stone, iron, or copper, as well as in wood. See **ARTIFICER.** The Hebrews, at a very early period, appear to have made considerable progress in these arts (Exod. xxxv, 80-85). See **ART.** Of their works, however, we have no existing remains; but by a reference to the antiquities of Egypt, the country where their proficiency was acquired, we may obtain a satisfactory notion of their general character. See **HANDICRAFT.** Tools of various kinds used in carpentry, as axes, hammers, saws, planes, chisels, and centre-bits, are represented on the ancient monuments, and to most of them we find allusions in Scripture (1 Sam. xiii, 19, 20; Judg. iv, 21; Isa. x, 15; xlv, 18). There appears but little difference between these implements and those of our time. See **TURSER.** The ancient Egyptians were acquainted with the art of veneering; this proves that they knew the use of glue. They had chairs and couches of very graceful form (comp. Gen. xliii, 89; 1 Sam. iv, 18). Among the works of the Egyptian artists are found tables, bureaux, wardrobes, and coffers; several of the latter, probably designed for jewel-cases, rival in beauty the caskets of gold and silver. See **MECHANIC.**

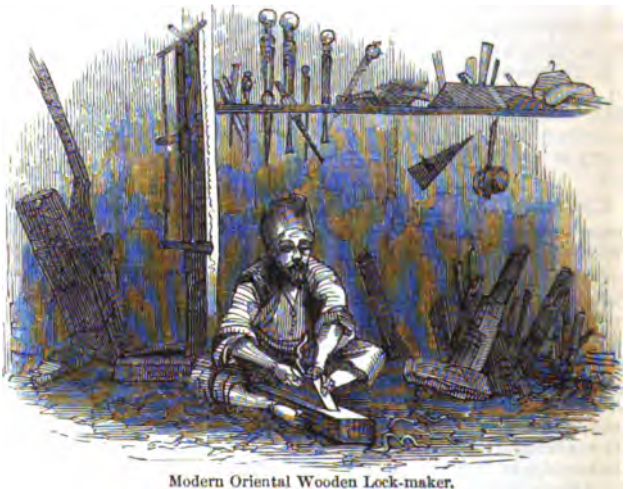

Modern Oriental Wooden Lock-maker.

Carpenter, Charles W., a Methodist Episcopal minister, was born in New York, Dec. 16, 1792, where his parents were members of the John Street Church. He entered Columbia College, but was compelled by ill health to quit before graduation. He was converted in his eighteenth year, and was licensed by Freeborn Garretson to preach in 1812. He entered the itinerant ministry in the New York Conference in 1814, but in 1816 he was obliged, by the weakness of his health, to go to Savannah, where he was engaged in business for ten years. During this time he labored as a local preacher, and was ordained deacon in 1820, and elder in 1826. In 1828 he returned to the North, and was readmitted into the New York Conference, in which he filled important appointments, as pastor and presiding elder, until 1850, when he was compelled by ill health to become supernumerary. He died May, 1853, at Plattekill, N. Y. He was of very uniform character, good literary acquirements,

and great loveliness of disposition. As a minister he was able and sound, and his influence was great and durable. He was several times delegate to the General Conference, and as presiding elder his administrative talent was remarkable. He was secretary of the New York Conference for several years, and in all posts he was efficient and successful. His death was joyful.—*Minutes of Conferences*, v. 194; *Sprague, Annals*, vii, 558; *Wightman, Life of Bishop Capers*, p. 211.

Carpenter, Coles, a minister of the Methodist Episcopal Church, was born in Westchester county, N. Y., March 17, 1784. His parents were earnest Methodists, and he was carefully trained in religion. At seventeen he was converted, and began at once to exhort his young neighbors. In 1809 he was admitted on trial in the New York Conference; ordained deacon in 1811, and elder in 1813. He filled various important appointments in the New York Conference until 1832, when the Troy Conference was organized, and he remained in it. In 1833 he was appointed presiding elder of the Troy District, in which service he labored acceptably until his death, Feb. 17, 1884. In direct appeals to the heart and conscience he had few superiors.—*Sprague, Annals*, vii, 466; *Minutes of Conferences*, 1834.

Carpenter, Lant, LL.D., an English Unitarian minister, was born Sept. 2, 1780, at Kidderminster, and educated at Northampton and Glasgow. In 1805 he became pastor of a Unitarian congregation at Exeter, and in 1817 removed to Bristol, where he remained as pastor and classical teacher till 1839, when, his health failing, he undertook a Continental tour. While going in a steam-boat from Naples to Leghorn, he fell overboard and was drowned, in the night of April 5, 1840. Dr. Carpenter was an industrious writer. His publications, including posthumous ones, amounted to forty-four. The more important are: *Introduction to the Geography of the New Testament* (12mo, 1806);—*Unitarianism the Doctrine of the Gospel* (12mo, 1809);—*An Examination of the Charges made against Unitarianism* by Dr. Magee (8vo, 1820);—*A Harmony of the Gospels* (8vo, 1835, of which a second edition, under the title of *An Apostolical Harmony of the Gospels*, was published in 1838);—*Sermons on Practical Subjects* (8vo, 1840, posthumous);—*Lectures on the Scripture Doctrine of Atonement* (12mo, 1843, posthumous). He was a contributor to *Rees's Cyclopædia*, and to the Unitarian journals. There is a memoir of him by his son, the Rev. R. L. Carpenter (Lond. 1840).—*English Cyclopædia*, s. v.; *Darling, Cyclopædia Bibliographica*, i, 582.

Carpocrates, a Gnostic of Alexandria in the second century, probably during the reign of Hadrian (A.D. 117-138). Of his personal history little is known. Clement of Alexandria speaks of his son Epiphaneus, who died at seventeen, and was honored as a god at Sama, in Cephallenia.—*Clemens, Strom.* iii, 428; *Lardner, Works*, viii, 398. See CARPOCRATIANS.

Carpocratians, Gnostic heretics of the second century, so named from Carpoctates of Alexandria (q. v.). In common with the Gnostics generally, they held the existence of one Supreme Principle, the Primal Being, or Monas, toward which all finite things are striving to return. They taught that the visible world was formed by angels, inferior to the Father (Epiphaneus, *Har.* xxvii, c. xi; *Iren. Har.* i, 25). They regarded Christ as a religious Genius, born, in the ordinary course of nature, of Joseph and Mary, but as having excelled other men not only by the holiness and virtue of his life, but by the wonderful elasticity of his mind (*στρονος*), which retained the remembrance of what he had seen when circling in the train of the Father. They admitted that he had been educated among the Jews, but had despised them, and had therefore obtained the power to surmount his sufferings,

and afterward ascended to the Father (*Iren. Har.* i, 25). The Carpocratians boasted of resembling Christ, and even allowed, hypothetically speaking, that if any person had a purer soul, or despised in a greater degree the things here below, he might excel him. They had statues and images of Christ and his apostles, and also of Pythagoras, Plato, Aristotle, and other eminent men, whom they are said to have honored with superstitious rites in the temple of Epiphaneus in Cephallenia. Carpocrates maintained the transmigration of the soul, which must perform all to which it was destined before it can obtain rest. In support of his doctrine he cited the words of our Lord, "Verily thou shalt not depart hence until thou hast paid the uttermost farthing." Those souls, however, which are deeply impressed with the remembrance of their former existence, are enabled to defy the influence of the spirits governing this world, and, soaring to the contemplation of the Supreme Being, finally reach a state of eternal rest. In proof of this, Carpocrates adduced the examples of Pythagoras, Plato, and Aristotle among the heathen, and Jesus among the Jews. To the latter he ascribed extraordinary strength of soul, which, animated by the remembrance of its former existence, soared to the highest flights of contemplation, and enabled him to obtain a divine power, by which, in working miracles, he set at naught the spirits of this world, cast off the thralldom of the God of the Jews, and overturned the religion which this god had devised. Every human soul was supposed by contemplation capable of becoming equal in every respect with Jesus Christ. The Carpocratians are stigmatized on account of the consequences which they drew from their principles. They are charged with asserting that there was nothing good or evil in itself; that the distinction between right and wrong was not real, but depended merely on human opinion—an assertion which appears inconsistent with their view of the character of Christ, and which was, perhaps, applied, not to moral duties, but to positive rites. They are also said to have taught the community of women; a doctrine which, together with their notions of a pre-existent state, and of metempsychosis, may be traced to Plato, in whose writings Carpocrates and his son Epiphaneus (by whom the opinions of this sect were much amplified, and to whom extraordinary honor was paid) were familiarly versed (*Clement, Strom.* iii, 428). As the fruit of these last opinions, they are represented as having indulged in the grossest licentiousness, and as having given occasion to the dreadful calumnies by which the early Christians were assailed. The reproach of licentiousness is not confirmed by Irenæus, who is the oldest source of our knowledge of the Carpocratians. Epiphaneus says the Carpocratians rejected the Old Testament. It appears not certain that they rejected any part of the New (*Euseb. Ecc. Hist.* iv, 7; *Epiphaneus, Har.* xxvii).—*Jeremie, Church Hist.* 154; *Neander, Ch. Hist.* i, 449-451; *Lardner, Works*, viii, 391-408; *Dorner, Person of Christ*, div. i, vol. i, p. 186; *Hase, Church History*, § 78; especially *Mosheim, Commentaries*, etc., cent. ii, § 50.

Car'pus (Κάρπος, perhaps for *καρπός*, fruit; on the accentuation, see *Winer's Grammar*, 6th ed. p. 49), a Christian at Troas, with whom the apostle Paul states that he left a cloak (2 Tim. iv, 13); on which of his journeys it is uncertain, but probably in passing through Asia Minor after his first captivity, for the last time before his martyrdom at Rome, A.D. 64. According to Hippolytus, Carpus was bishop of Berytus, in Thrace, called Berrhœa in the *Synopsis de Vita et Morte Prophetarum*, which passes under the name of Dorotheus of Tyre.—*Smith*, s. v.

Carpzov, the surname of a family which was one of the most distinguished of the 17th century for theological learning. The first eminent man of the name was Benedikt Carpzov, professor of law at Witten-

berg, who died in 1624; and the latest, Johann Benedikt (the fourth), died as professor at Helmstädt in 1808. The most important are:

CARPZOV, JOHANN BENEDIKT, born at Rochlitz, June 27, 1607, who became archdeacon of St. Thomas's church at Leipzig, and was made, in 1648, professor extraordinarius, and in 1646 professor ordinarius of theology at Leipzig. He died Nov. 27, 1657. He was noted for piety as well as for learning. His chief writings are, *De Nisiivitarum Pœnitentiâ* (Leipzig, 1640, 4to):—*Hodegeticum* (1656; enlarged by his son, J. B., 1689, 4to):—*Isagogæ in libros Eccl. Luther. Symbolicos*, completed after his death by Olearius (1665; 1675, 4to). In view of this book, Gass calls Carpzov the "first really distinguished laborer in Symbolica" (*Geschichte d. Prot. Dogmatik*, i, 172).

CARPZOV, JOHANN GOTTLÖB, the most eminent of the family, was born at Dresden, Sept. 26, 1679, and studied successively at Wittenberg, Leipzig, and Altdorf. In 1702 he became almoner to the Saxon ambassador, and in this capacity had the opportunity of travel in Holland and England, which he used to advantage for his culture in the Oriental languages. He was engaged in pastoral work at Dresden from 1704 to 1708, in which year he was called to St. Thomas's church in Leipzig. His studies took a wide range, but his chief bent was toward Hebrew literature and philology. In 1719 he was made professor of Oriental literature at Leipzig, which office he filled until 1730, when he became general superintendent at Lübeck, where he died April 7, 1767. His writings form an epoch in the history of Biblical criticism. He was a bitter opponent of the Moravians and Pietists, and wrote a historico-polemical treatise against the Moravians (mentioned below). His most important works are, *Disput. de vet. philose. sentt. circa naturam Dei* (Lpz. 1692, 4to):—*Disp. de pluralitate personarum in una Dei essentia* (Lpz. 1720, 4to):—*Introductio ad Libros Canonicos Vet. Test.* (Lpz. 1741, 2d ed. 4to):—*Critica Sacra Vet. Test.* (pt. i, *Text. Original*; pt. ii, *Versiones*; pt. iii, *Circa pseudo criticam G. Whistonii sollicita* (Lpz. 1728, 4to):—*Religions-Untersuchung der Böhmisch-und Mährischen Brüder* (Lpz. 1742, 8vo):—*Apparatus Hist.-Crit. Antiquitatum et codicis sacri et gentis Hebrææ* (Leipzig, 1748, 4to).—Ersch u. Gruber, *Allgem. Encyclopädie*, s. v.; Hoefer, *Nouv. Biog. Générale*, viii, 842.

CARPZOV, JOHANN BENEDIKT, born in Leipzig, 1720, became professor of philosophy at Leipzig in 1747; professor of Greek at Helmstädt, 1748. He published *Liber doct. theol. purioris* (1768):—*Sacra Exercitationes in Epist. ad Hebr.* (1750):—*Structura in Ep. ad Rom.* (1756):—*Septenarius Epist. Cath.* (1790). His reputation as a philologist was very great. He died April 28, 1803.

Carr (in some editions "car") is an Anglicized form of the term *χάρρα* (v. r. *κάρρα*), occurring only in 1 Esdr. v, 55, as the name of something given to the Phœnicians for furnishing cedar to rebuild the Temple. Bretschneider (*Spicileg.* p. 270) thinks we should read *χάραγμα*, i. e. *money*; perhaps, however, the word is simply a corruption for *κάρρα*, *coin* (see Fritzsche, *Handb.* in loc.).

CARRANZA, BARTOLOMEO DE, an eminent Spanish theologian and prelate, was born at Miranda, Navarre, in 1508, of noble parents. Having studied theology at Alcalá, he entered the order of Dominicans in 1520. He afterward was professor of theology at Valladolid. In 1546 Charles V sent him to the Council of Trent, where he vindicated the rights of bishops, *jure divino*, against the papal pretensions. Philip of Spain took him (1554) to England, where queen Mary appointed him her confessor, and charged him with the re-establishment of the Roman Church. This office he discharged "with a zeal more worthy of a Spanish inquisitor than of a minister of Jesus Christ," and was rewarded with the archbishopric of Toledo in 1558.

On entering his diocese he put forth a catechism, which his enemies made a subject of attack. It was censured by the Inquisition, but sanctioned by the commission of the Council of Trent. A more heavy charge awaited him. A report was circulated that Charles V had not died in the "faith of the Church," and that this was owing to the archbishop of Toledo, who had instilled into his mind "heretical opinions." Carranza was seized by the Inquisition and imprisoned in 1559. After eight years' duress in Spain he was transferred to Rome, where Pius V kept him ten years longer immured in the castle of St. Angelo. In 1576 he was finally acquitted, but was suspended from his episcopal functions for five years, and was compelled to reside in the Dominican cloister of Della Minerva at Rome. He lived only seventeen days afterward, dying May 2, 1576. He wrote, (1.) *Comentarios sobre el Catechismo Cristiano* (Antwerp, 1558, fol.):—(2.) *Summa Conciliorum* (Venice, 1548, 8vo):—(3.) *De necessariâ residentia Episc. et alior. pastorum* (Venice, 1547); and several practical treatises.—*Biog. Univ.* vii, 199; Burnet, *Hist. of Engl. Reformation*, iii, 381; Bayle, *Dictionary*, s. v.; Echard, *Script. ord. Prædicatorum*, s. v.; Hoefer, *Nouv. Biog. Générale*, viii, 854; Dupin, *Eccles. Writers*, cent. xvi.

Carriage. Vehicles answering to this term in modern usage were not known to the ancients. See CART. In the English Bible this word stands, therefore, as the incongruous rendering of several totally different terms. In 1 Sam. xvii, 20, the Hebrew word *מַגְלָלָה*, *magalah*, rendered "trench" in our version, and "place of the carriage" in the margin, probably signifies a *wagon-rampart*, a bulwark formed of the wagons and other vehicles of the army (1 Sam. xxvi, 5, 7). In Judg. xviii, 21, the original is *קְבוּרָה*, *kebudah*, and means *wealth*, i. e. *booty*. In Isa. xlvi, 1, "carriage" stands for *מַשָּׂא*, *mesah*, a *load* for a beast of burden. In 1 Sam. xvii, 22, the word *מַגְלָה*, *kelî*, "carriage," properly means *implements, equipments*; and in Isa. x, 28, *implements of war*. In Acts xxi, 15, the phrase, "we took up our carriages" (*ἀρκεσάμεθα*), should be, "we packed up our baggage." See WAGON.

Carrières, LOUIS DE, born at Cluville, near Angers, in 1662, was first a soldier, but in 1689 entered the congregation of the Oratory. He died at Paris June 11, 1717. He is chiefly known by his *Commentaire littéral*, or "Literal Commentary" on the whole Bible, which is so managed that his comments are introduced into the text (translated) in italic characters. They are for the most part in the words of holy Scripture itself, which is thus made to be its own interpreter. This work, which was carried through at the request of Bossuet, was completed in twenty-four 12mo volumes (1701 to 1716). It has since gone through many editions, and is much used. It is the only French version authorized in Italy.—*Biographie Universelle*, vii, 219.

Carroll, Daniel Lynn, D.D., a Presbyterian minister, was born in Fayette county, Pa., May 10, 1797, and graduated at Jefferson College, 1823. Having completed his theological course at Princeton, he was licensed in 1826, and supplied the churches of Shrewsbury and Middletown Point. Thence, after a brief sojourn at Princeton and Newburyport, he removed to Litchfield, Conn., where he was installed in 1827. He supplied the First Presbyterian Church, Brooklyn, in 1829, but his health soon obliged him to resign, and in 1835 he was appointed to the presidency of Hampden Sidney College, Va., which he held for three years. On retiring he took charge of the First Presbyterian Church in the Northern Liberties of Philadelphia, and subsequently became secretary of the Colonization Society of the state of New York till 1845, when he was obliged to give up all active service.

He died Nov. 23, 1851. He published *Sermons* (1846-7, 2 vols. 12mo), besides detached sermons and addresses.—Sprague, *Annals*, iv, 697.

Carroll, John, D.D., first Roman Catholic archbishop in the United States, was born at Upper Marlborough, Maryland, in 1734. He was educated at St. Omer's, France, and at the colleges of Liege and Bruges, in Belgium. In 1769 he was ordained priest, and became a Jesuit. When the order was dissolved in France he went to England, and became tutor to a son of Lord Stourton, with whom he travelled on the Continent. On the breaking out of the Revolutionary War he returned to America, and took an active part on the side of the patriots. After the close of the war, the Roman Catholic clergy in the United States requested from the pope the establishment of a hierarchy, and Mr. Carroll was appointed vice-general. He fixed his residence at Baltimore. In 1789 he was named bishop, and in the ensuing year was consecrated. In 1791 he assumed the title of bishop of Baltimore. A few years before his death he was made archbishop. He died Dec. 3, 1815.

Carahs'na (Heb. *Karshena'*, כַּרְשֵׁנָה, probably of Persian derivation; comp. mod. Pers. *Karshen*, "spoiler;" or Zend *Karshna*, Sanscr. *Kreshna*, "black;" Sept. has but three names, of which the first is 'Αρκαοια; Vulg. *Charshena*), the first named of the seven "princes" or chief emirs at the court of Xerxes (Ahasuerus) when Vashti refused to present herself at the royal banquet (Esth. i, 14). B.C. 488.

Carson, ALEXANDER, LL.D., a Baptist minister, was born in Scotland about 1776, but early removed to Ireland. He began his public life at Tubbermore as a minister in connection with the Presbyterian Synod of Ulster, but having changed his opinions as to Church government, and adopted the views of the Independents, he seceded in 1803. Embracing Independent Baptist views, he formed a society at Tubbermore, of which he remained pastor to the time of his death. He wrote, in 1803, his *Reasons for separating from the Synod of Ulster*; and afterward produced numerous books and pamphlets—on baptism and other subjects of controversy—which are highly esteemed by the Baptists. Though a strenuous advocate of immersion, he was not a "close" communionist. After many years of incessant activity, pastoral and literary, he died at Belfast, Aug. 24, 1844, from the effects of a sudden fall into the Mersey at Liverpool a few days before. Dr. Carson was an earnest and often bitter controversialist. His dogmatism and arrogance detract greatly from the effect of his arguments. He is often right, often wrong; but, whether right or wrong, he is equally self-confident. Besides a number of pamphlets, reviews, etc., he published *The God of Providence the God of the Bible* (18mo);—*Theories of Inspiration* (18mo);—*The Knowledge of Jesus* (18mo);—*The Unitarian Mystery* (8vo);—*Examination of the Principles of Biblical Interpretation of Ernesti, Stuart, Ammon, etc.*;—*A Treatise on Figures of Speech, and a Treatise on the Right and Duty of all men to read the Scriptures* (N. Y. 1855, 12mo);—*Baptism, in its Mode and Subjects, with a Sketch of the Life of Dr. Carson* (Phila. 1857, 5th ed. 8vo);—Jamieson, *Cyclopædia of Biography*; Reid, *History of the Presbyterian Church in Ireland*, iii, 449.

Carstares, WILLIAM, a Scotch divine and politician, was born in 1649, at Cathcart, near Glasgow, and completed his studies at the Universities of London and Utrecht. While in Holland he was introduced to the prince of Orange, who honored him with his confidence. After his return to England he became connected with the party which strove to exclude James from the throne, and, on suspicion of being one of the Rye-house conspirators, he was sent to Scotland, and put to the torture of the thumbcrew, which he bore with unshrinking firmness. On his liberation he went back to Holland, and became one of

the prince of Orange's chaplains. He accompanied William to England in 1688, and was appointed king's chaplain for Scotland. He was subsequently of great service in producing a reconciliation between the Scottish Presbyterians and William III. A General Assembly being about to convene, at which it was understood that there would be opposition to the oath of allegiance, the king had delivered to a messenger dispatches directing the peremptory enforcement of the act. It is said that Carstares assumed authority to stop the messenger; and, presenting himself to the king (who had gone to bed) in the middle of the night, in the guise of a petitioner for his life, forfeited by his having thus committed high treason, to have prevailed on him to dispense with the oath. Whether the anecdote be true or not, there is little doubt that his influence obtained the dispensation. He became now virtually prime minister for Scotland, and received the popular designation of "Cardinal Carstares." Even after the death of William, his knowledge of Scottish affairs, and the respect paid to his talents, left him with considerable influence. In 1704 he was chosen principal of the University of Edinburgh. He died Dec. 28, 1715. See *State Papers and Letters, to which is prefixed the Life of Mr. Carstares* (Ato, 1714); *Engl. Cyclopædia*; Hetherington, *Church of Scotland*, ii, 216.

Cart (כַּרְתָּוּ, *aqalak'*, from כָּרַב, *to roll*; Sept. *ἄμαξα* [so in Judith xv, 11], Vulg. *plaustrum*; also rendered "wagon," Gen. xlv, 19, 21, 27; xlv, 5; Num. vii, 8, 6, 7, 8; and "chariot" in Psa. xlv, 9 [comp. CART-WHEEL]), a vehicle moving on wheels, and usually drawn by cattle (2 Sam. vi, 6), to be distinguished from the chariot drawn by horses. See CHARIOT.

1. The carts which the king of Egypt sent to assist in transporting Jacob's family from Canaan (Gen. xlv, 19, 27) were manifestly not used in the latter country, but were peculiar to Egypt. These carts or wagons were, of course, not war-chariots, nor such curricles as were in use among the Egyptian nobility. The ready



An ancient Ethiopian Princess travelling in a Car drawn by Oxen, with a sort of Umbrella, a Driver, and a Footman.

means of transport and travel by the Nile seems to have rendered in a great measure unnecessary any other wheel-carriages than those for war or pleasure. The sculptures, however, exhibit some carts as used by a nomade people (enemies of the Egyptians) in their migrations (comp. Figs. 1 and 2, below).



Carts of the "Tokkari," some foreign nation defeated by the ancient Egyptians.

2. Elsewhere (Num. vii, 8, 6; 1 Sam. vi, 7) we read of carts used for the removal of the sacred arks and utensils. These also were drawn by two oxen. In Rossellini we have found a very curious representation of the vehicle used for such purposes by the Egyptians (Fig. 8). It is little more than a platform

on wheels; and the apprehension which induced Uzah to put forth his hand to stay the ark when shaken by the oxen (2 Sam. vi, 6) may suggest that the cart employed on that occasion was not unlike this, as it would be easy for a jerk to displace whatever might be upon it. See ARK.



Ancient Egyptian Carts: 1, 2, for ordinary purposes; 3, for conveying a Shrine containing a Mummy.

3. In Isa. xxviii, 27, 28, a *threshing-dray* or sledge is to be understood. See AGRICULTURE.

As it appears that the Israelites used carts, they doubtless employed them sometimes in the removal of agricultural produce. The load or bundles appear to have been bound fast by a large rope; hence "a cart-rop" is made in Isa. v, 18, a symbol of the strong attachment to sinful pleasures and practices induced by long and frequent habit. Carts and wagons were either open or covered (Num. vii, 8), and were used for conveyance of persons (Gen. xlv, 19), burdens (1 Sam. vi, 7, 8), or produce (Amos ii, 13). As there are no roads in Syria and Palestine and the neighboring countries, wheel-carriages for any purpose except conveyance of agricultural produce are all but unknown; and though modern usage has introduced European carriages drawn by horses into Egypt, they were unknown there also in times comparatively recent (Stanley, *Sinai and Pal.* p. 185; Porter, *Damascus*, i, 839; Lynch, *Narrative*, p. 75, 84; Niebuhr, *Voyage*, i, 123; Layard, *Nineveh*, ii, 75; Mrs. Poole, *Englishwomen in Egypt*, 2d series, p. 77). The only cart used in Western Asia has two wheels of solid wood (Olearius, *Travels*, p. 418;

drawn by oxen, conveying female captives; and others represent carts captured from enemies with captives, and also some used in carrying timber and other articles (Layard, *Nineveh*, ii, 896; *Nin. and Bab.* p. 134, 447, 583; *Mon. of Babylon*, pt. ii, pls. 12, 17). Four-wheeled carriages are said by Pliny (*Nat. Hist.* vii, 56) to have been invented by the Phrygians (Wilkinson, *Anc. Egypt.* Abridgment, i, 884, 385; ii, 89, 47). The carts used in India for conveying goods, called *suggar* or *hacker*, have two wheels, in the former case of solid wood, in the latter with spokes. They are drawn by oxen harnessed to a pole (Capper, *India*, p. 346, 352). —Kitto, s. v.; Smith, s. v. See WAGON.



Modern Indian Cart.

Carter, ABIEL, a minister of the Protestant Episcopal Church, was born at Concord, N. H., May 2, 1791. He graduated A.B. at Dartmouth College in 1818, and soon after began the study of law at New York; but, turning his attention to religion, he left the Congregational Church, in which he had been educated, and became a student of theology under bishop Hobart, by whom he was ordained deacon in 1815. He at once became assistant to Dr. Lyell at Christ Church, New York. He was ordained priest in 1816, and became rector of Trinity Church, Pittsburg, Pa., whence he removed in 1818 to St. Michael's Church, Trenton, N. J. In 1822 he became rector of Christ Church, Savannah, Georgia. In 1827 the yellow fever raged in Savannah, and although it had been stipulated in his call that he should spend the summer of each year in the North, he refused to leave his people. His wife soon fell a victim to the pestilence, which also carried him away, Nov. 1, 1827. He published a number of occasional sermons. — Sprague, *Annals*, v, 584.

Cartes, des. See DESCARTES.

Cartesian Philosophy. See DESCARTES.

Cartesius. See DESCARTES.

Carthage, a famous ancient city on the coast of Africa, founded by Tyrian colonists, and long the rival

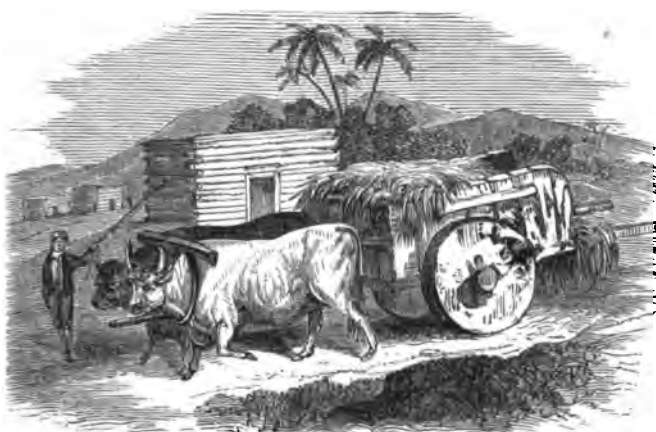

Modern Syrian Farm-cart.

Ker Porter, *Travels*, ii, 538). A bas-relief at Nineveh represents a cart having wheels with eight spokes,

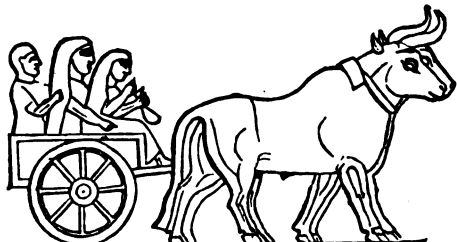

Captive Women in a Cart drawn by Oxen. From the Assyrian Monuments.

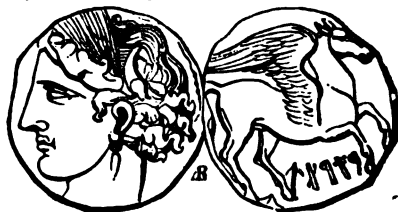

Coin of Carthage.

of Rome, by which it was taken and destroyed, B.C. 146. It was again rebuilt, however, and continued to flourish till the Vandal invasion (see a full account in Smith's *Dict. of Class. Geogr.* s. v.). Its site has lately been explored (Davis, *Ruins of Carthage*, Lond. 1861).

In Christian and ecclesiastical times Carthage was the metropolis of the proconsular province of Africa, and the seat of a bishop, having metropolitan authority over all the provinces of the African Church. All the African churches were dependent on the see of Rome, probably because their greater intercourse with Rome had made Latin the language of the country, and it was therefore more natural that they should be connected with the Latin than the Greek Church. Until the time of Constantine, the bishop of Carthage was the only prelate in the African Church having metropolitan jurisdiction; but under Constantine Africa was divided into six provinces, and each province began to have its own metropolitan, taking, however, the title of *primate*, and not that of *metropolitan*, which was still peculiar to the bishop of Carthage. This prelate, from the first, had authority to select whom he pleased from any church in Africa to consecrate to a vacant see (third Council of Carthage); for the bishop of Carthage had also the privilege of nominating to all the vacant sees of Africa. It was farther a privilege enjoyed by the primate of Carthage to convolve general and diocesan synods, to preside in them, and to judge therein of appeals brought thither from the provincial councils. That the African Church acknowledged no *papal* authority in the Roman see is evident from the well-known case of the priest Apiarius, where the African bishops denied the authority of the pope to receive appeals from the decisions of their synods, and his right to send a legate to take any sort of cognizance of their proceedings. In 691 the Saracens got possession of the city of Carthage, and of all this part of Africa, from which period the Church began to fall away; and though it was still in existence, under Leo IX, in the eleventh century, it soon after became entirely extinct.—Landon, *Eccles. Dictionary*, s. v.

CARTHAGE, COUNCILS OF. Among the most important are the following:

I. In 218-22 (?), under Agrippinus, on the baptism of heretics.

II. In 251, on the election of Cornelius as bishop of Rome, and the disputes of Novatian and Felicesimus.

III. In 252, on early baptism.

IV. In 253, on the baptism of infants and heretics.

Cyprian presided, and 66 bishops are said to have been present. On the question whether baptism should be administered to infants before the eighth day, in view of the rite of circumcision, the council decided unanimously that God had no respect either to persons or ages; that circumcision was but the figure of the mystery of Jesus Christ, and that no one may be shut out from the grace of God. Cyprian, who wrote this decision to Fidus in his own name and in that of his colleagues, gives the reason for it in these words: "If the greatest sinners coming to the faith receive remission of sin and baptism, how much less can we reject a little infant just born into the world, free from actual sin, and only so far a sinner as being born of Adam after the flesh, and by its first birth having contracted the pollution of the former death; it ought to have so much the easier access to the remission of sins, inasmuch as not its own sins, but those of others, are remitted." These words are quoted by Jerome in his dialogues against the Pelagians, and by Augustine in his 29th sermon, in order to prove that belief in original sin has always been the faith of the Church.—Cyprian, *Epist.* 56, Labbe et Cossart, *Concilia*, t. i, p. 740; Landon, *Manual of Councils*, 101.

V. Held in 264 (?), when the Spanish bishops Martinus and Basilides were deposed as *Libellatici*.

VI. Held in 255 and 256, under Cyprian, on the necessity of rebaptizing heretics—attended by 71 bishops.



They decided that there can be no valid baptism out of the Catholic Church, and addressed a synodical letter to Stephen of Rome upon the subject, informing him of their decision upon this and other matters. Stephen refused to admit the decision, and separated himself from the communion of Cyprian and the other bishops who acted with him in the council. The conflict lasted until the pontificate of Sixtus, when the African bishops gave up their theory of the invalidity of heretical baptism.—Labbe et Cossart, *Concilia*, t. i, p. 798; Landon, *Manual of Councils*, p. 102.

VII. Held in 380, in favor of those who were steadfast in the persecution.

VIII. Held in 397 and 398, on discipline and the baptism of children.

IX. Two in 401, in which numerous canons were made on receiving converted children of Donatists among the clergy.

X. Two in 408, on pagans, heretics, and Donatists.

XI. Commencing June 1, 411, in which conferences were held with the Donatists, with a view to their reunion with the Church. Augustine was present, and argued the case from the side of the Church. At the close of the conference, Marcellinus, who represented the emperor Honorius in the council, gave sentence to the effect that the Donatists had been entirely refuted by the Catholics; and that, accordingly, those of the Donatists who should refuse to unite themselves to the Church should be punished as the laws directed. From this sentence the Donatists appealed to the emperor, but in vain. Honorius confirmed the acts of the Conference of Carthage by a law, bearing date Aug. 30, 414. This conference and the severe measures which followed it gave the death-blow to Donatism.—Labbe et Cossart, *Concilia*, t. iii, p. 107; Neander, *Church History*, ii, 208 sq.; Landon, *Manual of Councils*, p. 111.

XII. Held in 411 or 412, against Coelestius, disciple of Pelagius. Coelestius was accused by Paulinus, among other things, of teaching that the sin of Adam only injured himself, and that its effects have not descended to his posterity, and that every child is born into the world in the same condition in which Adam was before the Fall. Coelestius did not deny the accusation; for, although he agreed that children must of necessity receive redemption by baptism, yet he refused to acknowledge that the sin of Adam had passed upon them; nor would he confess, unequivocally, that they receive therein remission of any sin: accordingly he was condemned and excommunicated.—Labbe

et Cossart, *Concil.* t. iii, p. 847 sq.; Landon, *Manual of Councils*, p. 111; Mansi, *Concil.* iv, 289.

XIII. Held in 416, against Pelagius and Coelestius. The doctrines of Pelagius were condemned by this council in a decree which was approved by Innocent I, bishop of Rome.

XIV. Held in 418, at which more than 200 bishops took part, under the presidency of Aurelius. Augustine styles it "the Council of Africa." Its decrees against Pelagianism were the triumph of Augustinism, and finally received the general approval of the Church. Prosper has preserved one of these decrees, in which the council declares that the grace of God given to us through Jesus Christ not only assists us to know what is right, but also to practise it in each particular action, so that without it we can neither have, nor think, nor say, nor do anything which appertains to holiness and true piety. The council agreed upon a letter to Zosimus, bishop of Rome, demanding that the sentence of condemnation passed by Innocent I against Pelagius and Coelestius should be enforced until they should abjure their errors. — Mansi, *Concil.* iii, 810; iv, 877; Landon, *Manual of Councils*, p. 112; Schaff, *Ch. Hist.* iii, 798.

Carthusians, an order of monks in the Roman Catholic Church, founded by St. Bruno (q. v.) A. D. 1086. A legend of much later origin tells the following story: At the funeral of a friend of Bruno's in 1082, the dead man raised himself up, saying, "By the just judgment of God I am accused!" This was repeated on the two following days, and had such an effect on Bruno and six more that they immediately retired to the desert of the Chartreuse, and there built the first monastery. This absurd legend found its way into the Roman breviary, but was struck out by order of Pope Urban VIII. After Bruno had governed the first establishment for about six years, Pope Urban II, his former pupil, called him to Rome, and retained him there, although Bruno begged for permission to return to his brethren. The order increased slowly. In 1187 they counted four, in 1161 fourteen, and in 1258 fifty-six houses. In 1170 the order was recognised by the pope. Martin V exempted all the property of the order from tithes. Julius II provided, in 1508, by a bull, that the prior of the Grande Chartreuse, near Grenoble, should always be the general of the whole order, and that a general chapter should meet annually. At the beginning of the 18th century the number of houses was 170, of which 75 belonged to France. Many houses perished in the French Revolution, but some were re-established after 1815. Their principal establishment, the Grande Chartreuse, was reoccupied in 1816. In England the Carthusians settled in 1180, and had a famous monastery in London, since called, from the Carthusians who settled there, the "Charter-house." The order has given to the Church several saints, three cardinals, and more than seventy archbishops and bishops.

Until 1180 the order had no written statutes. Then the fifth prior of the Chartreuse, Guigo, compiled the *Consuetudines Cartusie*. Bernard de la Tour collected, in 1258, the resolutions of all general chapters which had been held since 1141. This collection was confirmed by the General Chapter of 1259, and bears the title *Statuta antiqua*. Another collection, *Statuta nova*, was added in 1867. A third collection, *Tertia compilatio statutorum*, dates from the year 1509; a fourth, *Nova collectio statutorum ordinis Cartusiensis*, from the year 1581. The characteristic of the statutes of this order is, that it aims, in the first place, at precluding the members from all intercourse with the world, and even, as far as possible, from all intercourse with each other; secondly, at separating the *professi* from the lay brothers, who occupy in no other order an equally low position, and are divided into three classes, *Conversi*, *Donati*, and *Redditi*; thirdly, at separating every single Carthusian monastery from the whole surround-

ing region and population; and, lastly, at preventing all connection of the order with other monastic orders, and any direct influence on the world or the Church. Thus the whole order, and each individual member, is like a petrification from the Middle Ages. The monks wear a hair-cloth shirt, a white cassock, and over it, when they go out, a black cloak. They never eat flesh, and on Friday take only bread and water. They are not allowed to go out of their cells except to church, nor to speak to any person, even their own brother, without leave of their superior. Some of the convents are magnificent, especially those of Naples and Pavia, which have a world-wide renown for their ornaments and riches. In 1843 the order had 8 houses in France, 8 in Italy, and 2 in Switzerland.



Carthusian Monk—at Home. Carthusian Nun—at Home.

There are also houses of Carthusian nuns, but the date of their origin is not known. They were always very few in number. Father Helyot, the historian of monachism, knew only of the existence of five, all of which perished by the French Revolution. In 1820 they re-established their first house near Grenoble, in France, and this is still their only establishment.

A history of the order was commenced by father Masson, general of the order, and vol. i published in 1687; but, for unknown reasons, the order forbade the continuance of the work. See also Morstius, *Theatrum Chronologicum S. Ordinis Cartusiensis* (Taur. 1681); Corbin, *Histoire sacrée de l'ordre des Chartreux* (Paris, 1653, 4to); Helyot (ed. Migne), *Dict. des Ordres Relig.* i, 872; Fehr, *Geschichte der Mönchsorden*, i, 78 sq.

Cart-wheel (*τροχός ἀμάξης*), a chariot wheel (Ecclus. xxxiii, 5). See CART; WHEEL.

Cartwright, Thomas, a learned and eminent Puritan divine; born in Herts about 1585. He was educated at St. John's College, Cambridge, where he became a fellow in 1560. A few years afterward he was removed to a fellowship at Trinity College, of which he became one of the senior fellows. In 1564, when Queen Elizabeth visited the University, he appears to have distinguished himself in the disputations held before her majesty. He took his B. D. degree in 1567, and three years afterward was chosen Lady Margaret's divinity professor. He was a thorough Protestant. In his lectures he criticised the polity of the Church of England with great acuteness and learning. It was his conviction that the reformation of the Church had not gone far enough; and he advocated his views with a clearness and boldness which none could mistake. The following statement of the doctrines for which he was expelled from the University is given by Hook, in vindication of the severity with which Cartwright was treated. It will be seen that, with a

few exceptions, they are views in which most moderate men in the Church of England would now agree with other Christians. "He maintained that, in reforming the Church, it was necessary to reduce all things to the apostolical institution; that no one ought to be admitted into the Christian ministry who was unable to preach; that those only who ministered the word ought to pray publicly in the Church, or administer the sacraments; that popish ordinations were not valid; that only canonical Scripture ought to be read publicly in the Church; that the public liturgy ought to be so framed that there might be no private praying or reading in the Church, but that all the people should attend to the prayers of the minister; that the service of burying the dead did not belong any more to the ministerial office than to the rest of the Church; that equal reverence was due to all canonical Scripture, and to all the names of God: there was, therefore, no reason why the people should stand at the reading of the Gospel, or bow at the name of Jesus; that it was as lawful to sit at the Lord's table as to kneel or stand; that the Lord's Supper ought not to be administered in private, nor baptism administered by women or laymen; that the sign of the cross in baptism was superstitious; that it was reasonable and proper that the parent should offer his own child to baptism, making confession of that faith in which he intended to educate it, without being obliged to answer in the child's name, 'I will,' 'I will not,' 'I believe,' etc., nor ought women or persons under age to be sponsors; that, in giving names to children, it was convenient to avoid paganism, as well as the names and offices of Christ and angels; that it was papistical to forbid marriages at any particular time of the year, and to grant licenses at those times was intolerable; that private marriages, or such as were not published in the congregation, were highly inconvenient," etc.

Archbishop Grindal and Dr. Whitgift zealously opposed Cartwright, and in 1571 he was deprived of his professorship and fellowship. He retired from England to the Continent, became chaplain at Antwerp, and afterward at Middleburg. At the end of about two years he returned to England, and published a *Second Admonition to the Parliament*, with a petition for relief from the subscription required by the ecclesiastical commissioners. He had a controversy of pamphlets with Whitgift, and was greatly persecuted by that prelate, and was twice imprisoned. In 1585 he obtained from the earl of Leicester the mastership of the new hospital at Warwick. In 1592 he was liberated from his second imprisonment, and returned to the mastership of the hospital at Warwick, where he died, Dec. 27, 1603 (or 1602, according to Isaac Walton). Cartwright was a man of great parts. Beza wrote of him: "I think the sun does not see a more learned man." Froude, in his *History of England* (1866, vol. iv), gives an elaborate panegyric of Cartwright. Among his writings are, *Commentaria Practica in totam Historiam Evangelicam* (1630, 4to); and by L. Elzevir, at Amsterdam, 1647; Eng. version, 1650): —*Commentarii in Proverbia Salamonis* (Amsterdam, 1638, 4to); —*Metaphrasis et Homilia in Librum Ecclesiasticum* (ibid. 1647, etc.); —*A Body of Divinity* (London, 1616, 4to); —*Directory for Church Government* (1644, 4to); —*Confutation of the Rhemish Testament* (1618, fol.). His exegetical writings are still of value. Dr. Alexander (in Kitto's *Cyclopaedia*, s. v.) says that Hengstenberg, in his work on Ecclesiastes, borrows largely from Cartwright's *Metaphrasis*. See STRYPE, *Life of Whitgift*; Hook, *Ecol. Biography*, iii, 479; Neal, *History of the Puritans*, i, 172; ii, 48, et al.; iii, 404; Walton's *Lives*; Middleton, *Evang. Biography*, ii, 826.

Cartwright, Thomas, D.D., bishop of Salisbury, was born at Northampton Sept. 1, 1684. He studied at Magdalen Hall and Queen's College, Oxford, and, after taking orders, became chaplain of Queen's, and vicar of Walthamstow. In 1669 he was preacher of

St. Mary Magdalen, Fish Street. After the Restoration he was made domestic chaplain to Henry, duke of Gloucester; prebendary of Twyford, in the church of St. Paul; of Chalford, in the church of Wells; a chaplain in ordinary to the king; and rector of St. Thomas the Apostle, London. In 1672 he was made prebendary of Durham, and in 1677 dean of Ripon. His loyalty was, in 1686, rewarded with the bishopric of Chester. At the Revolution he fled to France, and performed divine service at St. Germain, according to the English ritual, for such as resorted to him. On the death of Dr. Seth Ward, king James nominated him to the see of Salisbury. In the spring of 1688 he went to Ireland, and finally died there, April 15, 1689. He wrote a *Diary*, published by the Camden Society in 1843.—Hook, *Ecol. Biog.* iii, p. 480 sq.

Carvajal. I. GIOVANNI, born in the year 1400, of an illustrious family of Andalusia, became bishop of Piacenzia, and governor of Rome. He was present at the Council of Basle, where he so warmly defended the interest of the papacy that Eugene IV created him cardinal in 1446. The succeeding popes sent him as their legate to Germany, Bohemia, and Hungary. He died at Rome in 1469.

II. BERNARDINO, nephew of the preceding, was born at Piacenzia in 1456. In 1493 he became cardinal and papal nuncio in Spain. He was put under the ban by Pope Julius II for having, in 1511, assembled the Council of Pisa, before which the pope was cited on account of his conduct toward the emperor Maximilian and king Louis XII of France. Leo X, however, restored him his dignities in 1513, and he was employed on important missions by the succeeding popes. He died bishop of Ostia in 1523.—Pierer, *Universal-Lexikon*, s. v.

Carve, in some of its forms, is the rendering in the Auth. Vers. of several Heb. words from the following roots: 1. Prop. כָּלָה, *kala'*, to "carve" wood (1 Kings vi, 29, 32, 35); hence כָּלְלָה, *milla'ah*, sculpture in relief (1 Kings vi, 18, 29, 32; "graving," vi, 31). 2. שָׂרַח, *charash'*, to engrave; whence שָׂרַח, *charosheth*, cutting of wood or stone (Exod. xxxi, 5; xxxv, 38). 3. חָכַח, *chakah'*, to hem; whence חָכַח, *mechukkeh'*, carved (1 Kings vi, 35). 4. פָּתַח, *pathach'*, to open; in Piel, to sculpture ("grave") wood (1 Kings vii, 36; 2 Chron. iii, 7), gems (Exod. xxviii, 9, 36; 2 Chron. ii, 7, 14), etc. (Exod. xxviii, 11; xxxix, 6; Zech. iii, 9); whence פָּתַח, *pitha'ach*, sculpture (Exod. xxviii, 11, 21, 36; Psa. lxxiv, 6; 1 Kings vi, 29; elsewhere "graving," etc.). 5. חָתַב, *chatab'*, to cut into figures; whence חָתַב, *chatuboth'*, variegated (Prov. vii, 16). 6. Especially, חָצַב, *pasal'*, to hew or shape; whence חָצַב, *pe'sel*, a "carved" or "graven" image (Exod. xx, 4, and often). 7. The Greek word "carve" in the Apocrypha is γλύφω (Wisd. xiii, 18; 1 Macc. v, 68). See ENGRAVE.

The Egyptians were extremely fond of carving on articles of furniture, and also in the decoration of walls and ceilings; and, indeed, there was scarcely a corner in an Egyptian palace destitute of carved ornaments. See HANDICRAFT. The ebony and ivory required for these costly works were obtained, either as a tribute or by traffic, from the Ethiopian nations. We frequently find both elephants' teeth and logs of ebony represented on the monuments as brought to the Egyptian monarchs; and we learn that Solomon did not erect his splendid ivory throne until he had opened a communication with the nations bordering on the Red Sea, through his alliance with the king of Tyre. The arts of carving and engraving were much in request in the construction both of the Tabernacle and the Temple (Exod. xxxi, 2, 5; xxxv, 33; 1 Kings vi, 18, 35; Psa. lxxiv, 6), as well as in the ornamentation of the priestly dresses (Exod. xxviii, 9-36; Zech. iii, 9;

2 Chron. ii, 6, 14). In Solomon's time, Hiram the Phœnician had the chief care of this, as of the larger architectural works. That the art of carving, however, was cultivated by the Hebrews themselves to a considerable extent, is evident, not only from the cherubim, which were set first in the Tabernacle, and afterwards in Solomon's Temple, but also from the lions which were placed on each side of his throne (1 Kings x, 20). The carving of timber is mentioned in Exod. xxxi, 5, and the prophet Isaiah gives us a minute description of the process of idol-making (xliv, 18). The origin and progress of the art of carving, as connected with Biblical inquiries, have been investigated and illustrated with much ingenuity by Mr. Landseer, in his *Sabœan Researches*. See GRAVEN IMAGE.

Carvoso, Benjamin, a Methodist missionary, son of William Carvoso, was born in Cornwall, England, Sept. 27, 1789. The eminent piety of his parents saved his youth from vice, and in 1811 he was converted. In 1814 he entered the itinerant ministry, and in 1820 was appointed missionary to New South Wales. There and in Van Diemen's Land, where he introduced Methodism, his labors were abundant and useful. In 1830 he returned to England, and re-entered the home work. He died Oct. 2, 1854. He commenced the first religious magazine in Australia, and wrote also *Memoir of William Carvoso* (q. v., New York, 1837, 12mo), which has been sold by thousands. — *Wesleyan Minutes* (Lond. 1855), p. 12.

Carvoso, William, a lay Methodist, one of the "saints" of modern times. He was born in Cornwall, England, March 11, 1760, and bred on a farm. In his youth he fell into the prevalent sins of the time, such as cock-fighting and Sabbath-breaking; but in 1771 he was converted, after a severe mental struggle. In 1774 he became a class-leader in the Wesleyan Church, and held that useful office for sixty years. His whole life was a wonderful illustration of the power of Christian faith, and his visits, prayers, and exhortations were the means of hundreds of conversions. He died Oct. 13, 1834. See *Memoir of William Carvoso*, edited by his son (N. Y. 18mo, a book which has had a vast circulation), and Stevens, *History of Methodism*, iii, 218, 279, 495.

Carwithen, J. B. S., a minister of the Church of England, was born in 1781. Having been ordained deacon in 1808 and priest in 1806, he was in 1810 appointed perpetual curate of Sandhurst, Berks, and in 1814 perpetual curate of Frimley, Hants. He died at Sandhurst vicarage in 1832. He published *A View of the Brahminical Religion in its Confirmation of the Truth of Sacred History, in a Series of Discourses preached in 1809* (Lond. 1810, 8vo):—*History of the Church of England*, parts 1 and 2 (2d ed., with a notice of the author by W. R. Browell, A.D., Oxf. 1849, 2 vols. 12mo):—*History of the Church from the Fourth to the Twelfth Century* (with Rev. A. Lyall, from *Encyclop. Metropol.* Lond. 1856, 12mo).—Darling, *Cyclop. Bibliog.* i, 569; *British Critic*, vii, 45.

Cary, Lot, a colored Baptist minister, was born a slave about 1780, in Charles City county, Va. He joined the Baptist Church in 1807 at Richmond, and, having learned to read and write, he held meetings with the colored people so successfully that the Church licensed him to preach. By rigid economy he was enabled to purchase his own freedom and that of his two children in 1813; and in 1815, having become deeply interested in the missions to Africa, he succeeded in establishing the "Richmond African Missionary Society." Having been ordained, he sailed for Sierra Leone Jan. 23, 1821, in company with Colin Teague, another colored preacher. He established a school at Monrovia, and attempted to establish another at Grand Cape Mount. Having studied the diseases of the country, he was in 1824 appointed physician to the colony. In September, 1826, he was appointed to the office of

vice-agent, and on Mr. Ashmun's return to America in 1828 he became acting governor of Liberia. An accidental explosion, Nov. 8, 1828, while he was engaged in manufacturing cartridges wherewith to defend the colony against the attacks of some slave-dealers, caused his death on the 10th of the same month.—Sprague, *Annals*, vi, 578.

Caryl, Joseph, a nonconformist divine of good abilities, learning, and industry, was born in London in 1602. He was for some time a commoner at Exeter College, Oxford, and preached several years with great success before the Hon. Society of Lincoln's Inn. Appointed one of the triers in 1653, he was ejected in 1662, and afterwards gathered a congregation in the neighborhood of St. Magnus, London Bridge. He died Feb. 7, 1678. His principal work, showing great learning, if not judgment, is his *Exposition, with Practical Observations on the Book of Job* (Lond. 1648-66, 12 vols. 4to; 2d edit. 2 vols. fol. 1676-7), abridged by Berrie (Edinb. 1836, 8vo).—Darling, *Cyclopaedia Bibliographica*, i, 590; Neal, *History of the Puritans*, v, 17; v, 581; Calamy, *Nonconformist's Memorial*, i, 221.

Casas, Bartolomeo de las, bishop of Chiapa, Mexico, was born of a noble family at Seville in 1474. His father Antonio, who went to Hispaniola with Columbus in 1498, and returned rich to Seville in 1498, made him a present of an Indian slave while he was pursuing his studies at Salamanca. At nineteen he accompanied his father to St. Domingo, whence he returned to Spain, entered the Dominican order, and fitted himself for a missionary. In 1535 he fixed his residence at St. Domingo, and employed himself in preaching Christianity to the Indians. Afflicted by the cruelties which the Indians endured from their conquerors, Las Casas made another voyage to Spain in order to interest Charles V in their behalf, and so far succeeded as to procure orders for the observance of the governors in the west, restricting the exercise of their powers. Upon his arrival in America he traveled through Mexico, New Spain, and even into Peru, notifying everywhere the imperial commands. In 1539 he again crossed the ocean to solicit aid of the emperor in behalf of the Indians. After infinite disappointments, the emperor granted all that he had asked for, and conferred upon him the bishopric of Chiapa. In 1544 he was consecrated at Seville, and returned with a band of missionaries to America, where he labored with incessant zeal and boldness to defend the natives, and at length retired to Spain, where he continued his endeavors in their behalf until his death, about 1566. One of his chief opponents was Sepulveda, a canon of Salamanca, who published an infamous work justifying the cruelties exercised upon the Indians, and even their murder. Las Casas replied by a writing entitled *Brevissima relacion de la destruccion de las Indias* (Seville, 1552, 4to). Charles V forbade its publication, but it was printed, and Sepulveda persisted, nevertheless, in his devilish doctrine, endeavoring in all ways to propagate the notion that, by the laws of the Church, it was a duty to "exterminate those who refused to embrace the Christian faith." Charles V appointed his confessor, the celebrated Dominic Soto, to examine the subject. Soto made his report to the council of Spain, but no judgment was ever pronounced, and the horrible massacres of the Indians continued to such an extent that, it is said, fifteen millions of these innocent victims perished in less than ten years. This is doubtless an exaggeration. An infamous calumny has been circulated by some historians against Las Casas, founded on the authority of Herrera alone, a writer of no credit, viz. that he first counselled the Spaniards to purchase negro slaves to labor instead of the Indians. This story has been sufficiently refuted by Grégoire, Llorente, and others. The other works of Las Casas are *Narratio regionum Indicarum per Hispanos quosdam devastatarum*, etc. (Frankfort, 1596, 4to, and at Tubin-

gen in 1625; also in French, at Antwerp, 1679); *Principia quaedam ex quibus procedendum est in disputatione ad manifestandam et defendendam justitiam Inordinum, etc.* His works were published at Seville, 1652, in five parts, 4to; but his *Historia General de las Indias* remains in MS.—Prescott, *History of Mexico*; Grégoire, *Apologie de Las Casas* (Mem. of Mor. and Polit. of Institute of France, vol. iv.); Landon, *Ecccl. Dictionary*, s. v.; *Revue de Paris*, 1843, 381; *Foreign Quart. Review*, March, 1835; Hoefler, *Nowv. Biog. Générale*, xxix, 745.

Casaubon, ISAAC, one of the most learned men of his own or of any age, was born Feb. 18th, 1559, at Geneva, whither his family, originally of Dauphiné, fled to avoid the persecutions to which the French Protestants were exposed. His father, Arnauld Casaubon, a minister of the Reformed Church, returned into France, and devoted himself to the education of his son, who, at nine years of age, spoke Latin. In 1578 he went to Lausanne, and studied law, theology, and the Greek and Oriental languages. He soon became professor of Greek at Geneva, and married the daughter of Henry Stephens, the celebrated printer, and soon began to put forth translations of the Greek and Latin writers, with notes and commentaries. In 1596 he accepted the Greek professorship at Montpellier, but held it only until 1599, when he was called to Paris by Henry IV, and received the appointment of librarian to the king. Henry appointed him one of the Protestant judges in the controversy between Du Perron, bishop of Evreux, and Du Plessis Mornay, at Fontainebleau (1600). The Roman Catholics made many attempts to gain so distinguished a convert; but there does not seem to be any reason for concluding that they had even partial success, although it was given out that he had wavered in a conference with Du Perron. On the death of Henry IV, 1610, Casaubon went to England with Sir Henry Wotton. James I received him with distinction, and presented him, though a layman, to a prebend at Canterbury, and (it is said) to another in the church of St. Peter, at Westminster. He died July 1, 1614, and was buried in Westminster Abbey. Besides his classical works he published *Exercitationes contra Baronium* (London, 1614, fol.), Frankfurt, 1615, and Geneva, 1663, 4to); *Novum Testamentum Græcum* (Geneva, 1587, 16mo, with notes; reprinted in the *Critici Sacri*); *De libertate Ecclesiasticâ* (1607, 8vo), undertaken by order of Henry IV on occasion of the difference between the republic of Venice and Pope Paul V, with the aim to maintain the rights of the temporal power against the court of Rome. It was stopped by the king's order, when the difference in question was settled. He also wrote *Ad Frontonem Duocæm Epistola* (Lond. 1611, 4to) against the Jesuitical doctrine of authority. The best edition of his *Letters* is that of Rotterdam (1709, fol). There is a full account of his life and writings in Haag, *La France Protestante*, iii, 230.—*Biog. Univ.* vii, 259; Landon, *Ecccl. Dictionary*, s. v.; Hoefler, *Nowv. Biog. Générale*, viii, 954.

Case, Isaac, a Baptist minister, was born at Rehoboth, Bristol Co., Mass., Feb. 25, 1761, united with the Baptist Church in 1779, was licensed the following year, and was ordained in 1783. For many years Mr. Case labored as a missionary in Maine, New Brunswick, and Nova Scotia, and with much success, until advancing age rendered him incapable of farther exertion. He died at Readfield, Nov. 3, 1862, in the 92d year of his age and the 72d of his ministry.—Sprague, *Annals*, vi, 205.

Case, William, missionary to the Indians in Canada, was born in Swansea, Mass., Aug. 27, 1760. He embraced a religious life in 1803, and was received on trial in the New York Conference of the Methodist Episcopal Church in 1805. His first appointment was to the Bay of Quinte, Canada. In 1809 he served as missionary at Detroit. From 1810 to 1827 he served as presiding elder in various districts in Western and

Northern New York, and in Canada. In 1828 Canada was given up to the Wesleyan Methodists, and Case was made superintendent of Indian missions and schools; and from 1880 to 1888 he was general superintendent, without episcopal powers, of the Methodist societies in Canada. A great part of his time, in all these years, was spent in missionary work among the Indians. In 1837 he was made principal of the Wesleyan native industrial school at Alnwick, in which service he remained until 1851. In 1854 he delivered a sermon before the Canadian Conference in commemoration of the fiftieth year of his service in the ministry. He died, in consequence of a fall from his horse, at the Alnwick mission-house, Canada, Oct. 19th, 1856. He filled all his ecclesiastical posts with honor; but his greatest field of usefulness was among the Indians. "The very spirit of Elliot seemed to be reproduced in him."—*Minutes of the Canadian Conference*, 1856; *West. Method. Magazine*, 1856, p. 179; Sprague, *Annals*, vii, 425; *Case and his Contemporaries* (Toronto, 1867).

Caselius, JOHANN, an eminent German scholar, was born at Göttingen in 1583. He studied first in the schools of Gandersheim and Nordhausen, and afterwards in the universities of Wittenberg and Leipzig, where he received the lessons of Melancthon and J. Camerarius. He then visited Italy, where he continued his studies, and on his return became, in 1563, professor of philosophy and rhetoric in the University of Rostock. During a second journey he made in Italy he received the degree of LL.D. at Pisa, in 1566, and the following year received a patent of nobility from the emperor Maximilian. In 1599 he accepted a professorship in the University of Helmstadt, where he opposed, in union with the Melancthonians, the efforts of ultra Lutheran orthodox, principally represented by his colleague, Daniel Hoffmann (q. v.), to proscribe science and philosophy. He was the teacher of George Calixtus (q. v.), and wrote a great number of works, most of which remain unpublished. He died in 1618. See J. Burkhardt's *Epistola de Jo. Caselio erga bonas literas meritis ejusque laudationem editio* (Wittenb. 1707, 4to).—Herzog, *Real-Encyclopædie*, ii, 598.

Casement (כַּסְמֵת, *eshnab'*, Prov. vii, 6; "lattice," Judg. v, 28), a kind of barrier of open-work, placed before windows in the East, which, being usually open in summer down to the floor, require some such defence. See HOUSE.

Cashel, formerly an archiepiscopal see in Ireland. This ancient see is now deprived of its metropolitan dignity, and has united to it the sees of Emly, Waterford, and Lismore; the united diocese consisting of the counties of Tipperary, Waterford, and part of Limerick. The incumbent in 1868 was Robert Daly, D.D., consecrated in 1843.

Casiph'ia (Heb. *Kasiphya'*, כַּסְפִּיָּה, perhaps from כַּסְפִּי, *silver*, or *whitish*, if the name be not of Arian origin; Sept. so translates ἀργύριον), a "place" (מְקוֹם, i. e. region) of the Persian empire, where Levites had settled during the Captivity, whence Iddo, with others of them, were sent for by Ezra to join his party returning to Jerusalem (Ezra viii, 17). Gesenius (*Thesaur.* p. 708) objects to the identification by some with the *Caspia Pyla*, and of others with the city *Kasvin*, that these are not on the route from Babylon to Palestine. As this position of the place in question, however, is not clear, it is likely that, if the *Caspian Sea* be not designated by this name, it may refer to the "*Caspian Mountains*, situated in Media (Strabo, xi, p. 522, 525; Pliny, vi, 15), where Jewish exiles seem to have been located (Tobit i, 16; iii, 7). This is at least favored by the rabbinical tradition, *Vajitra Rabba* (v, 5), and is defended by Fürst (*Heb. Handb. v. s. v.*), who adduces also the local title *Albania* as a coincidence with the silvery summits of the

snow-capped range of Caucasus (comp. *Alp*, i. e. *albus*, "white").

Cas'lev (Χασλεῦ), a Græcized form (1 Macc. i, 54; iv, 52, 59; 2 Macc. i, 9, 18; x, 5) of the name of the Jewish month elsewhere (Neh. i, 1; Zech. vii, 1) Anglicized **CASLEV** (q. v.).

Cas'luhim (Heb. *Κασλὺχίμ*, קַסְלוּחִים, of uncertain, but prob. foreign etymology; Sept. in Gen. *Χαρωμνίμ*, Vulg. *Chasluim*; in Chron. *Χαλωμνίμ* v. r. *Χαλωίμ*, *Casluim*), a people whose progenitor was a son of Mizraim (Gen. x, 14; 1 Chron. i, 12). In both passages it would appear, as the text now stands, that the Philistines came forth from the Casluhim, and not from the Caphtorim, as is elsewhere expressly stated: here, therefore, there may be a transposition. See **CAPHTOR**. The only clew we have as yet to the position of the Casluhim is their place in the list of the sons of Mizraim between the Pathrusim and the Caphtorim, whence it is probable that they were seated in Upper Egypt. See **PATRHOS**. The Sept. seems to identify them with the *Chashtannim*, קַשְׁתָּנִים, of Psa. lxxviii, 81 (A. V. "princes"), which some (Michaelis, *Suppl.* p. 978), though not the Sept. in that place, take to be a proper name, and compare with the native civil name of Hermopolis Magna. This would place the Casluhim in the Heptanomis. See **HASHMANNIM**. Bochart (*Phaleg*, iv, 81) suggests the identity of the Casluhim with the *Colchians* (comp. Michaelis, *Spicileg.* i, 275 sq.), who are said to have been an Egyptian colony (Herod. ii, 104; Diod. Sic. i, 28; Dionys. Perieg. p. 689; Ammian. Marc. xxii, 22; comp. Agath. *Hist.* ii, 18); but this story and the similarity of name do not seem sufficient to render the supposition a probable one, although Gesenius (see Hitzig, *Philist.* p. 86 sq.) gives it his support (*Theol.* p. 702; comp. Ritter, *Vorhalle*, p. 85 sq.; Brehmer, *Entdeck.* i, 354 sq.). Forster (*Ep. ad Michael.* p. 16 sq.) conjectures the Casluhim to be the inhabitants of *Cassiotis*, the tract in which is the slight elevation called Mount Casius (Pliny, v, 12 and 14; Strabo, xvii, 759; Steph. Byz. p. 455). Bunsen assumes this to be proved (*Bibelwerk*, p. 26). There is, however, a serious difficulty in the way of this supposition—the nature of the ground, a low littoral tract of rock, covered with shifting and even quick sand. But Ptolemy (*Geogr.* iv, 5, 12; comp. Joseph. *War.* iv, 5, 11) gives us the names of several towns lying in this district, so that it must have been capable of supporting a population, and may, in an earlier period, have been quite adequate to the support of a tribe. The position of the Casluhim in the list beside the Pathrusim and the Caphtorim renders it probable that the original seat of the tribe was somewhere in Lower Egypt, and not far from the vicinity of that "Serbonian Bog betwixt Damiatra and Mount Casius old" (*Par. Lost*, ii, 592). Hiller (*Syntax. Herm.* p. 178 sq.) refers the name to the *Solyms* of the Greeks (Strabo, i, 84; xiv, 667), in the neighborhood of the Lycians (comp. Schulthess, *Parad.* p. 166 sq.). The supposition of Hitzig (*Philist.* p. 90 sq.) that the Casluhim were a Cretan colony in Libya, whence again a colony was sent to Phillistia, is merely based upon a vague allusion in Tacitus (*Hist.* v, 2). See **ΕΤΗΝΟΙΟΥ**.

Cas'phon (Χασφών v. r. *Χασφώρ* and *Χασφάδ*, 1 Macc. v, 86) or **Cas'phor** (*Χασφώρ* v. r. *Χασφών* and *Χασφώδ*, 1 Macc. v, 26), one of the fortified cities in the "land of Galaad," i. e. Gilead (1 Macc. v, 26), in which the Jews took refuge from the Ammonites under Timotheus (comp. ver. 6), and which, with other cities, was taken by Judas Maccabæus (v, 86). Josephus, in the parallel account (*Ant.* xii, 8, 8), calls it *Chasphōma* (Χασφωμα). Grotius and Calmet (in loc.) consider it the same (but on very slight grounds) with **ΗΞΗΒΟΝ** (q. v.). It was situated near Bostra, Ash-taroth-Karnaim, and Edrei, and was perhaps one of

the ruined sites in the Hauran still found by travellers. See **HAURAN**. Soetzen's commentators (notes on pt. 7, March, 1806, iv, 198) suggest the modern *as-Sabān* as the possible site of Casphon, but add, "Site, however, uncertain." See also **CASPIA**.

Cas'pis (Κάσπις), a strongly-fortified city—whether east or west of Jordan is not plain—having near it a lake (λίμνη) two stadia in breadth. It was taken by Judas Maccabæus with great slaughter (2 Macc. xii, 18, 16). The parallel history of the 1st Book of Maccabees mentions a city named **CASPION** or **CASPION** (q. v.), with which Caspis may be identical, but the narratives differ materially (see Ewald, *Isr. Gesch.* iv, 359, note). Reland (*Palæst.* p. 184) compares a city (*Chaspiā* (Πῆσπι) on the borders of Palestine (Jerus. Talm. *Demai*, xxii, 4).

Cassander, GEORGE, one of the most amiable and enlightened divines of the Roman Church, was born about 1515, in the island of Cadsand, at the mouth of the Scheldt. He was for a time professor of theology, first at Bruges, then at Ghent; after which he went to Cologne, where he devoted himself to the study of the controversy between the Roman Catholics and Reformers, hoping to allay the dissensions of the time. The duke of Cleves called him to Duisburg, to bring back the Anabaptists, if possible, to the Church; and this led to his preparing his book on infant baptism. His first publication was *De officio pii veri in hoc dissidio religionis* (Basle, 1561, 8vo). He shared the common fate of those who endeavor to unite parties warmly opposed to each other, and his book was disliked by both Protestants and Romanists. The emperor Ferdinand induced him to write his *Consultatio de articulis fidei inter populos et protestantes controversis* (1564), in which he endeavored to reconcile the various articles of the Confession of Augsburg with the faith of the Roman Church. He was willing to grant the cup to the laity, and, in extreme cases, the marriage of priests. Cassander died Feb. 8, 1566. His works were collected by Decordes, *Opera qua reperiri poterunt omnia* (Paris, 1616, fol.). This collection contains, among other things, a commentary on the two natures of Jesus Christ; various treatises against the Anabaptists, with testimonies from the fathers, and the doctrine of the early Church on the subject of the baptism of infants; *Liturgica*; ecclesiastical hymns, with notes; one hundred and seven letters, etc. Some of these treatises were condemned by the Council of Trent.—Landon, *Ecol. Dictionary*, s. v.; Hofer, *Novæ Biog. Générale*, ix, 27; Gieseler, *Church History*, vol. iv, § 80, 61; Hook, *Eccles. Biography*, iii, 502 sq.

Cassel, Conference of, a meeting held at Cassel in 1661 between the Reformed theologians of Marburg and the Lutheran theologians of Rinteln. Peter Musäus and Johann Hennichen, both zealous disciples of Calixtus (q. v.), represented the Lutherans, and Sebastian Curtis and Johannes Hein the Reformed. The object of the Conference was, according to the officially-published *Brevis relatio colloquii*, etc., to endeavor, by friendly discussion, to remove the obstacles to union. The principal subjects of discussion were the Eucharist, Predestination, Baptism, and the person of Christ, and both parties agreed that in these fundamental points their doctrines were essentially similar. The landgrave was petitioned to call on the neighboring churches, and the Universities of Brandenburg and Brunswick, to adopt the resolutions of the Conference, and also to invite a general congress of the theologians of all countries. The landgrave's death (in 1668) destroyed all these projects of union. See Rommel, *Gesch. von Hessen*, ix, p. 46; Mosheim, *Church History*, iii, 859; Herzog, *Real-Encyclopädie*, ii, 600.

Cassell, LEONARD, a minister of the Methodist Episcopal Church, was born in Maryland in 1784, entered the itinerant ministry in 1802, and died of yellow

fever in September, 1808. He was of German parentage, and his mind remained in "uncultured darkness until his conversion. From that day it was manifest how great a mind had thus been called forth. The improvement he made astonished his friends." His genius, eloquence, and piety soon placed him in the most important positions as a preacher, and his early death was a great loss to the Church.—*Minutes of Conference*, ii, 168.

Cassia is the rendering in the Auth. Vers. of two Heb. words.

1. KIDDAH', קִדְדָה, mentioned in Exod. xxx, 24 (Sept. *ἰρις*) among the ingredients of the holy oil of anointing, and in Ezek. xxvii, 19 (Sept. *σκαπριον*) as one of the articles of merchandise in the markets of Tyre. The Sept. (in one passage) and Josephus (*Ant.* iii, 8, 8) have *iris*, i. e. some species of *flag*, perhaps the *Iris florentina*, which has an aromatic root-stock. Symmachus and the Vulg. (in one place) read *stacte*, "liquid myrrh." The Arabic versions of Saadias and Erpenius conjecture *costus* (see below). The Chaldees and Syriac, with most of the European versions, followed by Gesenius, Simon, Fürst, Lee, and all the lexicographers, understand the Arabian *cassia*, or cassia-bark, a species of aromatic cortical resembling cinnamon, but less fragrant and valuable; so called from its rolls being *split* (from קָדַד, to cleave). See Dioscor. i, 12; Theophr. *Hist. Plant.* ix, 5; Celsius, *Hierob.* ii, 186, 350 sq.

2. KETSIAH', קֶטְיָה, named only in the plural in Psa. xlv, 8 (Sept. *kaiaia*, Vulg. *casia*), in connection with myrrh and aloes, as being used to scent garments with. The word comes from the root קָצַף, to abrade, and appears to refer to the peeled bark of some species of cinnamon, perhaps differing in this from the preceding only as designating some oil or prepared aromatic, of which that denotes the raw material (see Celsii *Hierob.* ii, 860). See AROMATICS.

Under the name *cassia* (which appears to be identical with this last Heb. term) the ancients designated an aromatic bark derived from the East, and employed as an ingredient in costly unguents (Theophr. *Plant.* ix, 7; Pliny, xii, 48; Dioscor. i, 12; Diod. Sic. iii, 46; Athen. x, 449; *Plant. Curcul.* i, 2, 7; Virg. *Geo.* ii, 466; Martial, xi, 55, 1; x, 97, 2; Pers. *Sat.* ii, 64; i, 86). It was obtained from a tree or shrub growing in India and Austria (Herod. iii, 110; Diod. Sic. i. c.; Aga-

tharch. in Hudson, i, 61; Arrian, *Alex.* vii, 20; but see Pliny, xii, 41), which Pliny (xiii, 48) more closely, but still not adequately describes, and which Columella (iii, 8) saw in Roman fancy gardens. It is clear that the Latin writers by the term *casia* understood both the Oriental product now under consideration, as well as some low, sweet herbaceous plant, perhaps the *Daphne genkium*, Linn. (see Fee, *Flore de Virgile*, p. 82, and Du Molin, *Flor. Poet. Antienne*, p. 277); but the Greek word, which is first used by Herodotus (ii, 86), who says (iii, 110) the Arabians procured it from a shallow lake in their country, is limited to the Eastern product. Dioscorides (l. c.) and Galen enumerate three better sorts of cassia, and there are still in Europe held to be different kinds, but they all are distinguished from the true cinnamon-tree by their darker color, weaker odor, and less lively taste. The tree from which the bark is produced is regarded by naturalists as the *Laurus cassia* (Linn.), that flourishes in the East Indies and Malatia (Ainslie, *Mater. Med.* i, 58 sq.); yet the brothers Nees von Esenbeck (*De cinnamomo disputat.* Bonn, 1823, in the *Botan. Zeitung*, 1831, No. 84) have shown that this plant (the *Laurus cassia*) is not a distinct species, but only a wild or original form of the *cinnamomum Ceylonicum* or *Zeylanicum*. See the *Penny Cyclopaedia*, s. v. Cassia; Laurus.

The name Cassia has been applied by botanists to a genus containing the plants yielding senna, and to others, as the *Cassia fistula*, which have nothing to do with the original cassia. "Cassia-buds," again, though no doubt produced by a plant belonging to the same, or to some genus allied to that producing cinnamon and cassia, were probably not known in commerce at so early a period as the two latter substances. Dr. Royle, in his *Antiquity of Hindoo Medicine*, p. 84, has remarked, "The cassia of the ancients it is not easy to determine; that of commerce, Mr. Marshall says, consists of only the inferior kinds of cinnamon. Some consider cassia to be distinguished from cinnamon by the outer cellular covering of the bark being scraped off the latter, but allowed to remain on the former. This is, however, the characteristic of the (Cochin-Chinese) *Cinnamomum aromaticum*, as we are informed by Mr. Crawford (*Embassy to Siam*, p. 470) that it is not cured, like that of Ceylon, by freeing it from the epidermis." There is no doubt that some cassia is produced on the coast of Malabar. The name also would appear to be of Eastern origin, as *kasse koronde* is one kind of cinnamon, mentioned by Burmann in his *Flora Zeylonica*.

The Heb. word *ketsiah*, however, has a strong resemblance to the *kooth* and *koost* of the Arabs, of which *Koostia* is said by their authors to be the Syriac name, and from which there is little doubt that the *kóroç* of the Greeks and *costus* of the Latins are derived. *Kóroç* is enumerated by Theophrastus (*Hist. Pl.* ix, 7) among the fragrant substances employed in making ointment. Three kinds of it are described by Dioscorides among his *Aromata* (i, 15), of which the Arabian is said to be the best, the Indian to hold the second place, and the Syrian the third. An inferior kind is termed by him *κέρω* (i, 12), a word which has a strong resemblance to the Heb. *kiddah* above. Pliny mentions only two kinds (xv, 12), the white and the black, brought from India. The Persian writers on *Materia Medica* in use in India, in giving the above synonymes, evidently refer to two of the three kinds of *Costus* described by Dioscorides, one being called *Koost Hindee*, and the other *Koost Arabee*. Both these kinds are found in the bazaars of India, and the *koot* or *koost* of the natives is often, by European merchants, called Indian orris, i. e. Iris root, the odor of which it somewhat resembles. The same article is known in Calcutta as *Puchuk*, the name under which it is exported to China. The identity of the substance indicated by these various names was long ago ascertained by Garcias. The *koost* obtained in the northwestern provinces of India



Laurus Kinnamomum.

is one of the substances brought across the Indus from Lahore (Royle, *Illust. Himal. Bot.* p. 360). Dr. Falconer, on his journey to Cashmere, discovered that it was exported from that valley in large quantities into the Punjab, whence it finds its way to Bombay (as in the time of Pliny to Patala) and Calcutta for export to



Cinnamomum Cassia, with enlarged view of the Bud.

China, where it is highly valued as one of the ingredients in the incense which the Chinese burn in their temples and private houses. He named the species *Aucklandia Costus* (*Linn. Trans.* xix, 28) (see Smith's *Dict. of Class. Ant. Am.* ed., s. v. Cassia; Costum). See CINNAMOM.

CASSIAN, JULIUS (Κασσιανός), a leader of the Docetes in the second century: Cave gives the date A.D. 174; Tillemont about A.D. 200. He is mentioned by Hippolytus and Irenæus, but what is known of him is chiefly derived from Clemens Alexandrinus, who calls him the founder of the sect of the Docetes, and refers to one of his works, entitled *Concerning Continence*, from which it appears that he adopted the notions of Tatian respecting the impurity of marriage. He quoted passages from apocryphal Scriptures, and perverted passages from the genuine Scriptures in order to support his opinions. Clement says that "he had recourse to the fiction—that Christ was only a man in appearance—through unwillingness to believe that he had been born of the Virgin, or partaken in any way of generation." Clement accuses him of borrowing from Plato his notions respecting the evil nature of generation, as well as the notion that the soul was originally divine, but, being rendered effeminate by desire, came down from above to this world of generation and destruction. Eusebius (vi, 18) speaks of Cassian as author of "a history of the times in chronological order" (Clement, *Stromat.* iii, 13, § 91).—Lardner, *Works*, viii, 611-614; Neander, *Church Hist.* i, 458; Cave, *Hist. Litt. Cent.* ii; Matter, *Hist. du Gnosticisme*, ch. i, § 8.

CASSIANUS, JOHANNES (also called JOANNES MASILIENSIS, JOANNES EREMITA), according to Gennadius (*De Vir. Illust.* c. 61), a Scythian; but the more likely view makes him a native of Marseilles. He was brought up at the celebrated monastery of Bethlehem (q. v.), under Germanus, with whom, about A.D. 390, he went to visit the hermits of Egypt, among whom he lived several years. In 403 he went to Constantinople, where he listened to Chrysostom, who ordained him deacon. About 415 he founded a monastery at Marseilles for monks and another for nuns; the first is

the celebrated abbey of St. Victor. He may thus be considered as the founder of monachism in the West; and his treatise *De Institutis Coenobiorum*, libri xii, afforded a code by which the monasteries were long after ruled (transl. into French by Saligny, Paris, 1667, 8vo). Cassianus, according to different writers, died (aged 97) in 440, or 448, or 435. The Chronicle of Prosper represents him as alive in 433. Some churches honor him as a saint on the 23d of July, though he was never canonized. He was a strong opponent of Augustine's doctrine of predestination, but at the same time, by recognising the universal corruption of human nature, he opposed Pelagius just as strongly. (See his *Collationes Patrum*.) He admitted the necessity of preventing and assisting grace, but held that, in most men, faith and good will, and the desire of conversion, wrought by natural strength alone, precede such grace, and prepare the mind to receive it; and that such first efforts of the natural man cannot indeed deserve the gift of grace, but assist to the obtaining of it. "His attention was turned to experience; he observed religious natures; a system of mere logical speculation had no charms for him. His doctrines, which are scattered through his writings, were designed to represent in its simplicity the faith of the Galilean fishermen, which had been garbled by Ciceronian eloquence. Free will and grace agreed, and hence there was an opposing oneness, which maintained either grace alone, or free will alone. Augustine and Pelagius were each wrong in their own way. The idea of the divine justice in the determination of man's lot after the first transgression did not preponderate in Cassian's writings as in Augustine's, but the idea of a disciplinary divine love, by the leadings of which men are to be led to repentance. He appeals also to the mysteriousness of God's ways, but not as concerns predestination, but the variety of the leadings by which God leads different individuals to salvation. Nor is one law applicable to all; in some cases grace anticipates (*gratia præveniens*), in others a conflict precedes, and then divine help comes to them as grace. In no instance can divine grace operate independently of the free self-determination of man. As the husbandman must do his part, but all this avails nothing without the divine blessing, so man must do his part, yet this profits nothing without divine grace" (Neander, *Hist. Dogmas*, ii, 377). Among his writings are *Collationes Patrum*, xxiv, in which Cassian introduces Germanus and other monks as interlocutors, with himself, in dialogues on various monastic and moral duties. In the 18th Conference, Cassian, under the person of Cherrimon, sets forth what has been called his *semi-Pelagianism*, viz. his views of predestination and grace. The 17th Conference defends occasional *falsehood*, as being not contrary to Scripture: "A lie is to be so esteemed and so used as if it possessed the nature of hellebore, which, if taken in an extreme case of disease, may be healthful, but if taken rashly, is the cause of instant death; people the most holy and most approved of God have used falsehood without blame," etc. The 20th shows several ways of obtaining remission of sins besides through the death and intercession of Christ. He wrote also a treatise, *De Incarnatione Christi*, lib. vii, in confutation of Nestorius, about A.D. 430, at the request of Leo, afterwards bishop of Rome. Cassian maintains the propriety of the term "Mother of God." The *Collationes* were translated into French by Saligny (Paris, 1668, 8vo). His works were published at Basle in 1575; at Antwerp in 1578; at Rome (*cura Petri Giacconi*), 1580 and 1611, 8vo; at Douai (1616, two vols. 8vo), by Alardus Gazæus; reprinted at Leipsic 1722, fol. (the best edition). They are also in the *Biblioth. Patrum*, vol. vii.—Neander, *Church Hist.* ii, 627-630; Hoefler, *Nov. Biographie Générale*, ix, 35; Dupin, *Ecc. Writers*, 5th century; Meier, *Jean Cassian* (Strasb. 1840); Wiggers, *de Johanne Cassiano*, etc. (Rostock, 1824, 1825); Wiggers, *Augustinismus et Pelagianismus*, ii, 19, 47, etc.;

also his article Cassianus, in *Ersch u. Gruber's Encyclopædie*; Hagenbach, *History of Doctrines*, § 114; Lardner, *Works*, v, 27; Clarke, *Sacred Literature*, ii, 188.

Cassiodorus, or *Cassiodorus*, MAGNUS AURELIUS, *Senator*, was born at Scyllacium (Squillace), in Brutium (Lucania), of a noble Roman family, about 468, and gained a high reputation for wisdom and eloquence at a comparatively early age. Theodoric loaded him with honors and employments near his own person, and about 500 made him prefect of the Prætorium, and raised him to the patrician rank. In 514 he was sole consul. He retained his influence at court under Athalaric, but in 537 he retired into the country, and founded the monastery of Viviers (*Vivariense*), in Calabria. He was still living in 562, and is believed to have lived beyond a hundred years. In his retreat he devoted himself to literature, even to copying manuscripts, and it is an undoubted fact that we owe to him the preservation of many precious manuscripts. Some, indeed, say that he first of all set the monks to this labor of copying. Besides some grammatical works, he wrote *Historia Ecclesiast. Tripartita* (Frank. 1688); *Computus Paschalis*, etc.; *De Institutione Divinarum Litterarum*; *Expositio in Psalmos*; *Complexiones in Epist. Apostol.* (Rott. 1723, 8vo). His works were collected and published in 1491 and 1588; the most exact is the edition of Dom Garet (Rouen, 1679, 2 vols. fol., and Ven. 1729). They are also in Migne, *Patrologia*. Maffei published at Verona (1702) a commentary of Cassiodorus on the Acts and Epistles, which he discovered in the library of that city. His life was written by the Benedictine St. Marthe (*La vie de Cassiodore*, Paris, 1694).—Landon, *Eccles. Dictionary*, s. v.; Gieseler, *Church History*, i, § 112; Herzog, *Real-Encyclopædie*, ii, 608; Cave, *Hist. Lit.* (1720), p. 825.

Cassius (fully CAIUS CASSIUS LONGINUS), one of the murderers of Julius Cæsar, first appears in history as the questor of Crassus in the unfortunate campaign against the Parthians, B.C. 53, when he greatly distinguished himself by his military skill. After various public services he conspired with Brutus against Cæsar, B.C. 44, and in the anarchy that followed he usurped the presidency of Syria, in which capacity his violent conduct toward the Jews is related by Josephus (*Ant.* xiv, 11 and 12). The forces of the conspirators were defeated by Antony at Philippi, and Cassius commanded his freedmen to put an end to his life, B.C. 42.—Smith, *Dict. of Class. Biog.*, s. v. Longinus.

Josephus also mentions another (Caius) Cassius Longinus as appointed governor of Syria, A.D. 50, by Claudius, in the place of Marcus (*Ant.* xx, i, 1; comp. xv, 11, 4). He was banished by Nero, A.D. 66, who dreaded his popularity at Rome (Smith, *ut sup.*).

Cassock, the coat formerly worn by all orders of the clergy in the Roman and English churches; in the Church of Rome it varies in color with the dignity of the wearer. Priests wear black; bishops, purple; cardinals, scarlet; and popes, white. In the Church of England, black is worn by all the three orders of the clergy, and the garment is of cloth or silk, with plain sleeves like a coat, made to fit close to the body, and tied round the middle with a girdle. It is worn under the gown or surplice. The cassock was not originally appropriated to the clergy; the word is used in Shakspeare for a military coat.

Cast (the representative of many Heb. words, and usually of the Greek βάλλω) occurs in many applications as a synonyme of *throw*. The following seem to deserve special notice.

1. Amaziah, king of Judah, caused the punishment of "casting down from the top of a rock" to be inflicted on ten thousand Edomites whom he had taken in war (2 Chron. xxv, 12); and the Greeks and Romans were in the habit of condemning certain criminals to be cast down from the top of a rock, especially the latter na-

tion, whence the famous "Tarpeian Rock" at Rome. See PUNISHMENT.

2. The phrase to "cast up a bank" is one frequently employed in Scripture for the preliminary act in besiegers of raising a rampart of blockade around a hostile city. See SIEGE.

3. For the practice of "casting metal," see METALLURGY.

4. On the act of "casting out of the synagogue," see EXCOMMUNICATION.

5. "Castaway" (ἀδόκιμος, not accepted, reprobate) occurs 1 Cor. ix, 27, as a term equivalent to apostate. See APOSTASY.

Castalion, **Castalio**, or **Castellio**, SEBASTIAN, a Protestant writer of extraordinary talent, was born of poor parents in Dauphine in 1515. His family name was Châteillon, which he Latinized into Castalion. He applied himself early to the ancient languages, and became a great proficient in Greek and Hebrew. In 1540-1 Calvin invited him to Geneva, and had him appointed to a professor's chair. In a few years Castalio, having become obnoxious to Calvin on account of his opinions on predestination, left Geneva for Basle, where he employed himself in teaching and writing. He wrote *Paedterium reliquaque sacrarum Litterarum Carmina et Precesiones* (1547, with notes);—*Jonas Propheta, heroico carmine Latino descriptus*;—*Dialogorum Sacrorum ad linguam et mores puerorum formandos, libri sex* (translated into English by Bellamy under the title *Youth's Scripture Remembrancer, or Select Sacred Stories by way of familiar Dialogues*, Lat. and Eng., London, 1748). He also published a version in Latin verse of the Sibylline Books, with notes, and a Latin translation of the *Dialogues* of Bernardino Ochino. Before he left Geneva he had undertaken a complete Latin version of the Bible from the Hebrew and Greek, which he completed at Basle (*Biblia Vet. et Nov. Test. ex versione Seb. Castalionis*, Basil. 1551), and dedicated to Edward VI of England. He published a French version of the same in 1555. Castalio's versions were made the subject of much conflicting criticism. His Latin Bible went through several editions; that of Leipzig, 1697, contains also his *Delineatio Respublice Judaicæ ex Josepho*; *Defensio versionis Novi Fœderis contra Th. Bezaum, and Nota prolixior in cap. ix. Epistolæ ad Romanos*. He carried on an epistolary controversy with Calvin and Beza, who assailed him with many charges, and even urged the magistrates of Basle to drive him away. He passed his latter years at Basle in great poverty, and died Dec. 28, 1563, leaving his family in want. "In 1562 Castalio published *Defensio suarum Translationum Bibliorum et maxime Novi Fœderis*. His *Dialogi IV de Prædestinatione, Electione, Libero Arbitrio, ac Fide*, were published in 1578 by Faustus Socinus. The book attacks Calvin's doctrines with great violence, as making God a tyrant, as tending to encourage vice, and to discourage all exertion toward virtue. Castalio has been abused both by Calvinists and Roman Catholics; Arminian critics have been more indulgent to him. He wrote a treatise to prove that magistrates have no right to punish heretics" (*English Cyclopædia*). He was more a philologist than a theologian; he treated the Bible rather as a critic than as an interpreter.—Horne, *Bibliog. Ap-pendix*, pt. i, ch. i, § 4; Hag, *La France Protestante*, iii, 861; Hagenbach, *Hist. of Doctrines*, § 250; Bayle, *Dictionary*, s. v.; Wesley, *Works*, vii, 871.

Castè. See HINDOOISM.

Castell, EDMUND, a learned English divine, was born at Hatley, Cambridgeshire, 1606, and was educated at Emmanuel and St. John's colleges, Cambridge. While at the University he compiled his *Lexicon Hæpologation*, Dictionary of Seven Languages (London, 1669, 2 vols. fol.), after seventeen years' labor on it. The publication cost him £12,000, and ruined him. He had, however, previously been appointed king's chap-

lain (1666) and Arabic professor at Cambridge, to which were afterwards added a prebend of Canterbury and the livings of Hatfield Peverell and Wodeham Walter. He died in 1685 rector of Higham Gobion, Bedfordshire. His *Lexicon* is one of the greatest monuments of industry known in literature. He was aided in its preparation by Dr. Murray, bishop Beveridge, and Dr. Lightfoot. Besides his vast labors on the *Lexicon*, he was eminently useful to Walton in the preparation of his *Polyglot Bible*. Walton acknowledges his services, but not adequately.—*New General Biograph. Dictionary*, iii, 194; *Bibl. Repository*, x, 11; Todd, *Life of Walton*, vol. i, ch. v; Horne, *Introduction*, v, 252 (9th ed.).

Castellio. See CASTALION.

Castellum (or **Castra**) **Peregrinorum** (*Forcigners' Station*) or **PETRA INCISA** (*Cut Rock*), a fortified seaport of the Crusaders in Palestine, between Mt. Carmel and Cæsarea (Ritter, *Erdk.* xvi, 615; Raumer, *Paläst.* p. 188); now **ATHLIT**, a most formidable-looking ruin (Van de Velde, *Narrative*, i, 812-814; Wilson, *Lands of Bible*, ii, 248). See **AHLAB**. Under the form **Castra** (קסטריה) it seems to be mentioned by the Rabbins (Reland, *Palæst.* p. 697; Schwarz, *Palæst.* p. 162).

Castle is the rendering in the A. V. of the following words in certain passages: אֲרָמוֹן, *armon'*, a *fortress* (Prov. xviii, 19; elsewhere uniformly "palace"); טִירָה, *tirah'*, a *wall* ("row," Ezek. xlvi, 28), hence an *enclosure*, e. g. a *fortress* ("palace," Cant. viii, 9), or a nomade *hamlet* of palisades (Gen. xxv, 16; Num. xxi, 10; 1 Chron. vi, 54; "palace," Ezek. xxv, 4; poetically "habitation," Psa. lxxix, 25); בֵּירָה, *birah'*, [from the synonymous טִירָה, *tirah'*, "palace," see **BARIS**], a *citadel* (2 Chron. xvii, 12; xxvii, 4); מִגְדָּל, *migdal'* (1 Chron. xxvii, 25), a *tower* (as elsewhere rendered); מִצָּד, *metzad'* (1 Chron. xi, 7), or מְצֻדָה, *metzudah'* (1 Chron. xi, 5), a *fort* or *stronghold* (as elsewhere usually rendered); ἀκρόπολις, *acropolis* (2 Macc. iv, 27; v, 5); πύργος, a *tower* along a wall (2 Macc. x, 18, 20, 22); παρεμβολή, a *military enclosure* (Acts xxi, 34, 37; xxii, 24; xxiii, 10, 16, 32) or *station* ("camp," Heb. xi, 84; xiii, 11, 18; Rev. xx, 9). See **TOWER**; **PALACE**, etc.

Castles among the Hebrews were a kind of military fortress, frequently built on an eminence (1 Chron. xi, 7). The priests' castles, mentioned in 1 Chron. vi, 54, may also have been a kind of tower, for the purpose of making known anything discovered at a distance, and for blowing the trumpets, in like manner as the Mohammedan imams ascend the *minarets* of the mosques at the present day to call the people to prayers. The castles of the sons of Ishmael, mentioned in Gen. xxv, 16, were watch-towers, used by the nomade shepherds for security against marauders. The "castle" in Acts xxi, 34, refers to the quarters of the Roman soldiers at Jerusalem in the fortress Antonia (q. v.), which was adjacent to the Temple and commanded it. See **FORTIFICATION**.

Castor AND **POLLUX**, the *Dioscūri* (Δίωσκουροι, Acts xxviii, 11), two heroes of Greek and Roman mythology, the twin-sons of Jupiter and Leda (see Smith's *Dict. of Classical Biog.*, s. v. Dioscuri). They were regarded as the tutelary divinities (Θεοὶ σωτηριεῖς) of sailors (Xenoph. *Sympos.* viii, 29). They appeared in heaven as the constellation of *Gemini*. On ship-board they were recognised in the phosphoric lights called by modern Italian sailors the *fires of St. Elmo*, which play about the masts and the sails (Seneca, *Nat. Quæst.* i, 1; comp. Pliny, xi, 87). Hence the frequent allusions of Roman poets to these divinities in connection with navigation (see especially Horace, *Carm.* i, 8, 2, and iv, 8, 81). As the ship mentioned by Luke was from Alexandria, it may be worth while to no-

tice that Castor and Pollux were specially honored in the neighboring district of Cyrenaica (*Schol. Pind. Pyth.* v, 6). In Catull. iv, 27, we have distinct mention of a boat dedicated to them (see also lxviii, 65). In art, these divinities were sometimes represented simply as stars hovering over a ship, but more frequently as young men on horseback, with conical caps, and stars above them (see the coins of Rhegium, a city



Silver Brutian Coin, with the Heads of Castor and Pollux; also their Figures mounted.

of the Brutii, at which Paul touched on the voyage in question, verse 18). Such figures were probably painted or sculptured at the bow of the ship (hence *παράσημον*; see Smith, *Dict. of Class. Antiq.*, s. v. *Insigne*). This custom was very frequent in ancient ship-building. See **SHIP**. Herodotus says (iii, 87) that the Phœnicians used to place the figures of deities at the bow of their vessels. Virgil (*Æneid.* x, 209) and Ovid (*Trist.* i, 10, 2) supply us with illustrations of the practice; and Cyril of Alexandria (Cramer's *Catena*, ad l. c.) says that such was always the Alexandrian method of ornamenting each side of the prow.—Smith, s. v. See **DIOSCURI**.

Casuistry is that branch of Christian morals which treats of *casus conscientia* (cases of conscience); that is to say, of questions of conduct in which apparently conflicting duties seem at first to perplex and disturb the moral faculty, and make it necessary to trace, with a careful exclusion of everything but moral considerations, the consequences of the rules of morality (Whewell, *History of Moral Philosophy*, xxiv). Kant calls casuistry "the dialectics of conscience." In this sense the word might have a good meaning; but its ordinary use is to designate sophistical perversion or evasion of the moral law. Pope supplies examples of both shades of signification, as, first, in the good sense:

"Who shall decide when doctors disagree,
And soundest casuists doubt, like you and me?"

Again, in the unfavorable sense:

"Morality by her false guardians drawn,
Chicane in furs, and casuistry in lawn."

But the theory of "collision of duties," on which this so-called science of casuistry rests, is unsound. Duty is one, though there may be various ways of performing it, and with regard to these, instruction and guidance of course may be needed. What appears to be collision of duties is generally only a collision between duty and inclination. In true Christian ethics, principles of life are set forth, not rules for individual cases. There is nothing like casuistry in the moral teaching of Christ and his apostles. If the "eye be single, the whole body will be full of light;" and if the ultimate aim of man be to do the will of God, this aim, by the aid of the divine Spirit, will clear up all special perplexities as they arise. "When truth must be dealt out in drams or scruples, the health of the soul must be in a very feeble and crazy condition." Bishop Heber tells us that when Owen was dean of Christ Church, a regular office for the satisfaction of doubtful consciences was held in Oxford, to which the students at last gave the name of "Scruple shop" (Heber's *Works of Jeremy Taylor*, i, 270). "The cure for diseased consciences is not to be found in a 'scruple shop,' but in the love and care of the great Physician. The law of love, under the guidance of the Holy Spirit, is a solvent of all subordinate moral questions in the practice of life. For the application of this law our

reason must be constantly and carefully used" (Wesley, *Works*, ii, 129).

2. *Casistry in the Church of Rome.*—As the Roman doctrines of penance and absolution grew up in the Middle Age, *casistry* grew up also, in the form of decisions on special cases of moral difficulty. "The schoolmen delighted in this species of intellectual labor. They transferred their zeal for the most fanciful and frivolous distinctions in what respected the doctrines of religion to its precepts; they anatomized the different virtues; nicely examined all the circumstances by which our estimate of them should be influenced; and they thus rendered the study of morality inextricable, confounded the natural notions of right and wrong, and so accustomed themselves and others to weigh their actions, that they could easily find some excuse for what was most culpable, while they continued under the impression that they were not deviating from what, as moral beings, was incumbent upon them" (Watson, *Theol. Dictionary*, s. v.). The works which contained collections of cases of conscience, and of which the title commonly was *Summa Casuum Conscientiæ*, or something resembling this, were compiled at first for the use of Roman confessors. It was requisite for them to know, for instance, in what cases penance of a heavier or lighter kind was to be imposed; and what offences must, for the time, exclude the offender from the communion. The first systematic work on casistry was that of *Raymond of Pennafort*, who published a *Summa de Casibus Pœnitentiæ*, which came into very general use in the 13th century, largely followed by succeeding casuists. In the 14th and 15th centuries the number of such books increased very greatly. "These *Summa* were in common speech known by certain abbreviated names, borrowed from the name of the author or his birthplace. Thus there was the *Astessano*, which derived its name from its author, Astessanus, a Minorite of Asti, in Piedmont (Nuremberg, 1482); the *Angelica*, compiled by Angelus de Clavasio, a Genoese Minorite (Nuremberg, 1492); the *Pisano* or *Pisanella*, which was also termed *Bartholina* or *Magistrucchia* (Par. 1470); the *Pacificæ* (Venice, 1574), the *Rosella*, the *Sylvestrina*." In these works the subjects were usually arranged alphabetically, and the decisions were given in the form of responses to questions proposed, the opinions being often quoted from or supported by the authority of the Scriptures, or the fathers, or schoolmen. There was no attempt to lay down general principles which might enable the inquirer to determine for himself the matter by which his conscience was disturbed. The lay disciple was supposed to be in entire dependence upon his spiritual teachers for the guidance of his conscience, or, rather, for the determination of the penance and mortification by which his sins were to be obliterated. Moreover, a very large proportion of the offences which were pointed out in such works were transgressions of the observances required by the Church of those days, and referred to matters of which conscience could not take cognizance without a very considerable amount of artificial training. Questions of rites and ceremonies were put upon an equal footing with the gravest questions of morals. The Church had given her decision respecting both; and the neglect or violation of her precepts, and of the interpretations of her doctors, could never, it was held, be other than sinful. Thus this body of casistry was intimately connected with the authority and practices of the Church of Rome, and fell into disuse along with them (Whewell, l. c.).

After the Reformation, the vices of the casuistical system developed themselves in the Church of Rome more fully than ever before. The so-called *Moral Theology* really poisoned the very fountains of morality. See *JESUITA*; *PASCAL*. The abbé Maynard published in 1851 a defence of the Jesuits and of their casistry, under the title *Les Provinciales et leur refutation* (2 vols. 8vo), which is ably reviewed in the *Christian Remem-*

brancer (July, 1852), from which we take the following passage: "The first source of the Jesuical casistry is to be sought in the inherited habits of thought which had been formed in the Middle-age schools. Conditions, restrictions, distinctions multiplied, of course; but so did the authorities and decisions, inventing doubts, extending liberty, and taking away scruples. Its next cause was the practical need of casistry (under the Romish system)—the endeavor to fix what cannot be fixed—the limits, in every possible case, of mortal sin. Doubtless moral questions are very important and often very hard. But there are endless questions on which no answer can be given except a bad one—which cannot be answered in the shape proposed at all. We may think it very desirable to be able to state in the abstract, yet for practical use, the extreme cases, which excuse killing, or taking what is not our own; but if we cannot get beyond decisions which leave the door open for unquestionable murders or thefts, or shut it only by vague verbal restrictions, unexplained and inexplicable, about 'prudence,' and 'moderation,' and 'necessity,' and 'gravity of circumstances,' it is a practical illustration of the difficulty of casistry, which seems to point out that, unless we can do better, we had best leave it alone. But these men were hard to daunt. They could not trust the consciences of mankind with principles of duty, but they could trust without a misgiving their own dialectic forms, as a calculus which nothing could resist. The consequence was twofold. Their method often *did* fail, and in the attempt to give exact formulæ of right and wrong action, they proved unable to express the right without comprehending the wrong with it. From all evil designs the leaders, at any rate, may be safely absolved; though whether they did not lose their sense of the reality of human action in the formal terms in which they contemplated it, may be a question. But, though the *design* of corrupting morality is one of the most improbable charges against any men, the *effect* may more easily follow, even where not intended. These casuists would not trust the individual conscience, and it had its revenge. They were driven onward till they had no choice left between talking nonsense, or what was worse. They would set conscience to rights in minutest detail, and so they had to take the responsibility of whatever could not be set to rights. Nature outwitted them; it gave up its liberty in the gross, and then forced them to surrender it again in detail. And thus, at length, under the treatment of compilers and abridgers, and under the influence of that idea of authority which deferred to *opinions* on the same rule as it deferred to *testimony*—exhibited in the coarsest brevity, and with the affectation of outbidding the boldest precedents—grew up that form of casistry which is exhibited in the Escobars and Baunys; which, professing to be the indispensable aid to common sense, envelops it in a very Charybdis of discordant opinions; amid whose grotesque suppositions, and whimsical distinctions, and vague yet peremptory rules, bandied about between metaphysics and real life, the mind sinks into a hopeless confusion of moral ideas, and loses every clew to simple and straightforward action."

The principal casuists of the Roman Church are Vasquez († 1604), Sanchez († 1610), Suarez († 1617), Laymann († 1635), Filliacius († 1622), Banny († 1649), Escobar († 1669), Busenbaum († 1669). Most of these names are immortalized in Pascal's *Provincial Letters* (see also each name in its proper place in this Cyclopædia). See also Migne, *Dictionnaire de cas de Conscience* (Paris, 1847, 2 vols. 4to). The books of so-called *Moral Theology*, in the Roman Catholic Church, are generally repertoires of casistry. The most important of them of late are Ligorio, *Theologia Moralis* (Paris, 1852, 6 vols. 12mo); Gury, *Causæ Conscientiæ* (Lyons, 1866, 2 vols. 8vo).

3. *Protestant Casistry.*—The Reformation, of course,

brought the office of such casuistry to an end. "The decision of moral questions was left to each man's own conscience; and his responsibility as to his own moral and spiritual condition could no longer be transferred to others. For himself he must stand or fall. He might, indeed, aid himself by the best lights which the Church could supply—by the counsel of wiser and holier servants of God; and he was earnestly enjoined to seek counsel of God himself by hearty and humble prayer. But he could no longer lean the whole weight of his doubts and his sins upon his father confessor and his mother Church. He must ascertain for himself what is the true and perfect law of God. He could no longer derive hope or satisfaction from the collections of cases, in which the answer rested on the mere authority of men fallible and sinful like himself. Thus the casuistical works of the Romanists lost all weight, and almost all value, in the eyes of the Reformed churches. Indeed, they were looked upon, and justly, as among the glaring evidences of the perversions and human inventions by which the truth of God had been disfigured. But even after the sophistry and the moral perversion connected with casuistry were exploded, the form of that science was preserved, and many valuable moral principles in conformity to it delivered. The writers of the Reformed churches did not at first attempt to substitute anything in the place of the casuistical works of the Romish Church. Besides an aversion to the subject itself, which, as remarked above, they naturally felt, they were, for a considerable period after the Reformation, fully employed upon more urgent objects. If this had not been so, they could not have failed soon to perceive that, in reality, most persons do require some guidance for their consciences, and that rules and precepts, by which men may strengthen themselves against the temptations which cloud the judgment when it is brought into contact with special cases, are of great value to every body of moral and Christian men. But the circumstances of the times compelled them to give their energies mainly to controversies with the Romish and other adversaries, and to leave to each man's own thoughts the regulation of his conduct and feelings." —Whewell, *History of Moral Philosophy in England* (Lond. 1852, 1 vol. 8vo, p. xxviii sq.).

In the writings of the early reformers (e. g. Melancthon and Calvin) there may be found moral directions approaching to casuistry. But the first regular treatise on casuistry in the Protestant Church was Perkins, *The whole Treatise of Cases of Conscience, distinguished into three Books* (Lond. 1602, 1606; also in his *Works*, vol. ii, Lond. 1617; in Latin, Hanov. 1608; and in *Perkinsii Opera*, Geneva, 1624). See PERKINS. He was followed by Henr. Alstedius (Reformed), *Theologia Casuum*, in 1621 (Hanover, 4to); F. Balduinus, *Tract. de Casibus Conscientiæ* (Vitemb. 1628, 4to; Lips. 1684, 4to); Amesius (Ames, q. v.), *De Conscientiâ, ejus jure et Casibus* (Amst. 1680); Osiander, *Theologia Casualis* (Tübingen, 1680, 8vo). For other writers on casuistry in the Lutheran and Reformed churches, see Walch, *Bibliotheca Theologica*, vol. ii, cap. vi. In the Church of England we find bishop Hall, *Resolutions and Decisions of divers practical Cases of Conscience* (Lond. 1649, 8vo); bishop Sanderson, *Nine Cases of Conscience* (London, 1678, sm. 8vo); Jeremy Taylor, *Ductor Dubitantium, or Rule of Conscience* (Works, Heber's edition, vols. xii-xiv). To casuistry belongs also Baxter's *Christian Directory, a Sum of Practical Theology* (fol. 1678; and in Baxter's *Practical Works*, vols. ii-vi; transl. into German, Frankf. 1698, 4to). Dickson, professor at Edinburgh, had previously published *Therapeutica Sacra* (Latin, 1656; English, 1695), a work which Baxter lauds highly. There is still at the University of Cambridge, England, a professorship of *Moral Theology or Casuistical Divinity*, which was held by the late Dr. Whewell. See Whewell, *Lectures on the History of Moral Philosophy in England* (Lond. 1852, 8vo);

Winer, *Theolog. Literatur*, vol. i, § xiii, d.; Herzog, *Real-Encyclopædie*, ii, 607, 787; Orme, *Life of Baxter*, vol. ii, ch. v; Hagenbach, *Theolog. Encyclopædie*, § 94; Stäudlin, *Geschichte der theol. Wissenschaften*, i, 842 sq.; Schweitzer, in *Studien u. Kritiken*, 1850, p. 564; Gass, in *Ilgen's Zeitschrift*, xii, 152; Bickersteth, *Christ. Student*, p. 468.

CASUS RESERVATI (*cases reserved*), in the Roman Church, are cases of sin such as an ordinary confessor (q. v.) cannot absolve, but only an ecclesiastic of high rank, or one specially authorized by the pope for the purpose. See *Canons of Trent*, sess. xiv, ch. vii.

CAT (*αἰλουρος*), so called, according to Phavorinus, from *moving its tail*, an animal mentioned only in Baruch vi, 22, as among those which defile the gods of the



Nubian Wild Cat (*Felis Maniculata*).

heathen with impunity (see below). They are alluded to, however, in the Targum (at Isa. xiii, 22; Hos. ix, 6) under the name *chathul*, חַתּוּל, Arabic *chaytal*. Martial (xiii, 69) makes the only mention of *cattia* in classical writers. Bochart (*Hieroz.* ii, 206 sq.) thinks that by the word חַתּוּל, *chayim*, in Isa. xiii, 21; xxxiv, 14; Jer. i, 89, and Psa. lxxiv, 14, some species of cats are meant; but this is very doubtful (Michaelis, *Suppl.* p. 2086). See BEAST. The Greek *αἰλουρος*, as used by Aristotle, has more particular reference to the wild cat (*Felis catus*, etc.). Herodotus (ii, 66) uses *αἰλουρος* to denote the domestic animal; similarly, Cicero (*Tusc.* v, 27, 78) employs *felis*; but both Greek and Latin words are used to denote other animals, apparently some kinds of martens (*Martes*). The context of the passage in Baruch appears to point to the domesticated animal. Perhaps the people of Babylon originally procured the cat from Egypt, where it was a capital offence to kill one (Diod. Sic. i, 88).—Smith, s. v. See ANIMAL WORSHIP. The Egyptians treated it as a divinity, under the denomination of *Pashu*, the Lunar Goddess, or Diana, holding every domesticated individual sacred, embalming it after death, and often sending it for interment to Bubastis (see Jablonski, *Panth. Eg.* ii, 66). Yet we find the cat nowhere mentioned in the canonical books as a domestic animal. In Baruch it is noticed only as a tenant of pagan temples, where, no doubt, the fragments of sacrificed animals and vegetables attracted vermin, and rendered the presence of cats necessary. With regard to the neighboring nations, they all had domestic cats, derived, it is presumed, from a wild species found in Nubia, and first described by Ruppel under the name of *Felis maniculata*. Two specimens are here given from these

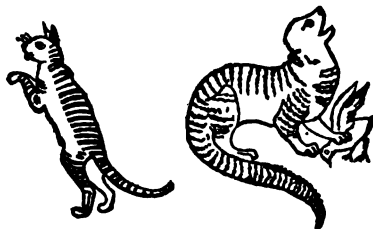

Ancient Egyptian domestic Cats.

paintings: one clearly a cat; the other, in the original, figured as catching birds, acting like a retriever for his master, who is fowling in a boat (Wilkinson, *Asc. Eg.* abridgm. i, 286, 287). It is not apparently a cat, but a species of *genet* or *paradoacurus*, one of the genera before hinted at. Both are nearly allied to the celebrated *ichneumon*, the *herpestes* of authors, the modern *weas*, which is even now occasionally domesticated; it differs in manners, for the *herpestes pharocidis* does not frequent the uplands, but willingly takes the water.—Kitto, s. v. See EGYPT.

Catabaptists (*κατά, against, and βαπτιστής*), a general name sometimes used to designate all who deny the necessity of Christian baptism.

Catacombs, subterranean places of burial, generally found in regions of soft and easily excavated rock, such as granular tufa. The oldest are in Egypt; others are to be found in Syria, Malta, Persia, Greece, and South America. It is likely that most of them were originally quarries, which afterwards came to be used as places of burial for the dead or as hiding-places for the living. When the word catacombs is used alone, it applies generally to those of Rome, the soil around which city is undermined in various places, and the long labyrinths thus formed are "The Catacombs." There are catacombs at Naples resembling those at Rome; and also at Palermo and Syracuse. This article is devoted entirely to the Catacombs of Rome.

I. *The Word Catacombs.*—The derivation of the word is uncertain. Some find it in *κατά, down, and κύμβος, mound, tomb*; others in *κοιμάς, to go to sleep*; or, as Marchi (*Monum.* p. 209), *Lat. cumba, part of decumbo, I lie down*; others in *κατά and κύμβη, a hollow, canoe, as from the resemblance of a sarcophagus to a boat* (Schneider, *Laz. Græc.*, s. v. *κύμβη*). The name catacombs was first applied to the underground burial-places in the sixth century; before that date they were called *cryptæ* (*κρυπταί, secret places*); *cemeteries* (*κοιμητήρια, sleeping-places*).

II. *Origin of the Catacombs.*—It is likely that some, at least, of the catacombs were originally the sand-pits and quarries from which building materials for use in the city had been taken. As the Romans burned their dead to ashes, they did not bury underground; but it is believed that the bodies of slaves and of executed criminals were sometimes thrown into the old quarries. This view was formerly held by the chief Roman Catholic writers on the Catacombs, e. g. Bosio, Aringhi, and Boldetti; but of late, since the publication of Padre Marchi's great work on the monuments of Rome, the writers of that school object to this origin for any of the catacombs, and call it a Protestant calumny (e. g. Bergier, *Dict. de Théologie*, i, 374). But Protestants and Romanists are alike interested in getting at historical truth; nor would either class be likely to stigmatize the early Christians, the common religious ancestry of all believers. The Jews in Rome and elsewhere retained the custom of burying their dead instead of burning them; and they probably began using catacombs in the vicinity of Rome before the time of Christ, or immediately after. In the 18th century Bosio discovered a Jewish catacomb outside of the ancient Porta Portuensis; and in 1862 another was opened on the Via Appia, outside of the Porta Capena. Its form is like that of the Christian catacombs; but, instead of the Christian symbols, the seven-branched candlestick and other Jewish emblems are sculptured on the slabs that close the tombs. The Etruscans, centuries before, had made use of rock-tombs or catacombs, as seen at Civita Castellana, Faleri, and other Etruscan cities. There is nothing more likely or natural than that, in the first persecutions, the Christians should have buried their dead in excavations previously made by Pagans; that they should afterwards have enlarged these excavations; and, finally, that they should have made new ones as their necessities, in the lapse of time, demand.

II.—K

ed. It is certain that in the catacombs at Naples there are found tiers of tombs, some of which are clearly Pagan, and have Pagan symbols and inscriptions, while others are as clearly Christian. The argument, on the other hand, for the theory that the early Christians themselves excavated all the catacombs, is well stated in Martigny, *Dict. des Antiq. Chrétienues*, p. 118 et seq. It certainly appears settled that many, if not most of the existing catacombs, were excavated by the Christians of the first three centuries. Their dates can be approximately ascertained by several criteria:

1. The style of some of the fresco paintings on the walls belongs to the third century, or even to the latter half of the second, while it is to be presumed that the crypts were excavated many years before the paintings were executed.

2. Some of the symbols which have been discovered belong to the earliest dates of the Christian history, and some of the coins bear the effigy of Domitian († 96), and even of earlier emperors; other inscriptions and paintings as clearly show later dates.

3. Inscriptions marked with consular dates. Among eleven thousand epitaphs in De Rossi's collection, about three hundred range from A. D. 71 up to the middle of the 4th century. For these and other reasons it is believed that the origin of the oldest Christian catacombs coincides with the dates of the earliest persecutions, e. g. that of Nero. Martigny puts in a much more doubtful argument, drawn from the burial-place of St. Peter, which, as he says, became the veritable nucleus of the Vatican catacombs. It is probable that the catacombs, such as we now know them, were all excavated before the 5th century. In that and the following century no new catacombs were dug, but the old ones were repaired; walls were built to support their roofs, and passages for light and air were opened to the surface of the ground.

III. *Early Uses.*—The Catacombs have served three distinct purposes:

1. *As places of burial.*—These underground receptacles consist of long galleries, with transverse corridors connecting them. These passages are sometimes regular for a considerable distance, but the multiplication of cross alleys and branches at last forms a labyrinth in which it is rash to venture without a guide. These galleries and corridors are of various lengths and heights, generally seven to eight feet high, and three to five wide. The roof is supported by that part of the tufa which is left between the passages, and in these walls the tombs (*loculi*) are excavated. In most cases the tomb is just large enough for a single corpse; in some tombs, however, two or more skeletons have been

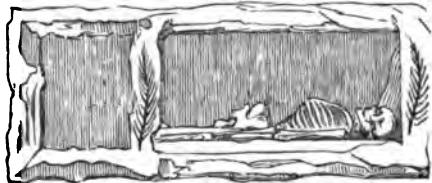

Catacombs. Fig. 1.

found. The number of graves in each tier depends on the height of the wall; there are commonly three to five; but even twelve are found in one instance. The tomb is closed up, either with a slab of marble (as in Fig. 3) or with large bricks (as in Fig. 2). Inscriptions and emblems are found sculptured or painted on many of the slabs (see Fig. 8), and in some cases a

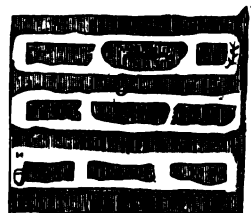

Catacombs. Fig. 2.

small vase (Fig. 2), supposed to have held blood, is found attached to the end of the tomb.

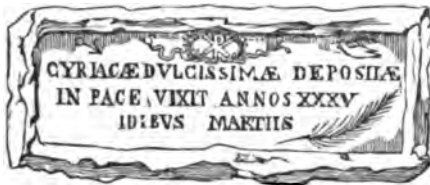

Catacombs. Fig. 3.

Besides the *loculi* in the corridors and passages, there are also larger spaces (called *arcoſolia*), having an arch over the tomb, or over a sarcophagus, hollowed out of the wall. There are also larger sepulchral chambers, called *cubicula*, of various shapes—square, triangular, semicircular, etc. These were doubtless family vaults; their walls are full of separate *loculi*. On the arch in front was a family inscription; e. g. on one found in the Catacombs of St. Agnes is the title *Cubiculum Domitiani*; while the separate *loculi* within had their individual inscriptions.

2. *As Places of Worship in Times of Persecution and Trouble.*—Chambers are found adapted to this purpose, some capable of holding a small assembly of worshippers, and others having room for but a few, who probably went there to commemorate the dead buried in the crypts. In some cases there is an opening from these crypts to the upper air sufficient to let in light, but commonly they were illuminated by lamps suspended by bronze chains from the roof. Cisterns and wells are sometimes found in them which served for use in baptisms. "The superstitious reverence which in later times was paid to the relics of martyrs was perhaps owing, in some measure, to the living and the dead being brought into so close contact in the early ages, and to the necessity of the same place being used at once for the offices of devotion and for burial" (Burton, *Eccles. History*, p. 841). In later times churches were built over the entrances to the chief catacombs; e. g. St. Peter's, over those of the Vatican; St. Paul's, over those of St. Lucina; St. Agnes, over the catacombs which bear her name, and in which, according to tradition, she was buried.

3. *As Places of Refuge.*—It is among the Roman traditions that Pope Stephen long dwelt in the Catacombs, held synods there, and was finally killed in his episcopal chair. Even after the establishment of the Church under Constantine, the Catacombs served for places of refuge for various popes in times of trouble. Liberius, it is said, lived a year in the cemetery of St. Agnes; and in the beginning of the fifth century, during one of the many disputes for the papal chair, Boniface concealed himself in one of the catacombs. There is little doubt that large numbers of Christians took refuge in the Catacombs during the early persecutions. A Protestant writer remarks that in the preparation of these vast caverns we may trace the presiding care of Providence. "As America, discovered a few years before the Reformation, furnished a hiding-place of refuge to the Protestants who fled from ecclesiastical intolerance, so the catacombs, reopened shortly before the birth of our Lord, supplied shelter to the Christians in Rome during the frequent proscriptions of the second and third centuries. When the Gospel was first propagated in the imperial city its adherents belonged chiefly to the lower classes; and, for reasons of which it is now impossible to speak with certainty, it seems to have been soon very generally embraced by the quarrymen and sand-diggers. It is probable that many were condemned to labor in those mines as a punishment for having embraced Christianity (see Lee's *Three Lectures*, Dublin, p. 28; Maitland's *Church in the Catacombs*, p. 24. Dr. Maitland visited Rome in 1841, and his inspection of the Lapidarian Gallery seems to have

been regarded with extreme jealousy by the authorities there). Thus it was when persecution raged in the capital; the Christian felt himself comparatively safe in the catacombs. The parties in charge of them were his friends; they could give him reasonable intimation of the approach of danger, and among these 'dens and caves of the earth,' with countless places of ingress and egress, the officers of government must have attempted in vain to overtake a fugitive" (Killen, *The Ancient Church*, p. 860).

IV. *Number and Extent of the Catacombs.*—The actual number of catacombs has never been accurately known. Aringhi, followed by other writers, gave the number as high as sixty, but without proof. De Rossi's list gives forty-two, only twenty-six of which are extensive, while five date after the peace secured for the Church under Constantine, mostly within a circle of three miles from the modern walls; the most remote being that of St. Alexander, about six miles on the Via Nomentana. It was formerly held that the catacombs around Rome were connected together in a vast system, but De Rossi has shown that there is no such connection. The most remarkable catacombs are on the left bank of the Tiber; viz. the catacombs of Sts. Julius, Valentinus, Basilla, Gianutus, Priscilla, Brigida, Agnes, Hippolytus, Peter, and Marcellinus, etc. On the Via Appia are the extensive catacombs of Pretextatus, Callistus (not far from the latter is an interesting Jewish catacomb, discovered in 1859), Sts. Nereus and Achilleus, and others. On the right bank there are few catacombs of interest except those of the Vatican. Tradition fixes upon this as the spot where St. Peter was buried; and in the belief of this tradition the church of St. Peter was built on the neighboring hill. The modern cemetery of the Vatican is over the more ancient one, contrary to the general rule. The number of bodies deposited in the catacombs cannot, of course, be accurately ascertained. P. Marchi estimates it at six millions. Michele di Rossi calculates, from carefully-gathered data, that the total length of all the galleries known to exist near Rome is 957,800 yards, equal to about 590 miles, but only a small part of this vast range has been explored.

V. *Inscriptions and Symbols.*—For a specific account of the inscriptions and symbols of the Catacombs, see the articles INSCRIPTIONS; SYMBOLISM. The collections of the Vatican and the Lateran contain multitudes of these remains, which can now be studied in De Rossi's *Inscriptiones Christianae Urbis Romae* (1861), and in other works named at the end of this article. On most of the slabs is found the Constantinian monogram of Christ $\text{X}\rho$, or a $\text{X}\rho\omega$. The sculptures and paintings are either historical or symbolical. Among the former, from the Old Testament, are the fall of Adam and Eve, Noah in the ark, the sacrifice of Abraham, Moses striking the rock, the story of Jonas, Daniel in the lions' den, the three Israelites in the furnace, the ascent of Elias, etc. From the New Testament, the Nativity, the adoration of the Magi, the change of water into wine, the multiplication of loaves, the healing of the cripple, the raising of Lazarus, Christ entering Jerusalem on an ass, Peter denying Christ, between two Jews; the arrest of Peter, Pilate washing his hands; in one instance (on a sarcophagus), the soldiers crowning our Lord in mockery, but a garland of flowers being substituted for the crown of thorns. No Crucifixion occurs among the remains; nor does the Virgin Mary or St. Peter appear before the fourth century.

"Turning to the purely symbolic, we find most frequently introduced, the lamb (later appearing with the nimbus round its head), and the various other forms in which faith contemplated the Redeemer, namely, the good shepherd, Orpheus charming wild animals with his lyre, the vine, the olive, the rock, a light, a column, a fountain, a lion; and we may read seven poetic lines by Pope Damasus enumerating all the titles or

symbols referring to the same divine personality, comprising, besides the above, a king, a giant, a gem, a gate, a rod, a hand, a house, a net, a vineyard. But, among all others, the symbol most frequently seen is the fish. See *ICHTHUS*. We find also the dove for the Holy Spirit, or for beatified spirits generally; the stag, for the desire after baptism and heavenly truth; candelabra, for illumination through the Gospel; a ship, for the Church—sometimes represented sailing near a light-house, to signify the Church guided by the source of all light and truth; a fish swimming with a basket of bread on its back, for the eucharistic sacrament; the horse, for eagerness or speed in embracing divine doctrine; the lion, for martyr fortitude, or vigilance against the snares of sin (as well as with that higher allusion above noticed); the peacock, for immortality; the phoenix, for the resurrection; the hare, for persecution, or the perils to which the faithful must be exposed; the cock, for vigilance—the fox being taken in a negative sense for warning against astuteness and pride, as the dove (besides its other meanings) reminded of the simplicity becoming to believers. Certain trees also appear in the same mystic order: the cypress and the pine, for death; the palm, for victory; the olive, for the fruit of good works, the lustre of virtue, mercy, purity, or peace; the vine, not only for the eucharist and the person of the Lord, but also for the union of the faithful in and with him" (Hemans, in *Contemp. Review*, Sept. 1866).

As to the spirit of the inscriptions and symbols, two things are to be noticed: 1. Their entire opposition to the Pagan spirit. 2. Their almost entire freedom from the later Romanist errors. As to the first, the inscriptions on Pagan tombs are remarkable for their painful exhibition either of despair or of rebellion against the Divine will: for instance, one taken from the right-hand wall of the Lapidarian gallery: "CAIUS JULIUS MAXIMUS, (aged) two years and five months. O relentless fortune, who delightest in cruel death, why is MAXIMUS so suddenly snatched from me? He who lately used to lie joyful on my bosom. This stone now marks his tomb—behold his mother." In the Christian inscriptions, on the other hand, we find expressions of hope, peace, resignation, but nothing of despair, hardly even sorrow. "'Vivis in Deo,' most ancient in such use; 'Vive in eterno;' 'Pax spiritui tuo;' 'In pace Domini dormis,' frequently introduced before the period of Constantine's conversion, but later falling into disuse; 'In pace' continuing to be the established Christian formula, though also found in the epitaphs of Jews; while the 'Vixit in pace,' very rare in Roman inscriptions, appears commonly among those of Africa and of several French cities, otherwise that distinctive phrase of the Pagan epitaph, 'Vixit' (as if even in the records of the grave to present life rather than death to the mental eye), does not pertain to Christian terminology" (Hemans, l. c.).

As to the other point, the freedom from later Roman doctrines and superstitions, we take the following passage from Killen (*The Ancient Church*, p. 351 sq.): "These witnesses to the faith of the early Church of Rome altogether repudiate the worship of the Virgin Mary, for the inscriptions of the Lapidarian Gallery, all arranged under the papal supervision, contain no addresses to the mother of our Lord (Maitland, p. 14). They point only to Jesus as the great Mediator, Redeemer, and Friend. Farther, instead of speaking of masses for the repose of souls, or representing departed believers as still to pass through purgatory, the inscriptions describe the deceased as having entered immediately into eternal rest. 'Alexander,' says one of them, 'is not dead, but lives beyond the stars, and his body rests in this tomb.' 'Here,' says another, 'lies Paulina, in the place of the blessed.' 'Gemella,' says a third, 'sleeps in peace.' 'Aselus,' says a fourth, 'sleeps in Christ' (Maitland, pp. 38, 41, 43, 170). On a third point, viz. celibacy, we gather the following

testimony from the tombs. Hippolytus tells us (*Philosophumena*, lib. ix) that, during the episcopate of Zephyrinus, Callistus was 'set over the cemetery.' This was probably considered a highly important trust, as, in those perilous times, the safety of the Christians very much depended on the prudence, activity, and courage of the individual who had the charge of their subterranean refuge. The new curator seems to have signalized himself by the ability with which he discharged the duties of his appointment; he probably embellished and enlarged some of these dreary caves; and hence a portion of the Catacombs was designated 'the cemetery of Callistus.' Hippolytus, led astray by the ascetic spirit beginning so strongly to prevail in the commencement of the third century, was opposed to all second marriages, so that he was sadly scandalized by the exceedingly liberal views of his Roman brother on the subject of matrimony; and he was so ill-informed as to pronounce them novel. 'In his time,' says he indignantly, 'bishops, presbyters, and deacons, though they had been two or three times married, began to be recognised as God's ministers; and if any one of the clergy married, it was determined that such a person should remain among the clergy as not having sinned' (*Philosophumena*, lib. ix. Tertullian corroborates the charge of Hippolytus, *De Pudicitia*, cap. 1). We cannot tell how many of the ancient bishops of the great city were husbands. We know, however, that, long after this period, married bishops were to be found almost everywhere. One of the most eminent martyrs in the Diocletian persecution was a bishop who had a wife and children (Eusebius, lib. viii, c. 9). Clemens Romanus speaks as a married man (*Ep. ad Cor.* § 21). But the inscriptions in the Catacombs show that the primitive Church of Rome did not impose celibacy on her ministers. There is, for instance, a monument 'To Basilus, the presbyter, and Felicitas, his wife;' and on another tombstone, erected about A.D. 472, or only four years before the fall of the Western Empire, there is the following singular record: 'Petronia, a deacon's wife, the type of modesty. In this place I lay my bones: spare your tears, dear husband and daughters, and believe that it is forbidden to weep for one who lives in God' (Maitland, p. 191-193; Aringhi, i, 421, 419). 'Here,' says another epitaph, 'Susanna, the happy daughter of the late presbyter Gabinius, lies in peace along with her father' (Aringhi, ii, 228; Rome, 1651). In the Lapidarian Gallery of the Vatican there are other epitaphs to the same effect."

The doctrinal lessons to be drawn from the Catacombs are also treated in two articles in the *Revue Chrétienne* (15 Mai, 1864; 15 Juin, 1864), by Roller, who, after a careful study of the conformation, etc. of the Catacombs, and of their tombs, chapels, etc.; of the inscriptions, of the paintings, and, finally, of the sarcophagi, with their sculptures, arrives at the following conclusions: The use of the Catacombs as places of worship dates from the 8d century; the substitution of the altar for the communion-table dates from the 4th. The Episcopal *Cathedra* appears at about the beginning of the 5th century. No specifically Romanist doctrine finds any support in inscriptions dating before the 4th century. We begin to trace signs of saint-worship in the 5th century. The first idea of the transmission of power from Christ to Peter dates from the latter part of the 5th to the beginning of the 6th, and even then Peter's figure does not appear armed with the keys, as in the later symbolism. Finally, Protestantism has every thing to gain, and nothing to lose, from the most thorough study of the remains gathered with so much care from the Catacombs by the authorities of the Church of Rome.

VI. *Later History and Literature.*—1. *Middle Age.*—After the 6th century no additions seem to have been made to the Catacombs. After a corridor or passage was filled, it appears to have been blocked up with stone. The irruption of the barbarians seems to coin-

cide with the disuse of the ancient cemeteries as burial-places, and they fell into neglect and ruin. Pope Paul I († 767) removed the bones of many martyrs and so-called saints from the Catacombs, and distributed them among churches and monasteries. But the tombs of the martyrs continued to be objects of reverence, and pilgrimages were made to them, especially to those of St. Sebastian, over which a church had been built, and which remained accessible. The Crusaders thronged the subterranean corridors, and carried off bones of the dead in such numbers that the popes denounced the act as a crime for which the penalty should be excommunication. With these exceptions, the Catacombs may be said to have been almost entirely forgotten for several centuries. Their ingresses became, for the most part, unknown even to the clergy; and one of the earliest records of their being visited in later ages is found in the names of Raynuzio Farnese (father of Paul III) and others, marked by an inscription in the Catacombs of St. Callistus, of date 1490.

2. *Modern Scientific Exploration.*—In 1578 a Dominican named Alphonse Ciacconio, learning that a cemetery (St. Priscilla's) had been opened on the Salarian Way, made a partial exploration of it, and gave designs of sculptures, etc. found in it. About 1590 he was joined by a young Frenchman named Wingh. But Antonio Bosio († 1600) was the real founder of the modern study of the Catacombs. He devoted to it thirty years of labor, the fruits of which appeared only after his death, in *Roma Sotterranea*, compiled from Bosio's MSS. by Severano, an Oratorian priest (Roma, 1632, 1 vol. fol.), and subsequently another Oratorian, Aringhi, brought out, with additions, the same work in Latin (Roma, 1651, 2 vols. fol.; Cologne, 1659, 2 vols. fol.). The works of Bosio and Aringhi were like a revelation to the learned world, and gave a great impulse to archaeological studies. In 1702 appeared Fabretti's *Inscriptiones Antiquae*, and in 1720 *Cimiteri dei Santi Martiri*, by Boldetti, the fruit of thirty years' labor. The *Sculpture e Piture Sacre* (Sacred Sculptures and Paintings from the Cemeteries of Rome, 3 vols. fol.), by Bottari (1737-54), is a very valuable and fully illustrated work, using Bosio's materials, and even his copper-plates. Original sketches of sculptures from the Catacombs are given by D'Agincourt, *Histoire d'art par les Monuments* (Paris, 1811-23, 6 vols. fol.). But in the eighteenth century little was done for the exploration or illustration of the Catacombs, and it is only since 1820 that the research has been carried on in a really scientific way, and the honor of this is largely due to the Jesuit padre Giuseppe Marchi, whose *Monumenti Primitivi delle Arte Christiane* (Roma, 1844, 70 plates, 4to) is confined wholly to the topography and architecture of the Catacombs. It was to have been followed by a second volume on the paintings, and a third on the sculptures. The French government has been at the expense of publishing, under the patronage of the Academy of Inscriptions, the finely-illustrated work of Perret, *Les Catacombes de Rome* (Paris, 1852-3, 6 vols. fol.), a work of more artistic than original scientific value, but yet exceedingly valuable for study. The 5th volume gives 430 Christian inscriptions, carefully reproduced. But all previous works are thrown into the shade by those of Chevalier G. B. di Rossi, who has given many years to personal research in the Catacombs (aided by his brother Michele di Rossi), and whose *Roma Sotterranea*, of which vol. i appeared in 1866 (4to, with Atlas of 40 plates), will, when completed (in 3 vols.), make the study of the Catacombs easy, without a personal visit to Rome. He has also published (under the patronage of Pius IX) *Inscriptiones Christianae urbis Romae* (1861, vol. 1, fol.), containing the Christian inscriptions of Rome anterior to the 6th century. Among minor works are Northcote (Rom. Cath.), *The Roman Catacombs* (London, 1859, 2d ed. 12mo.); Maitland, *Church in the Catacombs* (Lond. 1847, 2d ed. 8vo.); Kip, *The Catacombs of Rome* (N. Y. 1854,

12mo.); Bellermann, *Acht. Christliche Begräbnisstätten u. d. Catacomben zu Neapel* (Hamb. 1839). See also Murray, *Hand-book of Rome*, § 85; Schaaf, *Ch. History*, i, § 98; Rémusat, *Musée Chrétien de Rome* (in *Rev. d. d. Monde*, 15 Juin, 1863); Jehan, *Dict. des Origines du Christianisme*, p. 212 sq.; Martigny, *Dict. des Antiquités Chrét.* p. 106 sq.; Lecky, *History of Rationalism*, i, 216 sq.; *English Review*, v, 476; *Edinburgh Rev.* vol. cix, p. 101; vol. cxx, p. 112 (Am. ed.); Bouix, *Theologie des Catacombes* (Arras, 1864). See CRYPTS; LOCULUS; INSCRIPTIONS; SYMBOLISM.

Catafalco (Ital. a scaffold), or CATAFALQUE, a temporary cenotaph of carpentry, intended to represent a tomb, and with decorations of sculpture, and painting or upholstery. It is employed in funeral ceremonies in the Church of Rome, especially in Italy.

Cataldus, bishop of Tarentum, a saint of the Roman calendar. According to one account, he was born in Ireland, and came to Italy in the fifth or sixth century. Marvellous stories of miracles and wonders are connected with his birth and history in the Tarentine traditions. See Hoefler, *Novv. Biog. Générale*, ix, 141; Herzog, *Real-Encyclopädie*, supplement. p. 308; *Acta Sanctorum*, t. ii, Mali, p. 569.

Cataphrygians, a name anciently given to the Montanists, because Montanus first published his opinions in a village of Mysia, on the borders of Phrygia. See MONTANISTS.

Catechetical Instruction. See CATECHETICS; CATECHISM.

Catechetical Schools. See ANTIOCH and ALEXANDRIA (SCHOOLS OF).

Catechetics, CATECHIZATION. Catechetics is that part of the science of theology which treats of catechetical religious instruction (under Church authority), both with regard to theory and practice. It belongs to the department of Practical Theology.

1. *Name and Scope.*—The term is derived from *κατηχησις*, to sound out aloud; to sound into one's ears; and hence, in N. T., to instruct orally (1 Cor. xiv. 19; Gal. vi, 6, et al.). In the N. T. the word applies to all kinds of oral instruction; but its derivatives, in later use, acquired a special application to instruction given to proselytes seeking baptism. Still later, the same terms came to apply to elementary instruction in Christianity, whether given to proselytes seeking baptism, or (and this chiefly) to baptized children in the Church. The act of giving such instruction is called *catechizing*, or *catechization*. The person instructing is called a catechist (q. v.); the persons taught are called *catechumens* (q. v.); the substance of the instruction (in later times a small book) is called *The Catechism* (q. v.). It belongs to Catechetics, as a branch of theology, to treat of all these heads; but, for convenience of reference, we treat the three latter in separate articles, in their alphabetical order.

2. *History.*—The science of Catechetics, as such, can hardly be said to have taken its rise until after the Reformation. But as the necessities of the case gave rise to oral instruction in Christianity from the very beginning, and to the subsequent development of this instruction into a systematic branch of Church activity, we find indications of Catechetics at all periods.

(1.) *Before the Reformation.*—The first teaching of Christ and his apostles was necessarily oral, and partly homiletical, partly catechetical. But we find no mention in the N. T. of catechists as Church functionaries. In the second century we find mention of catechists and catechumens (e. g. in the *Clementines*, q. v.). Under the catechetical system of the fourth century, the catechumens were taught the Ten Commandments, a creed, or summary confession of faith, and the Lord's Prayer, with suitable expositions; but, prior to baptism, the nature of the sacraments was carefully concealed. See ARCANI DISCIPLINA; CATECHUMEN. The *Apostolical Constitutions* (q. v.) not only mention the

catechumens, but fix three years as the period of instruction (viii, 32). See ALEXANDRIA; ANTIOCH (SCHOOLS OF). In Gregory of Nyssa's († 894) *λόγος κατηχητικός ὁ μίγας* (ed. Krabinger, Monac. 1885), and in Cyril of Jerusalem's († 386) *Κατηχησις* (Catechetical discourses), we find catechetical instruction for both proselytes and newly-baptized persons. Augustine wrote a tract, *De Catechizandis rudibus* (opp. ed. Bened. t. vi). After the Church had become established, and its increase was obtained by the birth and baptism of children rather than by conversions from heathendom, the idea of catechetical instruction passed from being that of a preparation for baptism to being that of a culture of baptized children. When confirmation became general, catechetical instruction began to bear the same relation to it that it had formerly done to baptism. In the missions to heathens, in the Middle Age, it became usual to baptize converts at once, and the ancient catechumenate fell into disuse. Nor was great attention given to the catechizing of baptized children in the Roman Church up to the time of the Reformation; the confessional took the place of the Catechism. See CATECHISM. The names of Bruno, bishop of Würzburg (11th century), Hugo de St. Victore, Otto of Bamberg, and John Gerson, are to be mentioned as active in restoring catechetical instruction. The Waldenses, Wicliffites, and other reforming sects gave attention to the subject. On the Waldensian Catechism, see Zeschwitz, *Katechismen der Waldenser und Böhm. Brüder* (Erlangen, 1868); *Jahrbücher für deutsche Theologie*, ix, 2, 885.

(2.) *Since the Reformation.*—As the Reformation was a revival of religion for the human intellect as well as for the heart, it naturally followed that the training of children soon came to demand new methods, or the restoration of old methods, of grounding them in the faith. Luther was the father of modern catechetics, both by the Catechisms (q. v.) which he himself prepared, and by the writings in which he explained Catechetics and gave an impulse to their pursuit. The principal points of Luther's Catechisms are the Decalogue, the Creed, the Lord's Prayer, and the Sacraments (1529). Luther, with true insight, however, taught that catechization should not merely include the hearing of a recitation from the book, but also an explanation and an application of it to the hearts of the pupils (see prefaces to his larger and smaller Catechisms, and also Brüstlein, *Luther's Einfluss auf das Volksschulwesen*, etc., Jena, 1852). Calvin also published Catechisms (1538, 1541), and in the preface to the *Catechismus Eccles. Genevensis* he gave his views of the nature and design of Catechisms and of catechetical instruction at length. He defines the Catechism to be "formula erudiendi pueros in doctrina Christi" (Augusti, *Corpus. Libror. Symbolicor.* p. 460-464). The Reformed churches generally followed: e. g. the Heidelberg Catechism (1568) for the German Reformed; the Church of England Catechism (1558, 1572), etc. The Helvetic Confession (*brevis et simplex*) makes catechization a duty of positive obligation in the Church: "... pastores, qui juventutem mature et diligenter catechizant, prima fidei fundamenta jacentes, explicando Decalogum mandatorum Dei, Symbolum item Apostolorum, Orationem quoque Dominicam, et Sacramentorum rationem, cum aliis ejus generis primis principiis, et religionis nostræ capitibus præcipuis" (*Caput xxiv*). See also the preface to the Heidelberg Catechism (Augusti, *Lib. Symb.* 532 sq.), and the article CATECHISM. In Germany, after the fervor of the Reformation period had passed, and the scholastic theologians reigned, the catechetical instruction degenerated into a mere formal routine of preparation for confirmation, and the same thing happened in the Church of England. Indeed, this result appears to be inevitable where baptismal regeneration is believed, and confirmation is made to follow as a matter of course. Spenser and the Pietists gave new life to catechetical in-

struction by connecting it with spiritual teaching and life (see Hurst, *History of Rationalism*, p. 90; Thile, *Spener als Katechet*, Berl. 1840). The Church of Rome was compelled to follow the Reformers in catechetical instruction; the *Catechismus Romanus* (1566) became the basis of numerous Catechisms—those of Canisius, Bellarmin, Bossuet, and Fleury attaining the widest circulation. As any bishop can authorize a Catechism for his diocese, the Romanists have now a great variety, and they are still increasing (see *Theologische Quartalschrift*, 1868, p. 443).

The theory of catechization in the Protestant Church grew up gradually from the germs in Luther's teaching, through the period of decay and dry scholasticism, and finally shot up into full bloom in Pietism. Its principles are, 1. That the Catechism of the Church, stamped with its authority, shall be used in instruction; 2. That the instruction is not Socratic, i. e. does not aim to draw out what is in the mind of the pupil, but rather to convey revealed truth to the mind in a way which it can appreciate and understand; 3. That while the pupil is to learn the words of the Catechism by heart, the teacher is to explain and illustrate them from the Bible, and to enforce them on the heart and conscience of the catechumen—i. e. catechization is to be not merely didactic, but practical. It is farther well settled that the Catechism of each particular church should be taught to the children of that church (1) by parents or guardians in the family; (2) by the Sunday-school teacher, who should always be a constant catechist; and (3) by the pastor, whose catechization should not only be a test of the proficiency of the children under home and Sunday-school instruction, but should include exhortation, illustration, and application also. It was one of Spenser's glories that he introduced public catechization; and the pastor who fails, at fixed times, to catechize the children in presence of the congregation, loses one of the most important means of Christian culture within the sphere of Church life.

Dr. Ashbel Green (*Lectures on the Shorter Catechism*, vol. 1), in his *Introductory Lecture*, thus speaks of the advantages of catechization: "The catechetical or questionnaire form of religious summaries renders them most easy and interesting to children and youth, and, indeed, to Christians of all ages and descriptions. For myself, I have no reluctance to state here publicly what I have frequently mentioned in private, that in the composition of sermons one of the readiest and best aids I have ever found has been my Catechism. Let me add, farther, that long observation has satisfied me that a principal reason why instruction and exhortation from the pulpit are so little efficacious, is, that they presuppose a degree of information, or an acquaintance with the truths and doctrines of divine revelation, which, by a great part of the hearers, is not possessed, and which would best of all have been supplied by catechetical instruction. It is exactly this kind of instruction which is at the present time most urgently needed in many, perhaps in most of our congregations. It is needed to imbue effectually the minds of our people with "the first principles of the oracles of God," to indoctrinate them soundly and systematically in revealed truth, and thus to guard them against being "carried about with every wind of doctrine," as well as to qualify them to join in the weekly service of the sanctuary with full understanding, and with minds in all respects prepared for the right and deep impression of what they hear."

The duty of catechization is enjoined in the laws of almost all branches of the Church. In the Church of England, by Canon 58, "every parson, vicar, or curate, upon every Sunday and holyday, before evening prayer, shall, for half an hour or more, examine and instruct the youth and ignorant persons of his parish in the Ten Commandments, the articles of the belief, and in the Lord's Prayer; and shall diligently hear, in-

struct, and teach them the Catechism set forth in the Book of Common Prayer. And all fathers, mothers, masters, and mistresses shall cause their children, servants, and apprentices, which have not learned the Catechism, to come to the church at the time appointed, obediently to hear, and to be ordered by the minister until they have learned the same. And if any minister neglect his duty herein, let him be sharply reprov'd upon the first complaint, and true notice thereof given to the bishop or ordinary of the place. If, after submitting himself, he shall willingly offend therein again, let him be suspended. If so the third time, there being little hope that he will be therein reformed, then excommunicated, and so remain until he be reformed. And likewise, if any of the said fathers, mothers, masters, or mistresses, children, servants, or apprentices, shall neglect their duties as the one sort in not causing them to come, and the other in refusing to learn, as aforesaid, let them be suspended by their ordinaries (if they be not children), and if they so persist by the space of a month, then let them be excommunicated. And by the rubric, the curate of every parish shall diligently, upon Sundays and holydays, after the second lesson at evening prayer, openly in the church, instruct and examine so many children of the parish sent unto him as he shall think convenient, in some part of the Catechism. And all fathers and mothers, masters and dames, shall cause their children, servants, and apprentices (who have not learned their Catechism) to come to the church at the time appointed, and obediently to hear, and be ordered by the curate, until such time as they have learned all that therein is appointed for them to learn." These careful rules, however, have become nearly a dead letter. In the Protestant Episcopal Church, the xxviiith Canon (of 1882) enjoins that "the ministers of this Church who have charge of parishes or cures shall not only be diligent in instructing the children in the Catechism, but shall also, by stated catechetical lectures and instruction, be diligent in informing the youth and others in the doctrines, constitution, and liturgy of the Church." The Methodist Episcopal Church makes it the "duty of preachers to see that the Catechism is used in Sunday-schools and families, to preach to the children, and to publicly catechize them in the Sunday-schools and at public meetings appointed for that purpose" (*Discipline*, part v, § 2). "It shall also be the duty of each preacher, in his report to each Quarterly Conference, to state to what extent he has publicly or privately catechized the children of his charge" (part ii, chap. ii, § 17). "At the age of ten years, or earlier, the preacher in charge shall organize the baptized children of the church into classes, and appoint suitable leaders, male or female, whose duty it shall be to meet them in class once a week, and instruct them in the nature, design, and obligation of baptism, and the truths of religion necessary to make them wise unto salvation" (part i, ch. ii, § 2). The Presbyterian Church makes catechizing "one of the ordinances in a particular church" (*Form of Government*, ch. vii), and enjoins the duty in its *Directory for Worship*, ch. i, § 6; also ch. ix, § 1: "Children born within the pale of the visible Church, and dedicated to God in baptism, are under the inspection and government of the Church, and are to be taught the Catechism, the Apostles' Creed, and the Lord's Prayer." In the Reformed Dutch Church each pastor is bound to expound the Heidelberg Catechism, and the Classis is bound to see that "the catechizing of children and youth are faithfully attended to" (*Constitution*, ch. i, art. iii, § 8). The Lutheran and German Reformed churches, not only by their traditions, but also by Church law, are bound to fidelity in catechization.

8. *Literature*.—The science of Catechetics was treated by Hyperius, *De Catechesi* (1570; ed. Schmidt, Helmst. 1704, 8vo); Dietrich, *Instit. Catechet.* (1618); Alstedius, *Theologia Catechetica* (Hanover, 1616, 4to); Rambach, *Wohlanterrichteter Catechet* (Jena, 1727, and Lips.

1736, 8vo). Dr. Watts gave an impetus to Catechetics by his *Discourse on Instruction by Catechism* (London, 1728; *Works*, ed. of 1812, vol. v), in which he explained the Catechism of the Westminster Assembly, and gave two smaller Catechisms. A thorough work on this branch of theology, in English, is yet a desideratum. The relation of the Catechism and of catechetical instruction to the Church and to baptism has not been made so prominent in the English-speaking churches as in the German. On minor points, especially relating to the ancient Church, Bingham and other English writers have done well. Both for the history and theory of Catechetics in general, our chief references must be to German writers. Among them are, besides those already mentioned, Langemack, *Historia Catechetica* (8 vols. 1729-40); Walch, *Einleitung in die catechetische historie*, etc. (1752); Köcher, *Einleitung in die catechetische Theologie* (1752); the same, *kat. Geschichte d. päpstlichen Kirche* (1753); the same, *kat. Ges. d. reform. Kirche* (1766); the same, *kat. Geschichte d. Waldenser, u. a. Secten* (1768)—the four books constituting a body of Catechetical science. Of more or less Rationalistic tendencies are the following: Schuler, *Geschichte des kat. Religionsunterrichts unter der Protestanten bis 1762* (Halle, 1802); Gräffe, *Lehrbuch der allgem. Katechetik* (on Kantian principles, Götting, 1799, 8 vols.; 1805, 1 vol.); Gräffe, *Grundriss der allgem. Katechetik* (1796, 8vo). Of the same school: Schmid, *katechet. Handbuch* (Jena, 2d ed. 1799-1801); Müller, *Lehrbuch d. Katechetik* (Altona, 2d ed. 1822, 8vo). More evangelical, but yet resting on the Kantian philosophy in its Fichtean form, is Daub, *Lehrbuch der Katechetik* (Frankfurt, 1801, 8vo); and more practical are Schwarz, *Katechetik* (Giessen, 1819, 8vo); Harnisch (Halle, 1828); Hoffman, *katechetik* (1841). Since the modification of German theology through Schleiermacher's influence, a still better class of works has appeared, among which are Palmer, *evangel. Katechetik* (1844; 4th ed. 1866, 8vo); Kraussold, *Katechetik* (1848); Plato, *Lehrbuch d. Katechetik* (Leips. 1858, 12mo); Puchta, *Handbuch der prakt. Katechese* (1854); Zeschwitz, *System der christlich-kirchlichen Katechetik* (Lpz. 1864-66, 2 vols. 8vo, the fullest treatise on the subject, but not yet finished). In books of practical theology, Catechetics, of course, is treated in its place. Among Roman Catholic writers we name Galura, *Grundsätze d. wahren Katechese* (Freiburg, 1795); Winter, *Katechetik* (Landsbut, 1816, 8vo); Gruber; Müller; and especially Hirscher, *Katechetik* (1831, 4th ed. Tübing. 1840), whose comprehensive mind grasped the subject in all its bearings, but especially in its true relations to the pastoral work. Among writers in English, see Cannon, *Pastoral Theology*, Lecture xxxi; Baxter, *Reformed Pastor*; Vinet, *Pastoral Theology*; Baxter, *The Teaching of Families* (*Practical Works*, vol. xix); Orme, *Life of Baxter*, ii, 140 sq.; Gilly, *Horæ Catecheticae* (London, 1828, 8vo); Doddridge *On Preaching*, Lecture xvii; Farinon, *Sermons*, iv, 201; *Quarterly Review*, March, 1848; *Princeton Review*, xxi, 59; *Evangelical Review*, i, 221; Arden, *Manual of Catechetical Instruction* (High-church; London, 1851, 12mo); Green, Ashbel, *Lectures on the Shorter Catechism* (Phila. 1841, 2 vols. 8vo); Alexander, A., *Duty of Catechetical Instruction* (Presbyter. Tract Soc.); Ramsay, *Catechetical Instruction* (Church of England; Lond. 1851, 18mo); *Aids to Catechetical Teaching* (Lond. 1848, 12mo); Bather, *Art of Catechizing* (revised by author, N. Y. 1847). Catechetical hints may be found in many books on Sunday-school and Bible-class teaching; in periodicals, such as *The Catechumen's Reporter* (Lond.); and in the various expositions of the different Church Catechisms. Also Clarisse, *Encyclopædia Theologia*, § 99; Siegel, *Handbuch der christ.-kirchl. Alerthümer*, i, 340 sq.; Hagenbach, *Encyclopædie*, § 99; Pelt, *Theolog. Encyclopædie*, § 103; Herzog, *Real-Encyclopædie*, vii, 441; Winer, *Theolog. Literatur*; Walch, *Bibliotheca Theologica*, vol. i, ch. iv.

Catechism (in the ecclesiastical sense), a book of

Christian instruction, put forth under the authority of the Church, for the oral instruction of children and proselytes. Generally, at the present day, the Catechism is in the form of question and answer.

1. *The name Catechism.*—The name is derived from *κατήχησις* (see CATECHETICS, 1). In its existing sense it probably originated with Luther. In the early ages the catechumens (q. v.) were taught the Creed, the Lord's Prayer, and certain rudiments of doctrine (Bingham, *Orig. Eccles.* bk. x, ch. i, § 6). Cyril († 886) and Gregory of Nyssa († 894) wrote what would now in substance be called Catechisms, as did Augustine († 430) in his Exposition of the Creed. See CATECHETICS. But in Augustine's use, the word Catechism means the act of preparatory instruction through which the catechumens went before baptism. In the Middle Ages, Kero of St. Gall (8th century) published the Creed and Lord's Prayer in German, for the instruction of children and ignorant people. Wicliffe also did the same in English, adding the Decalogue. But Luther first gave the name Catechism (1525) to the sum of Christian knowledge made up for elementary instruction into a book. It is possible, however, that the term "Catechism" had been used by the Waldenses before Luther's time in the same sense. See Zezschwitz, *Die Katechismen der Waldenser und böhmischen Brüder* (Erlangen, 1863, 8vo).

II. *The principal Catechisms.*—1. *Lutheran.*—In 1520 Luther published his first Short Catechism, containing a short form of the Creed, the Commandments, and the Lord's Prayer; but his experience of the gross ignorance of the people in religious things, especially as seen by him in his visitations of 1527, led him to prepare Larger and Smaller Catechisms, which afterwards found a place among the symbolical books or standards of the Lutheran churches. They are to be found in Hase, *Libri Symbolici Eccles. Lutheranae* (Lips. 1846), where a brief sketch of their history is given; also in Francke, *Lib. Symb. Eccles. Lutheranae* (Lips. 1847). Translations in German and English are abundant. The *Catechismus Major* was intended for the use of the clergy and schoolmasters, the *Minor* for the use of the people and the children. The *Formula Concordia* calls these Catechisms "quasi laicorum Biblia, in quibus omnia illa breviter comprehenduntur quae in sacra Scriptura fusiis tractantur" (Part I, § 5; also Part II, § 8). The Smaller Catechism is in the form of question and answer; the Larger is not. The contents of the Smaller are: Preface; Chap. I. The Decalogue; Chap. II. The Apostles' Creed; Chap. III. The Lord's Prayer; Chap. IV. The Sacrament of Baptism; Chap. V. The Lord's Supper; Appendix 1. Morning and Evening Devotion; App. 2. Blessing and Grace at Table; App. 3. The Home Table (containing a brief summary of ethics). This arrangement of topics is followed also in the Larger Catechism (omitting the appendices), but more amply treated. The German churches still use Luther's Catechism generally, but not without opposition. See Zezschwitz, *System der christlich-kirchlichen Katechetik* (Leipzig, 1864, 1866, 2 vols. 8vo); Nitzsch, *prakt. Theol.* II, 1, 191, and *Jahrbücher für deutsche Theologie*, x, II, 895 sq. For the various editions of Luther's Catechisms, and the works written upon them, see Walch, *Bibliotheca Theologica*, i, 452 sq.; Winer, *theol. Literatur*, pt. xi, pt. xxvii.

2. *Reformed.*—(1.) *Geneva Catechism.*—Calvin drew up a Catechism in French in 1536; in Latin, 1538 (the *Catechismus Genevensis*). This was revised and published in French in 1541, and in Latin, 1545. Its heads are, 1. Doctrine, or Truth (the Apostles' Creed); 2. Duty (the Decalogue); 3. Prayer (the Lord's Prayer); 4. The Word; 5. The Sacraments. Appended is a form for public prayer and the administration of the sacraments (see *Calvini Opera*, Geneva, 1617, vol. xv, p. 12 sq.; Augusti, *Corpus Libr. Symbolicor.* 460 sq.). It was speedily translated into other languages, and adopted in the Reformed churches of Switzerland, France, Eng-

land, Scotland, Hungary, and the Netherlands. As late as 1578 it was ordered to be used in the University of Cambridge, England. See Köcher, *katechet. Gesch. der reform. Kirche*, Jena, 1756, 8vo, 210 sq.; Bonar, *Catechisms of the Scottish Reformation* (Lond. 1866).

(2.) *Heidelberg.*—The most important of the Reformed Catechisms is that of Heidelberg, compiled by Caspar Olevianus and Zacharias Ursinus, at the request of the Elector of the Palatinate, Frederick III, and published at Heidelberg in 1562. After its approval by the Synod of Dort (q. v.), it became one of the symbolical books of the Reformed Church of Holland, as well as of the German Reformed Church. It may be found in Latin in Augusti, *Libr. Symbolicor.* 532 sq.; in English in many separate editions. The best English version is the *Tercentenary* (N.Y. 4to, 1863); the best German ed. is that of Schaff (Phila. 1866, 18mo). In view of the special importance of this Catechism, it is treated in a separate article. See HEIDELBERG CATECHISM.

3. *Church of England.*—We give the following account from Procter, *On Common Prayer*, chap. v:

"Previously to 1661 the Catechism was inserted in the Order of Confirmation. The title in the Prayer-books of Edward VI and Elizabeth was, *Confirmation, wherein is contained a Catechism for Children*; and in 1604, *The Order of Confirmation, or laying on of hands upon children baptized, and able to render an account of their faith, according to the Catechism following*; with a farther title to the Catechism itself, that is to say, *An Instruction to be learned of every Child before he be brought to be confirmed by the Bishop*. The insertion in the prayer-book of such an authorized exposition of the elements of the Christian faith and practice belongs to the Reformation. English versions and expositions of the Lord's Prayer and Creed had existed in early times. But immediately before the Reformation, it appears that these elements were by no means generally known. The origin of the rubrics about catechizing may be referred to the injunctions issued in 1536 and 1538 (*Strype, Eccl. Mem. Hen. VIII.* i, 42), which ordered the curates to teach the people the Lord's Prayer, the Creed, and the Ten Commandments, sentence by sentence, on Sundays and holydays, and to make all persons recite them when they came to confession (Burnet, *Hist. Ref.* iv, 101, ed. Nares [Records, book iii, No. xi]). As soon as a book of service was prepared, a Catechism was placed in it, that the exposition of these Christian elements might not depend on the care or ability of the curates. This manual still remains in the Prayer-book, with only a few verbal alterations, and the addition of an explanation of the sacraments in 1604. The composition of this latter part is generally attributed to bishop Overall, who was the prolocutor of the Convocation, and at that time dean of St. Paul's. It was added by royal authority, 'by way of explanation,' in compliance with the wish which the Puritans had expressed at the conference at Hampton Court (Cardwell, *Conf.* p. 187), and, with two emendations, was afterwards confirmed by Convocation and Parliament in 1661.

"An intention was formed, in the time of Edward and Elizabeth, to have also another authorized Catechism for the instruction of more advanced students, and especially those in public schools, touching the grounds of the Christian religion. The original of this work is ascribed to Poynt (Orig. Lett. [Park. Soc.] lxxi, *Cheke to Bullinger*, June 7, 1558), who was bishop of Winchester during Gardiner's deprivation. It was published in Latin and in English in 1558, and is supposed to have had the approval of Cranmer, and also of the Convocation which sanctioned the Articles in 1552 (see it reprinted in bishop Randolph's *Enchiridion Theologicum*, vol. i. Both the English and Latin editions are reprinted in *Liturgies, etc., of Edw. VI* [Park. Soc.]). It seems, however, that this was not considered quite satisfactory; nor was it able to supplant the many similar compilations of the foreign Reformers,

which were adopted by many teachers, and occasioned much complaint as to the want of a uniform system of religious instruction (see Hardwick's *Hist. of the Articles*, p. 108 sq.). Of foreign Catechisms there were the Catechism of Erasmus (1647), ordered to be used in Winchester College and elsewhere; the Smaller and Larger Catechisms of Calvin (1638 and 1645), that of Ecolampadius (1545), Leo Judas (1568), and more especially Bullinger (1559). Even in 1578, when the exclusive use of Nowell's Catechisms had been enjoined in the canons of 1571, those of Calvin, Bullinger, and others were still ordered by statute to be used in the University of Oxford (see Cardwell, *Doc. Ann.* i, 800, note). Hence it was agreed by the bishops in 1561 that, besides the Catechism for children who were to be confirmed, another somewhat longer should be devised for communicants, and a third, in Latin, for schools. It is probable that at this time Dean Nowell was employed upon such a Catechism, taking Poyntet's as his groundwork; so that it was completed before the meeting of Convocation (Nov. 11, 1562), by which it was approved and amended, but not formally sanctioned, apparently because it was treated as part of a larger design, which was not realized, viz. to publish Nowell's Catechism, the Articles, and Jewell's Apology in one book 'by common consent to be authorized, as containing true doctrine, and enjoined to be taught to the youth in the universities and grammar-schools throughout the realm.' The Catechism, therefore, remained unpublished until 1570, when it was printed at the request of the archbishops, and appeared in several forms, in Latin and in English. The *Larger Catechism*, in Latin, intended to be used in places of liberal education, is reprinted in Bp. Randolph's *Enchirid. Theologicum*, vol. ii. Its title is 'Catechismus, sive prima institutio, disciplinaque pietatis Christiane, latine explicata.' In the same year it was translated into English by Norton. Also an abridgment of it, called the Shorter or the Middle Catechism, was prepared by Nowell for the use of schools. He also published a third, called the Smaller Catechism, differing but slightly from that in the Book of Common Prayer. It is probable that Overall abridged the questions and answers on the Sacraments from this Catechism (see Churton's *Life of Nowell*, p. 188 sq.; Lathbury, *Hist. of Convoc.* p. 167 sq.). "Cranmer's Catechism was reprinted, London, 1829, 8vo.

Among the numerous commentaries on the Catechism are, Nicholson (Bp.), *An Exposition of the Catechism of the Church of England* (2d ed. Oxf. 1844, 8vo); Beveridge (Bp.), *Church Catechism Explained* (12mo); Nixon (F. R.), *Lectures, Historical, Doctrinal, and Practical, on the Catechism of the Church of England* (8d ed. Lond. 1847, 8vo); Fitzgerald (A. D.), *Short Lectures on the Church Catechism* (12mo); James (J.), *A Comment on the Church Catechism and Occasional Offices, or the Mother's Help* (Lond. 1842, 12mo); Secker (Arp.), *Lectures on the Church Catechism* (12mo); Burnet's *Exposition of the Church Catechism* (8vo). John Wesley says of it: "Our Church Catechism is utterly improper for children of six or seven years old" (*Works*, N. Y. ed. vii, 170).

4. *Presbyterian Church.*—The *Westminster Catechisms*, with the Westminster Confession of Faith, constitute the standards or symbolical books of the Presbyterian churches. They were prepared by committees of the Westminster Assembly; the *Shorter Catechism* was presented to the House of Commons November 5, 1647; the *Larger*, April 5, 1648; and by resolution of September 15, 1648, the Catechisms were ordered printed by authority, for public use. The shorter is not an abridgment of the larger, but the latter is an expansion of the former. They were both adopted by the General Assembly of the Church of Scotland in 1648. The Shorter Catechism "has been, and still is, in almost universal use among Presbyterians speaking the English language, and to a consid-

erable extent among Independents and Congregationalists both in Britain and America. In Holland, also, a translation of it has been much used. It is very generally regarded, by those whose doctrinal views are in accordance with it, as an admirable compend of Christian doctrine and duty. The authorship of the Westminster Assembly's Catechisms has been the subject of much debate, or at least the authorship of the first drafts of them, it being admitted that they were prepared with great care by committees of the Assembly. But the probability appears to be that their authorship is to be ascribed entirely to these committees, and that, like the Westminster Confession of Faith, they are thus the result of the joint labors of many. From discoveries recently made by Dr. M'Crie, it seems probable that at least the plan or scheme of the Shorter Catechism is to be ascribed to Mr. Palmer" (Chambers, s. v.).

There are numerous editions of the Catechisms; the latest are those of the *Presbyterian Board of Publication* (Philadelphia). They teach the Calvinistic theology. Among the many commentaries on the Catechisms, we name Green (Ashbel), *Lectures on the Shorter Catechism* (Phila. 1841, 2 vols. 8vo); Belpage, *Exposition of the Assembly's Catechism* (Lond. 2 vols. 12mo); Fisher, *Exposition of the Assembly's Catechism* (Lond. 1849, 12mo); Paterson, *The Shorter Catechism* (Lond. 1841, 12mo); Vincent, *The Catechism Explained* (Lond. 1848, 18mo); Boyd, *The Westminster Shorter Catechism* (N. Y. 1849, 18mo).

5. *The Methodist Church.*—In the Wesleyan Methodist Church, in England, the Catechisms in use are three, arranged in gradation, for pupils of different ages, by the Rev. Richard Watson. They are printed as *The Wesleyan Methodist Catechisms*. For many years these Catechisms were used also in the Methodist Episcopal Church in the United States, together with *A Short Scriptural Catechism*, prepared by the Rev. J. Edmondson (?). In 1848 the General Conference ordered the preparation of a Church Catechism, which was undertaken by the Rev. Dr. Kidder (then Sunday-school Editor), who, with the aid of other divines, prepared a series of Catechisms which were approved and adopted by the General Conference of 1852. They are published as *Catechisms of the Methodist Episcopal Church*, No. 1, 2, 3 (New York, Methodist Book Room). The series does not consist of three separate Catechisms, but of one, in three stages of development, the language of the basis being unchanged in the different numbers of the series. No. 1 is the Catechism; No. 2 is the same, with the addition of numerous Scripture proofs and illustrations printed side by side with the several questions and answers; No. 3 expands the answers of No. 1 and the proofs of No. 2 into something like a system of Christian doctrine in a condensed form. The Catechism proper is taken up section by section, and a *summary* is given, in comprehensive language, of the subject-matter of each section. Then follow an analysis of the section, a number of explanatory and practical questions, and a set of definitions. The outline of topics is as follows: I. GOD: § 1. His Nature and Attributes; § 2. The Persons of God. II. CREATION: § 1. The World; § 2. MAN. III. MAN'S FALL AND SINFUL STATE: § 1. Sin; § 2. Guilt, Prevalence, and Consequences of Sin. IV. SALVATION: § 1. The Source and Grounds of Salvation, viz.: The Love of God in Christ, and Redemption through Christ; § 2. Conditions of Salvation; § 3. The Fruits and Extent of Salvation. V. THE MEANS OF GRACE: § 1. The Church and Ministry; § 2. The Sacraments: (1.) *Baptism*; (2.) *The Lord's Supper*; § 3. The Word of God and Prayer. VI. GOD'S LAW: Duties to God and MAN. VII. OF DEATH, JUDGMENT, and ETERNITY. APPENDIX: The Beatitudes; The Lord's Prayer; The Ten Commandments; The Apostles' Creed; Baptismal Covenant; Examples of Prayers for the Young.

6. *The Church of Rome.*—In the Church of Rome the Tridentine Catechism (*Catechismus Romanus*) is a book of symbolical authority. It was prepared in obedience to a decree of the Council of Trent (Sess. 24, de Ref. c. 7), by archbishop Leonardo Marino, bishop Egidius Foscarelli, and the Portuguese Dominican Francisco Fureiro, with the aid, as later writers (e. g. Tiraboschi) conclude, of Muzio Calini, archbishop of Zara; revised by cardinals Borromeo, Sirlet, and Antonian; and sanctioned by Pope Pius V. It was published at Rome in 1566, the Latin version being either by Paulus Manutius or Poggianus. The Council of Trent had ordered (l. c.) that the Catechism, when prepared, should "be faithfully translated into the vernacular languages, and expounded to the people by all pastors." It was subsequently approved by special bulls, and adopted by votes of provincial synods in the various Roman Catholic countries. It consists of four parts: the Apostles' Creed, the Sacraments, the Decalogue, and the Lord's Prayer. It is one of the standards of doctrine in the Church of Rome, though the Jesuits deny its symbolical authority. Möhler refuses to it the character of a "public confession," but admits "the great authority which undoubtedly belongs to it" (*Symbolism*, Introduction, p. 106; see Elliott, *Delineation of Romanism*, bk. i, ch. i; Cramp, *Text-book of Popery*, ch. xxii). The Catechism is not fitted for the instruction of children, but is a manual for the use of pastors. It was not originally in the form of question and answer, but some of the later editions took that shape. There is an English translation by Dr. Donovan, of Maynooth College (Dublin, 1829; Baltimore, n. d. 8vo). Cramp remarks of this translation that it "suppresses or alters such passages as express the peculiar tenets of popery in too open and undisguised a manner," and furnishes proofs of the charge (*Text-book of Popery*, p. 430). Besides the *Catechismus Romanus*, numerous other Catechisms have appeared within the Church of Rome from time to time. The most important are those of Canisius (q. v.), the Jesuit (1554 and 1566), which have been largely used from that time to this, especially in Germany; and that of Bellarmine (1603), and of Bossuet (1687). On recent Roman Catholic Catechisms, as compared with Canisius, see *Theologische Quartalschrift*, 1863, III, p. 448.

7. *The Greek Church.*—Palmer (in Herzog, *Real-Encyclop.* a. v. *Catechismus*) remarks that the only Church without an authorized Catechism is the Greek Church. But a Catechism prepared by Mogilas, metropolitan of Kiev (1642), was recognised by a synod of Jerusalem (1672) as a standard.

8. *Socinianism.*—1. The *Cracovian Catechism* was drawn up by Schomann, 1574, for the Polish churches; it is made up chiefly of verses of Scripture. 2. The Catechism of *Faxatus Socinus* was published at Racovia, 1618, in an unfinished form, owing to the death of Socinus, under the title *Christ.-Relig. brevissima institutio*, etc. 3. The *Racovian Catechisms*, larger and smaller, composed by Moscorovius, a Polish nobleman, and Schmalz, a Socinian minister (Latin, Racovia, 1609, 12mo; new ed. by Crellius, 1630, 4to; and another, with refutation, by Eder, Frankfurt and Leips. 1789, 8vo; English translation by Rees, Lond. 1818, with preface, treating of the literary history of the Catechism).

There have been many Catechisms prepared by individuals and used in various countries and churches, but as none of them have been clothed with symbolical authority, we do not attempt to give a list of them.—Smith's *Hagenbach, Hist. of Doctrines*, § 226; Shedd, *Hist. of Doctrines*, II, 457-498; Smith's *Gieseler's Ch. History*, vol. iv, § 81; Augusti, *Corpus Libr. Symbol. Reform.* (Ubert. 1827, 8vo); Winer, *Theol. Literatur*, § xxvii; Walch, *Bibliotheca Theologica*, vol. i, ch. iv; Herzog, *Real-Encyclopädie*, vii, 454 sq.; *Zeitschrift für histor. Theologie*, 1866, p. 300.

Catechist, i. e. *catechizer*, in the ecclesiastical sense, one who teaches religion to children, or neophytes, catechetically. For the derivation, see *CATECHETICS*, 1. (1.) At first it was the office of the bishop to prepare the catechumens for baptism, as well as to admit them into the Church by that sacrament. But in course of time it became impossible for the bishops to devote the requisite attention to this part of their work, and consequently they transferred it to such presbyters and deacons as they deemed competent to the undertaking. They were called *catechetai*; and their employment was considered peculiarly honorable, as requiring the possession and use of eminent talents and qualifications. But there never was a separate office or order of catechists in the Church; the work was only a function, assigned, as need arose, to persons capable of it. Cyril of Jerusalem and Chrysostom (*Hom.* 21 ad pop. Antioch.) were originally catechists. They were sometimes called by a figurative name, *ναυτολόγοι*, that is, those whose office it was to admit passengers to the ship, and contract with them for the fare. The Church, by a well-known figure, was compared to a ship; the bishop was *ὁ πρῶτος*, the pilot; the presbyters, *οἱ ναῦται*, the mariners; the deacons, *οἱ τοῖχαρχοί*, the chief rowers; the catechists, *οἱ ναυτολόγοι*. It was properly the catechists' duty to show the catechumens the contract they were to make, and the conditions they were to perform, in order to their admittance into the Christian ship. The deaconesses were also catechists to the more ignorant and rustic women-catechumens, which proves that catechists were not necessarily of the clerical order. Origen, when only eighteen years of age, and consequently when incapable of being ordained a deacon, was appointed a catechist (Eusebius, *Hist. Eccles.* vi, 3).

(2.) In the modern churches, ministers are generally required by Church law to be catechists (i. e. for the instruction of children); and since the growth of the Sunday-school (q. v.), the Sunday-school teachers are, or ought to be, all catechists.—Farrar, *Eccles. Dict.* s. v.; Bingham, *Orig. Eccles.* bk. iii, ch. x; Coleman, *Christian Antiq.* ch. iv, § 8; Krause, *Catechismus primitivæ ecclesiæ* (Lips. 1704); Siegel, *Alterthümer*, p. 340.

• *Catechumens*, in the ancient Church, candidates for baptism, who were placed under a course of religious instruction in order to their admission into the Church. For the derivation, see *CATECHETICS*, 1. They are classed by ancient writers as members of the Church, but the lowest order of members (e. g. Origen, Eusebius, Jerome; cited by Bingham, bk. i, ch. iii).

1. *Names.*—Besides the name catechumens, they were called candidates (*candidi*), because they were accustomed to appear dressed in white on their admission to the Church. They were also called *novitiani*, *tyrones Dei*, *rudes*, *incipientes* (e. g. by Tertullian, *De Patient.* c. vi.; and by Augustine, *De Fide ad Catechum.* lib. II, cap. i).

2. *Admission to the Catechumenate.*—Heathens were admitted to the catechumenate by the imposition of hands and prayer, with the sign of the cross. The children of believers were admitted as soon as they were of age to receive instruction, but there does not appear to have been any specific age fixed at which Jewish and heathen converts were considered as catechumens. The greater part were of adult age; even Constantine the Great was in this class. But it was essential that they should not have been baptized.

3. *Period of the Catechumenate.*—The time spent in preparation varied according to the usages of various churches, and particularly according to the proficiency of each individual. In the Apostolical Constitutions three years are enjoined; by the Council of Eliberis, A. D. 678, two years; by that of Agatha, A. D. 506, eight months. Sometimes the catechumenate period was limited to the forty days of Lent. Socrates observes that, in the conversion of the Burgundians, the

French bishop who converted them took only seven days to catechise them, and then baptized them. But, in case of sickness or imminent death, the catechumens were immediately baptized with what was called clinic baptism. Cyril of Jerusalem and Jerome direct the catechumens to observe a season of fasting and prayer forty days.

4. *Classes of Catechumens.*—They were early divided into separate classes, the number and names of which were somewhat different. The Greek canonists, followed by Beveridge, Cave, and others, among the moderns, speak of the *ἀρελιότεροι*, the *uninitiated*, and the *τελειότεροι*, the *more advanced*. Suidas distinguishes them as *ἀκροῦμενοι*, such as were occupied in learning, and *εὐχόμενοι*, such as are engaged in devotional pursuits. Bingham specifies four classes: First, the *ἐξουθούμενοι*, or those who were instructed privately without the Church, and kept at a distance from the privilege of entering into the Church for some time, to make them the more eager and desirous of it. The next degree above these were the *ἀκροῦμενοι*, *audientes*, or hearers. They were so called from being admitted to hear sermons and the Scriptures read in the Church, but were not allowed to partake of the prayers. The third sort of catechumens were the *γονυκλινοῦντες*, *genu-flectentes*, or kneelers, so called because they receive imposition of hands kneeling upon their knees. The fourth order was the *βαπτιζόμενοι*, *φοριζόμενοι*, the *competentes* and *electi*, which denote the immediate candidates of baptism, or such as were appointed to be baptized the next approaching festival, before which strict examination was made into their proficiency under the several stages of catechetical exercises. The age, sex, and circumstances of the catechumens were duly observed, men of age and rank not being classed with children (*Antiquities*, bk. x, ch. ii, § 2).

5. *Instruction and Admission to the Church.*—The exercises of the parties till their union with "the believers" were generally directed with reference to their preparation for baptism. They were required to attend to various doctrinal and catechetical instructions, to reading the Scriptures, etc. One of Chrysostom's homilies (ad 2 Cor. 2) is an exposition of the prayer of the Church for the catechumens (see Neander, *Life of Chrysostom*, tr. by Stapleton, Appendix to vol. i). That part of divine service which preceded the common prayers of the communicants at the altar, that is, the psalmody, the reading of the Scriptures, the sermon, etc. was called *missa catechumenorum*, because the catechumens had the liberty of being present only at this part of the service. The advanced classes before baptism were subjected to repeated examinations, and, in later times, to a kind of exorcism, accompanied by the imposition of hands; they received the sign of the cross, and insufflation, or the breathing of the priest upon them. They also passed many days in fasting and prayer, and in learning the Apostles' Creed and the Lord's Prayer. Some days before baptism they were required to wear a veil. Their mode of admission was simple. The bishop examined the candidate, and, if he was found worthy, enrolled his name in the records of the Church. The solemnity was concluded by prayer, by the imposition of hands, and by the signing of the cross.

"No such arrangement as the catechumenate is indicated in the New Testament: when an individual professed faith in the Lord Jesus Christ, he was immediately admitted to the initiatory rite of Christianity. All converts then, however they might differ in their knowledge or attainments, were equally entitled to the outward sign, as they were to the inward and spiritual grace. But when the Church was augmented by the accession to her pale of large numbers from heathenism, and when her purity was no longer guarded by the presiding care of those apostles and others who possessed the power of discerning spirits, the custom of deferring the admission of members was adopted, in

order to obtain satisfactory evidence of their fitness to be enrolled in the rank of the disciples. The experience of the primitive Christians had taught them that the gross habits of idolaters were not at once relinquished for the pure and spiritual principles of the Gospel, and that multitudes of professed believers held their faith by so slender a tie that the slightest temptation plunged them again into their former sensuality. The protracted inquiry into the character and views of candidates for admission into the Church was therefore designed, if possible, to prevent the occurrence of apostasies, which had disturbed the peace and prosperity of the Church, and may be traced to a laudable desire of instructing young and uninitiated converts in the principles of the Christian faith."

In modern Christian usage, the words *catechumen*, *catechumenate*, are not found in the books of Church law, except with historical reference to the ancient Church. But the things designated by these terms have always existed, and the terms themselves appear likely (and very properly) to come into use again, to designate the children of the Church and their period of instruction preparatory to confirmation, in the churches which use that rite, and preparatory to communion in full membership, in those churches which do not. In the Methodist Church in England the term has been revived, especially in the efforts of the Rev. S. Jackson to establish a fixed method and course of instruction for young persons between childhood and puberty (see the volumes of the *Catechumen's Reporter*, London). The whole subject is also carefully discussed by Zeszchwitz, *System d. christl.-kirchl. Katechetik* (Leips. 1862, i, 79 sq.).

See the copious treatment of the ancient catechumenate by Bingham, *Origines Ecclesie*, ch. x; and Coleman, *Ancient Christianity*, ch. vii, sec. vi, § 7. See also Siegel, *Alterthümer*, i, 864 sq.; Pfanner, *De Catechumenis*, *Antiqua Ecclesie* (Frankfurt et Gotha, 1688, 4to); Farrar, *Ecclesian Dictionary*, s. v.; Buck, *Theol. Dictionary*, s. v.; Neander, *Church History*, i, 805; and the article ARCANI DISCIPLINA.

Catēna (*a chain*), in Biblical criticism, is an exposition of a portion of the Scriptures, formed of collections from various authors. Thus we have *Catēse* of the Greek fathers by Procopius, by Olympiodorus, and by Nicephorus, on several books of the Old Testament. Poole's *Synopsis* may be regarded as a *catēna* of modern interpretations of the Bible. The ancient *catēnae* seem to have originated in the short scholia, or glosses, which it was customary in manuscripts of the Scriptures to introduce in the margin. These, by degrees, were expanded, and passages from the homilies or sermons of the fathers were added. The most celebrated *catēna* is the *catēna aurea* of Thomas Aquinas, which was translated at Oxford under the superintendence of Mr. J. H. Newman. The subsequent conduct of Mr. Newman has led those who were willing to attach some authority to that work to examine it carefully, and the result has been the detection that Thomas Aquinas has sometimes modified the quotations he has made from the fathers; and the whole, as a commentary, is inferior to the commentaries of modern theologians (Farrar, *Ecl. Dict.* s. v.; Hook, *Ch. Dictionary*, s. v.).

The application of this name to works of this sort has been attributed to Thomas Aquinas in consequence of the above collection on the four Gospels; but that it is of later invention appears from the fact that the older editions of this work bear the title of *glossa continua*, according to what was the customary phraseology of the time, and that Thomas himself, in his dedication to Pope Urban IV, calls his work *continua expositio*. The early names for these among the Greeks were *ἐπιτομὰ ἐρμηνειῶν*, *συναγωγὰ ἐξηγησιῶν*, *σχόλια ἀπὸ διαφόρων ἐρμηνειῶν*, etc., which are more justly descriptive of their contents than the later names *χρυσὰ κεφάλαια* and *σειραί*. These *catēnae* are

of different kinds. "Sometimes the words of the fathers from whom they were compiled are presented in a mutilated state, and not as they were originally written. Sometimes the bare exposition is given, without the reasons by which it is supported. Sometimes we find that the opinions of different writers are confounded, that being assigned to one which properly belongs to another. By far the greater number appear to have been hastily and negligently made, with so many omissions, corruptions, and errors that they cannot be relied on" (Davidson, *Hermeneut.* p. 156). All are not alike in the method of their arrangement, nor are all equally skillfully or neatly arranged. They vary, also, according as the writers from whom they are drawn were attached to the grammatical, the allegorical, or the dogmatic principle of interpretation; and sometimes the compiler's own inclination in this respect gives a character to his work. The use of these catenæ is, nevertheless, considerable, as they preserve to us many fragments of Aquila and the other versions of the Hexapla; as they contain extracts from the works of interpreters otherwise unknown to us, and as they occasionally supply various readings.

The number of these catenæ is considerable; many yet remain in MS. Of those that have been printed may be mentioned: *Catena Gr. Patrum in beatum Job, collectors Niceta*, ed. Pat. Junius (London, 1687, fol.); *Symbolarum in Matthæum tonius prior exhibens Catenam Gr. Patrum æzæ*, edit. P. Possinus (Tolos. 1646, fol.); *Epist. tonius alter quo continetur Catena PP. Gr. æzæ*, interpret. Balth. Corderius (Tolos. 1647, fol.); *Catena Gr. PP. in Evang. sec. Marcum* collect. atque interp. P. Possinus, etc. (Rom. 1678, fol.); *Catena lev Gr. PP. in Lucam, quæ simul Evang. introducit explicatorem, lucæ et latinitate donata*, etc. a B. Corderio, Antw. 1628, fol.); *Catena PP. Gr. in Joannem ex antiquiss. Gr. codicibus in lucem*, ed. a B. Corderio (Antw. 1630, fol.); *Catena Gr. PP. in Nov. Test.* ed. J. A. Cramer (Oxon. 1844, 8 vols. 8vo). To this class belong also the commentaries of Theophylact, Euthymius Zigabenus, Eucumenius, Andreas, Arethas, Bede, Aquinas, etc.

The introduction of this class of commentaries has been assigned to Olympiodorus by Wolf and others, but this cannot be substantiated; still less can the opinion of those who would ascribe it to Procopius Gaza. It is probable that the practice of compiling from the great teachers of the Church grew up gradually in the later and less enlightened ages, partly from a feeling of veneration for these earlier and brighter luminaries, partly from inability to furnish anything original on the books of Scripture. It was a season of night, when those who sought after truth felt that even reflected lights were a great blessing (see Simon, *Hist. Crit. des princ. Commentateurs de N. T.* c. 80, Ittigius *de bibliothecis et catenis patrum* [Lips. 1708]; Fabricius, *Bibl. Gr.* vii, p. 728; J. C. Wolfius, *Exercitatio in cat. PP. Gr.* reprinted in Cramer's *Catena in N. Test.* i; Noesselt, *De Cat. PP. Gr. in N. T.* [Opusc. iii, 825 sq.]; Cramer's *Præfatio* to his edition of the Catenæ).—Kitto, *Cyclopædia*, s. v. See COMMENTARY.

Caterpillar is the rendering in the Auth. Vers. of two Heb. words: 1. Invariably of כְּסִיל, *chasil* (occurs 1 Kings viii, 87; 2 Chron. vi, 28; Psa. lxxviii, 46; Isa. xxxiii, 4; Joel i, 4; ii, 25). 2. Occasionally (Psa. cv, 84; Jer. li, 14, 27) of כְּסִיל, *ge'lek*, elsewhere "canker-worm" (q. v.).

The English word *caterpillar* belongs strictly to the larvæ of the genus Lepidoptera, and more especially to the larvæ of a section of it, the *Papilionida*. It is, however, far from proved that the *chasil* is any species of caterpillar. The root כְּסִיל, *chasal*, signifies to "consume" or "devour," and it is especially used to denote the ravages of the locust (Deut. xxviii, 88). The word βροῦχος, by which it is frequently rendered in the Sept., from βρώσκω, "I eat up," conveys also the idea of ravenousness. The Arabic and Syriac

terms also indicate a creature whose chief characteristic is voracity, and this attaches to all the species of locusts. The ancients, indeed, concur in referring the word to the locust tribe of insects, but are not agreed whether it signifies any particular species of locust, or is the name for any of those *stades* or *transformations* through which the locust passes from the egg to the perfect insect. The Latin fathers take it to mean the larvæ of the locust, and the Greek understand it as the name of an adult locust. The Latins give the name *bruchus* to the young locust before it has wings, call it *attelabus* when it begins to fly, and *locusta* when it is fully able to fly. The superior antiquity, however, of the Sept. entitles its opinion to preference, and in some passages it ascribes *flight* to the βροῦχος, and speaks of it as a distinct species; and in the former particular, especially, it is difficult to suspect it of an egregious error. The statement of Aristotle is also worthy of notice, who speaks of the *attelabus* as a mature insect, for he refers to its parturition and eggs (*Hist. An.* v, 29). The arguments and speculations of the most eminent modern writers may be seen in Bochart, *Hieroz.* ed. Rosenmüller, iii, 256 sq. (Lips. 1798-6).—Kitto, s. v. CHASIL. See LOCUST.

Cathari (καθαροί, pure) or CATHARISTS (q. d. Puritans), a name applied at different times in Church history to different sects; all, however, characterized by aiming at, or at least pretending to, peculiar purity of life and manners. 1. It was assumed by the Novatians in the third century, who excluded from the Church all who fell into sin after baptism. See NOVATIANS. 2. The name of Cathari was also given in the twelfth century to the sects of the Albigenses, Vaudois, Patari, and others. The Roman Catholic historians abound in frightful accounts of the heresies and immoralities of all these sects, to whom they attributed all the bad men and bad deeds of their times. Some modern Protestant writers, yielding too ready credence to the Roman historians, treat of the Cathari as if they were all dualists, if not Manichæans. The truth seems to be that the origin of most, if not all, of the sects above named is to be sought in circumstances of general operation, and principally in a prevailing sense of the corruptions of the dominant Church, and of her perversions of Gospel truth. That some of the sects thus originated professed dualistic doctrines is not to be doubted; that all were corrupt in doctrine and life is probably an invention of their persecutors. See ALBIGENSES.

I. *History*.—The origin of the Cathari is unknown; the name itself, however, is Greek, and indicates an Oriental origin. That an earnest spirit of protest against the corruptions of Rome arose in Western Europe during the Middle Ages, and manifested itself especially about the thirteenth century, is certain; but the doctrines and some of the rites of the really dualistic Cathari were doubtless derived from the East. It was formerly thought that the Cathari were lineal descendants of the Manichæes of the third and fourth centuries; but this view is now abandoned. There is no subtle religious philosophy like that of the Manichæans found among the Cathari; their whole system was popular rather than mysterious. "According to the Manichæes, the creation is the result of the union of the soul of the world with matter, while the Cathari taught that the whole material creation was exclusively the work of the evil principle. Above all, there is among them no trace of the profound personal reverence for Manes, and worship of his memory, which was one essential characteristic of the genuine Manichæes, who looked upon their founder as the Paraclete promised by Jesus to his disciples. The Priscillianists succeeded the Manichæes in the West, and the Paulicians in the East; yet these latter, properly Syrian Gnostics, execrated Manes. The Paulicians were thought by Mosheim, Gibbon, and Maitland to have been the immediate religious ancestors of the Cathari. It is

well known that numbers of those religionists were transplanted into Thrace by Constantine Copronymus about the middle of the eighth century. Yet the Paulicians had no rites or ceremonies whatever, no ecclesiastical or hierarchical organization; they were strangers to ascetic abstinence from animal food, and did not condemn marriage. Such radical differences as these will not allow us to suppose the heterodox movement of Southern and Western Europe to have been a simple transplantation of Asiatic Paulicianism, though this sect may have contributed in some measure—more or less directly—to the formation of Catharism. The fact seems to be that Dualism manifested itself in Christendom at different periods under various successive and independent forms" (*Lond. Quart. Review*, iv, 10). Schmidt assigns it a Slavonic origin (South Macedonia), and ascribes its introduction into Italy to Macedonian traders. The first Cathari in Italy were found about A.D. 1035 near Turin, and their chief and others were burned. By the twelfth century they were established at various points, from Upper Italy to Calabria. A Romanist writer has recently sought to show that Dante was a Catharist (Aronz, *Dante hérétique*, Paris, 1854; and *Chef de la Comédie Anti-catholique de Dante Alighieri*, Paris, 1856). In the thirteenth century, Pungilovo, said to have been a Catharist, but a man of eminent charity and goodness, came near being canonized by the Roman Church. See CANONIZATION. The greatest successes of the Catharists in Western Europe were in the south of France, where they were either identical with the Albigenses, or confounded with them. See ALBIGENSES. During the twelfth century they, and all other dissidents from Rome, suffered grievous local persecutions; but there "had been no general, persevering, systematic attempt to exterminate them. Meantime they had spread from Constantinople to Spain; they were masters in the Slavonic provinces which now form the north-east of Turkey; they were formidable in Lombardy; they had audaciously insinuated themselves into the pontifical city itself; above all, the only transalpine nation that had emerged from barbarism had almost thrown off its allegiance to Rome; heresy sat enthroned in a central region, whence, in one generation, it could spread over France, Spain, and Italy. The Church was in peril; but the year 1198 witnessed the beginning of a pontificate in which an iron will was to put forth in her service all the resources of rare intrepidity, unremitting vigilance, and far-seeing sagacity. Innocent III was the very incarnation of the idea of the papacy; he was distinguished by precisely the sort of character and talents which were qualified to effect the purposes of the hierarchy of which he was the head." During his pontificate, the cruel crusades against the Albigenses and Cathari, which have made the names of Innocent and Dominic notorious in history, swept away thousands of Catharist Dualists and of simple-minded Albigenses together. See ALBIGENSES. There were congregations of them enough to constitute whole dioceses in the thirteenth century; but the Inquisition, directed by Innocent III, and established by the Council of Toulouse, 1229, for the search and suppression of heresy, pursued them relentlessly; so that after the fourteenth century no traces of them are to be found.

II. *Doctrines*.—The heretical Cathari held to Dualism, i. e. to God as the original good, and to an evil principle as the author of evil. This is a simple, and, to an uneducated mind, a natural solution of the problem of the origin of evil. The absolute Dualists held that the evil principle was an original one as well as the good. The struggle between them is eternal. "It was believed that some souls had never been created by the evil being, and, of course, would never be saved. Such were all atrocious criminals, tyrants, persecutors, enemies of God and of his Church. Others, created by the good God, had been seduced from the heavenly world above by Satan, who disguised himself, for the

purpose, as an angel of beauty and light. These were condemned to expiate their offence in earthly bodies, and to pass from one body to another, sometimes even, as an additional punishment, assuming the shape of animals, until, at last, they should obtain deliverance from their terrestrial hell by being admitted into the true Church. The *consolamentum* (see below) reunites the exiles to their guardian angels (called 'Holy Ghost' or 'Paraclete'), of whom there is a distinct one for every soul of heavenly creation. St. Paul, in particular, had successively inhabited thirty-two bodies. Of course there was to be no real resurrection."

The majority of the Cathari held to a more moderate form of Dualism. Of this class were the Bogomiles (q. v.) in Slavonia and the East; and in Italy, the Concorensians or Concorezenses, so called from a corruption of the name of the town Coriza, in Dalmatia. They held to one God, who created matter from nothing; but the arrangement of matter into the existing form of the visible world, in which so much evil exists, was due, not to God, but to a fallen spirit—an exceedingly mighty angel, who seduced a third of the heavenly host. The absolute Dualists held that all souls came to the earth at once; the Concorensians maintained that Adam and Eve were created (their bodies by the evil power, their souls from God), and that all souls are derived from them. Hence the metempsychosis of the absolute duality had no place in their system. The Word of God, both in the O. T. and N. T., was interpreted by the Catharists to suit their dualistic theory. Jesus Christ, the highest of created beings, was sent from heaven to teach the captive spirits the secret of setting themselves free from the chains of matter and of evil. He came in an ethereal body, which had only the appearance of the human form; for, as he said of himself, he is "from above" (John viii, 28), or, as St. Paul said, "from heaven" (1 Cor. xv, 47). He expressly denied having inherited anything from his mother (John ii, 4). He had but the likeness of flesh (Rom. viii, 8; Phil. ii, 8). It was for this reason that he could walk upon the water; and this was the glory revealed on the Mount of Transfiguration. His death, not being real, was but an apparent triumph of the evil one.

In *Ethics*, all classes of Cathari held that sin is "the lust after the created." The world, as the work of the evil one, is evil, and all contact with it leads to sin. Among mortal sins were wealth, war, killing of animals (except fish), carnal connexion, whether in or out of wedlock (inasmuch as it increases the number of fallen souls). Purification from sin was to be obtained by renouncing the world and entering the Church of the Cathari, out of which salvation could not be had.

III. *Usages*.—The various sects of Cathari agreed very generally in their usages, however they might differ in doctrine. There were two classes of members, the *perfect* (perfecti) and simple *believers* (credentes). The former were admitted by the "spirit-baptism," called the *consolamentum*, the ceremony being a simple imposition of hands. (Water baptism was rejected.) By the imposition of hands the Holy Ghost was said to be imparted, and the recipient became one of the *perfect*. To this class belonged the authority of the Church; they administered its rites, and governed it as successors of the apostles. A manuscript in the Romance language was discovered in 1851, and is now in the *Palais des Arts* at Lyons. It was published by Cunitz, Jena, 1852; also in the *Strasburger Beiträge z. d. theol. Wissenschaften*, vol. iv, 1852. It contains a short liturgy, beginning with the Lord's Prayer, the Doxology, and the first seventeen verses of St. John's Gospel in Latin. Then follow in Provençal, first, an act of confession; secondly, an act of reception among the number of *believers*; thirdly, an act of reception among the number of *Christians* or *Perfects*; fourthly, some special directions for the faithful; and, lastly, an

act of consolation in case of sickness. The formula for the act of confession terminates with the following prayer :

O thou holy and good Lord, all these things which happen to us, in our senses and in our thoughts, to thee we do manifest them, holy Lord ; and all the multitude of sins we lay upon the mercy of God, and upon holy prayer, and upon the holy Gospel ; for many are our sins. O Lord, Judge and condemn the vices of the flesh ; have no mercy on the flesh born of corruption, but have mercy on the spirit placed in prison, and administer to us days and hours, and genuflections, and fasts, and orisons, and preachings, as is the custom of good Christians, that we may not be judged nor condemned in the day of judgment with felons.

The first degree of initiation, or the act of reception into the number of believers, is called "the delivery of the orison," because a copy of the Lord's Prayer was given to the neophyte. It begins thus :

If a believer is in abstinence, and the Christians are agreed to deliver him the orison, let them wash their hands, and the believers present likewise. And then one of the *bons hommes*, the one that comes after the elder, is to make three bows to the elder, and then to prepare a desk (*desce*), then three more bows, and then he is to put a napkin (*touail*) upon the desk, and then three more bows, and then he is to put the book upon the napkin, and then let him say the *Benedicite, parviti nobis*. And then let the believer make his salute, and take the book from the hand of the elder. And the elder must admonish him, and preach from fitting testimonies (that is, texts). And if the believer's name is Peter, he is to say, "Sir Peter, you must understand that when you are before the Church of God, you are before the Father, and the Son, and the Holy Ghost. For the Church is called 'assembly'; and where are the true Christians, there is the Father, the Son, and the Holy Ghost."

The final initiation, or *consolamentum*, is called "the baptism of the Spirit." Here is an extract from the formula of its celebration :

Jesus Christ says, in the Acts of the Apostles, that "John surely baptised with water; but ye shall be baptised with the Holy Ghost." This holy baptism of imposition of hands wrought Jesus Christ, according as St. Luke reports; and he said that his friends should work it, as reports St. Mark: "They shall lay hands on the sick, and they shall receive good." And Ananias wrought this baptism on St. Paul when he was converted. And afterwards Paul and Barnabas wrought it in many places. And St. Peter and St. John wrought it on the Samaritans. . . . This holy baptism, by which the Holy Spirit is given, the Church of God has had it from the apostles until now; and it has come down from *bons hommes* to *bons hommes*, and will do so to the end of the world.

The *perfecti* were bound to special fasting and abstinence—from property, and from marriage. They had signs by which their persons, and even their houses, could be recognised by the initiated. Rainerius (who apostatised from Catharism to the Church of Rome) estimated the number of "the perfect" at about 4000 in all Europe. The *credentes*, or simple believers, were not subject to the special restrictions named above, but were bound to confession to their ministers, and to seek the *consolamentum* before death, as essential to salvation unattainable by the great mass of mankind. With them, quite as much as with the Roman Catholics, salvation was made to depend upon adhesion to a given religious community; and as the auditors generally put off receiving the *consolamentum* to the hour of death, this ceremony became invested with a magical virtue, like the sacraments of the dominant Church.

Their religious services were entirely free from the pomp and display of the Established Church. The places of worship were destitute of ornaments, crosses, and images; at one end was a simple table, covered with a cloth, on which lay the New Testament. Worship consisted of reading the Scripture, exposition of it, and prayer. They rejected the baptism of the Church of Rome both because the hierarchy was not the true one, and because water was created by the evil god; and yet, with some inconsistency, they substituted the blessing and breaking of bread, without wine, for the Romish eucharist.

The excellent writer in the *London Review*, whom we have cited, makes the following just remarks upon the source of the false views of the Cathari, as existing in all ages: "Is there no overt Manichæism displayed in our own day in the false asceticism of the Puseyite; and if there be no latent Manichæism in the views of

the extremely opposite section of Protestants, whence the tendency to treat human nature as intrinsically evil, not as merely subjected to evil; to make human powers, physical and mental, evil in their use, and not merely in their abuse; to identify society and its institutions with 'the world,' against which the Christian is forewarned? No; however it may disguise itself, and however its manifestations may be varied, that has ever been one and the same instinct of self-justification, hidden in the recesses of the heart, which treats sin as a something external to the will, and, to a certain extent, inevitably imposed; which makes holiness and faithfulness to God consist in something easier than the abdication of the idol self. This insidious instinct stops at no sacrifices provided it can maintain itself. It inspired the stern 'Touch not, taste not, handle not,' of the earliest Gnostics of the apostolic times (Col. ii, 21); and it has worked, with more or less intensity, in every age of the Christian Church."

IV. *Literature*.—The Roman sources are Bonacorsi, in D'Achery, *Spicil.* i, 208; Moneta, *adv. Catharos et Valdenses* (Rom. 1743); Rainerius (about 1250), whose account is analyzed by Maitland, *Facts and Documents on the History, etc. of the Albigenses and Waldenses* (Lond. 1882). The recent writers are Neander, *Ch. Hist.* iv, 565 sq.; Maitland (as above); Schmidt, *Hist. et Doct. de la Secte des Cathares* (Par. 1849, 2 vols. 8vo); Hahn, *Geschichte d. Ketzer in Mittelalter* (Stuttgart, 1845-47). See also *London Review*, April, 1855, art. i; Gieseeler, *Ch. History*, ii, § 84, 87; Hahn, in *Studien u. Kritiken*, 1852, Heft. iv.; Schmidt, in *Herzog's Real-Encyclopædie*, vii, 461 sq.

Catharine, the name of several so-called *saints* of the Greek and Roman churches.

1. A martyr, who suffered at Alexandria under Maximin II. The Greek and Roman accounts, which are not at all to be depended on, state that she was a rich and noble lady, who, having entered upon a disputation with certain heathen philosophers at the command of Maximin, and vanquished and converted them to the faith, was, together with them, put to death. She is said to have been put upon an engine made of wheels armed with spikes to lacerate her body, but when the machine was put into motion her bonds were miraculously broken, but she was immediately beheaded. Hence the name of *Catharine-wheel*. Eusebius (*Ecl. Hist.* viii, 14) speaks of a famous Alexandrian woman, who, when other women of the city yielded to the lust of the tyrant Maximin, resolutely resisted and overcame him, for which she was punished with exile and the loss of all her property. Joseph Assemani thinks that this is the only account of *St. Catharine* that can be depended on. Her remains are said to be still kept in a marble chest in the monastery of Mount Sinai, in Arabia (Pocock's *Travels*, i, 140, fol.). She is commemorated on Nov. 25.—Butler, *Lives of Saints*, Nov. 25; Landon, *Ecl. Dict.* s. v.

2. Of Sweden, a princess, born about 1880, who, being contracted in marriage to a young nobleman named Egard, persuaded him to join her in making a vow of perpetual chastity! She died abess of the monastery of Vatzen, March 24, 1881.—Butler, *Lives of Saints*, Nov. 22; Landon, *Ecl. Dictionary*, s. v.

3. Of Sienna, was born at Sienna in 1847, and early devoted herself to an austere life. In 1865 she received the habit of the third order of St. Dominic, and soon became celebrated for her recluse life, revelations, and miraculous powers of conversion! She induced Pope Gregory XI to restore the pontifical throne to Rome from Avignon. She used all her efforts to cause Urban VI to be recognised as the lawful successor of Gregory. She died April 29, 1880. Pius II published the bull for her canonization June 29, 1461, and her festival is observed on April 80.—A. Butler, *Lives of Saints*, April 80; Chavin, *Vie de St. Catharine* (1846); Landon, *Ecl. Dictionary*, s. v.

4. Of Bologna, born of noble parents Sept. 8, 1418.

In 1427 she entered among the nuns of St. Francis at Ferrara, who soon after adopted the severe rule of St. Clare. Afterwards she became abbess of a new convent of the order in Bologna. She is said by Roman writers to have had the gifts of prophecy and miracles! She died March 9, 1468, on which day she is commemorated. A spurious book of her Revelations was published at Bologna in 1511.—Butler, *Lives of Saints*, March 9.

5. Of Genoa, daughter of James Fieschi, viceroy of Naples, was born at Genoa in 1448, and at about sixteen was married, against her will, to a gay young profligate named Julius Adorna, who for many years caused her the greatest affliction. Being left a widow, she devoted herself to the care of the sick and poor. She died Sept. 14, 1510, leaving a few works of devotion.—Butler, *Lives of Saints*, Sept. 14; Upham, *Life of Cath. Adorna* (N. Y. 1856, 12mo).

6. Of Ricci, was born at Florence in 1522. In 1535 she took the veil among the Dominican nuns at Prato, in Tuscany. She was made perpetual prioress at twenty-five, on account of her sanctity and ascetic life. The Bollandists say that Philip of Neri was allowed to converse with her in a vision, she being at her convent and he at Rome! She died Feb. 2, 1589, and was canonized in 1746.—Butler, *Lives of Saints*, Feb. 14.

Catharinus, Ambrosius, or, more properly, *Lancelot Polit*, was born at Sienna in 1487. He studied law, and afterwards taught that science in several Italian universities; but in 1521 he entered the Dominican order at Florence, and in 1545 accompanied the cardinal del Monte to the Council of Trent. He became afterwards bishop of Minori in 1546, and archbishop of Conza in 1551. He died at Rome in 1558. As a theologian he stood high for learning, but was much given to controversy, and did not spare either the fathers or the dogmas of his Church in his attacks. His principal works are: *Commentaria in epistolus Pauli* (Venice, 1551, fol.);—*Enarrationes in Genesis* (Rome, 1552, fol.). Some of his writings were published under the title *Opuscula* (1542).—Pierer, *Universal-Lexikon*, s. v.; Dupin, *Eccle. Writers*, 16th cent.; Nicéron, *Mémoires*, t. xxxiv.

Cathart, Robert, D.D., a Presbyterian minister, was born Nov. 1795, near Coleraine, Ireland, where he was classically educated. He afterwards entered the University of Glasgow, was licensed by the Presbytery of Route, and labored within its bounds for several years. On coming to America in 1790 he became a member of the Presbytery of Philadelphia, and in 1798 became pastor of the churches of York and Hopewell, Pa., where he spent nearly fifty years of eminent usefulness. He was a member of the General Assembly for nearly thirty years in succession. He pursued his labors with unwearied diligence, and died Oct. 19, 1849. He published *A Sermon on the Death of Rev. Dr. Davidson*, 1812.—Sprague, *Annals*, iii, 559; *Presb. Quart. Rev.* Oct. 1860, art. vi.

Cathédra (Latin *cathedra*; Gr. *καθῆδρα*—from *κατά*, down, and *ἔδρα*, a seat). In classical archaeology *cathedra* means a chair with a back, but without arms, and usually used by women. Cathedrae were also used by teachers of gymnastics while giving instruction, and, later, by all public teachers. Following this usage of the word, the term has been applied to the chair or office of professors in universities or other high schools of learning. The English word *chair* is used in the same way.

In the early Christian Church the term *cathedra* was applied to the seats bishops and presbyters occupied during divine service in such rooms as Christians were permitted to assemble in before they were allowed to build churches. In many of the crypts in the Catacombs at Rome and elsewhere are seats cut in the rocks, supposed to have been thus used. Later, when

church edifices were erected, the *cathedrae* were placed in the middle of the semicircular apsis at the eastern or rear end of the church, and occupied by the choir. In Rome many of the *cathedrae* were taken from the public baths, and were thus of marble, and decorated with designs from classical mythology. Later, they were decorated with symbolic designs of the Christian faith, as the head of a lion, representing the force and vigilance of a good bishop; the head of a dog, representing his vigilance and fidelity; or a dove crowned with a nimbus over the back of the chair, representing the Holy Spirit which was to shed light into his heart. The *cathedrae* of the 5th and 6th centuries were often inlaid with ivory and precious stones, after the style of the Alexandrian mosaics. Later, they were richly decorated and heavily gilt. Very early in the history of the Church they were held as precious mementoes of favorite bishops. Traditions, unworthy of credit, are attached to the reputed chairs of St. Peter in the Vatican (Rome), of St. Mark in Venice, and of St. Paul in Salonica. In the Gallic Church, for a time, the bishops were buried seated in their chairs, which were afterwards taken up and preserved with great respect.

In the paintings of the Catacombs, in early mosaics and miniatures, *cathedrae* are often represented with either a literal or figurative meaning. Thus, in the Catacombs, a bishop is represented stretching out his hand to a woman and to a sheep, thus representing the audience and the flock; in another, the bishop is holding up the Word; God the Father is represented on a *cathedra* receiving the gifts of Cain and Abel; the Redeemer is thus seated, receiving the crowns of gold from the seven elders [see APOCALYPSE]; Christ is seated on a *cathedra* surrounded by eight martyrs. Two chairs in two niches, with a table between them bearing the open Bible, represent a council (in the Baptistery of Ravenna). In the church of Santa Maria della Mentorella (in Latium) is a work in gilded bronze, representing the twelve apostles on seats; between them is a *cathedra* supporting the open Bible, as the source of all authority; above is a lamb, bearing a cross with a banner, having the inscription "*Ego sum ostium et ostium ovium— I am the gate and the fold of the sheep*;" a chalcedony in Cortena has a *cathedra* with *Ἰχθῦς* cut on it.—Bingham, *Orig. Eccles.* bk. viii, ch. vi, § 10.

Cathedral [see CATHEDRA]. (1.) The church edifice containing the *cathedra* or bishop's chair, i. e. the bishop's church in a diocese, usually the largest and most magnificent church in a diocese. The modern use of the term *cathedral*, as designating the church in which the bishop has his throne, is confined to the Western Church, and is posterior to the tenth century. In the East such churches are called the great church, the episcopal church, or simply the church.

(2.) **CATHEDRAL** (adjective)—(a) pertaining to a cathedral, as "cathedral service;" (b) official or authoritative, as the "cathedral determination of an article."

Catholic (*καθολικός* [*κατά* and *ἄλος*], *general, universal*), a title given to the Christian Church on account of its being not confined (like the Jewish) to one people, but embracing members out of every nation. "As 'the Church' is (in one of its senses) employed to signify all Christians, who are 'members one of another,' and who compose the body of which Christ is the head, so the title 'catholic,' or 'universal' is a necessary indication of the use of the word 'church' in that sense. The Catholic Church comprehends the entire body of true Christians; but it is no one community on earth—it has no one visible ruler or governor. Any individual church may be included in it, but cannot with propriety be called the Catholic Church" (Eden, s. v.).

1. In the primitive Church, the title "catholic" came into use at an early period to distinguish the

Christian Church from the Jewish, which was national, while the Christian body was to include all mankind. At a later period it was used to distinguish those who adopted the so-called "heresies," within the Christian Church, from the body of believers who held the true faith, and to whom alone, and to whose belief, the term "catholic" was applied. The earliest uses of the word (e. g. Polycarp [† 166], in an epistle preserved in Eusebius, *H. E.* iv, 15; Clemens Alex. [† 220], *Stromata*, vii) are in the sense of the general diffusion of the Church. It is used in the Apostles' Creed (third century), and after the adoption of the Nicene Creed it became a common title of the Church (see Pearson, *On the Creed*, art. ix, note c). Chillingworth interprets the "Holy Catholic Church" in the Creed to mean "the right that the Church of Christ, or rather, to speak properly, the Gospel of Christ, hath to be universally believed. And therefore the article may be true, though there were no Christian Church in the world" (Chillingworth, *Works*, fol. p. 196). Paganus (A. D. 372), in answer to Sempronian the Novatian, who demanded of him why Christians called themselves Catholics, replied, "Christian is my name, and Catholic my surname; the one is my title, the other my character or mark of distinction" (cited by Binzham). Clarke (*Sermons* [vol. iv, ed. 1780] on the *Catholic Church*) gives the following meanings of the word: "The first and largest sense of the term Catholic Church is that which appears to be the most obvious and literal meaning of the words in the text (Heb. xii, 23), 'The general assembly and church of the first-born which are written in heaven;' that is, the whole number of those who shall finally attain unto salvation. Secondly, The Catholic or Universal Church signifies, in the next place, and indeed more frequently, the Christian Church only—the Christian Church, as distinguished from that of the Jews and patriarchs of old; the Church of Christ spread universally from our Saviour's days over all the world, in contradistinction to the Jewish Church, which was particularly confined to one nation or people. Thirdly, The Catholic Church signifies very frequently, in a still more particular and restrained sense, that part of the Universal Church of Christ which in the present age is now living upon earth, as distinguished from those which have been before and shall come after. Fourthly and lastly, The term Catholic Church signifies, in the last place, and most frequently of all, that part of the Universal Church of Christ which in the present generation is visible upon earth, in an outward profession of the belief of the gospels, and in a visible external communion of the Word and sacraments." Pearson (*Exposition of the Apostles' Creed*, art. ix) explains the catholicity of the Church as consisting, generally, in "universality, as embracing all sorts of persons, as to be disseminated through all nations, as comprehending all ages, as containing all necessary and saving truths, as obliging all men to all kinds of obedience, as curing all diseases, and planting all graces in the souls of men."

2. The Roman Church arrogantly claims the name Catholic as exclusively her own, and designates all who do not belong to her communion as heretics and schismatics. It is bad enough in the Church of Rome to make this claim of the title "Catholic;" it is still worse for Protestants to concede it. The result of this concession, in most Protestant countries, is that common people have really no conception of the true use of the word Catholic. The words "Papist," "Papal," "Romanist," are all properly applicable to the Church of Rome, and imply no offensive meaning, as they are all legitimately derived. At all events, the word "Roman" should always be prefixed to "Catholic," if the latter term be used as part of the title of the Church of Rome. "There is a strange enchantment in words, which, being (although with no great color of reason) assumed, do work on the fancies of men, es-

pecially of the weaker sort. Of these power doth ever arrogate to itself such as are most operative, by their force sustaining and extending itself. So divers prevalent factions did assume to themselves the name of Catholic, and the Roman Church particularly hath appropriated that word to itself, even so as to commit a bull, implying Rome and the universe to be the same place; and the perpetual canting of this term hath been one of the most effectual charms to weak people. 'I am a Catholic, that is, a universal; therefore all I hold is true:' this is their great argument" (Barrow, *On the Pope's Supremacy; Works*, N. Y. ed. iii, 201). The Church of which Rome was so long the centre is not Catholic, but Latin; just as the Church of which Constantinople was the centre is not Catholic, but Greek. "There is, indeed, a Catholic or Universal Church, and therefore a universal Christianity. But to assert that the unity implied in the conjunction of these terms is, and must be, a visible unity, is, in a word, to give the lie to all Church history, both Greek and Latin, from a date almost immediately sequent on the apostolic age. And neither Greek, nor Latin, nor Teutonic Christianity, nor all of them together, can be Catholic Christianity, any more than a part of anything can be equal to the whole" (*Lond. Quarterly Review*, April, 1855, p. 160).

Bishop Bilson, in his *True Difference between Christian Subjection and Unchristian Rebellion* (1585), sums up the reasons for denying catholicity as a note of the Roman Church as follows (in dialogue form): "*Philander* (Romanist): What one point of our religion is not catholic? *Theophilus* (Anglican): No one point of that which this realm hath refused is truly catholic. Your having and adoring of images in the church; your public service in a tongue not understood of the people; your gazing on the priest while he alone eateth and drinketh at the Lord's table; your barring the people from the Lord's cup; your sacrificing the Son of God to his Father for the sins of the world; your adoring the elements of bread and wine with Divine honor instead of Christ; your seven sacraments; your shrift; your releasing souls out of purgatory by prayers and pardons; your compelling priests to live single; your meritorious vowing and performing pilgrimages; your invocation of saints departed; your rules of perfection for monks and friars; your relying on the Pope as head of the Church, and vicar-general unto Christ—these, with infinite other superstitions in action and errors in doctrine, we deny to have any foundation in the Scriptures, or confirmation in the general consent or use of the Catholic Church."

In fact, for Protestants to concede to Romanists the title "Catholics" is equivalent to acknowledging themselves heretics. "This concession may be harmless and innocent enough as far as Protestants are concerned, but it is most pernicious to those to whom the title is conceded. Men at all times have an inclination to trust in names and privileges, and nothing has proved, or will prove, a greater obstacle to progress in Christian truth than this feeling of being possessed of exclusive privileges—of being exclusively Catholics, i. e. members of the Catholic Church—of that holy community that must secure a special share of divine favor to every member of it."—Bingham, *Orig. Eccles.* bk. i, ch. i, § 7; Suicer, *Theaurus Eccles.* s. v. καθολικός; Eden, *Churchman's Dictionary*, s. v.; Elliott, *Delinements of Romanism*, bk. iii, ch. ii, § vii; Bellarmine's *Notes of the Church confuted* (Lond. 1687, 4to, pp. 29-84); Litton, *The Church of Christ*, bk. ii, pt. ii, Introduction; Palmer, *On the Church*, pt. i, ch. xi, § 8. See ROMAN CATHOLIC CHURCH.

CATHOLIC, title of a prelate. See CATHOLICUS.

Catholic Apostolic Church, the name of a body of Christians which has had a separate organization for somewhat more than thirty years. The following article is from a member of the body.

I. *History.*—Towards the end of the first quarter of this century there began to be an increased spirit of prayer in Great Britain for the outpouring of the Holy Spirit, in promoting which the labors of the Rev. I. Haldane Stewart (of the Church of England) were most helpful. About the same time the Rev. Edward Irving (q. v.) was called up from Glasgow to London, where for a number of years he preached with great power and effect on the coming and kingdom of Christ, his true humanity, and his work as the baptizer with the Holy Ghost. In respect to the last, he taught that the Church is now, and at all times, entitled to the spiritual endowments of the primitive age, because “the gifts and callings of God are without repentance;” but he had no clear conviction that they would be restored, nor did he urge his flock to pray for their restoration. The missionary employed by his Church to preach to the poor of the city, the Rev. A. J. Scott, had much stronger faith that they would be recovered than Mr. Irving himself, and, when on a visit to his friends in the west of Scotland in '28 or '29, he labored to convince them of the permanency of the gift of the Holy Ghost. Among them was Miss Mary Campbell, sister of Isabella Campbell, whose *Memoirs* were widely circulated more than thirty years ago, then living at Fernicarry. Through the careful study of the New Testament, she became convinced that the promise of the Comforter was for all generations, and she was led to pray, in concert with some friends, that God would again manifest himself as of old in the gifts of his Spirit. In March, 1830, when engaged in prayer with her friends, the power of the Holy Ghost came mightily upon her, and she was made to speak in tongues and prophesying. Very soon afterwards, the same spiritual phenomena appeared in a family by the name of Macdonald, living at Port Glasgow, who, like Miss Campbell, were Presbyterians, and distinguished as well for purity of life as for zeal and devotion. One of the sisters, who was dangerously ill, was restored instantaneously to health through the faith of her brother, by whose instrumentality Mary Campbell was also raised up from what seemed to be the very brink of death. These occurrences naturally excited much attention not only in the immediate neighborhood, but throughout Great Britain, and in the summer of that year several persons—almost all of them members of the Church of England—went down from London and spent some weeks at Port Glasgow, to satisfy themselves as to the true character of these spiritual utterances. Being convinced by what they saw and heard that they were the work of the Holy Ghost, they met together after their return, with others of like faith, to pray that God would pour out his Spirit upon his whole Church. These meetings, which were held weekly at private houses, were continued throughout the winter, and it was not until April of the following year (1831) that any spiritual manifestation appeared. Then the mouth of a pious lady of the Church of England, under the pastoral care of the Rev. Baptist Noel, was opened in power, and she too spake in tongues and prophesying. In the course of that year other persons, both men and women, received like spiritual gifts. Some of them were members of the Established Church, and others were Presbyterians and Dissenters; but it was chiefly in the congregation of Mr. Irving (and that after long and careful examination) that liberty was given to speak in spiritual power. This, together with his prominence in the eyes of the world, led to the connecting of his name with the work, although he and all who were of the same faith with him never ceased to protest against the name of Irvingites as a designation of the body.

These utterances, accompanied by many and striking cases of healing, continued in great power and frequency until the end of the year 1832, when a new form was given to the work by the restoring of the office of apostle. This was done, not by popular elec-

tion, nor by any act of man, but by the voice of the Holy Ghost speaking through prophets, and thus expressing the mind and will of God, that one who had been a godly member of the Church of England, and had stood as a faithful witness to the work of the Holy Ghost, should serve him in this highest ministry. Others were afterwards, from time to time, called to the same office, until, in the year 1835, the full number was completed. Mr. Irving was not one of them, nor, with a single exception, any of his original congregation; three of them were clergymen, three were members of the bar, two of them had been members of Parliament, and all were men of high religious character.

At this time there existed a considerable number of congregations which had been gathered by the preaching of evangelists, and organized by the apostles previously called. When the number had been filled up, they were solemnly separated to their work with prayer and benediction in an assembly of the churches, as was done in Antioch in the case of Barnabas and Saul. They were then bidden, in the word of prophecy, to go to a secluded village in the south of England—Albury, the residence of Mr. Henry Drummond—and there read the Scriptures together in the presence of the prophets, that light might be thrown upon them by the word of the Holy Ghost. They were also directed to prepare a testimony of what God was doing, and to present it to the bishops of the Church of England and Ireland, which was done in Jan. 1836. A larger testimony was presented in 1838 to the Pope, the Emperor of Austria, and the King of the French, as the representatives of the great principles of government existing in Christendom—priestly rule, absolutism, and popular election—and afterwards to others of the chief rulers in church and state throughout Europe. In these testimonies (especially in the latter) the sins of Christendom in departing from the ways of God were pointed out, his approaching judgments proclaimed, and the coming of the Lord (for which the restoration of the Church was the preparation) held up as the only hope of deliverance to the sin-burdened and weary creation.

For a number of years the work made little progress outside of the British Isles, but the revolutionary movement in Europe in 1848 drew to it the attention of many in Germany, and churches were soon organized in Berlin and other cities and towns. It has gradually extended itself into Switzerland, France, Holland, Belgium, Denmark, and Austria, and also into North America, and believers are to be found in countries where there is as yet no liberty of worship.

II. *Organization and Polity.*—This body of Christians, who take the name of the Catholic Apostolic Church, as being the proper designation of all the baptized, and not as exclusively their own, look upon the spiritual work which has been briefly described, as a divine movement in the one Church to restore to it its original structure and endowments, in preparation for the now rapidly approaching advent of the Lord Jesus Christ. They believe it to be, not the founding of a new sect, much less the setting up of a new dispensation, but a work of healing and recovery in the one body of Christ, which has had a continuous and historic existence from the day of Pentecost to this hour. They recognise, therefore, the whole Christian Church as brethren, according to the measure of truth in doctrine and ordinances which it has retained in its several divisions. They believe that, in the purpose of God and in its own nature, it is one body; and that intercommunion between the parts is the true law of its being, and the necessary condition of its healthful growth; intercommunion, not as between distinct and independent nations, but as between the different portions of one and the same nation, having one central authority, and subject to common laws. The central authority which God gave to the Church in the beginning they believed him to have now restored, not for

the superseding of the existing ministries, but for the conveying of grace and strength more abundantly to all who will receive it. The apostolic office belongs to no sect, but is for the whole Church; and those who are gathered under it are not a sect, but a part of the one body brought into their right relations to the Head and to one another.

In respect to the organization of the Catholic Apostolic Church, its chief peculiarity lies in the fourfold ministry of apostle, prophet, evangelist, and pastor, as described by St. Paul in the 4th of the Ephesians. Apostles are rulers in the Church universal, by whom the Lord in his absence exercises his functions of authority; prophets are the special organs of the Holy Ghost, by whom light is imparted for the guidance of apostles in their work; evangelists carry forth the Gospel; and pastors feed and care for the flocks. The same fourfold distinction is brought out in the particular churches, in each of which, where circumstances allow of its being fully organized, there is an angel or chief pastor, representing to his own flock the Angel of the Covenant in the heavens, who has under him a body of elders in whom there should be seen the same fourfoldness of ministry as in the Church universal under Christ—some helping him in the work of rule, others exercising the prophetic gift, and others still acting as evangelists and pastors within the limits of the angel's charge. This variety of functions in the ministry is in accordance with a fourfold distinction in the intellectual and spiritual characters of men, to which the gifts of the Holy Ghost shape themselves—some having the power of rule, others the imaginative faculty, while in others the adaptive understanding or the affections are respectively predominant.

In every church, in addition to the angel and elders, there is a body of deacons, who are chosen by the people as being their representatives, and ordained by the angel; whose office it is to assist in the public services, especially the celebration of the Eucharist; to distribute the alms of the church to the poor, and to be the counsellors of the people in worldly matters. There are also under-deacons and deaconesses, as the necessities of the congregation may require. All ministers except those in the diaconal office are called by the voice of prophecy, and ordained by the hands of apostles. The apostles themselves are not ordained, there being none higher than themselves to confer on them authority and grace.

III. *Doctrines.*—They receive the Scriptures of the Old and New Testaments (rejecting the Apocrypha) as the plenary inspired and authoritative revelation of God's will, and standard of doctrine for all generations. And they hold the common faith of Christendom, as expressed in the three great creeds best deserving the name of Catholic—the Apostles', the Nicene, and the Athanasian. They make use of no other creeds, and these are used constantly in the public services as a part of worship—the Apostles' being recited before God every day in the morning and evening services, the Nicene every Sunday in the eucharistic office, and the Athanasian on the principal feasts of the year. But they give especial prominence to the great doctrine of the Incarnation, with its corollaries of the death and resurrection of the Lord, and the descent of the Holy Ghost; teaching that the only and eternally-begotten Son of God took fallen humanity by being born of the Virgin, fulfilled in it as man the perfect righteousness of God, and yielded it to the death of the cross as a spotless and sufficient offering for the sins of the whole world; whereupon the Father gave him his reward by raising him from the dead in the incorruptible body, and exalting him in the human nature to his own right hand. He was thus constituted the Head of the Church, and his next step was to form the body by sending the Holy Ghost to make men one with himself in all the spiritual fruits and results of his victory. The three great ordinances which he has appointed in his Church

II.—L

for this end are, Baptism, which is for conveying his new or resurrection life to all who believe in him, and to their children, and which is counted valid whether administered by sprinkling, pouring, or immersing; the Lord's Supper, in which bread and wine are made in consecration, by the operation of the Holy Spirit, to be the spiritual mystery of the body and blood of Christ, and are partaken of for the nourishing and strengthening of his faithful members; and the rite of confirmation or sealing, in which, by the laying on of the hands of apostles, the Holy Ghost is given for endowing with heavenly gifts and the powers of the world to come those who have reached adult age and are walking in holiness of life. In respect to the Eucharist, they reject the Roman Catholic doctrine of transubstantiation on the one hand, and that of Zwingli on the other, holding that the elements of bread and wine are unchanged in their physical properties and essence by consecration, while they are made, by the operation of the Holy Ghost, to be, spiritually and not carnally, the body and blood of the Lord.

To gather the Church as the election of God out of all the nations of the earth, they believe to be the great work of this dispensation, at the completion of which the Lord will return and take his Bride to himself by raising the dead and changing the living saints, and will then proceed to set up his kingdom in the earth. First of all, he will deliver the Jews—both the two tribes which are known and the ten which are lost—from their dispersion and exile, and reconstitute them as the metropolitan nation in the land which God gave to their fathers; and then, by their instrumentality, he will extend his salvation to all the families of mankind. This millennial dispensation will continue through the thousand years spoken of by St. John, at the expiration of which there will be an apostasy among the nations outside "the camp of the saints and the beloved city," i. e. those whose standing is distinct both from the Church and the restored nation of Israel, through the instigation of Satan, then for the last time loosed from his prison-house, after which the final judgment, with its eternal retributions of good and evil, will ensue.

The Eucharist is made the centre of worship, as being the commemoration of the death of Christ, which opened the way of entrance into the Holy of Holies, where he now, as our great High-priest, fulfils the work of intercession. In this work his Church is called to take part, which she does in the highest sense when she shows forth his death in this holy sacrament, by presenting unto God in the consecrated elements the memorial of his sacrifice, and thereupon offering prayers and intercessions for all men. It is not the expiatory sacrifice of Jesus on the Cross which the Church thus renews and continues in the Eucharist (as the Roman Catholics teach), for he died once for all to make atonement for sin, and there can be no repetition of his death; but it is his present intercessory work in heaven. The Eucharist is celebrated on the forenoon of every Lord's day, and on other solemn and special occasions. The tithes and offerings of the people are brought up during the services, and solemnly dedicated to God in prayer. There are also morning and evening services for worship on every day of the year, at 6 A.M. and 5 P.M., consisting of confession of sin with abolution, the reading of the Holy Scriptures, the reciting of the Creed, the singing of a Psalm, and prayers in the fourfold form of supplications, prayers, intercessions, and giving of thanks, which are offered by the priests in order according to their respective ministries, all being gathered up and presented to God in the name of Jesus Christ, the great High-priest and Mediator, by the angel of the Church. In the principal congregations there are shorter services every forenoon and afternoon at nine and at three. There are also meetings for extemporaneous prayer, that all whom the Spirit moves to

pray may have liberty to express their desires unto God, and for the exercise of spiritual gifts, in which every one—even women and children—may yield themselves to speak in the power of the Holy Ghost. Sermons are preached on Sundays and at appointed times during the week. A ritual is used, constructed on the principle of gathering in one all that is most valuable in the worship of the whole Church. The ministers wear vestments in the public services, and lights and incense are used for their symbolical character. The ancient ordinance for anointing the sick with oil is restored to its right use; and for the relief of penitents there is the rite of private confession and absolution, but which is not compulsory, nor for the extortion of secrets. They believe that the end of the dispensation is rapidly approaching, and that the object and aim of all these ministries, and spiritual gifts, and ecclesiastical services, is to make ready a people for the Lord.

There are no published statistics of this body, but there are churches in many of the principal cities of England (seven in London) and Scotland; in Dublin and Belfast; in Paris, and a few other places in France; in Basle, and Berne, and other towns in Switzerland; in Berlin, and many other places in North Germany; and a number of smaller congregations in Holland, and Belgium, and North America.—W. W. A.

To the above account it is proper to add that, in the judgment of the Christian Church generally, the distinctive doctrines of the Catholic Apostolic Church are regarded as erroneous, and its polity and usages as reactionary, and opposed to the true development of the Church.

1. *As to doctrine.*—The C. A. Church is especially distinguished by its doctrine as to spiritual gifts. "Like the Montanists of the second century, they look upon these apostolic gifts and offices as the necessary conditions of a healthy state of the Church at any time; make their disappearance the fault of Christianity; and hold it impossible to remedy the defects of the Church without a revival of the charisms and the apostolate. They appeal to such passages as 1 Cor. xii, 27-31; Eph. iv, 11-13, where undue emphasis is laid on 'till'; and to Thess. v, 19, 20; 1 Cor. xii, 31; xiv, 1, where the apostle not only warns Christians against quenching the holy fire of the Spirit, but also positively requires them to strive earnestly after His miraculous gifts. There seems to us to be here a mixture of truth and error on both sides. In these charisms we must distinguish between the essence and the temporary form. The first is permanent; the second has disappeared, yet breaks out at times sporadically, though not with the same strength and purity as in the apostolic period. In the nature of the case, the Holy Ghost, when first entering into humanity, came with peculiar creative power, copiousness, and freshness; presented a striking contrast to the mass of the unchristian world; and, by this very exhibition of what was extraordinary and miraculous, exerted a mighty attraction upon the world, without which it never could have been conquered. Christianity, however, aims to incorporate herself in the life of humanity, enter into all its conditions and spheres of activity as the ruling principle, and thus to become the second, higher nature. As it raises the natural more and more into the sphere of the Spirit, so in this very process it makes the supernatural more and more natural. These are but two aspects of one and the same operation. Accordingly we find that, as fast as the reigning power of heathenism is broken, those charisms which exhibited most of the miraculous become less frequent, and after the fourth century almost entirely disappear. This is not owing to a fault of Christianity, for at that very time the Church produced some of her greatest teachers, her Athanasius and her Ambrose, her Chrysostom and her Augustine. It is rather a result of its

victory over the world. Spiritual gifts, however, did not then fully and forever disappear, for in times of great awakening and of the powerful descent of the Spirit, in the creative epochs of the Church, we now and then observe phenomena quite similar to those of the first century, along with the corresponding dangers and abuses, and even satanic imitations and caricatures. These manifestations then gradually cease again, according to the law of the development of a new principle as just stated. Such facts of experience may serve to confirm and illustrate the phenomena of the apostolic age. In judging of them, moreover, particularly of the mass of legends of the Roman Church, which still lays claim to the perpetual possession of the gift of miracles, we must proceed with the greatest caution and critical discrimination. In view of the overvaluation of charisms by the Montanists and Irvingites, we must never forget that Paul puts those which most shun free inspection, and most rarely appear, as the gift of tongues, far beneath the others, which pertain to the regular vital action of the Church, and are at all times present in larger or smaller measure, as the gifts of wisdom, of knowledge, of teaching, of trying spirits, of government, and, above all, of love, that greatest, most valuable, most useful, and most enduring of all the fruits of the Spirit" (Schaff, *Apostolic Church*, § 116).

2. Their worship is almost wholly out of the line of Protestant development and feeling. Their use of incense, and of lights on the altar; their priestly vestments—alb, girdle, stole, chasuble, rochet, etc.—with the pomp of their worship, belong neither to the primitive age on the one hand, nor to the Reformed Church on the other.

For a fuller account, by the author of the articles given above (the Rev. W. W. Andrews), see *Bibliotheca Sacra*, January, 1866, p. 106 sq. See also Schaff, in the *Deutsche Kirchenreform*, vol. iii; *English Rev.* ix, 212; Thiersch (H. W. J.), *Vorlesungen über Katholicismus und Protestantismus* (Erlang, 1845, 1846, 2 vols.); Thiersch, *Die Kirche im Apostol. Zeitalter* (1852, 8vo); *London Quarterly Review*, No. iii, art. 1; *Liturgy and Litany of the C. A. Church* (N. Y. 1856); W. W. Andrews, *True Constitution of the Church* (N. Y. 1854); Jacobi, *Lehre der Irvingiten*, 1858; Smith's Hagenbach, *History of Doctrines*, ii, 414; Baxter, *Irvingism, its Rise, Progress, and Present State* (Lond. 1856); Kötstlin, in Herzog's *Real-Encyclopädie* (Am. ed. ii, 658); *Quarterly Journal of Prophecy*, July, 1866, art. 1; Maury, in *Revue des deux Mondes*, Sept. 1858; and the articles GIFTS; IRVING.

Catholic Epistles. The canonical epistles of James, Peter, and Jude, and the first of John, are so called because they are not addressed to any particular individual or church, but to Christians in general (Suicer, *Thec. Eccles.* ii, 15).

Hug gives the following view: "When the Gospels and Acts of the Apostles constituted one peculiar division, the works of Paul also another, there still remained writings of different authors which might likewise form a collection of themselves, to which a name must be given. It might most aptly be called the *common collection*, καθολικὸν σύνταγμα, of the apostles, and the treatises contained in it κοιναί and καθολικαί, which are commonly used by the Greeks as synonyms. For this we find a proof even in the most ancient ecclesiastical language. Clemens Alexandrinus calls the epistle which was dispatched by the assembly of the apostles (Acts xv, 23) the 'catholic epistle,' as that in which all the apostles had a share, τὴν ἐπιστολὴν καθολικὴν τῶν Ἀποστόλων ἑπαντων. Hence our seven epistles are catholic, or epistles of all the apostles who are authors" (*Introd. to N. T.* § 151). So, also, Eichhorn. See Horne, *Introduction*, pt. vi, ch. iv, § 1. See EPISTLES, APOSTOLICAL.

Catholic League. See LEAGUE.

Catholicos (καθολικός), (1.) The title given, under

Constantine, to his procurator, or vicar-general (after the organization of dioceses under imperial law), whose duty it was to see that all imperial rescripts were duly carried out. So in a letter from Constantine to Eusebius (preserved in Socrates, *Hist. Eccles.* i, 9), the emperor says: "Letters have been sent to the διοικήτωρ καθολικόν, that he may provide all things necessary," etc. See Suicer, *Thes. Eccles.* s. v.

(2.) The official title of certain of the Oriental prelates, especially of the patriarchs of the Armenian Church. He is appointed head of that part of the church over which his jurisdiction extends; he only can ordain bishops and consecrate the sacred oil. The dignity of Catholicos is inferior to that of patriarch, but superior to that of metropolitan. There are three dignities bearing the title in the Armenian Church at present—the Catholicos of Etchmiadzin, the Catholicos of Aghtamar, the Catholicos of Sis.—Coleman, *Ancient Christianity*, ch. xxvii, § 2. See ARMENIAN CHURCH.

Cathu'ä (Καθουά), one of the family heads of the "servants of the Temple" (Nethinim) that returned from Babylon (1 Esdr. v, 30); apparently the GIDDEL (q. v.) of the Heb. texts (Ezra ii, 47; Neh. vii, 49).

Catlin, JACOB, D. D., a Congregational minister, was born at Havinton, Conn., March, 1758, and graduated at Yale, 1784. He became pastor in New Marlborough, Mass., July 4, 1787, was made D.D. by Yale in 1822, and died April 12, 1826. He published a work on theology, *What is Truth?* (1818); a volume, *Sermons collected* (1797); and a *Discourse before a Free-mason's Lodge* (1796).—Sprague, *Annals*, ii, 260.

Cattenburgh, ADRIEN VAN, an Arminian or Remonstrant theologian, born at Rotterdam Nov. 2, 1664, and filled the professorship of theology at Amsterdam for twenty-five years. He was intimately connected with Philip Limborch. He died in 1786, leaving (1.) *Spicilegium Theologia Christiana Philippi a Limborch* (Amst. 1726, 2 vols. fol.).—(2.) *Bibliotheca Scriptorum Remonstrantium* (Amst. 1727, 8vo).—(3.) *Synagoga Sapienciae Moscovica* (ibid. 1787, 4to), against Atheists and Deists. He also wrote a life of Grotius in Dutch.—Hofer, *Nouv. Biog. Générale*, ix, 226.

Cattle (the representative in various passages in the A. V. of the Heb. words בְּהֵמָה, *behemah*, a large quadruped in general, usually "beast" [see БИЖИМОРЯ]; in Num. xx, 4, and Psa. lxxviii, 48, בְּעֵי, *beir*, grazing animals, elsewhere "beast;" so the Gr. βοσκήματα, as being fed, 2 Macc. xii, 11, or Σπίμαρα, from being reared, John iv, 12; most frequently and characteristically מִלְכֵה, *milneh*, a possession, as sometimes rendered—from the fact that Oriental wealth ["substance," Job i, 3, 10] largely consisted in this kind of property; like the Gr. κτήνη, as being possessed, 1 Macc. xii, 28; also idiomatically, ἴψ, *seh*, Gen. xxx, 37; Isa. vii, 25; xliii, 23; Ezek. xxxiv, 17, 20, 22, an individual sheep or lamb, as elsewhere rendered; or ἱσθ, *isom*, Gen. xxx, 39, 40, 41, 42, 43; xxxi, 8, 10, 12, 41, 43; Eccles. ii, 7, sheep collectively or a flock, as rendered elsewhere), in scriptural usage, embraces the tame quadrupeds employed by mankind for domestic purposes, as oxen, buffaloes, horses, sheep, goats, camels, and asses (Gen. i, 25; xiii, 2; xxxii, 13-17; Ezek. xii, 29; xxxiv, 19; Num. xx, 19; xxxii, 16; Psa. i, 10). See each of these in their alphabetical place.

The Holy Land was eminently distinguished for its abundance of cattle, to the management and rearing of which the inhabitants, from the earliest times, chiefly applied themselves, as indeed they have always constituted the principal and almost only possession of a nomadic race. In this case, wealthy people were exposed to all the vicissitudes of the seasons (Gen. xxxi, 40). Moses was a shepherd during his exile, Shamgar was taken from the herd to be a judge in Israel, and Gideon from his threshing-floor (Judg. vi, 11), as were

Jair and Jephthah from the keeping of sheep; Saul and David might also be mentioned. Some of the prophets were called from that employment to the prophetic dignity, as Elisha was from the plough (1 Kings xix, 19), and Amos from being a herdman. But the tending of flocks was not confined to the men. Rachel, the daughter of Laban, kept her father's sheep (Gen. xxix, 9), and Zipporah and her six sisters had the care of their father Jethro's flocks, who was a prince or priest of Midian (Exod. ii, 16). The following account is translated from Winer, *Rechw.* ii, 381, 394, 732. See HERD; FLOCK.



Bull of Palestine.

I. *Neat Cattle*.—These are designated collectively by the Heb. term בָּקָר, *bakar*; single animals of this kind are called בָּאֵלִיף, *alluph*, an "ox," or שׂוֹר, *shor* (Chald. ܫܘܪ, *tor*), a "bullock;" the calves are styled עֵגֶל, *e'gel*, often a yearling—fem. עֵגֶלָה, *eglah*, a "heifer" (also a young cow, even when broken to the yoke, Judg. xiv, 18; Hos. x, 11); when grown, but still in full youthful vigor, פָּרָה, *par*, a steer—fem. פָּרָה, *parah*, a heifer (*juvencus, juvenca*; comp. Varro, *Res Rust.* ii, 5, 8). The nomadic Abrahamides (like the Homeric chiefs, see Feith, *Antiq. Hom.* p. 405) already practiced the raising of cattle (Gen. xii, 16; xviii, 7; xxiv, 85; xxxii, 5; xxxiv, 28; comp. xiii, 5), and when they emigrated into Egypt still carried it on (Exod. x, 9, 24; xii, 32 sq.). In later times, also, this was a principal pursuit of the Israelites, especially in several districts of Palestine (Deut. viii, 18; xii, 21; 1 Sam. xi, 5; xii, 8; 2 Sam. xii, 2; Psa. cxliv, 14; Jer. iii, 24; v, 11; Judith viii, 6, etc.). The oxen are there somewhat small, with short horns, and a bunch of fat on the shoulders (Hasselquist, *Travels*, p. 180; comp. Shaw, *Travels*, p. 150). The finest herds and strongest bullocks were found in Bashan, beyond Jordan (Num. xxxii, 4); hence the Bashanite steers are often put metaphorically for formidable enemies (Psa. xxii, 18), while Bashanite cows are a symbol of stately women (Amos i, 4). In the district west of the Jordan, the plain of Sharon, extending to the Mediterranean Sea, afforded the finest pastures (Isa. lxxv, 10; see Jerome in loc.). Even the kings had their herdsmen (1 Chron. xxviii, 29). There was great demand for neat cattle; many hundreds were yearly slaughtered in sacrifice (and these were animals of the finest quality, as among other nations, see Herod. ii, 41; Xenoph. *Cyrop.* viii, 31; Varro, *Res Rust.* ii, 5, 11; Pliny, viii, 10, etc.), others were employed for food or festive occasions (Deut. xii, 21; 2 Sam. xii, 4; Tobit viii, 21; Matt. xxiii, 4), as then generally beef (1 Sam. xiv, 32; 1 Kings xix, 21; comp. iv, 28; Neh. v, 18), and still oftener veal was a feast to the Israelites (Gen. xviii, 7; 1 Sam. xxviii, 24; Amos vi, 4; Luke xv, 23, 27, 30), it being anciently regarded as an act of wanton prodigality to slay useful agricultural beasts (compare Apollon. Rhod. ii, 655 sq.) in order to enjoy their flesh (*Ælian, Var. Hist.* v, 14; *Anim.* xii, 84; Varro, *R. R.* ii, 5, 6; Pliny, *Hist. Nat.* viii, 70; Valer. Max. viii, 1; Cic. *Nat. Deor.* ii, 65). See FOOD. The milk was used either sweet or curdled, and was made also into cheese. See MILK; CHEESE; BUTTER. Cattle

were yoked to the plough (Deut. xxii, 10; 1 Kings xix, 19 sq.; Isa. xxx, 24; Amos vi, 12; Job i, 14; comp. Judg. xiv, 18; Josephus, *Ant.* xii, 4, 6), likewise for draught (Num. vii, 8, 7; 1 Sam. vi, 7; 2 Sam. vi, 3, 6), and were sometimes employed for burdens (1 Chron. xii, 40; comp. *Ælian*, *Anim.* vii, 4), but especially for threshing (comp. *Baba Mesia*, vi, 4; *Chelim*, xvi, 7). See AGRICULTURE. They were driven (Judg. iii, 31; 1 Sam. xiii, 21; compare Sirach xxxviii, 25; Acts ix, 5) with a pointed stick (מַלְמַד, *malmad*, or דְּבַר, *doban*; κέντρον or βούκεντρον, also βουκλήξ in *Iliad*, vi, 185, Lat. *stimulus* [comp. Schol. ad Pindar, *Pyth.* ii, 178]), an instrument employed also for horses (Ovid, *Metam.* ii, 127; see Schöttgen, *De stimulo boum*, Fref. a. V. 1717). See GOAD. During summer cattle ranged under the open sky. In the stalls (2 Chron. xxxii, 28) their fodder (Prov. xiv, 4; Luke xiii, 15) was placed in a crib (סִבְיָה, *ebus*; φάτνη). Besides fresh grass and meadow-plants (Dan. iv, 29; Num. xxii, 4), meslin (בִּלְיָה, *beli'*, Job vi, 5; Isa. xxx, 24; דְּבַר, *te'den*, Isa. xi, 7) is mentioned as provender of cattle, a mixed food, like the Roman *farrago* (Gesenius, *Theaur.* p. 212). That salt (to gratify the appetite) was added may be inferred from Isa. xxx, 24 (see Gesenius in loc.). See SALT. Cattle were greatly annoyed by insects, and perhaps the פְּרֵי, *ke'rets* (A. V. "destruction"), of Jer. xli, 20, indicates some sort of such noxious creature, namely, the gadfly or *æstrus* (see Hitzig in loc.; otherwise Gesenius in loc.). See BEEVE.

In the Mosaic law the following enactments relate especially to oxen: 1. The mouth of the threshing-cattle was not to be bound so as to prevent their eating the provender spread under them (compare Burckhardt, *Proverbs*, p. 67). See MUZZLE. Hence the term "threshing oxen" sometimes stands for *fit* or well-conditioned animals (Jer. i, 11; see Rosenmüller in loc.). 2. Whoever stole and then sold or slaughtered an ox must give five oxen in satisfaction (Exod. xxii, 1); but if the animal was found alive in the possession of the thief, he was merely required to make double restitution (Exod. xxii, 4). See THEFT. 3. Whoever met an ox that had fallen or strayed was under obligation immediately to help it up and bring it back to the owner (Exod. xxiii, 4; Deut. xxii, 1, 4), an injunction the more needful in a country not only thinly inhabited, but intersected by many desert tracts. See PALESTINE. 4. An ox and an ass must not be yoked together to the plough (Deut. xxii, 10). This prohibition is evidently akin to those relating to heterogeneous combinations, although Michaelis (*Mos. Recht*, iii, 149) gives it another interpretation. See DIVERSE. Respecting unruly cattle (Exod. xxi, 28 sq.), see DAMAGES. It was considered unmerciful to take the only beast of a widow in pawn (Job xxiv, 8). See DEBT. On the subject generally, see Bochart, *Hieroz.* i, 268 sq.; Ugolino, *De Re Rust.* *Hebr.* (in his *Theaur.* xix), ii, 9 sq. For the symbolical worship of the young bull, see CALF, GOLDEN. Compare BEAST.

II. *Small Cattle*: 1. *Sheep*.—These are designated collectively by צֹאן, *tsan* (a general term, like μῆλον and *pecus*, including also goats), singly by צֶהַב, *seh*; while רֶחֶל, *rachel*, means *ewe*; אֵיל, *a'gil*, *wether* (Chald. דְּבַר, *dekar*); עֵז, *kar*, a fat pasture lamb; כֶּבֶשׂ, *ke'bes*, a lamb of one to three years (comp. Gesen. *Thes.* p. 659); תַּלְהֵי, *taleh*' (or אֵילִי, *tehi'*), a suckling or *milk-lamb*; מִשְׁנִים, *meshnim*' ("fatlings," 1 Sam. xv, 9), is an obscure term, possibly signifying two-year-old lambs (*oves secundarias*, Columella, *Res Rust.* vii, 3; comp. Bochart, *Hieroz.* i, 469). Next to neat herds, sheep formed the most important staple of Oriental nomadic pursuits in Aramæa (Gen. xxix, x) and Palestine (Gen. xii, 16; xiii, 5; xx, 14;

xxi, 27; xxiv, 85; xxxii, 5; xxxiv, 28), as in Egypt (Gen. xlvii, 17; Exod. ix, 8), Arabia Petrea and Deserta (Exod. ii, 16, 19; iii, 1; Num. xxxi, 82; Isa. xxxiv, 6; lx, 7), and Moabitis (2 Kings, iii, 4; Isa. xvi, 1). In military feuds between such tribes, we always find sheep mentioned among the booty of the victors (Num. xxxi, 82; Jos. vi, 21; 1 Sam. xiv, 82; xv, 3 sq.; xxvii, 9; 1 Chron. v, 21, etc.). The same is still universally true of modern Bedouin Arabs, whose traffic in sheep (comp. Ezek. xxvi, 21) is their leading



Syrian Sheep (*Ovis Laticaudato*).

mark of prosperity and even opulence (comp. Arvieux, iii, 182). The patriarchs had large flocks of sheep in Palestine, as later in Egypt or Goshen (Exod. x, 9, 24; compare Hengstenberg, *Pent.* p. 5 sq.); also upon the occupation of Canaan by the Israelites, sheep-breeding continued to be the chief employment of a large part of the population down to the latest period, being carried on amid the numerous open tracts and hills of the country (Isa. vii, 25), many of which were productive of saline plants (comp. Deut. vii, 13; viii, 13; xxviii, 4; Judg. vi, 4; 1 Sam. xxii, 19; 2 Sam. xii, 2; Prov. xxvii, 28; Eccl. ii, 7; Jer. iii, 24; v, 17; Hos. v, 6; Joel i, 18; Judith viii, 6, etc.). There were rich owners of flocks (1 Sam. xxv, 2; 2 Sam. xii, 2; comp. Job i, 3; xlii, 12), and even kings had their shepherds (1 Chron. xxvii, 81; Amos vii, 1; compare 2 Chron. xxxii, 28), from whom they derived a revenue of sheep and wool as presents (2 Sam. xvii, 29; 1 Chron. xii, 40) or tribute (2 Kings iii, 4; Isa. xvi, 1). Among the regions most favorable for sheep-rearing are mentioned the plain of Sharon (Isa. lxx, 10), Mt. Carmel (Mic. vii, 14), Bashan (Ezek. xxxix), and Gilead (Mic. i, c.). The sheep in the patriarchal age were tended oftentimes by the daughters of the owners (Gen. xxix, 9; compare Exod. ii, 16); later by overseers or hired men (John x, 12); sometimes by the sons of the family (1 Sam. xvi, 11; xvii, 16). See SHEPHERD. The keepers gave their sheep, especially the bell-wethers, regular names (John x, 8; compare Theoc. v, 102 sq.; Aristot. *Anim.* vi, 16; Longin. *Pastor.* v, 17 and 19), and familiarized these animals with their voice so as to follow them (comp. 2 Sam. xii, 2). The sheep roamed all summer in the open air, being folded only at night (Num. xxxii, 16; 2 Chron. xxxii, 28) in a pen (גִּדְרֵי, *gederah*); Talmud, רִוּוּ, where, in exposed positions, they were guarded by sentries (Luke ii, 8). In the daytime they appear to have been sometimes sheltered from the heat of the sun in caverns (בְּרִוּוֹת, Zeph. ii, 6; which, however, according to others, signifies only *pias*, i. e. cisterns for watering the sheep). Shepherds' dogs were indispensable (Job xxx, 1). Of the young, which sheep bear twice a year, the autumn lambs were considered the more vigorous (Varro, *Res Rust.* ii, 2, 18; Colum. *R. R.* vii, 8; Pliny, viii, 72; comp. Hamaker, *Miscell. Pharmic.* p. 117 sq.). The flesh of the sheep, especially that of wethers and lambs,

was, as with modern Arabs (Wallsted, *Trav.* p. 121), a highly esteemed food (1 Sam. xxv, 18; Isa. xxii, 18; Amos vi, 4; Tobit vii, 9; viii, 21), and was essential to a well-spread board (1 Kings iv, 23; Neh. v, 18). The milk of sheep was also an article of culinary use (Deut. xxxii, 14; comp. Diod. Sic. i, 18; Pliny xxviii, 38; Strabo, xvii, 835; Colum. *R. R.* vii, 2; Dioscor. ii, 75). Sheep, especially lambs and rams (q. v.), were a prominent animal in sacrifices (q. v.), and a stock of them was often sacrilegiously offered for sale in the Jewish temple (John ii, 14). The wool (צֶמֶר, *te'mer*, or גֵּז, *gez*), which, on account of the pasturing of the flock under the open sky, attained a high degree of fineness (as in Spain), was wrought into garments (Lev. xiii, 47; Deut. xxii, 11; Ezek. xxxiv, 8; Job xxxi, 20; Prov. xxvii, 26; xxxi, 18), and the Israelites were obliged to pay tithes of this product (Deut. xviii, 4). Sheep-shearing (Gen. xxxviii, 12) was a rural festive occasion (1 Sam. xxv, 4; 2 Sam. xiii, 28). As enemies of the shepherd are named the lion (Mic. v, 7), the bear (1 Sam. xvii, 84), and the wolf (Sirach xiii, 21; Matt. x, 16; John x, 12; comp. Isa. xi, 6; lrv, 25), which might easily carry off a single animal in the extensive and solitary pastures, although even this was often rescued by the sheep-tender (1 Sam. xvii, 34 sq.). See LION. The sheep were very liable also to stray in the wide pasturages (Psa. cix, 176; Isa. liii, 6; Hos. iv, 16; Matt. xviii, 12). On the "rot," or disease peculiar to flocks, see BOCHART, i, 596; Aristot. *Anim.* ix, 3. The color of sheep is in the East generally white (Psa. cxlvii, 16; Isa. i, 18; Dan. vii, 9; Cant. vi, 5; Rev. i, 14; comp. Ezek. xxvii, 18); although black (צֹמֶת, *duky*, Gen. xxx, 32) ones are also found (Colum. *R. R.* vii, 2; Pliny, viii, 78; comp. Wallsted, i, 218; Ruppell, *Abessin.* ii, 21), as well as spotted and grizzled (Gen. xxx, 32), peculiarities which shepherds knew how to produce artificially (Gen. xxx, 37 sq.; Strabo, x, 449; Pliny, xxxi, 9; comp. Rossellini, *Monum. Civ.* i, 246). See JACOB. A peculiar species of sheep (*Ovis laticaudata*, Linn.) is found in the East, with a long fat tail (צֶמֶר אֵלֶּיךָ, *alyah*, Arab. *alyat*, A. V. "rump"; Lev. iii, 9; vii, 8; viii, 25; ix, 19) of 10 to 15, and sometimes 40 to 50 pounds' weight, turned up at the end, and often drawn by the animal upon a board or small two-wheeled cart (Herod. iii, 118; Aristot. *Anim.* viii, 28; Pliny, viii, 75; Diod. Sic. ii, 54; Ælian, *Anim.* iii, 8; x, 4; Olear. *Persian.* v, 8; Kämpfer, *Amoen.* p. 606 sq.; Lucas, *Reise nach d. Levante*, p. 183; Russel, *Aleppo*, ii, 8; *Descript. de l'Égypte*, xxiii, 197 sq.; Oedman, *Samml.* iv, 76 sq.; comp. Korte, *Reise*, p. 429; Robinson, *Res.* ii, 169, 180; Schubert, iii, 118). That the same contrivance was customary with the Jews may be seen from the Mishna (*Shabb.* v, 4). This kind of sheep is farther distinguished from the common species of the Bedouins by its turned-up nose, and long, pendent ears. On the Mosaic enactments respecting the rights of property in sheep (Exod. xxii; Deut. xxii), see above. Compare generally BOCHART, *Hieroz.* i, 451 sq.; Michaelis, *Verm. Schrift.* i, 118 sq. In Dan. vii the Persian empire (king) is personified by a ram. See PERSIA. On this figure (which represents the subjects as a flock), see Lengerke, *Daniel*, p. 865 sq. Compare SHEEP.

2. *Goats*.—This kind of stock is usually classed with sheep under the word צֹאן, *tsan*, or (when a single head is intended) קֵזִי, *seh*, and thus associated with neat cattle, בָּקָר, *bakar'* (as in Hom. *μηλα*, then *βόες*). The terms for goats individually are: צֵן, *es*, a *he-goat*; שֵׂעִירָה, *se'irah* 'izzim' (shaggy female of the goats), a *she-goat*; for the buck, more distinctively, there are several terms: תַּיִשׁ, *ta'yish*; עֲתוּד, *atud*; שֵׂעִיר, *se'ir* (more fully עֵצִיר, *se'ir izsim*, i. e. shaggy male of the goats); צִפְרִיר, *tsaphir*; גֵּזֶה, *ge'eh*, is a collective term. Goats were reared by

the early patriarchs (Gen. xv, 9; xxxii, 14; xxxvii, 81), as by the modern Bedouins; and in later times they also formed an important element (in all the hilly regions of Palestine) of agricultural wealth



Goat of Palestine (*Capra Mambria*.)

(comp. 1 Sam. xxv, 2; Cant. vi, 5; Prov. xxvii, 26; see Ezek. xxvii, 21). They were used not only for sacrifice, but also for food (Deut. xiv, 4; comp. Buckingham, ii, 67; Robinson, i, 842; Wallsted, p. 406), especially the young males (Gen. xxvii, 9, 14, 17; Judg. vi, 19; xiii, 15; 1 Sam. xvi, 20), as still in the East (Russel, *Aleppo*, ii, 28). The milk of goats was also an article of food (Prov. xxvii, 27), being more wholesome than that of sheep (Pliny, xxviii, 83; comp. BOCHART, *Hieroz.* i, 717; Prosp. Alpin. *Res. Egypt.* p. 229). Goat-skins were only employed as clothing by poor persons, or such as chose to wear mean apparel (Heb. xi, 87). They were generally made into water or wine casks. See BOTTLE. Goat's hair was often the material of tent-cloth (Exod. xxvi, 7; xxxvi, 14; comp. Della Valle, *Trav.* i, 206; Arvieux, iii, 226; Volney, i, 806; Thevenot, iii, 196), as well as of mattresses and bedding (1 Sam. xix, 13, 16; but see on this passage Kolkar, *Quest. Bibl. spec.* ii, 56 sq.), and frequently of cloaks (Robinson, i, 279). See TENT; BOLSTER; CLOTHING. The goats of the nomadic Arabs are generally black; but in Syria (Russel, ut sup.; Thevenot, ii, 196; Rusegger, i, 712) and Lower Egypt (Sonini, i, 829) there are found goats of a large size, like the European, with hanging ears (often a foot or more in length), and of a bright red color: this species is called *Capra Mambria*. Whether the Angora goat (*Capra Angorensis* of Linn.) (see Hasselquist, p. 286; Tournefort, iii, 488; Schubert, i, 879), whose long, soft, silky hair is made into the well-known "camelot" stuff, was also indigenous to Palestine (Schulz, *Leit.* v, 28, will have it found on Lebanon), is undetermined; it is possibly that referred to in Cant. vi, 5. On the Mosaic enactment respecting the cooking of a kid in its mother's milk (Exod. xxiii, 19; xxxiv, 26; Deut. xiv, 21), see KID. The symbol of the Macedonian (Alexander's) empire by a he-goat (צִפְרִיר קֵזִיִּים) in Dan. viii, 5 sq., may be illustrated by the epithet Ægean (Αἰγαῖος, q. d. goat-men), applied to the Greek colonies on that part of the Mediterranean Sea (comp. Justin. vii, 1, 7). See MACEDONIA. See generally BOCHART, *Hieroz.* i, 708. On the Syrian wild goats, see IBEX. Comp. GOAT.

Caul (יֹתֵרֶת, *yot'he'reth*, properly a redundant part, i. e. flap, Exod. xxix, 18, 22; Levit. iii, 4, 10, 15; iv, 9; vii, 4; viii, 16, 25; ix, 10, 19) is, according to the Septuagint and Vulgate, the *great lobe of the liver*; the margin of our version says, "It seemeth by anatomy and the Hebrew doctors to be the *midriff*." The word might be rendered the lobe over the liver, although it makes a part of the liver itself, and this appears to be more applicable than the net over the liver, termed the lesser omentum. See LIVER. In Hos. xiii, 8, the Heb. word rendered "caul" of the heart is סֶגוֹר' (*segor'*, literally *enclosed*), and means the *pericardium*, or parts about the heart.

The term translated "cauls" in Isa. iii. 18 (שֵׁבִיטִים, *shebissim*), literally *nettings*, Sept. ἑμβροσμία) was perhaps a cap of network worn by females. The caps of network in the accompanying wood-cut are from a



Ancient Assyrian Hair-nets.

relief in the British Museum, representing singers and harpists welcoming Sennacherib on his return from conquest. Fig. 1 has the hair curiously arranged, but perhaps not in a caul. There is also in the British Museum a real cap of network for the hair, from Thebes, the meshes of which are very fine. See HEAD-DRESS. As to the true meaning in this passage, the versions give but little assistance. The Sept. renders ἑμβροσμία "plaited work," to which κοσμήσεις, "fringes," appears to have been added originally as a gloss, and afterwards to have crept into the text. Aquila has ῥελαμῶνας, "belts." The Targum merely adopts the Hebrew word without translating it, and the Syriac and Arabic vaguely render it "their ornaments." It occurs but once, and its root is not elsewhere found in Hebrew. The Rabbinical commentators connect it with שֵׁבִיטִים, *shibbets*, rendered "embroider" in Exod. xxviii, 39, but properly "to work in squares, make checker-work." So Kimchi (*Lex. s. v.*) explains *shebissim* as "the name of garments wrought in checker-work." Rashi says they are "a kind of network to adorn the head." Abarbanel is more full; he describes them as "head-dresses made of silk or gold thread, with which the women bound their heads about, and they were of checker-work." The word occurs again in the Mishna (*Kelim*, xxviii, 10), but nothing can possibly be inferred from the passage itself, and the explanations of the commentators do not throw much light upon it. It there appears to be used as part of a network worn as a head-dress by women. Bartenora says it was "a figure which they made upon the network for ornament, standing in front of it, and going round from one ear to the other." Schroeder (*De Vest. Mül.* cap. ii) conjectured that they were medallions worn on the necklace, and identified them with the Arab *shomaisch*, the diminutive of *shams*, the sun, which is applied to denote the sun-shaped orna-



Modern Egyptian Lady with the Safa and Turban.

ments worn by Arab women about their necks. But to this Gesenius very properly objects (*Jes. i.* 209), as well as to the explanation of Jahn (*Archäol.* I, ii, 2, 189), who renders the word "gauze veils" (Smith, s. v.). Others understand golden ornaments appended to braids of the hair behind (see Kitto's *Daily Illustration* in loc.). The hair of Oriental women is usually divided into a number of braids or tresses, which fall down upon the back, and to each of which is added three silken threads, each charged with small ornaments in gold, and terminating in small coins of the same metal (see Kitto, *Pict. Bible* in loc.; Lane, *Mod. Eg.* i, 59, 60; ii, 409, 410). See ORNAMENT.

Causeway (מַעְלָה, *mesillah*), a raised way (1 Chron. xxvi, 16, 18), or stairs of wood ("terrace," 2 Chron. ix, 11). In these passages it apparently refers to an ascent by steps, or a raised slope between Zion and the Temple, which in subsequent times was replaced by the bridge. In 2 Chron. ix, 4, it is called עֲלִיָּה (*aliyah*), an "ascent." In most of the passages where it occurs, the former word signifies any public road, and is translated "highway."

Caussin, NICHOLAS, a French Roman Catholic divine, was born at Troyes, in Champagne, in 1583, and was received in the order of the Jesuits in 1607. He taught rhetoric for a time in different colleges, and Richelieu made him confessor to Louis XIII. He died July 2, 1651. His principal work is *Cour Sainte* (5 vols. 12mo, *The Holy Court*, transl. by Sir Thomas Hawkins, Lond. 1668, fol.). It had great success from the style of its biographies and its fervid devotion. Fuller has adopted much of its style in his *Holy and Profane State*. Part of it was translated into Latin, under the title *Aula Impia Herodis* (Col. 1644, 8vo). He published also *De eloquentia sacra et humana*, libri xvi (7th edit. Lugd. 1651, 4to); *Symbolica Egyptiorum sapientia, nunc post varias editiones denuo edita* (Par. 1647, 4to).—Hoefler, *Nouv. Biog. Générale*, ix, 262.

Cavalier or Cavallier, JEAN, one of the chief leaders of the Camisards (q. v.), was born in 1679, at Ribaute, near Alaix, in Languedoc. He was a Protestant, and in the persecution of 1701 he fled to Geneva. When the insurrection in the Cévennes broke out in 1702 he joined the insurgents, and soon rose to command. With incredible skill and success he kept up the warfare until 1704, when he made a treaty with Marshal Villars. He then became a colonel in the king's service, and was even introduced at Versailles. Afterwards feeling himself to be an object of suspicion, he escaped, and subsequently went to Great Britain. Here he published his *Mémoires*, which were translated into English (Dublin, 1726, 8vo). After having commanded a regiment of Huguenot refugees at the battle of Almanza, he died, governor of Jersey, in 1740.—Smedley, *Hist. of the Reform. Rel. in France*, vol. iii, chap. xxv; Hoefler, *Nouv. Biog. Générale*, ix, 279. See CAMISARDS.

Cavallieri, GIOVANNI MICHELE, an Augustine monk of Lombardy, born at Bergamo about the end of the 17th century. He died in 1757, leaving behind him as a monument of learning and industry a work entitled *Opera omnia liturgica* (Aug. Vind. 1764, 5 vols. folio), containing a vast mass of information in the shape of commentaries on the decrees of the "Sacred Congregation of Rites" at Rome.—Hoefler, *Nouv. Biog. Générale*, ix, 284; *Biog. Univ.* tom. iii, p. 448.

Cavalry. See HORSE; CHARIOT.

Cavasilas. See CABASILAS.

Cave, properly מְעָרָה, *me'arah* (everywhere so rendered, except "den" in Isa. xxxii, 14; Jer. vii, 11; "Mearah" [q. v.] in Josh. xiii, 4); σπήλαιον ("den," except in John xi, 88); occasionally חֹר, *chor* (literally a "hole," as generally rendered; hence a *cavern*, Job xxx, 6, etc.; whence the name HORITE, i. e. *trogolydite*;

also HAINAN, i. e. *cavernous*; HOBONAIM, i. e. *two caves*; BETH-HOBON, i. e. *place in the hollow*, or בֵּית הַחֹבּוֹן , *chav* (also rendered "hole"); once מִכְלִילָה , *mechillah*, Isa. ii, 19. Grottoes seem also to be indirectly denoted by the terms מְצֻלָּה , *chagavim* ('refuges in the rocks, "clefts," Cant. ii, 14; Jer. xlix, 16; Obad. 8), and מִיַּרְדֵּן , *minharah* ('a fissure through which a stream flows, "den," Judg. vi, 2); both of which are combined in the Greek term ὄρη ("cave," Heb. xi, 38; "place" of water, James iii, 11). See DEN.

1. *As natural Features.*—The geological formation of Syria is highly favorable to the production of caves. It consists chiefly of limestone, in different degrees of density, and abounds with subterranean rivulets. The springs issuing from limestone generally contain carbonate of lime, and most of them yield a large quantity of free carbonic acid upon exposure to the air. To the erosive effect upon limestone rocks of water charged with this acid the formation of caves is chiefly to be ascribed (*Enc. Metropol.* art. Geology, p. 692, 698). Many of these have also been artificially enlarged and adapted to various purposes both of shelter and defence (Page, *Text-Book of Geology*, p. 141; Kitto, *Phys. Geogr. of Pal.* p. 72). This circumstance has also given occasion to the use of so large a number of words as are employed in the Scriptures to denote caves, holes, and fissures, some of them giving names to the towns and places and their neighborhood (Gen. xiv, 6; xxxvi, 21; Deut. ii, 12; Job xxx, 8; comp. Strabo, i, 42; xvi, 775, 776; see Burckhardt, *Syria*, 410; Robinson, ii, 424; Stanley, *Sinai and Palest.* Append. § 68-71). The subordinate strata of Syria, sandstone, chalk, basalt, natron, etc. favor the formation of caves; consequently the whole region abounds with subterranean hollows of different dimensions. Some of them are of immense extent; these are noticed by Strabo, who speaks of a cavern near Damascus capable of holding 4000 men (xvi, p. 1096, edit. 1707). This cavern is shown to the present day. Modern travels abound with descriptions of the caves of Syria. The Crusade writers record the local traditions respecting them current in their times (William of Tyre; Quaresmius, *Etucid. Ter. Sanc.*). Tavernier (*Voyage de Perse*, part ii, chap. iv) speaks of a grotto between Aleppo and Bir which would hold near 8000 horse. Maundrell has described a large cavern under a high rocky mountain, in the vicinity of Sidon, containing 200 smaller caverns (*Travels*, p. 158, 159). Shaw mentions the numerous dens, holes, and caves in the mountains on the sea-coast, extending through a long range on each side of Joppa. An innumerable multitude of excavations are found in the rocks and valleys round Wady Musa, which were probably formed at first as sepulchres, but

afterwards inhabited, like the tombs of Thebes (Robinson's *Researches*, ii, 529). Other excavations occur at Deir Dubban (ii, 858); others in the Wady leading to Santa Hannah (ii, 895). "In the mountains of Kûl'at Ibn Ma'an, the natural caverns have been *used* by passages cut in the rocks, in order to render them more commodious habitations. In the midst of these caverns several cisterns have been built; the whole would afford refuge for 600 men" (Burckhardt's *Travels*, p. 381). Almost all the habitations at Om-keis (Gadara) are caves (Burckhardt, p. 278). An extensive system of caves exists between Bethlehem and Hebron (Irby and Mangles, p. 108).

2. *Scriptural Notices.*—(1.) The first mention of a cave in Scripture relates to that into which Lot and his two daughters retired from Zoar, after the destruction of Sodom and Gomorrah (Gen. xix, 30). It was some cavern in the mountains of Moab, but tradition has not fixed upon any of the numerous hollows in that region. See ZOAR.

(2.) The next is the cave of Machpelah, in the field of Ephron, which Abraham purchased of the sons of Heth (Gen. xxv, 9, 10). There Abraham buried Sarah, and was himself afterwards buried; there also Isaac, Rebekah, Leah, and Jacob were buried (Gen. xlix, 81; i, 18). The cave of Machpelah is said to be under the Mohammedan mosque at Hebron, surrounded by a high wall called the Haram; but even the Moslems are not allowed to descend into the cavern (Benj. of Tudela, *Early Trav.* p. 86; Stanley, p. 149). The tradition that this is the burial-place of the patriarchs is supported by an immense array of evidence (Robinson, *Researches*, ii, 438-440). See MACHPELAH.

(3.) The situation of the cave at Makkedah, into which the five kings of the Amorites retired upon their defeat by Joshua, and into which their carcases were ultimately cast, is not known (Josh. x, 16, 27). It is thought by many that the cave of Makkedah can hardly be the one to which tradition has assigned the name (Irby and Mangles, p. 93); for, though it is not necessary to suppose that the cave was close to the town of Makkedah, yet the situation of the great caverns both at Beir Jibrin and at Deir Dubban in neither case agrees with that of Makkedah as given by Eusebius, eight miles from Eleutheropolis (Reland, p. 885; Robinson, ii, 852, 897; Stanley, p. 211). See MAKKEDAH.

(4.) The cave of Adullam, to which David retired to avoid the persecutions of Saul (1 Sam. xxii, 1, 2), and in which he cut off the skirt of Saul's robe (1 Sam. xxiv, 4). This, according to tradition, is an immense natural cavern at the Wady Khureitun, which passes below the Frank mountain. The site assigned by Eusebius to Adullam, 10 m. E. of Eleutheropolis, agrees little with that of this cave, which in some respects agrees with the Scripture narrative better than the neighborhood of Deir Dubban, assigned to it by Mr. Stanley (see 1 Sam. xx, 6, and particularly xxii, 3, 4; Josephus, *Ant.* vi, 12, 8; Reland, p. 549; Irby and Mangles, p. 108; Robinson, ii, 175; Stanley, p. 259). See ADULLAM.

(5.) The cave at Engedi, which afforded a retreat to David and his followers (1 Sam. xxiii, 29; xxiv, 1), can be clearly identified. The place is now called 'Ain Tidy by the Arabs, which means the same as the Hebrew, namely, "The Fountain of the Kid." "On all sides the country is full of caverns, which might serve as lurking-places for David and his men, as they do for outlaws at the present day. The whole scene is drawn to the life" (Robinson,



Caves along the Upper Jordan.

ii, 208; comp. Lynch, *Narrative*, p. 284; Stanley, p. 296). See EN-GENDI.

(6.) The cave in which Obadiah concealed the prophets (1 Kings xviii, 4) cannot now be identified, but it was probably in the northern part of the country, in which abundant instances of caves fit for such a purpose might be pointed out. See OBADIAH.

(7.) The site of the cave of Elijah (1 Kings xix, 9), as well as that of the "cleft" of Moses on Mount Horeb (Exod. xxxiii, 22), is also obviously indeterminate; for, though tradition has not only assigned a place for the former on Jebel Mûsa, and consecrated the spot by a chapel, there are caves on the competing summit of Serbâl to one or another of which it might with equal probability be transferred (Stanley, p. 49; Robinson, i, 158; Burckhardt, p. 608). See HOREB. The cave of Elijah is pretended to be shown at the foot of Mount Sinai, in a chapel dedicated to him; and a hole near the altar is pointed out as the place where he lay (Robinson, i, 152). See also CARMEL.

(8.) In the New Test. are mentioned the rock sepulchres of Lazarus (John xi, 38) and Christ (Matt. xxvii, 60); the former still shown with little probability by the monks at Bethany (see Robinson, ii, 100), and the latter a disputed question. See CALVARY.

Besides these special caves there is frequent mention in O. T. of caves as places of refuge. Thus the Israelites are said to have taken refuge from the Philistines in "holes" (1 Sam. xiv, 11), to which the name of the scene of Jonathan's conflict, Mûkhmâs (Michmash), sufficiently answers (Stanley, p. 204; Robinson, ii, 112; Irby, p. 89). So, also, in the time of Gideon, they had taken refuge from the Midianites in dens, and caves, and strongholds, such as abound in the mountain region of Manasseh (Judg. vi, 2; see Stanley, p. 341).

8. *Uses of Caves.*—(1.) Caves were used as *dwelling-places* by the early inhabitants of Syria. The Horites, the ancient inhabitants of Idumæa Proper, were troglodytes, or dwellers in caves, as their name imports. Jerome records that in his time Idumæa, or the whole southern region from Eleutheropolis to Petra and Ailah, was full of habitations in caves, the inhabitants using subterranean dwellings on account of the great heat (*Comm. on Obad. v, 6*). "The excavations at Deir Dubbân and on the south side of the wady, leading to Santa Hanneh, are probably the dwellings of the ancient Horites" (Robinson, ii, 353), and they are peculiarly numerous around Beit Jibrin (Eleutheropolis) (ii, 425). The Scriptures abound with references to habitations in rocks; among others, see Num. xxiv, 21; Cant. ii, 14; Jer. xlix, 16; Obad. 3. Even at the present time many persons live in caves. The inhabitants of Anab, a town on the east of the Jordan, all live in grottoes or caves hollowed out of the rock (Buckingham's *Travels among the Arab Tribes*, p. 61). In the neighborhood of Hebron peasants still live in caves, and especially during summer, to be near their flocks (Wilkinson's *Travels*, i, 818). Poor families live in caverns in the rocks which seem formerly to have been inhabited as a sort of village, near the ruins of El Burj; so also at Siloam, and in the neighborhood of Nazareth. For the rock-dwellings and temples of Idumæa, see PETRA.

(2.) Caves afforded excellent *refuge in the time of war*. Thus the Israelites (1 Sam. xiii, 6) are said to have hid themselves in caves, and in thickets, and in rocks, and in high places, and in pits (see also Jer. xli, 9; Josephus, *Ant.* xii, 11, 1). Hence, then, to "enter into the rock, to go into the holes of the rocks, and into the caves of the earth" (Isa. ii, 19), would, to the Israelites, be a very proper and familiar way to express terror and consternation. Such were most of the caves noticed above, especially the strongholds of Adullam and Engedi.

(3.) Not only have the caves of Palestine afforded refuge from enemies, but during the *earthquakes* also,

by which the country has been so often visited, the inhabitants have found in them a safe retreat. This was the case in the great convulsion of 1837, when Safet was destroyed; and to this mode of retreat the prophet Isaiah perhaps alludes (Isa. ii, 10, 19, 21; see Robinson, iii, 321; Stanley, p. 161).

(4.) Caverns were also frequently *fortified* when occupied by soldiers. Thus Bacchides, the general of Demetrius, in his expedition against Judæa, encamped at Messaloth, near Arbela, and reduced to submission the occupants of the caves (1 Macc. ix, 2; comp. Josephus, *Ant.* xii, 11, 1). Messaloth is probably מִסְּלֹת, *steps or terraces* (comp. 2 Chron. ix, 11; see Gesenius, *Thes.* p. 957). The Messaloth of the book of Maccabees and the robber-caves of Arbela are thus probably identical, and are the same as the fortified cavern near Mejdal (Magdala), called Kalast Ibn Maan, or Pigeon's Castle, mentioned by several travellers. They are said by Burckhardt to be capable of containing 600 men (Reland, p. 368, 575; Burckhardt, *Syria*, p. 381; Irby and Mangles, p. 91; Lightfoot, *Cent. Chorogr.* ii, 281; Robinson, iii, 279; Raumer, p. 108; comp. also Hos. x, 14). See BETE-ARBEL. Josephus also speaks of the robber inhabitants of Trachonitis, who lived in large caverns, presenting no prominence above ground, but widely extended below (*Ant.* xv, 10, 1). These banditti annoyed much the trade with Damascus, but were put down by Herod. Strabo alludes very distinctly to this in his description of Trachonitis, and describes one of the caverns as capable of holding 4000 men (Strabo, xvi, 756; Raumer, p. 68; Jolliffe, *Travels in Pal.* i, 197). Josephus (*Ant.* xiv, 15, 5) relates the manner in which one of these caves, occupied by robbers, or rather insurgents, was attacked by soldiers let down from above in chests and baskets, from which they dragged forth the inmates with hooks, and killed or thrust them down the precipices; or, setting fire to their stores of fuel, destroyed them by suffocation. These caves are said to have been in Galilee, not far from Sepphoris, and are probably the same as those which Josephus himself, in providing for the defence of Galilee, fortified near Gennesaret, which elsewhere he calls the caves of Arbela (*War*, i, 16, 2-4; ii, 20, 6; *Life*, 87). See ARBELA. This description of *caves of robbers* reminds us of our Lord's words, in which he reproaches the Jews with having made the Temple a den of thieves, σπήλαιον ληστών (Matt. xxi, 18). A fortified cavern existed in the time of the Crusades. It is mentioned by William of Tyre (xxii, 15-21) as situate in the country beyond the Jordan, sixteen Roman miles from Tiberias. Lastly, it was the caves which lie beneath and around so many of the Jewish cities that formed the last hiding-places of the Jewish leaders in the war with the Romans. Josephus himself relates the story of his own concealment in the caves of Jotapata; and after the capture of Jerusalem, John of Gischala, Simon, and many other Jews, endeavored to conceal themselves in the caverns beneath the city; while in some of them great spoil and vast numbers of dead bodies were found of those who had perished during the siege by hunger or from wounds (Josephus, *War*, iii, 8, 1; vi, 9, 4).

(5.) Natural cavities in the rock were and are frequently used for other purposes more or less akin with the above, such as stalls for horses and for granaries (Irby and Mangles, p. 146). Again, the "pits" spoken of in some of the foregoing Scripture references seem to have consisted of large wells, in "the sides" of which excavations were made leading into various chambers. See CISTERN. Such pits were sometimes used as *prisons* (Isa. xxiv, 22; li, 14; Zech. ix, 11). See PRISON. Those with *niches* in the sides were even occupied for *burying-places* (Ezek. xxxii, 28). Many of these vaulted pits remain to this day. The cave in which Lazarus was buried was possibly something of this kind. No use, indeed, of rock caverns more

strikingly connects the modern usages of Palestine and the adjacent regions with their ancient history than the employment of them as tombs or vaults (compare the early Christian CATACOMBS). The rocky soil of so large a portion of the Holy Land almost forbids interment, excepting in cavities either natural or hewn from the rock. The dwelling of the dæmonic among the tombs is thus explained by the rock caverns abounding near the sea of Galilee (Jolliffe, i, 86). Accordingly, numerous sites are shown in Palestine and adjoining lands of (so-called) sepulchres of saints and heroes of the Old and New Testaments, venerated both by Christians and Mohammedans (*Early Trav.* p. 26; Stanley, p. 148). Among these may be mentioned the cave of Machpelah, the tomb of Aaron on Mount Hor, of Joseph, and of Rachel, as those for which every probability of identity, in site at least, may be claimed (Irby and Mangles, p. 184; Robinson, i, 321, 322; iii, 96-97). More questionable are the sites of the tombs of Elisha, Obadiah, and John the Baptist at Samaria; of Habakkuk at Jobâtha (Gabatha), Micah near Keila, and of Deborah, Rebekah's nurse, at Bethel (Stanley, p. 143, 149; Reland, p. 772, 698, 981; Robinson, iii, 140). The questions so much debated relating to the tombs in and near Jerusalem and Bethany will be found treated under those heads. But, whatever value may belong to the connection of the name of judges, kings, or prophets with the very remarkable rock-tombs near Jerusalem, there can be no doubt that the caves bearing these names are sepulchral caverns enlarged and embellished by art. The sides of the valley of Jehoshaphat are studded with caves, many of which are inhabited by Arab families (Sandys, p. 188; Maundrell, p. 446; Robinson, i, 355, 516, 539; Bartlett, *Walks about Jerusalem*, p. 117). It is no doubt the vast number of caves throughout the country, together with, perhaps, as Maundrell remarks, the taste for hermit life which prevailed in the fifth and sixth centuries of the Christian æra, which has placed the sites of so many important events in caves and grottoes; e. g. the birth of the Virgin, the Annunciation, the Salutation, the birth of the Baptist and of our Lord, the scene of the Agony, of Peter's denial, the composition of the Apostles' Creed, the Transfiguration (Shaw, pt. ii, c. 1; Maundrell, *Early Travels*, p. 479); and the like causes have created a traditional cave-site for the altar of Elijah on Mount Carmel (1 Kings xviii, 19; comp. Amos iv, 8), and peopled its sides, as well as those of Mount Tabor, with hermit inhabitants (see Irby and Mangles, p. 60; Reland, p. 329; Sir J. Maundeville, *Travels*, p. 81; Sandys, p. 203; Maundrell, *Early Trav.* p. 478; Jahn, *Bibl. Arch.* p. 9; Stanley, p. 353; Kitto, *Phys. Geogr.* p. 80, 81; Van Egmont, *Travels*, ii, 5-7).—Kitto, s. v.; Smith, s. v. See SEPULCHRE.

CAVE, WILLIAM, an eminent English divine, was born at Pickwell, Leicestershire, Dec. 30, 1637. He studied at St. John's College, Cambridge, where he graduated A.B. in 1656; A.M. in 1660. In 1662 he was appointed vicar of Islington, and afterwards he became chaplain in ordinary to Charles II. In 1679 he was made rector of All-Hallows, London; in 1681 he received a canonry at Windsor, and in 1690 became vicar of Isleworth. He died at Windsor August 13, 1713. His works are: 1. *Primitive Christianity* (Lond. 1672; and several times reprinted—a French translation, Amsterdam, 1712, 2 vols. 12mo).—2. *Tabula Ecclæsiastica*, or Tables of Ecclesiastical Writers (Lond. 1674; Hamburg, 1676).—3. *Antiquitates Apostolica*, or *Lives, Acts, &c., of the Holy Apostles, and Sts. Mark and Luke* (Lond. 1676 and 1684, fol.; also, edited by Cary, Oxf. 1840, 8vo).—4. *Apostolici*, or the *Lives, Acts, &c., of the Contemporaries or immediate Successors of the Apostles*, and the most eminent of the Fathers of the first three centuries (Lond. 1677, fol.; also, edited by Cary, Oxf. 1840, 3 vols. 8vo).—5. *A Dissertation concerning the Government of the Ancient Church*, by Bish-

ops, Metropolitans, and Patriarchs (Lond. 1683, 8vo).—6. *Ecclæsiastici*, or *Lives, Acts, &c.*, of the most eminent Fathers of the fourth century (Lond. 1682, fol.).—7. *Chartophylax Ecclæsiasticus*, an improved edition of the *Tabula Ecclæsiastica* (1685, 8vo).—8. *Scriptorium Ecclæsiasticorum Historia Literaria a Christo nato usque ad Sæculum XIV* (2 vols. or parts, fol. 1688 and 1698, Lond.; reprinted at Geneva, 1705 and 1720, and at Basle, 1741; best edition that of Oxford, corrected and enlarged by Cave himself, and continued by Wharton (1740 and 1743, 2 vols. fol. The Basle edition was made upon this). Cave was a very credulous writer; destitute of critical talent, he generally took the accounts of ancient writers and Roman Catholics as he found them. Jortin calls him "the whitewasher of the ancients." Yet Dowling is justified in saying that "Cave's writings rank undoubtedly among those which have affected the progress of Church history. His smaller works greatly tended to extend an acquaintance with Christian antiquity; his *Lives of the Apostles and Primitive Fathers*, which may be regarded as an ecclesiastical history of the first four centuries, is to this very day the most learned work of the kind which has been written in our own language; and his *Historia Literaria* is still the best and most convenient complete work on the literary history of the Church. For extent and variety of learning he stands high among the scholars of his time, and he had taste and feeling to appreciate ancient piety, but he can scarcely claim any other praise."—Herzog, *Real-Encyclopædie*, Supplement, i, 183; Landon, *Ecclæ. Dictionary*, s. v.; Hook, *Ecclæ. Biography*, iii, 524; Dowling, *Introductio ad Ecclæ. Hist.* (Lond. 1838); *New Gen. Biog. Dict.* vi, 187.

CAWTON, THOMAS, a Nonconformist divine, was born at Wivenhoe, Essex, in 1637. Having studied at Utrecht and Oxford, he received ordination from the bishop of Oxford. He officiated for several years as chaplain to English noble families, but soon became so dissatisfied with the dominant party in the Established Church that he left it to become pastor of a Nonconformist congregation in Westminster, where he died in 1677. While a student at Utrecht, he published two dissertations, entitled, *Disputatio de Versione Syriaca Vet. et Novi Testamenti* (Ultraj. 1657, 4to), and *Dissertatio de usu Lingue Hebræicæ in Philosophia Theoretica* (Ultraj. 1657, 4to), the former of which is of lasting value for the history of the Syriac versions. Cawton was regarded as one of the prominent Orientalists of his time.—Kitto, *Cyclop.* s. v.; Hook, *Eccl. Biog.* iii, 526.

CAZALLA, AUGUSTIN, martyr, was born of noble parents in 1506, and was educated at the universities of Valladolid and Alcalá. Carranza (q. v.), archbishop of Toledo, became his patron; and Cazalla's talents, under such patronage, soon gained him distinction. In 1545 he became chaplain and almoner to the emperor Charles V, whom he accompanied into Germany. Here he imbibed the principles of Luther (after combating them some time), and on his return to Spain in 1552 he began to preach reform. His mother, brother, and sisters shared his religious convictions, and it is said that even Charles V was greatly moved by Cazalla's piety and arguments. The attention of the Inquisition was soon fixed on the Cazalla family, but it was not till after the emperor's death in 1558 that they were arrested and tried for heresy. At an auto da fé in May, 1559, he was strangled and then burnt, with his sister Donna Beatrice; his brother Francisco was at the same time burnt alive.—M'Crie, *Hist. of the Reformation in Spain*, p. 225 sq.; De Castro, *Spanish Protestants* (Lond. 1851), p. 114 sq.

CECIL, RICHARD, an eminent Evangelical divine of the Church of England, was born in London, November 8, 1748. His early life was bad—he was even a professed infidel; but about 1772 he was converted, and in 1778 entered Queen's College, Oxford. In 1777

he was ordained priest, and settled at Lewes; but his health failed there, and in 1780 he became minister of St. John's, Bedford Row, London. In 1800 he obtained the livings of Chobham and Bisham, Surrey. In 1808 he was attacked by a paralytic seizure, and was compelled to visit Clifton. The journey did not much, however, improve his health, and he retired in May, 1809, to Tunbridge Wells. He died August 15, 1810. "The exertions of Mr. Cecil as a preacher were immense. His talents were eminent; his eloquence was impassioned, yet solemn, and sometimes argumentative. As a Christian, he was habitually spiritually minded; modest and unassuming, he never intruded his capacities on the attention of mankind. He was contented with doing good and getting good; and his works, though few, are valuable for their sterling sense and genuine piety" (Jones). They are collected in his *Works*, edited by Pratt (London, 1811, 4 vols. 8vo), of which vol. i contains a Life of Cecil, by Pratt, with Cecil's *Lives of Bacon and Newton*, vol. ii contains sermons and miscellaneous tracts; vol. iii, thirty-three sermons; vol. iv, Cecil's *Remains*, which are among the most valuable writings on pastoral life and work, as well as on various points of practical religion, in modern times. There is also an American edition (N. Y. 1845, 3 vols. 8vo).—Pratt, *Memoir of Cecil*; Jones, *Christian Biography*, s. v.

Cecilia, one of the so-called saints of the Greek and Roman Calendar, is said to have suffered martyrdom nearly at the same time with Valerian, her husband, Tiburtius, his brother, and Maximus, an officer, about A.D. 280, under Alexander Severus, probably in some popular commotion and persecution, since that emperor was favorably inclined toward the Christians. The legendary accounts of her are not worthy of credit. As she is said to have sung praises with instrumental accompaniment just before her execution, she is regarded as the special patroness of church music. "St. Cecilia's Day" is still annually celebrated in England by a musical festival. Handel's "Messiah" was composed for it. Both Greeks and Latins celebrate her festival on the 22d of November.—A. Butler, *Lives of Saints*, Nov. 22; Landon, *Ecccl. Dict.* s. v.

Cecilianus, bishop of Carthage (A.D. 811). See DONATISTS.

Cedar (צֶדֶר, *c'ez*, from its deep root or compressed form; Gr. κέδρος) occurs in numerous places of Scripture, but authors are not agreed on the exact meaning of the term. Celsius (*Hierobot.* i, 106, sq.), for instance, conceives that it is a general name for the pine tribe, to the exclusion of the cedar of Lebanon, which he considers to be indicated by the word *berosh*, or "fir." The majority of authors, however, are of opinion that the cedar of Lebanon (*Pinus cedrus*, or *Cedrus Libani* of botanists) is alone intended. This opinion is confirmed by the Septuagint and Vulgate, which uniformly (as in the English version) render the word by κέδρος, *cedrus*; and also by the fact that the Arabic name for the cedar of Lebanon is *arz*, evidently cognate with *erez*. The following statements are chiefly compiled from Kitto and Smith, s. v. See BOTANY.

1. The earliest notice of the cedar is in Lev. xiv, 4, 6, where we are told that Moses commanded the leper that was to be cleansed to make an offering of two sparrows, cedar-wood, wool dyed in scarlet, and hyssop; and in ver. 49, 51, 52, the houses in which the lepers dwell are directed to be purified with the same materials. Again, in Num. xix, 6, Moses and Aaron are commanded to sacrifice a red heifer: "And the priest shall take cedar-wood, and hyssop, and scarlet." Here the proper cedar can hardly be meant, as it does not grow in Egypt, and its wood is scarcely aromatic. The variety called *juniper* is evidently intended, the wood and berries of which were anciently applied to such purposes. The term cedar is applied by Pliny 'the lesser cedar, *oxycedrus*, a Phœnician juniper,

which is still common on the Lebanon, and whose wood is aromatic. The wood or fruit of this tree was anciently burnt by way of perfume, especially at funerals (Pliny, *H. N.* xiii, 1, 5; Ovid, *Fast.* ii, 568; Homer, *Od.* v, 60). The tree is common in Egypt and Nubia, and also in Arabia, in the Wady Mousa, where the greater cedar is not found. It is obviously likely that the use of the more common tree should be enjoined while the people were still in the wilderness, rather than of the uncommon (Shaw, *Travels*, p. 464; Burckhardt, *Syria*, p. 480; Russell, *Nubia*, p. 425). See JUNIPER.

At a later period we have notices of the various uses to which the wood of the *erez* was applied, as 2 Sam. v, 11; vii, 2-7; 1 Kings v, 6, 8, 10; vi, 9, 10, 15, 16, 18, 20; vii, 2, 3, 7, 11, 12; ix, 11; x, 27; 1 Chron. xvii, 6; 2 Chron. ii, 8; ix, 27; xxv, 18. In these passages we are informed of the negotiations with Hiram, king of Tyre, for the supply of cedar-trees out of Lebanon, and of the uses to which the timber was applied in the construction of the Temple, and of the king's palace: he "covered the house with beams and boards of cedar; "the walls of the house within were covered with boards of cedar;" there were "cedar pillars," and "beams of cedar;" and the altar was of cedar. But in these passages of Scripture, likewise, the common cedar cannot well be signified, as the wood is neither hard nor strong enough for building purposes. Other kindred varieties of trees, however, doubtless existed in the same locality with the cedar of Lebanon, which were suitable in these respects, as well as on account of beauty and durability, for architecture. Perhaps nothing more is meant than the *pinus*-tree, which is known to grow on Mt. Lebanon. This opinion seems to be confirmed by Ezek. xxvii, 5: "They have made all thy ship-boards of fir-trees of Senir; they have taken cedar from Lebanon to make masts for thee;" for it is not probable that any other tree than the common pine would be taken for masts, when this was procurable. Also in the second Temple, rebuilt under Zerubbabel, the timber employed was cedar from Lebanon (Ezra iii, 7; 1 Esdr. iv, 48; v, 55). Cedar is also said by Josephus to have been used by Herod in the roof of his temple (*War.* v, 5, 2). The roof of the rotunda of the church of the Holy Sepulchre at Jerusalem is said to have been of cedar, and that of the church of the Virgin at Bethlehem to have been of cedar or cypress (Williams, *Holy City*, ii, 202; Quaresimus, *Educ. Terr. Sanct.* vi, 12; Tobler, *Bethlehem*, p. 110, 112). See PINE.

It may here also be remarked that the Syriac and Heb. interpreters generally, at Isa. xli, 19; lx, 18, render the word *cedrus* (צֶדֶר, literally *erectness*), translated in our version (after the Vulg. and Chaldee) "box-tree," by *asherim*-cedar, a species of cedar distinguished by the smallness of its cones and the upward direction of its branches (see Rosenmüller, *Athenæum* IV, i, 292). Another form of this word, צֶדֶר, *ashur*, occurring in Ezek. xxvii, 6, has there been mistranslated in our version by "Ashurites," where the clause "the company of the Ashurites have made thy benches of ivory," is literally, "thy benches they make of ivory, the daughter of the *ashur*-wood," i. e. inlaid or bordered with it. For a full account of the various readings of that passage, see Rosenmüller's *Schol.* in Ezek. xxvii, 6. The most satisfactory translation appears to be that of Bochart (*Geog. Sac.* i, iii, c. 5, 180) and Rosenmüller: "Thy benches have they made of ivory, inlaid with box-wood from the isles of Chittim." Now it is probable that the isles of Chittim may refer to any of the islands or maritime districts of the Mediterranean. Bochart believes Corsica is intended in this passage; the Vulg. has "de insulis Italie." Corsica was celebrated for its box-trees (Plin. xvi, 16; Theophrast. *H. P.* iii, 15, § 5), and it is well known that the ancients understood the art of veneer-

ing wood, especially box-wood, with ivory, tortoise-shell, etc. (Virg. *Aen.* x, 137). However, Celsius (*Hierob.* i, 80) and Sprengel (*Hist. Rei Herb.* i, 267) identify the *sharbin* with the *Pinus cedrus* (Linn.), the cedar of Lebanon. See BOX-TREE.

If, on the other hand, we consider some of the remaining passages of Scripture, we cannot fail to perceive that they forcibly apply to the cedar of Lebanon, and to the cedar of Lebanon only. Thus, in Psa. xcii, 12, it is said, "The righteous shall flourish like a palm-tree, and spread abroad like a cedar of Lebanon." But Ezekiel (chap. xxxi) is justly adduced as giving the most magnificent, and, at the same time, the most graphic description of this celebrated tree (comp. Homer, *Il.* xiii, 359; Virgil, *Æn.* ii, 626; v, 447; Horace, *Od.* iv, 6). The other principal passages in which the cedar is mentioned are 1 Kings iv, 33; 2 Kings xix, 23; Job xl, 17; Psalms xxix, 5; lxxx, 10; civ, 16; cxlviii, 9; Cant. i, 17; v, 15; viii, 9; Isa. ii, 13; ix, 10; xiv, 8; xxxvii, 24; xli, 19; xlv, 14; Jer. xxii, 7, 14, 23; Ezek. xvii, 8, 22, 23; Amos ii, 9; Zeph. ii, 14; Zech. xi, 1, 2; and in the Apocrypha, Ecclus. xxiv, 13; i, 12. See TREE.

The conditions to be fulfilled in order to answer all the descriptions in the Bible of a cedar-tree are that it should be tall (Isa. ii, 18), spreading (Ezek. xxxi, 8), abundant (1 Kings v, 6, 10), fit for beams, pillars, and boards (1 Kings vi, 10, 15; vii, 2), masts of ships (Ezek. xxvii, 5), and for carved work, as images (Isa. xlv, 14). To these may be added qualities ascribed to cedar-wood by profane writers. Pliny speaks of the cedar of Crete, Africa, and Syria as being most esteemed and imperishable. In Egypt and Syria ships were built of cedar, and in Cyprus a tree was cut down 120 feet long and proportionately thick. The durability of cedar was proved, he says, by the duration of the cedar roof of the Temple of Diana at Ephesus, which had lasted 400 years. At Utica the beams, made of Numidian cedar, of a temple of Apollo had lasted 1178 years! (Pliny, *Hist. Nat.* xiii, 5; xvi, 40). Vitruvius (ii, 9) speaks of the antiseptic properties of the oil of cedar (comp. Josephus, *Ant.* viii, 5, 2; Sandys, *Travels*, p. 166, 167). The corresponding Arabic word, *arz*, is used to express not only the cedar of Lebanon, but also at Aleppo the *Pinus sylvestris*, which is abundant both near that city and on Lebanon. A similar statement will apply also to the *Thuja articulata* of Mount Atlas, which is called by the Arabs *el-ars*, a name that led to the mistake as to the material of the Cordova roof from its similarity to the Spanish *alerce* (Niebuhr, *Descr. de l'Arabie*, p. 131, etc., and *Questions*, xc, 169, etc.; Pliny, *H. N.*, xiii, 11, 15; Hay, *West Barb.* c. iv, 49; Gesenius, *Thes.* p. 148). Besides the trees which belong to the one grove, known by the name of "the Cedars," groves and green woods of cedar are found in other parts of the range (Buckingham, *Travels among the Arabs*, p. 468; *Eng. Cyclopaedia*, s. v. Syria; Robinson, new ed. of *Res.* iii, 593; Burckhardt, *Syria*, p. 19; Loudon, *Arboretum*, iv, 2408, 2407; Celsius, *Hierobotan.* i, 89; Belon, *Obs. de arboribus comiferis*, ii, 162, 165, 166). The remains of wood used in the Nineveh palaces were supposed by Layard to be cedar, a supposition confirmed by the inscriptions, which show that the Assyrian kings imported cedar from Lebanon. This wood is now proved by microscopic examination to be yew (Layard, *Nin. and Bab.* p. 356, 357; Loudon, *ut sup.* p. 2431). See FIR.

2. The modern CEDAR OF LEBANON is well known to be a widely-spreading tree, generally from 50 to 80 feet high, and, when standing singly, often covering a space with its branches the diameter of which is much greater than its height. The



Cedar of Lebanon (*Cedrus Libani*).

horizontal branches, when the tree is exposed on all sides, are very large in proportion to the trunk, being disposed in distinct layers or stages, and the distance to which they extend diminishes as they approach the top, where they form a pyramidal head, broad in proportion to its height. The branchlets are disposed in a flat, fan-like manner on the branches (see Shelby, *Forest Trees*, p. 522). The leaves, produced in tufts, are straight, about one inch long, slender, nearly cylindrical, tapering to a point, and are on short footstalks. The male catkins are single, solitary, of a reddish hue, about two inches long, terminal, and turning upwards. The female catkins are short, erect, roundish, and rather oval; they change after fecundation into oval oblong cones, which, when they approach maturity, become from 2½ inches to 5 inches long. Every part of the cone abounds with resin, which sometimes exudes from between the scales. As its leaves remain two years on the branches, and as every spring contributes a fresh supply, the tree is an evergreen, in this resembling other members of the fir family, which, the larches excepted, retain the same suit for a year or upwards, and drop the old foliage so gradually as to render the "fall of the leaf" in their case imperceptible. As far as is at present known, the cedar of Lebanon is confined in Syria to one valley of the Lebanon range, viz. that of the Kedisha River, which flows from near the highest point of the range westward to the Mediterranean, and enters the sea at the port of Tripoli. The



General view of the Cedars.

grove is at the very upper part of the valley, about 15 miles from the sea, 6000 feet above that level, and their position is moreover above that of all other arborescent vegetation. Belon, who traveled in Syria about 1550, found the cedars about 28 in number, in a valley on the sides of the mountains. Rauwolf, who visited the cedars in 1574, "could tell no more but 24, that stood round about in a circle; and two others, the branches whereof are quite decayed from age." De la Roque, in 1688, found but 20. Maundrell, in 1696, found them reduced to 16; and Dr. Pococke, who visited Syria in 1744 and 1745, discovered only 15. "The wood," he says, "does not differ from white deal in appearance, nor does it seem to be harder. It has a fine smell, but is not so fragrant as the juniper of America, which is commonly called cedar, and it also falls short of it in beauty." M. Lamartine, in 1832, says, "These trees diminish in every succeeding age. There are now but 7. These, however, from their size and general appearance, may fairly be presumed to have existed in biblical times. Around these ancient witnesses of ages long since past there still remains a little grove of yellow cedars, appearing to me to form a group of from 400 to 500 trees or shrubs. Every year, in the month of June, the inhabitants of Beshierai, of Eden, of Kandbin, and the other neighboring valleys and villages, climb up to these cedars and celebrate mass at their feet." Dr. Graham gives the following measurements of the twelve largest cedars: the circumferences of the trunk at the base respectively 40 feet, 38, 47, 18½, 30, 22½, 28, 25½, 38½, 29½, 22, 29½; the largest having thus a diameter of nearly 16 feet (*Jordan and the Rhine*, p. 26). Within a few years past a chapel has been erected there (Robinson, *Later Res.* p. 590, 591; Stanley, *Sinai and Pal.* p. 140). See Trew's treatises, *Cedror. Libani Hist. and Apologia de cedro Lib.* (Norimb. 1757 and 1767); *Penny Cyclop.* s. v. Abies; Thomson, *Land and Book*, i, 292 sq.; especially Dr. Hooker, in the *Nat. History Review*, Jan. 1862, p. 11-18; and Mr. Jessup, in the *Hours at Home*, March and April, 1867.

Ce'dron, the name of a place and of a rivulet.

1. (ἡ Κεδρών v. r. Κεδρώ.) A place fortified by Cendebeus, under the orders of king Antiochus (Sidetes), as a station from which to command the roads of Judea (1 Macc. xv, 39, 41; xvi, 9). It was not far from Jamnia (Jabneh), or from Azotus (Ashdod), and had a winter-torrent or wady (χειμάρρου) on the eastward of it, which the army of the Maccabees had to cross before Cendebeus could be attacked (xvi, 5). These conditions are well fulfilled in the modern place *Katra* or *Kiṭra*, which lies on the maritime plain below the river Rubin, and three miles south-west of Akir (Ekron). Schwarz (*Palest.* p. 119) gives the modern name as *Kadrin*, but this wants confirmation. Ewald (*Isr. Gesch.* iv, 390, note) suggests *Tell-Turmus*, five or six miles farther south. The Syriac has *Hebron*, and the Vulg. *Gedor*, which some compare with the village *Gedrus* (Κέδρου), mentioned by Eusebius and Jerome (*Onomast.* s. v. Γεδούρ, Gædur) as lying ten miles from Diopolis, toward Eleutheropolis.

2. In this form is given in the N. T. the name of the brook Kidron (כִּדְרוֹן) = "the black torrent" in the ravine below the eastern wall of Jerusalem (John xviii, 1). Lachman, with codices A and D, has χειμάρρου τῷ Κεδρών; but the Rec. Text with B has τῶν Κεδρών, i. e. "the brook of the cedars" (so, too, the Sept. in 2 Sam. xv, 28). Other MSS. have the name even so far corrupted as τῷ κέδρου (so N), *cedri*, and τῶν δένδρων. The word, however, has no connection with "cedar." In English, the name in this form is often erroneously pronounced (as if written *Kedron*) with a hard C.—Smith, s. v. See **KIDRON**.

Cel'lan (Κελαν, Vulg. *Ciaso*), a person named (1 Eedr. v, 15) as the family head (in connection with Azetas) of seventy-seven Israelites who returned from

Babylon; but the Heb. texts (Ezra ii, 16; Neh. vii, 21) do not contain either name.

Ceiling. There are three Heb. words employed in the Old Test. which our translators have rendered "celled" or "ceiling." 1. חָפְזָא (*chaphzā*), to cover or overlay, as it is elsewhere rendered) occurs 2 Chron. iii, 5, where it is said, "He ceiled the greater house with fir-tree." 2. אֶפְסָא (*asaphā*), to wainscot or plank; elsewhere rendered "cover," once "seat," Deut. xxxiii, 21) occurs Jer. xxii, 14: "It is ceiled with cedar, and painted with vermilion." Houses finished in this manner were called "celled houses" (Hag. i, 4). The "ceiling" of the walls itself is likewise spoken of (שִׁפּוּץ, *sippuz*, 1 Kings vi, 15). In Ezek. xli, 16, the word rendered "celled" is שַׁחֲפָא (*shachpā*), from being *heved thin*, a board simply, used for that purpose. These ceilings were adorned with ornaments in stucco, with gold, silver, gems, and ivory. Oriental houses appear to have been the reverse of such as we inhabit, the ceiling being of wood richly ornamented and painted, and the floor plaster or stucco, the walls being generally wainscoted. The Egyptian monuments still exhibit elegant specimens of painted ceilings, no doubt



Patterns of ancient Egyptian Ceilings.

greatly resembling those mentioned in the above texts (Wilkinson's *Anc. Egypt.* ii, 125). According to Mr. Layard, in the ancient Assyrian houses also "the ceilings overhead were divided into square compartments, painted with flowers or with the figures of animals. Some were inlaid with ivory, each compartment being surrounded by elegant borders and mouldings" (*Nineveh*, ii, 208). The following remarks are from Smith's *Dict.* s. v.: The descriptions of Scripture (1 Kings vi, 9, 15; vii, 8; 2 Chron. iii, 5, 9; Jer. xxii, 14; Hag. i, 4) and of Josephus (*Ant.* viii, 3, 2-9; xv, 11, 5) show that the ceilings of the Temple and the palaces of the Jewish kings were formed of clear planks applied to the beams or joints crossing from wall to wall, probably with sunk panels (*παρνώματα*), edged and ornamented with gold, and carved with incised or other patterns (*βαθυκύλοις γλυφαῖς*), sometimes painted (Jer. xxii, 14). It is probable that both Egyptian and Assyrian models were in this, as in other branches of architectural construction, followed before the Roman period. See **ARCHITECTURE**. The construction and designs of Assyrian ceilings in the more important buildings can only be conjectured (Layard, *Nineveh*, ii, 265, 289), but the proportions in the walls themselves answer in a great degree to those mentioned in Scripture (*Nin. and Bab.* p. 642; Ferguson, *Hand-book of Architecture*, i, 201). Examples, however, are extant of Egyptian ceilings in stucco painted with devices of a date much earlier than that of Solomon's Temple. Of these devices, the principal are the guilloche, the chevron, and the scroll. Some are painted in blue, with stars, and others bear representations of birds and other emblems (Wilkinson, *Anc. Egypt.* ii, 290). The excessive use of vermilion and other glaring colors in Roman house-painting, of which Vitruvius at a later date complains (vii, 5), may have been introduced from Egypt, whence also came, in all probability, the taste for vermilion painting shown in Jehoiakim's palace (Jer. xxii, 14; Amos iii, 15; Wilkinson, i, 19). See also the descriptions given by Athenæus (v, 196) of the tent of Ptolemy Philadelphus and the ship of Philopator (ib. 206), and of the so-called sepulchres of the kings of Syria, near Tyre, by Hasselquist (p. 165). The

panel-work in ceilings which has been described is found in Oriental and North African dwellings of late and modern time. Shaw describes the ceilings of Moorish houses in Barbary as of wainscot, either "very artfully painted, or else thrown into a variety of panels, with gilded mouldings and scrolls of the Ko-

Blue. 
 Green. 
 Red. 

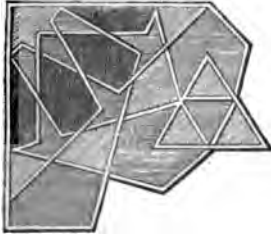

Modern Egyptian Ceiling with different Colors.

ran intermixed" (*Trav.* p. 208). Mr. Porter describes the ceilings of houses at Damascus as delicately painted, and in the more ancient houses with "arabesques" encompassing panels of blue, on which are inscribed verses and chapters of the Koran in Arabic; also a tomb at Palmyra, with a stone ceiling beautifully panelled and painted (*Damascus*, i, 34, 87, 57, 60, 232; comp. Deut. vi, 9; see also Lane's *Mod. Egypt.* i, 37, 38; Thomson, *Land and Book*, ii, 571). Many of the rooms in the Palace of the Moors at the Alhambra were ceiled and ornamented with the richest geometrical patterns. The ancient Egyptians used colored tiles in their buildings (*Athen.* v, 206; Wilkinson, ii, 287). The like taste is observed by Chardin to have prevailed in Persia, and he mentions beautiful specimens of mosaic, arabesque, and inlaid wood-work in ceilings at Isbahan, at Koom in the mosque of Fatima, and

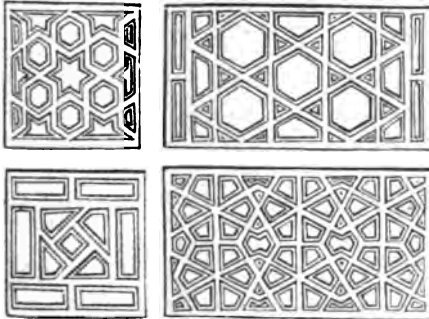

Panel-work in modern Egyptian Ceilings.

at Ardevil. These ceilings were constructed on the ground, and hoisted to their position by machinery (*Chardin, Voyage*, ii, 484; iv, 126; vii, 887; viii, 40, plate 39; Olearius, p. 241). See HOUSE.

Ceillier, DOM RÉMY, an eminent French theologian, was born at Bar-le-Duc in 1688. He entered the order of St. Benedict in 1705, and became titular prior of Flavigny. In 1718 he published, *Apologie de la morale des Peres de l'Église, contre Jean Barbeyrac*; but the work of his life was his *Histoire Générale des Auteurs Sacrés et Ecclésiastiques* (1729-1763, 23 vols. 4to)—a work more complete, and perhaps more accurate than that of Dupin, although inferior to him in the analysis of books. A new edition has appeared (Paris, 1860-65, 15 vols. 8vo), with additions, but unfortunately thus far without general indexes. The chief superiority of Ceillier over Dupin lies in his treatment of the writers of the first six centuries, in which he had the use of Tillemont, and also of the Benedictine editions of the fathers. In the Middle Ages, and especially in the scholastic theology, for which he had no taste, he does not equal Dupin. Ceillier died Nov. 17, 1761.—*Biog. Universelle*, s. v.

Ceimeliarohæ (κεμηλιάρχοι, *keepers of the sacred vessels*), a class of inferior officers in the ancient church. They had charge of all utensils and precious things laid up in the sacred repository of the church. The name *scetophylax* is used in the same signification; also *chartophylax*, or *custos archivorum*, custodian of the rolls or archives (Suicer, *Theaurus*, ii, 971). This officer was commonly a presbyter; Macedonius was both presbyter and scetophylax of the church of Constantinople; and Sozomen styles Theodore, presbyter of Antioch, who suffered martyrdom in the days of Julian, φύλακα τῶν κημηλίων, "keeper of the sacred utensils." He was put to death because he would not deliver up what he had in his custody. In the Greek Church the chartophylax acts as the patriarch's substitute, excommunicating and licensing presbyters and deacons, and sitting as supreme ecclesiastical judge in many cases.—Bingham, *Orig. Eccl.* bk. liii, ch. xiii, § 3; Sozomen, *Hist. Eccl.* v, 8.

Celestine (or CELESTIN) I, Pope, a Roman by birth, was elected Pope in 422, on the death of Boniface I. During his pontificate the Council of Ephesus, against Nestorius, was held, upon which occasion he wrote several letters to the Eastern churches. He claimed authority and primacy in the Roman See, and sought to exercise it over the African Church in vain. In the Nestorian dispute above mentioned he was more successful, as Cyril, in order to put down Nestorius, accepted the authority of Celestine against him. He left thirteen letters; among them is a complaint as to the dress of bishops; but it is doubtful whether it means that the clergy should dress like the laity, or should abstain from some special garment which some had adopted. He died March 25 (or July 26), 432. Celestine is said to have sent Palladius and St. Patrick as missionaries to Ireland, but the story is very doubtful. It is not clear that either of them ever had any connection with Rome. His letters are preserved in the Collection of Councils. He is counted among the saints of the Church of Rome.—*Biog. Univ.* vii, 497; *Cormenin, Lives of the Popes*, i, 79.

II. Pope, originally Guido, of Città di Castello, in Tuscany, studied under Abelard, and succeeded Innocent II September 25th, 1148. He died in March, 1144.

III. Pope, a Roman named Iacinto Orsini, cardinal of Santa Maria, was elected Pope March 30, 1191, at eighty-five. He crowned Henry V and his wife Constance, and made a great display of arrogance in doing it; entered warmly into the scheme for delivering the Holy Land, on which account he espoused the cause of Richard I of England, and culminated censures against Leopold of Austria and the emperor, who detained Richard prisoner. He died January 8, 1198. During his last illness he proposed to transfer his papal authority to cardinal Colonna, to which, of course, the cardinals objected.

IV. Pope, originally called Goffredo, of the family of Castiglione, of Milan. He was elected Pope September 20, 1241, and died on the 8th of October following.

V. Pope, originally Pietro de Murrone, was born 1215 at Isernia. With a few companions he withdrew to a cave on Monte Majella, where he lived a life of extreme austerity. After a time his disciples multiplied so greatly that he was induced to form them into a new order (called first the congregation of *St. Damian*, but subsequently the order of *Celestines*), under the rule of St. Benedict. This order was confirmed by Gregory X in the Synod of Lyons, 1274. On the 15th of July, 1294, he was elected pope, and took the name of Celestine V. He proved to be too ignorant of the world and its ways, as well as of literature, for the office which he was so suddenly called upon to undertake. Feeling his unfitness, and finding that many abuses were committed in his name, he resigned Dec. 13, 1294, and retired to his solitude. He was cruelly imprisoned by

his successor Boniface, who detained him in custody until his death, May 19, 1296. Clement V canonized him, and his day in the calendar is May 19.—Moseheim, *Ch. Hist.* i, 849; Hoefler, *Nouv. Biog. Générale*, ix, 846.

Celestines, or **CELESTINES** (I.), an order of barefooted Minorites (see **DISCALCEATI**); (II.) a monastic order, so called from the founder, Pietro de Murrone, afterwards Celestine V, in 1254. After his death his order made great progress, not only in Italy, but likewise in France, whither the then general, Peter of Tivoli, sent twelve religious, at the request of king Philip the Fair, who gave them two monasteries, one in the forest of Orleans, and the other in the forest of Compeigne, at Mount Chartres. This order had at one time 200 monasteries in Italy, France, Germany, and the Netherlands. They had about ninety-six convents in Italy, and twenty-one in France, under the name of priories. Their Constitutions consisted of three parts: the first refers to the provincial chapters and the election of superiors; the second contains the regular observances; and the third, the visitation and correction of the monks. The rule required the Celestines to rise two hours after midnight to say matins; to eat no flesh except when in sickness; to fast every Wednesday and Friday from Easter to the feast of the Exaltation of the Holy Cross; and from that feast to Easter, every day. Their dress was a white gown, a capuche, and a black scapulary; in the choir, and out of the monastery, a black cowl with the capuche; shirts of serge. The order is decayed; in Italy a few monasteries survive. See **FRANCISCANS**.

Celestius. See **CELESTIUS**.

Celibacy (*calibatus*, Lat. *cælebs* or *cælebs*, unmarried, derived by some Roman writers from *cali beatitudo*, the blessedness of heaven), the state of virginity, or of unmarried persons.

I. *In the Scripture*.—Under the Mosaic law, priests were not only allowed, but encouraged to marry. The priesthood was confirmed to the descendants of one family, and consequently involved even an obligation to marry. In the N. T. we find passages in which an unmarried life, voluntarily assumed, is commended, under certain circumstances (Matt. xix, 12; 1 Cor. vii, 1-35). But no passage in the N. T. can be interpreted into a prohibition against the marriage of the clergy under the Gospel dispensation; on the contrary, there are many from which we may infer the contrary. One of the twelve, Peter, was certainly a married man (Matt. viii, 14), and it is supposed that several of the others were also married. Philip, one of the seven deacons, was also a married man (Acts xxi, 9); and if our Lord did not require celibacy in the first preachers of the Gospel, it cannot be thought indispensable in their successors. Paul says, "Let every man have his own wife" (1 Cor. vii, 2); and that marriage is honorable in all (Heb. xiii, 4), without excepting those who are employed in the public offices of religion. He expressly says that "a bishop must be the husband of one wife" (1 Tim. iii, 2); and he gives the same direction concerning elders, priests, and deacons. When Aquila traveled about to preach the Gospel, he was not only married, but his wife Priscilla accompanied him (Acts xviii, 2); and Paul insists that he might have claimed the privilege "of carrying about a sister or wife (1 Cor. ix, 5), as other apostles did." The "forbidding to marry" (1 Tim. iv, 3) is mentioned as a character of the apostasy of the latter times.

II. *In the Early Church*.—At an early period virginity came to be held in honor in the Church. Several passages of the N. T. (e. g. Matt. xix, 10, 12; 1 Cor. vii, 7, 8) in which *voluntary* virginity for "the kingdom of heaven's" sake is commended under certain circumstances, were interpreted as favoring asceticism and as depreciating marriage. Moreover, in the old Pagan times celibacy had been held in honor (e. g. the

Vestal Virgins). Wherever dualistic ideas of a good and evil principle, and of matter as the seat of evil, prevailed, there it was natural that ascetic notions of virginity should arise. An undue regard for virginity, and corresponding depreciation of marriage, began to appear strongly about the middle of the second century, and reached their height in the fourth. Few of the so-called fathers escaped from extravagant notions and opinions on this subject; in fact, their errors here have done more, perhaps, than any other cause to weaken their authority as guides for the Church (see Taylor, *Ancient Christianity*, passim). But no enforced celibacy of the clergy was known in the Church immediately following the apostolic age. Bingham collects the facts carefully (*Orig. Eccles.* bk. iv, ch. v) to the following effect. In the age immediately succeeding that of the apostles we read of the wives of Valens, presbyter of Philippi (Polycarp, *Ep. ad Philip.* ii, 11), of Chæremón, bishop of Nilus (Euseb. vi, c. 42), of Novatus, presbyter of Carthage (Cyprian, *Ep.* 49), of Cyprian himself, of Cæcilius, who converted him (*Pont. Vit. Cyp.*), and of several other bishops and presbyters. But it has been said by the advocates of celibacy that married persons promised to separate themselves from their wives as soon as they should receive ordination. The history of Novatus distinctly proves the contrary. He was accused, long after he was a presbyter, of having caused the miscarriage of his wife by a passionate blow. In fact, throughout the first three centuries we read of no enforced celibacy. Chrysostom expressly combats the notion that the clergy, peculiarly, were required to live unmarried (*Ep. 1 ad Cor.*: *Hom. XIX* ad 1 Cor. vii, 1). But the first step towards clerical celibacy was taken in the disapproval of *second* marriages. "Yet so late as the beginning of the third century there were many clergymen in the Catholic Church who were married a second time. This appears from the accusation of Tertullian, who asks the Catholics, with Montanistic indignation: '*Quot enim et bigami president apud vos, insulantes utique apostolo? . . . Digamus tinguis? digamus offers?*'" Second marriage thus seems to him to disqualify for the administration of the sacraments of baptism and the Lord's Supper. Hippolytus, in the *Philosophoumena*, reproaches the Roman bishop Callistus with admitting to sacerdotal and episcopal office those who were married the second and even the third time, and allowing the clergy to marry after having been ordained. The next step was the disapproval of even one marriage for the clergy, but not yet the prohibition of it. The priesthood and marriage became more and more incompatible in the prevailing view. The Montanists shared in this feeling; among the oracles of the prophetess Prisca is one to the effect, "Only a holy (that is, an unmarried) minister can administer in holy things." Even those fathers who were married, like the presbyter Tertullian and the bishop Gregory of Nyssa, gave decided preference to virginity. The apostolical constitutions and some provincial councils accordingly prohibited priests not only from marrying a widow, or a divorced woman, or a slave, and from second marriage, but also from contracting marriage after ordination. The Synod of Ancyra, in 814, allowed it to deacons, but only when they expressly stipulated for it before taking orders. The rigoristic Spanish Council of Elvira (Iliberis), in 805, went farthest. It appears even to have forbidden the continuance of nuptial intercourse after consecration upon pain of deposition" (Schaff, *Church Hist.* i, § 96).

Phileas, bishop of Thumis, and Philoromus, had both wife and children, and were on that account urged by the heathen magistrate to deny the faith and save themselves (Euseb. lib. vi, cap. 42; lib. viii, cap. 9). Eusebius (iv, 28) tells us how Pinytus, bishop of Gnoesus, in Crete, being desirous to enforce celibacy, was rebuked by Dionysius, bishop of Corinth. In the great Council of Nicaea it was proposed to enact a law to

that effect, but Paphnutius, an Egyptian bishop, himself unmarried, resolutely withstood it as an innovation, declared that marriage is honorable "in all men," and desired that the ancient tradition of the Church should continue to be observed, viz. that those who before ordination were unmarried should continue to be so (Socrates, *H. E.* i. 11; Sozomen, *H. E.* i. 28). The only reply which Bellarmine and Valesius give to this statement is to suspect the veracity of the historians; in which they are followed by Thomassin, who, cautious and judicious as he is, scruples not to say that Socrates and Sozomen are not such irreproachable writers, nor of such weight, that we need believe their word in a matter of such importance. In opposition to all this, Roman writers allege the testimony of Epiphanius and Jerome, and the tenth canon of Ancyra, which forbids deacons who did not, at ordination, declare their intention to marry, to do so afterwards. But all these testimonies are subsequent to the third century; and the Council of Gangra, held probably about 879, long after that of Ancyra, anathematizes those who separate from the communion of a married priest: "*Si quis discernit presbyterum conjugatum, tanquam occasione nuptiarum quod offerre non debeat et ab ejus oblatione ideo se obtinet, anathema sit*" (Canon iv). See Wilson, *The Doctrine of the Apostolic Fathers* (Liverpool, 1845), p. 178 sq.; and the article EUSTATHIUS.

III. *In the Church of Rome.*—Siricius, bishop of Rome (A.D. 385), decided against the Canon of Gangra (*ad Himer. Tarraconensem*, ep. i. c. 7, in c. 3, 4, dist. lxxxii), asserting that the reason why, in the O. T., priests were allowed to marry, was because they could be taken only from the tribe of Levi. He argued, therefore, as no such tribal limitation exists in the Christian Church, that *obscenæ cupiditates* (i. e. marriage) are inconsistent with the clerical office. The Roman bishops after Siricius adhered to his theory, and the Church generally seems to have followed them (Decretals of Innocent I, A.D. 404, 405, c. 4-6, dist. xxxi; of Leo I, 446-456, in c. i, dist. xxxii; c. 10, dist. xxxi, etc.; Conc. Carth. ii, A.D. 390, c. 2, in c. 3, dist. xxxi; c. 8, dist. lxxxiv; Conc. Carth. v, A.D. 401, c. 8, in c. 13, dist. xxxii; c. 4, dist. lxxxiv, etc.). The prohibition applied at first only to bishops, priests, and deacons, but from the fifth century onward subdeacons were prohibited marriage after ordination (Leo I, A.D. 448, in c. 1, dist. xxxii; Gregory I, A.D. 591-94, in c. 1, dist. xxxi; c. 2, dist. xxxii; Conc. Agath. A.D. 506, c. 89, in c. 19, dist. xxxiv, etc.). The clergy of the minor orders were allowed to marry once, but not with widows (Conc. Carth. v, A.D. 401, c. 8, in c. 18, dist. xxxii; Greg. I, A.D. 601, in c. 8). The civil law confirmed these regulations, enacting that married persons, or such as had children or grandchildren, should not be chosen as bishops. It was farther enjoined by the civil law that all marriages of higher clergy after their ordination should be held as invalid, and the children of such marriages illegitimate (Herzog, *Real-Encyclopædie*, vii, 772).

For centuries this question of the celibacy of the clergy was a subject of constant struggle within the Church. Unnatural crimes abounded among the clergy; their office, in the ninth and tenth centuries, seemed to be held as a license for excess (Neander, *Church History*, iv, 94). Many priests lived openly in wedlock, although the councils were always issuing new orders against them. "Pope Leo IX (1048-1054) and Nicolas II (1058-1061) interdicted all priests that had wives or concubines from the exercise of any spiritual function, on pain of excommunication. Alexander II (1061-1078) decreed excommunication against all who should attend a mass celebrated by a priest having a wife or concubine. This decision was renewed by Gregory VII (Hildebrand) in a council held at Rome in 1074, and a decretal was issued that every layman who should receive the communion from the hands of a married priest should be excommunicated, and that

every priest who married or lived in concubinage should be deposed. The decree met with the most violent opposition in all countries, but Gregory succeeded in carrying it out with the greatest rigor; and, though individual instances of married priests were still to be found in the twelfth and thirteenth centuries, the celibacy of the Roman Catholic clergy was established, and has since continued both in theory and practice" (Chambers, s. v.). Nevertheless, after the Reformation, the question came up; and at the Council of Trent (1545-1563) several bishops, and the emperor Charles V, favored a relaxation of the rule. But the majority of voices decided that God would not withhold the gift of chastity from those that rightly prayed for it, and the rule of celibacy was thus finally and forever imposed on the ministers of the Roman Catholic Church. Those who have only received the lower kinds of consecration may marry on resigning their office. For all grades above a sub-deacon, a papal dispensation is necessary. A priest that marries incurs excommunication, and is incapable of any spiritual function. If a married man wishes to become a priest, he receives consecration only on condition that he separate from his wife, and that she of her free will consent to the separation, and enter a religious order, or take the vow of chastity (*sess. xxiv, can. ix*). It is a question among divines of the Roman communion whether the law of the celibacy of clerks be of divine right, i. e. whether marriage is by holy Scripture forbidden to the clergy, or whether it is only of ecclesiastical authority, and binding on each clergyman in consequence of the vow to that effect voluntarily made at his ordination. Their best and most moderate writers maintain the second view.

IV. *In the Greek Church.*—The Greek Church has never adopted the law of celibacy absolutely for all its clergy, but adheres, in substance, to the ancient canon law. The Council in Trullo (A.D. 692) enacted that, though bishops may observe celibacy, yet presbyters and deacons might live with their wives (c. 14; Conc. Chalcedon, A.D. 451, c. 8, 6, 12, 18, 48; Conc. Trullan, A.D. 692, can. 7, 18). In the Russian Church, a parish priest *must* be married before ordination; if he loses his wife, he generally enters a monastery; or, if he marries again, he lays aside his priestly functions (Neale, *Voices from the East*, p. 58). Celibacy is to this day enjoined upon the bishops, who are therefore generally chosen from the monks, or from widowed presbyters; but as to the lower clergy, while the canons forbid the marriage of priests, deacons, and subdeacons, *after ordination*, they do not forbid the ordination of married men, nor require them to abstain from the conversation of their wives. In the Armenian Church marriage is imperative; an unmarried man cannot be ordained; but he cannot marry again. The *Vartabeds* (regulars), on the other hand, take the vow of celibacy, live in convents, and from their ranks the bishops are chosen (Dwight, in Coleman's *Ancient Christianity*, ch. xxvii, § 2); and the Romish Church allowed this in the case of the Greeks, Maronites, etc. who united with her (Benedict XIV, in the constit. *Etsi Pastoralis* of May 26, 1742 [*Bullar. Magn. ed. Luxemb.* t. xvi, fol. 100, and his *Eo quomodo tempore*, May 4, 1745, t. xvi, 6, 296]). The priests of the united Greek Church have received permission from the popes to continue in marriage, if entered into before consecration, but on condition of always living apart from their wives three days before they celebrate mass. There have been discussions in the Roman Church even in regard to the validity or nullity of marriages among the Copts and Greeks entered into after ordination (see *Bullar. Magn.* t. xviii, p. 67). "The Greek Church differs from the Latin, not by any higher standard of marriage, but only by a closer adherence to earlier usage, and by less consistent application of the ascetic principle. It is in theory as remote from the evangelical Protestant Church as the Latin is, and ap-

proaches it only in practice. It sets virginity far above marriage, and regards marriage only in its aspect of negative utility. In the single marriage of a priest it sees, in a measure, a necessary evil—at best only a conditional good, a wholesome concession to the flesh for the prevention of immorality—and requires of its highest office-bearers total abstinence from all matrimonial intercourse. It wavers, therefore, between a partial permission and a partial condemnation of priestly marriage" (Schaff, *Ch. History*, ii, § 50).

V. *Since the Reformation.*—The evils brought upon the Church by the celibacy of the clergy formed one cause of the movement towards reform which culminated in the 16th century. The leading Reformers declared against the celibacy of the clergy as unfounded in Scripture, and contrary to the natural ordinance of God, and the spell was finally broken by the marriage of Luther with Catharine Bora. His example was soon widely followed; and his writings, and those of his coadjutors, soon put an end to celibacy among all the reforming clergy (comp. Luther, *Ermahnung an kaiserl. Maj.* 1520, etc.; *De Votis Monasticis*). Calvin speaks as follows of the evil of clerical celibacy, as developed among the Romanists: "With what impunity fornication rages among them it is unnecessary to remark; emboldened by their polluted celibacy, they have become hardened to every crime. Yet this prohibition clearly shows how pestilent are all their traditions, since it has not only deprived the Church of upright and able pastors, but has formed a horrible gulf of enormities, and precipitated many souls into the abyss of despair. The interdiction of marriage to priests was certainly an act of impious tyranny, not only contrary to the Word of God, but at variance with every principle of justice. In the first place, it was on no account lawful for men to prohibit that which the Lord had left free. Secondly, that God had expressly provided in his Word that this liberty should not be infringed, is too clear to require much proof" (*Institutes*, iv, 12, 18). The Protestant Confessions of Faith generally touch on the subject more or less directly: e. g. the Augsburg Confession has a long article (xxiii) on the subject, from which we extract a passage: "Matrimony is moreover declared a lawful and honorable estate by the laws of your imperial majesty, and by the code of every empire in which justice and law prevailed. Of late, however, innocent subjects, and especially ministers, are cruelly tormented on account of their marriage. Nor is such conduct a violation of the divine laws alone; it is equally opposed to the canons of the Church. The apostle Paul denominates that a doctrine of devils which forbids marriage (1 Tim. iv, 1, 8); and Christ says (John viii, 44), 'The devil is a murderer from the beginning.' For that may well be regarded as a doctrine of devils which forbids marriage and enforces the prohibition by the shedding of blood." The Church of England: "Art. xxxii. *Of the Marriage of Priests.*—Bishops, priests, and deacons are not commanded by God's law either to vow the estate of single life, or to abstain from marriage; therefore it is lawful for them, as for all other Christian men, to marry at their own discretion, as they shall judge the same to serve better to godliness." See also the Helvetic Conf. i, ch. xxxvii; ii, ch. xxix. All the modern evangelical denominations are agreed in rejecting enforced celibacy as unscriptural and immoral. "When an institution has been tried during a dozen centuries in all parts of the world, and has uniformly been found productive of the same evil effects, there cannot well be a doubt what sentence ought to be pronounced on it: *Cut it down.* That the papacy should have refrained from pronouncing this sentence—that, on the contrary, it should have retained and upheld that institution with dogged pertinacity, notwithstanding the horrors which streamed in whelming torrents from it, is perhaps the most damning proof how the papacy recklessly sacrificed every

moral consideration, recklessly sacrificed the souls of its ministers, for the sake of maintaining its own power, by surrounding itself with an innumerable host of spiritual Mamelukes, bound to it by that which severed them from all social ties. And this is the Church for which our modern dreamers claim the exclusive title of holy—a Church headed by his holiness Pope Alexander the Sixth! This whole question of the celibacy of the clergy has been treated in a masterly manner by Jeremy Taylor, in that wonderful book, his *Doctor Dubitantium* (b. iii, c. iv, rule 20), where (in § 28) he gives the following summary of his objections: 'The law of the Church was an evil law, made by an authority violent and usurpt, insufficient as to that charge. It was not a law of God; it was against the rights and against the necessities of Nature; it was unnatural and unreasonable; it was not for edification of the Church; it was no advantage to spiritual life; it is a law that is therefore against public honesty, because it did openly and secretly introduce dishonesty; it had nothing of the requisites of a good law—no consideration of human frailty nor of human comforts; it was neither necessary, nor profitable, nor innocent—neither fitted to time, nor place, nor person; it was not accepted by them that could not bear it; it was complained of by them that could; it was never admitted in the East; it was fought against, and disclaimed, and railed at in the West; and at last it is laid aside in the churches, especially of the North, as the most intolerable and most unreasonable tyranny in the world; for it was not to be endured that, upon the pretence of an unreasonable perfection, so much impurity should be brought into the Church, and so many souls thrust down to hell.'—Hare, *Contest with Rome*, p. 268.

At different periods since the Council of Trent the celibacy of the clergy has been a topic of dispute within the Church of Rome, and many of the clergy have sought to free their body from this yoke of bondage. In Austria, Joseph II confirmed it by an ordinance under date of June 11, 1787, which would seem to indicate that some hopes of its nullification were entertained by the Austrian clergy at that time. When, in consequence of the Concordat of 1801, ecclesiastical communities were re-established in France, the rule of celibacy was maintained, and was skillfully defended by Portalis in the session of the *Corps Legislatif* of March 21, 1802. In 1817 the question was again mooted by the theological faculty of Landslut, who, complaining of the scarcity of candidates for holy orders, pointed to celibacy as one of its causes. In 1828 certain Roman priests of Baden and Silesia made another attempt, but without success. Similar attempts were also made after 1881 in the grand-duchy of Hesse, Wurtemberg, and Saxony, and petitions asking for the abolition of celibacy presented at the diets. The civil authorities felt the less inclined to such a step, as the fundamental question as to whether celibacy is an ecclesiastical law, or whether it could be abrogated by the civil authorities, is not yet decided. In France, again, the question was eagerly discussed from 1828 to 1832. In Spain, the Academy of Ecclesiastical Science took the subject into consideration in a meeting held in 1842; while the Portuguese Chambers had previously, in 1835, discussed it, though without result. The same took place in Brazil about 1827. During the commotions of 1848, the subject was again brought into prominence in Germany. The "German Catholics" (q. v.) had already abolished celibacy; and a general measure was called for in the Frankfort Parliament, in the Prussian Assembly, and in the press. In Austria, also, voices were raised against it; but here the state took the side of the pope, who, in a bull of 1847, had added fresh stringency to the rule of celibacy, and condemned its infringement. Since the Italian Liberation War of 1866, hundreds of the Italian clergy have united to reform the Church, and one of

the special points demanded is the abolition of celibacy.

On the other hand, the Romanizing party in the Church of England seem inclined to revive celibacy and the ancient admiration of virginity. See Shipley, *The Church and the World* (Vaux's Essay), London, 1866, 8vo.

Literature.—For the older writers on both sides, see Walch, *Bibliotheca Theologica*, i, 202; ii, 254. As later authorities, besides those cited in this article, see Gieseher, *Ch. History*, i, § 95, 124; ii, § 30, 65; Schaff, *Apostol. Church*, § 112; Schaff, *Ch. History*, l. c.; Browne, *On Thirty-nine Articles*, art. xxxii; Burnet, *On the Articles*, art. xxxii; Mackintosh, *Ethical Philosophy*, § 8; Taylor, *Ancient Christianity*, i, 198, 388 (N. York ed.); Neander, *Planting*, etc. i, 246 sq.; Neander, *Ch. History*, ii, 147; iv, 94 (Torrey's); Atterbury, *Sermon before the Sons of the Clergy* (Dec. 6, 1709); Thiersch, *Vorles. üb. Katholicismus und Protestantismus*, vorl. 88; Marneineke, *Instit. Symbol.* § 49, and references there; Herzog, *Real-Encyclopädie*, ii, 771; Wetzler u. Welte, *Kirchen-Lezikon*, ii, 656 (for Romanist view); Palmer, *On the Church*, pt. vi, ch. ix; Cramp, *Text-book of Popery*, ch. xv, § 2; Elliott, *Delineation of Romanism*, bk. iv (a very full treatment of the subject); Burnet, *History of Reformation*, ii, 142 sq.; Macanlay, *History of England*, vol. i, ch. ii; *Vollständige Sammlung d. Cölibatgesetze* (Franc. 1823); Theiner, *Die Einführung d. priesterlichen Ehelosigkeit u. ihre Folgen* (Altenb. 1828); Klitzsche, *Geesch. d. Cölibats* (Augs. 1830); Sulzer, *Die erblichsten Gründe für u. gegen d. Cölibatgesetze* (Const. 1820); Lea, *Sacerd. Celibacy* (Phila. 1867, 8vo); Stanley, *East. Church*, p. 264; Milman, *Lat. Christianity*, iii, 106 sq. See MARRIAGE; MONACHISM; VIRGINITY.

Cell (Lat. *cella*).

1. In classical archæology *cella* is applied to a cave or cellar to preserve wine, oil, or other provision. It also was applied to the enclosed space of a temple, to bath-rooms, to the sleeping apartments of slaves.

2. From this last use of the word it was transferred in the fourth century to the sleeping apartments of monks and nuns in cloisters (q. v.). These at first held three or four occupants, but later they usually received but one person. These cells are small, have one door and window, and are generally plainly furnished.

3. The word was also applied to a monastic dwelling, either for a single monk or for a community, subordinate to some great abbey. The former was mostly the abode of hermits, and erected in solitary places. See HERMITAGE. In the Quirinal Palace at Rome are the cells of the conclave (q. v.).

Cellar (צֶלֶן, *otzar*, something laid up in store). This word is in 1 Chron. xxvii, 28 rendered "cellar," but in another verse of the same chapter, "treasure," and "store-house," from which we may conclude that subterranean vaults are spoken of in each case. The same word is sometimes applied to the treasury of the Temple (1 Kings vii, 51) and of the king (xiv, 26).

Cellarius, or **Cellarer**, an officer in monasteries to whom belonged the care of procuring provisions for the establishment. See ABBEY. He was one of the four *obedienciarii*, or great officers: under his ordering was the *pastinarius*, or bake-house, and the *bracarius*, or brew-house. In the richer houses there were lands set apart for the maintenance of the office, called, in ancient writings, *ad cibum monachorum*. His whole office had respect to that origin. He was to see the corn got in, and laid up in the granaries: his wages consisted of a portion of the property, usually fixed at a thirteenth part of the whole, and a furrow gown. The office was equivalent to that of bursar.—Fosbrooke, *Antiquities*, i, 177; Farrar, *Ecol. Dict.* s. v.

Cellarius, Martinus (surnamed BORRHÆUS), was born at Stuttgart in 1499; studied at Tübingen, and afterwards at Wittenberg (under Melancthon),

where he devoted himself to Oriental languages. When the Anabaptists arose, he wrote and spoke against them, especially against Stock; but finally he joined them himself. About 1530 he gave up this enthusiasm and went to Baale, assuming the name of Borrhæus. He became professor of rhetoric there in 1536; of theology, 1544; and died Oct. 11, 1564.—Melchior, *Adam, Vit. Eruditorum*; Herzog, *Real-Encyclop.* s. v.

Cellarius, Jacobus. See KELLER.

Cellites (*Fratres Cellite*), a society which arose at Antwerp about 1300, and so called from *cella*, because they provided graves for the dead. They were also called the Alexian Brethren and Sisters, because Alexius was their patron. As the clergy of that period took little care of the sick and dying, and deserted such as were infected with pestilential disorders, some compassionate persons in Antwerp formed themselves into a society for the performance of these religious duties. They visited the sick, assisted the dying, and buried the dead with a solemn funeral dirge, and were on that account called Lollards (from *lollen*, or *lullen*, to sing). See LOLLARDS. Societies of Lollards were formed in most parts of Germany, and were supported partly by manual labor and partly by charitable donations. In 1472, Charles, duke of Burgundy, obtained a bull from Pope Sixtus IV ordering that the Cellites or Lollards should be ranked among the religious orders, and delivered from the jurisdiction of the bishops. Of the Alexian brethren, a few houses are left in the archdiocese of Cologne (Cologne, Aix-la-Chapelle, Düren), and of the sisters, some houses in Germany (Cologne, Dusseldorf), Belgium, and France.—Wetzler u. Welte, *Kirchen-Lezikon*, i, 165; Farrar, *Ecol. Dict.* s. v.; Mosheim, *Church History*, ii, 392. See ALEXIANS; LOLLARDS.

Celosyria. See COELE-SYRIA.

Celsus, OLAUS, an exegetical writer of Sweden, was born in 1670. He was a minister of the Lutheran Church, and professor of theology and of the Oriental languages at the University of Upsal. He was twice offered the dignity of archbishop of Upsal, but declined. He published many dissertations on points of theology, history, and antiquities. His most distinguished labors were on the natural history of the Bible. By direction of Charles XI, he travelled over the principal states of Europe to determine the different plants mentioned in the Bible, and the result of his labors, seventeen dissertations, published at intervals from 1702 to 1741, and afterwards collected into one work called *Hierobotanicon, seu de plantis Sanctæ Scripturæ dissertationes breves* (Upsal, 1745 and 1747), is still in repute as one of the most important books on the subject. He died in 1756. See *Memoirs of the Society of Sciences of Upsal*, vol. ii; *Biogr. Univers.* s. v.

Celsus, a philosopher of the second century, supposed to have been of the Epicurean sect, but inclined towards Platonism. He lived towards the close of the reign of Adrian, and during part of that of M. Aur. Antoninus; and (if Origen be correct) wrote an attack upon the faith and morals of Christians, which he called *Λόγος ἀληθής*, or "A True Discourse," the date of which Lardner supposes to have been about A.D. 176. Our only knowledge of it is derived from Origen's reply to it (*contra Celsum*, lib. viii), which, however, gives extracts sufficiently copious to allow a pretty sure judgment of its contents and purpose.

Of the life of Celsus little or nothing is known. Lucian dedicated his life of the magician Alexander to Celsus the Epicurean, and Origen identifies this person with the author of the book against which he wrote. The spirit of the book is far more Platonic than Epicurean. The arguments for and against the identity of the two persons thus named are stated in Neander, *Church History* (Torrey's transl. i, 160 sq.); and in Baur, *Geschichte der drei ersten Jahrhunderte*, p. 371.

"Both conclude that the persons were different. The evidence of their oneness is chiefly Origen's conjecture that they were the same person (*cont. Celsum*, iv, 86). The evidence against it is: (1.) That Lucian's friend attacked magical rites; the Celsus of Origen seems to have believed them. (2.) That Lucian's friend was probably an Epicurean; the other Celsus a Platonist or Eclectic. (3.) That the former is praised for his mildness; the latter shows want of moderation. Pressensé (*Trois Prem. Siècles*, vol. ii, 106) regards them as the same person" (Farrar, *Free Thought*, p. 51). It is quite in harmony with the whole spirit of the book, as well as of the Pagan philosophy of the time, to suppose that Celsus is, as Origen supposed, the Epicurean friend of Lucian; and that, in this treatise, he argues on any principles that may serve his purpose. But, whoever Celsus may have been, his writings are very important to Christian apologetics. They "are valuable on account of their admissions of the grand facts and doctrines of the Gospel as preached by the apostles and contained in their writings, by an enemy who lived little more than one hundred and thirty years after the ascension of our Lord. He has nearly eighty quotations from the books of the New Testament, which he not only appeals to as existing, but as universally received by the Christians of that age as credible and divine. He is most minute in his references to the circumstances of the life of Christ and his apostles, which shows that he was well acquainted with them, and that no one denied them. He everywhere ridicules the idea of our Lord's divinity, contrasting with it that of his poverty, sufferings, and death; which proves not only that the Christians of that early age avowed their belief in the doctrine, but that Celsus himself, though an unbeliever, found it in the documents to which he refers, as the source of his acquaintance with the Christian system" (Buck, s. v.). Moreover, he is the "original representative of a kind of intellect which has presented itself over and over again in the various attacks made on Christianity: wit and acuteness, without earnest purpose or depth of research; a worldly understanding, that glances merely on the surface, and delights in hunting up difficulties and contradictions. His objections against Christianity serve one important end: they present in the clearest manner the opposition between the Christian standing-ground and that of the ancient world; and, in general, the relation which revealed religion will ever be found to hold to the ground assumed by natural reason. Thus many of his objections and strictures became testimonies for the truth" (Neander, l. c.).

Lardner (*Testimonies*, chap. xviii; *Works*, vii, 210 sq.) gives full summaries of the book, classed under different heads, especially with reference to the authentication of the books of the N. T., for which these allusions and citations are of special value, as coming from a heathen opponent. A full analysis is also given by Neander, *Ch. History*, i, 160 sq. (Torrey's transl.), and by Tzschirner, *Fall des Heidenthums*, i, 820 sq. Pressensé, in his *Hist. de l'Eglise des Trois Prem. Siècles* (2d series, ii, 140 sq.), attempts ingeniously a reproduction of Celsus's treatise, as gathered from Origen, which Farrar follows (*Critical History of Free Thought*, lect. ii) in the outline which we here present. The references are to the Benedictine edition (Paris, 1733). Celsus introduces a Jewish rabbi as opposing Christianity from the Hebrew monotheistic point of view. "The rabbi first criticises the documents of Christianity, and then the facts narrated. He points out inconsistencies in the Gospel narratives of the genealogy of Christ; utters the most blasphemous calumnies concerning the incarnation; turns the narrative of the infancy into ridicule; imputes our Saviour's miracles to magic; attacks his divinity; and concentrates the bitterest raillery on the affecting narrative of our blessed Lord's most holy passion. Each fact of deepening sorrow in that divine tragedy, the betrayal, the men-

tal anguish, the sacred agony (ii, 24), is made the subject of remarks characterized no less by coarseness of taste and unfairness, than to the Christian mind by irreverence. Instead of his heart being touched by the majesty of our Saviour's sorrow, Celsus only finds an argument against the divine character of the adorable sufferer (ii, 16). The wonders accompanying Christ's death are treated as legends (iii, 88); the resurrection regarded as an invention or an optical delusion (iii, 59, 55, 57, 78).

"After Celsus has thus made the Jew the means of a ruthless attack on Christianity, he himself directs a similar one against the Jewish religion itself (iii, § 1 and elsewhere). He goes to the origin of their history; describes the Jews as having left Egypt in a sedition (iii, § 5); as being true types of the Christians in their ancient factiousness (iii, § 5); considers Moses to be only on a level with the early Greek legislators (i, 17, 18; i, 22); regards Jewish rites like circumcision to be borrowed from Egypt; charges anthropomorphism on Jewish theology (iv, 71; vi, 62), and declines allowing the allegorical interpretation in explanation of it (iv, 48); examines Jewish prophecy, parallels it with heathen oracles (vii, 8; viii, 46), and claims that the goodness, not the truth of a prophecy, ought to be considered (vii, 14); points to the ancient idolatry of the Jews as proof that they were not better than other nations (iv, 22, 23); and to the destruction of Jerusalem as proof that they were not special favorites of heaven. At last he arrives at their idea of creation (iv, 74; vi, 49, etc.), and here reveals the real ground of his antipathy. While he objects to details in the narrative, such as the mention of days before the existence of the sun (vi, 60), his real hatred is against the idea of the unity of God, and the freedom of Deity in the act of creation. It is the struggle of pantheism against theism.

"When Celsus has thus made use of the Jew to refute Christianity from the Jewish stand-point, and afterwards refuted the Jew from his own, he proceeds to make his own attack on Christianity; in doing which, he first examines the lives of Christians (iii), and afterwards the Christian doctrine (v, vi, vii), thus skillfully prejudicing the mind of his readers against the persons before attacking the doctrines. He alludes to the quarrelsomeness shown in the various sects of Christians (iii, 10), and repeats the calumnious suspicion of disloyalty (iii, 5, 14), want of patriotism (iii, § 55; viii, 78), and political uselessness (viii, 69), and hence defends the public persecution of them (viii, 69). Filled with the esoteric pride of ancient philosophy, he reproaches the Christians with their carelessness to proselytize the poor (iii, 44, 50) and to convert the vicious (iii, 59, 62, 74), thus unconsciously giving a noble testimony to one of the most divine features in our religion, and testifying to the preaching of the doctrine of a Saviour for sinners.

"Having thus defamed the Christians, he passes to the examination of the Christian doctrine, in its form, its method, and its substance. His æsthetic sense, ruined with the idolatry of form, and unable to appreciate the thought, regards the Gospels as defective and rude through simplicity (iii, 55; viii, 87). The method of Christian teaching also seems to him to be defective, as lacking philosophy and dialectic, and as denouncing the use of reason (vii, 9; i, 2; i, 9; iii, 39; vi, 10). Lastly, he turns to the substance of the dogmas themselves. He distinguishes two elements in them, the one of which, as bearing resemblance to philosophy or to heathen religion, he regards as incontestably true, but denies its originality, and endeavors to derive it from Persia or from Platonism (vi, 15; vi, 22, 58, 62; v, 63; vi, 1), resolving, for example, the worship of a human being into the ordinary phenomenon of apotheosis (iii, 22; vii, 28-30). The other class of doctrines which he attacks as false consists of those which relate to creation (iv, 37; vi, 49), the incarna-

tion (iv, 14; v, 2; vii, 86), the fall (iv, 62, 70), redemption (v, 14; vii, 28, 86; vi, 78), man's place in creation (iv, 74, 76, 28), moral conversions (iii, 65), and the resurrection of the dead (v, 14, 15). His point of view for criticising them is derived from the fundamental dualism of the Platonic system; the eternal severance of matter and mind, of God and the world; and the reference of good to the region of mind, evil to that of matter. Thus, not content with his former attack on the idea of creation in discussion with the Jew, he returns to the discussion from the philosophical side. His Platonism will not allow him to admit that the absolute God, the first Cause, can have any contact with matter. It leads him also to give importance to the idea of *δαίμονες*, or divine mediators, by which the chasm is filled between the ideal god and the world (vii, 68; viii. [2-14] 85, 86), not being able otherwise to imagine the action of the pure *idea* of God on a world of matter. Hence he blames Christians for attributing an evil nature to demons, and finds a reasonable interpretation of the heathen worship (viii, 2). The same dualist theory extinguishes the idea of the incarnation as a degradation of God; and also the doctrine of the fall, inasmuch as psychological deterioration is impossible if the soul be pure, and if evil be a necessary attribute of matter (iv, 99). With the fall redemption also disappears, because the perfect cannot admit of change; Christ's coming could only be to correct what God already knew, or rectify what ought to have been corrected before (iv, 3, 7, 18). Further, Celsus argues, if Divinity did descend, that it would not assume so lowly a form as Jesus. The same rigorous logic charges on Christianity the undue elevation of man, as well as the abasement of God. Celsus can neither admit man more than the brutes to be the final cause of the universe, nor allow the possibility of man's nearness to God (iv, 74). His pantheism, destroying the barrier which separates the material from the moral, obliterates the perception of the fact that a single free responsible being may be of more dignity than the universe."

The order in which the objections of Celsus are arranged in Origen's reply to him is different from that above given in some respects, and it is therefore here subjoined: "The first half of book i is prefatory (ch. 1-11); the second half, together with book ii, contains the attack by the Jew on Christianity given in lect. ii. The early part of book iii (1-9) contains Origen's refutation of the Jew. The subsequent parts and remaining books give Origen's refutation of Celsus's own attack on Christianity. First, Celsus attacks the character of Christians in the remainder of book iii. In book iv he returns to his attack on Judaism, and on the Scriptures of the Old Testament, especially on many of the narratives, either regarding them as false or as borrowed, and objecting to their anthropomorphic character; also objecting to the account of man's place in creation, and of divine interference. In book v he continues his attack on the doctrines of both religions, chiefly so far as he considers them to be untrue; and in book vi so far as he considers them to be borrowed, dragging to light the difference which existed between Judaism and Christianity. In book vii the subject of prophecy and some other doctrines, as well as the ethics of Christianity, are examined; and in book viii, when the attack on Christianity is mainly over, a defence of paganism is offered by Celsus. Such is the type of a philosophical objector against Christianity a little later than the middle of the second century. We meet here for the first time a remarkable effort of pagan thought, endeavoring to extinguish the new religion; the definite statements of a mind that investigated its claims and rejected it. Most of the objections of Celsus are sophistical, a few are admitted difficulties, but the philosophical class of them will be seen to be the corollary from his general principle before explained" (Farrar, l. c.).

Literature.—Besides the works already cited, see Cave, *History of Literature*, i, 96; Pond, in *Literary and Theological Review*, iv, 219, 584; Cudworth, *Intellectual System*, ii, 840 sq. (American edition); Shedd, *History of Doctrines*, bk. ii, ch. ii; Bindemann, in *Illgen's Zeitschrift*, etc. 1842, Heft 2; Schaff, *Church History*, i, § 60; Jachmann, *De Celsus*, etc. (Regiom. 1836, 4to); Hase, *Church History*, § 51; Fenger, *de Celsus Epicurio* (1828, 8vo); maintains that Celsus was not a Platonist; Gieseler, *Ch. History*, i, § 89 (note); Mosheim, *Commentaries*, cent. ii, § 19 (argues that Celsus was an Alexandrian Platonist). See also APOLOGETICS; APOLOGIES; ORIGEN.

Celtic Church or Christians. See CULDEES; GALATIANS.

Celtic Religion. Unless preceded by the Iberians, the Celts formed the first of those vast waves of Indo-European immigration that, first from the Himalayas and then from the Caspian Sea, spread themselves over Europe. This people, of unknown antiquity, not only at one time held all of Western and Central, but also an important part of Southern and Eastern Europe, and their armies threatened Rome and Asia Minor. Pressed back by the German tribes, and then conquered by the Romans and Saxons, the Celts have now ceased to be active agents in history as distinct national bodies, and have, indeed, a clear descent, as an unmixed race, only in Brittany, in France, Ireland, Wales, and part of Scotland and the smaller British Isles.

The Celts occupied a low stage of culture. They despised agriculture, were skillful traders and miners, and passionately fond of war, piracy, ornaments, and wine. They were cruel to their wives and children on the death of chiefs, practised polygamy, had few roads, but built many fortified cities and villages. They had no compact national union, but were divided into clans and districts, having but a slight federative union. Their society gradually became more and more aristocratic, so that feudalism seems, from its many points of resemblance, to be but the development of the Celtic social order.

The Celts had, however, a powerful bond of union in their religion and priesthood. In many features the priests resembled those of the ancient Egyptians. The numerous and powerful body of priests called *Druids* not only fulfilled all the offices of religion, but they were also the judges, the expounders of civil law, the physicians, the astrologers, the instructors of the youth, and had, in short, in their hands all the spiritual life of the entire people. They were not held to military service, paid no taxes, and bore none of the burdens of the state. With such privileges attached to their order, the children of rich and noble families often were placed in the priesthood, or sought it of their own wills. These novices were placed under a training which often lasted twenty years, being compelled to commit to memory an immense number of verses containing the secrets of the religion. As it was never permitted to commit these verses to writing, most of the particulars of the Celtic religion have been lost. The Druids were a secret or close corporation, wore a peculiar costume, had various grades of priesthood, and were presided over by a high-priest elected by the whole body. To the *ordinary priests* were intrusted the preservation of the sacred legends, and the teaching of them to the young priests. They usually had their places of residence and instruction in retired places, as in deep forests, dark valleys, or in islands. The *vates* (seers) dwelt in cities and villages, and there conducted the prayers, sacrifices, and other religious rites, and foretold the future and the counsel of the gods from the flight of birds and other phenomena of Nature. The *bards* preserved, developed, and sang to the people lyrics of the religion and of the glorious traditions of heroes among their ancestors. They often

appeared on the battle-field, firing the soldiers to deeds of heroic valor. By the touching tones of their lyres and songs they often stayed the flow of blood between hostile clans. In the early ages the bards stood in the highest esteem. At Cæsar's time they had sunk to the level of beggar-poets, seeking their living by singing flattering songs in the palaces of rich men and princes.

The religion of the Druids seems to have been originally a monotheism, which developed later into the deification of the powers of Nature, and the final incorporation of them as deities. *Taranis* (the Thunderer) was the god of heaven, the ruler of the universe, the highest judge, scattering the thunderbolts of his vengeance among mortals. *Belus* was the benevolent son of God, who gives life to the vegetable world and healing power to plants. *Hesus, Heus or Hu*, originally the founder of the religion of the Druids, was the god of war and of agricultural labor. *Testates* was the god of manufactures, the arts, and trade, therefore was identified by the Romans as Mercury. *Fairies*, "motherly virgins," were female deities who spun out the thread of life and of fate, and who were guardian angels of both lands, cities, and individual persons, and in the minds of the people were clothed with all attractions and virtues. Many places had also their local female deities.

The instruction in the schools of the priests consisted largely in tracing out the attributes of their deities. This was done with a surprising completeness. Instruction was also given concerning the stars and their courses, the size of the universe, the nature of matter and of existence, and especially of the human soul. The Druids taught the immortality of the soul; that after death it enters into another body, and that it leads in a more beautiful world than this a happy life, like the earthly life in its better phases, with the same occupations and enjoyments, so that the dead and living stand in a certain communication. At burial, letters were thus often thrown into the flames, that the dead might read them. This belief gave the Celts a high regard for their dead, and spurred them to deeds of great bravery. But it also brought with it deeds of horrible cruelty. In their earlier history it was not unusual, on the death of a man of station, for some of his nearest friends to throw themselves into the flames of his funeral pile. This led to tragic results. Thus, after the feudal system of the late Celtic period had developed itself, it was not rare, on the death of a chieftain, for some of his favorite slaves or followers to be killed and burned on his pile or buried in his grave. The warrior's favorite steed, his arms, dress, and ornaments, were also buried with him, that he might lack nothing in the other life.

Sacrifices formed the chief part of the Celtic religious rites. Human sacrifices were frequent, being regarded as the most effectual and acceptable way of appeasing Deity. It was believed that one human life could only be redeemed by the life of another human being. Thus, a person suffering from a dangerous sickness, a person in danger or in battle, offered to the deities instead of animals a human being, or vowed to do so, availing themselves of the Druids to fulfil the vow for them. In behalf of the state also the Druids offered human sacrifices. Great figures in the human form, made of wicker-work, were filled with human beings and then set on fire. The sacrifice of criminals was considered especially grateful to the deities. When they were lacking, innocent persons were offered up. For a long time also prevailed the custom of sacrificing all prisoners of war, accompanying the dreadful offering with loud songs and wild music, and out of the flowing blood and quivering members to divine the future.

The Celts also had *Druidesses*, or female priests, who, however, had less respect and privileges than the Druids. Companies of these priestesses inhabited certain woods, which no man dared to set foot upon. When

they wished to have intercourse with the people of the main land, they had to come in boats, and then return to their islands. These islands were avoided by sailors, as their fancy attributed to the Druidesses the power of sending tempests to destroy them. Once each year these priestesses had to remove the roofs from their houses, and to restore a new one before the setting of the sun. If one of them, crowned with ivy and other leaves, let a stick fall while at this work, the others fell upon her with wild cries and tore her to pieces.

All legal questions were decided by the Druids. All the Druids gathered every year at Chartres, and there decided all matters of dispute, both public and private. They appointed the punishment for murder and other crimes, and decided all disputes of inheritance and boundaries of estates. If any private person or chieftain refused to stand by their decision, he was refused permission to attend the religious rites—the most severe punishment they could inflict. He was an outcast, a godless criminal, avoided by all, and deprived of all rights at the hand of his fellow-man or of the law itself.

The medicine of the Druids consisted mostly in incantations, the plants used being deemed only the vehicles of communicating the healing influence. The most prized plant was the mistletoe. This was gathered from the oak in dark forests on winter's nights of the holy festival days, and was cut with golden sickles. It was called the "all-healing."

Talismans of various kinds were prepared with incantations by the priests and given to the people. The eggs of snakes, gathered by moonlight and carried in the bosom, were considered the most powerful protection against evil fortune. Many of these rites have left their traces on the religious customs of modern times, and are the foundation of many superstitions in Celtic lands of to-day.

Carnac, a small village in Brittany, has remains attributed to Druidical worship. They consist of four thousand massive rocks, placed upright in eleven rows. These rocks are often ten or fifteen feet high, and nearly as many feet apart. Over these are similar rocks, laid horizontally. In other places in Western France are similar remains of Druidical worship, also in Anglesea (Wales), on the Isle of Man, and other places in England. The tombs of the chiefs are mounds, or subterranean chambers. In the first are usually found bronze and earthen urns, bones, and ashes; in the latter, skeletons, earthen vessels, knives, battle-axes, chains, and other articles of furniture or ornament. — Amed. Thierry, *Histoire des Gaulois* (Paris, 1857, 2 vols.); Eckermann, *Celtische Mythologie* (Halle, 1847); Diefenbach, *Celtica* (Stuttg. 1839-41); Mone, *Celt. Forschungen* (Freiburg, 1857); Conzen, *Wanderungen der Cellen* (Leipz. 1861). See DRUIDS.

Cemeteries (κοιμητήρια, dormitories, or sleeping-places), a place of burial for the dead. The word cemetery, in this use, is of exclusively Christian origin; the burial-places of the Christians were so called to denote not only that the dead rested from their earthly labors and sorrows, but to point out the hope of a future resurrection (Bingham, *Orig. Eccles.* bk. xliii, ch. 1). See BURIAL; CATACOMBS; SEPULCHRE.

Cen'ohrëä (rather *Cenchrës*, *Κενχρηά*), the eastern port (ἐπίγειον) of Corinth (i. e. its harbor on the Saronic Gulf) and the emporium of its trade with the Asiatic shores of the Mediterranean, as Lechæum (now Lutáki) on the Corinthian Gulf connected it with Italy and the west (Philo, *Opp.* ii, 539; Theodoret, *in Rom.* xvi). A line of walls extended from the citadel of Corinth to Lechæum, and thus the Pass of Cenchræa was of peculiar military importance in reference to the approach along the isthmus from Northern Greece to the Morea. See CORINTH. The apostle Paul sailed from Cenchræa (Acts xviii, 18) on his return to Syria

from his second missionary journey; and when he wrote his epistle to the Romans, in the course of the third journey, an organized church seems to have been formed here (Rom. xvi, 1), probably a branch of that in Corinth (see Pauli, in the *Miscell. Diss.* i, 51 sq.). See FROESE. The first bishop of this church is said (*Apost. Const.* vii, 46) to have been named Lucius, and to have been appointed by Paul. The distance of Cenchreae from Corinth was seventy stadia, or about nine miles (Strabo, viii, 380; Liv. xxxii, 17; Pliny, iv, 4; Apulej. *Metam.* x, p. 255, Bip. ed.). Pausanias (ii, 8) describes the road as having tombs and a grove of cypresses by the wayside. The modern village of Kik-rires retains the ancient name, which is conjectured by Dr. Sibthorpe to be derived from the millet (κίγρο) which still grows there (Walpole's *Travels*, p. 41). The site is now occupied by a single farm-house. Close to the sea, and in parts even covered by its waters, are the foundations of a variety of buildings, the plans of which may yet be traced, as the walls still remain to the height of from two feet to three feet and a half. Some traces of the moles of the port are also still visible (Leake's *Morea*, iii, 238-285). The following coin exhibits the port exactly as it was described by Pausanias, with a temple at the extremity of each mole, and a statue of Neptune on a rock between them (see Conybeare and Howson, *St. Paul*, ii, 195).—Smith, s. v.



Colonial Coin of Corinth, with the Head of Antoninus Pius, and a diagram of the Haven of Cenchreae.

Cendebæus (Κενδεβαῖος), a general left by Antiochus VII (q. v.) in command (στρατηγός v. r. ἐπιστρατηγός and ὑποστρατηγός) of the sea-board (παρὰ-λαίαν) of Palestine (1 Macc. xv, 88 sq.) after the defeat of Tryphon, B.C. 138. He fortified Kedron (q. v.) and harassed the Jews for some time, but was afterwards defeated by Judas and John, the sons of Simon Maccabeus, with great loss (1 Macc. xvi, 1-10). The account of Josephus (*Ant.* xiii, 7, 8; *War*, i, 2, 2) is somewhat different.

Cendevia, according to Pliny (xxxvi, 26), the name of a lake from which the river Belus (q. v.) takes its rise, near Mt. Carmel (see Reland, *Palæst.* p. 267); probably the fountains now called *Kurdany*, near Shefr Amur (Thomson, *Land and Book*, i, 486).

Cène. See LECNE.

Cennick, JOHN, was originally one of Wesley's lay preachers, who appointed him as a sort of lay-chaplain at Kingswood School in 1789. In a year or two he began to preach against Wesley's Arminian doctrines, and to raise a party within the Wesleyan Society. After unavailing delays and overtures of peace, Wesley read publicly a paper declaring, "by the consent and approbation of the Band Society of Kingswood," that Cennick and his followers "were no longer members thereof." Cennick afterwards united with the Whitefield Methodists, but did not continue long with them. He became at last a Moravian. He was a good though weak man, and his subsequent earnest and laborious life shows that he deserves more lenity than has usually been accorded to him by Methodist writers. After many years of diligent labor as an evangelist, he died in 1755. His *Discourses* were published in 1770 (2 vols. sm. 8vo); and a new edition, with a "Life," was published in 1852 by Matthew Wilks, who says: "He possessed a sweet simplicity of spirit, with an ardent zeal in the cause of his divine

Master." The well-known hymn, "Jesus, my all, to heaven is gone," was written by Cennick.—Stevens, *History of Methodism*, i, 155; Darling, *Cyclopædia Bibliographica*, i, 615.

Censer, a vessel in which incense was presented in the Temple, being used by the Jews in the daily offering of incense, and yearly on the Day of Atonement, when the high-priest entered the Holy of Holies (2 Chron. xxvi, 19; Ezek. viii, 11; Ecclus. i, 9). On the latter occasion the priest filled the censer with live coals from the sacred fire on the altar of burnt-offering, and bore it into the sanctuary, where he threw upon the burning coals the "sweet incense beaten small" which he had brought in his hand (Lev. xvi, 12, 18). In this case the incense was burnt while the high-priest held the censer in his hand; but in the daily offering the censer in which the live coals were brought from the altar of burnt-offering was set down upon the altar of incense. This alone would suggest the probability of some difference of shape between the censers used on these occasions. The daily censers must have had a base or stand to admit of their being placed on the golden altar, while those employed on the Day of Atonement were probably furnished with a handle. In fact, there are different names for these vessels. Those in daily use were called מִקְטָרֵי (mikte'reth, occurs only in 2 Chron. xxvi, 19; Ezek. viii, 11), from מִקְטָר, incense; whereas that used on the Day of Atonement is distinguished by the title of מַחְטָאֵה (machta'ah, something to take fire with), or coal-pan (often "fire-pan" in the English version). We learn also that the daily censers were of brass (Num. xvi, 98) (according to the Mishna, *Tamid*, v, 5, in the second temple, also of silver), whereas the yearly one was of gold (Josephus, *Ant.* xiv, 4, 4). The latter is also said to have had a handle (Mishna, *Foma*, iv, 4), which, indeed, as being held by the priest while the incense was burning, it seems to have required. It is conjectured that this distinction is alluded to in Rev. v, 8; viii, 3, where the angel is represented with a golden "censer" (λίβανωτός, from λίβανος, incense), and the twenty-four elders each with a golden "vial" (φιάλη). In the Apocrypha, silver (1 Esdr. ii, 18) as well as golden (1 Macc. i, 22) "censers" (שִׁטְכֵי) are similarly referred to. Paul, in Heb. ix, 4, speaks of the golden "censer" as a thing which belonged to the Tabernacle, but the Greek word θυμιατήριον, which there occurs, may signify "altar of incense" (see Bleek, *Comment.* p. 488; Meyer, *Bibeldeut.* p. 7 sq.; Mynster, in the *Stud. u. Krit.* 1829; ii, 342 sq.). The latter of the above Hebrew words seems used generally for any instrument to seize or hold burning coals, or to receive ashes, etc. such as the appendages of the brazen altar and golden candlestick mentioned in Exod. xxv, 38; xxxvii, 23 (in which senses it seems rendered in the Sept. by ἱεραποσπίς, ἱεραπύρη, or perhaps ὑπόθεμα). It, however, generally bears the limited meaning which properly belongs to the former word, viz. a small portable vessel of metal, on which the incense was sprinkled by the priest to whose office this exclusively belonged (2 Chron. xxvi, 18; Luke i, 9). Thus "Korah and his company" were bidden to take "censers," with which, in emulation of Aaron and his sons, they had perhaps provided themselves (comp. Ezek. viii, 11); and Moses tells Aaron to take "the censer" (not a, as in the A. V.), i. e. that of the sanctuary or that of the high-priest, to stay the plague by atonement. The only distinct precepts regarding the use of the censer are found in Num. iv, 14, where among the vessels of the golden altar, i. e. of incense, "censers" are reckoned; and in Lev. xvi, 12, where we find that the high-priest was to carry it (here also it is "the," not "a censer," that he is ordered to "take") into the most holy place within the veil, where the "incense" was to be "put on the fire," i. e. on the coals in the censer, "before the Lord." This

must have been on the Day of Atonement, for then only was that place entered. Solomon prepared "censers of pure gold" as part of the same furniture (1 Kings vii, 50; 2 Chron. iv, 22). Possibly their general use may be explained by the imagery of Rev. viii, 8, 4, and may have been to take up coals from the brazen altar, and convey the incense while burning to the "golden altar," or "altar of incense," on which it was to be offered morning and evening (Exod. xxx, 7, 8). So Uzziah, when he was intending "to burn incense upon the altar of incense," took "a censer in his hand" (2 Chron. xxvi, 16, 19). See ALTAR.

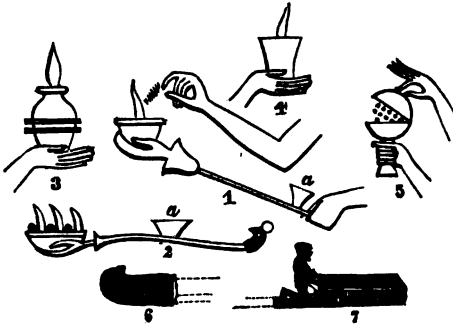

Ancient Egyptian Censers.

1. Throwing incense on the flame in censer. 2. Balls of incense burning in censer; a, a, Boxes for holding incense. 3, 4. Censers of different forms. 5. Box or cup for incense. 6, 7. Head of handle and pan of censers, in bronze.

These intimations help us to conclude that the Jewish censers were unlike those of the classical ancients, with which the sculptures of Greece and Rome have made us familiar, as well as those (with perforated lids, and swung by chains) which are used in the Church of Rome. It is observable that in all cases the Egyptian priests had their costly incense made up into small round pellets, which they projected successively from between their finger and thumb into the censer at such a distance that the operation must have required a peculiar knack, such as could have been acquired only by much practice. As the incense used by the Jews was made up into a kind of paste, it was probably employed in the same manner. See Sonneschmid, *De Thymiaterio sanctissimi* (Viteb. 1728); Deyling, *Observ. ii*, 565 sq.; J. G. Michaelis, in the *Mus. Brem.* ii, 6 sq., and in Ugolini *Thesaur.* xi; Wentz, in the *Nova Biblioth. Brem.* v, 887 sq.; Zeibich, *De thuribulo aureo* (Gerl. 1768); Köcher, *id.* (Jen. 1769); Braun, *Selecta aura*, p. 208 sq.; Rogal, *De thuribulis* (Regiom. 1724; also in Ugolini *Thes.* xi). See INCENSE.

CENSER, in Roman Catholic worship. See THURIBLE.

Censorship of Books, supervision of publications by means of a preliminary examination and authorization, under Church or state law. The design of censorship has always been to hinder the publication of writings supposed to be dangerous either to the state or to religion (i. e. under Roman Catholic authority, to the Church). The practice has been defended (1) by the example given in Acts xix, 9, where the "books of curious arts" were burnt; (2) by the responsibility of the Church for the souls of the flock, liable to be destroyed by bad books; (3) by the duty of teaching, which includes the withholding of bad doctrine as well as the furnishing of good.

Before the invention of printing, it was comparatively easy to control the circulation of manuscripts, and to destroy them when thought necessary. But the discovery of that art, and the spread of the Reformation in the sixteenth century, induced stronger measures and rules on the part of the Roman Church than had been known before, in order to prevent the diffusion of heretical literature. A censorship was offi-

cially established by the bull of Leo X, May 12, 1515, commanding the bishops and inquisitors to examine all works before publication, and not to tolerate any of heretical tendencies. The Council of Trent expressly prohibited the printing or reading of heretical books in the terms following: "No one shall be permitted to print, or cause to be printed, any books relating to religion without the name of the author; neither shall any one hereafter sell such books, or even retain them in his possession, unless they have been first examined and approved by the ordinary, under penalty of anathema, and the pecuniary fine adjudged by the last Council of Lateran. And if they be regulars they shall obtain, besides this examination and approval, the license of their superiors, who shall examine the books according to the forms of their statutes. Those who circulate or publish them in manuscript, without being examined and approved, shall be liable to the same penalties as the printers; and those who possess or read them, unless they declare the authors of them, shall themselves be considered as the author. The approbation of books of this description shall be given in writing, and shall be placed in due form on the title-page of the book, whether manuscript or printed; and the whole, that is, the examination and the approval, shall be gratuitous, that what is deserving may be approved, and what is unworthy may be rejected" (*Session IV*). A committee was appointed to carry out this law by proper enactments, which resulted in the *Index Librorum prohibitorum*, or *Index Expurgatorius*, and in the establishment of the *Congregation of the Index* as a perpetual censorship. The popes sought also to obtain the assistance of the civil authorities in the carrying out of the censorship, and we find that several German states published edicts in 1524, 1530, 1541, 1548, 1567, 1577, etc. recommending a stricter control of the press. Still stricter regulations were afterwards enacted in Spain, Italy, and France. In 1522 the legate Chieregati maintained in the free town of Nuremberg that it was right to take and burn all works printed without authority, and that the printers and publishers of such works were punishable. In most Roman Catholic countries there arose a twofold censorship, that of the bishops and that of the state. In many cases the two were united into one. The process was simple: the censor or licenser read over the MS. to be printed, and, after striking out any objectionable passages, certified that the work might be printed. Hence, in old books, we see the word *imprimatur* (let it be printed), followed by the signatures of the authorities. In England a censorship was established by act of Parliament in 1662, 18 Char. II, c. 38: "An act for preventing the frequent abuses in printing seditious, treasonable, and unlicensed books and pamphlets, and for regulating of printing and printing-presses." This was a temporary act, renewed from time to time; and its renewal was refused in 1693, owing to a quarrel between the House of Commons and the licenser. Since that time there has been, generally speaking, no restriction on what any man may publish; and he is merely responsible to the law if in his publication he should commit any public or private wrong. On the Continent of Europe the censorship became generally less stringent after the conclusion of the peace of Westphalia, although Leopold I and Francis II continued to enforce it. It was abolished in Denmark in 1770; Sweden, 1809; France, 1827; Belgium, 1830; Spain, 1833; Germany and Austria, 1848. — Plerer, *Universal Lexikon*, s. v.; Chambers, *Encyclopedia*; Milton, *Liberty of Unlicensed Printing*; Mendham, *Literary Policy of the Ch. of Rome*; M'Crie, *Reformation in Italy*, ch. v. See INDEX (EXPURGATORIUS).

Censures, Church (*Censura ecclesiastica*), the penalties by which crimes are visited by Church authority (potestas *disciplinaria*), the scriptural authority for which is found in such passages as Tit. i, 13; iii,

10; 1 Tim. v, 20; Matt. xvii, 17, 18; John xx, 28; 1 Cor. v, 8; 2 Thess. iii, 6, 7; Gal. v, 12. These censures are, in the state churches, admonition, degradation (q. v.), excommunication (q. v.), suspension, interdict (q. v.), and irregularity (q. v.), which hinders a man from being admitted into higher orders.

"The canonists define an ecclesiastical censure to be a spiritual punishment, inflicted by some ecclesiastical judge, whereby he deprives a person baptized of the use of some spiritual things, which conduce not only to his present welfare in the Church, but likewise to his future and eternal salvation. It differs from civil punishments, which consist only in things temporal—as confiscation of goods, pecuniary mulcts or fines, and the like; but the Church, by its censures, does not deprive a man of all spirituals, but only of some in particular. This definition speaks of such things as conduce to eternal salvation, in order to manifest the end of this censure; for the Church, by censures, does not intend the destroying of men's souls, but only the *scoring* them, by enjoining repentance for past errors, a return from contumacy, and an abstaining from future sins" (Hook, *Church Dictionary*, s. v.). All churches claim the right of censure. Art. 80 of the Westminster Confession is as follows: "Of Church Censures.—The Lord Jesus, as king and head of his Church, hath therein appointed a government in the hand of Church officers, distinct from the civil magistrate. To these officers the keys of the kingdom of heaven are committed, by virtue whereof they have power respectively to retain and remit sins, to shut that kingdom against the impenitent both by the word and censures, and to open it unto penitent sinners by the ministry of the Gospel, and by absolution from censures, as occasion shall require. Church censures are necessary for the reclaiming and gaining of offending brethren; for deterring of others from like offenses; for purging out of that leaven which might infect the whole lump; for vindicating the honor of Christ, and the holy profession of the Gospel; and for preventing the wrath of God, which might justly fall upon the Church, if they should suffer his covenant, and the seals thereof, to be profaned by notorious and obstinate offenders. For the better attaining of these ends, the officers of the Church are to proceed by admonition, suspension from the sacrament of the Lord's Supper for a season, and by excommunication from the Church, according to the nature of the crime and demerit of the person." In most Protestant churches, censures can only be inflicted after trial by the peers of the accused person. On the persons liable to Church censures, and the crimes for which they were inflicted in the ancient Church, see Bingham, *Orig. Eccles.* bk. xvi, ch. iii; and on the rightfulness of Church censures, Burnet, *On the Articles*, art. 33; Palmer, *On the Church*, ii, 277; Watson, *Theol. Institutes*, ii, 600 (N. Y. ed.). See also DISCIPLINE; EXCOMMUNICATION.

Census, a term that does not occur in the A. V. (although it is found in the original text of the N. T. in the Greek form *κῆνος*, "tribute," Matt. xvii, 25, etc.), while the act denoted by it is several times re-

ferred to both in the Heb. and Gr. Scriptures (נָסַף, or נִסְפָּה, "numbering" combined with lustration, from נָסַף, to survey in order to purge, Gesenius, *Theo.* p. 1120; Sept. ἀριθμός; N. T. ἀπογραφὴ; Vulg. *enumeratio, descriptio*). See POPULATION.

1. *Jewish*.—Moses laid down the law (Exod. xxx, 12, 18) that whenever the people were numbered an offering of half a shekel should be made by every man above twenty years of age, by way of atonement or propitiation. A previous law had also ordered that the first-born of man and of beast should be set apart, as well as the first-fruits of agricultural produce; the first to be redeemed, and the rest, with one exception, offered to God (Exod. xiii, 12, 13; xxii, 29). The idea of lustration in connection with numbering predominated also in the Roman census (Smith, *Dict. of Class. Antiq.* s. v. *Lustrum*), and among Mohammedan nations at the present day a prejudice exists against numbering their possessions, especially the fruits of the field (Hay, *Western Barbary*, p. 15; Crichton, *Arabia*, ii, 180; see also Lane, *Mod. Egypt*, ii, 72, 73). The instances of numbering recorded in the O. T. are as follows:

1. Under the express direction of God (Exod. xxxviii, 26), in the third or fourth month after the Exodus, during the encampment at Sinai, chiefly for the purpose of raising money for the Tabernacle. The numbers then taken amounted to 603,550 men, which may be presumed to express with greater precision the round numbers of 600,000 who are said to have left Egypt at first (Exod. xii, 87).

2. Again, in the second month of the second year after the Exodus (Num. i, 2, 8). This census was taken for a double purpose: (a.) To ascertain the number of fighting men from the age of 20 to 50 (Joseph. *Ant.* iii, 12, 4). The total number on this occasion, exclusive of the Levites, amounted at this time also to 603,550 (Num. ii, 82); Josephus says 603,650: each tribe was numbered, and placed under a special leader, the head of the tribe. (b.) To ascertain the amount of the redemption-offering due on account of all the first-born, both of persons and cattle. Accordingly, the numbers were taken of all the first-born male persons of the whole nation above one month old, including all of the tribe of Levi of the same age. The Levites, whose numbers amounted to 22,000, were taken in lieu of the first-born males of the rest of Israel, whose numbers were 22,278, and for the surplus of 278 a money payment of 1865 shekels, or 5 shekels each, was made to Aaron and his sons (Num. iii, 89, 51).

If the numbers in our present copies, from which those given by Josephus do not materially differ, be correct, it seems likely that these two numberings were in fact one, but applied to different purposes. We can hardly otherwise account for the identity of numbers even within the few months of interval (Calmet on Num. i; Kitto, *Pictorial Bible*, ib. J). It may be remarked that the system of appointing head men in each tribe as leaders, as well as the care taken in preserving the pedigrees of the families, corresponds with the practice of the Arab tribes at the present day (Crichton, *Arabia*, ii, 185, 186; Niebuhr, *Descr. de l'Arabie*, p. 14; Buckingham, *Arab Tribes*, p. 88; Jahn, *Hist.* bk. ii, 8, 11; Malcolm, *Sketches of Persia*, xiv, 157, 159).

8. Another numbering took place 88 years afterwards, previous to the entrance into Canaan, when the total number, excepting the Levites, amounted to 601,780 males, showing a decrease of 1870. All the tribes presented an increase, except Reuben, which had decreased 2770; Simeon, 87,100; Gad, 5150; Ephraim and Naphtali, 8000 each. The tribe of Levi had increased 727 (Num. xxvi). The great diminution which took place in the tribe of Simeon may probably be assigned to the plague consequent on the misconduct of



Ancient Egyptian Registration.

Zimri (Calmet on Num. xxv, 9). On the other hand, the chief instances of increase are found in Manasseh of 20,500; Benjamin, 10,200; Asher, 11,900; and Issachar, 9900. None were numbered at this census who had been above 20 years of age at the previous one in the second year, excepting Caleb and Joshua (Num. xxvi, 63-65).

4. The next formal numbering of the whole people was in the reign of David, who in a moment of presumption, contrary to the advice of Joab, gave orders to number the people without requiring the statutory offering of a half-shekel. The men of Israel above 20 years of age were 800,000, and of Judah 500,000; total, 1,800,000. The book of Chron. gives the numbers of Israel 1,100,000, and of Judah 470,000; total, 1,570,000; but informs us that Levi and Benjamin were not numbered (1 Chron. xxi, 6; xxvii, 24). Josephus gives the numbers of Israel and Judah respectively 900,000 and 400,000 (2 Sam. xxiv, 1, 9; and Calmet, in loc.; 1 Chron. xxi, 1, 5; xxvii, 24; Joseph. *Ant.* vii, 13, 1).

5. The census of David was completed by Solomon, by causing the foreigners and remnants of the conquered nations resident within Palestine to be numbered. Their number amounted to 153,600, and they were employed in forced labor on his great architectural works (Josh. ix, 27; 1 Kings v, 15; ix, 20, 21; 1 Chron. xxii, 2; 2 Chron. ii, 17, 18).

Between this time and the Captivity, mention is made of the numbers of armies under successive kings of Israel and Judah, from which may be gathered with more or less probability, and with due consideration of the circumstances of the times as influencing the numbers of the levies, estimates of the population at the various times mentioned.

6. Rehoboam collected from Judah and Benjamin 180,000 men to fight against Jeroboam (1 Kings, xii, 21).

7. Abijah, with 400,000 men, made war on Jeroboam with 800,000, of whom 500,000 were slain (2 Chron. xiii, 8, 17).

8. Asa had an army of 800,000 men from Judah, and 280,000 (Josephus says 250,000) from Benjamin, with which he defeated Zerah the Ethiopian, with an army of 1,000,000 (2 Chron. xiv, 8, 9; Josephus, *Ant.* viii, 12, 1).

9. Jehoshaphat, besides men in garrisons, had under arms 1,160,000 men, including perhaps subject foreigners (2 Chron. xvii, 14-19; Jahn, *Hist.* v, 87).

10. Amaziah had from Judah and Benjamin 800,000, besides 100,000 mercenaries from Israel (2 Chron. xxv, 5, 6).

11. Uzziah could bring into the field 807,500 men (807,000, Josephus), well armed, under 2600 officers (2 Chron. xxvi, 11-15; Joseph. *Ant.* ix, 10, 8).

Besides these more general statements, we have other and partial notices of numbers indicating population. Thus, a. Gideon from 4 tribes collected 82,000 men (Judg. vi, 85; vii, 8). b. Jephthah put to death 42,000 Ephraimites (Judg. xii, 6). The numbers of Ephraim 800 years before were 82,500 (Num. xxvi, 87). c. Of Benjamin 25,000 were slain at the battle of Gibeath, by which slaughter, and that of the inhabitants of its cities, the tribe was reduced to 600 men. Its numbers in the wilderness were 45,600 (Num. xxvi, 41; Judg. xx, 85, 46). d. The number of those who joined David after Saul's death, besides the tribe of Issachar, was 840,922 (1 Chron. xii, 23-38). e. At the time when Jehoshaphat could muster 1,160,000 men, Ahab in Israel could only bring 7000 against the Syrians (1 Kings xx, 15). f. The numbers carried captive to Babylon, B.C. 598-82, from Judah are said (2 Kings xxiv, 14, 16) to have been from 8000 to 10,000, by Jeremiah 4600 (Jer. lii, 80).

12. The number of those who returned with Zerubabel in the first caravan is reckoned at 42,860 (Ezra ii, 64), but of these perhaps 12,542 belonged to other tribes than Judah and Benjamin. It is thus that the

difference between the total (v, 64) and the several details is to be accounted for. The purpose of this census, which does not materially differ from the statement in Nehemiah (Neh. vii), was to settle with reference to the year of Jubilee the inheritances in the Holy Land, which had been disturbed by the Captivity, and also to ascertain the family genealogies, and ensure, as far as possible, the purity of the Jewish race (Ezra ii, 59; x, 2, 8, 18, 44; Lev. xxv, 10).

In the second caravan the number was 1496. Women and children are in neither case included (Ezra viii, 1-14).

It was probably for kindred objects that the pedigrees and enumerations which occupy the first 9 chapters of the 1st book of Chronicles were either composed before the Captivity, or compiled afterwards from existing records by Ezra and others (1 Chron. iv, 28, 32, 39; v, 9; vi, 57, 81; vii, 28; ix, 2). In the course of these we meet with notices of the numbers of the tribes, but at what periods is uncertain. Thus Reuben, Gad, and half the tribe of Manasseh are set down at 44,760 (v, 18), Issachar at 87,000 (vii, 5), Benjamin 59,484 (vii, 7, 9, 11), Asher 26,000 (vii, 40). Besides, there are to be reckoned priests, Levites, and residents at Jerusalem from the tribes of Benjamin, Ephraim, and Manasseh (ix, 8).

Throughout all these accounts two points are clear. 1. That great pains were taken to ascertain and register the numbers of the Jewish people at various times for the reasons mentioned above. 2. That the numbers given in some cases can with difficulty be reconciled with other numbers of no very distant date, as well as with the presumed capacity of the country for supporting population. Thus the entire male population above 20 years of age, excepting Levi and Benjamin, at David's census, is given as 1,800,000, or 1,570,000 (2 Sam. xxiv, 1; 1 Chron. xxi), strangers 158,600; total, 1,458,600, or 1,728,000. These numbers (the excepted tribes being borne in mind) represent a population of not less than 4 times this amount, or at least 5,814,000, of whom not less than 2,000,000 belonged to Judah alone (2 Sam. xxiv, 9). About 100 years after, Jehoshaphat was able to gather from Judah and Benjamin (including subject foreigners) an army of 1,160,000, besides garrisons, representing a population of 4,640,000. Fifty years later, Amaziah could only raise 800,000 from the same 2 tribes, and 27 years after this, Uzziah had 807,500 men and 2600 officers. Whether the number of the foreigners subject to Jehoshaphat constitutes the difference at these periods must remain uncertain.

To compare these estimates with the probable capacity of the country, the whole area of Palestine, including the trans-Jordanic tribes, so far as it is possible to ascertain their limits, may be set down as not exceeding 11,000 square miles; Judah and Benjamin at 8185, and Galilee at 980 square miles. The population, making allowance for the excepted tribes, would thus be not less than 590 to the square mile. This considerably exceeds the ratio in most European countries, and even of many of the counties of England.

But while, on the one hand, great doubt rests on the genuineness of numerical expressions in O. T., it must be considered, on the other, that the readings on which our version is founded give, with trifling variations, the same results as those presented by the Sept. and by Josephus (Jahn, v, 86; Glasse, *Phil. Sac. de causis corruptionis*, i, § 28; vol. ii, p. 189). See NUMBER.

In the list of cities occupied by the tribe of Judah, including Simeon, are found 128 "with their villages," and by Benjamin 26. Of one city, Ai, situate in Benjamin, which like many, if not all the others, was walled, we know that the population, probably exclusive of children, was 12,000, while of Gibeon it is said that it was larger than Ai (Josh. viii, 25, 29; x, 2; xv, 21-62; xviii, 21, 28; xix, 1-9). If these "cities" may be taken as samples of the rest, it is clear that South-

ern Palestine, at least, was very populous before the entrance of the people of Israel.

But Josephus, in his accounts (1.) of the population of Galilee in his own time, and (2.) of the numbers congregated at Jerusalem at the time of the Passover, shows a large population inhabiting Palestine. He says there were many cities in Galilee, besides villages, of which the least, whether cities or villages is not quite certain, had not less than 15,000 inhabitants (*War*, iii, 8, 2 and 4; comp. *Tacit. Hist.* v, 8). After the defeat of Cestius, A.D. 66, before the formal outbreak of the war, a census taken at Jerusalem by the priests, of the numbers assembled there for the Passover, founded on the number of lambs sacrificed, compared with the probable number of persons partaking, gave 2,700,000 persons, besides foreigners and those who were excluded by ceremonial defilement (see *Tacit. Hist.* v, 12). In the siege itself 1,100,000 perished, and during the war 97,000 were made captives. Besides these many deserted to the Romans, and were dismissed by them (*War*, vi, 8, 9, 8). These numbers, on any supposition of foreign influx (*ὀμόφυλον ἀλλ' οὐκ ἐπιχώριον*) imply a large native population; and 68 years later, in the insurrection of Barchochebas, Dion Cassius says that 50 fortified towns and 980 villages were destroyed, and 580,000 persons were slain in war, besides a countless multitude who perished by famine, fire, and disease, so that Palestine became almost depopulated (*Dion Cass.* lxi, 14).

Lastly, there are abundant traces throughout the whole of Palestine of a much higher rate of fertility in former as compared with present times—a fertility remarked by profane writers, and of which the present neglected state of cultivation affords no test. This, combined with the positive divine promises of populousness, increases the probability of at least approximate correctness in the foregoing estimates of population (*Tacit. Hist.* v, 6; *Amm. Marc.* xiv, 8; *Josephus, War.* iii, 8; *Jerome* on *Ezek.* xx, and Rabbinical authorities in *Reland*, c. xxvi; *Shaw, Travels*, ii, pt. ii, c. i, p. 386, 340, and 275; *Hasselquist, Travels*, p. 120, 127, 180; *Stanley, Palest.* p. 120, 374; *Kitto, Phys. Geogr.* p. 38; *Raumer, Palästina*, p. 8, 80, 88, App. ix. *Comp. Gen.* xiii, 16; xxii, 17; *Num.* xxiii, 10; 1 *Kings* iv, 20; *Acts* xii, 20). See *Meiner, De Hebræorum censibus* (*Langens.* 1764-66); *Zeibich, De censibus Hebræorum* (*Gera.* 1764-6). See PALESTINE.

II. *Roman*.—This, under the Republic, consisted, so far as the present purpose is concerned, of an enrolment of persons and property by tribes and households. Every paterfamilias was required to appear before the censor, and give his own name and his father's; if married, that of his wife, and the number and ages of his children; after this, an account and valuation of his property, on which a tax was then imposed. By the lists thus obtained every man's position in the state was regulated. After these duties had been performed, a *lustrum*, or solemn purification of the people, followed, but not always immediately (*Smith, Dict. of Class. Antiq.* s. v. *Census*. See *Dionys.* iv, 15, 22; *Cicero, de Legg.* iii, 8; *Clinton, Fast. Hell.* iii, p. 457, c. 10). The census was taken, more or less regularly, in the provinces, under the republic, by provincial censors, and the tribute regulated at their discretion (*Cicero, Ferr.* ii, lib. ii, 58, 56), but no complete census was made before the time of Augustus, who carried out three general inspections of this kind, viz. (1.) B.C. 28; (2.) B.C. 8; (3.) A.D. 14; and a partial one, A.D. 4. The reason of the partial extent of this last was that he feared disturbances out of Italy, and also that he might not appear as an exactor. Of the returns made, Augustus himself kept an accurate account (*brevarium*), like a private man of his property (*Dion Cass.* liv, 85; iv, 18; *Suetonius, Aug.* 27, 101; *Tacitus, Ann.* i, 11; *Tab. Ancyr.* ap. *Ernesti, Tacit.* ii, 188). A special assessment of Gaul, under commissioners sent for the purpose, is mentioned in the time of Tiberius

(*Tacit. Ann.* i, 81; ii, 6; *Livy, Ep.* 184, 186). In the New Test. two enrolments of this kind, executed under the Roman government, are mentioned by Luke (*ἀπογραφή*, "taxing").—*Smith*, s. v. See TAX.

1. In *Acts* v, 37, a census is referred to as at the time a well-known event, during which a certain Judas of Galilee raised an insurrection. This import of the term there employed is sustained by *Josephus* (*Ant.* xviii, 1, 1; 2, 1), who says that it was an assessment of property (*ἀπορίμους τῶν οὐσιῶν ἢ χρημάτων*), which the proconsul Quirinus (*Κυρήνιος*, *Cyrenius*) carried out on behalf of the emperor Augustus after the banishment of king Archelaus (A.D. 6), in which Samaria, Judæa, and Idumæa were joined with the province of Syria under direct Roman rule. The Latin name for such a valuation, which was occasionally instituted in all the provinces of the Roman empire, is the well-known one *census*; by it new lists (*ἀπογραφαι*, *tabula censoria*, *Polyb.* ii, 23, 9) were made out, of persons, property, and business, and upon this basis the tax was imposed. See ASSESSMENT. The matter was naturally odious generally to the subjects, especially to the Jews [see PUBLICAN], not only on account of their religious prejudices [see ZELOTES], but also the violent and extortionate manner in which Oriental taxation is always enforced. See TRIBUTE. The word *ἀπογραφή* is used almost invariably by Greek writers of the Roman period for *census*, although an enrolment for taxation is more properly called *ἀπορίμους*, a sense, however, not inapplicable (even in the Attic dialect) to *ἀπογραφή* and *ἀπογράφεσθαι* (see *Wachsmuth, Hellen. Alterth.* ii, 71, 288, 280). See JUDAS (THE GALILEAN).

2. In *Luke* ii, 1, there is mentioned an enrolment or *ἀπογραφή* as having taken place in the year of Christ's birth, by order of Augustus, and, as the words seem to express, under the superintendence of Quirinus or Cyrenius, president of Syria, extending over the entire land (*πᾶσα οἰκουμένη*). This seems, according to the date indicated, to have been different from the census above mentioned, as is indeed implied in the language "this the first tax-list was made while Quirinus was governor" (*αὕτη ἡ ἀπογραφὴ πρῶτη ἐγένετο ἡγεμονεύοντος Κυρήνιου*). But this passage contains great historical difficulty as well as importance (see *Huschke, Ueber den zur Zeit der Geburt Christi gehaltenen Census*, *Breslau*, 1840; *Wieseler, Synopse*, p. 82 sq.; *Kirma, in the Jenæer Lit.-Zeitung*, 1842, No. 100 sq.). The principal discrepancies alleged with regard to the tax itself have been adduced by *Strauss* (*Leben Jesu*, i, § 28) and *De Wette* (*Comment. zu Luc.* in loc.): 1. Palestine was not yet directly Roman, or immediately liable to such a census (comp. *Joseph. Ant.* xvii, 13, 5; xviii, 1, 1; *Appian, Civ.* v, 75); an *ἀπογραφή* at this time, therefore, as being neither available for the purposes of the emperor, nor adapted to the relations of the Jewish vassal-kings towards him, would have been the more likely to have created a popular or governmental disturbance than the later one above referred to. 2. At all events, no historical mention of so unusual a proceeding occurs either in *Josephus* or the Roman writers of the period. 3. Yet some notice of this event is the more to be expected, inasmuch as the *ἀπογραφή* in question covered the whole empire, the restriction of its terms ("the whole earth" or land) to Palestine being altogether arbitrary. 4. In a Roman "census" the subjects were assessed at their actual residences; a journey to the family seat could only be requisite on the supposition of a Jewish genealogical registry. 5. As wives were in no case required to repair to the assessors, Mary must have undertaken unnecessarily a journey to Bethlehem, and a stay there was harassing in her condition. Some of these objections were canvassed by *Paulus* (in his *Comment.* in loc.); *Tholuck* (*Glaubwürdigk. d. evang. Gesch.* p. 188 sq.), *Huschke* (*ut sup.*), and others have pretty effectually answered them all. They may mostly be obvi-

ated by simply and naturally assuming that this was a registration instituted indeed by the Roman emperor, but executed in accordance with the local usages (see Strong's *Harmony of the Gospels*, notes to § viii). See CYRENIUS.

In the first place, an *δρογραφη* was properly only an enrolment of the inhabitants, which may have been set on foot for statistical purposes, in order to obtain a complete account of the population, perhaps as a basis for a levy of troops from this as a subject territory. The emperor Augustus caused such a roll or abstract to be made out ("breviarium totius imperii," Suetonius, *Octav.* 101), which included an account of the provincial allies ("quantum sociorum in armis," Tacitus, *Annal.* i, 11), and from this Palestine could not well have been excepted. The ordering of such a register was not inconsistent with the political relations of Herod (as thought by Hoven, *Otia liter.* ii, 27 sq.), since he was himself but a dependant monarch; and as the word in question has usually the sense of a list with a view to assessment, the probability of such a taxation in this instance can certainly not be denied. Similar examples are by no means wanting in modern times among dependant countries. Moreover, Herod was so subject to the rule of Augustus that he did not even assume to judge two of his own sons, but referred the trial to the emperor (Josephus, *Ant.* xvi, 4, 1; comp. xvii, 6, 8); and he, in fact, submitted to an oath of allegiance to the emperor, which the Jews were required to take (*Ant.* xvii, 2, 4). The latter circumstance may indeed be naturally attributed to the vassalage of a nation, but the former was a voluntary act on the part of Herod, who nevertheless, without such ceremony, executed other members of his family (comp. however, Josephus, *Ant.* xvi, 11, 1). At all events, it abundantly appears from Josephus that Augustus, in moments of passion, was capable of resolving to proceed to extremities with Herod (*Ant.* xvi, 9, 8); and that, after Herod's death, he hesitated about transferring the land to the sons of the latter (*Ant.* xvi, 11).—Winer, ii, 398.

There are monographs in Latin on the census of Quirinus by Ammon (Erlang. 1810), Birch (Hafn. 1790), Bornitius (Viteb. 1650), Breithaupt (Helmst. 1787), Deyling (*Observ.* ii, 826 sq.), Hasee (Regiom. 1796), Heumann (Gotting. 1782), Janus (Viteb. 1715; also in Ikenii *Theol.* ii, 424 sq.), Obrecht (Argenter. 1675), Perizonius (*Diss. de Prætorio*, s. f.), Pihlmann (Aboe, 1785), Richard (Viteb. 1704; also in Ikenii *Theol.* ii, 494 sq.), Volborth (Gotting. 1785), Wedel (Jen. 1708), Wernsdorf (Viteb. 1698, 1720); in Greek, by Friberg (Aboe, 1730); in German, by Kist (Utr. 1791), Pitschmann (*Dub. rec. Hist.* i, 1-25), Stockmann (Grön. 1756). See NATIVITY.

Central America comprised, in 1868, five sovereign states, viz. Costa Rica, Nicaragua, Guatemala, Honduras, and San Salvador. The eastern coast of Central America was discovered by Columbus in 1502, the western by H. Ponce in 1516. The Spaniards soon subjected to their rule the greater part of the country; but on the Mosquito coast the Indians maintained their independence, and the district of Peten was not taken possession of until 1697. In 1821 the five states overthrew the Spanish rule by a bloodless revolution; in 1822 they called a Constituent Assembly, and in 1823 they declared themselves an independent republic, under the name the United States of Central America. The new confederacy was continually a prey to civil war, arising principally from the mutual hostility of the three races: the white, which prevails in Costa Rica; the Indian, to which in Guatemala almost 90 per cent. of the entire population belong; and the mixed, which is predominant in the three other states. The year 1839 put an end to the union, and the confederacy was divided into five sovereign and independent states. Together with the Spanish dominion, the ecclesiastical rule of the Roman Cath-

olic Church was established throughout the whole extent of Central America. After the declaration of independence, the Central American confederacy showed itself favorable to ecclesiastical reforms and to religious toleration. The Constituent Assembly forbade the proclamation of papal bulls, and the receiving of money for indulgences. From 1826 to 1831 all the convents of monks except those of the Bethlehemites (q. v.) were suppressed, and in 1835 an annual visitation of the female convents was ordered, in order to see that no nun was retained in a convent against her will. In 1832 religious liberty was proclaimed, and Honduras even abrogated for some time the celibacy of priests. Since the dissolution of the union there has always been a fierce struggle between the clerical and the liberal parties. Some of the states, in particular Guatemala, have recalled the priests, and re-enforced the most odious laws of intolerance which ever disgraced a papal country; others, in particular Honduras, have been more faithful to the principles of liberalism. The religious condition of the people, as in all the papal countries of America, is very low. The grossest superstition prevails, especially among the Indians. In the Indian villages the rule of the priest is almost absolute. Worship consists mostly in processions and in the veneration of the images of the saints. Every Indian endeavors to possess a saint's image, which is preserved in the church, and which he carries about in processions on a gilded pole. At the festival of the saint the possessor of the image gives a great banquet, and the priest receives for the mass which he says, in honor of the saint, money and fowl. If the possessor of the image dies without heirs, it is bought by another Indian, lest it be rejected from the church; for the church rejects every image that has no owner, and every such rejection is expected to forbode a calamity to the village. The processions are attended by flutes and other instruments, by immense clouds of frankincense, and by a great display of fireworks. A peculiar custom is observed on the day of Pentecost, when a white dove, ornamented with flowers, is placed on the head of the priest who stands before the altar, and flowers are showered upon him from all sides. Marriages are conducted in the villages before sunrise, a custom probably transmitted from the times of Indian paganism. Efforts to establish Protestantism in Central America have been repeatedly made, especially by missionaries sent out by the venerable Mr. Gosner (q. v.), but thus far without great permanent fruit. The Moravians, however, have had (since 1848) some flourishing missions on the Mosquito Coast, an independent district of Central America inhabited by about 20,000 Indians. Their missionary statistics in 1860 were as follows: stations, 8; missionaries, 7; converts, 219. The Roman Catholic Church in the five states of Central America is under the jurisdiction of the archbishop of Guatemala (who is assisted in his diocese by two bishops *in partibus infidelium*) and four bishops, at San Salvador, Nicaragua, Comayagua (the capital of Honduras), and St. José (in the state of Costa Rica). The aggregate number of parishes in the five states, according to the last accounts, is 248, with 4 missions, and the number of churches 716. See Reichard, *Central-America* (Brunsw. 1851); Fröbel, *Seven Years' Travel in Central-America* (Lond. 1858); Marr, *Reise nach Central-America* (Hamb. 1863, 2 vols.); Squier, *The States of Central-America* (N. Y. 1858). See AMERICA.

Centuriators, the writers of the CENTURIES OF MAGDEBURG (q. v.) are so called.

Centuries of Magdeburg (*Centuria Magdeburgenses*), the name given to the first great work on Church History by Protestant writers. It was projected by Matthias Flacius, and prosecuted by him, in conjunction with Joh. Wigand, Matt. Judex, Basilius Faber, Andr. Corvinus, and Thom. Holzthuter, of Magdeburg. Several of the Protestant princes joined to defray the

expense incurred in the preparation of the work. "The centurions thus describe the process employed in the composition of their work. Five directors were appointed to manage the whole design, and ten paid agents supplied the necessary labor. Seven of these were well-informed students, who were employed in making collections from the various pieces set before them. Two others, more advanced in years, and of greater learning and judgment, arranged the matter thus collected, submitted it to the directors, and, if it were approved, employed it in the composition of the work. As fast as the various chapters were composed they were laid before certain inspectors, selected from the members of the directors, who carefully examined what had been done, and made the necessary alterations; and, finally, a regular amanuensis made a fair copy of the whole. At length, in the year 1559, appeared the first volume of their laborious undertaking. It was printed at Basle, where the thirteenth and final volume (fol.) appeared in 1574; but, as it was projected at Magdeburg, that name was to remain on its title; and the first great Protestant work on Church History has been always commonly known as the Magdeburg Centuries. It was in every point of view an extraordinary production. Though the first modern attempt to illustrate the history of the Church, it was written upon a scale which has scarcely been exceeded. It brought to light a large quantity of unpublished materials, and cast the whole subject into a fixed and regular form. One of its most remarkable features is the elaborate classification. This was strictly original, and, with all its inconveniences, undoubtedly tended to introduce scientific arrangement and minute accuracy into the study of Church History. Each century is treated separately, in sixteen heads or chapters. The first of these gives a general view of the history of the century; then follows, 2. The extent and propagation of the Church; 3. Persecution and tranquility of the Church; 4. Doctrine; 5. Heresies; 6. Rites and Ceremonies; 7. Government; 8. Schisma; 9. Councils; 10. Lives of Bishops and Doctors; 11. Heretics; 12. Martyrs; 13. Miracles; 14. Condition of the Jews; 15. Other religions not Christian; 16. Political changes of the world" (Hook, *Church History*, s. v.). "The work enlisted all the Protestant learning of the age. It was distinguished for its familiarity with original authorities, for its frequent citations, for a criticism which paid no deference to earlier writers on the same subject, and for its passionate style of controversy. For more than a century afterwards, nothing was published but text-books formed from the materials supplied by the Centuries, and written in the same spirit" (Hase, *Church History*, § 10). As a whole, the work is controversial rather than purely historical; but its spirit, its thoroughness, and its method were far in advance of any book in the same field that had arisen in the Roman Church. The "Annals" of Baronius were undertaken in order to counteract the influence of this great work.

The "Centuries" do not reach beyond the 13th century. The best edition is the original one (*Ecclesiastica Historia, etc. per aliquot Studiosos et pios viros in urbe Magdeburgica* (Basil, 1559-74, 13 vols. in 8, fol.); 2d edit. by Lucius, with alterations (Basel, 1624, 13 vols. in 8); new edition, to be extended to 1500, commenced by Baumgarten and Semler, but reaching only the 6th century (Nürnb. 1757-65, 6 vols.); *Epitome* up to 1600, by Osiander (Tüb. 1592-1604, 9 vols.); Germ. transl. by Count Münnich (Hamburg, 1855). See *Buddæus, Inagoge*, bk. ii, chap. vi, § iv, p. 787; *Schaff, Ch. Hist.* vol. i, § 7; *Schaff, Apost. Church*, § 29, p. 66.

Centurion (*κατονράρχης* and *ικατόνταρχος*, a translation of the Latin *centurio*, which also occurs in the Græcized form *κεντυριαν*, Mark xv, 89, 44, 45), a Roman military officer in command of a hundred men, as the title implies. The number under him, however, was not always uniform, being enlarged or less-

ened according to circumstances (see Smith's *Dict. of Class. Antiq.* s. v.). Cornelius, the first Gentile convert to Christianity, held this rank (Acts x, 1, 22). See **CORNELIUS**. Other centurions are mentioned in Matt. viii, 5, 8, 18; Luke vii, 2, 6; Acts xxi, 82; xxii, 25, 26; xxiii, 17, 28; xxiv, 23; xxvii, 1, 6, 11, 81, 48; xxviii, 16. See **ARMY**. The centurion at our Saviour's cross (Matt. xxvii, 54; Luke xxiii, 47) is said to have been named Longinus (see the treatises on this point by Goetze and by Möller, *Obss. philol.* Rost. 1696, p. 4 sq.). See **CAPTAIN**.

Ceolfrid, or **CEOLFIRTH**, a Saxon monk and writer, was born about the year 642, in the kingdom of Northumberland. In 674 he is mentioned by Bede as aiding Benedict Bishop in building the monastery of St. Peter at Wearmouth; and when Benedict founded the monastery of St. Paul at Jarrow, he made Ceolfrid the abbot. Benedict, on his death-bed, designated Ceolfrid abbot of both the monasteries at Wearmouth and at Jarrow. Bede describes him as "a man of great perseverance, of acute intellect, bold in action, experienced in judgment, and zealous in religion." He died on his way to Rome, when he had nearly reached Langres, in France, on the 25th of September, 716. His remains were carried to Wearmouth, but were subsequently removed to Glastonbury. His letter concerning Easter, addressed to Naitan, king of the Picts, and preserved by Bede, is distinguished by strength of reasoning and clearness of style. Bale attributes to him some homilies, epistles, and a tract, *De sua Peregrinatione*.—Wright, *Biog. Brit. Lit.* i, 294 sq.; Bede, *Hist. Eccles.* bk. v, ch. xxi; Hook, *Eccles. Biography*, iii, 532.

Ceperaria (evidently a compound of the Hebrew כפר—see **CAPHAR**—), a town of Palestine mentioned in the *Peutinger Table* as lying between Ashkelon and Jerusalem, 8 (or 18) R. miles from Eleutheropolis, and thought by Reland (*Palæst.* p. 684) to be the same as *Capharorsa* (q. v.); but identified by Robinson with "a deserted village, *Keft Uriei*, in or near the plain, not far from Tibneh and the mouth of the Surar" (*Researches*, ii, 648).

Ce'phas (*Κηφᾶς*; in later Heb. or Syriac כפא'ס), a surname which Christ bestowed upon Simon (John i, 42), and which the Greeks rendered by Πέτρος, and the Latins by *Petrus*, both words meaning "a rock," which is the signification of the original. See **PETER**.

Ce'ras (*Κηράς*), mentioned (1 Eedr. v, 29) as one of the "temple servants" whose "sons" returned from Babylon; evidently the KEROS (q. v.) of the Heb. texts (Ezra ii, 44; Neh. vii, 47).

Cerastès. See **SERPENT**.

Ceration, **Ceratonia**. See **HUSK**.

Cerdo, or **CERDON**, a Gnostic of the second century. Little is known of his history. Irenæus says that he came to Rome from Syria in the time of Hyginus, A. D. 140. Lardner gathers the testimonies of the fathers with regard to his heresy as follows: Cerdon taught, according to Irenæus, that "the God declared in the law and the prophets is not the Father of our Lord Jesus Christ. For he was well known, the latter unknown; the former was just, the latter good" (Irenæus, as cited by Eusebius (*Hist. Eccles.* iv, 11). Epiphanius's summary is to this purpose (*Hæc.* 41): "That Cerdon learned his doctrine from Heracleon, making, however, some additions of his own; that he came from Syria to Rome, and there spread his notions in the time of Hyginus. He held two contrary principles; he said that Christ was not born. He denied the resurrection of the dead, and rejected the Old Testament." In his larger article Epiphanius writes that "Cerdon succeeded Heracleon, and came from Syria to Rome in the time of Hyginus, the ninth bishop after the apostles; that, like many other heretics, he held two principles and two gods: one good and unknown,

the Father of Jesus; the other the Creator, evil and known, who spake in the law, appeared to the prophets, and was often seen. He taught, moreover, that Jesus was not born of Mary, and that he had flesh in appearance only. He denied the resurrection of the body, and rejected the Old Testament. He said that Christ descended from the unknown Father; that he came to overthrow the empire and dominion of the Creator of the world, as many other heretics do; and, having been a short time at Rome, he transmitted his venom to Marcion, who succeeded him."

Theodoret's account of Cerdon is to this effect: "He was in the time of the first Antoninus. He taught that there is one God, the Father of our Lord Jesus Christ, unknown to the prophets; another, the Maker of the universe, the giver of the Mosaic law; and this last is just, the other good. For he in the law orders 'that an eye should be given for an eye, and a tooth for a tooth;' but the good God in the Gospels commands that 'to him who smiteth thee on the right cheek, turn the other also;' and that to him who would take away thy coat, thou shouldst give thy cloak also. He in the law directs to love a friend and hate an enemy; but the other, to love even our enemies. 'Not observing,' says Theodoret, 'that in the law it is directed that if a man meet his enemy's ox going astray, he should bring him back; and not forbear to help his beast when lying under his burden;' and that he who, according to him, is alone good, threatens 'hell-fire to him who calls his brother fool;' and showing himself to be just, said, 'With what measure ye mete, it shall be meted to you again.'" Irenæus says that when Cerdon was at Rome, he several times renounced his errors; but at length, for returning to them again, or for teaching them in a clandestine manner, he was finally excluded from the Church. Cerdon's views were adopted and amplified by Marcion. See Mosheim, *Commentaries*, cent. ii, § 68; Lardner, *Works*, viii, 444 sq.; Baur, *Die Christliche Gnosis*, p. 101, 278 sq.; and the articles GNOSTICS; MARCION.

Cerealis, PETILIUS, a relative of the emperor Vespasian, and a Roman general of note in several provincial campaigns (Tacitus, *Ann.* xiv, 82; *Hist.* iii, 69, 78, 79; iv, 71, 86; *Agr.* 8, 17). During the war of Titus against the Jews he commanded a detachment against the Samaritans (Josephus, *War*, iii, 7, 32), and was active in the siege of Jerusalem (*ib.* iv, 9, 9; vi, 2, 5; 4, 8).

Cereals, a general term embracing all those kinds of grain (כֶּרֶס, "corn") of which bread (q. v.) is made. See AGRICULTURE. These, among the Hebrews, were the following (see Jahn, *Bibl. Archaeol.* § 58). See GRAIN.

1. *Wheat* (חֵטָה, *chittah*), i. e. חֵטָה, like the Arabic *chittah*; the several kernels are denoted by the plur. חֵטָהִים; Greek *trupos*; in the N. T. the more generic term *citros*; in modern Egypt and Barbary *kamchus*, Heb. כֶּמֶח. It was the most important kind of bread-corn grown in Palestine (Isa. xxviii, 25; Ezek. iv, 9), and, like barley, was raised throughout the land (Deut. viii, 8; Judg. vi, 11; 1 Sam. vi, 18; 2 Sam. iv, 6; xvii, 28; comp. Pliny, xviii, 21); so fully supplying the inhabitants that Solomon was enabled with a surplus to procure the services of king Hiram's artificers (1 Kings v, 11), and considerable exports of wheat to Tyre are spoken of at a later date (Ezek. xxvii, 17). The culture of wheat is still practised there (Robinson, *Researches*, ii, 276 etc.). The finest wheat is said (Mishna, *Menach.* viii, 1) to have grown in Michmas, and an unknown locality called *Mezumichah* (מִצְמוּחָה). In Ezek. (l. c.) a peculiar kind of wheat (חֵטָה מִיִּנְיָה, "wheat of Minnith") is spoken of. See MINNITH. The sowing of wheat fell in Marchesvan (Oct.-Nov.), and the reaping (חֵטָה יִצֵר, "wheat-harvest") at the end of Nisan (March-April). See CALENDAR. Wheat

still ripens in Palestine sometimes in April (Korte, *Reise*, p. 145, 482; Shaw, *Trav.* p. 290), although it is usually fit to cut in May or the beginning of June (Robinson, *Researches*, ii, 99, etc.). See FIRST-FRUIT. Wheat flour (חֵטָה טְרוּחָה, Exod. xxix, 2) was used for bread and cakes (q. v.), and the grains were also roasted (see PARCHED CORN) when green (Joshua v, 11; Ruth ii, 14; 1 Sam. xvii, 17; 2 Sam. vii, 28), as is still the case in Palestine, especially by the reapers (Hasselquist, p. 91). See HARVEST. The kernels were also pounded (Lev. ii, 14; xxiii, 14; 2 Kings iv, 42) into a kind of grits (טְרוּחָה). See EARS (OF CORN).

In the sanctuary wheat was used in considerable quantity (Ezra vii, 22; comp. vi, 9; see Bel 2). Wheat was universally cultivated in the lands of hither Asia, and the adjoining parts of North Africa (Egypt), from the earliest times; but how it was introduced to the Hebrews is unknown. See generally Link, in the *Abhandl. der Berliner Akademie*, 1816-17, p. 127 sq.; Celsus *Herobot.* ii, 112 sq. — Winer, ii, 687. See WHEAT.

2. *Barley* (בָּרֵכָה, *seirah*), of various kinds (chiefly the six-rowed), was largely cultivated (Gen. xxvii, 16; 2 Chron. ii, 10; Ruth ii, 17; 2 Sam. xiv, 80; Isaiah xxviii, 25; Jer. xli, 8) by the Egyptians (Exod. ix, 31 sq.) and Hebrews (as one of the staple products of Palestine, Deut. viii, 8; comp. Joel i, 11), and was used partly as fodder (1 Kings iv, 28; comp. *Pesach. f. iii*, 2) for cattle (Phadr. v, 5, 8; Juven. viii, 154; Pliny, xiii, 47; xviii, 14; xxviii, 81) or horses (*Ætop. Fab.* 140; comp. Sonnini, *Trav.* ii, 20), partly for bread (Pliny, *Hist. Nat.* xviii, 26) for the poorer classes (Judg. vii, 18; 2 Kings iv, 42; John vi, 9, 13; comp. Ezek. iv, 9; Joseph. *War*, v, 10, 2; Philo, ii, 807; Seneca, *Ep.* 18, p. 85, Bip.; Athen. vii, 804; Plutarch, *Apoph.* reg. p. 6, Lips.; Xenoph. *Asiab.* iv, 5, 81; see Weinstein, i, 876 sq.); for the latter purpose it was regarded as wholesome (Lucian, *Macrob.* 5; Pliny, xviii, 66); but, being less palatable than wheat (Athen. iii, 115), it was not usually eaten except under the pressure of hunger (Wilhelm Tyr. xi, 22, p. 809), and therefore constituted the regular fare of Roman soldiers when undergoing correction (Livy, xxvii, 13; Sueton. *Aug.* 24; *Veget. Mil.* i, 13; Dio Cass. xlix, c. 27 and 88; Polyb. vi, 88, 4; Polyæn. iv, 24), as of the hermits in the Christian Church (Jerome, *Opp.* ii, 5); although in early times it was a common article of food (Pliny, xviii, 14; Artemid. i, 71), and is still highly relied upon by the Arabs in Morocco (Häst, *Nachr.* p. 182). It was also employed as malt for a species of intoxicating drink (q. v.). See WINE. Barley was sown in the middle of the month of Marchesvan (q. v.), or November (Lightfoot, p. 840, 1004), and was reaped in the month Abib (q. v.), or April (at Jericho in March; see Buhle, *Calendar. Palest. æcon.* p. 14, 28; in less favored situations even in May, Robinson, *Res.* ii, 99, 100); and these seasons became regular notations of time (2 Sam. xxi, 9; Ruth i, 22; Judith viii, 2). See HARVEST. See generally Celsus, *Herobot.* ii, 239 sq. On the kinds of barley known to the ancients, see Link, in the *Abhandl. der physikal. Classe der kön. preuss. Akademie d. Wissenschaft.* 1816-17, p. 183 sq. On Num. v, 15, comp. the article JEALOUSY-OFFERING. — Winer, i, 410. See BARLEY.

3. *Spelt* (שֵׁבֶלֶת, *kuss' meth*; Arab. *kassamat*; Aram. כֶּמֶחָה; *Triticum spelta* of Linn.; by the Latins *odor* or *adoreum*, Adam, *Rom. Ant.* ii, 434), mentioned in Exod. ix, 32; Isa. xxviii, 25; Ezek. iv, 9 [see FITCHES], is a species of bread-corn with a four-petaled blunt calyx, hermaphrodite blossoms, followed by little bearded slender ears, seemingly aborn (hence the name, from שֵׁבֶלֶת, to *cartail*), whose grains adhere so firmly in the husk as to be with difficulty separated from it. It grows about as tall as barley, and was cultivated in the southern parts of Europe (Strabo, v,

227), as well as in Egypt (Herod. ii, 86; Pliny, xviii, 19), Arabia, and Palestine (where it is still raised), of several varieties, the winter grain being esteemed the best (Exod. ix, 32). Among the Israelites it was usually associated with barley as a field-crop (Isa. i. c.). The meal is fine, and whiter than wheat flour (Pliny, xviii, 11); the bread made of it (Phocas, c. 23) is more brittle and less nutritious than wheat (Dioscor. ii, 111). Comp. generally Celsius, *Herob.* ii, 96 sq. Various other significations of the above Heb. term may be seen in Lindorfii *Lex. Heb.* ii, 1007; among moderns, Shaw (*Trav.* p. 351) understands *rice* (*oryza*, Linn.); the Sept. has *ζία* in Isa., but *δλωρα* in both the other passages (both are synonymous terms, Herod. ii, 84). Comp. Link, *Urwelt*, i, 404 sq.—Winer, i, 270. See **SPELTER**.

4. *Millet* appears to be denoted by the Heb. מִלֵּית, *dockna* (Arab. *dachna*) of Ezek. iv, 9, which, however, Gesenius (*Theo.* p. 388) regards as a generic term, in distinction from the *Indian millet* (*Hochus dockna*, Linn.), a species of cereal (Pliny, xxvii, 63) peculiar for its hermaphrodite or two-bearded and mostly two-petaled calyx. It stands quite tall, and bears prolate brown kernels pressed together and resembling rice. It blossoms in Egypt (Rosellini, *Monum. civ.* i, 363 sq.; Forskall found it at Rosetta) in the beginning of November, and is also now cultivated in Arabia (Wellsted, *Trav.* i, 296), where the grain is used for a poor sort of bread (Niebuhr, *Reise*, i, 158). See generally Celsius *Herob.* i, 453 sq.; Oedmann, *Samml.* v, 92 sq.—Winer, ii, 104. See **MILLET**.

Some distinct species of grain is thought by many (so the Sept., Aquila, Theod., and Vulg.) to be designated by the term מִלֵּית, *nisman*, of Isa. xxviii, 5; whether a variety of millet, spelt, or barley, or some totally different cereal, is not agreed; but the word is perhaps rather an appellative indicative (so the A. V. "appointed" barley) of a barley-field (see Rosenmüller and Gesenius, in loc.). Other modern gramineous plants, as rye, oats, maize, rice, etc. do not appear to be mentioned in Scripture. See **RYE**. Some of the smaller grasses, however, seem to have been employed as farinacea. See **CUMMIN**. Certain legumes also, as beans, peas, etc. were used for similar culinary purposes. See **PULSE**.

Ceremony, Latin *cerimonia*, a word sanctioned by Ciceronian usage, but of uncertain etymology, and variously derived: (1) from *Ceres*, and the offerings made to her; (2) from *Cære*, the Etrurian town, whither the sacred things and Vestals of the Romans were conveyed for safety from the Gauls (Forcellini, *Lex. tot. Latini*); (3) from *Carere*; (4) from *Carus* and *Caritas*; (5) from *Cerus*, an obsolete Latin word=*pius, sanctus*, i. e. pious, sacred (Scaliger); (6) from *Coirra*=*Cera* (Georges' *Lexikon*); (7) from *Catum*, as though it should be *Cakimonia*.

Particular ceremonies are treated in this work under their appropriate heads. We propose only to consider here (1) whether the term is a suitable one to denote Christian church services, and (2) its import in creeds and symbolical books, making free use of Palmer's article in Herzog, *Real-Encyklop.* (Suppl. i, 814).

Whenever the word ceremony is used in an indefinite way of a religious act, we must not overlook the distinction between the essential, necessary part of the act, without which no worship can be, and its accompanying forms, which only serve to give it greater solemnity, and bring out more strikingly the contrast with common life. This non-essential part only is *ceremony*. To illustrate farther: the religious act may be defined as something done in obedience to divine command, and therefore necessary to salvation; while ceremony represents man's voluntary work, the offspring of the connection of the religious impulse and his æsthetic taste. Hence results the truly Protestant doctrine that these forms, because they are subjective-

ly conditioned, may vary according to times and places. The Roman Catholic Church, in spite of her longing for absolute unity, is unable to prevent some freedom and variety in this respect, and allows that particular rites (*ritus particulares*) need not be everywhere exactly the same, though universal ones (*ritus universales*) must be observed always and everywhere alike. On this point Melancthon rightly says, "We do not fully understand what our opponents mean" (Non satis intelligimus, quid velint adversari); for by the distinction of universal and particular rites, the Protestant view is, in fact, conceded to be correct, and the only question would seem to be, which rites belong to the one and which to the other class. Yet, under the Romish view, we have only to rank among the universals as many as possible of the most formal, unmeaning, and arbitrary things, and thus make them obligatory. In the distinction of the divinely commanded and the humanly devised, we must keep in view (1) that the Mosaic law made what we call ceremony the subject of divine enactment, and did not leave it to man's choice; and (2) that this choice is not individual caprice. Whatever, through the Church's tendency to improvement in matters of worship, has grown into ritual forms—whatever has become settled practice in the Church, should be respected by the individual, as a custom inherited from the fathers—with the condition, indeed, that when a ceremony has lost its original, correct meaning, or assumed a false one, or when its outward form has become opposed to the moral consciousness and condition of the Church, Christian freedom may assert its right to abolish, simplify, or replace such ceremony.

The distinction may be made clearer by the following illustrations: To baptize is not a ceremony, but a necessary church act; but the use of a cope and surplice, of a silver baptismal cup and bowl, of certain liturgically prescribed words, the laying on of the hands, the sign of the cross—these constitute ceremony. Again, we celebrate the Lord's Supper in obedience to Christ's command, but ceremony prescribes how we shall furnish a table, as a New Testament altar; what kind of vessels we shall use; whether, like the Lutherans, we shall give the *waffer* to each communicant, with the same words, or, like the Reformed, shall cut the bread, etc.; whether the communicants shall kneel or not, etc. These examples show that what is necessary and what is voluntary, what is divinely enjoined and what is pleasing to man, the kernel and the shell, cannot be mechanically separated; and that, though some ceremony enters into all religious services, it should never be mere empty, unmeaning form. What are called in public life court ceremonials are indeed such, but the minister of the Gospel may not be merely a master of ceremonies. In judicial proceedings ceremony may have real significance: e. g. in the taking of oath, the raised hand and set form of words, the assumption of a black cap by the judge when pronouncing sentence of death, and the breaking of a staff before the execution, non-essential, yet symbolic acts, powerfully influence the imagination.

The application of the term ceremony to the rites of Christian baptism, marriage, burial, etc. is repugnant to our feelings, as implying excessive formality. The Socinians alone call baptism and the Lord's Supper ceremonials, regarding them as essentially unmeaning observances, though enjoined by Christ. On the other hand, the Roman Catholic and High-Church view assigns to certain ceremonial acts somewhat of saving efficacy, to attain which duly authorized forms must be observed. The evangelical Protestant, eschewing either extreme, accepts as helps in the Christian life such ritual forms as by their outward correspondence with the religious idea tend to edify; but he does not trust in them as having power to save; for him, far more important than sprinkled water, folded hands, chrism, or holy vessel, is the *Word of God*, understood

by all, and pointing him to the sacrifice of Christ as his hope and salvation. We see, therefore, that the term ceremony is less frequently applicable to the services of the Protestant than to those of the Roman Catholic or Greek Church; and, indeed, in this sense the word is rather foreign to Protestant ecclesiastical and scientific language.

The Reformers were not punctilious in this respect, however; but, in their symbolical books, used ceremony as synonymous with *ritus ecclesiasticus*, and named, as such, *ordo lectionum, orationum, vestitus ecclesiasticus et alia similia* (*Apol. Conf.* xii; Hase, *Libri Symb.* p. 250). Frequently ceremony was confounded with *traditiones*, and what holds good of these applies also to it. Nevertheless, a clear perception of the import of ceremony, and its distinction from the essential church act, is shown in their doctrine that it is not "*per se cultus divinus aut aliqua saltem pars divini cultus*" (*Form. Concord. Epist.* cap. x. p. 651), and that no general conformity therein is required by the practice of the ancient Church; and of more importance still, that no justifying or saving power belongs to the performance of ceremonial acts (*Apol.* viii, p. 206. Paulus ideo damnat Mosaicis ceremonias, sicut traditiones damnat, quia existimabantur esse opera, quæ merentur justitiam coram Deo). If such an opinion of their value obtains, they must be abandoned (Luther, *Tischreden*, th. xi, cap. 10, 8). So we must not, for the sake of our ease or peace, take part in ceremonies which conscience disapproves, to effect the true aim of all ceremonies; i. e. the teaching the ignorant and producing harmony of worship. If those in use fail, the Church may and should establish others; so that, on the one hand, the people lack not those seemly forms, which justly apprehended, "do serve to a decent order and godly discipline," and, on the other, be not so overburdened or misled by them as "in the bondage of the shadow" to lose "the freedom of the spirit" (*Preface to English Prayer-book*).

The Articles of Religion of the Church of England declare that "the Church hath power to decree rites or ceremonies" (Art. XX): and "every particular Church hath authority to ordain, change, and abolish ceremonies, etc." The Methodist Episcopal and Protestant Episcopal churches have similar articles. "If our reasonable service to God as Christians implies certain external acts of worship, these external acts *must* be performed after an external manner—that is to say, there *must* be certain forms and ceremonies in our divine worship. And those sects, like the Quakers, who have pretended to deny this fact, have proved, by their own quaint and peculiar ceremonies, that *something of the sort is needful* even to their form of Christianity. But as it is *needful*, so likewise is it *advantageous* to observe decent and orderly ceremonies in religion." Without such institutions, religion might be preserved, indeed, by a few of superior understanding and of strong powers of reflection, but among mankind in general all trace of it would soon be lost. When the end for which they are appointed is kept in view, and the simple examples of the New Testament are observed, they are of vast importance to the production both of pious feelings and of virtuous conduct; but there has constantly been a propensity in the human race to mistake the means for the end, and to consider themselves as moral and religious when they scrupulously observe what was intended to produce morality and religion. The reason is obvious: ceremonial observances can be performed without any great sacrifice of propensities and vices; they are palpable; when they are observed by men who, in the tenor of public life, do not act immorally, they are regarded by others as indicating high attainments in virtue; and through that self-deceit which so wonderfully misleads the reason, and inclines it to minister to the passions which it should restrain, men have themselves become persuaded that their acknowledgment

of divine authority, implied in their respect to the ritual which that authority is conceived to have sanctioned, may be taken as a proof that they have nothing to apprehend from the violation of the law under which they are placed (Watson, s. v.).

"The rites and ceremonies of the Christian Church, agreeably to the general rules of Scripture, ought to be of such a kind as to promote the order, the decency, and the solemnity of public worship. At the same time they ought not to be numerous, but should preserve that character of simplicity which is inseparable from true dignity, and which accords especially with the spiritual character of the religion of Christ. The apostles often remind Christians that they are delivered from the ceremonies of the law, which are styled by Peter 'a yoke which neither their fathers nor they were able to bear' (Acts xv, 10). The whole tenor of our Lord's discourses, and of the writings of his apostles, elevates the mind above those superstitious observances in which the Pharisees placed the substance of religion; and, according to the divine saying of Paul, 'The kingdom of God is not meat and drink, but righteousness and peace, and joy in the Holy Ghost' (Rom. xiv, 17). The nature of this kingdom is forgotten when frivolous observances are multiplied by human authority; and the complicated, expensive pageantry of Roman Catholic worship, together with the still more childish ceremonies which abound in the Eastern or Greek Church, appear to deserve the application of that censure which the apostle pronounced when he represented the attempts made in his days to revive the Mosaic ritual as a 'turning again to weak and beggarly elements.' Further, all the Scripture rules and examples suggest that, in enacting ceremonies, regard should be had to the opinions, the manners, and prejudices of those to whom they are prescribed, and that those who entertain more enlightened views upon the subject should not despise their weak brethren. Upon the same principle, it is obvious that ceremonies ought not to be lightly changed. In the eyes of most people, those practices appear venerable which have been handed down from remote antiquity. To many the want of those helps to which they have been accustomed in the exercises of devotion might prove very hurtful, and frequent changes in the external parts of worship might shake the steadfastness of their faith. The last rule deducible from the Scripture examples is this, that the authority which enacts the ceremonies should clearly explain the light in which they are to be considered; should never employ any expressions, or any means of enforcing them, which tend to convey to the people that they are accounted necessary to salvation; and should beware of seeming to teach that the most punctual observance of things in themselves indifferent is of equal importance with judgment, mercy, and the love of God."—Hill, *Lectures on Divinity* (N. Y. ed., p. 778). See also Palmer, in *Herzog's Real-Encyclopædie*, Supplem. i, 814; Farindon, *Sermons*, ii, 180, 181; iii, 27, 226; *Common Prayer* (Ch. of England), *Of Ceremonies*; Barrow, *Works* (N. Y. ed.), i, 593; ii, 389; iii, 168.

Cerinthians, followers of Cerinthus (q. v.).

Cerinthus (Κήριθος), a heresiarch, who lived in the time of the apostle John, towards the end of the first and at the beginning of the second century. The accounts of the ancients and the opinions of modern writers are equally at variance with respect to him. He was a Jew by nation and religion, who, after having studied in the schools of Alexandria, appeared in Palestine, and spread his errors chiefly in Asia Minor. Our sources of information as to his doctrines are Irenæus, *adv. Hæc.* i, 26; Eusebius, *Hist. Eccl.* iii, 28; vii, 25; Epiphanius, *Hæc.* 28; and Theodoret, *Fab. Hæc.* ii, 8 (Opp. tom. iii). Epiphanius makes him to have been one of those Jews who, in their zeal for the law of Moses, troubled the Church

of Antioch by insisting on the necessity of the legal ceremonies for the Gentile converts; but in this he is probably mistaken. The account of Irenæus is that he appeared about the year 88, and was known to St. John, who wrote his Gospel in refutation of his errors. Irenæus, on the authority of Polycarp, narrates that the apostle John, when at Ephesus, going on a certain day to the bath, and finding Cerinthus within, fled from the building, saying, "Let us even be gone, lest the bath should fall to pieces, Cerinthus, that enemy of the truth, being within." Eusebius (iii, 28), quoting from the presbyter Caius, states that Cerinthus put forth some *Revelations*, written by himself, as it were by some great apostle, filled with the most monstrous narrations, which he pretended to have received from angels.

As to his peculiar tenets, also, "there is great difference of opinion. Some consider his system to be pure Gnosticism; others a compound of Gnosticism, Judaism, and Christianity. Irenæus says, 'Cerinthus taught that the world was not made by the supreme God, but by a certain power (Demurge) separate from Him, and below Him, and ignorant of Him. Jesus he supposed not to be born of a virgin, but to be the son of Joseph and Mary, born altogether as other men are; but he excelled all men in virtue, knowledge, and wisdom. At His baptism, the Christ came down upon Him, from God who is over all, in the shape of a dove; and then He declared to the world the unknown Father, and wrought miracles. At the end, the Christ left Jesus, and Jesus suffered and rose again, but the Christ, being spiritual, was impossible.' Epiphanius says nearly the same, but asserts that Cerinthus taught that the world was made by angels, and that he opposed the apostles in Judæa. It appears that Cerinthus considered Christ an ordinary man, born in the usual way, and devoid of miraculous powers, but distinguished from the rest of the Jews by possessing superior wisdom, so that He was worthy to be chosen as the Messiah; that he knew nothing of his high dignity till it was revealed to Him in His baptism by John, when He was consecrated to the Messiahship, and furnished with the necessary powers for the fulfilment of His office by the descent of the supreme Logos or Spirit from the heavens, which hung over Him like a dove, and at length entered into His heart; that He was then raised to the dignity of the Son of God, began to perform miracles, and even angels were now taught by His revelations; that redemption could not be effected by His sufferings. Jesus, in union with the mighty Spirit of God, could not suffer, but must triumph over all His enemies. The very fact of suffering was assumed to be a proof that the Spirit of God, which had been previously united to Him, was now separated from Him, and had returned to the Father. The sufferings were of the man Jesus, now left to himself. Cerinthus denied also the resurrection of Christ. He adhered in part to Judaism, and considered the Mosaic law binding on Christians. He taught that the righteous would enjoy a paradise of delights in Palestine, and that the man Jesus, through the power of the Logos again coming upon him, as the Messiah, would reign a thousand years" (Farrar, *Eccles. Dict.* s. v.). It is supposed that Cerinthus and his doctrines are alluded to in John's Gospel. The system of Cerinthus seems to combine Ebionitism with Gnosticism, and the Judæo-Christian millenarianism. A full discussion of Cerinthus and his doctrines is given by Moebeim, *Comment.* c. i, § 70. See also Gieseler, *Ch. Hist.* period i, § 86; Hagenbach, *Hist. of Doctrines*, i, § 28; Neander, *Ch. Hist.* i, 896; Neander, *Planting*, etc. i, 325, 392; Dorner, *Lehre v. d. Person Christi*, i, 810; Lardner, *Works*, viii, 404 sq.; Schaff, *Ch. Hist.* i, 286; Paulus, *Historia Cerinthi* (Jena, 1795); Schmidt, in *Bibliothek für Kritik*, etc. i, 181 sq.; Cunningham, *Historical Theology*, i, 125 sq.

Certitude OF SALVATION. See ASSURANCE.

Cerularius. See CÆRULARIUS.

Cesar, Cesarea, Cæsarius. See CÆSAR, CÆSAREA, CÆSARIUS.

Cestius Gallus, son of C. Cestius Gallus Camerounus, was governor (*legatus*) of Syria A.D. 64, 65, when the Jews broke out into the rebellion which ended in the destruction of their metropolis and Temple by Titus. Maddened by the tyranny of Gessius Florus (q. v.), they applied to Gallus for protection; but, though he sent Neapolitanus, one of his officers, to investigate the case, and received from him a report favorable to the Jews, he took no effectual steps either to redress their injuries or to prepare for any outbreak into which their discontent might drive them. When at last he found it necessary to act, he marched from Antioch, and, having taken Ptolemais and Lydda, advanced on Jerusalem. There he drove the Jews into the upper part of the city and the precincts of the Temple, and might, according to Josephus, have finished the war at once, had he not been dissuaded by some of his officers from pursuing his advantage. Soon after he unaccountably (comp. Matt. xxiv, 15, 16) drew off his forces, and was much harassed in his retreat by the Jews, who took from him a quantity of spoil. Nero was at the time in Achaia, and Gallus sent messengers to him to give an account of his affairs as favorable as possible to himself. The emperor, however, much exasperated, commissioned Vespasian to conduct the war; and the language of Tacitus seems to imply that Gallus died before the arrival of his successor, his death being probably hastened by vexation. (Josephus, *Life*, 48; *War*, ii, 14, 8; 16, 1 and 2; 18, 9 and 10; 19, 1-9; 20, 1; iii, 1; Tacit. *Hist.* v, 10; Sueton. *Vesp.* 4.)—Smith, *Dictionary of Biography*, ii, 226. See JERUSALEM.

Ce'tab (Κητύβ, Vulg. *Celtra*), given (1 Esdr. v, 80) as one of the "servants of the Temple" whose "sons" returned from Babylon; but the Heb. lists (*Ezra* ii, 46; Neh. vii, 48) do not contain any corresponding name.

Cetubim (the usual Anglo-Latin form of the Heb. term כֶּתוּבִים, *Kethubim*, the *Writings*), one of the three large divisions of the Old Test. used by the Jews, and thus distinguished from the Law and the Prophets (the other divisions), as being, in the first instance, committed to writing, and not orally delivered. Hence the Book of Daniel is found in this section, his prophecies having been originally written down, and not uttered orally. This division of Scripture is also known by the equivalent Greek name HAGIOGRAPHIA (q. v.). It contains the Psalms, Proverbs, Job, Canticles, Ruth, Lamentations, Ecclesiastes, Esther, Daniel, Ezra and Nehemiah (reckoned as one), and Chronicles. See BIBLE.

Ceylon (the *Taprobânê* of the Greeks and Romans, the *Serendib* of the "Arabian Nights;" *Lanka*, in Singhalese; *Selanôve*, in the Indian language, whence, probably, *Celana* or *Ceylon*, the European name), an island in the Indian Ocean, southeast of the coast of Coromandel (Hindustan), from which it is separated by the Gulf of Manaar. It lies between 5° 55' and 9° 51' N. lat. and 79° 42' and 81° 55' E. long. From north to south its length is about 270 miles; its narrowest width 40 miles, and its greatest 187½ miles. Its area is about 25,000 square miles. Ceylon can vie with any part of the world in natural beauty, richness of soil, and variety of fauna and flora.

The climate is much more equable than that of the main land of India. The average temperature is about 80°; 80 inches is the average annual fall of rain. The population, according to the Gotha Almanac for 1867, numbers 2,079,881. The European and other inhabitants, including the military, amount to about 25,000. Sir J. E. Tennent is of opinion that Ceylon, when in the height of its prosperity, must have been ten times as densely populated as at the present

day. The natives are divided into four classes: first, the Ceylonese or Singhalese, occupying the Kandian territories and the coasts; second, the Moormen, who are found in all parts of the island; third, the Veddahs, a wild race who live in the mountains in the eastern part of the island, and, fourth, the Hindoos, who occupy chiefly the N. and E. coasts, and speak the Tamil language. Besides these there are also in the island some Portuguese, Dutch, and English colonists; and an intermixture of these with each other, and with the native races, forms still another class called "burghers." The Singhalese believe themselves to have been the aborigines. The Portuguese discovered Ceylon in 1505. They subsequently became masters of the island, and from them it was conquered by the Dutch, in 1666, just a century and a half after the arrival of the Portuguese. In 1796 the English took possession of Colombo, and in 1815 of Kandy (Newcomb, *Cyclopaedia of Missions*, s. v.).

Religion.—"The Singhalese are devoted to Buddhism, which is the prevailing religion of the island. It does not exist, however, in that state of purity in which it is still found in the Indo-Chinese peninsula. Its sacred books are identical with those of Burmah and Siam, and both record the doctrines of Gautama in the Pali language; the deviations are in matters of practice. The Malabar kings adulterated Buddhism to a considerable extent with Brahmanism, introducing the worship of Hindoo deities into the Buddhist temples, and this continues more or less to be the case. More than once have the Buddhists of Ceylon sought to restore the purity of their faith—at one time sending deputies to Siam, at another to Burmah, with this object in view. The Burman or Amaraपुरa sect have long been the reformers of Singhalese Buddhism, and maintain no very friendly relations with the party who, supported by the priests of Siam, acknowledge the civil power in matters of religion, sanction the worship of Hindoo deities and the employment of the priesthood in secular occupations, uphold caste, and restrict the sacred books. Caste was acknowledged by the Singhalese prior to the introduction of Buddhism, which in principle is opposed to it; but so firmly was it rooted that it still endures, though more as a social than a sacred institution. Gautama Buddha is said to have visited Ceylon three different times to preach his doctrine, and his *ari-pada*, or sacred foot-step, on the summit of Adam's Peak still commands the homage of the faithful. Buddhism was not, however, permanently introduced into Ceylon till 807 B.C., when Mahindo, obtaining the support of the king, established it as the national faith. The influence of the priests gradually increased, and, by the piety of the Singhalese kings, monasteries were richly endowed; for though the Buddhist monk is individually forbidden to possess goods, a community may own property to any extent; and it is a remarkable fact that, at the present day, no less than one third of the cultivated land of the island is computed to belong to the priesthood, and is exempt from taxation" (Chambers, s. v.). The Moormen, scattered through the island, are Mohammedans. The Hindoos (Malabar or Tamils), who form the chief population of the district of Jaffna, follow Brahminism. See BRAHM; BUDDHISM; HINDOOISM.

MISSIONS IN CEYLON.—1. *Roman Catholic.*—During the tenure of Ceylon by the Portuguese (1505-1666), they introduced the Roman Catholic religion. In 1544, Xavier (q. v.) preached to the Hindoos in Ceylon. The mission was very successful; a Jesuit college and several convents were erected, and the province of Jaffna became almost wholly Christian. The missionaries did not penetrate far into the interior. The Church of Rome has at present two vicariates apostolic, Colombo and Jaffna, and claim a membership of about 140,000, of whom 55,000 belong to the vicariate of Jaffna. Detailed statistical information on the vi-

cariate of Jaffna is given in Battersby's *Catholic Directory* for 1864 (Dublin, 1864, p. 397-400).

2. *Dutch.*—When the Dutch drove out the Portuguese, they began at once to plant the Reformed religion. (In the remainder of this account we follow Newcomb, *Cyclopaedia of Missions*, p. 223 sq., and Brown, *History of Missions*, vol. i.) They took possession of the Roman Catholic churches and convents, and banished the priests and nuns. In five years they reported 12,387 children baptized, 18,000 pupils in the schools, 65,000 converts to Christianity. When the Dutch surrendered the island to the English, the number of Christians was stated at 425,000. Many of these were nominal converts; all that was required before baptism was that the candidates should be able to repeat the Lord's Prayer, the Ten Commandments, a morning and evening prayer, and grace upon meat. By a very mistaken policy, the Dutch would give no public employment to an unbaptized native, and the Singhalese were baptized by hundreds with no religious aim whatever. It is not to be wondered at that when the Dutch gave up the island there was little fruit to be seen of their missions in it.

3. *The London Missionary Society.*—In 1804 this society entered upon a mission in Ceylon, and the Rev. Messrs. Voelcker, Palm, and Read were employed as missionaries for several years; but after several years of effort the mission was abandoned.

4. *The English Baptist Missionary Society.*—The English Baptists commenced a mission in Ceylon in 1812 in the person of Mr. Chater, whose efforts to Christianize the Singhalese, or Buddhists, and to systematize the study of their language, have made his name memorable. He died in 1829. The labors of his successors had reached, in 1853, to 181 villages of the Singhalese, in which they maintained 81 schools, with an average attendance of 880 pupils. They had also 488 enrolled as Church members.

5. *The American Board.*—One of the first missionaries of the American Board to the East was the Rev. Samuel Newell. This missionary spent some time at Ceylon. In a letter dated at Colombo, Dec. 20, 1813, Mr. Newell urged an American mission in Ceylon on the following grounds, among others, that the government (English) was friendly to missions; that the population of the island was from one to two millions; that there were but two languages to be learned in order to preach to three millions of people; that the natives could read and write; that the whole Bible had been translated into Tamil, and the New Testament into Singhalese; that there were 200,000 native Christians so called, and at least 100 schools were in operation, and that there but two missionaries in the whole island. The board decided to make Ceylon a mission field, and sent, in 1815, the Rev. Messrs. Meigs, Richards, Warren, Barwell, and Poor, who landed at Colombo in March, 1816. In a year Mr. Poor was able to preach in Tamil, and schools were established at different points. By 1818, through deaths and changes, Messrs. Meigs and Poor only were left in Ceylon; but in 1819, Messrs. Winslow, Spalding, and Woodward, with John Scudder, M.D., arrived in Ceylon. A printing-press was established in 1820. In 1824 an extensive revival occurred in the island. By 1827 there was a high-school, 80 scholars, and 80 native assistants. The mission has passed through many vicissitudes, but, on the whole, its results have been very satisfactory. In 1849 a new version of the Bible in the Tamil was published. The statistics in 1865 were as follows:

Churches.	Members.	Churches.	Members.
Tihipally	38	Chavagacherry	40
Batticotta	127	Oodopitty	22
Panditeripo	49	Karadre	14
Oodoville	125	Valany	12
Manepy	33	Navaly	87
		Total	48

The addition by confession during the year 1865 was only 18, while 9 were removed by death and 8 by excommunication. The aggregate number reported as attending the Sabbath morning exercises at 9 of the 10 stations was 1823; 46 preaching-places were reported, and 62 services are conducted each week; 15 adults and 38 children were baptized. The contributions of the churches for 1865 amounted to £102 7s. 2½d. The income of the Native Evangelical Society was £51. There were 7 stations, 7 sub-stations, 6 missionaries, 1 physician, 8 female assistant missionaries, 8 native pastors, 2 licensed preachers, 20 catechists, 6 teachers in seminaries, 40 school-teachers, and 9 other helpers.

6. *The Church Missionary Society.*—The Church Missionary Society sent four missionaries in 1818 to Ceylon. Two of them—Mr. Mayor and Mr. Lamb-
rick—stationed themselves in Kandy. The town itself has only about 3000 people, but in the neighboring mountains, to which the labors of these missionaries extended, there is a population of 200,000. The fruits of this mission among the Kandians have been very small. The secluded and solitary condition of the Kandian territory, within which Europeans seldom entered, had kept this region under the sway of Buddhism, and the Kandians preserved a rigid conformity to all its rules. After five years five schools had been established, numbering 127 pupils; and in 1839 the number of schools had increased to 13, and the number of scholars to 400. During the last twenty years Europeans have settled along the Kandian Hills, causing some irritation to the peasants, but affording protection to the mission, which is still continued. It is stated in a recent report that the labors of the missionaries are confined in a great measure to sojourners from the maritime provinces, who reside at Kandy and other places in the interior, and who are nominal Christians, and that the native Kandians have received comparatively little attention.

The Church mission station at Baddagame, in the low country, ten miles north of Point de Galle, commenced at the same time as that at Kandy, has been even less successful. Schools have been established, printed books have been circulated and read, and many have been made acquainted with the principles of Christianity. Still there have been but few conversions. In the annual report for 1852, the Rev. Mr. Parsons, one of the missionaries, says: "At this place the church is built (it was dedicated by bishop Heber), and here are the mission residences, seminary, and girls' school; but here, alas! is the greatest indifference to the good news of salvation."

By far the most important of the stations of the Church of England mission in Ceylon is that at Cotta, a populous district within a few miles of Colombo. Here the mission commenced its labors in 1823, and a collegiate institute was founded in 1827 for the training of native teachers and assistants. It commenced with ten pupils, and has continued to the present time with success, being resorted to by the Tamils of Jaffna, the Kandians from the hills, and the Singhalese from the low country. In this "Oriental college" there were in 1852 22 students in Greek and Latin, Euclid, Scripture History, etc. A printing-press has been for some years in operation, which has issued a translation of the Scriptures known as the "Cotta version."

7. *Wesleyan Methodist Missions.*—The British Conference, stimulated by the earnest appeals of Dr. Coke (q. v.), and by the wishes of Sir A. Johnstone, chief justice of Ceylon, determined in 1813 to organize a mission in Ceylon. Dr. Coke, accompanied by six missionaries, Messrs. William Ault, James Lynch, George Erskine, William Martin Harvard, Thomas Hall Squance, and Benjamin Clough, set sail from Portsmouth on the 80th of December, 1813. Two of the party, Harvard and Squance, were acquainted with the management of the printing-press, which subsequently became the chief instrument in the mis-

sion. On the 8d of May Dr. Coke died on the passage. The missionaries landed in June, and were most cordially received by the British functionaries on the island. It was decided to occupy at first only four stations, viz., Jaffna and Batticaloa, for the Tamil division of the island; Galle and Matura for the Singhalese; Messrs. Lynch and Squance to be stationed at Jaffna, Mr. Ault at Batticaloa, Mr. Erskine at Matura, and Mr. Clough at Galle.

It is impossible for us to enter into details concerning this most interesting and successful mission. By 1818 there were 70 members of the Wesleyan Church; in 1863 there were over 50 churches and about 2200 members. The literary labors of the Wesleyan missionaries have been more extended than those of any others, and their contributions to our knowledge of Buddhism are of priceless value. "The Methodists," says Sir E. Tennent, "have been the closest investigators of Buddhism, the most profound students of its sacred books in the original, and the most accomplished scholars both in the classical and vernacular languages of Ceylon." Their publications in Singhalese, against Buddhism and in favor of the evidences of Christianity, have been of great service. One of the missionaries, John Calloway, published a Dictionary of Singhalese, with several sermons and tracts; W. B. Fox, a Singhalese and Portuguese Vocabulary; Robert Newstead translated the N. T. and the Hymn-book into Portuguese; Alexander Hume translated the first part of Pilgrim's Progress into Singhalese. The most eminent names in literature among the Ceylon missionaries, however, are those of R. Spence Hardy (author of *Eastern Monachism*; *Manual of Buddhism*; and other works), and of the Rev. D. J. Gogerly (+1862), late general superintendent of the Wesleyan Missions in South Ceylon, who stood at the head of Pali scholarship at the time of his death (see GOGERLY). So great has been the effect of the preaching and of the literary labors of the Wesleyan missionaries, that the Buddhists have formed a society (since 1860) to propagate the doctrines of Gautama by itinerant preaching, the press, and colportage.

In 1866, the statistics of Wesleyan Missions were as follows:

	Chiretta.	Chapala.	Other Preach- ing Places.	Missionaries and Assistant Missionaries.	Subordinate Agents.	Members.	On Trial for Membership.	Scholars in Sunday-schools.	Attendance on Public Worship.
Southern Ceylon (Singhalese).	15	46	27	19	117	1178	363	2500	3326
Northern Ceylon (Tamil).	5	6	31	8	95	406	73	1194	1940

Newcomb gave the following statistics of all the missions in Ceylon in 1853:

MISSIONS.	When com- menced.	Missionaries.	Assistants.	Communi- cants.	Schools.	Scholars.	Stations.
English Baptist	1812	3	34	493	31	1,008	3
Wesleyan Methodist	1814	26	69	1749	80	3,768	18
American Board	1816	9	42	385	77	4,242	3
Church Mis. Society	1818	6	167	371	101	3,569	6
Gospel Prop. Soc.	1838	3	1	113	9	831	3
Totals	47	313	3101	268	12,978	33

Boyce (*Statistics of Missions*, London, 1863) gives the following statistics for 1861:

CEYLON.	Principal Stations.	Ministers.				Hearers.	Members.	Day Schools.		
		Europ.	Nat.	Lay Agents.	No.			Teachers.	Scholars.	
Am. B. of For. M.	3	9	4	22	921	453	37	50	1498	
Church Mis. Soc.	19	13	2	35	4753	492	120	4450		
Wesleyan Mis. . .	22	10	25	132	8500	2168	100	148	4934	
Soc. Pro. Gospel .	1	6	13	17	3363	262	64	64	3902	
Baptist Mis. Soc.	9	2	3	11	1920	437	22	20	770	

Literature.—Besides the works already cited, see Turnour, *Epitome of the History of Ceylon* (Colombo, 1886); Knighton, *History of Ceylon* (London, 1845); Tennent, *Christianity in Ceylon* (1850, 8vo); Tennent, *Ceylon: Physical, Historical, etc.* (London, 1859, 8vo); Heber, *Journey in India, with Notes in Ceylon* (Phila. 1829, 8vo); *London Quarterly Review*, April, 1863, art. v (The Ceylon Wesleyan Mission); *Annual Reports, A. B. C. F. M. and of Wesleyan Missionary Society*; Marshall (Roman Catholic), *Christian Missions* (Lond. and New York, 1864, 2 vols.), vol. i, p. 357-409; Stevens, *History of Methodism*, vol. iii, ch. xii.

Chabârè. See ACHABARA.

Chabatsetleth. See ROSE.

Cha'bris (Χαβρείς v. r. Ἀβρίς, Vulg. omits), the son of Gothaniel (ὁ τοῦ Γ.), one of the three "rulers" (ἀρχοντες) or "ancients" (πρεσβύτεροι) of Bethulia (q. v.) in the time of Judith (Jud. vi, 15; viii, 10; x, 6).

Chad, St., bishop of York in the 7th century, was educated under Aidan at the monastery of Lindisfarne. For some years he was head of the monastery of Lesingra, Cleveland. King Oswi made him bishop of York; but as Wilfrid had before been consecrated to that see by French bishops, Chad gave it up at the suggestion of Theodore (q. v.), and was appointed to the see of Lichfield, which he held till his death, March 2, A. D. 672. His name is still preserved in the Calendar of the Church of England (March 2), and the Cathedral of Lichfield is named St. Chad's.—Churton, *Early English Church*, chap. iv.

Chaderton, LAURENCE, the first master of Emanuel College, Cambridge, was born at Chatterton, in Lancashire, in 1546. His parents were of the Romish religion, but the son, after studying the law, went to Cambridge, where he obtained a scholarship in Christ's College, for which his father disinherited him. In 1578 he took his degree of B. D., and was chosen lecturer of St. Clement's Church, Cambridge, where he preached many years; and such was his reputation that Sir Walter Mildmay declared that, if he would not accept the mastership of his college, the foundation should not go on. In the beginning of the reign of James I he was appointed one of the divines at the Hampton Court Conference, and he was also one of the translators of the Bible, translating from Chronicles to the Canticles inclusive. In 1612 he took his doctor's degree. He died in 1640. He wrote a Treatise on Justification, and a sermon preached at St. Paul's Cross.—Rose, *New Gen. Biog. Dict.* vi, 182; Hook, *Ecol. Biography*, iii, 545.

Cha'dias, named (1 Esdr. v, 20), in connection with Ammidloi, as one of the (?) places from which 422 persons ("they of Chadias," οἱ Χαδιασται) returned from Babylon with Zerubbabel; but the Hebrew lists (Ezra ii, 26; Neh. vii, 30) do not contain the name.

Chæ'reas (Χαίριος), a brother of Timotheus, the leader of the Ammonites against Judas Maccabæus (1 Macc. v, 6), who held Gazara (Jazar, 1 Macc. v, 8), where he was slain on the capture of the fortress by the Jews (2 Macc. x, 82, 87).

Chaff (properly חִיב, *mots*; ἄχυρον), the refuse of winnowed grain, separated by the breeze, and consisting of husks and broken straw. It was the custom in the East to burn the chaff after winnowing. There was danger lest, after they had been separated, the chaff should be blown again among the wheat by the changing of the wind, and to prevent this they put fire to it at the windward side, which crept on and continued to burn till it had consumed all the chaff (Psa. lxxiii, 13; Isa. v, 4; Matt. iii, 12). See AGRICULTURE.

The word rendered "chaff" in Isa. v, 24; xxxiii, 11, is חֲשָׁשׁ (chashash'), and means rather dried grass or hay. In Jer. xxiii, 28, it is תֵּבֵן (te'ben), elsewhere "straw." In Exod. v, 12, we read of חֲשָׁשׁ וְעֵבֶר, *stubble for straw*; so that it is not the same as stubble. It means straw cut into small portions, in which state it was mixed with the mud of which bricks were made to give it consistency. See STRAW. In 1 Kings iv, 28, mention is made of a mixed provender for horses and camels of barley and תֵּבֵן, such as the Arabs call *tibn* to this day. In Dan. ii, 35, the term is the Chaldee חֲשָׁשׁ (w). See THRESHING.

Chaff in the Scriptures is a frequent emblem of abortive wickedness (Psa. i, 4; Matt. iii, 12, etc.). False doctrines are called chaff; they are unproductive, and cannot abide the trial of the word and Spirit of God (Jer. xxiii, 28). See BAPTISM OF FIRE. The carrying away of chaff by the wind is an ordinary scriptural image of the destruction of the wicked, and of their powerlessness to resist God's judgments (Isa. xvii, 13; Hos. xiii, 8; Zeph. ii, 2).

Chagab. See LOCUST.

Chagigah. See TALMUD.

Chain (represented by several Heb. and Gr. terms). Chains of different metals appear to have been used by the ancients for various purposes, similar to those of modern times.

1. *As a Badge of Office.*—The gold chain (רִבְדֵי, *rabid'*) placed about Joseph's neck (Gen. xii, 42), and that promised to Daniel (Dan. v, 7, named רִבְדֵי הַמֶּלֶךְ, *hamnik'*), are instances of the first use (comp. 1 Esdr. iii, 6). In Egypt it was one of the *insignia* of a judge, who wore a jeweled image of Thmei or Truth attached to it (Wilkinson's *Anc. Egypt*, ii, 26); it was also worn by the prime minister. In Persia it was considered not only a mark of royal favor (Xenophon, *Anab.* i, 2, § 27), but a token of investiture (Dan. i. c.; Mörner's *Second Journey*, p. 93). In Ezek. xvi, 11, the chain is mentioned as the symbol of sovereignty. The breastplate of the high-priest was in like manner fastened to the ephod with golden chains (Exod. xxxix, 16, 21). See ATTIRE.

2. *Chains for ornamental purposes* (comp. Judith x, 4) were worn by men as well as women in many countries both of Europe (Smith's *Dict. of Class. Ant.* s. v. Torques) and Asia (Wilkinson, iii, 375), and probably this was the case among the Hebrews (Prov. i, 9). The necklace (קַרְנָיִם, *anak'*) consisted of pearls, corals, etc., threaded on a string; the beads were called חַרְזִימִים, *charuzim'*, that is, *perforated* (Cant. i, 10, "chains," where "of gold" is interpolated). Besides

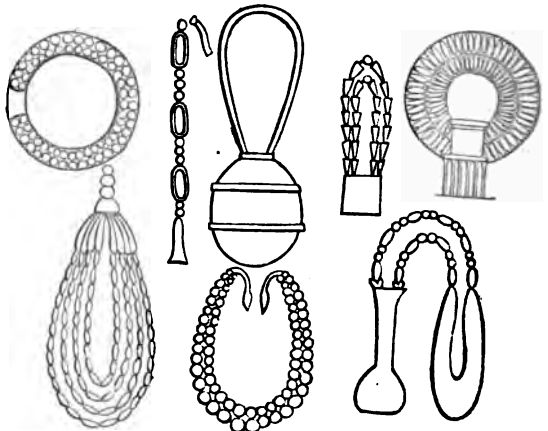

Various Forms of ancient Egyptian Pendants.

the necklace, other chains were worn (Judith x, 4) hanging down as far as the waist, or even lower. Some were adorned with pieces of metal, shaped in the form of the moon, named שַׁהֲרוֹנִים (*saharonim*'), Sept. *μῦρακοι*; Vulg. *lunulae*; A. V. *round tires like the moon*; Isa. iii, 18; a similar ornament, the *hiliil*, still exists in Egypt (Lane's *Modern Egyptians*, App. A.). The Midianites adorned the necks of their camels with such (Judg. viii, 21, 26); the Arabs still use a similar ornament (Wellsted, i, 301). To other chains were suspended various trinkets, as scent-bottles, בִּתְּי (bottey' *han-me*' *phesht*, tablets or houses of the soul, Isa. iii, 20), and mirrors, גִּלְיוֹנִים (*gilyonim*'), Isa. iii, 23). *Step-chains*, צַדִּיּוֹת (*tsediyot*'), *linking ornaments*, were attached to the ankle-rings, which shortened the step and produced a mincing gait (Isa. iii, 16, 18). See ANKLET; NECKLACE. The particular female ornaments thus rendered in Isa. iii, 19 (נֶטִּיפּוֹת, *netiphoth*'), Sept. *κάδρα*, Vulg. *torques*), signify drops or pendants to earrings or other articles of jewelry. See EARRING.

3. The means adopted for *confining prisoners* among the Jews were either manacles or fetters of copper or iron, similar to our handcuffs, נְחֻשְׁתָּיִם (*nechushtayim*, lit. *two brasses*, as though made in halves), fastened on the wrists and ankles, and attached to each other by a chain (Judg. xvi, 21; 2 Sam. iii, 84; 2 Kings xxv, 7; Jer. xxxix, 7). It was a custom among the Romans likewise to fasten a prisoner with a light chain to the soldier who was appointed to guard him. One end of it was attached to the right hand of the prisoner, and the other to the left hand of the soldier. This is the *chain* by which Paul was so often bound, and to which he repeatedly alludes (Acts xxviii, 20; Eph. vi, 20; 2 Tim. i, 16). When the utmost security was desired, the prisoner was attached by two chains to two soldiers, as was the case with Peter (Acts xii, 6; Walch, *De vinculis Petri*, Jen. 1768). (See Smith's *Dict. of Class. Antiq.* s. v. *Catena*.) See FETTER.

Idols, it appears, were fixed in their shrines with chains (Isa. xl, 19). Pride is *emblematically* termed a chain which keeps men under its power (Psa. lxxiii, 6; comp. 1 Esdr. i, 40; Wied. xvii, 87; Eccus. vi, 24, 29). See Wemyse, *Symbol. Dict.* s. v.

Chair. See CATHEDRA; SEAT; THRONE.

Chais, CHARLES-PIERRE, a Swiss divine of the Reformed Church, was born at Geneva in January, 1701. In 1728 he became pastor of the French congregation at the Hague; and he remained in that charge until his death, October, 1785. He translated, from the English of Stackhouse, *Le Sens littéral de l'Écriture Sainte* (La Haye, 1738, 3 vols. 8vo); and also published a commentary on the Bible (*La Sainte Bible avec un Comment. littéral, et des Notes choisies et tirées de divers auteurs Anglais*, 6 vols. 8vo; La Haye, 1742-77; a seventh volume was issued after his death by Dr. Maclaine, with preliminary dissertations, 1790); a work on Biblical Theology (*Theol. de l'Écriture Sainte, ou la Science du Salut*, 2 vols. 8vo, 1752); *Catechisme historique et dogmatique* (La Haye, 1755, 8vo); and numerous minor works.—Senebier, *Histoire Litt. de Genève*; Hofer, *Nouv. Biog. Générale*, ix, 556.

Chaise. See LA CHAISE.

Chajug, JEHUDA BEN-DAVID, commonly called *CHUG*, and in Arabia *Abukaria, Jachja B. Drid el-Fasi el-Kartubi*, and *Jachja*, a Jewish writer who is regarded by Jewish critics as the chief of Hebrew grammarians (יְהוּדָה בֶּן-דָּוִד הַחַיָּג), was born in Fez about A.D. 1020-1040, and hence is sometimes also called *Jehuda Fasi* (יְהוּדָה פָּסִי). He was the first who recognised that the stem words of the Hebrew consist of *three consonants*, as up to his time some of the chief etymologists and expositors, e. g. Suidas Gaon, Menachem, Ibn-Saruk, maintained that there were bi-

literal and even monoliteral stems. He, too, was the first who discovered the true relation of the *quiescent letters*, forming the mnemonic אָהוּא, and their changes. It was he, too, who arranged the Heb. verbs according to their conjugations, distributing them under two heads: 1. *KAL*, *light*, not burdened with any formative additions; and 2. *CABED*, *heavy*, being burdened with formative additions; and fixed six conjugations, viz. 1. *Kal*; 2. *Niphal*; 3. *Hiphil*; 4. *Hithpaal*; 5. *Pual* and *Hophal*; and, 6. *Piel*. This arrangement has been substantially adopted by all grammarians, and is exhibited in all the regular paradigms of the verb given by Gesenius, Ewald, and all modern linguists in their Hebrew grammars. These discoveries and scientific principles Chajug propounds in three books. The first is called אֲרֵיבֵי הַמִּשְׁתָּה הַחֲמִשָּׁה, and treats chiefly of the *quiescent letters*, in three sections. The second book is called הַשְּׁלֵשִׁי הַמִּשְׁתָּה, and treats of verbs whose *second* and *third* radicals are alike = *Ayin doubled*. The third book is called הַשְּׁתֵּי הַמִּשְׁתָּה, and treats of the vowel points and accents. Originally written in Arabic, these marvellous grammatical discoveries were at first inaccessible and unknown to the Germano-French interpreters; but they exercised so extraordinary an influence upon the Spanish school of interpreters, that in order to make them more generally useful they were translated into Hebrew by Aben-Ezra. They have been published by Leop. Duks (Frankft. a. M. 1844, 8vo), who has also given a sketch of the life and linguistic discoveries of Chajug in his *Literaturhistorische Mittheilungen*, etc. (Stuttg. 1844).—Kitto, s. v.; Fürst, *Bib. Jud.* i, 160.

Chalamish (חַלְמִישׁ), a place in Palestine mentioned by the Talmudists (*Echa Rabbati*, i, 17) as being near Naveh (Reland, *Palæst.* p. 702); thought by Schwarz (*Palæst.* p. 236) to be the same with the modern *Sunamein*. See ERRE.

Chalcedon, a city of Bithynia. It was the seat of one of the so-called General Councils of the Church, held A.D. 451 (the fourth œcumenical council), which was called by the emperor Marcianus, at the request of the bishops (especially of Leo I), to put down the Eutychian and Nestorian heresies. The emperor had first summoned the bishops to meet at Nicea, but when the time approached he was prevented by political troubles from going so far from the imperial city, and therefore changed the place of meeting to Chalcedon, in Bithynia, on the Bosphorus, opposite Constantinople. The Council was attended by 630 bishops and deputies, all Eastern except four legates sent by Leo I from Rome. The sessions began Oct. 8, 451, and ended Oct. 31. As the two parties in the Council were roused to the highest pitch of passion, the proceedings, especially during the early sessions, were very tumultuous, until the lay commissioners and senators had to urge the bishops to keep order, saying that such *ἐκβοηθει δημοκρατι* (vulgar outcries) were disgraceful. (See the account from Mansi, cited by Stanley, *Eastern Church*, lect. ii, p. 165.)

At the first session (October 8, 451) the Council assembled in the Church of St. Euphemia; in the centre sat the officers of the emperor; at their left, or on the epistle side, sat the bishops of Constantinople, Antioch, Cæsarea in Cappadocia, and of the other Eastern dioceses, and Pontus, Asia, and Thrace, together with the four legates; on the other side were Dioscurus, Juvenal, Thalassius of Cæsarea, and the other bishops of Egypt, Palestine, and Illyria, most of whom had been present in the pseudo-council of Ephesus. In the midst were the Holy Gospels, placed upon a raised seat. When they had taken their seats, the legates of the pope demanded that Dioscurus should withdraw from the assembly, accusing him of his scandalous conduct at Ephesus, and declaring that otherwise they would depart. Then the imperial officers ordered him

to withdraw from the Council, and to take his seat among the accused. The acts of the so-called "Robber Council" of Ephesus (q. v.) were discussed and condemned, and Dioscurus was left with only twelve bishops to stand by him. The Eutychnian heresy, that in our Lord were two natures before his incarnation, and but one afterwards, was anathematized. The majority of the assembled bishops then proceeded to anathematize Dioscurus himself, and demanded that he, together with Juvenal of Jerusalem, Thalassius of Caesarea, Eusebius of Ancyra, Eustachius of Berytus, and Basil of Selencia, who had presided at the Council, should be deposed from the episcopate. See DIOSCURUS.

At the *second* session (Oct. 10), the following exposition of faith, substantially taken from a letter of Leo to Flavianus, was approved, and its opponents anathematized: "The divine nature and the human nature, each remaining perfect, have been united in one person, to the intent that the same Mediator might die, being yet immortal and impassible. . . . Neither nature is altered by the other; he who is truly God is also truly man. . . . The Word and the flesh preserve each its proper functions. Holy Scripture proves equally the verity of the two natures. He is God, since it is written, 'In the beginning was the Word, and the Word was God.' He is also man, since it is written, 'The Word was made flesh, and dwelt among us.' As man, he was tempted by the devil; as God, he is ministered unto by angels. As man, he wept over the tomb of Lazarus; as God, he raised him from the dead. As man, he is nailed to the cross; as God, he makes all nature tremble at his death. It is by reason of the unity of person that we say that the Son of Man came down from heaven, and that the Son of God was crucified and buried, although he was so only as to his human nature."

At the *third* session the deposition of Dioscurus was pronounced irrevocable, and soon after he was banished to Gangra, in Paphlagonia, where, in the course of three years, he died.

In the *fifth* session the following formula of faith on the question at issue was adopted: "We confess and with one accord teach one and the same Son, our Lord Jesus Christ, perfect in the divinity, perfect in the humanity, truly God and truly man, consisting of a reasonable soul and body; consubstantial with the Father according to the Godhead, and consubstantial with us according to the manhood; in all things like unto us, sin only excepted; who was begotten of the Father before all ages, according to the Godhead; and in the last days, the same was born according to the manhood, of Mary the Virgin, mother of God, for us and for our salvation; who is to be acknowledged one and the same Christ, the Son, the Lord, the only begotten in two natures, without mixture, change, division, or separation; the difference of natures not being removed by their union, but rather the propriety of each nature being preserved and concurring in one person and in one *ὑπόστασις*, so that he is not divided or separated into two persons, but the only Son, God, the Word, our Lord Jesus Christ, and one and the same person." At the later sessions (ix-xv) a number of questions of order, supremacy, discipline, etc. were settled. But by far the most important was the 28th canon, sess. xv, by which the patriarch of Constantinople was placed on equality of authority with the bishop of Rome, saving only to the latter priority of honor. The Roman delegates protested against this, and, after its adoption, Leo constantly opposed it, upon the plea that it contradicted the sixth of Nicæa, which assigned the second place in dignity to Alexandria; however, in spite of his opposition and that of his successors, the canon remained and was executed. See SUPREMACY OF THE POPE.

The acts of this Council in Greek, with the exception of the anathemas, are lost. See Evagrius, *Hist. Eccl.*

ii, 4; Labbe and Cossart, *Concilia*, tom. iv; Mansi, *Concilia*, vi, 590; Landon, *Man. of Councils*, p. 113-127; Gieseler, *Church History* (Cunningham's), i, 240; Mosheim, *Church History*, bk. ii, cent. v, pt. ii, ch. v, § 15, 16; Neander, *Church History*, ii, 518, 524; Hefele, *Concilien-geschichte*, ii, 392; especially Dorner, *Person of Christ* (Edinburgh, div. ii, vol. 1, p. 93-106); Schaff, *Church Hist.* ii, § 56, 65; ii, § 141; Shedd, *History of Doctrines*, i, 398 sq.; Elliott, *Delineation of Romanism*, bk. iii, ch. iii, xl. See CHRYSTOLOGY; COUNCILS; EUTYCHES; NESTORIANISM.

Chal'cedony (χαλκήδων) occurs only in Rev. xxi, 19, being the precious stone with which the third foundation of the wall of the New Jerusalem is garnished. According to Pliny (*H. N.* xxxvii, 8, § 15), chalcedony is a gem resembling the Callais or turquoise, and some have judged it to be a kind of carbuncle or ruby. Salmassius differs from those who make the color of chalcedony to be like that of the carbuncle, and says that they confound τὸν καρνηδώνιον λίθον, which is a species of carbuncle, with τῇ χαλκήδονι; but he confesses that it is by no means clear what stone the ancients called *chalcedonius*. Pigneius on Rev. (xxi, 19) says that this stone has the color of a pallid lamp, shines in the open air, but is dark in a house, cannot be cut, and has powers of attraction. The etymology of the word is not less doubtful than its meaning. Some derive it from χαλκός, from a belief that it rings like brass when struck. Others have derived it from Χαλκήδων, as though from a locality where it is found, and others from Καρνηδών. (See Braun, *de Vest. Heb.* ii, c. ii, p. 525) The *Chalcedonius* was so called from Chalcedon, and was obtained from the copper mines there; it was a small stone, and of no great value. It is described by Pliny as resembling the green and blue tints which are seen on a peacock's tail or on a pigeon's neck. Mr. King (*Antique Gems*, p. 8) says it was a kind of inferior emerald, as Pliny understood it. This mineral is supposed by some to be the same that occurs in the Heb. Scriptures (Exod. xxviii, 18) under the name of ἤρα, *no'phék* (translated "emerald"), but this is doubtful. See EMERALD. Chalcedony of modern lapidaries is a variety of amorphous quartz, and the distinction between it and agate is not very satisfactorily established. It is harder than flint (spec. grav. 2.04), commonly semi-transparent, and is generally of one uniform color throughout, usually a light brown, and often nearly white (and then termed "white cornelian"); but other shades of color are not infrequent, such as gray, yellow, green, and blue. Chalcedony occurs in irregular masses, commonly forming grotesque cavities, in trap rocks and even granite. It is found in most parts of the world; and in the East it is employed in the fabrication of cups and plates, and articles of taste, which are wrought with great skill and labor, and treasured among precious things. In Europe it is made into snuff-boxes, buttons, knife-handles, and other minor articles. (See *Penny Cyclopædia*, s. v. Quartz.)—Kitto, s. v.; Smith, s. v. See GEM.

Chalcidius, according to Fabricius (*Bibl. Lat. lib.* iii, c. 7), a Christian Platonist of the 4th century. Others place him in the 6th century. He translated the *Timæus* of Plato, and added a commentary. Cave (*Hist. Lit. Sac.* iv, an. 380) doubts whether he was pagan or Christian. Lardner says, "I dare not be positive; but to me it seems that he was a polite Platonic philosopher, who was willing to be on good terms with Christians, and I place him, with Cave, about A. D. 380." In his Commentary on *Timæus* he refers to the O. and N. T. repeatedly, and mentions the "star in the East."—Lardner, *Works*, vii, 570; Brucker, *Hist. Crit. Phil.* iii, 472; Murdoch's Mosheim, *Church History*, bk. ii, cent. iv, pt. i, § 18, note; Cudworth, *Intell. System* (Lond. 1845), ii, 463 sq.

Chalcis (Χαλκίς), a city of Palestine mentioned by Josephus (*Ant.* xiv, 8, 2; 7, 4; xix, 5, 1; 8, 1; xx, 1, 3;

7, 1; *War*, i, 9, 2; ii, 12, 1) and Strabo (xvi, 2, 16, p. 763, 765) as lying under Mount Lebanon, near Heliopolis; but thought by Reland (*Palæst.* p. 315) to be different from the Chalcis in Syria, placed by the *Antonine Itinerary* between Beroa (Beroa or Berea) and Androna. Modern travellers (Thomson, in the *Bibliotheca Sacra*, 1848, p. 761; Seetzen, *Reise*, i, 262; Porter, i, 14-16; Robinson, *Lat. Bibl. Res.* p. 497, 498) have sought its site in the considerable ruins near Medjel Anjar, 8 hours S. of Zahleh (Van de Velde, *Memoir*, p. 303).

Chal'col (Heb. *Kalcol'*, כַּלְכֹל, perhaps *sustenance*; Sept. Χαλκὸν v. r. Χαλκῶδ, Josephus Χαλκίος, *Ant.* viii, 2, 5), one of the five sons of Mahol, who were famous for their wisdom before the time of Solomon (1 Kings iv, 31). B.C. ante 1010. In 1 Chron. ii, 6 (where the name is Anglicized "Calcol") he and his brothers are enumerated as the sons of Zerah, the son of Judah, perhaps by an error for the name Hamul preceding, which may be a transposition for Mahol. See **DARDA**.

Chaldæ'a (Jer. i, 10; ii, 24, 35; Ezek. xvi, 29; xxiii, 16; Gr. ἡ Χαλδαία, for the Heb. כַּלְדַּיִם, elsewhere "Chaldeans") is properly only the most southern portion of Babylonia. It is used, however, in our version for the Hebrew ethnic appellative *Kasdim* (or "Chaldees"), under which term the inhabitants of the entire country is designated, and it will therefore here be taken in this extended sense. The origin of the term is very doubtful. *Kasdim* has been derived by some from Kesed (כֶּסֶד), the son of Nahor (Gen. xxii, 22); but if Ur was already a city "of the Chaldees" before Abraham quitted it (Gen. xi, 28), the name *Kasdim* cannot possibly have been derived from his nephew. On the other hand, the term *Chaldæa* has been connected with the city *Kawadha* (Chilmad of Ezekiel, xxvii, 23). This is possibly correct. At any rate, in searching for an etymology, it should be borne in mind that *Kaldi* or *Kaldai*, not *Kasdim*, is the native form (Bawlinson, *Herod.* i, 583, *note*). The Chaldæans are mentioned in the cuneiform inscriptions (q. v.). In Persian cuneiform the name of Babylon or Babylonia is written very differently:

𐎶 𐎠 𐎢𐎽𐎢𐏁 𐎶 𐎠 𐎢𐎽𐎢𐏁 𐎶 𐎠 𐎢𐎽𐎢𐏁
 B a b i l o n

The Babylonian cuneiform writes it in many ways, but none have any resemblance to *Kasdim* or *Kaldi*. See **BABYLON**.

1. *Extent and Boundaries*.—The tract of country viewed in Scripture as the land of the Chaldæans is that vast alluvial plain which has been formed by the deposits of the Euphrates and the Tigris—at least so far as it lies to the west of the latter stream. The country to the east is Elam or Susiana; but the entire tract between the rivers, as well as the low country on the Arabian side of the Euphrates, which is cultivable by irrigation from that stream, must be considered as comprised within the Chaldæa of which Nebuchadnezzar was king. This extraordinary flat, unbroken except by the works of man, extends, in a direction nearly N.E. and S.W., a distance of 400 miles along the course of the rivers, and is on the average about 100 miles in width. A line drawn from the junction of the river Khabur with the Euphrates to that of the Lesser Zab with the Tigris may be considered to mark its northern limits; the eastern boundary is the Tigris itself; the southern the Persian Gulf; on the west its boundary is somewhat ill defined, and in fact would vary according to the degree of skill and industry devoted to the regulation of the waters and the extension of works for irrigation. In the most flourishing times of the Chaldæan empire the water seems to have been brought to the extreme limit of the alluvium, a canal having been cut along the edge of the tertiary formation on the Arabian side throughout its entire extent,

running at an average distance from the Euphrates of about 30 miles.

2. *General Character of the Country*.—The general aspect of the country is thus described by a modern traveller, who well contrasts its condition now with the appearance which it must have presented in ancient times. "In former days," he says, "the vast plains of Babylon were nourished by a complicated system of canals and water-courses, which spread over the surface of the country like a net-work. The wants of a teeming population were supplied by a rich soil, not less bountiful than that on the banks of the Egyptian Nile. Like islands rising from a golden sea of waving corn stood frequent groves of palm-trees and pleasant gardens, affording to the idler or traveller their grateful and highly-valued shade. Crowds of passengers hurried along the dusty roads to and from the busy city. The land was rich in corn and wine. How changed is the aspect of that region at the present day! Long lines of mounds, it is true, mark the courses of those main arteries which formerly diffused life and vegetation along their banks, but their channels are now bereft of moisture and choked with drifted sand; the smaller offshoots are wholly effaced. 'A drought is upon her waters,' says the prophet, 'and they shall be dried up!' All that remains of that ancient civilization—that 'glory of kingdoms'—the praise of the whole earth—is recognisable in the numerous mouldering heaps of brick and rubbish which overpread the surface of the plain. Instead of the luxuriant fields, the groves, and gardens, nothing now meets the eye but an arid waste—the dense population of former times is vanished, and no man dwells there" (Loftus's *Chaldæa*, p. 14, 15). The cause of the change is to be found in the neglect of man. "There is no physical reason," the same writer observes, "why Babylonia should not be as beautiful and as thickly inhabited as in days of yore; a little care and labor bestowed on the ancient canals would again restore the fertility and population which it originally possessed." The prosperity and fertility of the country depend entirely on the regulation of the waters. Carefully and properly applied and husbanded, they are sufficient to make the entire plain a garden. Left to themselves, they desert the river courses to accumulate in lakes and marshes, leaving large districts waterless, and others most scantily supplied, while they overwhelm tracts formerly under cultivation, which become covered with a forest of reeds, and during the summer heats breed a pestilential miasma. This is the present condition of the greater part of Babylonia under Turkish rule; the evil is said to be advancing, and the whole country threatens to become within a short time either marsh or desert.

3. *Divisions*.—In a country so uniform and so devoid of natural features as this, political divisions could be only accidental or arbitrary. Few are found of any importance. The true Chaldæa, as has been already noticed, is always in the geographers a distinct region, being the portion most southerly from Babylon, lying chiefly (if not solely) on the right bank of the Euphrates (Strabo, xvi, 1, § 6; Ptolemy, v, 20). Babylonia above this is separated into two districts, called respectively *Amordacia* and *Auranitis*. The former is the name of the central territory round Babylon itself; the latter is applied to the regions toward the north, where Babylonia borders on Assyria (Ptol. v, 20).

4. *Cities*.—Babylonia was celebrated at all times for the number and antiquity of its cities. "Babel, and Erech, and Accad, and Calneh in the land of Shinar," are the first towns mentioned in Scripture (Gen. x, 10). The "vast number of great cities" which the country possessed was noted by Herodotus (i, 178), and the whole region is, in fact, studded with huge mounds, each mound marking, beyond a doubt, the site of a considerable town. The most important of those which have been identified are Borsippa (now *Birs-Nimrud*), Sippara or Sepharvaim (*Mosab*), Cutha



General Map of the Chaldean and associated Empires.

(Ibrahim), Calneh (Niffer), Erech (Warka), Ur (Mugheir), Chilmad (Kalwadha), Larancha (Semkerek), Is (Hû), Duraba (Akkerkuf); but of these not fully, and of many others not at all, have the exact sites been determined, as the Accad of Genesis (x, 10); the Teredon of Abydenus (Fragm. 8); *Abi, Rubesi*, etc.,

towns mentioned in the inscriptions. Two of these places—Ur and Borsippa—are of particular note. Of the rest, Erech, Larancha, and Calneh were in early times of the most consequence, while Cutha, Sippara, and Teredon attained their celebrity at a comparatively recent period. (See each name in its place.)

5. *Canals*.—These constituted one of the most remarkable features of ancient Babylonia. Three principal canals carried off the waters of the Euphrates toward the Tigris, above Babylon. These were, 1. The original "Royal river," or *Ar-Malcha* of Berosus, which left the Euphrates at Perisabor or Anbar, and followed the line of the modern *Saklaweyk* canal, passing by Akkerkuf, and entering the Tigris a little below Bagdad; 2. the *Nahr Malcha* of the Arabs, which branched off at Riddhivaniyah, and ran across to the site of Seleucia; and, 3. the *Nahr Kutba*, which, starting from the Euphrates about twelve miles above Mossaib, passed through Cutha, and fell into the Tigris twenty miles below the site of Seleucia. On the other side of the stream, a large canal, perhaps the most important of all, leaving the Euphrates at Hit, where the alluvial plain commences, skirted the deposit on the west along its entire extent, and fell into the Persian Gulf at the head of the Bubian creek, about twenty miles west of the Sbat el-Arab; while a second main artery (the *Pallacopas* of Arrian) branched from the Euphrates nearly at Mossaib, and ran into a great lake in the neighborhood of Borsippa, whence the lands to the south-west of Babylon were irrigated. From these and other similar channels numerous branches were carried out, from which further cross cuts were made, until at length every field was duly supplied with the precious fluid.

6. *Sea of Nedjef, Chaldean Marshes, etc.*—Chaldæa contains one natural feature deserving of special description—the "great inland fresh-water sea of Nedjef" (Loftus, p. 45). This sheet of water, which does not owe its origin to the inundations, but is a permanent lake of considerable depth, surrounded by cliffs of a reddish sandstone in places forty feet high, extends in a south-easterly direction a distance of forty miles, from about lat. $31^{\circ} 53'$, long. 44° , to lat. $31^{\circ} 26'$, long. $44^{\circ} 35'$. Its greatest width is thirty-five miles. It lies thus on the right bank of the Euphrates, from which it is distant (at the nearest point) about twenty miles, and receives from it a certain quantity of water at the time of the inundation, which flows through it, and is carried back to the Euphrates at Samava by a natural river course known as the Sbat el-Atehan. Above and below the sea of Nedjef, from the Birs-Nimrud to Kufa, and from the south-eastern extremity of the sea to Samava, extend the famous Chaldæan marshes (Strab. xvi. i, § 12; Arrian, *Exp. Al.* vii, 22), where Alexander was nearly lost; but these are entirely distinct from the sea itself, depending on the state of the Hindiyeh canal, and disappearing altogether when that is effectually closed.

7. *Productions*.—The extraordinary fertility of the Chaldæan soil has been noticed by various writers. It is said to be the only country in the world where wheat grows wild. Berosus noticed this production (*Fragm.* 1, § 2), and also the spontaneous growth of barley, sesame, ochryes, palms, apples, and many kinds of shelled fruit. Herodotus declared (i, 198) that grain commonly returned 200-fold to the sower, and occasionally 300-fold. Strabo made nearly the same assertion (xvi, 1, § 14); and Pliny said (*Hist. Nat.* xviii, 17) that the wheat was cut twice, and afterwards was good keep for beasts. The palm was undoubtedly one of the principal objects of cultivation. According to Strabo it furnished the natives with bread, wine, vinegar, honey, porridge, and ropes; with a fuel equal to charcoal, and with a means of fattening cattle and sheep. A Persian poem celebrated its 860 uses (Strab. xvi, 1, 14). Herodotus says (i, 198) that the whole of the flat country was planted with palms, and Ammianus Marcellinus (xvii, 8) observes that from the point reached by Julian's army to the shores of the Persian Gulf was one continuous forest of verdure. At present palms are almost confined to the vicinity of the rivers, and even there they do not grow thickly except about the villages on their banks. The soil is rich,

but there is little cultivation, the inhabitants subsisting chiefly upon dates. More than half the country is left dry and waste from the want of a proper system of irrigation, while the remaining half is to a great extent covered with marshes, owing to the same neglect. Thus it is at once true that "the sea has come up upon Babylon, and she is covered with the waves thereof" (Jer. li, 42); that she is made "a possession for the bitter, and pools of water" (Isa. xiv, 28); and also that "a drought is upon her waters, and they are dried up" (Jer. i, 88), that she is "wholly desolate"—"the hindermost of the nations, a wilderness, a dry land, and a desert" (*ib.* 12, 13). (See Loftus's *Chaldæa and Susiana*; Layard's *Nin. and Bab.* ch. xxi-xxiv; Rawlinson's *Herodotus*, vol. i, Essay ix; and Mr. Taylor's *Paper in the Journal of the Asiatic Society*, vol. xv.)—Smith, s. v. See BABYLONIA.

8. *Inhabitants*.—The monuments of Babylonia furnish abundant evidence of the fact that a Hamitic race held possession of that country in the earliest times, and continued to be a powerful element in the population down to a period very little preceding the accession of Nebuchadnezzar. The most ancient historical records found in the country, and many of the religious and scientific documents, are written in a language which belongs to the Allophylian family, presenting affinities with the dialects of Africa on the one hand, and with those of High Asia on the other. The people by whom this language was spoken, whose principal tribe was the Akkad (Accad, Gen. x, 10), may be regarded as represented by the Chaldæans of the Greeks, the Kasdim of the Hebrew writers. This race seems to have gradually developed the type of language known as Shemitism, which became in course of time the general language of the country; still, however, as a priest-caste, a portion of the Akkad preserved their ancient tongue, and formed the learned and scientific Chaldæans of later times (Rawlinson, *Herodotus*, i, 588). Their language was the language of science in those countries; and the Chaldæans devoted themselves to the study of the sciences, and especially astronomy. See CHALDÆAN PHILOSOPHY. The scientific tablets discovered at Nineveh are all in this dialect. These facts throw new and clear light on the many allusions to the Chaldæan wise men in the Bible (Dan. i, 4; ii, 2; iv, 7; Ezek. xxiii, 14). The influence and power of the Chaldæans rapidly increased, so that in the early part of the ninth century B.C. they became the dominant race in Babylonia, and gave that kingdom their name (2 Chron. xxxvi, 17; Dan. ix, 1). During the eighth century B.C. a number of them emigrated from their native plains, and settled in the mountains of Armenia. This is possibly the true explanation of the occurrence of the Chaldæans in that region, as noted by many ancient writers (Xenoph. *Anab.* iv, 3, 4; Strabo, xii; Steph. Byz. s. v. *Χαλδαία*); and this, too, shows why Gesenius and other recent authors were led to believe that the Chaldæans of Babylonia were a colony from the northern mountains, settled in that country by one of the later Assyrian monarchs. (See Rawlinson, *Five Great Monarchies*, Lond. 1864 sq.; Dittmar, *Vaterland d. Chaldæer*, Berlin, 1786; Palmblad, *De rebus Babylonicis*, Upsal. 1820; Bochart, *Geography*.)—Kitto, s. v. See CHALDEES.

Chaldæan. See CHALDEANS; CHALDEES.

Chaldæan Philosophy. Ritter (*History of Philosophy*, bk. ii, ch. i) remarks that he passes over the philosophy of the Chaldæans without special notice; both "because the fragments of Manetho, Berosus, and Sanchoiatho are not free from suspicion as to genuineness and antiquity, and also because the ideas and conceptions prevailing in them are of little value philosophically." Beard, in Kitto's *Cyclopedia* (s. v. Philosophy), remarks, nevertheless, that the subject is "of interest to the student of the Bible, in con-

sequence of the general and decided influence which the Babylonian philosophy exerted on the opinions and manner of thinking of the Israelites during their captivity in Babylon, as the Rabbins themselves admit, in alleging that the names of the angels and of the months were derived by the house of Israel from Babylon (*Rosh Hashanah*, p. 56). See CAPTIVITY. The system of opinion and manner of thinking which the captives met with in Babylon was made up of elements whose birthplace was in various parts of the East, and which appear to have found in Babylon a not uncongenial soil, where they grew and coalesced into one general system. Of these elements the two principal were the Chaldean and the Medo-Persian or Zoroastrian.

"The former of these, which alone we shall here consider, seems to have originated in the cultivation of astronomy (q. v.), a science very early pursued under the clear sky of Babylonia, although generally corrupted with a mixture of astrology (q. v.). Light naturally came to be regarded as a divine principle, and the heavenly bodies were worshipped as the residence or impersonation of Deity. This soon diverged into polytheism, as the celestial luminaries were assigned to separate powers of Nature. See IDOLATRY. An observation of the astronomical phenomena led not only to the formation of horoscopes with a view to divining the future, but it likewise induced a belief in certain intermediate powers, which were supposed (as by the now discovered bond of gravitation) to link all bodies together, and whose presence was made to fill the void between them and the invisible Being at the centre. Thus arose the emanation theory, which figures so conspicuously in the Cabbala (q. v.) and in Gnosticism (q. v.). These intermediate or derived existences were invested with intelligence, and formed again a link between spirit and matter, giving rise to a whole world of *dæmons* (q. v.), of various characters and capacities. To guard against the malignant influence of some of these, talismans (q. v.) were used, and the arts of sorcery (q. v.) were resorted to. See CHALDEES.

"The fragments of Berosus, preserved by Eusebius and Josephus, and to be found in Scaliger (*De Eminent. Temp.*), and more fully in Fabricius (*Bib. Gr.* xiv, 175), afford some information on the subject of Chaldean philosophy. Berosus was a priest of the god Baal, at Babylon, in the time of Alexander the Great. The Talmud and other works of the Jewish Rabbins may also be advantageously consulted, together with the following authorities: Euseb. *Prep. Evang.* ix, 10; Philo, *De Mig. Mun.*; Selden, *De Diis Syris*, Proleg. 8; Stanley's *History of Oriental Philosophy*; Rosenroth, *Cabbala denudata* (t. 1, Solih. 1677, t. 2); 'Liber Joh. restitutus' (Francof. 1684); Kleuker, *Emanationslehre bei den Kabbalisten* (Riga, 1786); Molitor, *Philosophie der Geschichte* (1827-8); Hartmann, *Verbindung des A. T. mit dem Neuen*. (1831); Fritz, *Ketzer-Lezikon* (1838); Brucker, *Hist. Crit. Phil.*; Nork, *Vergleichende Mythologie* (Lpz. 1836)." See MAGI.

Chaldeans, or CHALDEAN CHRISTIANS, a name by which the Nestorians (q. v.) call themselves. More commonly it is used to designate that portion of the Nestorians who have acknowledged the supremacy of the Pope.

The writings of Ibas, bishop of Odessa, and the activity of the school of Odessa, disseminated the Nestorian doctrines in Mesopotamia, Assyria, Persia, and other Eastern countries in the 5th century. The adherents of these doctrines received from the orthodox party the name of Nestorians, while they chose for themselves that of Chaldean Christians. Thus separated from co-operation with the Western Church, and the breach being subsequently widened by the schism of the Greek Church, they formed a separate organization, and established an ecclesiastical system of their own, having at its head Ctesiphon, patriarch of Seleucia. After the Council of Florence (q. v.) had to some

extent reunited the Greek and Latin Churches, a large number of Nestorians returned to them. Timotheus, archbishop of the Nestorians of Cyprus, among others, abjured Nestorianism, and was received into the Roman Church in virtue of a bull of Pope Eugene IV (1445), which bull also decided that the name of Nestorians should no longer be applied to the Chaldean Christians. After this, partial accessions of Nestorians to the Roman Catholic Church took place from time to time; a number of them joined it during the reign of Pope Julius III (1552), when Sind, patriarch of the Nestorians of Mosul, asked and obtained the ratification of his election by the Pope. This union was continued by the patriarch Elias, who, in 1616, assembled a synod at Amid, where the patriarch, together with five archbishops and one bishop, endorsed the Roman Catholic Confession of Faith, and declared in favor of union with Rome. Yet separations occurred from time to time. Under Pope Innocent IX a large number of Nestorians joined the Roman Church, and he gave them, as well as to all Chaldean Christians, a patriarch in the person of Joseph I, who made his residence at Amid, usually called Diarbekir. From this time forward the Roman Catholics of Chaldæa have had a patriarch of their own, bearing the title of patriarch of Babylon, and residing at Bagdad. They also preserve a ritual of their own in the Chaldaic language. Besides the patriarch, the Chaldeans have archbishops at Amadie and Seleucia in Asiatic Turkey, four bishops in Turkey, and two in Persia. "This sect is accessible through the missions of the A. B. C. F. M. at Oroomiah and Diarbekir, but principally through the station at Mosul, where some of the members of the Protestant Church are converted Chaldeans. Recently, through papal intrigues with the pasha, the large Chaldean village of Telkeif has been closed to missionary efforts, and even Protestants who own property there have been forbidden to visit it. But such a state of things cannot last, and we may hope soon to hear that such measures have rounded, as they always do, to the furtherance of the truth" (Newcomb, *Cyclop. of Missions*, 243).—Wetzer und Welte, *Kirchenlexikon*; Schem, *Year-book* for 1859, p. 33; Assemani, *Biblioth. Orient.* t. i, p. 203-261, 543-549; ii, p. 457; iii, part ii, p. 412; Guriel (a Chaldean priest), *Elementa lingue Chaldaica quibus accedit series Patriarchatus Chaldaeorum* (Rome, 1860); *Annals of the Propagation of the Faith* (1845); Perkins, *Eight Years among the Nestorian Christians* (N. Y. 1848). See NESTORIANS.

Chaldee Language is the name by which the elder or Eastern form of the Aramaic idiom is generally distinguished (see the *Introductio* to Winer's *Chald. Gramm.* 2d ed. tr. by Prof. Hackett, N. Y. 1851, p. 9 sq.). Whether there is any authority in the Old Testament for applying this designation to the Aramaic language is a question which depends on the sense in which the expression "tongue of the Chaldees," in Dan. i, 4, is to be taken, and which involves such important historical points that it does not come within the scope of this article (see Hengstenberg, *Authenticus des Daniel*, p. 810). Another preliminary question is, whether there is any propriety in the common definition of the Chaldee language as the *Eastern*, and especially as the *Babylonian* dialect—or, indeed, even as a *dialect* at all—of the Aramaic. Hupfeld strenuously maintains the negative of all these propositions in the *Theologische Studien* for 1830, p. 290 sq. Avoiding these debatable points, however, we apply the name Chaldee language to that Aramaic idiom which, in our present text of the Old Testament, is employed in the passages of Daniel, from ii, 4, to vii, 28; in Ezra, from iv, 8, to vi, 18, and vii, from 12 to 26; in Gen. xxxi, 47; and in Jer. x, 11; as also to that in which several translations and paraphrases of portions of the Old Testament, the so-called Targums, are written. The language is thus distinguished, as to the nature of the documents in which it is employed, into

Biblical and Targumical Chaldee. Winer, however, regarding linguistical characteristics chiefly, distinguishes three grades of its purity: the language, as found in the Targum of Onkelos, as most free from Hebraisms; the Biblical Chaldee, which, as it frequently intermixes certain peculiarities of Hebrew (as the Π of the article, the plural ending \square —, the dual form, and the conjugation *Hophal*), ranks below the first class; and the idiom of the other Targums, which not only abounds with foreign words, but possesses several peculiar formations bordering on those of the Syriac and of Rabbinical Hebrew. See TARGUM. The language of the Talmud is also usually called Chaldee; and, if we except the Mishnah (which is written in an idiom not so very far removed from Biblical Hebrew, with a tincture of Chaldee), it is true of the Gemaras that they are written in such very *corrupt* Chaldee that their idiom is more properly designated as the Talmudical dialect. See TALMUD.

Under the article ARAMÆAN LANGUAGE have been noticed those several features which the Chaldee possesses in common with the Syriac; and it now remains to define those, certainly not marked, characteristics by which it is distinguished from it. These are—the predominance of the A sound where the Syriac has O; the avoidance of diphthongs and of otiant letters; the use of dagesh-forte; the regular accentuation of the last syllable; and the formation of the infinitives, except in *Peal*, without the preformative $\mathbf{2}$. The mode of writing is also much less *defective* than in Syriac.—Kitto, s. v.

Works auxiliary to the study of the Chaldee:—GRAMMARS: Cellarius, *Grammat. Ling. Chald.* (Cizæ, 1684); Oplitz, *Chaldaismus Targum. Talmud. Rabbin.* (Kiel, 1696); Hegelmaier, *Chaldaismi Biblici fundamenta* (Tüb. 1770); J. D. Michaelis, *Grammatica Chaldaica* (Götting. 1771); Hexel, *Anweisung zum Chald.* (Lemgo, 1787); Schroeder, *Institut. ad Chaldæism. Biblicum* (1787, 1810); Wittich, *Grundzüge d. bibl. u. targ. Chaldaismus* (Leipzig, 1824); Hirzel, *De Chaldaismi biblici orig. et auct. critica* (Lips. 1830); Dietrich, *De sermone Chaldaico proprietate*; Longfield, *Introduction to Chaldee* (Lond. 1859); Riggs, *Manual of Chald. Language* (N. Y. 1858); Guriel (a Chaldaean priest), *Elementa linguae Chaldaicae* (Rome, 1860); Först, *Lehrgebäude der aram. Idiome* (Leipz. 1885). The best manual is Winer's *Grammatik* (Lpz. 1824), 2d ed. translated by Professor Hackett, *Grammar of the Chaldee Language as contained in the Bible and Targums* (N. Y. 1851). The most complete LEXICON is Buxtorf's *Lexicon Chaldaico-talmudico-rabbinicum* (Basil, 1639; a new ed. by Fische and Gelbe is announced, Lpz. 1866 sq., 4to). There are also Landau's *Rabbinisch-aramäisch-deutsches Wörterb.* (Prague, 1819-24), new ed. by Sperling (Lemberg, 1857); Levy, *Chald. Wörterbuch* (Lpz. 1866, sq.). The Biblical Chaldee words are contained in the Heb. lexicons. CHRESTOMATHIES have been edited by Bauer (Norimb. 1792); J. Jahn (Wien, 1800); Grimm (Lemgo, 1801); Winer, *Chald. Lesebuch a. d. Targumim, m. Anmerk. u. Wortregister* (Leipzig, 1825); P. Ewald, "*Pirke Aboth*," übers. u. erklärt *nebst punctirtem Texte u. Wortregister* (Erlang. 1825); Petermann (Berol. 1840). The Biblical Chaldee is contained in the Heb. Bible.

Chaldee Paraphrases. See TARGUMS.

Chal'dees (or "Chaldæans," Hebrew *Kasdim*, \square \square \square , Sept. *Χαλδαῖος*, Chald. \square \square \square , \square \square \square) appear in Scripture, until the time of the Captivity, as the people of the country which has Babylon for its capital (2 Kings xxv; Isa. xiii, 19; xxiii, 18; comp. Isa. xlvi, 14; Jer. xxi, 4; xxiii, 2 sq.; Ezek. xxii, 15, etc.), and which is itself termed Shinar (\square \square \square); but in the book of Daniel, while this meaning is still found (v, 30, and ix, 1), a new sense shows itself. The Chaldaeans are there classed with the magicians and

astronomers, and evidently form a sort of priest class, who have a peculiar "tongue" and "learning" (i, 4), and are consulted by the king on religious subjects. The same variety appears in profane writers. Berosus, the native historian, himself a Chaldæan in the narrower sense (Tatian, *Or. adv. Gr.* 58), uses the term only in the wider sense, while Herodotus, Diodorus, Strabo, and the later writers almost universally employ it to signify a sect or portion of the people whom they regard either as priests or as philosophers. With this view, however, is joined another, namely, that the Chaldæans are the inhabitants of a particular part of Babylonia, viz. the country bordering on the Persian Gulf and on Arabia (Strab. xvi, 1, § 6; Ptol. v, 20, 3). See BABYLONIA.

1. It appears that the Chaldæans (*Kaldai* or *Kaldi*) were in the earliest times merely one of the many Cushite tribes inhabiting the great alluvial plain known afterwards as Chaldæa or Babylonia. Their special seat was probably that southern portion of the country which is found to have so late retained the name of Chaldæa. Here was Ur "of the Chaldee," the modern Mugheir, which lies south of the Euphrates, near its junction with the Sht el-Hie. Hence would readily come those "three bands of Chaldæans" who were instruments, simultaneously with the Sabæans, in the affliction of Job (i, 15-17). In process of time, as the *Kaldi* grew in power, their name gradually prevailed over that of the other tribes inhabiting the country, and by the era of the Jewish Captivity it had begun to be used generally for all the inhabitants of Babylonia. We may suspect that when the name is applied by Berosus to the dynasties which preceded the Assyrian, it is by way of *prolepsis*. The dynasty of Nabopolassar, however, was (it is probable) really Chaldæan, and this greatly helped to establish the wider use of the appellation. It had thus come by this time to have two senses, both ethnic; in the one it was the special appellative of a particular race, to whom it had belonged from the remotest times; in the other it designated the nation at large in which this race was predominant.—Smith, s. v. Probably it was a branch of the same people that are spoken of in Greek writers as an uncultivated tribe of mountaineers, on the Carduchian mountains, in the neighborhood of Armenia, whom Xenophon describes as brave and fond of freedom (*Cyrop.* i, 81; *Anab.* iv, 3, 4, 7, 8, 25). In Hab. i, 6-10, the Chaldæans are spoken of in corresponding terms. The circumstance, moreover, that a Semitic dialect is found to have prevailed in Babylon, corroborates the idea that the Chaldæans were of a mixed character. See CHALDÆA.

2. The kingdom of the Chaldee is found among the four "thrones" spoken of by Daniel (vii, 3 sq.), and is set forth under the symbol of a lion having eagles' wings. The government was despotic, and the will of the monarch, who bore the title of "king of kings" (Dan. ii, 37), was supreme law, as may be seen in Dan. iii, 12; xiv, 28. The kings lived inaccessible to their subjects in a well-guarded palace, denominated, as with the ancient Persians (Xenoph. *Cyrop.* 1), "the gate of the king" (Dan. ii, 49, compared with Esther ii, 19, 21, and iii, 2). The number of court and state servants was not small; in Dan. vi, 1, Darius is said to have set over the whole kingdom no fewer than "a hundred and twenty princes." The chief officers appear to have been a sort of "mayor of the palace," or prime minister, to which high office Daniel was appointed (Dan. ii, 49), "a master of the eunuchs" (Dan. i, 8), "a captain of the king's guard" (Dan. ii, 14), and "a master of the magicians," or president of the magi (Dan. iv, 9). Distinct, probably, from the foregoing, was the class termed (Dan. iii, 24, 27) "the king's counsellors," who seem to have formed a kind of "privy council," or even "cabinet," for advising the monarch and governing the kingdom. The entire empire was divided into several provinces (Dan. ii, 48; iii, 1), presided

over by officers of various ranks. An enumeration of several kinds may be found in Dan. iii, 2, 3. The head officers, who united in themselves the highest civil and military power, were denominated מְלָכִים, "rulers" (Jer. ii, 23, 28, 57), or מְשֻׁלְתָּיִם, "presidents" (Dan. vi, 2); those who presided over single provinces or districts bore the title of מְשָׁלְתֵי, "governors" (Hagg. i, 1; ii, 2; in Chald. מְשָׁלְתֵי). The administration of criminal justice was rigorous and cruel, will being substituted for law, and human life and human suffering being totally disregarded. Nebuchadnezzar (Dan. ii, 5) declares to the college of the magi: "If ye will not make known unto me the dream, with the interpretation thereof, ye shall be cut in pieces, and your houses shall be made a dung-hill" (see also Dan. iii, 19; vi, 8; Jer. xxix, 22). The religion of the Chaldees was, as with the ancient Arabians and Syrians, the worship of the heavenly bodies; the planets Jupiter, Mercury, and Venus were honored as Bel, Nebo, and Meni, besides Saturn and Mars (Gesenius, *Jesa.* ii, 332 sq.). The language spoken in Babylon was what is designated Chaldee, which is Shemitic in its origin, belonging to the Aramaic branch.—Kitto, s. v. See CHALDEE LANGUAGE.

3. That the *Kaldî* proper, however, were a Cushite race, is proved by the remains of their language, which closely resembles the *Galla* or ancient language of Ethiopia. Now it appears by the inscriptions that while both in Assyria and in later Babylonia the Shemitic type of speech prevailed for civil purposes, the ancient Cushite dialect was retained, as a learned language, for scientific and religious literature. This is no doubt the "learning" and the "tongue" to which reference is made in the book of Daniel (i, 4). It became gradually inaccessible to the great mass of the people, who were Shemitized by means (chiefly) of Assyrian influence. But it was the Chaldean learning, in the old Chaldean or Cushite language. Hence all who studied it, whatever their origin or race, were, on account of their knowledge, termed Chaldeans. In this sense Daniel himself, the "master of the Chaldeans" (Dan. v, 11), would no doubt have been reckoned among them; and so we find Seleucus, a Greek, called a Chaldean by Strabo (xvi, 1, § 6). It may be doubted whether the Chaldeans at any time were all priests, though no doubt priests were required to be Chaldeans. They were really the learned class, who by their acquaintance with the language of science had become its depositaries. They were priests, magicians, or astronomers, as their preference for one or other of those occupations inclined them; and in the last of the three capacities they probably effected discoveries of great importance.

According to Strabo, who well distinguishes (xvi, 1, § 6) between the learned Chaldeans and the mere race descended from the ancient *Kaldî*, which continued to predominate in the country bordering upon Arabia and the Gulf, there were two chief seats of Chaldean learning, Borsippa, and Ur or Orchoë. To these we may add from Pliny (*H. N.* vi, 26) two others, Babylon, and Sippara or Sepharvaim. The Chaldeans (it would appear) congregated into bodies, forming what we may perhaps call universities, and pursuing the studies in which they engaged together. They probably mixed up to some extent astrology with their astronomy, even in the earlier times, but they certainly made great advances in astronomical science, to which their serene sky, transparent atmosphere, and regular horizon specially invited them. The observations, covering a space of 1908 years, which Callisthenes sent to Aristotle from Babylon (*Simplic. ad Arist. de Cel.* ii, p. 123), indicate at once the antiquity of such knowledge in the country, and the care with which it had been preserved by the learned class. In later times they seem certainly to have degenerated into mere fortune-tellers (Cicero, *de Div.* i, 1; Aul. Gell. i, 9; Juv. vi,

552; x, 94, etc.); but this reproach is not justly levelled against the Chaldeans of the empire, and indeed it was but partially deserved so late as the reign of Augustus (see Strabo, xvi, 1, § 6). Josephus, however, uses the word in this sense (*War.* ii, 7, 88).—Smith, s. v.

Upon the walls of the Assyrian palaces are representations of various magi, all distinguished by a peculiarity of dress. It may be difficult to determine the class to which they respectively belong, but there is one (Botta, pl. xliii) who may be particularized as a diviner, and probably of the Chaldean race, for his person is much thinner, and his features are more delicate than are those of the other attendants of the court, indicating a different order of occupations, and an exemption from the ruder and more active employments of life.—Fairbairn, s. v. See DIVINER.



Chaldean Diviner.

Chalice (Lat. *calix*), the cup in which the wine of the Eucharist is administered. At first, when the Christians were poor, the cups were of common materials; but when they grew rich, the cups were of the most costly materials they could afford, such as onyx, sardonyx, silver, and gold. The chalices are of two kinds, the greater, containing a large quantity of wine, and the less, called *ministriales*, because the priests deliver the wine to be drunk out of them.—Bingham, *Orig. Eccles.* bk. viii, ch. vi, § 21; Doughtæus, *de Calic. Euchar. Vet.* (Helmst. 1726); Siegel, *Aurthümer*, i, 61.

Chalk. The Heb. גִּיר, *gir*, thus rendered in Isa. xxvii, 9, properly denotes *lime*. To make the stones of the Hebrew altars like lime-stones is to crumble and destroy them. See LIME.

Challah. See TALMUD.

Challamah. See FLINT.

Challamuth. See PURSLAIN.

Challenge. See SINGLE COMBAT.

Challoner, RICHARD, an English Romanist, was born at Lewes, Sussex, Sept. 29, 1691. His parents were Protestants, but he was led over to Rome by his tutor, Mr. Gother, a Romish chaplain at Warworth, Northamptonshire. In 1704 he went to the English college in the University of Douay, where he was appointed professor of poetry, afterwards of rhetoric, in 1713 of philosophy, and in 1718 of divinity. In 1720 he became vice-president of his college, and ten years afterwards was sent on a mission to England. He now commenced a series of controversial works, among which was a reply to Conyers Middleton's *Letter from Rome*. In 1741 he was made titular bishop of London and Salisbury, and vicar apostolic. He was accused of acting against the anti-papal law of William III, but was acquitted. In 1780 he was again in danger from Lord George Gordon's riots. He died in 1781. See Barrow, *Life of Richard Challoner* (Lond. 1784, 8vo). Among his writings are, 1. *The Catholic Christian instructed in the Sacraments, Sacrifices, and Ceremonies of the Church* (against Middleton's *Conformity between Popery and Paganism*);—2. *Britannia Sancta* (Memoirs of British Saints, 1745, 2 vols. 4to);—3. *A Caveat against Methodism, etc.*—Gorton, *Biog. Dictionary*, s. v.; Allibone, *Dictionary of Authors*, i, 361.

Chalmers, THOMAS, D.D., LL.D., eminent alike

as preacher, philanthropist, and philosopher, was born in Anstruther, in Fifeshire, Scotland, March 17, 1780. He was sent at an early age to the ancient University of St. Andrew's. He devoted himself chiefly to physical science, especially to astronomy, in which he became a proficient. In May, 1803, he was appointed minister of Kilmany, in Fifeshire. During his first years of service there he gave himself more to science than to pastoral duties, and published his first important work, the *Inquiry into the Extent and Stability of National Resources*, in which two points are especially prominent—an intense dislike of the spirit of trade, and a burning military ardor. About 1809 he was engaged to write the article on Christianity for the *Edinburgh Encyclopædia*. In prosecuting the studies necessary for this article, he began to perceive that there was something in Christianity which he had never yet comprehended. The reflections to which a severe illness gave rise completed his "conversion," and on his recovery he began to confess publicly his previous blindness, and to preach Christ crucified. In 1815 he was invited by the town council of Glasgow to take charge of the Tron Church and parish in that city. It was here, perhaps, that the highest triumphs of his eloquence were achieved. In 1823 he was transferred to the chair of moral philosophy in the University of St. Andrew's. The ethical class-room, which had before presented a beggarly account of empty benches, was soon crowded with classes of enthusiastic students. In 1828 he was appointed to the chair of theology in the College of Edinburgh—the summit of ecclesiastical elevation and influence in the National Establishment. In this post he continued to labor until the disruption of the Establishment. See FREE CHURCH OF SCOTLAND. In May, 1843, the pride and power of the ancient Church—four hundred ministers, with Chalmers at their head—departed from her, and organized the first "General Assembly of the Free Church of Scotland," over which he presided. "With the stupendous exertions that were then put forth to erect churches, mansees, school-houses, and colleges; to send missions to Jews and heathen, and to set on foot all the machinery of an efficient Church; with the amazing labors of Chalmers, who travelled over the length and breadth of Scotland, breathing his own burning spirit into every class, while he seemed, like the eagle, to have renewed his youth; and with the wonderful success that crowned these exertions, we cannot be detained without exceeding our limits. Suffice it to say that, in a great measure, by the infusion of his own untiring energy into every class, rank, and age, the stupendous structure of the Free Church went up, like Aladdin's palace, as it were in a single night, and the world stood amazed at the unparalleled spectacle." Chalmers was appointed principal and professor of theology in the Free Church College, in which post he continued till his death. Busied with his professorship, with the preparation of his *Institutes of Theology* and his *Daily Scripture Readings*, he yet found time for varied works of benevolence and philanthropy. On Friday night, May 30, 1847, he retired to his chamber apparently in his ordinary health, and was found dead in his bed next morning.

In analyzing the "intellectual character of Dr. Chalmers we find but two prominent peculiarities. The first is the large development of the perceptive faculties. It was this peculiarity that directed his mind to natural science, and fitted him to excel in those departments that demanded the exercise of the perceptive powers; that determined his thoughts to the details of economics, poor-laws, statistics, etc.; that furnished him with the exuberance of illustration that adorns his discourses, and led him generally to reason by analogy rather than on abstract principles or by metaphysical deductions. The other prominent fact in his intellectual structure was imagination. He did not look at a subject in the cold, dry light of pure

intellection, but in the warm and vivid light of a poetic fancy. The 'body of divinity,' or ethics, which in the hands of other analysts became a skeleton of rattling bones, by his plastic touch was transformed into an image of living, breathing beauty, warm and bright with a glorious life. The abstractions of colder and more logical minds were to him concrete, embodied realities. But when we examine his sermons critically we find much to condemn. There is an utter disregard of all the laws of style and language. The sentences are long, involved, and tangled. The veriest colloquialisms, the most unauthorized idioms, and in some cases even an approach to vulgarisms, appear in his language. Thus, in one of his most magnificent efforts, he tells his hearers that he does not expect by such appeals to break the 'confounded spell' that chained them to the world. The most offensive trait in his style is its endless amplification and repetition" (Moore, *quoted below*).

We cannot assign Chalmers a high rank as an expositor of Scripture. His *Lectures on Romans*, and still more fully his *Posthumous Works*, prove that his excursions into this vast field were but short and narrow in their range.

The *Works of Dr. Chalmers* are published in a uniform edition by T. Constable, Edinburgh (25 vols. 12mo). They are as follows: *Natural Theology*, 2 vols.; *Christian Evidences*, 2 vols.; *Moral Philosophy*, 1 vol.; *Commercial Discourses*, 1 vol.; *Astronomical Discourses*, 1 vol.; *Congregational Sermons*, 3 vols.; *Public Sermons*, 1 vol.; *Tracts and Essays*, 1 vol.; *Essays on Christian Authors*, 1 vol.; *Christian and Economic Polity*, 3 vols.; *Church Establishments*, 1 vol.; *Church Extension*, 1 vol.; *Political Economy*, 2 vols.; *Parochial System*, 1 vol.; *Lectures on Romans*, 4 vols. Besides these, his Posthumous Works contain, *Daily Scripture Readings*, 3 vols.; *Sabbath Scripture Readings*, 2 vols.; *Discourses hitherto unpublished*, 1 vol.; *Lectures on Butler, Hill, etc.* 1 vol.; *Institutes of Christianity*, 1 vol. His *Life and Correspondence*, by the Rev. W. Hanna, D.D. (4 vols. 12mo), is not equal to the reputation of Dr. Chalmers. An abstract of his Theology, by the Rev. J. M. Manning, is given in the *Bibliotheca Sacra*, xiii, 477 sq.—Moore, in the *Methodist Quart. Review*, Oct. 1849; Hanna, *Life of Chalmers* (New York, Harpers, 1850); *N. Brit. Review*, vii, 299; viii, 210; xvii, 110; *Princeton Review*, xiii, 30.

Chalon. See HALL.

Chalons, a town in France, on the Saone, on the site of the ancient *Cabillonum*. See FRANCE.

Several provincial COUNCILS were held here during the Middle Ages, of which the most important was that of A.D. 818, ordered by Charlemagne. It published sixty-six canons, of which the first eleven relate to bishops, and direct that they shall read the holy Scriptures, the councils, and the pastoral of St. Gregory; that they shall preach to their people and edify them, establish schools, etc. The twenty-seventh forbids the repetition of confirmation. The thirty-second declares that spiritual sins must be confessed, as well as bodily sins. The thirty-sixth declares that almsgiving avails only to release from venial sins, arising from frailty, and reproves those who go on in sin, thinking to escape punishment for their much almsgiving. The forty-ninth orders prayers for the dead to be said at every mass, and declares it to be an ancient custom in the Church to commend to the Lord the spirits of those asleep. The forty-third declares the ordination of certain priests and deacons conferred by certain Scotch bishops to be null and void, being done without the consent of their diocesans, and with suspicion of simony. The forty-fifth condemns pilgrimages made in order to obtain remission of sins, which, on that pretext, the persons about to make the pilgrimage go on committing more freely; pilgrimages made from proper devotional motives are com-

mended. The forty-seventh orders all Christians to receive the holy Eucharist on Maunday Thursday.—Labbe and Cossart, *Concil.* t. vii, p. 1270; Landon, *Manual of Councils*, s. v.

Chaluza. See **CHELLUS**.

Chamber (the translation of various Heb. words). Oriental houses have in general a court in the centre, with cloisters and a gallery, into which the chambers open, the apartments of the women being at the back, and only to be approached by passing through the others. Toward the street is a dead wall, with a porch, over which is a chamber, sometimes used as a lodging for guests, and sometimes as a store-room, it being well suited for either of these purposes, by being connected with the rest of the house by a door in the gallery, and having a separate staircase opening into the porch. This is the "chamber on the wall" (עֲלֵית־חַיִּים).

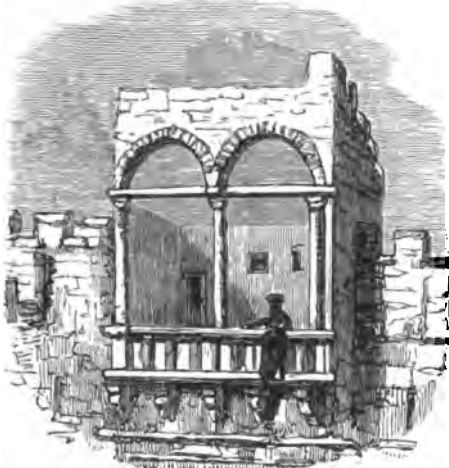

Modern Oriental "Chamber on the Wall."

wall-loft, Sept. ὑπέρσπον) which the Shunamites prepared for the prophet Elisha (2 Kings iv, 10). Such an "upper chamber" (ὑπέρσπον) is still the guest-chamber where entertainments are made, which was the custom with the Greeks as well as the Jews (Matt. ix, 14; Mark xiv, 14). Among the former it occupied the upper story; among the Hebrews it seems to have been open, or connected with, the flat roof of their dwellings (comp. Acts xx, 8). These upper chambers were also sometimes used for the performance of idolatrous rites (2 Kings xxiii, 12), and in them the bodies of the dead were laid out (Acts ix, 37). The early Christians, too, held their meetings for worship in such places. Besides these, there were inner chambers, or a "chamber within a chamber" (1 Kings xxii, 25), such as that into which the messenger of Elisha retired to anoint Jehu (2 Kings ix, 2). See **HOUSE**.

The term *chamber* is used metaphorically in many places of the Scriptures, as Psa. civ, 8, 13; Prov. vii, 27. To apply ourselves to earnest prayer and supplication, and to depend on the promises and providence of God for special protection, is to enter into our chambers, that we may be safe, as the Hebrews were in their houses, from the destroying angel (Isa. xxvi, 20). See **BED-CHAMBER**.

The "chambers of the south" (Job ix, 9) are the constellations, or clusters of stars, belonging to the southern part of the firmament. See **ASTRONOMY**.

The term "Chambers of Imagery" (חַדְרֵי מַטְבִּיחַיִּים, *figure-apartments*; Sept. κοῦῶν εἰκαστικός) is used by the prophet Ezekiel (viii, 12) to denote the vision which he had of the abominations practiced by the Jews in the distant Jerusalem. As the practices there denounced were evidently borrowed from their Chal-

dæan oppressors, they derive striking elucidation from the gorgeous halls of the Assyrian palaces lately brought to light by Layard, with their long lines of sculptured animals, and kings worshipping before them (*Nineveh*, ii, 209). See **IMAGERY**.

"Chambering" (κοῖται) signifies in Rom. xiv, 13, that lewd association with courtesans and similar characters that was a peculiar feature of the heathenism of that age. See **HARLOT**.

Chamberlain (סַרִּיס, *saris*, 2 Kings xxiii, 18; Esth. i, 10, 12, 14; ii, 8, 14, 15, 21; iv, 4, 5; vi, 2, 14; Sept. regularly ὑπόδοχος, twice ἀνάδωξ, all signifying *castrated*; in other places it is translated "eunuch," or "officer"). The term appears to have been applied to officers confidentially employed about the person of the sovereign; thus Potiphar, who was also captain of the guard, in the Egyptian court, is styled thus (Gen. xxxvii, 36; xxxix, 1). It probably also occurs in the title *Balsaris* (q. v.). The title "chamberlain" (οἰκονόμος), in Rom. xvi, 23, probably denotes the steward or treasurer of the city, called by the Romans the *questor*. The Vulg. renders it by *arcarius*, which was the title of a class of inferior magistrates, who had the charge of the public chest (*arca publica*), and were under the authority of the senate. They kept the accounts of the public revenues. (See Reinesius, *Synagm. Inscr.* p. 431; La Cérda, *Advors. Sacr.* cap. 56; Elsner, *Obs. Sacr.* ii, p. 68; and a note by Reinesius to the *Marmorata Ozoniensis*, p. 515, ed. 1732.) Blastus is said in Acts xii, 20, to have been "the king's (Herod's) chamberlain" (ὁ ἐπι τοῦ κοιτῶνος τοῦ βασιλέως), by which is probably meant his personal attendant or *valet de chambre*. It was a post of honor, which involved great intimacy and influence with the king. The margin of our version gives "that was over the king's bedchamber," the office thus corresponding to that of the *prefectus cubiculo* (Suetonius, *Dom.* 16). See **EUNUCH**.

Chamberlain, Jeremiah, D.D., a Presbyterian minister, was born in York Co., Pa., Jan. 5, 1794, graduated at Dickinson College in 1814, and studied theology at Princeton. He was licensed in 1817, when he became a missionary to the West and South, visiting Natchez, New Orleans, and Mobile. In 1818 he supplied the Bedford church, Pa., and in 1822-23 removed to Danville, Ky., to the Presidency of Centre College. In 1824 he became President in a State institution at Jackson, La., but resigned in 1828, and opened an academy. In 1830 he was made President of Oakland College, Claiborne Co., Miss., the establishment of which was the result of his own enterprise. He was stabbed to the heart (Sept. 5th, 1850) by a student, who afterward committed suicide. He published *A Sermon on the Sanctity and Perpetuity of the Sabbath*, 1831. Some of his *Addresses and Letters* were published in the current newspapers.—Sprague, *Annals*, iv, 590.

Chamberlain, Schuyler, a minister of the Methodist Episcopal Church, was born in Woodstock, Conn., Sept. 4th, 1800. In 1818 he joined the first Methodist class formed in Craftsbury, Vt. He was received into the New England Conference in 1823, and during his itinerant career filled a number of important appointments, including the presiding eldership. He died at Craftsbury, May 5, 1862. He possessed superior abilities as a preacher; his style was easy, impressive, and attractive, and there was great clearness and definiteness in his sermons. He was elected three times a delegate to the General Conference. He also represented the town of Craftsbury in the State Legislature three terms.—*Minutes of Conferences*, 1863, p. 104.

Chameleon, a reptile belonging to the *saurian* or lizard-like order. In the original of Lev. xi, 30, occur the words *ko'ach* (כֹּחַ), so called apparently on account of its great strength) and *tinsh' meth* (תִּנְשֵׁת־מֵת), the

first of which, in our version, is rendered "chameleon" (after the Sept. and Vulg. *χαμαιλιων*, *chameleon*), and the second "mole;" but Bochart and others consider both words as relating to animals of the *saurian* or lizard tribe, and that which our translators have termed the mole is, in reality, the chameleon (*Chamaleo vulgaris*), while the chameleon of our version is some other and larger creature of the same order, perhaps a species of the land crocodile. See MOLE. "The chameleon is a small species of lizard, celebrated for the faculty it has of changing the color of its skin. This property, however, has no reference to the substance it may be placed on, as generally asserted, but is solely derived from the bulk of its respiratory organs acting upon its transparent skin and on the blood of the animal. The chameleons form a small genus of *saurians*, easily distinguished by the shagreened character of the skin, and the five toes on the feet, divided differently from those of most other animals, there being, if the expression may be allowed, two thumbs opposed to three fingers. Their eyes are telescopic, move separately, and can be directed backward or forward. Chameleons are slow, inoffensive, and capable of considerable abstinence from food, which consists solely of flies, caught by a rapid protrusion of a long



Chamaleo Africanus.

and viscous tongue. Among themselves they are irascible, and are then liable to change their colors rapidly; dark yellow or gray is predominant when they are in a quiescent state, but, while the emotions are in activity, it passes into green, purple, and even ashy black. The species found in Palestine and all Northern Africa is the common 'African chameleon,' and probably is that referred to in Lev. xi, 30, where unclean animals are mentioned" (Kitto, s. v.). (See *Penny Cyclopædia*, s. v.). See LIZARD.

Chamier, DANIEL, a French Protestant divine, was born in 1565; studied at Orange; and at 16 became one of the professors of the college at Nismes. In 1583 he went to study at Geneva, where he was ordained. On his return he was made pastor of Vans, and afterward of Aubenas, and some time after succeeded his father, Adrian Chamier, as pastor of Montélimar. In 1596 he was sent by the province to the National Synod of Saumur, and several times afterwards to the Assemblies of Laudun, Vendôme, Saumur, and Châtellerault. He gained great credit by his firmness in the negotiations relating to the Edict of Nantes. In 1600 he distinguished himself in a controversy with Father Coton at Nismes, and the next year with the Jesuit Gaultier. In 1601 he became a delegate to the National Synod of Gergeau, and, together with Maraval, went as a deputation to the king to ask for the continuation of the Saumur Assembly; this was refused, but the convocation of an assembly at Sainte Foix was granted, and of this he also became a member, as well as of several succeeding assemblies. Made pastor of Montauban, he also applied himself to the restoration of its college, and continued his labors as preacher and professor until he was killed by a cannon-ball at the siege of that city on Oct. 21, 1621. His principal works are: *Dispute de la vocation des ministres en l'Eglise Reformée* (La Rochelle, 1598, 8vo); *Epistolas Jesuicas* (Gen. 1599, 8vo); *Confusion des disputes papistes* (Gen. 1600, 8vo); *Disputatio scholastico-theologica de œcumenico pontifice*

(Gen. 1601, 8vo); *La honte de Babylon* (pt. i, 1612, 8vo); *Panstratia catholica sive controversiarum de religione adv. pontificis corpus* (Gen. 1626, 4 vols. fol.; 2d ed. Frankf. ad M. 1627, 4 vols. fol.); *Corpus theologicum, sive Loci communes* (Gen. 1613, fol.). See *Memoir of Chamier* (Lond. 1852, 8vo).—Haag, *La France protestante*, iii, 817; Bayle, *Dictionary*, s. v.

Chamois, the rendering in the Auth. Vers. at Deut. xix, 5, of the Heb. צמיר, *ze'mer* (so called from leaping; Sept. and Vulg. understand the giraffe, *καμηλοπάρδαλις*, *camelopardalis*; Luther "elend" or elk). The enumeration there requires us to understand *ze'mer* to be a clean ruminant; but it is plain that the Mosaic list of clean animals would not include such as were totally out of the reach of the Hebrew people, and at best only known to them from specimens seen in Egypt, consisting of presents sent from Nubia, or in pictures on the walls of temples. The camelopard is exclusively an inhabitant of Southern Africa (comp. Strabo. xvi, 771; xvii, 827; Pliny, viii, 27), and therefore could not come in the way of the people of Israel (see Michaelis, *Suppl.* iii, 628). The same objection applies to the elk, because that species of deer never appears further south than Northern Germany and Poland (Cuvier, *Anim. Kingd.* i, 876 sq.). As to the chamois (Gesenius, *Thes.* i, 420), though it did exist in the mountains of Greece, and is still found in Central Asia, there is no vestige of its having at any time frequented Libanus or any other part of Syria. *Zammer* is still used in Persia and India for any large species of ruminants, particularly those of the stag kind. In the sacred text, however, the word *ze'mer* is not generic, but strictly specific. *Ail*, or "stag," is mentioned, as well as several Antilopidæ, in the same verse; we must, therefore, look for an animal not hitherto noticed, and withal sufficiently important to merit being named in such an ordinance. See DEER; GOAT; GAZELLE, etc.

The only species that seems to answer the conditions required is a wild sheep, still not uncommon in the Mokattam rocks near Cairo, found in Sinai, and eastward in the broken ridges of Stony Arabia, where it is known under the name of *kebsch*, a slight mutation of the old Hebrew קֶשֶׁב, *kesch*, or, rather, קֶבֶשׁ, *kebes*, which is applied, indeed, to a domestic sheep, one that grazed. This animal is frequently represented and hieroglyphically named on Egyptian monuments (Wilkinson, *Anc. Eg.* iii, 19). It is a fearless



Ovis Tragelaphus.

climber, and secure on its feet, among the sharpest and most elevated ridges. In stature the animal exceeds a large domestic sheep, though it is not more bulky of body. Instead of wool, it is covered with

close, fine, rufous hair: from the throat to the breast, and on the upper arms above the knees, there is abundance of long, loose, reddish hair, forming a compact protection to the knees and brisket, and indicating that the habits of the species require extraordinary defence while sporting among the most rugged cliffs (see Bochart, *Hieroz.* ii, 278 sq.; Rosenmüller, *Allerth.* IV, ii, 186 sq.). The head and face are perfectly ovine, the eyes are bluish, and the horns, of a yellowish color, are set on as in sheep; they rise obliquely, and are directed backward and outward, with the points bending downward. The tail, about nine inches long, is heavy and round.—Kitto, s. v. See ANTELOPE.

Chamor. See ASS.

Champaign (צַרְבַּח, *arabak'*, desert), an open or uninhabited district (Deut. xi, 80). See ARABAH.

Champeaux. See WILLIAM OF CHAMPEAUX.

Champion (גִּבּוֹר, *gibbor'*, 1 Sam. xvii, 51; elsewhere "mighty man"). The Heb. phrase חַיִּיבֵנִים יִמ, *ish hab-bena'yim*, rendered "champion" in 1 Sam. xvii, 4, 23, literally signifies a man between the two, that is, a go-between, an arbiter, or one who offers a challenge, and appropriately denotes the position of Goliath when he stood up between the Hebrew and Philistine armies. Single combats at the head of armies were not unusual in ancient times, and in many cases it was a condition that the result should determine the national quarrel. An example of this kind is the combat between Paris and Menelaus, described by Homer. A similar practice obtains in the present day among the Bedouin Arabs. See SINGLE COMBAT.

Cha'naän (Χαναάν), a mode of Anglicizing, or, rather, Græcizing the name CANAAN in the A. V. of the Apocrypha and N. T. (Judith v, 8, 9, 10; Bar. iii, 22; Sus. 56; 1 Macc. ix, 87; Acts vii, 11; xiii, 19).

Cha'naänite (Χαναανίτης), another form for CANAANITE (Judith v, 16).

Chanamal. See FROST.

Chancel (Lat. *cancelli*, from *cancer*, a lattice), in modern usage, part of a church set off from the rest by a railing. See CANCELLUS. Modern French writers use the word *cancel* in its original sense of a lattice or screen, as they apply it to the screen (*transenna*) which separates the choir or side chapels from the nave or main body of the church. In English Protestant churches the term *chancel* is applied mostly to that part of the smaller churches cut off from the nave by the *cancel*, or, rather, the railing where formerly the *cancel* stood. The original term choir (q. v.) is retained in the larger churches and cathedrals. The *chancel* is reserved for the use of the clergy in the administration of their offices during divine service. In the German churches the term "*kanzel*" is applied to the pulpit, which projects from the side of a gallery, that all in the church may easily hear.

"By the rubric of the Church of England before the Common Prayer, it is ordained that" the chancels shall remain as they have done in times past, "that is to say, distinguished from the body of the church in manner aforesaid; against which distinction Bucer and bishop Hooper (at the time of the Reformation) inveighed vehemently, as tending only to magnify the priesthood; but though the king and the Parliament yielded so far as to allow the daily service to be read in the body of the church, if the ordinary thought fit, yet they would not suffer the *chancel* to be taken away or altered." See Bingham, *Orig. Eccl.* bk. viii, ch. iii; Hook, *Church Dictionary*, s. v.; Guericke, *Manual of Antiquities*, p. 104 (Engl. transl.).

Chancellor (חַנְצְלָרִים, *beal'-teem'*; Sept. Βασιλεύς and Βασιλῆς). The original word signifies a commander, or lord of the edicts or causes; it was the Chaldee title of the Persian governor at Samaria, but is rendered in our version "chancellor" (Ezra iv, 8, 9, 17).

CHANCELLOR (*Cancellarius*), a lay officer who is judge in a bishop's court, under his authority. "In ancient times bishops had jurisdiction in particular causes, as in marriages, adultery, last wills, etc., which were determined by them in their consistory courts. But when many controversies arose in these and other causes, it was not consistent with the character of a bishop to interpose in every litigious matter, and it became necessary for the bishop to depute some subordinate officer, experienced both in the civil and canon law, to determine those ecclesiastical causes, and this was the original of diocesan chancellors. Henry II of England, requiring the attendance of bishops in his state councils, and other public affairs, it was thought necessary to substitute chancellors in their room, to dispatch those causes which were proper to the bishop's jurisdiction. In a few years a chancellor became such a necessary officer to the bishop that he was not to be without him; for if he would have none, the archbishop of the province might enjoin him to depute one, and if he refused, the archbishop might appoint one himself. The person thus deputed by the bishop has his authority from the law, and his jurisdiction is not, like that of a *commissary*, limited to a certain place and certain causes, but extends throughout the whole diocese, and to all ecclesiastical matters; not only for reformation of manners, in punishment of criminals, but in all causes concerning marriages, last wills, administrations, etc." (Hook, *Church Dictionary*, s. v.). In England the chancellor presides in the bishop's court, and is called his *vicar-general*, as being clothed with the bishop's authority. In Ireland the chancellor has no ecclesiastical jurisdiction, all matters pertaining to his office being executed by a distinct officer, called the *vicar-general*.—Bingham, *Orig. Eccles.* bk. ii, ch. vii, § 5; Marsden, *Churches and Sects*, 331.

Chandler, Edward, D.D., bishop of Durham, was born in Dublin about 1650. He received his education at Emanuel College, Cambridge, where he took his degree of M.A., and in 1693 he became chaplain to bishop Lloyd, of Lichfield (afterwards of Worcester), who gave him preferment in both those cathedrals. In 1717 Dr. Chandler was nominated to the see of Lichfield, from whence, in 1730, he was translated to Durham. He died in London July 20th, 1750. Among his writings are *A Defence of Christianity from the Prophecies of the O. T.*, in reply to Anthony Collins (London, 1725, 8vo), a work which compelled Collins to produce, in 1727, his *The Scheme of Literal Prophecy considered*, which occasioned a second answer from the bishop, entitled *A Vindication of the Defence of Christianity, from the Prophecies of the O. T.* (London, 1728). He also wrote *Eight Occasional Sermons*; the *Chronological Dissertation* prefixed to Arndt's *Ecclesiasticus*; and a preface to Cudworth's *Immutable Morality*.—Rose, *New Biographical Dictionary*, vi, 200; Hook, *Eccl. Biography*, iii, 550.

Chandler, Samuel, D.D., an eminent dissenting minister, was born at Malmesbury in 1693, and completed his studies at Leyden. In 1716 he was chosen minister to a congregation at Peckham, and during his stay there was also a bookseller. In 1718 he was chosen lecturer at the Old Jewry, and, about 1726, pastor at the latter place; this last office he held forty years. In 1748 the universities of Edinburgh and Glasgow gave him the degree of D.D. He died May 8, 1766. Among his numerous works are, *Sermons published from M.S.* (London, 1768, 4 vols. 8vo); *A Critical History of David* (London, 1766, 2 vols. 8vo); *A Vindication of the Christian Religion* (London, 1728, 8vo); *The History of Persecution* (London, 1786, 8vo); *Vindication of the Authority of Daniel's Prophecies* (London, 1728, 8vo); *Paraphrase and Notes on Galatians and Ephesians* (London, 1779, 4to); *Paraphrase and Commentary on Joel* (London, 1735, 4to). His apologetical writings are still of value. In theology he was a semi-Arian.

—*Biographia Britannica*, iii, 480; *Allibone's Dictionary of Authors*, i, 866; *Rose, New Biog. Dict.* vi, 201.

Chandler, Thomas Bradbury, D.D., a Protestant Episcopal minister, was born in Woodstock on the 26th of April, 1726, and graduated at Yale College in 1745. On his return from England in 1751, he entered upon the duties of a mission at Elizabethtown and Woodbridge, N. J. In the winter of 1768–4 Whitefield visited Elizabethtown, and Mr. Chandler refused him his pulpit on the ground of "the rules of our ecclesiastical policy." In 1766 he was made D.D. by the University of Oxford. In 1767 a controversy arose between him and Dr. Chauncy, of Boston, on the subject of episcopacy, and the pamphlets on both sides showed great ability. The Revolution did not enlist the sympathies of Dr. Chandler, and he retired to England, where he remained till 1785, when he returned to Elizabeth, having previously declined the appointment of bishop of Nova Scotia. He died at Elizabeth, June 17th, 1790. —*Sprague, Annals*, v, 137.

Chandler, William Penn, one of the most eminent Methodist preachers of his time, was born in Charles Co., Maryland, June 22d, 1764. He entered the Philadelphia Conference in 1797, and filled in succession the most important stations in the Church. He took a superannuated relation in 1811, and located in 1813, returning to the Conference, however, in 1822, the year in which he died. As a Christian and a minister, Mr. Chandler was a man of no ordinary mark; in the pulpit, the divine unction that rested upon him, and the evangelical energy of his sermons, gave eminent success to his labors (*Minutes of Conferences*, i, 402). Boehm styles him "one of the most powerful ministers that ever wielded the sword of the Spirit." In May, 1820, he had a paralytic stroke. He visited the West Indies in hope of benefit, but returned no better, and died in Philadelphia, Dec. 8th, 1822. —*Stevens, Hist. of the M. E. Church*, iii, 409–413; *Sprague, Annals*, vii, 287; *Boehm, Reminiscences of Methodism*, chap. xv; *Ware, Autobiography*.

Change of Raiment. See GARMENT.

Changer of Money, or MONEY-CHANGER (εραμιστής, John ii, 14; κολλυβιστής, Matt. xxi, 12; Mark xi, 15; John ii, 15). When Judæa became a province of Rome, the Jews were required to pay taxes in Roman currency, and at the same time the annual tribute for the service of the sanctuary was the half shekel of Jewish currency. See TAX. To exchange these, one for the other, was the business of the money-changers, like the business of modern brokers. To obtain custom, they stationed themselves in the outer courts of the Temple, the places of general resort for strangers from every part of Judæa, and their oppressive and fraudulent practices probably justified the allusion of our Saviour to "a den of thieves." Perhaps they were also (like the *ραμνίζῆται*, "exchangers") accustomed to pay and receive interest on loans, and this practice is recognised in Matt. xxi, 12; xxv, 16, 27; John ii, 14. At the present day, in Oriental cities, money-changers are found in the most public places, sitting at little tables covered with coins. See MONEY.

Channel, the rendering in the Auth. Vers. in certain passages of two Heb. words: *פְּנֵן*, *aphik'*, the bed of a brook (2 Sam. xxii, 16; Psa. xviii, 15; Isa. viii, 7; elsewhere "stream," "river," etc.); and *שִׁבּוֹ'לֵת*, *shibbo'leth*, a stream (Isa. xxvii, 12; "flood," Psa. lxi, 2, 15).

Channing, WILLIAM ELLERY, D.D., an eminent Unitarian divine and philanthropist, was born at Newport, Rhode Island, April 7th, 1780; entered Harvard University in his 14th year; graduated at the age of 18; spent a part of the ensuing two years as a private tutor in Richmond, Va.; returned to Cambridge as regent (a subordinate office) in 1801; was settled as pas-

tor of Federal Street Church, Boston, in June, 1803; visited Europe in 1822; began his celebrated essays on Milton, Napoleon, and Fénelon, which distinguish the commencement of his literary career, proper, in 1826; visited the West Indies in 1830; commenced his anti-slavery labors in 1835; and died Oct. 2, 1842.

To the American community in general Channing is chiefly known as a theologian, while on the other side of the Atlantic his fame is chiefly that of a literary man and a philanthropist. The common impression that he was the leader of the Unitarian movement in this country is false. By the publication of his celebrated sermon at the ordination of Mr. Sparks, in Baltimore, in 1819, the doctrinal position of Unitarianism was more generally made known in the American community than at any former date. By this accident, and still more, perhaps, by the fact that his literary reputation elevated him above all others engaged in the movement, he became recognised as its head, although it could boast of earlier advocates and abler polemics. He is perhaps rather to be classed with Samuel Clarke and Locke, as a high Arian, than with Priestley, Belaham, and the Socinians generally. He is described by his biographers "as a member of the Church Universal of the lovers of God and lovers of Man." But he himself says that "he had long ceased to attach any importance to the rank or dignity of Christ, or to believe in the Trinity; that the idea of Christ's death being a satisfaction is nowhere taught in Scripture; and that evil spirits have no existence, Satan being merely a figurative personation of moral evil." Still, according to his peculiar views of religious faith and duty, Dr. Channing was a devout and serious man, who had a profound reverence for the authority of Scripture, and was accustomed habitually to view all things in connection with eternity.

With Unitarianism as a system or movement, he unquestionably did not feel satisfied in his later years. In 1837 he wrote as follows: "I feel that among liberal Christians the preaching has been too vague, has wanted unity, has scattered attention too much." In 1839 he thus expresses himself: "I would that I could look to Unitarianism with more hope. But this system was, at its recent revival, a protest of the understanding against absurd dogmas, rather than the work of deep religious principle, and was early paralyzed by the mixture of a material philosophy, and fell too much into the hands of scholars and political reformers; and the consequence is a want of vitality and force, which gives us but little hope of its accomplishing much under its present auspices or in its present form."

As a preacher Channing was pre-eminent, though he had very few natural oratorical qualities. His presence in the pulpit was not commanding; he was small in stature, exceedingly emaciated, and enveloped in a superabundance of clothing; his cheeks were sunken, his eye hollow, and his voice feeble, though remarkably flexible. He generally read his discourses. Throughout his long ministry he was the most popular preacher in Boston. In philanthropic enterprise he was the Chalmers of America. His journals contain "long lists" of plans "for public works, benevolent operations, special reforms." These plans include, "Associations among Mechanics," a "Work to be written on ardent Spirits," "Fire Clubs," "Poor-houses," "Female Employment Societies," "Provisions of Wood on a large Scale," "Bake-houses for the Poor," "Associations for the Relief of the Sick, Old, Debtors," "Societies for the Advice of Emigrants, for the Reformation of Prostitutes, the Improvement of Africans," etc. His liberality was not absorbed in devising plans of good, but his personal charities were great. His latest and matured strength was devoted to the discussion of American slavery, and no writer has treated the subject with more candor or more impressive eloquence. His literary reputation, especially in England, was scarcely paralleled by that of any other

American author of his time. He possessed the best elements of immediate success as a writer—a poetic temperament, and a style of remarkable transparency and power. The greatest faults of his style are repetition and expansion, the fine gold being often beaten out into very thin leaf. Channing's works were reviewed by Macaulay in the *Edinburgh Review* (vol. lxix, p. 214), and a graphic sketch of him is given by Stevens in the *Methodist Quarterly Review* (Jan. 1849, art. iv), from which the present article is condensed. His *Works* have been published in Boston in 6 vols. 12mo (reprinted in England). Many of them have been translated into German (Berlin, 1850-55), also into French, with an Essay on his Life and Writings, by Laboulaye.—*Memoirs and Correspondence of Channing* (Bost. 1848, 8 vols. 12mo); Ware, *American Unitarian Biography*, ii, 139; Sprague, *Unitar. Pulpit*, 360 sq.; *British Quarterly*, Nov. 1848, art. 1; *Literary and Theological Review*, i, 304; *N. American Review*, xli, 866; *Democratic Review* (Bancroft), xii, 524; *Westminster Review* (J. Martineau), i, 817; *Edinburgh Review*, lxi, 214; Allibone, *Dict. of Authors*, i, 367.

Channunæus (*Xavouναῖος*), given (1 Esdr. viii, 48) as a person, several of whose "sons" (there named) were among the priests or Levites secured by Ezra to accompany his party to Jerusalem; corresponding apparently to **MERARI** of the Heb. text (Ezra viii, 19).

Chant (*קָרַט*, *parat'*, to chatter, spoken contemptuously; Sept. *ἰκκαριῶ*) occurs only in Amos vi, 5, where the passage, "That chant to the sound of the viol," may be rendered, "That sing to the sound of the harp." The Chaldee, Syriac, and Vulgate read, "who sing to the sound of the psalter;" and the margin of our version gives "quaver." Josephus informs us that the instrument here termed *nebel* was of a triangular shape, and carried in the hand. In the paintings on the monuments at Thebes we find players on the harp in the act of singing to the sound of their own music. (See the cut below.) Similar scenes are depicted on the Assyrian monuments. See **MUSIC**. Both among the Jews and the Egyptians musical instruments were chiefly played upon by women: the Psalmist, describing a musical procession, says, "The singers went before, the players on instruments followed after; among them were the damsels playing with timbrels" (Psa. lxxviii, 25). See **HARP**.

CHANT (*cantus*, a song), the word employed in the early Church to designate the vocal music of the congregation. The term was applied, later, to special tunes adapted to prose; e. g. the *Ambrosian*, established by St. Ambrose, and the *Gregorian*, introduced by Pope Gregory the Great, who established schools of chanters, and corrected the Church music. This, at first, was called the *Roman song*; afterwards the *plain song*, as the choir and people sing in unison. In modern liturgical worship, the word designates the musical

(*sing*), an ecclesiastical benefice or endowment to provide for the chanting of masses for the repose of the souls of the founders. Money was often left also for the building of a chapel in which the masses were to be chanted, and hence the term was applied also to such chapels. They were sometimes built in or near a church, but more usually were attached to an abbey or monastery, and were frequently very richly decorated.

Chanuca. See **DEDICATION (FEAST OF)**.

Chaos, a term taken from the Greek mythology, according to which Chaos was the first existence and the origin of all subsequent forms of being (Hesiod, *Theogon.* 116; Ovid, *Metamorph.* i, 5). The word itself (in Gr. *χάος*, immeasurable space) signifies the vast void, or the confused mass of elements from which it was supposed by the ancient philosophers that the world was formed. It has been employed in later times to denote the unformed mass of primeval matter described by the sacred historian in Gen. i, 2, corresponding to the Heb. words *תוהו*, *to'hu*, and *בוהו*, *bo'hu*, a waste void, a desert, a waste solitude, rendered in the Sept. *ἀόρατος* kai *ἀταραξίαστος*, invisible and without order. These two words, combined for the sake of the paronomasia into the phrase *תוהו ובוהו*, in which the repetition of similar terms is a Hebrew method of designating intensity or superlativeness, signify simply utter desolation.

The description which Ovid (l. c.) gives of Chaos itself, and of the formation of the world from the chaotic mass, is very remarkable. The following is a literal version:

Ere sea, or land, or sky, that covers all,
Existed, over all of nature's round
One face there was, which men have Chaos named—
A rude, unfathomed mass, with naught save weight;
And here were heaped the jarring elements
Of ill-connected things. No sun as yet
His rays afforded to the world; the moon
Filled not afresh her horns by monthly growth;
Nor hung the globe in circumbient air,
Poised by its balanced weight; nor had the sea
Reached forth its arms along the distant shore.
Where'er was earth, there also sea and air;
No land to stand upon, no wave to swim,
And rayless air. Nothing preserved its form:
Each thing opposed the rest; since in one frame
The cold with hot things fought, the moist with dry,
The soft with hard, and light with heavy things.
This strife the God and kindly Nature quelled,
By cleaving sky from land, and land from sea,
And parting liquid sky from thicker air.
These thus evolved and from the blind mass drawn,
Disjoined in space, were tied in friendly peace:
The fiery force of heaven's weightless arch
Leaped forth, and chose the topmost point its seat;
The air comes next in gravity and place;
The denser earth drags down the bulky parts,
Crushed with its weight; the water, flowing round,
The outskirts held, and bound the orb entire.

"This statement bears so many striking resemblances to the Mosaic account of the creation that one can scarcely fail to regard it as having been derived by tradition from the same source. There is, however, this great difference between the scriptural and the heathen cosmogonies — that the former sets out with the emphatic declaration that the unformed mass was the creation of God; while the latter speaks of it as the already existing materials out of which he formed the world, or even as itself the cause and author of all things. Most interpreters, who have been ignorant of geological phenomena, have at once decided that the chaos of which Moses speaks was the form in which



Ancient Egyptians (men and women) singing to the Harp, Lyre, and double Pipe.

performance of all those parts of a prose liturgy which are permitted to be sung or recited in a musical tone. In a wider sense, it is used to denote those forms of sacred music in which prose (e. g. passages of Scripture) is sung in simple harmonies. See **MUSIC**.

Chantry (old French *chanterie*, from *chanter*, to

matter was first created. Some have even declared that there cannot have been any such interval as we have spoken of (Prof. Stuart, in *Bib. Repos.* No. xxi, Jan. 1836). But, on the other hand, the world gives intimations, in the rocks which compose its crust, of various and long-continued changes both of condition and of inhabitants. Hence we conclude: (1) that the world has existed during some long period *before* the Mosaic record of creation in six days; (2) that during that period it was the abode of animals differing in organization and structure from those now found on its surface; and (3) that it has been exposed to various convulsions and reorganizations, more or less general. A favorite mode of explaining the Mosaic account, a few years back, was to take the six days of creation for unlimited periods, during which the changes we are speaking of took place. This ground has, however, been almost completely abandoned, both because the account, so understood, does not agree with the physical phenomena, and because such an interpretation is, to say the least, hardly admissible on exegetical principles. The first sentence of the inspired record may therefore be regarded as the majestic declaration of a fact, which the world had lost sight of, but which it deeply concerned men to know. What occurred subsequently, until the earth was to be furnished for the abode of man, is to be gathered, not from the written word, but from the memorials engraven on the tablets of the world itself. The succeeding verse of the Mosaic account then relates to a state of chaos, or confusion, into which the world was thrown immediately before the last reorganization of it. Nor is such a chaos opposed to geological phenomena, which plainly tell of 'critical periods' and of 'revolutions of organic life' (Phillips's *Geology*, in *Cab. Cyclop.* ii, 264). Whether the chaos of which we are now speaking was universal, or was confined to those regions which formed the cradle of the human race, is a distinct question. The latter supposition has been adopted by Dr. Pye Smith, in his lectures *On the Relation between the holy Scriptures and some Parts of Geological Science*. To these lectures, as well as to the articles by Prof. Hitchcock, in the *Biblical Repository* (Nos. 17, 18, 20, and 22), and to various papers which have appeared at different times in the *Christian Observer*, the reader is referred for a fuller discussion of this and kindred questions" (Kitto, *Cyclop.* s. v.). The difficulty advanced by some that geology (q. v.) gives no intimation of any such total break in the chain of organized beings as is implied in a chaotic condition of the globe just prior to man's introduction upon it, is hardly consistent with truth; for although the rocky tablets of the earth's crust do indeed exhibit a continued series of organized life, yet they also record great changes of species, and even wholesale demolitions of imperfect orders, not now extant, while they contain few, if any, specimens identifiable with those that inhabit the present surface of our planet. See also Hitchcock's *Religions of Geology* (Boston, 1856). See CREATION.

Chapel (מִקְדָּשׁ, *mikdash'*, holy place), a general name for a *sanctuary* (as it is elsewhere rendered) or place of worship, occurs in Amos vii, 13, where Bethel is called "the king's chapel" by one of the idol priests, because there the kings of Israel paid idolatrous worship to the golden calves. In 1 Macc. i, 47, the Greek word is εἰδωλείον, and in 2 Macc. x, 2; xi, 8, τέμενος; both used in a similar sense.

Chapel (Lat. *capella*, a little cloak or hood). The kings of France are said to have preserved a piece of the cloak of St. Martin in a little church, and to have taken it with them to the field of battle. The tent or church containing this *capella* hence received its name. The term was afterward applied to all small churches, and especially to the side rooms or chapels added to the side aisles of a church, and which were separately dedicated, usually to the service of some saint. Before

the Reformation nearly all castles, manor-houses, court-houses, and religious or charitable establishments had such chapels. These had not the right of sepulture, nor of sacramental services.

The term *chapel* was also sometimes applied to the sets of vessels or the vestments necessary for the celebration of the church services. It is also sometimes applied to a choir of singers; also to a printer's work-house, or a body of printers, because printing in England was first carried on in a chapel of Westminster Abbey.

In England the word is now used to denote, 1. Domestic chapels, built by noblemen for private worship in their families; 2. College chapels, attached to colleges; 3. Chapels of ease, built for the use of parishioners who live at too great a distance from the parish church; 4. Parochial chapels, which differ from chapels of ease on account of their having a permanent minister or incumbent, though they are in some degree dependent upon the mother church; 5. Free chapels, such as were founded by kings of England, and made exempt from episcopal jurisdiction; 6. Chapels which adjoin to any part of the church; such were formerly built by persons of consideration as burial-places. In the great Roman cathedrals and churches of Europe side-chapels are commonly fitted up for prayer, with an altar and the other necessary appendages.

The Methodists and Dissenters in England call their churches chapels, and this erroneous use of the word has crept somewhat into use in America.

Chapelle ardente, a peculiar ceremony in the Roman Church in connection with the masses for the dead. The *ch. pelle* is a small tent in which the corpse is laid, and is called *ardente* in allusion to the lights placed round the catafalque. Incense is burned, holy water is sprinkled, prayers are chanted, and absolution is given, ending with *requiescat in pace*.—Eadie, *Eccle. Dictionary*, s. v.

Chapharperah. See MOLE.

Chapin, Calvin, D.D., an eminent Congregational minister, was born in Springfield, Mass., about 1764. He graduated at Yale in 1788, and in 1791 became tutor in the same college, where he remained until March, 1794, when he was ordained pastor at Rocky Hill. He was a trustee of the Conn. Miss. Soc., and one of the five organizers of the "American Board of Commissioners for Foreign Missions." He was a strong advocate of the principle of "total abstinence." He was made D.D. by Union College in 1816. He resigned his pastoral charge in 1847, and died March 16, 1851. He published several sermons on funeral and other occasions.—Sprague, *Annals*, ii, 823.

Chapin, Stephen, D.D., a Baptist minister, was born at Milford, Mass., Nov. 4, 1778. He graduated at Harvard in 1804, and in 1805 was ordained pastor of the Congregational church in Hillsborough, N. H., from whence he removed, in Nov. 1809, to the Congregational church in Mount Vernon, N. H. Here he remained nine years, but, on account of a change in his views concerning baptism, he was discharged Nov. 18, 1818, and the same month he was received a member of the Baptist Church. In the fall of 1819 he was installed pastor of the Baptist church in North Yarmouth, Me., where he was greatly esteemed. In 1822 he was made D.D. by Brown University. In 1823 he became professor of Theology at Waterville College, Me., and remained there until his appointment as president of Columbia College, Washington, D. C., where he was inaugurated in March, 1829, and labored for twelve years with unflagging zeal and energy. In consequence of growing infirmities he resigned the presidency in 1841, and retired to a small farm near Washington, where he died Oct. 1st, 1845. Dr. Chapin published a pamphlet on Baptism in 1819, and a number of occasional sermons, addresses, etc.—Sprague, *Annals*, vi, 673.

Chapter (כִּתְּוֹב, *rosh, head*, as it is usually rendered; but in the account of the Temple it is translated "top," as 1 Kings vii, 16, etc.), or **CAPTAL**, as it is called in modern architecture, is the upper or ornamental part of a column (Exod. xxvi, 88; xxxviii, 17, 19, 28), in which passages those of the Tabernacle are spoken of as being overlaid with gold. See **TABERNACLE**. In 1 Kings, vii, 19, the chapters on the tops of the pillars were formed of "lily work." See **JACHIN**. By comparing these descriptions with the remains of ancient temples in Egypt, we find that it was the practice to gild and paint the columns of various colors. The lotus or lily ornament was also a favorite in Egyptian architecture. See **PILLAR**. A more distinctive term thus rendered is כִּתְּוֹב (see *pheth*, literally something overlaid), which occurs in 2 Chron. iii, 15, evidently in this sense. In all other passages the Heb. word thus rendered is the specific one כִּתְּוֹב (see *kothe'reth*, literally a coronet), which in the case of the Sanctuary was of brass, and in some instances decorated with artificial pomegranates (Jer. lii, 22). See **ARCHITECTURE**. "The prevalent idea of the Hebrew term is the roundness of the forms which characterized the capitals of the Egyptian and Assyrian columns (Fürst, *Hebr. Wört.* p. 648). The *kothereh* consisted of two portions, the crown or ledge (in which sense it is applied to the laver [q. v.], 1 Kings vii, 31), and the 'pommel' or turban-shaped bowl beneath (כִּתְּוֹב). According to R. Levi ben-Gershom, this chapter rather resembled a pair of crowns or caps, so joined as to form an oval figure of five cubits high, bulging out all around beyond the breadth of the column which it surmounted, not unlike, as we may suppose, the truncated lotus-bud capitals of the grand pillars of the Memnonium, Thebes (see Frith's *Egypt and Palestine Photographed*, vol. i, pl. 85). Lightfoot, who adopts Gershom's view (*Descriptio Temp.* xiii, 2, 3), reconciles the discrepancy between 1 Kings vii, 16, and 2 Kings xxv, 17, as to the height of the chapters, by observing that the three cubits contained the sculpture or "wreath-work" mentioned in the same verse, whereas the other passage included two belts or necks of plain space of two more cubits below the ornamental portion. The chapters were festooned with 'nets of checker-work and wreaths of chain-work,' with sculptured 'pomegranates,' forming an ornate group similar to that which still adorns the columns of the beautiful temple ruins of Wady Kardassy in Nubia (Frith, ii, pl. 4). Lightfoot (*ut supra*) translates thus: "The chapters upon the top of the pillars possessed lily-work of four cubits over the porch," and supposes that the lily-work surrounded the column *under* and *not around* the chapter; the lily-leaf not enveloping the chapter, which had its ornaments already, but curving laterally over the space of the porch, and occupying four cubits of the column below the chapter. The more natural view, however, is that the lily-leaves or lotus ornaments formed the capital itself. A vast amount of learned information, from ancient and modern sources, is accumulated on the subject in Plesken's *Dissertatio Philologica de Columnis Aenicis* (Vitemb. 1719)" (Kitto, s. v.). See **COLUMN**.

Chaplain (*capellanus*), a person who performs divine service in a *capella* (chapel). The position of the chaplain was contingent upon the nature of the *capella*, which either denotes a church without parochial rights, an oratory, a sanctuary, or even a part (altar, etc.) of a particular church. See **CHAPEL**. Thus the chaplain was sometimes the assistant of a parish priest; sometimes even exempted from episcopal jurisdiction. The "royal or palace chaplains" (*capellani regii* or *palatini*) usually received large privileges from the popes. At the head of the army chaplains (*capellani militum*) was a chaplain general (*Capellanus major regius*), to whom usually extraordinary faculties were transferred. There

were also special chaplains in the castles of noblemen and in the houses of wealthy citizens. The chaplains of the bishops usually served as their secretaries. The chaplains attached to the papal court were divided into three classes: titular chaplains (*capellani honorarii*), chaplains assisting at the pontifical ceremonies (*ceremoniarii*), and chaplains employed as private secretaries of the pope (*capellani secreti*). Chaplains were also commonly appointed for the religious services in monasteries, hospitals, and other ecclesiastical institutions; but the most common employment of chaplains in the Church of Rome soon became, and still is, service at non-parochial churches and sanctuaries, or as assistants of the parish priests at large churches requiring the services of more than one clergyman.

In many of the Protestant churches the name chaplain was for a long time retained for the assistant clergymen at large churches, but this use has gradually disappeared, and is now only to be found in a few places, especially in Hungary. It is used in modern times as the title of court preachers, of preachers appointed for the chapels of ambassadors or for private chapels, and more commonly for clergymen appointed exclusively to minister in the army or navy (army and navy chaplains). "In England there are 48 chaplains to the king, who wait four each month, preach in the chapel, read the service to the family, and to the king in his private oratory, and say grace in the absence of the clerk of the closet. While in waiting they have a table and attendance, but no salary. In Scotland the king has six chaplains, with a salary of £50 each; three of them having, in addition, the duty of the chapel royal divided between them, making up above £100 to each. Their only duty at present is to say prayers at the election of peers for Scotland to sit in Parliament" (Buck, *Theological Dictionary*, s. v.). In England, "when the system of army chaplains was remodelled in 1796, a *chaplain-general* was appointed: this office was abolished by the Duke of Wellington soon after the termination of the great war, but revived by Mr. Sidney Herbert in 1846. The chaplain-general, who receives £1000 per annum, has duties partaking somewhat of those of an archdeacon. He assists the War Office in selecting chaplains, and in regulating the religious matters of the army. His office forms one of the 17 departments under the new organization of the War Office. There are about 80 chaplains on the staff, besides assistant clergymen and chapel clerks. The commissioned chaplains receive from 16s. to 28s. per day, and there are always some on half pay, while the assistant clergymen receive from £200 to £400 a year. The whole expenditure for commissioned chaplains, assistant clergymen, chapel-clerks, and church and chapel books, figures in the Army Estimates for 1860-61 at about £45,000. In the navy every ship in commission, down to and including fifth-rates, has a chaplain. The Navy Estimates (1860-61) provide for 99 commissioned chaplains, at stipends varying from £160 to £256 per annum; 9 others in district guard-ships, at average stipends of about £175; and 66 on half-pay, at 5s. to 10s. per day. The chaplains perform divine service at stated times on shipboard, visit the sick sailors, and assist in maintaining moral discipline among the crew" (Chambers, *Encyclop.* s. v.).

In the United States the national government has not only army and navy chaplains, but also chaplains for both houses, Senate and Representatives. Many of the state Legislatures have chaplains also.

Chaplet (French *chapelet*), a string of beads, or other material, used by Romanists in counting the number of their prayers. It is more commonly called the Rosary (q. v.).

Chaplin, Daniel, D.D., a Congregational minister, and native of Rowley, Mass., was born Dec. 30, 1748. He graduated at Harvard, 1772, and was made D.D. by the same college in 1817. He was ordained

pastor at Groton, Jan. 1, 1778, and remained in the same charge for fifty years. His great piety and decision of character gave him great influence in the stormy times of the Revolution, and his long ministry was acceptable and useful, until, toward the close of his life, part of his congregation chose a Unitarian minister. He died in peace in 1831.—Sprague, *Annals*, ii, 150.

Chaplin, Jeremiah, D.D., a Baptist minister, was born at Georgetown (then Rowley), Mass., Jan. 2, 1776; graduated at Brown University in 1799, and took charge of the Baptist Church in Danvers, Mass., about 1802. In 1817 he became principal of a theological school in Waterville, Me., of which, after its being chartered as Waterville College in 1820, he was elected President. He held the office thirteen years with great success. He was made D.D. by the College of South Carolina in 1819. In 1833 he resigned the presidency of the college, and, after preaching for some time at Rowley, Mass., and at Willington, Conn., finally settled at Hamilton, N. Y., where he died suddenly, May 7th, 1841. Dr. Chaplin published *The Evening of Life; or, Light and Comfort amidst the Shadows of declining Years*.—Sprague, *Annals*, vi, 463; Patison, *Eulogy on Dr. Chaplin*, Boston, 1843.

Chaplin, Jonathan E., a Methodist Episcopal minister, was born in Connecticut in 1789, was converted in 1830, and entered the travelling ministry in the Ohio Conference in 1834. He was three years principal of Norwalk Seminary, Ohio, and then remained in the itinerant work in Ohio till 1840, when he removed to the Michigan Conference, and was made principal of White Pigeon branch of the Michigan University. Here he remained until his death in 1846. While young he studied law in the State of New York, and during the war of 1812 was aid-de-camp to General Porter. Soon after the peace he settled at Urbana, Ohio, where he practiced law till his conversion. In the cause of education he was of lasting service and benefit to the Church in Ohio and Michigan. His care of the institutions committed to him was very satisfactory. His last words were, "Live holiness, and preach it from the heart."—*Minutes of Conf.*, iv, 178.

Chapman (חַפְּזָן חַמְּוִשׁ, *enosh' hat-tur'*, man of the journeying, traveller, i. e. for purposes of traffic), a trader who transports articles of commerce from the place of production to a mart (2 Chron. ix, 14); a merchant-man, as the same phrase is rendered in the parallel passage (1 Kings x, 15). See MERCHANT.

Chapman, John, D.D., an eminent English theologian, was born at Strathfieldsaye in 1704; studied at King's College, Cambridge, and in 1739 became rector of Mersham, in Kent, from whence, in 1744, he removed to the rectory of Alderton. He afterwards became archdeacon of Sudbury, and treasurer of Chichester, and died Oct. 14, 1784. The most important of his works are: *Eusebius; or, the true Christian's Defence against a late Book entitled the Moral Philosopher* [by Dr. Morgan] (1789-91, 2 vols. 8vo); *Miscellaneous Tracts relating to Antiquity, revised and corrected, with Additions* (Lond. 1748, 8vo); *Expediency and Credibility of Miraculous Powers among the primitive Christians after the Deaths of the Apostles* (Lond. 1752, 4to).—Darling, *Cyclopædia Bibliographica*, i, 682; Hook, *Ecol. Biography*, iii, 554.

Chappel, William, D.D., bishop of Cork, was born at Lexington, Nottinghams., Dec. 10, 1582, and was educated at Mansfield, from whence he removed to Christ's College, Cambridge, where he obtained a fellowship. By the favor of archbishop Laud he was made dean of Cashel, Ireland, in 1638, and soon after provost of Trinity College, Dublin. In 1638 he was made bishop of Cork. He suffered many hardships in the Rebellion, and on landing in England was sent to prison, but soon obtained his liberty. He died at Derby in 1649. He wrote *Methodus Concionandi* (London,

1648), and *A Treatise on the Use of Holy Scripture* (London, 1653, 8vo). The *Whole Duty of Man* has also been ascribed to him, but without probability. Archbishop Usher and bishop Martin opposed him on account of his apparent leaning to Romanist views of discipline.—Hook, *Church Dictionary*, iii, 554; Kippis, *Biographia Britannica*, iii, 439.

Chappelow, Leonard, B.D., an eminent Oriental scholar, was born in England in 1688. He was educated at St. John's College, Cambridge, chosen fellow in 1717, and became Arabic professor in that university in 1720. He also obtained the livings of Great and Little Horstead. He died in 1768. His principal works are, *A Commentary on the Book of Job, in which is inserted the Hebrew Text and English Translation* (Camb. 1752, 2 vols. 4to); *Elementa linguæ Arabicæ* (1780, 8vo); *Six Assemblies, or ingenious Conversations of learned Men among the Arabians* (1767, 8vo).—Darling, *Cyclopædia Bibliographica*, i, 683; Rose, *New Gen. Biog. Dict.*, vi, 211.

Chapter, an abbreviated form of the word *chapter* (q. v.), heading, e. g. of a column.

CHAPTER OF THE BIBLE. The present numeral division of the Scriptures into chapters and verses is, in some respects, of comparatively recent origin. The Pentateuch was divided by the Jews, at an early period, into fifty-four *parshioth* (פַּרְשִׁיּוֹת) = sections, one of which was read in the synagogue every Sabbath day (Acts xiii, 15). These sections were subdivided, probably by the Masoretes, into 669 *sidarim* (סִדְרִים), or orders. After the reading of the law, it was also customary, from an early period, to read a passage from the prophets, and with that to dissolve the assembly. Such passages were called *haphkhoroth* (הַפְּחֻרֹת) = dismissals, and appear to have been selected according to the choice of any reader (Acts xiii, 15; xxvii, 43; Luke iv, 16). The divisions or sections found in the Greek and Latin manuscripts are different from those of the Hebrew books; they are of unequal and arbitrary length, and very different from the chapters in our printed Bibles. So, also, the books of the New Testament were divided, at an early period, into certain portions, which appear under various names. The division into church lessons, read in the assemblies like the sections of the law and the prophets, was the most ancient. Subsequently the New Testament was divided into two kinds of sections, called *titles* (τίτλοι) and *chapters* (κεφάλαια = heads). The titles were portions of the Gospels, with summaries placed at the top or bottom of the page. The chapters were divisions, with numeral notations, chiefly adapted to the Gospel harmony of Ammonius. Other sectional divisions are occasionally seen in manuscripts, which appear to have varied at different times and in different churches, accordingly as festival days were multiplied. See BIBLE.

The numerical division of the Old and New Testaments into modern chapters is by some ascribed to Lanfranc, who was archbishop of Canterbury in the reigns of William the Conqueror and William II, while others attribute it to Stephen Langton, who was archbishop of the same see in the reigns of John and Henry III. Its authorship, however, is usually assigned to the schoolmen, who, with cardinal Hugh of St. Cher, were the authors of the Concordance for the Latin Vulgate, about A.D. 1240. This cardinal wrote remarks, or *Postils*, as they were called, on all the books of Scripture; and this Latin Bible, published by him, is generally supposed to be the first Bible divided into the present chapters. Yet cardinal Humbert, about A.D. 1059, cites the 12th and 18th chapters of Exodus, and the 23d of Leviticus, according to our present division of chapters. Whoever was the author, from about this period the division of the several books into chapters was gradually adopted in the Latin and other versions; and, finally, in the Hebrew, with a few va-

riations, and also in the Greek text. The several Psalms were not included in this division. See VERSE.

CHAPTER, as an ecclesiastical term, the name of a corporation of ecclesiastics, bound by canonical rules, and generally attached to a cathedral. The name chapter arose from the fact that the first communities of canons (q. v.) were called together daily in a common hall, to hear a chapter of the Bible, or of their common rules, read aloud. The hall was hence called the Chapter, or Chapter-house (q. v.), and the name finally passed to the body of ecclesiastics assembling in it.

Originally the property of the chapter belonged to the diocese; and the monks or canons had a common life, and kept strict obedience. Corporations of this kind rapidly multiplied, however, and soon began to have wealth of their own; by the 12th century these *capitula canonicorum* were attached to almost every see. The nomination of the bishop fell to the chapter, and this was allowed by the popes, thus enlarging greatly the power of the chapter, and diminishing the authority of the bishop over it. The nobility of Europe found the canonries rich, and the chapters were made sources of income for their children, who in some dioceses filled every stall. These *secular* canons absorbed the revenues of the chapters, and appointed vicars to do the work. The Council of Trent introduced many reforms (sess. 23, 25). In 1808 the chapters, as corporations, were abolished in South Germany, and in 1810 in Prussia. Whatever rights the chapters now have are based upon the canon law, and upon the special legislation of each country in which they exist. In Switzerland, Prussia, and other Protestant countries of Germany, the chapters have received the right of electing the bishops, who in most of the Roman Catholic countries are appointed by the sovereigns.

In England the chapter of a cathedral church consists "of persons ecclesiastical, canons and prebendaries, whereof the dean is chief, all subordinate to the bishop, to whom they are as assistants in matters relating to the church, for the better ordering and disposing the things thereof, and for confirmation of such leases of the temporalities and officers relating to the bishopric as the bishop from time to time shall happen to make" (Hook, s. v.). The dean and chapter had formerly the right to choose the bishop in England, but that right was assumed by Henry VIII as a prerogative of the crown. In Germany, Luther made an attempt to preserve the chapters as ecclesiastical corporations, but soon most of them lost altogether their ecclesiastical character, and nearly all of them perished at the beginning of the present century. A few chapters, like those of Halberstadt, Minden, and Osnabrück, had both Protestant and Roman Catholic canons, and in Osnabrück even the election of the bishop had to alternate between the two denominations.—Herzog, *Real-Encyclopædie*, ii, 554 sq.; Ersch u. Gruber, *Encyclop.* xxvi, 888 sq. See CANON; DEAN.

CHAPTERS, THE THREE, a title given to three points (*κεφάλαια*, *capitula*) condemned by the fifth Council of Constantinople. They were, 1. The person and writings of Theodore of Mopsuestia; 2. The writings of Theodoret, so far as they were directed against Cyril; 3. The letter of Ibas of Edessa to Maris, concerning the Council of Ephesus. The emperor Justinian, under the influence of his wife Theodora, who was at heart a Monophysite, and of Theodore, bishop of Cæsarea, published an edict A.D. 544, in which the above were condemned. This edict was signed by most of the Eastern bishops, but was opposed by the African and Western bishops, especially by Vigilius, the Roman pontiff, who was ordered to Constantinople (A.D. 547), and obliged to give a written declaration (*Judicatum*) approving the condemnation of the "Three Chapters." They were afterwards condemned anew by Justinian, A.D. 551, and by the fifth Council of Constantinople, A.D. 553. Dr. Schaff remarks (iii,

770) that the "controversy of the 'Three Chapters' has filled more volumes than it is worth lines."—Mosheim, *Ch. Hist.* cent. vi, pt. ii, ch. iii, § 10, note; Schaff, *Ch. History*, iii, § 144; Gieseler, *Church History*, i, § 109. See CONSTANTINOPLE.

Chapter-house (see CHAPTER), an apartment or hall in which the monks and canons of a monastic establishment, or the deans and prebendary of cathedrals and collegiate churches, meet for transacting the business of the body of the society. Chapter-houses were often built in the most magnificent and costly style of architecture. They are of various forms, more usually located contiguous to a church, and often mere places of burial, having occasionally crypts under them.

In mediæval Latin the chapter-house is denominated *capitulum*, and also *Domus Capitularis*. The former term was also applied to the east end of the church (*caput ecclesie*), and hence there have been errors of translation.

Charaith'alar (*Χαραθαλάρ* v. r. *Χαραθαλάρ*, Vulg. *Carmella et Careth*) is given among the pseudo-priests in 1 Esdr. v, 36, where "Charaathalar, leading them and Analar," is the confused translation for "CHERUB (q. v.), Addan (or Addon), and Immer," of the Heb. texts (Ezra ii, 57; Neh. vii, 61).

Char'aca (*Χάρακ*, Vulg. *Characo*) is a place obscurely mentioned only in 2 Macc. xii, 17 (*εἰς τὸν Χάρακα*), as that to which Judas Maccabæus retired after his attack of the Nabathæans. It was on the east of Jordan, being inhabited by the Jews called "Tubieni," or "Tobie" (see TOB), who were in Gilead (comp. 1 Macc. v, 9, 18); and it was 750 stadia from the city Caspin; but where the latter place was situated, or in which direction Charax was with regard to it, there is no clew. Ewald (*Jer. Gesch.* iv, 369, note) places it to the extreme east, and identifies it with Raphon. The only name now known on the east of Jordan which recalls Charax is *Kerak*, the ancient Kir-Moab, on the S.E. of the Dead Sea, which in post-biblical times was called *Χαράκωβα*, and *Μωβουχάραι* (see Reland, *Palæst.* p. 706). The Syriac has *Karka*, which suggests Kar-kor (Judg. viii, 10).—Smith, s. v.

Character (*χαρακτήρ*, *impress, image*), CHRISTIAN, is the force of a man's moral personality, as modified and developed by the work of the Holy Spirit.

Christianity does not seek to destroy the natural and moral qualities of man, but to elevate, strengthen, and sanctify them. But the individual man, under the Christian system, is taught "of the Holy Spirit" the way of life; and, under his own responsibility, the influence of the Holy Spirit must be voluntarily accepted as the inspiring and controlling principle of the qualities which belong to him by nature. If this be not the case, the man remains a "natural man," and his character is his natural character. But the beginning of a new moral course of life, through the work of the Holy Spirit, is *regeneration*, and in regeneration the true foundation of the Christian character is laid. But this regeneration, though it requires active faith on the part of man, is, nevertheless, the work of God, and therefore character is necessarily a divine work, "lest any man should boast" (Eph. ii, 9). Of course, all the practical forms of goodness, the cardinal virtues, so called (2 Pet. i, 5-7), and the special Christian virtue of charity, are elements of this Christian character. It manifests itself in the "fruits of the Spirit," which always, in turn, react upon the character, bringing it constantly into nearer identity with the "inner" or "spiritual" man (Eph. iii, 16; iv, 23). It fixes the moral worth of the individual, as well as his fitness for the kingdom of God, in which the entire character, the *whole man*, is peremptorily required (Matt. vi, 24; xii, 23). Christianity demands the *whole* heart; for "out of the heart are the issues of life," and the ruling disposition of a man's heart forms the essence of his character. With Paul, character is the man: the holy

character is the "new man;" the corrupt character the "old man."

But, though the Spirit works this Christian character in man, it leaves free play for the special gifts and endowments of the individual. Although "in Christ there is neither Jew nor Greek," there is room in Christ's kingdom for diversities springing from temperament, race, or nationality. The apostles Peter, Paul, John, and Judé have been taken, by some writers, as types of the four temperaments, sanguine, nervous, lymphatic, and bilious. The Word of God is regarded, in the Christian system, as the rule of life and standard of appeal for the Christian character. On *perfection* of character, see HOLINESS; SANCTIFICATION; PERFECTION. — Herzog, *Real-Encyclop.* vii, 316; *Bibliotheca Sacra*, iii, 22.

Character Dominicus (*the mark of the Lord*), a name by which, as well as *character regius* (*royal mark*), Augustine designates the sacrament of baptism; "by which he does not mean any internal quality or spiritual power distinct from baptism imprinted on the soul, but only the external form common to all receivers, both good and bad, who are duly baptized in the name of the Holy Trinity; that they are so far signed by the mark or character of the Lord as thereby to be distinguished from unbaptized Jews and Gentiles, who never made any formal profession of Christianity, nor ever received so much as the external indication of it. He allowed this character to be so far indelible that a Christian, though he turn Jew or pagan, can never need a second baptism, but only repentance and abolution to reinstate him in the Church." It is clear that Augustine did not dream of the later Romanist theory of sacramental "character." — Bingham, *Orig. Eccles.* bk. xi, ch. i, § 7. See CHARACTER INDELEBILIS.

Character Indelebilis. In the Church of Rome it is held that a spiritual sign, called *character*, is impressed in the soul by certain sacraments. Aquinas taught that, "in consequence of the death of Jesus, the sacraments instituted in the New Testament have obtained what is called *virtus instrumentalis*, or *effectiva*, which those of the Old Testament did not possess. Therefore, by partaking of the sacraments, man acquires a certain character, which, in the case of some sacraments, such as baptism, confirmation, and the ordination of priests, is *character indelibilis*, and, consequently, renders impossible the repetition of such sacraments" (Aquinas, *Summa*, pt. iii, Qu. 60-65).

The Council of Florence (1439) laid down the following canon (Mansi, t. xxxi, col. 1054 sq.): *Inter hæc sacramenta tria sunt, baptismus, confirmatio et ordo, quæ characterem, i. e. spirituale quoddam signum a cæteris distinctivum imprimunt in anima indelibile. Unde in eadem persona non reiterantur.* Reliqua vero quatuor characterem non imprimunt et reiterationem admittunt. — "Among the sacraments there are three, baptism, confirmation, and orders, which impose in the soul a character, that is, a certain spiritual and indelible sign, distinguishing it from others. Hence, in the same persons, these sacraments are not repeated. The other four do not impress a character, and admit of repetition." The Council of Trent gives the following: "9. Whoever shall affirm that a character, that is, a certain spiritual and indelible mark, is not impressed on the soul by the three sacraments of baptism, confirmation, and orders, for which reason they cannot be repeated, let him be accursed" (sess. vii, can. 9). There is a great variety of opinions (naturally enough) among Romanist theologians concerning the nature of this "character." See Ferrara, *Promta Bibliotheca*, viii, 221 (s. v. Sacramentum); Elliott, *Delineation of Romanism*, bk. ii, ch. i.

Char'ashim (Heb. *Charashim'*, חַרְאֲשִׁים, *craftsmen*, as it is explained in the text; Sept. *Ἀγαστάσιοι* v. r. *Ἰγασάσιοι*), the name of a valley (חַרְאִים, *ravinus*) inhabited by the descendants of Joab (q. v.), of the tribe of

Judah, so called from their employment as artificers (1 Chron. iv, 14). The same place is mentioned in Neh. vi, 85 (A. V. "valley of craftsmen;" Sept. γῆ ἀγασσίου) as extant after the Captivity, and inhabited by the Benjamites, and as lying not far from Jerusalem. The Talmud (as quoted by Schwarz, *Palet.* p. 185) reports the valley of Charashim to consist of Lod and Ono, which lay therein. These notices appear to fix its position as in the undulating ground at the back of the plain of Sharon, east of Jaffa, being, in fact, the depression now marked by *Wady Maseirah*. See CRAFTSMAN.

Char'ohamis (Χαρῶμις v. r. Χαλχαμύς, 1 Esdr. i, 25), **Char'ohemlah** (2 Chron. xxxv, 20), other methods of Anglicising the name CARCHEMISH (q. v.).

Char'ous (Βαρχοῦς; Vulg. *Barcus*), given (1 Esdr. v, 32) as one of the heads of the Temple servants that returned from Babylon; a corruption for *Barkos* (q. v.) in the lists of Ezra (ii, 58) and Nehemiah (vii, 55), possibly by a change of צ into כ. But it does not appear whence the translators of the A. V. got their reading of the name. In the edition of 1611 it is "Char-eus."

Cha'rea (Χαρία), given (1 Esdr. v, 82) as the name of another head of the Temple servants who returned with Zerubbabel, instead of the HARSHA (q. v.) of the Heb. text (Ezra ii, 52; Neh. vii, 54).

Charenton, a town of France, five miles from Paris. A Protestant Synod was held there in 1631, in which the Confession of Augsburg was declared free of errors on all fundamental doctrinal points, and its adherents to be entitled to the sacrament of the Lord's Supper in the Reformed churches, to be accepted as sponsors for children, and to intermarry with the Reformed. See FRANCE, REFORMED CHURCH OF.

Chares (Χαρής), one of the most influential of the Jewish commanders, who died of illness during the final struggle with the Romans (Josephus, *War*, ix, i, 4, 9).

Charey-Yonim. See DOVES' DUNG.

Charger. The silver vessels offered by the heads of the tribes for the service of the Tabernacle (Num. viii) are thus termed in our translation, being in the original כְּפָרֶת (*keparak'*, literally a *deep dish*), a *basin*, elsewhere rendered "dish" (Exod. xxv, 29; xxxvi, 16; Num. iv, 7). These are said to have been of silver, and to have weighed each 180 shekels, or 65 oz. (Hussey, *Asc. Weights*, chap. ix, p. 190). The "charger" upon which the Baptist's head was presented to Herodias (comp. Homer, *Il.* i, 141) must have been a large *platter* (πίναξ, strictly a broad *tablet* [comp. *πινακίδιον*, a writing-tablet, Luke i, 68], hence a wooden trencher, Matt. xiv, 8, 11; Mark vi, 25, 28; rendered "platter" in Luke xi, 89). The "chargers" of gold and silver, in Ezra i, 9 (כְּפָרֶת, *apartak'*), were probably, as interpreted by the Sept., Vulg., and Syriac, *basins* for containing the blood of sacrifices; although others make them to have been *basins* for first-fruit offerings. See BASIN; DISH.

Chargol. See BEETLE.

Chariot (properly מֵרְכָבָה, *merkabak'*, a vehicle for riding; ἄρμα), a car used either for warlike or peaceful purposes, but most commonly the former. Of the latter use there is but one probable instance as regards the Jews (1 Kings xviii, 44), and as regards other nations, but few (Gen. xli, 43; xli, 29; 2 Kings v, 9; Acts viii, 28). The Scriptures employ different words to denote carriages of different sorts, but it is not in every case easy to distinguish the kind of vehicle which these words severally denote. We are now, however, through the discovery of ancient sculptures and paintings, in possession of much new information respecting the chariots of Egypt, Assyria, Babylon, and Persia, which are, in fact, mentioned in the Scrip-

tures. There has been some speculation as to any difference of meaning between the above word and the briefer (masc.) form מֵרִכָב, *merkab'*, which occurs in three passages only. In 1 Kings v, 6, the latter obviously means chariots, taken collectively. But in Lev. xv, 9 (Auth. Vers. "saddle"), and Cant. iii, 10 ("the covering"), it has been understood by some to denote the seat of a chariot. To this view there is the fatal objection that ancient chariots had no seats. It appears to denote the seat of a litter (the only vehicle that had a seat), and its name *merkab'* may have been derived from the general resemblance of the body of a litter (distinguished from the canopy, etc.), both in form and use, to that of a chariot. Another still simpler form, the word רִכָב, *re'keb* (with the analogous forms רִכְבָּה, *rikbah'*, Ezek. xxvii, 20, and רִכֹּב, *re'kob'*, Psa. civ, 8), from the same root, appears to signify a carriage of any kind, and is especially used with reference to large bodies of carriages, and hence most generally of war-chariots; for chariots were anciently seldom seen together in large numbers except in war. It is applied to the war-chariots of the Egyptians (Exod. xiv, 9), the Canaanites (Josh. xvii, 18; Judg. i, 19; iv, 8), the Hebrews (2 Kings ix, 21, 24; x, 16), the Syrians (2 Kings v, 9), the Persians (Isa. xxi, 7, 9). To this corresponds the *pidon* of Rev. xviii, 18; the Latin *rheda*, a carriage with four wheels, an improvement of later times. By a comparison of these references with those passages in which *merkabah* occurs, we find the two words applied to all sorts of carriages indifferently and interchangeably, just as we should say either "carriage" or "coach"—neither of which is specific, and both of which differ more from each other than the Hebrew words in question—to denote the same vehicle. Indeed, there are passages in which both words are manifestly applied to the same identical vehicle, as in 2 Kings v, 9, 21, and 1 Kings xxii, 85, 88, where some have endeavored to make out a difference between the Heb. terms. There is another word once rendered chariot, viz. עֲגָלָה (*agalah'*, Psa. xlv, 9), but it denotes a *plaustrum*, cart, or wagon drawn by oxen. See CART. The only other words rendered "chariot" in the Bible are אֲפִירְיוֹן (*appiryon'*, Cant. iii, 9), which the etymol., as well as the rendering in the Sept. and Vulg., shows to have been a portable sedan or *palanquin* [see LITTER], and חֵרֶת, (*ho'teen*, only in Ezek. xxiii, 24), which, according to etymology and the Rabbin's, means *weapons* or defensive armor. It is demonstrated that the word *rekeb*, rendered "horsemen," does not mean "cavalry," but merely riders in the chariots—in other words, chariot-warriors; for Exod. xiv, 7, which gives the first account of the Egyptian army, says, "he took six hundred chosen chariots, and all the chariots of Egypt, and captains over every one of them" (or in each). The "horsemen" in verse 9 and the subsequent verses

means literally "riders," not upon the horses, but in the chariots. Hence, though Moses's song of triumph mentions the "horse and his rider" (Exod. xv, 1), yet ver. 4 clearly indicates that by rider chariot-rider is understood: "Pharaoh's chariots and his host hath he cast into the sea; his chosen captains also (chariot-warriors) are drowned in the Red Sea." See HORSE.

The earliest mention of chariots in Scripture is in Egypt, where Joseph, as a mark of distinction, was placed in Pharaoh's second chariot (Gen. xli, 43), and later when he went in his own chariot to meet his father on his entrance into Egypt from Canaan (xlii, 29). In the funeral procession of Jacob chariots also formed a part, possibly by way of escort or as a guard of honor (1, 9). The next mention of Egyptian chariots is for a warlike purpose (Exod. xiv, 7). In this point of view chariots among some nations of antiquity, as elephants among others, may be regarded as filling the place of heavy artillery in modern times, so that the military power of a nation might be estimated by the number of its chariots. Thus Pharaoh, in pursuing Israel, took with him 600 chariots. The Canaanites of the valleys of Palestine were enabled to resist the Israelites successfully in consequence of the number of their chariots of iron, i. e. perhaps armed with iron scythes (Josh. xvii, 18; Judg. i, 19; see Schickendanz, *De curribus falcatis*, Zerbst. 1754). Jabin, king of Canaan, had 900 chariots (Judg. iv, 8). The Philistines in Saul's time had 80,000, a number which seems excessive (1 Sam. xiii, 5; but comp. the Sept. and Joseph. *Ant.* vi, 6, 1). David took from Hadadzezer, king of Zobah, 1000 chariots (2 Sam. viii, 4), and from the Syrians a little later 700 (x, 18), who, in order to recover their ground, collected 82,000 chariots (1 Chron. xix, 7). Up to this time the Israelites possessed few or no chariots, partly, no doubt, in consequence of the theocratic prohibition against multiplying horses, for fear of intercourse with Egypt, and the regal despotism implied in the possession of them (Deut. xvii, 16; 1 Sam. viii, 11, 12). But to some extent David (2 Sam. viii, 4), and in a much greater degree Solomon, broke through the prohibition from seeing the necessity of placing his kingdom, under its altered circumstances, on a footing of military equality or superiority toward other nations. He raised, therefore, and maintained a force of 1400 chariots (1 Kings x, 26) by taxation on certain cities, agreeably to Eastern custom in such matters (1 Kings ix, 19; x, 25; Xenoph. *Anab.* i, 4, 9). The chariots themselves, and also the horses, were imported chiefly from Egypt, and the cost of each chariot was 600 shekels of silver, and of each horse 150 (1 Kings x, 29). See SHEKEL. From this time chariots were regarded as among the most important arms of war, though the supplies of them and of horses appear to have been still drawn from Egypt (1 Kings xxii, 34; 2 Kings ix, 16, 21; xiii, 7, 14; xviii, 24; xxiii, 30; Isa. xxxi, 1). The prophets also allude frequently to chariots as typical of power (Psa. xx, 7; civ, 8; Jer. li, 21; Zech. vi, 1). Chariots of other nations are likewise mentioned, as of Assyria (2 Kings xix, 28; Ezek. xxiii, 24), Syria (2 Sam. viii, and 2 Kings vi, 14, 15), Persia (Isa. xxii, 6); and, lastly, Antiochus Eupator is said to have had 800 chariots armed with scythes (2 Macc. xiii, 2). In the N. T. the only mention made of a chariot, except in Rev. ix, 9, is in the case of the Ethiopian or Abyssinian eunuch of Queen Candace, who is described as sitting in his chariot reading (Acts viii, 28, 29, 38). See RIDER.

Jewish chariots were no doubt imitated from Egyptian models, if not actually imported from Egypt. These appear to have come into use not earlier than the 18th dynasty (B.C. 1580). The war-chariot, from which the chariot used in peace did not essentially differ, was extremely simple in its construction. It consisted, as appears both from Egyptian paintings and reliefs, as well as from an actual specimen preserved at Florence, of a nearly semicircular wooden frame with



Ancient Egyptian War Car and Horses, designed from a comparison of different Monuments.

straightened sides, resting posteriorly on the axle-tree of a pair of wheels, and supporting a rail of wood or ivory attached to the frame by leather thongs and one wooden upright in front. The floor of the car was made of rope net-work, intended to give a more springy footing to the occupants. The car was mounted from the back, which was open, and the sides were strengthened and ornamented with leather and metal binding.

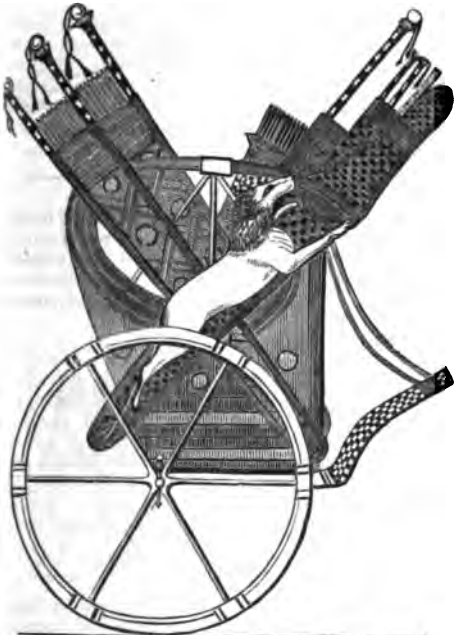

Ancient Egyptian Chariot of War, with Bow-cases and complete Furniture, except the Yoke.

Attached to the off or right-hand side, and crossing each other diagonally, were the bow-case, and inclining backwards, the quiver and spear-case. If two persons were in the chariot a second bow-case was added. The wheels, of which there were 2, had 6 spokes: those of peace chariots had sometimes 4, fastened to the axle by a linch-pin secured by a thong. There were no traces; but the horses, which were often of different colors, wore only a breast-band and girths, which were attached to the saddle, together with head furniture, consisting of cheek-pieces, throat-lash, head-stall, and straps across the forehead and nose. A bearing-rein was fastened to a ring or hook in front of the saddle, and the driving-reins passed through other rings on each side of both horses. From the central point of the saddle rose a short stem of metal, ending in a knob, whether for use or mere ornament is not certain. The driver stood on the off side, and in discharging his arrow hung his whip from the wrist. In some instances the king is represented alone in his chariot, with the reins fastened round his body, thus using his weapons with his hands at liberty. Most commonly two persons, and sometimes three, rode in the chariot, of whom the third was employed to carry the state umbrella (2 Kings ix, 20, 24; 1 Kings xxii, 84; Acts viii, 38). A second chariot usually accompanied the king to battle, to be used in case of necessity (2 Chron. xxv, 84).

On peaceable occasions the Egyptian gentleman sometimes drove alone in his chariot, attended by servants on foot. The horses wore housings to protect them from heat and insects. For royal personages and women of rank, an umbrella was carried by a bearer or fixed upright in the chariot. Sometimes mules were driven instead of horses, and in travelling sometimes oxen; but for travelling purposes the sides of the chariot appear to have been closed. One instance occurs

of a 4-wheeled car, which (like the *τετρακύκλος ἀμάξα* of Herod. ii, 68) was used for religious purposes. See CAET. The processes of manufacture of chariots and harness are fully illustrated by existing sculptures, in which also are represented the chariots used by neighboring nations (Wilkinson, *Anc. Egypt.* i, 368, 386; ii, 75, 76, 2d ed.).

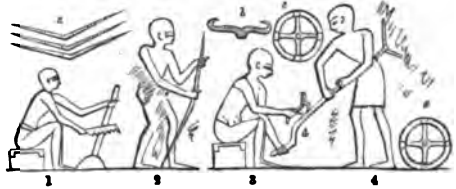

Ancient Egyptian Chariot-makers.

Fig. 1, Sawing out the Axle; 2, Preparing the bent pieces of Wood, a, b; 3, 4, Shaping the Pole, d; c, e, Wheels.

The earliest Egyptian chariot noticed in Scripture (Gen. xli, 48) was doubtless a state-chariot; but, among the Egyptians, it does not appear to have been different from the war-chariot, the splendid military appointments of which rendered it fit for purposes of royal pomp. Hence, although the same word (*מֵרְכָבָה*, *merkabah*) is again used for chariots of state in Gen. xli, 29; 1 Sam. viii, 11; 2 Sam. xv, 1, it undoubtedly denotes a war-chariot in Exod. xv, 4; Joel ii, 5. In Isa. ii, 7, the same word appears to comprehend chariots of every kind which were found in cities. In fact, chariots anciently in the East were used almost entirely for purposes of state or of war, being very rarely employed by private persons. We also observe that where private carriages were known, as in Egypt, they were of the same shape as those used in war, only having less complete military accoutrements, although retaining the case for arrows. One of the most interesting of the Egyptian paintings represents a person of quality arriving late at an entertainment in his curicle, drawn (like all the Egyptian chariots) by two horses (one hidden by the other in profile). He is at-



Ancient Egyptian Curicle.

tended by a number of running footmen, one of whom hastens forward to knock at the door of the house, another advances to take the reins, a third bears a stool to assist his master in alighting, and most of them carry their sandals in their hands, that they may run with the more ease. This conveys a lively illustration of such passages as 1 Sam. viii, 11; 2 Sam. xv, 1. The principal distinction between these private chariots and those actually used in war was, as appears from the monuments, that in the former the party drove himself, whereas in war the chariot, as among the Greeks, often contained a second person to drive it, that the warrior might be at liberty to employ his weapons with the more effect. But this was not always the case; for in the Egyptian monuments we often see even royal personages alone in their chariots, warring furiously, with the reins lashed round their waist. So it appears that Jehu (who certainly rode in a war-chariot) drove himself, for his peculiar style of driving was recognised at a considerable distance (2 Kings ix, 20). The Egyptians used horses in the equipment of an armed force before Jacob and his sons had settled in Goshen; they had chariots of war, and mounted asses and mules, and



Ancient Egyptian Chariot in Battle.

therefore could not be ignorant of the art of riding; but for ages after that period Arab nations rode on the bare back, and guided the animals with a wand. Others, and probably the shepherd invaders, noosed a single rope in a slip-knot round the lower jaw, forming an imperfect bridle with only one rein; a practice still in vogue among the Bedouins. Thus cavalry were but little formidable, compared with chariots, until a complete command over the horse was obtained by the discovery of a true bridle. This seems to have been first introduced by chariot-drivers, and there are figures of well-constructed harness, reins, and mouth-pieces in very early Egyptian monuments, representing both native and foreign chariots of war. In fighting from chariots great dexterity was shown by the warrior, not only in handling his weapons, but also in stepping out upon the pole to the horses' shoulders, in order the better to attain his enemies; and the charioteer was an important person, sometimes equal in rank to the warrior himself. Both the kingdoms of Judah and Israel had war-chariots, and, from the case of king Josiah at the battle of Megiddo, it is clear they had also travelling vehicles, for, being wounded, he quitted his fighting-chariot, and in a second, evidently more commodious, he was brought to Jerusalem (2 Chron. xxxv, 24). Chariots of war continued to be used in Syria in the time of the Maccabees (2 Macc. xiii, 5), and in Britain when Caesar invaded the island (*Bell. Gall.* iv, 29).

In the prophecy of Nahum, who was of the first captivity, and resident (if not born) at Elkosh in Assyria, there is much allusion to chariots, suggested doubtless by their frequency before his eyes in the streets of Nineveh and throughout the Assyrian empire. In fact, when prophesying the downfall of Nineveh, he gives a particular and animated description (ii, 84) of their action in the streets of the great city:

The shield of his heroes is reddened,
The men of prowess are crimsoned [in dress]:
With the fire of irons [flashing steel armatures] is the chariot in the day of his arrow;
And the cypresses [lances] are brandished;
In the streets will madden the chariot-force,
They will race in the broad places;
Their appearance is as the torches,
As the lightnings will they rush.

Abundant illustrations of this passage occur on the recently discovered sculptures of Nineveh and Babylon. They are minutely described by Layard (*Nineveh*, ii, 268 sq.). The earlier Assyrian war-chariot and harness did not differ essentially from the Egyptian. Two or three persons stood in the car, but the driver is sometimes represented as standing on the near side, while a third warrior in the chariot held a shield to protect the archer in discharging his arrow. The car appears to have had closed sides. The war-chariot wheels had 6 spokes; the state or peace chariot 8 or more; and a third person in state processions carried the royal umbrella. A third horse, like the Greek *παρόρος*, was generally attached (Layard, *Nineveh*, ii, 350). In later times the third horse was laid aside, the wheels were made higher, and had 8 spokes, and the front of the car, to which the quiver was removed from its

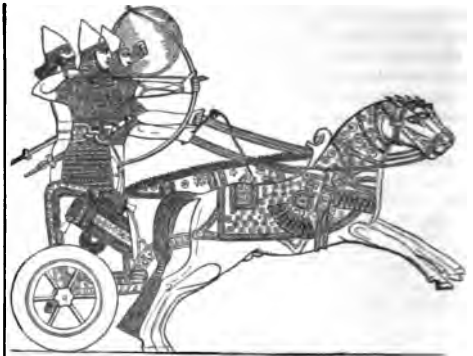

Ancient Assyrian Warrior in a Chariot.

former side position, was made square instead of round. The cars were more highly ornamented, panelled, and inlaid with valuable woods and metals, and painted. The embroidered housings, in which in earlier times the horses were clothed, were laid aside, and plumes



Royal Chariot. From the later Assyrian Monuments.

and tassels used to decorate their necks and foreheads (*Layard, Nineveh*, ii, 358, 356; *Nineveh and Babylon*, p. 841, 587, 608, 618; *Mon. of Nin.* 2d series, pl. 24; comp. Ezek. xxvii, 20). Chariots used for other purposes than that of war, especially in hunting, were



Ancient Assyrian Chariot for the Chase.

and tassels used to decorate their necks and foreheads, as well as occasionally carts for the transportation of persons or baggage.

The Persian art, as appears from the sculptures at Persepolis, and also at Koyounjik, shows great similarity to the Assyrian; but the procession represented at the former place contains a chariot or car with wheels of 12 spokes, while, from the sculptures at the latter, it appears that the Elamites, or Persians, besides chariots

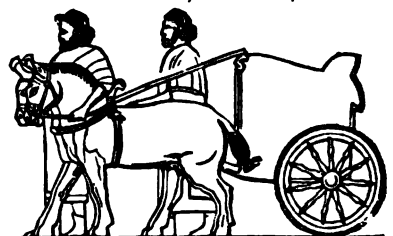

Ancient Persian Chariot.

containing two persons, which were sometimes drawn by four horses, used a kind of cart, drawn by a single mule or more, consisting of a stage on high wheels, capable of holding five or six persons, of whom the driver sat on a low stool, with his legs hanging on each side of the pole (Isa. xxii, 6; Ezek. xxiii, 24; see Xenoph. *Cyrop.* iv, 8, 1; ii, 22; Niebuhr, *Voyage*, ii, 105; Chardin, *Voyage*, vii, 257, pl. lix; Layard, *Nin. & Bab.* p. 447, 449; Olearius, *Travels*, p. 802). Chariots armed with scythes (*ἀμυρα δρεπανιφόρα*, Xen. *Anab.* i, 7, 10) may perhaps be intended by the "chariots of iron" of the Canaanites; they are mentioned as part of the equipment of Antiochus (2 Macc. xiii, 2), and of Darius (Diod. Sic. xvii, 58; Appian, *Syr.* 82). Xenophon mentions a Persian chariot with 4 poles and 8 horses (*Cyrop.* vi, 4). The Persian custom of sacrificing horses to the Sun (Xen. *Cyrop.* viii, 8, 12), seems to have led to offerings of chariots and horses for the same object among the Jewish monarchs who fell into idolatry (Ezek. viii, 17; 2 Kings xxii, 11; see P. della Valle, p. 256). See WAGON.

Not very different from the Persian chariot is one represented on a coin found at Babylon, but somewhat ruder; but the spokes of the wheels are eight, as in the Assyrian chariot. This coin has given occasion to much unsound speculation in the attempt to connect it with the history of Daniel. See BABYLON.

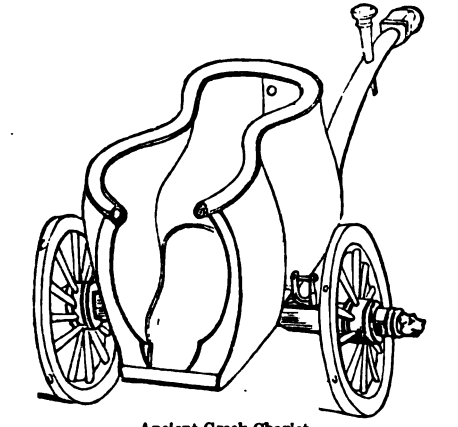

Ancient Greek Chariot

Among the Greeks and Romans, chariots were used at all times for purposes of war, and the chariot-races of the "Isthmian Games" were especially famous (see Smith's *Dict. of Class. Antiquity*, s. v. *Currus*). See CHARIOT-RACE.



Ancient Roman Chariot

Among the parts of wheel-carriages mentioned in the Scriptures are: 1, the wheel, *וְפָנִים* (*ophan'*, Exod. xiv, 25, etc.); also *גִּלְגָּל* (*gilgal'*, Isa. xxviii, 28) or

גִּלְגָּל (*galgal'*, Isa. v, 28; Ezek. x, 2, 6; xxiii, 24; xxvi, 10; id. Chald. Dan. vii, 9); 2, the rim, *גָּב* (*gab*, 1 Kings vii, 38; Ezek. i, 18); 3, the spokes, *רִשְׁרִים* (*chishakubim'*, 1 Kings vi, 38); 4, the hub, *רִשְׁרִים* (*chishakurim'*, 1 Kings vii, 38); 5, the axle, *יָד* (*yad'*, 1 Kings vii, 32, 33). To harness (yoke) the horses or other animals is designated by *אָסַר* (*asar'*, Gen. xli, 29; 1 Sam. vi, 7; 1 Kings xviii, 14), or *רָתַם* (*ratham'*, Mic. i, 18); also *רָכַב* (*rakab'*, Hos. x, 11), which properly signifies to ride or drive. See WHEEL.

The word chariots is sometimes used figuratively for hosts or armies (Psa. lxxviii, 17; 2 Kings vi, 17); and Elijah, by his prayers and counsels, and power with God, was "the chariot of Israel, and the horsemen thereof" (2 Kings ii, 12; see Rosh, *De curru Israelis*, Bautz, 1780), inasmuch as he did more for them than all the chariots they could muster (Psa. xx, 7; Isa. liii, 1).—Kitto, s. v.; Smith, s. v. See WAR.

The term "chariot" is likewise used poetically in Scripture to designate the rapid agencies of God in nature (Psa. civ, 8; lxxviii, 17; Isa. lxxvi, 15; Hab. iii, 8). See WEYMSS, *Symbol. Dict.* s. v.

CAPTAINS OF CHARIOTS (Exod. xv, 4) might be supposed to denote the officer or officers who had charge of the chariot forces, but the literal meaning is mounted third men (*שְׁלִישֵׁי הָעֲרֹבֹת*). This passage seems obscure, but a picture from an Egyptian tomb (the Ramesseum of Thebes), nearly or quite as ancient as the period to which the above-cited passage relates, furnishes a key to this otherwise difficult expression. It represents three men standing upon a chariot, two of whom are prepared for action, and the



Ancient Egyptian Chariot carrying three Warriors

third manages the horses (compare the large cut above of the Assyrian chariot). They were probably selected for their valor, and perhaps formed by themselves a distinct division of the army, and each had its distinct officer (Exod. xiv, 7). See CAPTAINS.

CHARIOT OF THE CHERUBIM probably means the frame-work on which the cherubim rested, and one pattern of which might resemble the body of a chariot (1 Chron. xxviii, 18). See CHERUB.

CHARIOT-CITIES, cities specially designated for storing the chariots of war during the time of peace, as magazines and arsenals of modern times are used (2 Chron. i, 14). See CITY.

CHARIOT-HORSES, such as were peculiarly fitted, by size, spirit, docility, or special training, for service in chariots, as carriage, draught, and saddle horses of later days (2 Kings vii, 14). See HORSE.

CHARIOT-MAN, the driver or charioteer, or perhaps an officer who had charge of the chariot (2 Chron. xviii, 38). See DRIVER.

CHARIOTS OF WAR (Exod. xiv, 7; 2 Sam. viii, 4). One class of carriages thus denominated were used as the common vehicles of princes and generals; but another formed the most terrible of military engines, and were employed in great numbers to break the enemy's battalions by rushing in among them (1 Sam. xiii, 5; 1 Chron. xviii, 4). Like other ancient carriages, they had usually only two wheels; and iron hooks or scythes, strong and sharp, were affixed to the extremities of the axles on each side, which made dreadful havoc among the troops (Joah. xi, 4; Judg. iv, 8, 18). War-

riors sometimes fought standing on them, or leaping from them upon the enemy. The chariots in the army of Cyrus were capacious enough to permit twenty men to fight from them. If we examine the sculptures of Egypt, we find that the strength of the armies of the Pharaohs was in their chariots, an Egyptian army being composed exclusively of infantry and bigas, or two-horsed chariots, which carry the driver and the warrior. In no instance is an Egyptian ever represented on horseback. Such palpable evidence that the Egyptians did not employ cavalry is difficult to reconcile with the Scripture account of the pursuit of the Israelites, which expressly speaks of "the horses and chariots of Pharaoh, and his horsemen" (Exod. xiv, 9). Hengstenberg, after a critical examination of the text, says, in his *Egypt and the Books of Moses* (p. 126), that "Moses does not mention cavalry at all; that, according to him, the Egyptian army is composed only of chariots of war, and that he therefore agrees in a wonderful manner with the native Egyptian monuments." See ARMY; CHARIOT.

CHARIOTS OF THE SUN. The ancient Persians who worshipped the sun dedicated to that luminary certain horses and chariots, which, in allusion to his rapid course, they consecrated to him. The kings of Judah fell into this peculiar idolatry. In these chariots, the Rabbins informs us, the king and nobles rode when they went forth to meet the morning sun. The idolatrous chariots of the sun were burnt by king Josiah (2 Kings xxiii, 11). See SUN.

In the narrative of the translation of Elijah (2 Kings ii, 11), it is said "there appeared a chariot of fire, and horses of fire," and a corrupt tradition of this miraculous ascension seems to have been preserved in the East. Mr. Roberts says, "The Hindoos believe their supreme god Siva sends his angels with a green chariot, to fetch the souls of those who are devoted to him; and there are occasionally horses, but at other times none. The holy king *Tirtu-Sangu* (divine chank) was taken to heaven, body and soul, without the pain of dying."

CHARIOT-RACE, the most renowned of all the exercises used in the Olympic games of the ancient Greeks and Romans, and those from which the victors were held to derive the greatest honor. There appear to be but one or two allusions to them in the New Testament, and these are involved in some uncertainty. In Cor. xvi, 9, the apostle refers to his great success in collecting a church at Ephesus: "But I will tarry at Ephesus until Pentecost, for a great door and effectual is opened unto me, and there are many adversaries;" alluding, it is thought, to the door of the circus, which was opened to admit the chariots when the races were to begin; and by the word *ἀντικείμενοι*, "adversaries," which Doddridge renders "opposers," he is supposed to mean antagonists or competitors. In Colos. iii, 15, he says, "Let the peace of God *rule* (*βραβεύω*, preside, as the arbiters or judges of the games) in your hearts;" 2 Thes. iii, 1, "that the word of the Lord may have free course (*ῥέχω*, run), and be glorified," referring, as it seems, to the applause of the spectators; 1 Tim. iv, 8, "Bodily *exercises* (*γυμνασία*, gymnastic discipline) profiteth little," alluding to the training of the racers; Heb. xii, 28, "the general assembly" (*πανήγυρις*, crowd of attendants). See GAME.

Charisma (*χάρισμα*), (1.) one of the names by which baptism was designated in the early Church; (2.) a spiritual gift. See GIFTS, SPIRITUAL.

Charity, one of the three chief Christian graces. The Greek word *ἀγάπη*, frequently rendered in the authorized version *love*, is occasionally translated *charity*, and is so rendered throughout 1 Cor. xiii. The old English word *charity* means *love*—love to God and man, which is the fulfilling of the law. Perhaps it would have been better had the word been rendered "love." The meaning of the term can, however,

scarcely be misapprehended after a careful perusal of that important chapter. In popular usage, charity is often restricted to *almsgiving*, which is only one of its manifestations. See LOVE. Christian ethics teach that charity, in this sense of love, is to be the habitual affection of the heart, in all our relations to our fellow-creatures. Charity considered, 1. As to its *source*, implies a regenerated state of mind. 2. As to its *existence*, shuts out all, 1, anger; 2, implacability; 3, revenge; 4, prejudice; 5, evil speaking; 6, petty aggressions, though legal; 7, artificial distinctions, as its limitations. 3. As to its *active expression*; (1) it delights in sympathy, liberality, and, in general, in benevolence; (2) it dictates and regulates *works of mercy*; (3) it teaches us that we are only *stewards* of the divine goodness.

"All spiritual gifts are surpassed by charity, which alone puts on them the crown of perfection (1 Cor. xiii, 81–xiii, 18). By this we are to understand not a mere inclination and emotion, however pure, or natural benevolence and philanthropy, however disinterested; but a disposition wrought by the Holy Ghost, springing from the consciousness of reconciliation; a vital supernatural energy, uniting all the powers of the soul with God, the essence of all love, and consecrating them to the service of his kingdom. Without this, even speaking with the tongues of angels were but 'sounding brass or a tinkling cymbal.' Without this, the boldest prophecy, the most comprehensive knowledge, and a power of faith which could call the impossible into being, have no abiding worth or practical importance. Without this, the other gifts would separate, pass into the service of ambition, and thus ruin themselves and the whole church. Without this, the gift of tongues fosters vanity and enthusiasm, knowledge puffs up (1 Cor. viii, 1–8), and the gift of government degenerates to despotism. As faith lies at the bottom of all the charisms, and forms their common root, so also love is properly not a gift by itself, but the soul of all gifts, binding them together like the members of a body, making them work in for each other, and directing them to the common good. It maintains the unity of the manifold divine powers, subordinates every thing individual and personal to the general, and makes it subservient to the interests of the body of Christ.

"For another reason, love transcends all the other gifts. It never ceases. In the future world the other gifts will disappear, at least in their present nature. The mysterious tongues will cease in the land, where all understand them. Prophecies will be lost in their fulfilment, like the aurora in the moon. Knowledge, which on earth is but partial, will merge in immediate, perfect intuition. Nay, faith itself will be exchanged for sight, and hope for fruition. But love, by which even here we have fellowship of life with God through Christ, remains love. It changes not. It rises not out of its element. It passes not into another sphere. It only deepens and expands. It can never gain higher grounds, never reach another and better form of union with God; but only continues to grow stronger, fuller, more lively, and more blissful (1 Cor. xiii, 8–18). 'Charity,' says Bishop Warburton somewhere, 'regulates and perfects all the other virtues, and is in itself in no want of a reformer.'

"Hence Paul exhorts the Corinthians, who were inclined to place an undue estimate on the more striking and showy charisms, to strive after charity, above all, as the greatest and most precious gift, the cardinal and universal Christian virtue, of which heathenism had scarce the faintest notion. 'Heathenism,' observes Oleshausen (*Comment.* iii, p. 698), 'did not get beyond *ἔρω*.' It knew nothing of the Christian *ἀγάπη*. In the Old Testament nothing but the stern *δικη* reigns. Eros, even in its purest, noblest form, is but the result of want, the longing for love, springing from the consciousness that we have not what is worth loving.

But the Christian *ἀγάπη* is the streaming forth of positive love, God himself dwelling in the believer, so that streams of living water flow out of him (John iv, 14). And he commends it, in the most glowing and attractive description ever uttered by tongue of man or angel, in language which comes to the heart with perpetual freshness, like music from the bowers of eternity, and is of itself enough to put beyond all doubt the divinity of Christianity and its infinite superiority to all other religions. 'And now (in the present earthly life of Christians) abideth faith, hope, charity, these three; but the greatest of these is charity' (Schaff, *Apostolic Church*, § 120). See also Watson, *Theol. Institutes*, pt. iii, ch. iv; Fellowes, *Body of Theology*, ii, 64, etc.; Barrow, *Works*, vol. i, ser. 27, 28; Fletcher, *Works* (N.Y. ed.), iii, 166 sq.

Charity, Brothers of (called, in Italy, *Fate ben fratelli*; in France, *Frères de la Charité*; in Spain, *Brothers of Hospitality*), a Romanist order, founded in 1540 at Seville, by the Portuguese Johannes a Deo, for nursing the sick and reforming immoral females. In 1572 Pope Pius V confirmed it, under the rule of St. Augustine, and it then limited itself to serving hospitals for the sick of all nations and religions. In 1580 it had a number of institutions in France, Italy, Germany, Poland, both Indies, and other countries. In 1617 it was received into the number of regular orders by adopting the solemn vows. In 1619 the brethren were exempted from the jurisdiction of the diocesan bishops, and in 1624 they received all the privileges of the mendicant orders. Among the hospitals of the order, those of Milan, Paris, Rome, Naples, Vienna, Prague, are especially celebrated. The number of houses amounts at present to over a hundred, in Italy, France, Spain, Austria, Prussia, Bavaria, and North and South America. See Helyot, *Ordres Religieux*, vol. ii; Fehr, *Geschichte der Mönchsorden*, ii, 80 sq.

Charity, Sisters of, called also **DAUGHTERS OF CHRISTIAN CHARITY** (*Sœurs or Filles de la Charité*), or, from their dress, **GRAY SISTERS** (*Sœurs grises*), a community of women in the Roman Catholic Church for nursing the poor and the sick, founded in 1629 at Châtillon, in France, by Vincent de Paul, aided by Madame Louise de Marillac le Gras. The rule which Vincent gave to his community was confirmed by the pope in 1668, whereupon the community spread so rapidly that by 1685 two hundred and twenty-four



Sister of Charity.

houses were established. Until the end of the eighteenth century they remained almost entirely confined to France, where their labors were interrupted by the Revolution. After a few years they were permitted to take them up again, and in 1807 they were placed under the protection of the mother of Napoleon. Since that time they have enjoyed the patronage of all French governments. In 1827 they nursed in France 145,000 sick persons and 120,000 children, which number has since considerably increased. Since 1815 they have rapidly established themselves in all states in which monastic orders are not forbidden. Several states, as Prussia and Baden, which exclude most of the monastic orders, have made an exception in favor of the Sisters of Charity. Since 1848 they have been

admitted into all the German states except Saxony. In all Germany they had, in 1868, establishments in 194 places, with about 2000 members. Spain promised to admit them in the Concordat of 1851. They established themselves in Portugal in 1857, but were there, as also in Brazil, severely attacked by the Liberal party, and mobbed by the populace. Large numbers of them were called to Russia by the government of Alexander II, and they have penetrated even into Denmark and Sweden. In Turkey they conduct several largely-attended schools. They are also found in many of the missions of Asia, Africa, and Australia, and in several of the states of Central and South America. In the United States they were established in 1809 by *Elizabeth Seton* (a convert from Protestantism), with a distinct rule, which is still followed in the dioceses of New York, Brooklyn, Newark, and Halifax. The houses in the other dioceses have abandoned Mrs. Seton's rule, and have united with the French order. In 1852 there were 88 houses under the charge of the sisters in different parts of the United States, and the number of sisters was 420. This number has since considerably increased. In the diocese of New York alone there are now about 250 sisters, having under their care, besides the parish schools in the city of New York, a hospital, a male and female asylum, and an industrial school. Their mother-house is at Fonthill, on the Hudson River, near Yonkers.

Numerous other communities of women have been established on the same plan, and on nearly the same rule. The most important among them is the congregation of St. Carolus Borromeus, so called because they chose Borromeo as their patron. Their mother-house is at Nancy, France; and in 1845 they counted 70 houses, with about 700 members. Another was founded in 1808 in Westphalia, by baron Droste zu Vischering, who became afterwards archbishop of Cologne. It counted, in 1858, 41 establishments, with about 200 sisters. The United States have also a number of similar institutions, as Sisters of Charity of Montreal, Sisters of Charity of Nazareth, Sisters of our Lady of Mercy, Sisters of Mercy, Sisters of Charity of the Blessed Virgin, Sisters of Charity of St. Augustine, most of which have been founded during the present century.

No monastic institution has spread since the beginning of the present century with equal rapidity, and the increase is still going on in nearly every part of the world. In 1862, the number of establishments, as far as known, was 1064; namely, 347 in Europe, 80 in America, 17 in Asia, 17 in Africa, and 8 in Australia and Oceania (P. Karl vom heil. Aloys, *Statist. Jahrbuch der Kirche*, Ratisbon, 1862). The number of members of the French order was estimated at 18,000, and that of all the Sisters of Charity at 28,000.

'Conscious that celibacy alone excites little admiration in modern times, Rome has sought, by her 'Sisters of Charity' and by her educational orders, to give her female aristocracy better claims on the gratitude of mankind. In England and America the female orders have attracted many to the Church of Rome, and softened many antipathies. The association of unmarried females for such purposes will ever have an attraction for romantic minds; yet the well-worked Protestant congregations in our cities send out more such sisters of charity and educators of the young than any of the sisterhoods of Rome. Without any bond but the law of love, and 'without observation,' because without the dress and separation of Rome's 'Sisters of Charity,' thousands now do the part of Priscilla or Dorcas, yet take part in all home duties and enjoyments, unconscious that they are better than others, or that they have attained a higher perfection than their fathers and mothers' (Lewis, *Bible, Missal, and Breviary*, i, 124). See also Fehr, *Geschichte der Mönchsorden*, ii, 828 sq.; Eremites, *Der Orden der barmherzigen Schwestern* (Schaffhausen, 1844); *Methodist Quarterly Review*, Jan. 1849, art. v.

Charlemagne (**CHARLES I, or the Great**), Emperor of the West, was born at Salzburg, in Bavaria, about 742, and, jointly with his brother Karloman, succeeded his father, Pepin-le-Bref, in 768. Karloman died in 771, and Charles became sole sovereign. By his wars against the Saxons, the Lombards, and the Saracens of Spain, he increased his empire until he was master of the best part of Europe. Pepin had granted the exarchate of Ravenna to the pope and his successors forever. After Pepin's death, Diedrich, the Lombard king, attacked the pope (Adrian I), who applied to Charlemagne for aid. He crossed the Alps (A.D. 774) with a formidable army, and terminated the contest between the bishops of Rome and the kings of Lombardy forever. The exarchate of Ravenna was overthrown, its vanquished prince was sent into France, and Charlemagne proclaimed himself king of the Lombards. The conqueror visited Rome, where it is said he not only confirmed the grants which Pepin had made to its bishops, but added to them new donations. By these acts he opened a way to the attainment of an object which Pepin had contemplated, but was unable to accomplish—he was enabled to gain the authority as well as to assume the title of Emperor of the West. In A.D. 800 he visited Rome, where Pope Leo III crowned him Emperor of the West, with the title of Carolus I, Cæsar Augustus. "Although this added

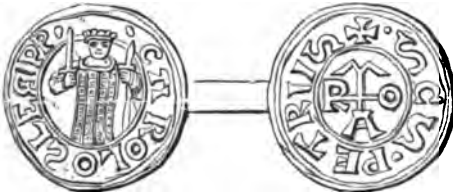

Denier of Charlemagne. Obverse: Figure of the Emperor, with the (Lat.) inscription, "Pope Leo to King Charles." Reverse: "St. Peter," and "Rome" in Monogram.

nothing directly to his power, yet it greatly confirmed and increased the respect entertained for him, such was still the lustre of a title with which were associated recollections of all the greatness of the Roman empire. Nicephorus I, emperor of Constantinople, also acknowledged him, and between them they fixed the limits of the Eastern and Western empires. A profound statesman and legislator, as well as a successful conqueror, he then devoted the remainder of his life to the internal improvement of his vast empire, and to the fortification of its frontiers against the invasions of the Normans and Danes. In 818 he named his third son, Louis (Louis le Débonnaire), his colleague in the empire, and died at Aix-la-Chapelle January 28, 814. "His last days, after the coronation of his son Louis, were occupied in correcting the text of the four Evangelists, in which he was assisted by Greeks and Syrians. Charlemagne had long shown a great zeal for religion; he never failed, while his health permitted, to attend divine service daily, morning and evening. He took great care that the service should be conducted with decorum and propriety, supplied his chapels with abundance of vestments and ornaments, and, being perfectly instructed in the best manner of reading and singing, he corrected the mode of performing both; but he himself never read publicly in church, but contented himself with singing in a low tone and with others. His alms were not only liberally bestowed in his own dominions, but on all the poor and distressed Christians in Syria, Egypt, Africa, Jerusalem, Alexandria, and Carthage; and he cultivated the friendship of unbelieving princes with a view to assuage the sufferings of the Christians under their dominion" (Palmer, *Church History*, ch. xv).

Charlemagne was throughout his reign the champion of Christianity. He never rested until the Saxons were not only subjected, but baptized, if not Christian-

ized; his war against the Lombards, whose kingdom he finally annexed, was originally commenced at the instance of the pope, whose power was menaced by the inroads of these barbarians. It cannot be denied, however, that Charlemagne propagated Christianity by the use of "carnal weapons." His "wholesale and indiscriminate mode of administering baptism on the conclusion of his campaigns drew forth the indignant expostulations of Alcuin and men of a kindred spirit" (Mac Lear, *Missions in the Mid. Ages*, p. 449). "He did not confine his benefactions to the bishop of Rome, but distributed them among all the orders of the hierarchy. He augmented their wealth, he enlarged their privileges, he exalted their dignity, he confirmed and extended their immunities. But the motives of his liberality were such as became a magnanimous and a benevolent monarch. Superstition has never been accounted among them, nor any unfounded fears or undue reverence of the ecclesiastical order; from the former he was perhaps more nearly exempt than would have appeared possible in so rude an age; and in his transactions with the clergy, even with the pope himself, he never forgot, or allowed them to forget, his own supremacy. But he was desirous to civilize his barbarous subjects: he was anxious to influence their rude manners, and correct their vicious morals, by the more general diffusion and comprehension of the Christian truths; and he was willing also to sow the seeds of secular learning, and dispel the ignorance which oppressed his people" (Waddington, *Church History*, ch. v.). As a statesman he favored the Church because he considered it a school for the improvement of his people, and, while adding to the temporal power of the Church, was careful not to render it independent. He decided against image-worship, and in his *Libri Carolini* (A.D. 790, Elias Phillyra, 1549; Heumann, Han. 1781), he set forth (in opposition to the decision of the second Synod of Nicea of A.D. 787), that "God could be worshipped only in spirit," and his opinions were indorsed by the Synods of Frankfort (794) and of Paris (825), censuring Adrian's treatise in favor of image-worship. But, while Charlemagne condemned image-worship as idolatry, the Caroline books approve of the crucifix, and of reverence to the relics of saints, etc.—Hase, *Ch. History* (N. Y. ed.), p. 178; Chambers, *Encyclopædia*, s. v.; Herzog, *Real-Encyclopædie*, vii, 879 sq.; Gibbon, *Decline and Fall*, ch. xlix; Neander, *Church History*, iii, 285 sq.; *Studien u. Kritiken*, 1855, Heft 2; Dippold, *Leben Kaiser Karl des Grossen* (Tüb. 1810); Gaillard, *Hist. de Charlemagne* (Par. 1819, 2d ed. 4 vols.); Abel, *Jahrbücher des fränk. Reiches unter Karl dem Grossen* (Berlin, 1866, vol. i). See CAROLINE BOOKS.

Charles V, emperor of Germany and king of Spain (under the title of *Dow Carlos I*), eldest son of Philip, archduke of Austria, and Joanna, second daughter of Ferdinand and Isabella of Spain, was born at Ghent, Feb. 24th, 1500, and died at the monastery of San Yuste, near Placencia, in Estramadura, Spain, Sept. 21st, 1558. His father died when he was only six years of age, and his grandfather Maximilian became his guardian, and placed him under the care of William de Croy, lord of Chièvres, as governor, and Adrian of Utrecht, afterwards Pope Adrian VI, as preceptor.

On the death of his grandfather Ferdinand, Charles, conjointly with his mother, was acknowledged as his successor, and visited Spain in 1517, where the conduct of his Flemish ministers gave rise to serious troubles. In the year 1519 his grandfather Maximilian died, and Charles became a competitor for the imperial crown. Through the efforts of Frederick the Wise, elector of Saxony and regent of the empire, he was chosen over Francis I of France, his principal rival, June 28th, 1519. This contest ripened the jealousy between these young and ambitious sovereigns into an enmity which gave rise to four wars, and ended only with the death of Francis.

Charles was crowned emperor with great pomp at Aix-la-Chapelle, Oct. 22, 1520. His first act was to issue a call for convoking a diet at Worms early the next year, especially to consider the means of suppressing the new religious ideas awakened by the teachings of Luther. This assembly was held April 17-26, 1521, and thither Luther repaired under a safe-conduct, and plead his cause; but an edict of outlawry was pronounced against him. See WORMS. The prudent action of his patron, Frederick of Saxony, in having him taken to the Wartburg, and the almost sovereign power of the German princes, saved the reformer and his cause from the impending danger; while the wars with France, 1521-6 and 1527-9 forced Charles to "leave the conduct of German affairs to the established authorities, who were not opposed to a reform of the Church, and who, instead of executing the edict of Worms, persisted in the demand for a general council 'to be held in a German city.'" At the Diet of Spire, 1526, a decree was signed by Charles's brother, Ferdinand, as his representative, which left to each state of Germany the right to regulate its religious affairs, which decree, according to Ranke, was the basis of the legal existence of Protestantism in Germany. At a second diet at Spire, in March, 1529, the Roman Catholic party, emboldened by the more favorable aspect of Charles's affairs abroad, sought to prevent the further progress of the Reformation by a decree "that the Church should remain in statu quo until the convocation of a council." This led to the celebrated *Protest* of the Lutheran princes, April 19, 1529, from which the name Protestant arose. This protest was not favorably received by Charles; but the fear of the Turks, who had laid siege to Vienna, compelled moderation on his part until their retreat, when the subject again came up at the Diet of Augsburg (1530). In accordance with the promise of Charles that each party should lay before this diet a statement in Latin and German of their opinions, the Reformers presented the *Augsburg Confession* (q. v.), drawn up by Melancthon, which was read June 25th, and produced so powerful an impression that many Roman Catholic princes inclined to a milder judgment of the new faith.

No statement was presented by the other party, but the emperor caused a refutation of the Lutheran Confession to be prepared, to which the Protestants replied in the *Apologia Confessionis*, also from the pen of Melancthon; but this failed to change the purpose of Charles, who, influenced by Campeggio, the papal legate, issued a decree, Nov. 19, 1530, condemning the Confession, and requiring its adherents to submit unconditionally, until a future general council, and to be reconciled to the Roman Catholic Church within seven months. The design of the emperor to force submission to his will in matters of religion was now evident, and, to protect themselves, the Protestant princes and states formed the "League of Smalcald," Feb. 27, 1531, and made treaties with France, England, and Denmark. Confronted by so formidable a coalition, and threatened with a new invasion of Austria by the Turks under Solymán, Charles was forced to grant the "Truce of Nuremberg," July 23, 1532, by which liberty of conscience was allowed until the assembling of a council.

The constant pressure of foreign enterprises, and the necessity of conciliation within the empire, to ward off outward dangers, postponed for some years the armed conflict between Charles and his Protestant subjects; and at the Diet of Spire, 1544, considerable concessions were made to them in order to secure their hearty support against the French. But when the war was ended, the Protestants saw plainly that Charles purposed to compel their submission to the decrees of the Council of Trent, then assembled by Paul III, and they prepared to defend their religious liberties by arms. Owing to the lack of energy and decision on the part of their leaders, and the skill of Maurice of Saxony,

who took the side of Charles, they failed of success, and were totally defeated at Mühlberg.

Shortly before this, the death of Francis and Henry VIII had freed Charles from his most powerful external foes, and he might now hope, aided by the pope and the new order of the Jesuits, to compel religious unity in Germany. Accordingly, he convoked a diet at Augsburg with this view; but after he had with great difficulty induced the Protestants to accept conditionally the Council of Trent, the pope removed the council to Bologna, and would neither change the place nor make any concessions to the Protestants. This so irritated Charles that he caused a declaration to be drawn up by Pflug, Holding, and Agricola, called the *Interim* (q. v.), to serve as a rule of faith and practice until a free and general council—a plan which pleased neither party. But Charles was now too powerful for open resistance. Maurice of Saxony, however, began to form schemes for humbling him, and so well did he conceal his purposes, that he was even appointed to the command of the army intended to compel the refractory city of Magdeburg to receive the *Interim*. Having formed alliances with France and other powers, and provided for the support of his army, Maurice openly declared against Charles in March, 1552, and by his rapid and successful movements extorted from the emperor the treaty of Passau, Aug. 2, 1552, by which, together with the release of the captive princes, complete religious liberty was granted to the Protestants—terms subsequently confirmed by the *Recess or Religious Peace of Augsburg*, Sept. 21, 1555.

The star of Charles had now passed its zenith. The consuming cares of a life devoted to exciting and ambitious schemes, and the uncontrolled indulgence of an excessive appetite, not to say gluttony, had left their impress in failing powers and tormenting disease; and now that he saw his cherished hope of universal monarchy and an imperial throne for his son fading away, baffled and disappointed by Fortune, which he peevishly described as a woman who smiled on his youth, but forsook him in his age, he determined to throw off the prerogatives and responsibilities of power, and seek in retirement ease of mind and body. Accordingly, Oct. 25th, 1555, before an assembly of the estates of the Netherlands, convened at Brussels for that purpose, he resigned the crown of those provinces, and, Jan. 15, 1556, at the same place, in the presence of the *grandees* of Spain, the crown of Spain to his son Philip II; and on August 27, 1556, also the imperial crown, in favor of his brother Ferdinand. He set out, Sept. 17th, 1556, for his chosen retreat, the Hieronymite monastery of San Yuste, where, by his orders, separate buildings had been erected for himself and the few servants who accompanied him. Here he remained until his death, occupied in religious exercises, gardening, and mechanical experiments, without, as recent researches show, losing sight of the political and religious movements of the outer world.

He is described as possessing dignity and elegance of manner, slow in resolving, but prompt to execute, patient of every hardship but hunger, firm and self-possessed in danger, but without the warmth of genius or that noble directness of character which subordinates selfish aims to the higher claims of humanity and right. Though amiable in private life, his inhuman persecution of his Protestant subjects in the Netherlands, and his testamentary directions to his son, evince the feelings of a bigot and a tyrant; while his course towards the Reformation in Germany proves how readily his secret preferences were made to yield to the promptings of policy, when the furtherance of his ambitious plans demanded a show of moderation in dealing with the newly-awakened desire of the age for religious reform.—Herzog, *Real-Encyclopädie*, vii, 379 sq.; Hofer, *Nov. Biog. Générale*, ix, 269; Heine, *Briefe an Karl V. geschrieben von s. Beichtvater* (Berlin, 1848, 8vo); Sleidan, *De statu religionis, etc. Carolo V*

Cæsare commentarii (Frankf. 1786, 8 vols. 8vo); Ranke, *History of the Reformation*; Prescott, *History of Philip II*; Ranke, *History of the Papacy* (2 vols. 8vo, 1851); Motley, *The Rise of the Dutch Republic* (8 vols. 8vo, N. Y. 1857); Sismondi, *Histoire des Français*, 18 vols. 8vo (Bruxelles, 1849; see index in 18th vol.); Robertson, *History of the Reign of Charles V*; Lanz, *Correspondens des Kaisers Karl V* (Leipz. 1844-46, 8 vols.); Kervyn de Lettenhove, *Aufsichungen des Kaisers Karl V* (German transl. Leipz. 1862); Gachard, *Correspond. de Charles Quint* (Brussels, 1859). Special works on the life of Charles V after his abdication and retirement have been written by Stirling (*Cloister Life of the Emperor Charles the Fifth*, N. Y. 12mo), Gachard (*Retrait et Mort de Ch. V* (Brussels, 1854-55)), Pichot (*Chronique de Charles V*, Paris, 1854), and Migne (*Charles Quint*, Paris, 1854).

Charles IX., second son of Henry II and of Catharine de Medici, was born at St. Germain-en-Laye June 27, 1550, and on December 5, 1560, succeeded his brother, Francis II. "His character was a compound of passion, acuteness, heartlessness, and cunning. Although only twenty-four years of age when he died, so well had his detestable mother trained him to a love of perfidy and cruelty, that he found time, with her assistance and that of the Guises, to perpetrate an act so hideously diabolical that all civilized Europe still shudders at the recollection. The massacre of St. Bartholomew's (q. v.), Aug. 24, 1572, was the culmination of a series of treacheries toward the Huguenots which disgraced his reign. The result was that civil war broke out anew, and assumed a very threatening character, as political malcontents associated themselves with the Protestants. Charles died May 30, 1574."—Chambers, *Encyclopædia*, s. v.; and a good article, with an account of the massacre of St. B., in the *English Cyclopædia*, s. v. Charles IX. See FRANCE, REFORMED CHURCH OF.

Charleton, Walter, M.D., an English physician, was born Feb. 2, 1619, was educated at Magdalen Hall, Oxford, became an eminent practitioner in London, president of the College of Physicians in 1689, and died in 1707. He is mentioned here on account of his *Darkness of Atheism dispelled by the Light of Nature* (Lond. 1652, 4to), and *Harmony of Natural and Positive Divine Laws* (Lond. 1680, 8vo).—Darling, *Cyclopædia Bibliographica*, l, 637; Kippis, *Biographia Britannica*, iii, 448 sq.

Charm (שַׁחַשׁ, *lachash'*, to whisper, as enchanters). In Psa. lviii, 5; Jer. viii, 17; Eccles. x, 11 ("enchantment"), this word is used to express *serpent-charming*. In the first of these passages it occurs in connection with שַׁחַשׁ (she'ber, strictly a confederacy, i. e. with spirits of the other world), which is rendered in the same manner, and has a similar meaning. In other passages, although still rendered "charm," both words, as is the case also with other terms, signify ordinary *necromancy* or *conjuración*. That the most venomous reptiles might be rendered tame and harmless by certain charms, or soft and sweet sounds, and trained to delight in music, was an opinion which prevailed very early and universally (see Bochart, *Hieros.* I, iii, cap. 6). Virgil speaks of it particularly (*Æn.* vii, 750); so also Lucan (*Pharsalia*). See SERPENT. The most famous serpent-charmers of antiquity were the *Paylii*, a people of Cyrenaica; and that theirs was believed to be a natural power appears from the story told by Pliny, that they were accustomed to try the legitimacy of their new-born children by exposing them to the most cruel and venomous serpents, which dared not molest or even approach them unless they were illegitimate. He thinks their power resided in some peculiar odor in their persons which the serpents abhorred (*Nat. Hist.* lib. vii, c. 2). Shaw, Bruce, and indeed all travellers who have been in the Levant, speak of the charming of serpents as a thing frequent-

ly seen (see especially Thomson, *Land and Book*, ii, 216, 238). The much-dreaded *Cobra di Capello*, or *good Serpent* of the Hindoos, is capable of being tamed; and the Malabar jugglers have the art of teaching them to dance to the inharmonious and slow notes of their flageolet. The serpent first seems astonished, then begins to rear himself, and sometimes, by a gentle undulatory motion of the head, and with distended hood, seems to listen with pleasure to the notes. These dancing snakes are carried about in baskets by the jugglers all over India, and Mr. Forbes states it as a well-attested fact that when a house is infested with these snakes, and some others of the *Coleber* genus, which destroy poultry, or with some even of the larger serpents of the boa tribe, the musicians are sent for, who charm the reptiles from their hiding-places to their own destruction (*Oriental Memoirs*). It is often said that the charmer introduces his tame serpents, and that they obey the accustomed call, and are exhibited in proof of the triumph of the charmer's art. This may sometimes be the case, but instances are known in which there could not have been any collusion or contrivance; and, after the severest test and scrutiny, many have been obliged to rest in the conclusion that the charmers do really possess the physical means of discovering the presence of serpents without seeing them, and of attracting them from their lurking-places. This is Mr. Lane's conclusion, who also suspects that they discover the presence of serpents by the smell, and compares their attractive powers to those of the fowler, who, by the fascination of his voice, allures the bird into his net (*Modern Egyptians*). The deaf-adder or asp may either be a serpent of a species naturally deaf (for such kinds are mentioned by Avicenna as quoted by Bochart), or on account of its appearing to be so. In either case, in the language of poetry, it may be said to *stop its ear*, from its being proof against all the efforts of the charmer (*Un. Presb. Quart. Review*, July, 1860). See DIVINATION; MAGICIAN.

In modern usage the word *charm* (Lat. *carmen*, a song) denotes a spell, in a form of words, generally in verse, supposed to possess, when recited, some occult power, either hurtful or beneficial. When written on paper or parchment, and worn on the person, charms are to be classed with amulets (q. v.). See also INCANTATION; MAGIC.

Char'mis (Χαρμῖς v. r. Χαλμῖς; Vulg. *Charmi*). son of Melchiel, one of the three "ancients" (πρεσβύτεροι) or "rulers" (ἀρχωντες) of Bethulia (Judith vi, 18; viii, 10; x, 6). See BETHULIA.

Charnel-house (med. Lat. *caruarium*), a place in the neighborhood of a church-yard or other cemetery, usually vaulted, where the dry bones of the dead, which the grave-digger had thrown up, were carefully laid in order. Afterwards a chapel was built over it, wherein interment could be made, monuments erected, and masses (see CHANTRY) be sung. In this case the "charnel-house" was a vault under the chapel. The chapels of cathedrals sometimes had such charnel-houses under them.

Charnock, Stephen, D.D., an eminent English Nonconformist, was born in London in 1628. He received his earliest education from his father, and when very young he entered Emanuel College, Cambridge, under Dr. William Sancroft. He commenced his labors as a minister in Southwark, but soon obtained a fellowship in New College, Oxford, and in 1652 became senior proctor of the university. In 1663 he went to Dublin, and his ministry there was eminently successful. About 1660, ejected by the Act of Uniformity, he returned to England, and spent fifteen years in and about London in study and preaching, but without a settled congregation until about 1675. He died July 26, 1680. "His sermons constitute the chief of his works; and while on the *doctrines* they contain, being

decidedly Calvinistic, a variety of opinions are entertained, yet it is universally admitted that they are distinguished by great originality and genius, and are well deserving of the widely-spread attention they have so long received. His reasonings are nervous and his appeals affecting. His judgment was sound, his taste correct, his imagination lively, his piety undissembled. He was grave without being dull, and perspicuous without being wearisome. His *Treatise on the Attributes of God* is acknowledged to be the best in the English language" (Jones). His *Works* were republished in 1815 (Lond. 9 vols. 8vo), with a life prefixed, by Edward Parsons. There is an American edition of the *Attributes*, with a life of Charneck, by Symington (N. Y. 2 vols. 8vo), and a new edition of his *Works* is now going on at Edinburgh (Nichols), 1866, vols. 1-v, 8vo. See Jones, *Christian Biography*, p. 106; Symington, *Choice Works of Charneck, with his Life* (N. Y. 12mo); Middleton, *Eccles. Biography*, iii, 448; Calamy, *Non-conformist's Memorial* (Lond. 1778), i, 159 sq.

Char'ran (Χαρράν), another mode (Acts vii, 2, 4) of Anglicizing the name HARAN (q. v.).

Charter-house (a corruption of *Chartreuse*, i. e. Carthusian house) is a hospital, chapel, and school-house in London, established in 1611 by Sir Thomas Sutton. It had originally been a Carthusian monastery, but after the dissolution of monastic establishments by Henry VIII it fell into various hands, and was finally purchased from Lord Suffolk by Sir Thomas Sutton for £18,000, who endowed it with the revenues of upward of 20 manors, lordships, and other estates in various parts of England. This "masterpiece of Protestant English charity," as old Fuller calls it, serves three uses—it is an asylum for poor brethren, an educational, and a religious institution; hence Bacon terms it a "triple good." The Charter-house school is memorable as the place where Barrow, Addison, and John Wesley received their early education. — Chambers, *Encyclopædia*, s. v.

Charitom. See MAGICIAN.

Charthophylax. See CERMELIARCHE.

Chartreux. See CARTHUSIANS.

Chartan. See KERNELS.

Charul. See NETTLE.

Chase (ציד, רִדָּה, δῶκω, etc.). The practice of hunting wild animals early prevailed among the nomade Hebrews (Gen. xxv, 28; xxvii, 8 sq.), and continued to later times to be a common employment (Lev. xvii, 18; Prov. xii, 27; Josephus, *War*, i, 21, 18), both for the sake of the flesh of the game (Sirach xxxvi, 21; but in the Sabbatical year it was allowed to multiply, Exod. xxiii, 11; Lev. xxv, 7; comp. Michaelis, *Mus. Recht*, iii, 178 sq.), and also for the extermination of noxious beasts (2 Sam. xxiii, 20), of both which there was no lack in Palestine (see Harmar, i, 828 sq.). The means employed in this pursuit were usually the bow (Gen. xxvii, 8), the spear or javelin (comp. Strabo, xv, 784), the net (רֶשֶׁת, מַקְמָר, מְצוּר; which was likewise used for the larger kinds of animals, as gazelles, Isa. li, 21, and even for lions, Ezek. xix, 8), the sling (צָמִים, שֶׁשׁ, מוֹקֵשׁ, Eccles. ix, 12; Psa. xci, 8), and the pitfall (שְׁחָר, שְׁחָר, Plin. x, 54; comp. Ezek. xix, 4; 2 Sam. xxiii, 20), the last especially for the

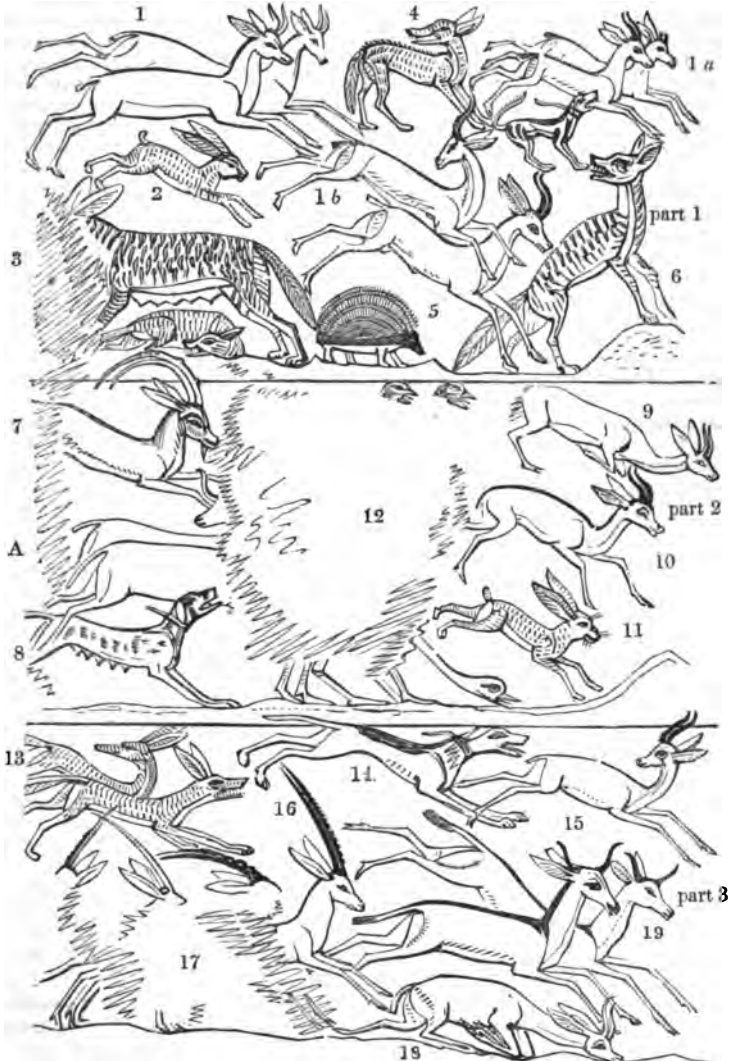

Ancient Chase in the Desert of Thebaid (Wilkinson).

To the left of A was the chasseur in his chariot shooting with the bow, *non defaec.* Figs. 1, 2, 15, 18. Gazelles. 2, 11. Hares. 8. Female hyena with its young. 4, 18. Foxes. 5. Porcupine. 6. Hyena arrived at the top of a hill and looking towards the chasseur. 7. The ibex. 8, 14. Hounds. 13. Ostriches (*defaec.*). 16. The ox. 19. Wild oxen.

lion (Shaw, *Trav.* 152 sq.). Compare the description in Job xviii, 8 sq. They do not appear to have had hunting dogs (yet comp. *Joseph. Ant.* iv, 8, 9), and it is doubtful if in hunting birds they used trained falcons or other species of birds (*Eliau, Anim.* viii, 24), although hawks (*Harmar*, iii, 79), like hounds (*Odyss.* xix, 438; *Strabo*, v, 215; *Philostr. Icon.* i, 28; *Polyb.* xxxi, 22; *Curt.* ix, 1, 31; *Plin.* viii, 61; *Becker, Charicles*, i, 389) were anciently, and still are universally common in the East (*Shaw, Travels*, p. 300; *Kampfer, Amoen.* p. 131). On the Egyptian monuments hunting scenes are frequently represented (*Wilkinson*, i, 212 sq.). Hunting became an aristocratic sport (*Meurs. ad Lycophr.* 499) at least in later periods of Jewish history (*Josephus, Ant.* xv, 7, 7; xvi, 10, 3; see also *Philo*, ii, 356; comp. *Heindorf* on *Horace, Sat.* ii, 2, 9). Instances occur in which men of strength overcame wild animals even without weapons (*Judg.* xiv, 6; 1 *Sam.* xvii, 85). (See *Jahn's Bibl. Archaeol.* § 52.)—*Winer*, i, 590. See NIMROD.

The instruments and modes of the chase are sometimes used figuratively, to indicate the wiles of an adversary, great danger, or impending destruction (*Psa.* ix, 16; lvii, 6; xcl, 3; xciv, 13; cxix, 85; *Prov.* xxvi, 27; *Isa.* xxiv, 17; xliii, 22; *Jer.* v, 26; vi, 21; xvi, 16; xviii, 22; xlviii, 44; *Amos* iii, 5; *Hos.* xiii, 14; *Luke* xxi, 85; *Rom.* xi, 9; 1 *Cor.* xv, 55). See HUNTING.

Chase, Abner, a minister of the Methodist Episcopal Church, was born in Stonington, Conn., Dec. 11, 1784, and died in Penn Yan, N. Y., April 27, 1854. At the age of 19 he was converted, and joined the Methodist Episcopal Church. When 22 years of age he was licensed to exhort, and soon after received license to preach. He continued as an exhorter and local preacher about six years, laboring very successfully in winning souls to Christ. In 1810 he was admitted on trial in the N. Y. Conference, and appointed to the Delaware Circuit. The next year, at his own request, he was transferred to the Genesee Conference, in whose ranks he remained, part of the time as superannuated, until his death. Very few men have served the Church more faithfully, acceptably, and usefully.—*Minutes of Conf.* v, 419; *Sprague, Annals*, vii, 497.

Chase, Henry, a minister of the Methodist Episcopal Church, was born in Hoosick, N. Y., Sept. 10, 1790. His father being unable to send him to a classical school, he began, unaided, in youth a course of study which ended only with his life, and which included Latin, Greek, Hebrew, French, and German, besides general literature and theology. In 1809 he entered the Methodist ministry, and served in several laborious circuits until 1820, when he removed to New York, and became a teacher in the Wesleyan Seminary. In 1828 he devoted himself to the service of the seamen of New York, and continued, with short interruptions, to be pastor of "The Mariners' Church" until his death, July 8, 1858. He was greatly beloved and esteemed both by his own flock and by the general public.—*Sprague, Annals*, vii, 478.

Chase, Philander, D.D., a bishop of the Protestant Episcopal Church, was born at Cornish, N. H., Dec. 14th, 1775, and graduated at Dartmouth College in 1795. After ordination, he was occupied for about a year and a half as a missionary in the State of New York, extending his services to Utica, Auburn, Canandaigua, and other places. In 1799 he accepted the charge of the Protestant Episcopal churches at Poughkeepsie and Fishkill. He was next appointed to Christ Church, New Orleans, but returned to New England in 1811 to become rector of Christ Church, Hartford, "where he labored with great assiduity, acceptance, and success." His thoughts, however, were directed to the "Great West," and in 1817 he journeyed thither, preaching as he advanced. In May, 1817, he presided at the first meeting of the parishioners of

Christ Church, Cincinnati, and became rector at Worthington, Columbus, and Delaware, and accepted also the charge of an academy. In 1819 he was elected bishop of Ohio; in 1821 he became President of Cincinnati College. Desiring to supply the West with an efficient ministry, he visited England, and received large contributions for education. About 1826 he engaged in the foundation of Kenyon College and the Theological Seminary of Ohio. This assiduity and energy were, however, ill rewarded, for "a stand was taken by the professors of Kenyon College as to the extent of his powers over the institution of which he was the originator; and on the same day, in September, 1831, with his usual magnanimity, he resigned his offices of president and bishop of Ohio." Being now in search of temporary repose, he selected as his residence a place in Illinois, which he named "The Valley of Peace," engaged here, and on the St. Joseph, Michigan, in missionary labors, and planning for himself a wide circle of visitation, which "invaded no man's diocese, parish, or labors." In 1835 he was elected bishop of Illinois, and used similar expedients for the interests of his diocese as those which he had before adopted for Ohio. He again visited England, and collected nearly \$10,000 for this purpose. In 1838 he laid the foundation of Jubilee College, and shortly after visited Mississippi, Louisiana, Georgia, and South Carolina, where he received liberal contributions. His colleges were subsequently better endowed, and his own circumstances rendered easy, if not comfortable; and thus, towards his latter end, "the smiles of Providence beamed on his broad philanthropy and indomitable perseverance." He died Sept. 20th, 1852. His published works are: *A Plea for the West* (1826); *The Star in the West, or Kenyon College* (1828); *Defence of Kenyon College, Ohio* (1831); *Reminiscences: An Autobiography, comprising a History of the principal Events in the Author's Life to 1847* (1848, 2 vols. 8vo).—*Sprague, Annals*, v, 453; *Bp. Chase's Reminiscences, an Autobiography to A.D. 1847* (2 vols. 8vo, Boston, 1848).

Chase, Squire, a Methodist Episcopal minister and missionary. He was born in Scipio, Cayuga Co., New York, February 15, 1802; was converted at about fourteen; entered the travelling ministry in the Genesee Conference in 1822; was set off with the Black River Conference at its organization in 1826; sailed as missionary to Liberia, Oct. 15, 1836; returned to America in August, 1837; was delegate to General Conference in 1840; sailed again to Africa in January, 1842; returned to America in May, 1843; and died at Syracuse, N. Y., July 26, 1848. Mr. Chase was of prepossessing appearance, natural amiability, and unaffected piety. In the pulpit his "commanding figure and earnest manner gave him great advantage over his audience, and his sermons bespoke a cultivated mind and diligent preparation." He was a good scientific and classical scholar, and a vigorous writer. As presiding elder he was eminently efficient. In 1840 he published *An Examination of the Doctrine, History, and Moral Tendency of Roman Catholic Indulgences*.—*Black River Conference Memorial*, p. 50; *Sprague, Annals*, vii, 664.

Chas'eba (Χασεβά, *Vulg. Casaba*), a name among the list of the "servants of the Temple" (1 *Esd.* v, 81), which has nothing corresponding to it in *Ezra* (ii, 48) or *Nehemiah* (vii, 50), and is probably a mere corruption of that succeeding it—GAZERA (q. v.).

Chashmal. See AMBER.

Chasible. See CHASUBLE.

Chasidah. See STORK.

Chasidim (חסידים, i. e. *saints*; comp. *'Asoadaio*, 1 *Macc.* vii, 13), a name which among the ancient Jews was given to all who manifested their attachment to the Jewish creed in some extraordinary manner. In

a more special sense it was given to a sect which was organized for the purpose of opposing Hellenistic innovations, and uniting the true believers by voluntary imposition of works of supererogation. In the time of Judas Maccabeus the sect readily joined the great leader of the true Jewish faith. The essential principles of the Chasidim were as follows: most rigidly to observe all the ritual laws of purification; to meet together frequently for devotion, carefully preparing themselves for it by ablutions, and wearing their phylacteries longer than others; to seek diligently for opportunities of offering sacrifices (*Nedarim*, 10, a); to impose upon themselves voluntarily great acts of self-denial and mortification; to abstain from wine and all intoxicating liquors sometimes for several weeks, and sometimes for their whole lives; and to observe, like the priests, the Levitical purifications during the time of their being Nazarites, and sometimes longer. It also appears from the Mishna that they frequently had all things in common (*Abot*, v, 10); that they sometimes withdrew altogether from general society, and devoted themselves entirely to contemplation, and to the study of the written and oral law, while others of the sect, by pursuing secular avocations, procured the common means of support; that they would not talk much to their own wives, and would not at all look at strange women. The Mishna states (*Sota*, iii, 7) that these principles were carried by some to extravagant excesses. In the course of time the association was split up into parties, those insisting upon the rigid observances forming themselves into separate denominations, such as the Essenes, etc., while the moderate party retained the name Chasidim. In the Talmudic period (A.D. 200-500) the meaning of Chasidim was on the whole again that of the word in the Old Testament, denoting those who are pious, temperate, mild, forbearing, benevolent, etc. There were, however, occasionally zealots among them who would not, for instance, extinguish a fire which broke out on the Sabbath; but they were an exception. In the post-Talmudic period, and in the Middle Ages, the philosophical school appears to have understood by the term those who possessed simple piety in contradistinction to scientific knowledge. The Karaites claimed the name for those who earnestly strove to know God as he is, and only gave it to their spiritual heads. The German and French schools also fixed so high a standard for the qualifications of a Chasid that few except the Rabbins could attain it. In these schools it somewhat approaches the asceticism of the old sect, and still more was this the case in the Cabalistic school representing the Sohar, in which a rigorous observance of externals and mortifications is insisted upon.

The Chasidim were reorganized as a special sect in the eighteenth century by Rabbi Israel ben-Eliezer Baal-Shem (בַּעַל שֵׁם טוֹב, "lord of the name"=*Σουφργος*, a man who by words of conjuration and other formulas knows how to exercise a power over the visible and invisible world), also called *Besht*, בעש"ט, from the initials of שם טוב. Baal-Shem made his public appearance about 1740 in Tlusti, in the district of Czarkow, from whence he subsequently removed to Medzibozhe, in Podolia. His miraculous cures and prophecies attracted attention in large circles; his mode of life, consisting of contemplation, study of the book Sohar, giving advice to all applying for it, and frequent washings in rivers, soon spread a halo round him, while his liberal views on the gratification of sensual wants, which he declared to be more conducive than prejudicial to true godliness, disposed a large number to become his disciples. To promote the separate organization of a sect, his disciples circulated many miraculous reports; for instance, that his father had been visited by the prophet Elijah, to predict his birth, and that his mother was a hundred years old when she was delivered of him; that, when a youth, he had vic-

toriously struggled with evil spirits, etc.—all of which may be found in the book שְׁבוּת חַסְדֵי שֵׁם טוֹב, published in 1815 by the grandson of Baal-Shem, R. Bär Linz. Baal-Shem and his successors received the name Zadik (צַדִּיק, i. e. *righteous*), and his fame attracted multitudes of Jews from all parts of Poland, who were desirous to submit themselves to his guidance, and become members of the sect. The following are the chief principles and tenets of the sect: 1. The great aim of every Chasid is to be in intimate communion with (דְּבַקוּת), or wedded to the Deity (שְׂכִיבָה), who is regarded as a bride. This communion is effected through prayer, and more especially through frequent contact with the Zadik, or spiritual head, who is espoused to God, and who, as his delegate upon earth, can do all manner of wonderful things. The Zadik is therefore the king and supreme judge of the community; has absolute power over their thoughts, words, and deeds; is richly supported by the voluntary contributions of his followers; they perform pilgrimages to him to spend the Sabbaths and festivals with him, when the rich sit with him at the table, and the poor esteem it the greatest privilege to touch the hem of his garment, or even to catch a glimpse of him. 2. Revelation and the reward of all good works depend upon *absolute faith*, which is greatly interfered with by research and philosophy. 3. Miracles must be implicitly believed in; the greatest devotion is to be manifested during prayer, and hence shouting, clapping of hands, singing, dancing before the Lord, etc., must be resorted to, so as to preclude the intrusion of profane thoughts. 4. Repentance and conversion are essential to salvation; a man must always prepare himself for them, and never despair. 5. The Chasid must keep aloof from profane knowledge, and from the love of mammon, which leads to unbelief, but worship God, even in the performance of business. 6. He must be exceedingly cheerful, contented, unselfish, benevolent, peaceable, charitable in judging others, courageous, temperate in his dress and mode of living, etc. In every town or village where ten Chasidim are to be found, they must meet separately for prayer and meditation, and use the Spanish form of prayer, introducing into it the Cabalistic elements.

The Chasidim derive their doctrines from the Bible, the Talmud, and more especially from the Sohar. At the death of Baal-Shem, his three grandsons, Bär of Meseritz, Mendel of Przemislan, and Michael of Kolk, continued to govern the sect, which at that time numbered about 40,000 members, and became firmly established in Poland, Wallachia, Moldavia, Galicia, and Palestine, in all of which countries it still exists, though divided into several parties. Into Hungary it was introduced in 1809, by R. Moses Dattelbaum, one of the ablest men that have thus far belonged to the sect.

The Chasidim have published a number of works in defence of their doctrines. The following are some of them: 1. A small work called תְּקִינָה (*Tradition*), by Senior Salman Lidier, 1780, reprinted in Königsberg, 1823; 2. שְׁעַר־הַאֱמוּנָה וְהַחֶסֶד (*Gates of Love and Truth*), by R. Aaron the Levite, Sklow, 1820; 3. יְשׁוּעוֹת הַחַסִּידוֹת, a book of ethics, arranged in alphabetical order by R. Nachman, 1821. See Kitto, *Cyclopaedia*, i, 475 sq.; Herzog, *Real-Encyclop.* ii, 687 sq.; Joet, *Geschichte des Judenthums und seiner Secten*, iii, 185 sq.; *Ben Chananja*, ii, 1, 49, 145, 198; Fürst, *Bib. Jud.* i, 74. Compare ASSIDÆAN.

Chasil. See CATERPILLAR.

Chaskuni BEN-MANOACH, a learned Jew, who flourished in France about A.D. 1260. He wrote a commentary on the Pentateuch, usually styled קְטָר חַסְדֵי שֵׁם טוֹב, in which he made large use of the Midrashic literature; indeed, it is almost entirely a compilation

from some twenty older annotators. It was printed by Bomberg at Venice in 1524, fol., and again at Basle in 1606, and in 1559 a carefully revised edition, by Vittorino Eliano, appeared at Cremona, 4to. It may be found also in the *Biblia Magna* of Moses Frankfurter (q. v.), Amst. 1724-27. — Kitto, *Cyclopaedia*, i, 478; Fürst, *Bib. Jud.* i, 171.

Chassidim. See CHASIDIM.

Chasten; *chastity, correct.* (1.) To strike or afflict one for his advantage and correction; and to refuse or despise chastisement, or correction, is to undervalue it, and be not reformed by it (Jer. ii, 30, and vii, 28; Heb. xii, 5). The overthrow of the Jewish nation by the Chaldeans was the chastisement of a cruel one; it was very severe, and inflicted by cruel instruments (Jer. xxx, 14). (2.) To punish in just wrath (Lev. xxvi, 28). Thus the chastisement of our peace was laid on Christ; that punishment, by the bearing of which our reconciliation with God is effected, was laid on him as our surety (Isa. liii, 5). To chasten one's self is to be exercised before God in self-abasement, fasting, and prayer (Dan. x, 12). The Scriptures are for correction; by their powerful influence they pierce a man to the heart, and make him amend his evil courses (2 Tim. iii, 16).—Brown, *Bible Dictionary*, s. v.

Chastity (Lat. *castitas*), in the Christian sense, denotes (1.) freedom from impure thoughts, desires, or imaginations; and (2.) abstinence from illicit sexual intercourse. It requires a control of the passions and of the imagination to a degree which no system of morals, except the Christian, has ever succeeded in securing. The love of God in the heart is the only sure safeguard against evil lusts. The body, in Christian ethics, is "the temple of the Holy Ghost." But, apart from pure religious life, a strict morality may do a great deal toward securing purity, if not of heart, at least of life. The evil consequences of sexual disorder should be taught in morals as hindrances to lust. Among them is the certainty that domestic happiness, as well as the physical and mental health of the criminal, are endangered by it. Chastity is the noblest result of pure morality, or of the free mastery of spiritual elevation and purity over the natural instincts; it protects liberty from sinking into subjection to the flesh, so far only, however, as it is the result of virtue, not of a natural indifference arising from temperament.

The best sources of chastity are, first, the true fear of God, which leads to avoid offending God by a sinful misuse of the noblest force of nature, and disturbing the divine law of human reproduction by beastly indulgences; secondly, education, inculcating honesty, modesty, and morality; thirdly, active occupation both of mind and body; fourth, moderation in the use of drink and spices. Chastity is highly blessed in its results, for from it result the purity of the soul, the liberty of the will, the preservation of health and strength, and freedom from the difficulties and misfortunes which unchastity entails on its unfortunate victims. It is also the seal of a high mind, a true virtue, and a sincere fear of God (Mark vii, 21, 22; Rom. xiii, 13, Let us walk honestly, as in the day: not in rioting and drunkenness, not in chambering and wantonness, not in strife and envying; 2 Cor. vi, 4, 6; Gal. v, 19-22; 1 Cor. vii, 5, Defraud ye not one the other, except it be with consent for a time, that ye may give yourselves to fasting and prayer; and come together again, that Satan tempt you not for your incontinency; Phil. iv, 8; 1 Tim. iv, 12; v, 2; Titus i, 8; ii, 5; 1 Pet. i, 22; iii, 2, While they behold your chaste conversation coupled with fear; iv, 8, For the time past of our life may suffice us to have wrought the will of the Gentiles, when we walked in lasciviousness, lusts, excess of wine, revellings, banquetings, and abominable idolatries; James iii, 17). He who is under the guidance of divine wisdom is essentially chaste (James iv, 8). Those who are διψυχοι, double-minded, cling on the

one side to the earth, and on the other aspire after heaven. When the heart is purified by the spirit of God, this duality ceases, and chastity is easy.—Krehl, *N. T. Handwörterbuch*, s. v.

Chasuble (*casula*, a hut, the name of the frock worn by the Roman peasants in the rain), the outer dress worn by the priest at the altar-service; called also *penula*. It succeeded the old Roman toga. The *penula* was a circular cloth, with an aperture to admit the head in the centre, while it fell down over the body, so as completely to cover it. It was otherwise called *φαινόλιον*, *amphiballium*, and *planeta*. This *penula*, worn rather longer than common, was adopted at an early age for the outer dress of the clergy. The Romish Church has altered it by cutting it away at the sides, so as to expose the arms, and leave only a straight piece before and behind. The color of the vestment varies according to the different festivals of the Church at which it is used. The Greek Church retains it in its primitive shape. It often appears on the older sculptures and mosaics, and also in old brasses in England.—Palmer, *Orig. Liturg.* ii, 809; Hook, *Church Dictionary*, s. v.; Siegel, *Alterthümer*, iii, 63 sq.; Martigny, *Dictionnaire des Antiquités*, 146.

Chatel, Du. See DU CHATEL.

Chatlim (חַטְלִים) or Chatulim (חַטְלִים), a place in Palestine mentioned by the Talmudists (*Mesachoth*, 86 b), and made by Schwarz (*Palest.* p. 178) to be "the modern village *Al-Chatā*, east of Mt. Tabor, not far from Jordan," where it is marked as *EL-Hallā* on Van de Velde's *Map*.

Chatsir. See LEEX.

Chauncy, Charles, a Congregational minister, was born in Yardleybury, Hertfordshire, Eng., 1592. He entered as student in Trinity College, Cambridge, and passed M.A. in 1617. He was chosen fellow, and was made bachelor of divinity in 1624, and, still later, was elected professor of Greek. He left the University, entered the ministry, and in 1627 became vicar of Ware. He was brought before Laud for his opposition to the "Book of Sports" in 1629, and in 1636 he was found guilty of disobedience and contempt of Church authority, but he made a recantation. He was afterwards silenced, and came to New England in 1638. About three years he lived at Plymouth, and then became pastor in Scituate. In November, 1654, he was chosen president of Harvard College, in which station he remained with honor until his death, Feb. 19, 1672. He was the author of several Latin and Greek poems, and also of *Retraction of Chas. Chauncy, formerly Minister of Ware, in Hertfordshire, written with his own Hands before his going to New England in 1637* (Lond. 1641); *Twenty-six Sermons on Justification* (4to, 1659); *Antisynodalia Americana*, and a few occasional sermons.—Sprague, *Annals*, i, 110.

Chauncy, Charles, D.D., a descendant of president Chauncy, of Harvard University (see preceding article), was born in Boston Jan. 1, 1706, graduated at Harvard in 1821, studied divinity, and was ordained pastor of the First Church in Boston in 1727. He was distinguished for learning and independence, and was one of the founders of Universalism. He died Feb. 10, 1781, in the eighty-third year of his age. He published *A complete View of Episcopacy:—Seasonable Thoughts* (opposed to Whitfield), 1776.—*The Fall and its Consequences*, 1785.—*The Benevolence of the Deity*, 1784, 8vo.—*The Salvation of all Men*, 1784, 8vo; answered by Edwards, jun. (*Works*, N. Y. ed., vol. i, 5-279).

Chauncy, Isaac, an English Nonconformist divine (son of Charles Chauncy 1st [q. v.]), was one of the ministers ejected in 1662, and afterwards became pastor of a Congregational church at Andover. In 1687 he became pastor of the Independent Church in London, which had previously been Dr. John Owen's.

In 1704 he retired from the ministry, and was professor of divinity for several years in the Dissenters' Academy in London. He died Feb. 28, 1712. Among his writings are, *The Divine Institution of Congregational Churches*—*The Doctrine according to Godliness* (in catechetical form; Lond. 1787, 12mo):—*Neonomianism unmasked* (Lond. 1692).—Calamy, *Nonconformists' Memorial*, ii, 517.

Chazir. See SWINE.

Chē'bar (Heb. *Kebar*, כְּבַר, perhaps from its length; Sept. *Koβάρ*), a river in the "land of the Chaldeans" (Ezek. i, 8), i. e. apparently of Mesopotamia (comp. 2 Kings xxiv, 15), on the banks of which some of the Jews were located at the time of the captivity, and where Ezekiel saw his earlier visions (Ezek. i, 1; iii, 15, 28; x, 15, 20, 28; xliii, 8). It is commonly regarded as identical with the **HABOR** (חַבּוֹר), or river of Gozan, to which some portion of the Israelites were removed by the Assyrians (2 Kings xvii, 6). But this is a mere conjecture, resting wholly upon the similarity of name, which, after all, is not very close. It is perhaps better to suppose the two streams distinct, more especially if we regard the Habor as the ancient Chaboras (modern Khabour), which fell into the Euphrates at Ciresium, for in the Old Testament the name of Chaldæa is never extended so far northward. The Chebar of Ezekiel must be looked for in Babylonia. It is a name which might properly have been given to any *great* stream (comp. *גְּבַר*, *great*). Perhaps the view, which finds some support in Pliny (*H. N.* vi, 26), and is adopted by Bochart (*Phaleg*, i, 8) and Cellarius (*Geograph.* c. 22), that the Chebar of Ezekiel is the *Nahr Malcha*, or Royal Canal of Nebuchadnezzar—the *greatest* of all the cuttings in Mesopotamia—may be regarded as best deserving acceptance. In that case we may suppose the Jewish captives to have been employed in the excavation of the channel. That Chaldæa, not Upper Mesopotamia, was the scene of Ezekiel's preaching, is indicated by the tradition which places his tomb at Keffil (Loftus's *Chaldæa*, p. 85).—Smith, s. v. See **EZEKIEL**.

Chebel (כֶּבֶל, *che'bel*; usually rendered in the older versions *σχοινίωμα*, *περίμετρον*, *περίχωρον*; *regio*, *funiculus*), one of the singular topographical terms (q. v.) in which the ancient Hebrew language abounded, and which add so much force and precision to its records. The ordinary meaning of the word is a "rope" or "cord;" and in this sense it frequently occurs both literally (as Josh. ii, 15, "cord;" 1 Kings xxx, 31, "ropes;" Isa. xxxiii, 23, "tacklings;" Amos vii, 17, "line") and metaphorically (as Eccles. xii, 6; Isa. v, 18; Hos. xi, 4). From this it has passed—with a curious correspondence to our own modes of speech—to denote a body of men, a "band" (as in Psa. cxix, 61). In 1 Sam. x, 5, 10, our word "string" would not be inappropriate to the circumstances—"a string of prophets coming down from the high place." Further it is found in other metaphorical senses, arising out of its original meaning (as Job xviii, 10; Psa. xviii, 4; Jer. xiii, 21). From the idea of a measuring-line (Mic. ii, 5), it has come to mean a "portion" or "allotment" (as 1 Chron. xvi, 18; Psa. cv, 11; Ezek. xlvii, 18). It is the word used in the familiar passage "the *lines* are fallen unto me in pleasant places" (Psa. xvi, 6). But in its topographical sense, as meaning a "tract" or "district," we find it always attached to the region of Argob, which is invariably designated by this, and by no other term (Deut. iii, 4, 18, 14; 1 Kings iv, 13). Its propriety is illustrated by a late traveller in those regions, who shows the abrupt definiteness of the boundary of the district (Graham, in *Cambridge Essays*, 1858). A comparison of the fact that Argob was taken possession of by Manasseh—a part of the great tribe of Joseph—with the use of this word by that tribe, and by Joshua in his report, in the very early and characteristic frag-

ment, Josh. xvii, 5, 14 (A. V. "portion"), prompts the suggestion that it may have been a provincialism in use among that large and independent part of Israel. Or its application to the "rocky shore" of Argob may be illustrated and justified by its use (Zeph. ii, 5-7; A. V. "coast") for the "coast line" of the Mediterranean along Philistia. In connection with the sea-shore it is also employed in Josh. xix, 29.—Smith, s. v. See **ARGOB**.

Checker (חֶבְרֵק, *sehahak*, 1 Kings vii, 17). The original term, thus rendered, is the same as that translated *net-work* in the context, and signifies a *lattice* forming the *balustrade* surmounting the capitals of columns.

Chedek. See **THORN**.

Chedorla'omer (Heb. *Kedorla' mer*, כְּדֹרְלָאוֹמֶר; Sept. *Χοδολαγομῶρ*, Josephus *Χοδολαγομορος*, *Ant.* i, 9, 1), a king of Elam, who, in the time of Abraham, with three other chiefs, made war upon the kings of Sodom, Gomorrah, Admah, Zeboim, and Zoar, and reduced them to servitude (Gen. xiv, 1 sq.). B. C. cir. 2080. For twelve years he retained his hold over them; in the thirteenth they rebelled; in the next year, however, he and his allies marched upon their country, and, after defeating many neighboring tribes, encountered the five kings of the plain in the vale of Siddim. He completely routed them, slew the kings of Sodom and Gomorrah, and carried away much spoil, together with the family of Lot (comp. Psa. cx). Chedorlaomer seems to have perished in the rescue, which was effected by Abraham upon hearing of the captivity of his nephew (Gen. xiv, 17). According to Gesenius (*Theo. Heb.* p. 660 b), the meaning of the word may be "handful of sheaves, from the Arabic *kadara*, *handful*, and the Heb. *כֶּבֶר*, *sheaf*," an etymology with which Fürst (*Heb. Handv.* s. v.) coincides; but this is little satisfactory. The name of a king is found upon the bricks recently discovered in Chaldæa, which is read *Kudur-mapula*. See **BABYLON**. This man has been supposed to be identical with Chedorlaomer, and the opinion is confirmed by the fact that he is farther distinguished by a title which may be translated "Ravager of the West." "As, however, one type alone of his legends has been discovered," says Colonel Rawlinson, "it is impossible to pronounce at present on the identification. The second element in the name 'Chedorlaomer' is of course distinct from that in 'Kudur-mapula.' Its substitution may be thus accounted for. In the names of Babylonian kings the latter portion is often dropped. Thus Shalmaneser becomes Shalman in Hoshea; Merodach-bal-adan becomes Mardoccepal, etc. *Kudur-mapula* might therefore become known as *Kudar* simply. The Arabic epithet 'al-Ahmar,' which means *the Red*, may afterwards have been added to the name, and may have been corrupted into *Laomer*, which, as the orthography now stands, has no apparent meaning. *Kedar el-Ahmar*, or 'Kedar the Red,' is in fact a famous hero in Arabian tradition, and his history bears no inconsiderable resemblance to the Scripture narrative of Chedor-laomer. It is also very possible that the second element in the name of Chedorlaomer, whatever be its true form, may be a Semitic translation of the original Hamite term *mapula*." "Chedorlaomer may have been the leader of certain immigrant Chaldæan Elamites who founded the great Chaldæan empire of Berosus in the early part of the 20th [21st] century B. C., while Amraphel and Arioch, the Hamite kings of Shinar and Ellasar, who fought under his banner in the Syrian war as subordinate chiefs, and Tidal, who led a contingent of Median Scythians belonging to the old population, may have been the local governors who had submitted to his power when he invaded Chaldæa" (Rawlinson's *Herod.* i, 848, 856.—Smith, *Dict.* s. v.

Mr. Stuart Poole supposes that the first invasion of

Palestine by Chedorlaomer and his confederates caused the shepherd-kings to leave the East and settle in Egypt (*Horæ Egypt.* p. 150). The narrative is strangely supposed by Hitzig (*Ps.* ii, 176) to be a late fiction referring to the expedition of Sennacherib against Jerusalem (comp. Gen. xiv, 5, and 2 Kings xviii, 18). See, on the other side, Tuch (*Genes.* p. 808); Bertheau (*Israel. Geschichte.* p. 217). See ELAM.

Cheek (רִיבֹן, *leché'*, the jaw, as often rendered; σιαγών). Smiting upon the cheek is frequently spoken of in the Scriptures as a most grievous insult and injury (Job xvi, 10; Lam. iii, 80; Mic. v, 1; Luke vi, 29); and the incidental notices of modern travellers on this, as on other subjects, exhibit the literal accuracy of the language of the inspired writers. Lord Valentia, in his *Travels*, alluding to one of his servants, says, "Davgé was deeply incensed; nor could I do more than induce him to come to the factory on business while I was there, Mr. Pringle having, in one of his fits, struck him on the cheek with the sole of his slipper." Sir W. Ouseley, speaking of the Persian court, remarks, "When the vizir declared himself unable to procure the money, Fathh Ali Shah reproached him for his crimes, struck him on the face, and, with the high wooden heel of a slipper, always iron-bound, beat out several of his teeth." Roberts remarks that the Hindoo can bear almost any thing without emotion except slipping—that is, a stroke with the sole of a slipper or sandal, after a person has taken it off his foot and spit upon it: this is dreaded above all affronts, and considered as no less ignominious than spitting in the face or bespattering with dirt among Europeans. An angry man often says, "I will beat thy cheek, thou low-caste fellow."

The term "*cheek-bone*," in *Psa.* iii, 7, is used figuratively, and presents the Psalmist surrounded by his enemies as by a herd of wild beasts, and denotes their complete deprivation of the power of seizing upon or devouring their prey. In *Joa* i, 6, the "*cheek-teeth*" (מַתְּלֵיתָי, *methalleith'*), grinders, of locusts are compared to those of a beast of prey.

Cheese (in 1 Sam. xvii, 18, חֲרִישֵׁי הַחֶלָּב, *charitsey' he-chalab'*, slices of the [curdled] milk; Sept. ῥυφαλίδες τοῦ γάλακτος, Vulg. *formelle casei*; in 2 Sam. xvii, 29, שֶׁפְּתוֹת, *shephoth'*, according to the Rabbins, so called from being filtered from the whey; Sept. Σαφύς, Vulg. *pingues*; in Job x, 10, גִּבְיָנָה, *gebinah'*, coagulated milk; Sept. *rupós*). It is difficult to decide how far these terms correspond with our notion of *cheese*, for they simply express various degrees of coagulation (see Gesenius, *Thes. Heb.* p. 25, 526). It may be observed that *cheese* is not at the present day common among the Bedouin Arabs, butter being decidedly preferred; but there is a substance, closely corresponding to those mentioned in 1 Sam. xvii; 2 Sam. xvii, consisting of coagulated buttermilk, which is dried until it becomes quite hard, and is then ground: the Arabs eat it mixed with butter (Burkhardt, *Notes on the Bedouins.* i, 60). It is noticeable that the ancients seem generally to have used either butter or *cheese*, but not both: thus the Greeks had in reality but one expression for the two, for βούτυρον = βούτος, *rupós*, "cheese of kine." The Romans used *cheese* exclusively (see Beroald, *ad Apulej. Metam.* p. 26), while all nomad tribes preferred butter. The distinction between *cheese* proper and coagulated milk seems to be referred to in Pliny, xi, 96. See BUTTER.

The most important passage in which this preparation from milk is mentioned in Scripture is that where Job (x, 10), figuratively describing the formation of the fetus in the womb, says:

Is it not like milk thou wouldst pour me out,
Even like *cheese* wouldst curdle me?

This text alludes to that progressive solidification which is common to all *cheese*, which is always soft

when new, though it hardens when it becomes old. Undoubtedly the Orientals do eat curds, or curdled milk, but that, therefore, their *cheese* consists of curdled milk is not the correct inference. We also eat curds, but do not regard curds as *cheese*; neither do they. The other passages describe "*cheese*" in the plural, as parts of military provision, for which the most solid and compact substances are always preferred. Persons on a march would not like to encumber themselves with curdled milk (2 Sam. xvii, 29). See CURDLE.

There is much reason to conclude that the *cheese* used by the Jews differed in no respect from that still common in the East, which is usually exhibited in small cakes about the size of a tea-saucer, white in color, and excessively salt. It has no rind, and soon becomes exceedingly hard and dry; being, indeed, not made for long keeping. It is best when new and comparatively soft, and in this state large quantities are consumed in lumps or crumbs not made up into cakes. All *cheese* in the East is of very indifferent quality, and the natives infinitely prefer English or Dutch *cheese* when they can obtain it. In making *cheese* the common rennet is either buttermilk or a decoction of the great-headed thistle or wild artichoke. The curds are afterwards put into small baskets made of rushes or palm leaves, which are then tied up close and the necessary pressure applied. (See Kitto, *Pict. Lib.* note on 1 Sam. xvii, 19.) See MILK.

There are several decisions in the Mishna relative to the pressure by which *cheese* was made (*Cholim.* viii, 2). This proves that, as observed before, no preparation of milk was regarded as *cheese* while in a fluid state, or before being subjected to pressure. In another place (*Aboda Sara.* ii, 5) it is decided that *cheese* made by foreigners could not be eaten, from the fear that it might possibly be derived from the milk of some animal which had been offered in sacrifice to idols. It is therefore certain that *cheese* was known to the Jews (comp. Philo, *Opp.* ii, 387; Otho, *Lex. Rab.* p. 120), and there was even a valley at Jerusalem called the *Tyropeon* (q. v.), i. e. *cheese-makers'* valley (φάραξ τῶν τυροποιῶν), doubtless from its being occupied by persons of this craft (Josephus, *War.* v, 5, 1). See BAZAAR. An instrument for cutting firm *cheese* is even named in the Mishna (*Shabb.* xvii, 2). (See generally Ugolini, *De re rustica vet.* *Hebr.* [in his *The-saur.* xxix], ii, 15.) See FOOD.

Cheke, SIR JOHN, was born at Cambridge June 16, 1514, and was educated at the University there, devoting himself especially to the study of Greek, then much neglected in England. When the first professorship of Greek was founded in Cambridge by king Henry VIII, about 1540, Cheke was appointed professor. He was made tutor of the prince, afterwards Edward VI, but when queen Mary came to the throne his property was confiscated. He fled to the Continent, but was arrested at Brussels by order of Philip II, and sent back to London. He abjured Protestantism, but this act preyed on his mind, and he died in the following year, September 18, 1557. His writings were very numerous and learned; among them are *De Obitu Martini Buceri* (Lond. 1551, 4to); *De Pronunciatione Lingue Græcæ* (Basil, 1555); *Translation of Matthew* (from the Greek, edited by Goodwin, Cambridge).—*Gen. Biog. Dict.* iii, 801; Strype, *Life of Cheke* (Lond. 1705, 8vo); Kippis, *Biog. Britannica*, iii, 484.

Che'lal (Heb. *Kelal'*, כֶּלֶל, *completion*; Sept. Χαλήλ), one of the "sons" of Pahath-Moab who divorced his Gentile wife after the return from Babylon (*Ezra* x, 80). B. C. 458.

Chelbenah. See GALBANUM.

Chel'cias (Χελκίας, i. e. *Hilkiah*), the name of three or four men.

1. The father of Asariah and ancestor of Baruch (q. v.). (Bar. i, 1). B.C. considerably ante 605.

2. A priest, son of Salom (Shallum), and father of Joachim (Bar. i, 7); evidently the HILKIAH (q. v.) of the Old Test. (1 Chron. vi, 18).

3. The father of Susanna (Sus. 2, 29, 68). B.C. post 588. He was perhaps identical with the Hilkiah of Neh. xii, 7, or of Neh. viii, 4. Tradition, however (Hippol. in *Susanna*, i, 689, ed. Migne), represents him as identical with the father of Jeremiah (Jer. i, 1), and also with the priest who found the copy of the law in the time of Josiah (2 Kings xxii, 8).

4. One of the two Alexandrian Jewish generals of Cleopatra in her contest with her son Ptolemy Lathyrus, in which campaign he died in Coele-Syria (Josephus, *Ant.* xiii, 10, 4; 18, 1).

Chel'lian (or, rather, *Chellusan*, Χελλαίος), an inhabitant of a region mentioned (Judith ii, 28) as adjoining Arabia Deserta on the north; probably that elsewhere (Judith i, 9) called CHELLUS (q. v.).

Chel'tuh (Heb. *Cheluku*, חֶלְיָהוּ [text חֶלְיָהוּ], v. r. חֶלְיָהוּ or חֶלְיָהוּ, completed; Sept. *Χελία* v. r. *Χελία* and *Χελκία*, Vulg. *Cheliam*), one of the "sons" of Bani who divorced their Gentile wives after the Babylonian exile (Ezra x, 86). B.C. 458.

Chel'tus (Χελλοῦς v. r. *Χελούς*, Vulg. omits), named among the places beyond (i. e. on the west of) Jordan to which Nabuchodonosor sent his summons (Judith i, 9). Except its mention with "Kades" there is no clew to its situation; this, however, would seem to locate it near Kadesh-barnea. Hence Reland (*Palæst.* p. 717) conjectures that it may be *Chalusa* (חֶלְיָהוּ), a place which, under the altered form of ELUSA (q. v.), was well known to the Roman and Greek geographers. With this agrees the subsequent mention of the "land of the Chellians" (ἡ Χελλαίων, Vulg. *terra Collon*), "by the wilderness," to the south of whom were the children of Ishmael (Judith ii, 28). Movers (*Zeitschr. f. Philos.* 1835, p. 86) supposes it to be the same as HALHUL (Josh. xv, 58), and that Betane, mentioned with it, is the same as Beth-anoth (Josh. xv, 59).

Chel'od (Χελοῦδ v. r. *Χελοῦλ*, Vulg. omits, old Lat. ver. *Chelleuth*, Syr. "Chaldæans"). "Many nations of the sons of Chelod" were among those who obeyed the summons of Nabuchodonosor to his war with Arphaxad (Judith i, 6). The word is apparently corrupt (see Fritzsche, *Ev. Handb.* in loc.). Simonis suggests *Χαλῶν*, i. e. CALNEH, perh. *Ctesiphon*. Ewald (*Gesch. Isr.* III, ii, 548) conjectures it to be a nickname for the *Syrians*, "sons of the mole" (חֶלְיָהוּ, *choled*).

Chel'tub (Heb. *Chelub*, חֶלְיָהוּ, a *cage*, as in Jer. v, 27), the name of two men.

1. (Sept. *Χαλίβ*.) The brother of Shuah and father of Chechir, of the tribe of Judah (1 Chron. iv, 11). B.C. appar. ante 1612.

2. (Sept. *Χελοῦβ*.) The father of Ezri, which latter was David's chief gardener (1 Chron. xxvii, 26). B.C. ante 1014.

Chel'u'bai (Heb. *Chelubay*, חֶלְיָהוּ; Sept. *Χαλίβ*), one of the sons of Hezron (1 Chron. ii, 9); elsewhere (ver. 18, 42) called CALEB (q. v.). It is worth noting that, while in this passage Jerahmeel is stated to be a brother of Chelubai, it appears from 1 Sam. xxvii, 10, that the Jerahmeelites were placed on the "south of Judah," where also were the possessions of the house of Caleb (Judg. i, 15; 1 Sam. xxv, 8; xxx, 14).

Chem'arim (Heb. *Chemarim*, חֶמְרִים, *idol-priests*). This word occurs only once in our version of the Bible ("chemarims," Zeph. i, 4; Sept. confounds with *tepeic* following); but it is met with in the Hebrew in 2 Kings xxiii, 5 (Sept. *Χομαρίμ*); Hos. x, 5 (Sept. omits), where it is rendered "idoltrous priests," and "priests;" and in both of these passages the margin

has "*chemarim*." According to Gesenius (*Theo. Heb.* p. 693), the corresponding Syriac word signifies "a priest in general; but this, as well as other Syriac words relating to divine worship, is restricted by the Hebrews to idol-worship. As to the etymology, the singular form חֶמְרִי, *ko'mer*, is properly *blackness, sadness*, and concretely, *one who goes about in black, in mourning*, hence an *ascetic, a priest*." Fürst (*Heb. Lex.* s. v.) suggests a derivation from חֶמְרִי = חֶמְרִי, in the sense of *worship*, and remarks that the title *chemarim*, although proper to the peculiar priests of Baal, was also applied to other idolatrous priests. Zeph. i, 4, the *chemarim* are coupled with the priests, and the passage may signify, "I will destroy the *chemarim*, together with the priests of the tribe of Levi who have joined in the worship of idols." The priests who officiated in the service of the golden calves at Dan and Bethel were called *chemarim* (see the other passages referred to). Even to this day the Jews retain the word, and apply it in derision to Christian ministers, on account of their black robes. See BAAL.

Chemnitz (properly VON KEMNITZ), MARTIN, an eminent German theologian, was born at Treuenbitzen, in Brandenburg, Nov. 9, 1522. His parents designed him for an artisan, but he took kindly to no trade, and a distant relative (Niemann) called him to Magdeburg (1539), where he spent three years preparing for the University. He was compelled by want of money to become a teacher at Kalbe in 1542, and at Wrietzen in 1544; studied mathematics and astrology at Wittenberg in 1545-47; was made rector at Königsberg, Prussia, in 1548, and two years afterwards became librarian of duke Albrecht. He now turned his attention to theology, and became a thorough student of the Bible and the fathers. In the controversy on the doctrine of justification he took part against Osiander; but the controversy so annoyed him that, in 1552, much against the will of the duke, he left Königsberg. He immediately after began the scientific study of dogmatics at Wittenberg, attaching himself closely to Melancthon, and lecturing in the University. He became preacher at Brunswick in 1554, and also delivered lectures there on theology, which gained great celebrity, and were published after his death by Polykarp Lyser (Frankfurt, 1591, 8 vols. 8vo, and often). His work, entitled *Theologia Jesuitarum præcipua capita* (Greifsw. 1562), involved him in a controversy with the Roman Catholics, and led to his writing the *Examen concilii Tridentini* (Greifsw. 1565-1578, 4 vols.; Frankf. 1707, fol.), which is still a classical work on the subject. After the death of Melancthon he showed himself a zealous Lutheran, and in 1566 became associated with Mörlin in the preparation of the *Corpus doctrinæ Prutenicum*, designed as the symbolical text-book of Prussia. In 1567, having become superintendent of Brunswick, he prepared the Confession of the Church of Lower Saxony. From 1574 he exerted himself, with Jacob Andrea, to induce the churches of Saxony and Suabia to adopt the *Formula Concordiæ* (q. v.), in the preparation of which he had taken a leading part. He devoted himself almost exclusively to this work, took with Andrea a leading part in all the meetings that were held on the subject, and obtained the admiration of his contemporaries as well by the prudence and firmness of his conduct as by the depth and extent of his knowledge. He resigned his charge in 1585, and died April 8, 1586. Besides the above-named works, he wrote also *Repetitio sacra doctrinæ de vera presentia corporis et sanguinis Domini in cena sacra* (Leipzig, 1561).—*Die führnehmsten Hauptstücke der christlichen Lehre* (Wolfenb. 1569).—*De duabus in Christo naturis* (Jena, 1570).—*Harmonia evangeliorum*, completed by Leyser and Gerhard (Hamburg, 1704, 8 vols. fol.). Chemnitz has been pronounced the "first great theologian produced by the Reformation." Schenkel (in Herzog, cited below) says that it was

more from the force of circumstances than from his own theological tendencies that he appeared to be a leader of the Lutheran party." On his Christology, see Dorner, *Person of Christ*, div. ii, vol. ii, 198 sq. See also Lentz, *Dr. Martin Kemnitz* (Gotha, 1866); Hachfeld, *M. Chemnitz* (Leipzig, 1867).

Chemosh (Heb. *Kemośh'*, כְּמוֹשׁ, perh. *subduer*, or [as Fürst prefers] *fire-god*; Sept. *Χαμὸς*), the national deity of the Moabites (Num. xxi, 29; Jer. xlviii, 7, 18, 46). In Judg. xi, 24 (see Kraft, *Chamos a Jephtha derivus*, Erlang. 1766), he also appears as the god of the Ammonites, but not of the Amorites (as De Wette states, *Archäol.* p. 828). Solomon introduced, and Josiah abolished, the worship of Chemosh at Jerusalem (1 Kings xi, 7; 2 Kings xxiii, 18). See IDOLATRY. With regard to the meaning of the name, and the position which Chemosh held in mythology, we have nothing to record beyond doubtful and discordant conjectures. Jerome (*Comm.* in Isa. xv, 2) identifies him with *Baal-Peor* (comp. Selden, *De diis Syr.* p. 165, 841); others with *Baal-Zebub*, on etymological grounds (Hyde, *De rel. vet. Pers.* c. 5); others, as Gesenius (*Theaur.* p. 698), with *Mars*, or the god of war, on similar grounds; and others (Beyer *ad Selden*, p. 828) with *Saturn*, as the star of ill omen, Chemosh having been worshipped, according to a Jewish tradition (comp. Pococke, *Specim.* p. 807), under the form of a black stone; and Maimonides states that his worshippers went bareheaded, and abstained from the use of garments sewn together by the needle (see Calmet, *Desert.* ii, 277 sq.). This last identification is favored by the connection of the name Chemosh with that of Moloch or Milcom (1 Chron. xi, 7; 2 Kings xxiii, 18), and by the sacrifice apparently of children to him (see 2 Kings iii, 27). Hackmann, however (*Dis. de Chemocho*, Brem. 1780; also in Oelrich's *Opusc. histor. philol. theol.* I, i, 19 sq.), makes the name to be equivalent to *royal deity*. Jerome (*ut. sup.*) notices Dibon as the chief seat of his worship. Eusebius again (*Onomast.* s. v. *Ἀριὰ*, i. e. *Ἀριῆλ*) names *Ariel* (? fire-god) as the chief deity of Ar-Moab (thence called Areopolis), and in this character he is represented on coins (Eckhel, *Doctr. Num.* I, iii, 504). See SATURN.

Chena'anah (Heb. *Kena'anah'*, כְּנַעֲנָה, fem. form of *Canaan*), the name of two men. Fürst (*Hebr. Wörterb.* s. v.) suggests that the prevalence of such names as this, and *Tarsish* and *Cush* among the Benjamites, indicates special connection by intermarriage with the earlier race; the straits to which this tribe was reduced by its civil war (Judg. xxi) may have driven its members to special alliances with their Phœnician neighbors.

1. (Sept. *Xavanāv* v. r. *Xavanā*). The fourth named of the seven "sons" of Bilhan, son of Jediael, of the tribe of Benjamin, a leading warrior apparently in the time of David (1 Chron. vii, 10). B.C. cir. 1020.

2. (Sept. *Xavaāv* v. r. *Xavanā* and *Xavaavā*). The father of the false prophet Zedekiah, which latter encouraged Ahab against Miciah (1 Kings xxii, 11, 24; 2 Chron. xviii, 10, 28). B.C. ante 896.

Chen'ani (Heb. *Kenan'*, כְּנַנִּי, probably abridged from כְּנַנִּיָּה, *Chenaniah*; Sept. *Xavani* v. r. *Xaveni*), one of the Levites who offered the public prayer on the occasion of the fast at the return from the captivity (Neh. ix, 4). B.C. 459. By the Sept. the word "Bani" (בְּנֵי) preceding is read *viol* (like others adjoining), as if meaning "sons of Chenani." This reading is very probable, for there is not only another *Bani* in the verse, but one of Kennicott's MSS. (180), and six of De Rossi's, read כְּנַנִּיָּה, "sons of Chenani," instead of כְּנַנִּי, "Bani, Chenani" (for there is no conjunction in the original). The Peshito version assimilates the names of verse 4 to those of verse 5, omits "Chenani," and in place of it reads *Pethahia*. In the

omission of Chenani, it is supported by the *Cod. Frid.-August* of the Sept., which omits *vier Xaveni* (*primi manu*). The Vulgate and A. V., adhering to the Masoretic pointing, insert "and."

Chenani'ah (Heb. *Kenanah'*, כְּנַנִּיָּה, established by *Jehovah*; 1 Chron. xv, 27; Sept. *Xaveniās* v. r. *Xaveniās*; elsewhere in the longer form *Kenanah'*, כְּנַנִּיָּהּ; 1 Chron. xv, 22, *Xaveniā*; v. r. in 1 Chron. xxvi, 29, *Xaveniās*), a Levite of the family of Izharites (1 Chron. xxvi, 29), and chief of the temple singers (1 Chron. xv, 22), who conducted the grand musical services when the ark was removed from the house of Obed-edom to Jerusalem (1 Chron. xv, 27). B.C. 1043. See also CONONIAH.

Cheph'ar-haām'monai (Heb. *Kephār' ha-Ammonai'*, כְּפָר הַיַּמְמוֹנַי, *village of the Ammonites*; or, as the margin corrects, *Kephār' ha-Ammonah'*, כְּפָר הַיַּמְמוֹנָה, *village of [the] Ammonah*, i. e. *Ammonitis*; Sept. *Καφαρραμμονά*, but v. r. *Καφαρά και Κεφάρ και Μοβί*, blending with Ophni following; Vulg. *villa Emma-na*), a place in the N.E. section of the tribe of Benjamin (q. v.), mentioned between Ophrah and Ophni (Josh. xviii, 24. Schwarz (*Palest.* p. 126) thinks it is the "Ammonon" (so he reads for "Emmaus") repaired by Baruchides (1 Macc. ix, 50). In the *Onomasticon* (s. v.) it is merely called "Ammonai (Euseb. *Ἀμμωνία*; Jerome, *Ammon*), in the tribe of Benjamin." In the name of this hamlet [see CAPHAR-] is doubtless preserved the memory of an incursion of the Ammonites up the long ravines which lead from the Jordan valley to the highlands of Benjamin. See AMMONITE. Such a position is the modern *Ain Yebrud*, a little east of Jufna (Robinson, *Researches*, iii, 79 note).

Chephi'rah (Heb. in Josh. always with the art. *hak-Kephirah'*, חֶפְרָה, *the village*, Sept. *Κεφρά*; but in Ezra *Καφαρά*, Neh. *Καφερά* v. r. *Καφρά*), one of the four cities of the Gibeonitish Hivites with whom Joshua made the league (Josh. ix, 17; comp. ver. 7); assigned to the tribe of Benjamin (xviii, 26), and occupied by the remnant of the same tribe after the Captivity (Ezra ii, 25; Neh. vii, 29). Schwarz (*Palest.* p. 127) thinks it is one of "the villages (*Kephirium*, כְּפִרִיָּה) in the plain of Ono" (Neh. vi, 2). The Samaritan Version, at Gen. xiii, 8, renders Hai (Ai) by *Kephrah* (כְּפִרָה); but this cannot be Cephirah, since both Ai and it are mentioned together in Josh. ix (comp. 8 with 17), and in the lists of Ezra and Nehemiah already quoted. Dr. Robinson seems to have discovered it under the scarcely altered name of *Kef'ur* (*Biblioth. Sacra*, 1853, p. 124), in the mountain country on the western confines of Benjamin, about two miles west of Ajalon (*Later Bib. Res.* p. 146). The "extensive site called *Kef'ur*," suggested by Thomson (*Land and Book*, ii, 804), is too far N.W. The same objection applies to another ruined village, *el-Kef'ur*, laid down in this direction on Van de Velde's *Map*.

Cher'an (Heb. *Keran'*, כֶּרֶן, according to Gesenius a *harp*, but according to Fürst *association*; Sept. *Χαρόβαν*), the last named of the four "sons" of Dishon (but the Heb. in Gen. has Dishan), the Horite "duke" descended from Seir (Gen. xxxvi, 26; 1 Chron. i, 41). B.C. apparently cir. 1920.

Cher'eas. See CHERRAS.

Cherem. The vow thus called in Hebrew (חֶרֶם), "the accursed thing," is nowhere enjoined by Moses, nor does he specify by what solemnities or expressions it was distinguished from other vows, but takes it for granted all this was then well known. The species of *cherem* with which we are most familiar was the previous devoting to God of hostile cities against which they intended to proceed with extreme severity, and that with a view to inflaming the minds of the people to war. In such cases, not only were all the inhabitants put to death, but also, according as the terms of the

vow declared, no booty was made by any Israelite; the beasts were slain; what would not burn, as gold, silver, and other metals, was added to the treasury of the sanctuary; and everything else, with the whole city, burnt, with an imprecation upon any attempt that should ever be made to rebuild it. Of this, the history of Jericho furnishes an example (Josh. vi, 17, 19, 21-24). In the time of Moses there was a similar vow against the king of Arad (Numb. xxi, 1-3). See ACCURSED; ANATHERMA.

Cher'ethim (Heb. *Kerethim*, כְּרֵיתִים, the regular plural of *Cherethite*), occurs in this form only in Ezek. xxv, 16; Zeph. ii, 25, in the former of which passages it is rendered "Cherethims," and in the latter "Cherethites." The only other passage where the Cherethites are mentioned singly (although in a slightly different form in the original) is 1 Sam. xxx, 14. In all these passages they are expressly named as inhabitants of the southern Philistia, that is, *Philistines*. The Sept. and Syriac render the word in these places by *Cretans*; from which, and the passages in Amos ix, 7; Jer. xvii, 4; Deut. ii, 23, the conjecture would be strong that the Philistines sprang from Crete, were it certain that Captor means Crete. See PHILISTINE; CAPIТОR. For the other passages in which the word occurs, see CHERETHITE.

Cher'ethite (Heb. *Kerethi*, כְּרֵיתִי) occurs alone only in 1 Sam. xxx, 14 (A. V. "Cherethites"), where the people so designated are meant. See CHERETHIM. The word is elsewhere, and always in the same form, found only in the formula, "THE CHERETHITES AND THE PELETHITES" (כְּרֵיתִים וּפְלֵיתִים), without the final ך of the plural; Sept. ο Χερεθι και ο Φελεσι, but v. r. in 1 Chron. ο Χερηθι και ο Φαλλεσι; Vulg. *Cerethi at Phelethi*, a collective term for the life-guards (Josephus *σωματοφύλακεις*, *Ant.* vii, 5, 4) of king David (2 Sam. viii, 18; xv, 18; xx, 7, 23; 1 Kings i, 38, 44; 1 Chron. xviii, 17). Prevailing opinion (*Tal-mud Bab. tit. Zerack*, p. 18, ed. Rabe; see Carpzov in Ugolino *Theaur.* xxvii, 482) translates their names "headsmen and foot-runners." The former word (from כָּרַח, *karath'*, to cut) is used for *woodcutters* (2 Chron. ii, 10), and it might seem probable that the Cherethites, like the lictors of the Roman dictator, carried axes, both as a badge of office and for prompt use. In the later years of David, their captain, Benaiah, rose to a more commanding importance than the generals of the regular troops, just as in imperial Rome the præfect of the prætorian guards became the second person in the empire. It is evident that, to perpetrate any summary deed, Benaiah and the guards were chiefly relied on. That they were strictly a body-guard is distinctly stated in 2 Sam. xxiii, 23. The grammatical form of the Hebrew words is nevertheless not quite clear; and as the Cherethites are named as a nation of the south (1 Sam. xxx, 14), some are disposed to believe Crethi and Plethi to be foreign Gentile names used collectively. No small confirmation of this may be drawn from 2 Sam. xv, 18: "All the Cherethites, and all the Pelethites, and all the Gittites, six hundred men," etc. If the first two words were grammatical plurals, like the third (Gittites), it is difficult to see why final ך should be added to the third, and not also to the other two (yet see Gesenius, *Lehrgeb.* p. 526). As the word *all* is repeated three times, and 600 men is the number intended the third time, the Cherethites and Pelethites must have been reckoned by the hundred; and since the Gittites were clearly foreigners, all the à priori improbability which some have seen in David's defending himself by a foreign guard falls to the ground. His Gittite satellites are one more proof of the intensity of the tyrannical principle already come in, since equally among the Greeks and Romans (Herod. ii, 152; v, 66, 111; Livy, xxxvii, 40), and in modern Europe, for a prince to

trust the care of his person to foreign guards has ever been looked on as the most evident mark that he is keeping down his own subjects by force. It would seem that the office of the Cherethi was of the same nature as that of *Capigis* among the Turks and other Orientals (see Lüdecke, *Beschr. des türk. Reichs*, p. 293), who are bearers of the sultan's orders for punishing any one, by decapitation or otherwise (Le Bryn, *Voyage*, i, 184 sq.; ii, 258); an office which is very honorable in the East, though considered as degrading among us. It appears that Herod made use of an officer of this description in beheading John the Baptist. Of a like nature, probably, were the "footmen" of Saul (1 Sam. xxii, 17). At a later date they were called "the captains and the guard" (כְּרֵיתִים וְרֹצְיִים, 2 Kings xi, 4, 19; comp. 1 Kings xv, 27). It is plain that these royal guards were employed as executioners (2 Kings xi, 4), and as couriers (1 Kings xiv, 27). Similarly Potiphar was captain of the guard of Pharaoh, and also chief of the executioners (Gen. xxxvii, 36), as was Arioch, Nebuchadnezzar's officer (Dan. ii, 14). See Elsner, in the *Biblioth. Brem. Nov.* I, iii, 464 sq.; Schwarz, in the *Nov. Miscell. Lips.* II, i, 95 sq.; Opitz, *De Davidis et Solomonis satelhitio, Crethi et Plethi* (Jen. 1672); also in Crenii *Dissert. hist. philol.* (Rotterd. 1692); also in Ugolino, xxvii; Iken, *De Crethi et Plethi*, in his *Dissert. philol. theol.* p. 102 sq.; Elseling, in Winckler's *Animadoer. philol.* ii, 882 sq.; Lund, *Diss. de Crethi et Plethi* (Upsal. 1704); Carpzov, *Disputati. acad.* p. 187 sq. See PELETHITE; EXECUTIONER.

Che'rith (Heb. *Kerith*, כְּרִית, a cutting; Sept. *Xoppás*), a "brook" (כָּלַי, *mach'al*, Sept. *χειμάρρους*) i. e. torrent-bed (the Arabic *wady*) or winter-stream of Palestine, in (כִּי, not "by") which, i. e. upon whose sloping bank the prophet Elijah (q. v.) hid himself during the early part of the three years' drought (1 Kings xvii, 8, 5). The words of the passage give no precise clew to its position: "Get thee hence [i. e. apparently from the spot where the interview with Ahab had taken place], and turn thy face eastward (לְמִזְרֵיחַ), and hide thee in the torrent of Cherith, which is facing (עַל פְּנֵי) the Jordan." This last expression, which occurs also in verse 5, seems simply to indicate that the stream in question ran into that river, and not into either the Mediterranean or Dead Sea; for although the words sometimes require the translation "beyond" (as in Gen. xxv, 18; Josh. xv, 18), they may also be rendered "towards," or "before the Jordan" (comp. Gen. xvi, 22), that is, in coming from Samaria. Josephus (*Ant.* viii, 18, 2) does not name the torrent (*χειμάρρους τις*), and he says that Elijah went, not "eastward," but towards the south (*εἰς τὰ πρὸς νότον μῆρον*). Eusebius and Jerome, on the other hand (*Onomasticon*, s. v. *Xoppás*, Chorath), place the Cherith beyond Jordan, where also Schwarz (*Palest.* p. 51) would identify it in a *Wady Ahas*, opposite Bethshean. This is the *Wady el-Yabis* (Jabesh); the other name, Benj. Tude-la says, is a corruption of *Uad Elias* (וְאֵד אֱלִיָּהוּ, *Istin.* ii, 406, ed. Asher). The argument from probability is but little in favor of the Cherith being on the east of Jordan, of which region Elijah was indeed a native, but where he would scarcely be more out of Ahab's reach than in the recesses of the mountains of the rival kingdom of Judah. The only explicit tradition on the subject is one mentioned by Marinus Sanutus in 1821 (*Gesta per Franc.* p. 247), that it ran by Phasælis (q. v.), Herod's city in the Jordan valley (comp. Reland, *Palest.* p. 958). This would make it the *Ain Fusail*, which falls from the mountains of Ephraim into the Ghôr, south of Kurn Sârtabeh, and about fifteen miles above Jericho. This view is supported by Bachiene (*Heilige Geogr.* I, i, 126-180, and Van de Velde, *Narrative*, ii, 810, 811). The spring of the brook is concealed under high cliffs and under the shade of a dense jungle (Van de Velde, *Memoir*, p. 889). Dr. Robinson,

on the other hand, would find the stream in the *Wady el-Kelt*, behind Jericho (*Researches*, ii, 288). This last name is, however, not greatly like Cherith, yet the identification is perhaps the best hitherto suggested. This wady is formed by the union of many streams in the mountains west of Jericho, issuing from a deep gorge, in which it passes by that village, and then across the plain to the Jordan. It is dry in summer. No spot in Palestine is better fitted to afford a secure asylum to the persecuted than Wady el-Kelt. On each side of it extend the bare, desolate hills of the wilderness of Judæa, in whose fastnesses David was able to bid defiance to Saul. The Kelt is one of the wildest ravines in this wild region. In some places it is not less than five hundred feet deep, and just wide enough at the bottom to give a passage to a streamlet (1 Kings xvii, 6), like a silver thread, and to afford space for its narrow fringe of oleanders. The banks are almost sheer precipices of naked limestone, and are here and there pierced with the dark openings of caves and grottoes, in some one of which probably Elijah lay hid. The wady opens into the great valley, and from its depths issues a narrow line of verdure into the white plain; it gradually spreads as it advances until it mingles, at the distance of a mile or more, with the thickets that encompass Riha, the modern representative of Jericho. To any one passing down from Jerusalem or Samaria towards Jericho, the appropriateness of the words in 1 Kings xvii, 8, would be at once apparent (see Tristram, *Land of Israel*, p. 202). The Kelt being near Mount Quarantania, the traditional scene of the Temptation, was a favorite resort for anchorites when the example of St. Saba made that order fashionable in Palestine. See ELLJAH.

Wady el-Kelt is held by Porter (*Hand-book for Syria*, p. 191) to be the "Valley of Achor," in which the Israelites stoned Achan (Josh. vii, 26), and which served to mark the northern border of Judah (xv, 7). Along the southern bank of the wady, by a long and toilsome pass, ascends the ancient and only road from Jericho to Jerusalem. This he deems "the going up to Adummim, which is on the south side of the river (xv, 7). But this identification would confound the name Cherith with the very dissimilar one Achor, which latter we know was retained to a late period in Jewish history. See ACHOR.

Cher'ub [the proper name is pronounced *Ke'rub*] (Heb. *Kerub'*; קְרֻבִים, etymology uncertain; Sept. *Xepoûβ* v. r. *Xapouîβ* and *Xapîβ*; Vulg. *Cherub*), a place apparently in the Babylonian dominions, associated with Tel-harsa, Addan, etc., from which some Jewish exiles returned with Zerubbabel, who had lost their pedigree (Ezra ii, 59; Neh. vii, 61). The true construction of these names, however, would rather make this to be that of a *man* thus unregistered. B. C. 536. See ADDON.

Cher'ub (Heb. *kerub'*, קְרֻבִים, in the sing. only in Exod. xxv, 19; 2 Sam. xxii, 11; 1 Kings vi, 24, 25, 27; 2 Chron. iii, 11, 12; Psa. xviii, 10; Ezek. x, 2, 7, 9, 14; xxviii, 14, 16; Sept. *χepoûβ*), plur. **CHER'UBIM** (Heb. *kerubim'*, קְרֻבִים, sometimes קְרֻבִים; Sept. *χepoûβim* v. r. *χepoûβeim*, and so in Eccl. xlix, 8, and Heb. ix, 5; Engl. Vers. invariably "cherubims"), the appellation of certain symbolical figures frequently mentioned in Scripture. See SERAPH.

I. Import of the Name.—The origin and signification of the word it is impossible to determine with any certainty. Those who seek it in a Shemitic root are still divided in opinion, some deriving it from the Chald. קְרֻב, *kerub'*, to plough, so that *cherub* = "plougher," i. e. *œ*, urging the parallel between Ezek. x, 14, and i, 10; others (as Gussetius, L. de Dieu, and Rödiger) take it by a transposition of letters for קְרֻבִים, *rekub'*, q. d. divine "beast" (Psa. xxiii, 11), comp. the Arabic *karûb*, a *ship* of transport; others (see Hyde, *De*

relig. vet. Pers. p. 268) make it i. q. קְרֻב, *karob'*, "near" to God, i. e. admitted to his presence; with others (see Maurer, *Comment. in Vet. Test.* at Isa. vi, 2) it is equivalent to קְרָב, *karav'* (Arabic the same). "to be noble," i. e. chief (comp. *Seraphim*); finally, to pass over other less probable conjectures (e. g. Rosenmüller, *Alterthumsk.* I, i, 181; and Paulus ap. Züllig, p. 81), the Talmudists regard it as the Chald. קְרֻבִיגָא, *ke-rubyā'*, *boylike* (see Buxtorf, jun., *Ezerickatt.* p. 100; Otho, *Lex. Rab.* s. v.). Gesenius at first proposed a derivation from the Syriac *kerub*, *strong*, but afterwards, convinced that he was misled by an error of Castell (see his *Anecd. Orient.* i, 66), he proposed a new etymology, as = קְרָב, *charav'* (Arabic the same), "to prohibit from a common use," to consecrate (*Theaur.* p. 711), compare the Ethiopic kindred word for sanctuary; so that the signification would be *keeper*, or guard, sc. of the Deity against all profane approach. Others (e. g. Eichhorn, *Einleit. in A. T.* iii, 80; Vatke, *Bibl. Theologie*, i, 525) think the cherubim were the same with the γούρες, *griffins*, of the Oriental imagination, guardians of the golden mountains; and seek the root in the Persic *karub*, to grasp (Tychsen in Heeren's *Ideen*, i, 386). Forster even seeks an Egyptian derivation of the name (*De bysso*, p. 116). Hävernick (*Zu Ezek.* p. 5) suggests a derivation from a Syriac root, meaning to cut or carve (Keil on 1 Kings v, 9); so Aben Ezra says that "cherub" is the same as קְרֻבִים, and means any artistic figure (Schultens, *Prov. Sol.* p. 472). An early etymology makes it from קְרָב, *ke-rab'*, *great-as-it-were*, q. d. like *Cabeiri* = *Σεοι θυραοι* (see Psa. ciii, 20; *θυράκιον*, 1 Pet. iii, 22; *ἀρχαί*, Eph. i, 21; so Procopius on Gen. iii; Theodorus on Gen. xlvii). The oldest derivation is from רָב and כָּר, as though it meant "abundance of knowledge," a meaning once universally adopted (Philo, *Vit. Mos.* p. 688; Clem. Alex. *Strom.* v, 240, ed. Sylb.; Origen, *Frag. Hex.* p. 114; Jerome on Isa. vi, 2; Dionys. *De Cal. Hier.* vii, 96; Spencer, *De Legg.* III, iii, 1, etc.). Hence the remark of Aquinas, "The name Seraphim is given from their fervor, as belonging to love; but the name Cherubim is given from their knowledge" (I, i, b. 1087, ch. vii). Fürst (*Concord.* p. 571), followed by Delitzsch (*Gen.* ii, 208), regards the root as properly *Semitic*, allied to the above sense of *grasping* (Sanscr. *grîbh*, Engl. *grip*).

II. History and Classification.—1. The first occasion on which they are mentioned is on the expulsion of our first parents from Eden (Gen. iii, 24), where the office of preventing man's access to the tree of life is assigned to "the cherubim (קְרֻבִים) with as in A. V. 'cherubims') with the flame of the waving sword." They are thus abruptly introduced, without any intimation of their shape and nature, as though they were too well understood to require comment. That some *angelic beings* are intended is obvious, and the attempts to refer the passage to volcanic agency (Sickler, *Ideen zu einem Vulkan*, p. 6), or to the inflammable bituminous region near Babylon (Plin. ii, 109, etc.), is a specimen of that valueless rationalism which unwisely turns the attention from the inner spirit of the narrative to its mere external form. We might perhaps conjecture, from the use of the *article*, that there were supposed to be a definite number of cherubim, and it seems that *four* is the mystic number usually attached to the conception of them. As the number four has special significance in Hebrew symbolism—being the number to express the world and divine revelation (Bähr's *Symbolik.* i, 119 sq.)—this consideration must not be lost sight of.

The word קְרֻבִים, there translated "on the east," may signify as well "before or on the edge of." Besides, קְרֻב, rendered by our translators "placed," signifies properly "to place in a tabernacle," an ex-

pression which, viewed in connection with some incidents in the after history of the primeval family (Gen. iv, 14-16), seems a conclusive establishment of the opinion that this was a local tabernacle, in which the symbols of the Divine presence were manifested, suitably to the altered circumstances in which man, after the Fall, came before God, and to the acceptable mode of worship he was taught to observe. That consecrated place, with its striking symbols, called "the presence of the Lord," there is reason to believe, continued till the time of the Deluge, otherwise there would have been nothing to guard the way to the tree of life; and thus the knowledge of their form, from the longevity of the antediluvians, could have been easily transmitted to the time of Abraham (Faber, *Horæ Mosaicæ*, bk. ii, ch. vi). Moreover, it is an approved opinion that, when those emblems were removed at the close of the patriarchal dispensation from the place of public worship, the ancestors of that patriarch formed small models of them for domestic use, under the name of Seraphim or Teraphim, according to the Chaldee dialect (Faber, *Origines of Pag. Idol.* i, 256).

In like manner were lion-shaped and eagle-formed griffins supposed by the aborigines of Northern Europe (Herod. iii, 102, 116) and India (Ctesias, *Ind.* p. 12) as guardians of the gold-bearing hills (comp. Gen. ii, 11); and in Greek mythology (see Creuzer, *Symbolik*, ii, 647) they were sacred to the deities (e. g. Apollo, Minerva, Bacchus). But the cherub was appointed as a divine emblem (Ezek. xxviii, 14; where some, however, take *מְרִצָּה* for *מְרִצָּה*, in the sense merely of "extended"), presiding over sacred mountains blazing with precious ores (ver. 16); at least the king of Tyre is there compared to such a being, unless, with others, we refer that whole description to the cherubic forms of the Jewish sanctuary (see Henderson, *Comment.* in loc.).

2. The next occasion on which the cherubim are noticed is when Moses was commanded to provide the furniture of the tabernacle; and, although he received instructions to make all things according to the pattern shown him in the Mount, and although it is natural to suppose that he saw a figure of the cherubim, yet we find no minute and special description of them, as is given of everything else, for the direction of the artificers (Exod. xxvi, 81). The simple mention which the sacred historian makes, in both these passages, of the cherubim conveys the impression that the symbolic figures which had been introduced into the Levitical tabernacle were substantially the same with those established in the primeval place of worship on the outskirts of Eden, and that by traditional information, or some other means, their form was so well known, both to Bezaleel and the whole congregation of Israel, as to render superfluous all further description of them.

Similar figures were to be enwoven on the ten blue, red, and crimson curtains of the tabernacle (Exod. xxvi, 1). The promise that God would "meet and commune with Moses from between the two cherubim" (Exod. xxv, 22) originates the constant occurrence of that expression as a description of the divine abode and presence (Numb. vii, 89; 1 Sam. iv, 4; Isa. xxxvii, 16; Psa. lxxx, 1; xcix, 1, etc.).

3. Cherubim after this appear likewise in the theophantic descriptions of the prophets and inspired poets (2 Sam. xxii, 11), especially in the remarkable visions of Ezekiel by the river Chebar (Ezek. x). Yet there was no mystery as to those remarkable figures, for Ezekiel knew at once (x, 20) the living creatures which appeared in his vision supporting the throne of God, and bearing it in majesty from place to place, to be cherubim, from having frequently seen them, in common with all other worshippers, in the carved work of the outer sanctuary. Moreover, as is the opinion of many eminent divines, the visionary scene,

with which this prophet was favored, exhibited a transcript of the Temple, which was shown in pattern to David, and afterwards erected by his son and successor; and, as the chief design of that later vision was to inspire the Hebrew exiles in Babylon with the hope of seeing, on their return to Judæa, another temple, more glorious than the one then in ruins, it is reasonable to believe that, as the whole style and apparatus of this mystic temple bore an exact resemblance (1 Kings vi, 20) to that of Solomon's magnificent edifice, so the cherubs also that appeared to his fancy portrayed on the walls would be fac-similes of those that belonged to its ancient prototype. See TEMPLE.

Still the question arises, Was the shape already familiar, or kept designedly mysterious? From the fact that cherubim were blazoned on the doors, walls, curtains, etc., of the house, and from the detailed description of shapes by Ezekiel, the latter idea might seem out of place. But if the text of Ezekiel, and the carvings, etc., of the Temple had made them popular, Josephus could not possibly have said (*Ant.* viii, 3, 8), "No one can say or conjecture what the cherubim (*χερουβείμ*) actually were." It is also remarkable that Ezekiel (chap. i) speaks of them as "living creatures" (*חַיִּים*, *חַיִּים*) under mere animal forms. Into this description in chap. x, 14, the remarkable expression, "the face of a cherub," is introduced, and the prophet concludes by a reference to his former vision, and an identification of those creatures with the cherubim (v, 20). On the whole, it seems likely that the word "cherub" meant not only the composite creature-form, of which the man, lion, ox, and eagle were the elements, but, further, some peculiar and mystical form, which Ezekiel, being a priest, would know and recognise as "the face of a CHERUB," but which was kept secret from all others; and such probably were those on the ark, which, when it was moved, was always covered (see ARK OF COVENANT), though those on the hangings and panels might be of the popular device. What this peculiar cherubic form was is a mystery perhaps impenetrable. It was probably believed popularly to be something of the bovine type (though in Psa. xvi, 20, the notion appears to be marked as degraded); so Spencer (*de leg. Hebr. rit.* iii, diss. 5, 4, 2) thinks that the ox was the *forma præcipua*, and quotes Grotius on Exod. xxv, 18 (Bochart, *Hierozoic.* p. 87, edit. 1690). Hence the "golden calf." The symbolism of the visions of Ezekiel is more complex than that of the earlier Scriptures, and he certainly means that each composite creature-form had four faces, so as to look four ways at once; was four-sided and four-winged, so as to move with instant rapidity in every direction without turning, whereas the Mosaic idea was probably single-faced, and with but one pair of wings. Ezekiel adds also the imagery of the wheels—a mechanical to the previous animal forms. This might typify inanimate nature revolving in a fixed course, informed by the spiritual power of God. The additional symbol of being "full of eyes" is one of obvious meaning. See CREATURE (LIVING).

III. *Their Form and Character.*—If we may trust the unanimous testimony of Jewish tradition, we must suppose that they had the faces of human beings, according to the positive assertion of Maimonides, Abarbanel, Aben Ezra, etc. (Otho, *Lex. Rab.* s. v. Cherubim; Buxtorf, *Hist. Arc. Fœd.* p. 100). But, taking Ezekiel's description of them to be the proper appearance that belonged in common to all his cherubic creatures (ch. i, x, xii), we are led to conclude that they were compound figures, unlike any living animals or real object in nature, but rather a combination, in one nondescript artificial image, of the distinguishing features and properties of several. The ox, as chief among the tame and useful animals, the lion among the wild ones, the eagle among the feathery tribes, and man, as head over all, were the animals which, or rather parts of

A.



C.



B.



D.

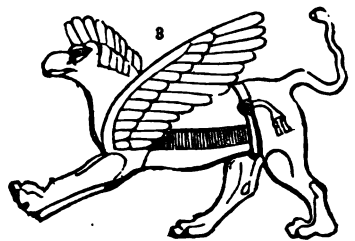
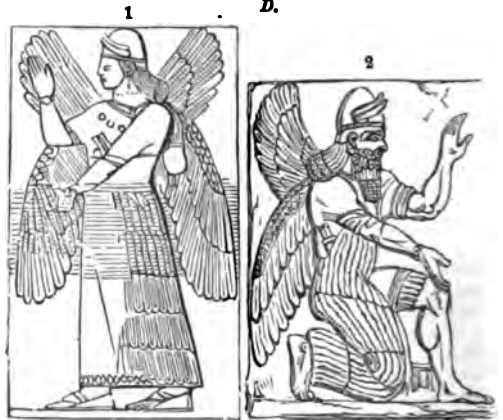

D (continued).



D (continued).



E.



Ancient Winged Symbols.

- A. Egyptian.—1, Angelic; 2, Eagle; 3, Asp; 4, Abstract—"eternity"; 5, Sphinx; 6, Griffin.
- B. Persian.—1, Cyrus; 2, Royal or Divine.
- C. Babylonian.—1, Male Sphinx; 2, Lion fighting; 3, Eagle; 4, Small Animal.
- D. Assyrian.—1, Royal, female; 2, Royal, male; 3, Griffin; 4, Horse; 5, Lion; 6, Bull; 7, Sphinx.
- E. Grecian.—Griffin.

which, composed the symbolical figures. Each cherub had four distinct faces on one neck—that of a man in front, that of a lion on the right side, and of an ox on the left, while behind was the face of an eagle. Each had four wings, the two under ones covering the lower extremities, or rather the centre of the person (Heb. the feet), in token of decency and humility, while the upper ones, spread out on a level with the head and shoulders, were so joined together, to the edge of his neighbors', as to form a canopy; and in this manner they soared rather than flew, without any vibratory motion with their wings, through the air. Each had straight feet (Heb. "their feet [were] a straight foot," Ezek. i, 7), and the probability is that the legs were destitute of any flexible joint at the knee, and so joined together that its locomotions must have been performed in some other way than by the ordinary process of walking, or lifting one foot after another. Bähr (whose entire remarks on this subject are valuable and often profound) inclines to think that the precise form varied within certain limits; e. g. the cherubic figure might have one, two, or four faces, two or four feet, one or two pair of wings, and might have the bovine or leonine type as its basis, the imagery being modified to suit the prominently intended attribute, and the highest forms of creature-being expressing best the highest attributes of the Creator (*Symbolik*, i, 313 sq.). Thus, he thinks, the human form might indicate spirituality (p. 340). (Comp. Grotius on Exod. xxv, 18, and Heb. ix, 5.) Some useful hints as to the connection of cherubic with other mythological forms may be found in Creuzer (*Symbol*, i, 441, 540).

It has been sometimes disputed whether the colossal cherubim of olive wood, overlaid with gold, with outspread wings, touching in the centre of the oracle and

reaching to either wall, placed by Solomon in the Holy of Holies, were substitutes for or additions to the original golden pair. The latter is probably the truth, for had the Mosaic cherubim been lost we should have been informed of the fact. All that we learn about these figures is that they each had a body ten cubits high (1 Kings v, 23), and stood on their feet (2 Chron. iii, 13), so that the monstrous conception of winged child-faces is an error which should long ago have been banished from Christian iconography (De Sauley, *Hist. de l'Art Judaïque*, p. 25). The expression "cherubims of image work," in 2 Chron, iii, 10 (מַסְכֵּי צַדִּיקִים), Sept. ἱερὸν ἐκ εἰδωλῶν, Vulg. opere statuario, Marg., of movable work), is very obscure, but would probably give us no farther insight into the subject (Dorjen, *De opere Zaazyim* in Ugolini *Thes.* viii, No. 6); but in 1 Chron. xxviii, 18, 19, we learn that David had given to Solomon a model for these figures, which are there called "the chariot of the cherubim" (Vulg. quadriga cherubim). We are not to suppose from this that any wheels supported the figures, but we must take "cherubim" in apposition to "charlots" (Bertheau, ad loc.). The same phrase is found in Eccles. xlix, 8, and is in both cases an allusion to the poetical expression, "He rode upon a cherub, and did fly" (2 Sam. xxii, 11; Ps. xviii, 10), an image magnificently expanded in the subsequent vision of Ezekiel, which for that reason has received from the Rabbis the title of מַרְכָּבָה, "the chariot." Although the mere word "cherub" is used in these passages, yet the simple human figure is so totally unadapted to perform the function of a chariot, that we are almost driven to the conclusion arrived at by De Sauley on this ground alone, that the normal type of the cherub involved the body of an ox, as well

as spreading wings and a human face (*Hist. de l'Art Judaïque*, p. 29). If this conjecture be correct, we shall have in these symbols a counterpart, exact in the minutest particulars, to the human-headed oxen, *touching both walls with their wings*, which have been discovered in the chambers of Nimrūd and Khorsabad. We shall find, further on, the strongest confirmations of this remarkable inference. We may here mention the suspicion of its truth, which we cannot but derive from the strange reticence of Josephus on the subject (*Ant.* iii, 6, 5). Now it is hardly conceivable that an emblem seen daily by multitudes of priests, and known to the Jews from the earliest ages, could be so completely secret and forgotten as this. If the cherubim were simply winged genii there would have been no possible reason why Josephus should have been ashamed to mention the fact, and, in that case, he would hardly have used the ambiguous word *Zōov*. If, on the other hand, they were semi-bovine in shape, Josephus, who was of course familiar with the revolting idolatry of which his nation was accused (*Tacit. Hist.* v, 4; *Josephus, Apion*, ii, 7), had the best reason to conceal their real form (*Spencer, De leg. Hebr. rit.* III, iv, 2 ad fin.), and to avert, as far as possible, all further inquiry about them. See *AS, WORSHIP OF*.

Arks, surmounted by mysterious winged guardians, were used in the religious service of most ancient nations, and especially in Egypt (*Plutarch, de Isid.* xxxix; *Wilkinson's Anc. Egypt.* v, 271; see *ARK*), but none of them involved the sublime and spiritual symbolism of the cherubim on the mercy-seat—at once guardians of the divine oracles and types of God's presence for the expiation of sin. But a question here arises, how the profuse introduction of these figures into the Tabernacle was reconcilable with obedience to the second commandment. It is certain that the rigid observance of this commandment was as serious a hindrance to the plastic arts among the Jews as the similar injunctions of the Koran are to the Mohammedans; and yet no word of condemnation was breathed against the cherubim, though Josephus even ventures to charge Solomon with distinct disobedience to the Law for placing oxen under the brazen sea (*Ant.* viii, 7, 5). The cherubim, indeed, were made in obedience to a distinct command; but how was it that they did not offend the consciences or seduce the allegiance of the theocratic Hebrews? The answer seems to be, that the second commandment only forbids the plastic arts when proscribed to the direct object of idolatry, and Tertullian is right in defending the introduction of cherubim, on the ground that they were a *simplex ornamentum* (*c. Marcion*, ii, 22); even the Talmudists allowed the use of images for purely decorative purposes (*Kalisch on Exod.* p. 346). Besides, they represented created beings as created beings, and also as themselves in the attitude of humility and adoration (*Exod.* xxv, 20; *1 Pet.* i, 12), so that instead of violating the commandment they expressed its highest spirit, in thus vividly symbolizing God's supremacy over the creatures which stood on the highest step of life, and were, in fact, the ideal of absolute and perfect created existence (*Bähr, Symbol.* i, 340 sq.). We may add that the danger was less, because, in all probability, they were seen by none but the priests (*Cornel. a Lapide on Exod.* xxv, 8); and when, in the desert, the ark was moved from place to place, it was covered over with a triple veil (*Num.* iv, 5, 6), before which even the Levites were not suffered to approach it (*Bochart, Hieros.* II, xxxiv, ad fin.). It may even be the case that the shape of the cherubim was designedly considered as indefinite and variable, that the tendency to worship them might still further be obviated. This wavering and indistinct conception of them was due to their symbolical character, a fact so thoroughly understood among all Oriental nations as at once to save the Jews from any strong temptation, and to raise them above the breath of suspicion.

Whether the golden calf constructed by Aaron might be, not the Apis of Egypt, but a representation of the antediluvian Cherubim, as some suppose, from its being made on "a feast to the Lord," and called "the gods of Israel" (*Exod.* xxxii, 5), and whether Jeroboam, in the erection of his two calves, intended a schismatic imitation of the sacred symbols in the Temple of Jerusalem rather than the introduction of a new species of idolatry (*1 Kings* xii, 28), we shall not stop to inquire. See *CALF*. But as paganism is a corruption of patriarchal worship, each nation having added something according to its own taste and fancy, perhaps we may find a confirmation of the views given above of the compound form of the cherubim, in the strange figures that are grouped together in the heathen deities. The numerous ox-heads, for instance, in the statue of the ancient Diana, and particularly the Asiatic idols, almost all of which exhibit several heads and arms attached to one person, or the heads of different animals combined, afford a collateral proof, similar to the universal prevalence of sacrifice, that the form of the primitive cherubim has been traditionally preserved and extended over a large portion of the world. This may indeed be shown by the above actual figures copied from ancient monuments, all of which illustrate some one or more of the notions which we attach to the cherubic forms; and while they afford material assistance to our ideas on the subject, they show that figures of this kind, as sacred symbols, were not peculiar to the Hebrews, and that their presence in the sanctuary was not calculated to excite any surprise among the neighboring nations, or to lead to the notion that the Jews also were worshippers of idols, for even in the pagan monument they never appear as idols, but as symbols; and it was very possibly this fact—that the cherubic figures were not liable to be misunderstood—which induced the Divine wisdom to permit their introduction into the most holy place.

Mr. Layard traces many striking points of analogy between the form and position of the above figures, especially between the last ones of the Assyrian group and the cherubim of the Temple: "Within the sacred oracle itself were the two cherubim of olive-wood, ten cubits high, with wings each five cubits long; and Solomon carved all the house around with carved figures of cherubim, and palm-trees, and open flowers, within and without. The cherubim have been described by Biblical commentators as mythic figures, uniting the human head with the body of a lion or an ox, and the wings of an eagle. If for the palm-trees we substitute the sacred tree of the Ninevite sculptures, and for the open flowers the Assyrian tulip-shaped ornament—objects most probably very nearly resembling each other—we find the oracle of the Temple was almost identical, in general form and in its ornaments, with some of the characters of Nimrūd and Khorsabad. In the Assyrian halls, too, the winged human-headed bulls were on the side of the wall, and their wings, like those of the cherubim, 'touched one another in the midst of the house.' The dimensions of these figures were in some cases nearly the same, namely, fifteen feet square. The doors were also carved with cherubim, and palm-trees, and open flowers, and thus, with the other parts of the building, corresponded with those of the Assyrian palaces" (*Nineveh and Babylon*, 2d series, p. 648).

It appears, therefore, that the symbolic figure which the Hebrew generically designates as a *cherub*, was a composite creature-form, that finds a parallel in the religious insignia of Assyria, Egypt, and Persia, e. g. the sphinx, the winged bulls and lions of Nineveh, etc., a general prevalence which prevents the necessity of our regarding it as a mere adoption from the Egyptian ritual. In such forms (comp. the Chimæra of Greek and the Griffin of north-eastern fables) every imaginative people has sought to embody its notions either of the attributes of Divine essence, or of the vast powers

of Nature which transcend that of man. Among the Greeks the *dragon* (Photius, *Cod.* 190, p. 250), and among the Indians the *griffin* (Pliny, vii, 2), were especially such creatures of mythological imagination. See DRAGON. In the various legends of Hercules the bull and the lion constantly appear as forms of hostile and evil power; and some of the Persian sculptures apparently represent evil genii under similar quasi-cherubic forms. The Hebrew idea seems to limit the number of the cherubim. A pair (Exod. xxv, 18, etc.) were placed on the mercy-seat of the ark; a pair of colossal size overshadowed it in Solomon's Temple with the canopy of their contiguously extended wings. Ezekiel, i, 4-14, speaks of four, and similarly the apocalyptic *living creatures*, *ζῶα* (Rev. iv, 6), are four. So at the front or east of Eden were posted "the cherubim," as though the whole of some recognized number. They utter no voice, though one is "heard from above them," nor have dealings with men save to awe and repel. A "man clothed in linen" is introduced as a medium of communication between them and the prophet, whereas for a similar office one of the seraphim personally officiates; and these latter also "cry one to another." The cherubim are placed beneath the actual presence of Jehovah, whose moving throne they appear to draw (Gen. iii, 24; Ezek. i, 5, 25, 26; x, 1, 2, 6, 7; Isa. vi, 2, 8, 6). The expression, however, "the chariot (*כְּרִיבֹת*) of the cherubim" (1 Chron. xxviii, 18) does not imply wheels, but the whole apparatus of ark and cherubim is probably so called in reference to its being carried on staves, and the words "chariot" and "cherubim" are in apposition. So a sedan might be called a "carriage," and the masc. form *כְּרִיבֹת* is used for the body of a litter. See, however, Dorjén, *De cherub. Sanct.* (ap. Ugolini, vol. viii), where the opposite opinion is ably supported. The glory symbolizing that presence which eye cannot see rests or rides on them, or one of them, thence dismounts to the temple threshold, and then departs and mounts again (Ezek. x, 4, 18; comp. ix, 8; Psa. xviii, 10). There is in them an entire absence of human sympathy, and even on the mercy-seat they probably appeared not merely as admiring and wondering (1 Pet. i, 12), but as guardians of the covenant and avengers of its breach. A single figure there would have suggested an idol, which two, especially when represented as regarding something greater than themselves, could not do. They thus became subordinata, like the supporters to a shield, and are repeated, as it were the distinctive bearings of divine heraldry—the mark, carved or wrought, everywhere on the house and furniture of God (Exod. xxv, 20; 1 Kings vi, 29, 35; vii, 29, 36). Those on the ark were to be placed with wings stretched forth, one at each end of the mercy-seat, and to be made "of the mercy-seat," which Abarbenel (Spencer, *De leg. Heb. ritual.* iii, diss. v) and oth-

ers interpret of the same mass of gold with it, viz. wrought by hammering, not cast and then joined on. This seems doubtful; but from the word employed (*כְּרִיבֹת*) the solidity of the metal may perhaps be inferred. They are called "cherubim of glory" (Heb. ix, 5), as on them the glory, when visible, rested; but, whether thus visibly symbolized or not, a perpetual presence of God is attributed to the Holy of Holies. They were anointed with the holy oil, like the ark itself and the other sacred furniture. Their wings were to be stretched upwards, and their faces "towards each other and towards the mercy-seat." It is remarkable that with such precise directions as to their position, attitude, and material, nothing, save that they were winged, is said concerning their shape. See TABERNACLE.

IV. *Their Meaning.*—All, whether ancients or moderns, have agreed that the cherubim were symbolical, but they have greatly differed as to their figurative design; many regarding them as having a twofold significance, both physical and metaphysical. They were clearly intended, in a general sense, to represent divine existences in immediate contact with Jehovah. This was the view of Chrysostom, Ambrose, Augustine, and the fathers generally (Sixt. Senensis, *Bibl. Sanct.* p. 848), and the Pseudo Dionysius places them second (between seraphim and thrones) in the nine orders of the celestial hierarchy (Dionys. Areop. *de Coelest. Hier.* p. 5-9). The Cabalists, on the other hand, placed them ninth in their ten choirs of spirits (Buddæus, *Philos. Hebr.* p. 415). In a special sense, Philo regarded them as signifying the two hemispheres, and the flaming sword the motion of the planets, in which opinion he is joined by some moderns, who consider them to have been nothing more than astronomical emblems—the Lion and the Man being equivalent to Leo and Aquarius—the signs of the zodiac (Landseer, *Sab. Resear.* p. 815). Irenæus views them as emblematic of several things, such as the four elements, the four quarters of the globe, the four Gospels, the four universal covenants (*adv. Hæres.* iii, 11). Tertullian supposed that the cherubic figures, particularly the flaming sword, denoted the torrid zone (*Apol.* cap. 47). Justin Martyr imagined that the living creatures of Ezekiel were symbolical of Nebuchadnezzar, the Assyrian monarch, in his distress; when he ate grass like an ox, his hair was like a lion's, and his nails like a bird's claws (*Quæst.* xlv). Athanasius supposed that they were significant of the visible heavens (*Quæst. ad Antioc.* cxxxv). The nature of the passages in which cherubim occur—passages poetical and highly wrought—the existence of exactly similar images among other nations, and the purely symbolic character of their form, has led not only Jewish allegorists like Philo, and Christian philosophers like Clemens of Alexandria, but even such writers as Hengstenberg, Keil, Neumann, etc., to deny them any personal reality; and in this way we may explain Zullich's definition of them as "mythical servants of Jehovah" (*Die Cherubim-Wagen*, Heidelberg, 1832). Thus, in the vision of Ezekiel, it is obvious that their animal shape and position implies subjection to the Almighty; that the four heads, uniting what were, according to the Jewish proverb, the four highest things in the world (Schoettgen's *Hor. Hebr.* ad Rev. iv), viz. the lion among beasts, the ox among cattle, the eagle among birds, and man among all, while God is the highest of all—constitute them the representative and quintessence of creation, placed in subordination to the great Creator (Leyrer, in *Zeller's Wörterb.* s. v.). The heads, too, represent not only creatures, perfect after their kind, but also perfect *qualities*, as love, constancy, magnanimity, sublimity, the free consciousness of man, the strong courage of the lion, the enduring strength of the ox, the rapid flight of the eagle (Hoffman); and possibly the number four may



Probable Form of the Cherubic Type.

indicate the universe as composed of four elements or four quarters. The four traditional (?) standards of the quadrilateral Israelite encampment (Num. ii), the lion of Judah, the man of Reuben, the eagle of Dan, the ox of Ephraim, are far too uncertain to be relied upon. Their eyes represent universal knowledge and insight (comp. Ovid, *Metamor.* i, 624, and the similar symbol of the Phœnician god Taut, mentioned by Sanchoniatho, ap. Euseb. *Præp. Evang.* x, 39), for they are the eyes of the Lord, which run to and fro through the whole earth (Zech. iv, 10). The wings imply speed and ubiquity; the wheels are necessary for the throne-chariot, itself a perfect and royal emblem, and so used by other nations (Chrysost. *Orat.* xxxv, 1); and the straight feet imply the fiery gliding and lightning-like flash of their divine motion (*πυροδρε*). We purposely avoid the error of pressing the minor particulars, such as those suggested by Clemens Alexandrinus, when he supposes that the twelve wings hint at the twelve signs of the zodiac (*Stromata*, V, cap. vi, sec. 37, p. 240, ed. Sylb.). Thus explained, they become a striking hieroglyphic of the dazzling, consummate beauty of universal creation, emanating from and subjected to the divine Creator, whose attributes are reflected in his works.

The leading opinions of moderns may be reduced to three systems. (1.) Hutchinson and his followers consider the cherubim as emblems of the Trinity, with man incorporated into the divine essence: in proof of which they remark that the words rendered "a flaming sword" (Gen. iii, 24) signify either a flaming fiery sword, as the words are rendered by the Sept., or, rather, a flame of fire and a sword or knife; so that, in this figure, there was exhibited in visible form, to the minds of our first parents, fire—the emblem of divine wrath, as well as an instrument for sacrifice—which, as it enfolded or revolved round itself, can mean nothing else than a picture of the satisfaction to be made by deity itself.—But the grand objection to this theory, where it is at all intelligible, is, that not only are the cherubim, in all the places of Scripture where they are introduced, described as distinct from God, and no more than his attendants, but that it represents the divine Being, who is a pure spirit, without parts, passions, or anything material, making a visible picture of himself, when in all ages, from the beginning of time, he has expressly prohibited "the likeness of anything in heaven above" (see Parkhurst, *Heb. Lexicon*, s. v.). (2.) Another system regards the cherubim as symbolical of the chief ruling powers by which God carries on the operations of nature. As the heaven of heavens was typified by the holy of holies in the Levitical tabernacle (Heb. ix, 8-12, 24-28), this system considers that the visible heavens may be typified by the holy place or the outer sanctuary, and accordingly finding, as its supporters imagine they do, the cherubim identified with the aerial firmament and its elements in such passages as the following: "He rode upon a cherub, and did fly, yea, he did fly upon the wings of the wind," where the last hemistich is exegetical of the former (Psa. xviii, 10); "Who rideth upon the heavens in thy help, and in his excellency upon the sky" (Deut. xxxiii, 26; Psa. lxxviii, 4); "He maketh the clouds his chariot:" he is said to descend in fire (Exod. xix, 18), and between them he dwelt in light (1 Tim. vi, 16); and it was in this very manner he manifested his divine glory in the tabernacle and temple—they interpret the cherubim, on which the Lord is described as riding, to be symbolical of the wind, the clouds, the fire, the light; in short, the heavens, the atmosphere, the great physical powers by which the Creator and preserver of the universe carries on the operations of nature.—This view, however, although doubtless truly representing the *origins* of the cherubic symbol, fails, by reason of its vague and extensive character, to explain the peculiar form of representation adopted. (3.) A third system considers

the cherubim, from their being instituted immediately after the Fall, as having particular reference to the redemption of man, and as symbolical of the great and active rulers or ministers of the Church. Those who adopt this theory are accustomed to refer to the living creatures, or cherubim, mentioned in the Apocalyptic vision (Rev. iv, 6), improperly rendered in our English translation "beasts" (ζῶα), and which, it is clear, were not angels, but redeemed men connected with the Church, and deeply interested in the blessings and glory procured by the Lamb. The same character may be ascribed to the living creatures in Ezekiel's visions, and to the cherubim, which stood over and looked into the mercy-seat, sprinkled with the blood of the atonement, and on the Shechinah, or divine glory arising from it, as well as the cherubic figures which were placed on the edge of Eden; and thus the cherubim, which are prominently introduced in all the three successive dispensations of the covenant of grace, appear to be symbols of those who, in every age, should officially study and proclaim the glory and manifold wisdom of God.—Of this view, likewise, it may be said that, while it assigns an adequate and plausible reason for the institution of some symbol having a moral import, it does not show why the special form in question should have been selected.

It is evident that the interpretation of the symbol must be as variable as the symbol itself, and we shall accordingly find that no *single* explanation of the cherubim can be accepted as adequate, but that the best of the various explanations contain elements of truth which melt and fade into each other, and are each true under one aspect. Unsatisfactory and vague as is the treatise of Philo "on the Cherubim and Flaming Sword," it has at least the merit of seizing this truth. Thus, discarding his astronomical vagaries which are alien to the spirit of Mossaism (Kalisch on *Exod.* p. 496), we may safely follow him in regarding the cherubim as emblems at once of divine perfection—personifications, in fact, of natural power employed in God's service, as De Wette holds; and emblems also of the divine attributes, his slowness to anger, his speed to love (Grotius on *Exod.* xxv, 18; Bochart, *Hiæros.* ii, 18; Rosenmüller, *Scholæ in Ezek.* i; Philo, *περὶ τὸν Χερουβ.* καὶ τῆς φλογ. ῥομφ. § 7-9; *De Vita Mos.* p. 688). Both of these views are admissible; the cherubim represent at once the subordination of the universe to God (Pirke, R. Eliezer, c. 8; *Shemoth Rabba*, § 23, ap. Schoettgen, *Hor. Hebr.* ad Apoc. ix, 6, τῆς βασιλείας αὐτοῦ σύμβολον; *Isidor.* lib. iv, ep. 70; Alford on Rev. iv, 8), and the glory of him whose servants they are (*Χερουβιμ δόξης*, Heb. ix, 5); "as standing on the highest step of created life, and uniting in themselves the most perfect created life, they are the most perfect revelation of God and the divine life." This is the conclusion of Bähr, whose whole treatment of the subject, though over-ingenious, is the most valuable contribution to a right understanding of this important and interesting question (*Symbolik*, i, 340).

As the other suggestions of their meaning are, for the most part, mere adaptations, they may simply be mentioned and passed over; as that the cherubim represent the four archangels; the four major prophets; the Church (Cocceius); the two uncreated angels, i. e. the Son and the Holy Spirit (Hulse); the two natures of Christ (Lightfoot); the four ages of the world (Kaiser, *De Cherubis humani generis mundique ætatum symbolis*, Erl. 1827); or God's fourfold covenant with man in Christ, as man, as sacrificed, as risen, and ascended (Arndt, *Wahres Christenthum*, iv, 1, 6). We may compare also the absurd explanation of Clermont, that they are the northern army of Chaldeans; and of Vatke, that they symbolize the destructive powers of the heathen gods. The very wide-spread and early fancy which attached the cherubic figures to the four evangelists is equally untenable, though it first appears in the Pastor

Hermas, and was adopted by the school of St. John (Iren. *adv. Hæres.* iii, 2, 8; Athanas. *Opp.* v, 2, p. 155; August. *de consens. Evang.* i, 6; Jerome, *Prolog. ad Evv.*; ep. 50, *ad Paulin.*; Greg. *Hom.* 4 in *Ezek.*; Adam de St. Vict. *Hymns. de Sa. Evang.* etc.). The four, in their union, were regarded as a symbol of the Redeemer (see Trench's *Sacred Latin Poetry*, p. 61; Mr. Jamieson, *Sacred and Leg. Art.* p. 185). The last to maintain this view is Dr. Wordsworth (on Rev. iv), who is rightly answered by Dean Alford (*ad loc.*).

V. The office ascribed to these symbolic beings is mainly twofold—1, a protective vengeful function in guarding from man's too close intrusion the physical and moral splendors of a lost paradise and a sacred revelation; and, 2, to form the throne and chariot of the divine being in his earthly manifestations, and to guard the outskirts of his unapproachable glory (Eichhorn, *Einleit.* iii, § 80). The cherubim engraved and woven in the Temple decorations, while they symbolize this function, serve also as "a seal of similitude," i. e. as heraldic insignia of the divine attributes to mark Jehovah's presence by their guardian ministries (Isidor. iv, ep. 78). At the same time, from another point of view, they were no less significant of the fulness of life subordinated to him who created it. A reference to the Apocalypse enables us to combine these conceptions with a far sublimer truth, and to explain the connection of the cherubim with the mercy-seat as a type not only of vengeance, but of expiation and forgiveness. For in the vision of John these immortalities appear in the same choir with the redeemed innumerable multitude of the universal church (iv, 7; v, 13); no longer armed with flaming swords, with wrathful aspect and repellant silence, but mingling with the elders and joining in the new song. And here, too, we find the recovered Eden, the water of life flowing freely, and the tree of life with no flame to hedge it round. Thus it is in the Apocalypse that the fullest and divinest significance is attached to this profound emblem. In the cherubim of the last book of the Bible we find the highest explanation of the cherubim in the first. The apparent wrath which excluded man from the forfeited paradise was but the mercy in disguise which secured for him its final fruition in a nobler form of life. Thus, to give the last touch of meaning to this changeful symbol, we catch in it a gleam, dim at first, but growing into steady brightness, of that redeemed created perfection, that exalted spiritual body, for which is reserved hereafter the paradise of God. Beyond this we cannot go; but we have said enough to show the many-sided applicability of this inspired conception—a many-sidedness which is the strongest proof of its value and greatness.

VI. It is important to observe the extraordinary resemblance of the cherubim, as described in Scripture, to the symbolical religious fancies of heathen nations. It is not true, in any sense, to say, with Kurz, that the animal character is far more predominant in the emblems of heathen pantheism. Even if we concede (which is more than doubtful) that the simplest conception of cherubim was represented by winged men, we find four-winged and six-winged human figures in the sculptures of Nineveh (Layard, i, 125). In fact, there is no single cherubic combination, whether of bull, eagle, and man (Layard, *Nineveh*, i, 127); man, lion, and eagle (*Ibid.* pp. 70, 849); man and eagle (*Ibid.* i, 64); man and lion (*Ibid.* ii, 468); or, to take the most prevalent (both in Scripture and in the Assyrian sculptures), man and bull (*Ibid.* i), which may not be profusely paralleled. In fact, these wood-cuts might stand for direct illustrations of Ezek. xli, 19; Rev. iv, 6 sq.; 1 Kings vii, 29, etc.; and when we also find "wheels within wheels" represented in the same sculptures (*Ibid.* ii, 448), it is Mr. Layard's natural inference that Ezekiel, "seeking to typify certain divine attributes, chose forms familiar not only to himself, but to the people whom he addressed" (*Id. Ibid.*; see, too, *Nineveh*

and *Babylon*, ii, 648); or, as we should greatly prefer to see it expressed, the familiar decorations of the Assyrian temples moulded the forms of his imagination even at its most exalted moments. But, as we have already seen, Ezekiel was far more likely to have been supplied with this imagery by the sacerdotal sympathies which impressed his memory with the minutest details of the temple at Jerusalem; and the same symbols were not exclusively Assyrian, but were no less familiar to the Egyptians (Porphyry, *de Abstinens.* iv, 9; Ritter, *Erklärung*, viii, 947; Witaius, *Ægypt.* ii, 13), the Persians (Hdt. iii, 116; Ctes. *Ind.* xii; Plin. vii, 22; Wilkinson's *Anc. Egypt.*, passim; Chardin's and Niebuhr's *Travels*), the Greeks (Pausan. i, 24, 6), the Arabians (D'Herbelot, *Bibliothèque Orient.* s. v. Simorg), and many other nations (Plin. x, 49, 69; Parkhurst's *Lexicon*, s. v.). On this subject, generally, see Kreuzer, *Symbol.* i, 495; Rhode, *Heil. Sage*, p. 217; and Rödiger in Ersch and Gruber's *Encyclopædie*, s. v. Cherub. The similarity to the sphinx is such as to have led, even in early times, to a very strong belief that the idea of the Mosaic cherubim was in some way derived from them (Clem. Alex. *Strom.* V, cap. vi, § 87, ed. Syll. p. 240; Orig. *c. Cels.* iii, p. 121; Euseb. *Præp. Evang.* iii, 12). For a number of weighty arguments to this effect, see Bochart, *Hieroz.* II, xviii, xxxiv, and xli; Spencer, *ut sup.* bk. III, chap. iv; and especially Hengstenberg, *Die BB. Mos. u. Ægypt.* p. 157 sq. Besides these external coincidences, still more striking, perhaps, are the cherubic functions ascribed in Greek mythology to the fiery-breathing bulls which guarded the golden fleece (Ovid, *Met.* vii, 104), to the winged dragon of the Hesperides, to the resuscitated Phoenix, to the Gryphons (lion-eagles) who kept the Arimaspians from their guarded gold (*Æsch. Prom.* v, 848; Meld. ii, 1; comp. Milton, *Par. Lost.* ii, 948), and to the thundering-horses that draw the chariot of Jupiter (Horace, *Od.* i, 84, 7). Influenced by too exclusive an attention to these single resemblances, Herder identifies the cherubim with the mythic gold-guarding monsters of antiquity (*Geist. der Hebr. Poes.* i, 168), and J. D. Michaelis with the Equi Tonantes (*De Cherubis*; compare Velthuyzen, *Von den Cherub.*; Schleusner, *Lex. N. Test. s. v. Χερουβίμ*). Similarly, Justin Martyr considers that Plato borrowed from the Scriptures his *πτηνὸν ἕρμα*, or "winged chariot" of Zeus (*πρὸς Ἕλληνας*, p. 80). From these conclusions we dissent. It seems far more likely that the Hebrews were, in the most ancient times, acquainted with a symbol familiar to so many nations, than to suppose either that they borrowed it from the Egyptians, or that any other nations adopted it from them. In fact, the conception belongs to the common cycle of Oriental tradition, fragments of which were freely adopted by the Hebrew writers, who always infused into them a nobler meaning and an unwonted truth.—Kitto, *Cyclop.* s. v.; Smith, *Dict.* s. v.

VII. For further information on the subject, see (in addition to works and monographs cited above) Hufnagel, *Der Cherubim im Paradiese* (Frankfurt a. M. 1821 [fanciful]); Gabler in Eichhorn's *Urgeschichte*, II, i, 246 sq.; Meyer, *Bibeldeut.* p. 171 sq.; Carpov, *Appar.* p. 268 sq.; Bemer, *Gottesd.* ii, 86 sq.; Grüneisen, in the *Stutt. Konversationsblatt*, 1884, No. 1-6; Jour. *Sacred Lit.* Oct. 1856, p. 154 sq.; *Critici Sacri*, i, 120; Leone, *De Cherubinis* (Amst. 1647; also Helmst. 1665, and in Spanish, Amst. 1654); Wepler, *De Cherubis* (Marb. 1777); Geissler, *De Cherubim* (Vitemb. 1661); Henderwerk, *De Cherub. et Seraph.* (Regiom. 1887); Jac. Ode, *Comment. de Angelis*, I, v, 78 sq.; Deyling, *Obs. Sacr.* ii, 442; Michaelis, in the *Comment. Soc. Reg. Gott.* i, 157 sq.; Velthuyzen, *Von den Cherubines* (Braunsch. 1764); Hutchinson, *Æpos. of Cherubim* (in his *Works*, Lond. 1749); Amel, *Erörterung*, pt. ii, p. 467-500; Bochart, *Hieroz.* pt. i, bk. iii, ch. 5; Labrun, *Entretiens*, pt. ii, p. 63 sq. (Amst. 1788); Fairbairn, *Typology*, i, 242 sq.; G. Smith, *Doct. of the Cherubim* (Lond. 1850);

M'Leod, *Cherubim and the Apocalypse* (London, 1856); Anon. *Angels, Cherubim, etc.* (Lond. 1861). See ΣΕΒΑΡΗΜ.

Ches'alon (Heb. *Kesalon'*, כֶּסֶלֹן, place of confidence; Sept. *Χασαλών* v. r. *Χασλών*), a place named as one of the landmarks on the west part of the north boundary of Judah, beyond Mt. Seir, and apparently situated on the shoulder (A. V. "side") of Mt. Jearim (Josh. xv, 10). This last, the "Mount of Forests," has not necessarily any connection with Kirjath-Jearim, though the two were evidently, from their proximity in this statement of the boundary, not far apart. See JEARIM. Chesalon was the next landmark to Betheshem, and it is quite in accordance with this that Dr. Robinson has observed a modern village named *Kesla*, about six miles to the N.E. of Ainsheims, on the western mountains of Judah (*Researches*, ii, 864, note; *Later Res.* p. 154). Eusebius and Jerome, in the *Onomasticon* (s. v. *Χαλασών, Chaslon*), mention a place of a similar name, but they differ as to its situation, the former placing it in Benjamin, the latter in Judah; both agree that it was a very large village in the neighborhood of Jerusalem. The position of the border-line at this point determines that it lay within Judah. See TRIBE.

Che'sed (Heb. *Ke'sed*, כֶּסֶד, of uncertain signif.; Sept. *Χαζάδ*, Vulg. *Cased*, Josephus *Χάζαδος*, *Ant.* i, 6, 5), the fourth of the eight sons of Nahor by Milcah (Gen. xxii, 22). B.C. cir. 2088. The name is the same as would be the sing. form of the Heb. for *Chaldeans*; but it is doubtful whether there is any connection. See CHALDÆA.

Che'sil (Heb. *Kesil'*, כֶּסִיל, a fool, i. e. profane, as in Psa. xlix, 11, and elsewhere; Sept. *Χεσίλ* v. r. *Χασίρ* and *Βασιήλ*; Vulg. *Cesil*), a town in the extreme south of Palestine, named between Èltolad and Hormah (Josh. xv, 80). In the list of towns given out of Judah to Simeon, the name ΒΕΘΗΛ (q. v.) occurs in place of it (xix, 4), as if the one were identical with, or a corruption of, the other. This is confirmed by the reading of 1 Chron. iv, 80, ΒΕΘΗΛ; by that of the Sept. as given above, and by the mention in 1 Sam. xxx, 27, of a ΒΕΘΗΛ among the cities of the extreme south. It is merely mentioned by Eusebius and Jerome in the *Onomasticon* (s. v. *Χουλί, Chisil*). See also URION.

Chestnut. See CHESTNUT.

Chest is the rendering in certain passages in the Auth. Vers. of two distinct Hebrew terms: 1. אָרוֹן or אֲרוֹן, *aron'* (from אָרַן, to gather; Sept. *κιβωτός*, Vulg. *gasophylacium*), invariably used for the Ark (q. v.) of the Covenant, and, with two exceptions, for that only. (It is instructive to be reminded that there is no connection whatever between this word and that for the "ark" of Noah, and for the "ark" in which Moses was hid among the flags [both אֲרוֹן, *tebah*]). The two exceptions alluded to are (a) the "coffin" or mummy-case in which the bones of Joseph were carried from Egypt (Gen. i, 26; rendered in the Targum of Ps.-Jon. by *γλώσσόκομον*—compare John xii, 6—in Hebrew letters: the reading of the whole passage is very singular); and (b) the "chest" in which Jehoia-da the priest collected the alms for the repairs of the Temple (2 Kings xii, 9, 10; 2 Chron. xxiv, 8-11). See COFFIN. 2. חֶסֶד, *gesazim'* (only in the plur.; from חָסַד, to hoard, "chests," Ezek. xxvii, 24; "treasures," Esth. iii, 9; iv, 7).

Many boxes of various forms have been discovered among the Egyptian monuments. Some of these had lids resembling the curved summit of a royal canopy, and were ornamented with the usual cornice; others had a simple flat cover, and some few a pointed summit, resembling the shelving roof of a house. The sides were secured with wooden nails and glue, and

dovetailed together. This last kind of lid was divided into two parts, one of which alone opened, turning on two small pins at the base, on the principle of the doors of their houses and temples; and, when necessary, the two knobs at the top could be tied together and sealed. These boxes were frequently of costly materials, veneered with rare woods, or made of ebony inlaid with ivory, painted with various devices, or stained to imitate materials of a valuable nature; and the mode of fastening the lid, and the curious substitute for a hinge given to some of them, show that the former was entirely removed, and that the box remained open while used. When not veneered, or inlaid with rare wood, the sides and lid were painted, and those intended for the tombs, to be deposited there in honor of the deceased, had usually funeral inscriptions or religious subjects painted upon them, among which were offerings presented by members of their family. (See Wilkinson, *Anc. Eg.* i, 168; ii, 116, abridgment.) See BOX.



Ancient Egyptian Chest.

Chester, an ancient city of England, on the river Dee, founded by the Romans. In the 13th century it had several monasteries, a college, and the hospitals of St. Anne and of St. John Baptist, the latter of which remains to this day. Under Henry VIII the Church of the monastery of St. Wesburgh became the Cathedral for the new see of Chester, which took in Cheshire (from the diocese of Litchfield) and Lancashire (from the diocese of York). The revenues of the dissolved monasteries were made a provision for the bishop, dean, and chapter. The present (1867) bishop is William Jacobson, DD., consecrated in 1865.

Chestnut-TREE (אֲרוֹן, *arnon'*; Chald. *בִּלְיָ*, Sept. *πλάτανος* [but in Ezek. *ελάτη*], Vulg. *platanus*), mentioned among the "speckled rods" which Jacob placed in the watering-troughs before the sheep (Gen. xxx, 87): its grandeur is indicated in Ezek. xxxi, 8 (as well as in *Èclus.* xxiv, 19), as one of the trees to which the Assyrian empire in its strength and beauty is likened, it being there noted for its magnificence, shooting its high boughs aloft. This description agrees well with the *plane-tree* (*Platanus Orientalis*), which is adopted by the above ancient translators, to which modern critical opinion inclines, and which actually grows in Palestine (see Ritter, *Erzk.* xi, 511 sq.). The *beek*, the *maple*, and the *chestnut* have been adopted, in different modern versions, as representing the Hebrew *arnon*, but scarcely any one now doubts that it means the *plane-tree*. It may be remarked that this tree is in Genesis associated with others—the willow and the poplar—whose habits agree with it; they are all trees of the low grounds, and love to grow where the soil is rich and humid. This is strikingly illustrated by the fact that Russel (*N. H. of Aleppo*, i, 47) expressly names the plane, the willow, and the poplar (along with the ash) as trees which grow in the same situations near Aleppo. But this congruity would be lost if the chestnut were understood, as that tree prefers dry and hilly situations. There is a latent beauty also in the passage in Ezekiel, where, in describing the greatness and glory of Assyria, the prophet says, "The *arnon-trees* were

not like his boughs, nor any tree in the garden of God like unto him for beauty." This not only expresses the grandeur of the tree, but is singularly appropriate, from the fact that the plane-trees (*čewars*, as they are called) in the plains of Assyria are of extraordinary size and beauty, in both respects exceeding even those of Palestine (comp. Plin. xii, 3; xvii, 18; Virg. *Georg.* iv, 146; Cicero, *Orat.* i, 7; Statius, *Sylv.* ii, 3, 89 sq.; Martial, ix, 61, 5). Moreover, the etymology of the word connects it with עָרָם, '*aram*', "to be naked," and with Arab. '*arām*', "to strip off bark," the shedding of its bark yearly being characteristic of the plane-tree (see Hiller in *Hierophyl.* i, 402). The account here given is chiefly from Kitto's *Cyclop.* s. v. Armon.



Oriental Plane-tree (*Platanus Orientalis*).

The Oriental plane-tree ranks in the Linnæan class and order *Monocia Polyandria*, and in the natural order among the *Platanaceæ*. Westernmost Asia is its native country, although, according to Prof. Royle, it extends as far eastward as Cashmere. The stem is tall, erect, and covered with a smooth bark which annually falls off. The flowers are small and scarcely distinguishable: they come out a little before the leaves. The wood of the plane-tree is fine-grained, hard, and rather brittle than tough; when old, it is said to acquire dark veins, and to take the appearance of walnut-wood. In those situations which are favorable to its growth, huge branches spread out in all directions from the massive trunk, invested with broad, deeply-divided, and glossy green leaves. This body of rich foliage, joined to the smoothness of the stem and the symmetry of the general growth, renders the plane-tree one of the noblest objects in the vegetable kingdom. It has now, and had also of old (Plin. *Nat. Hist.* xii, 1), the reputation of being the tree which most effectually excludes the sun's beams in summer and most readily admits them in winter, thus affording the best shelter from the extremes of both seasons. For this reason it was planted near public buildings and palaces, a practice which the Greeks and Romans adopted; and the former delighted to adorn with it their academic walks and places of public exercise. In the East the plane seems to have been considered sacred, as the oak was formerly in Britain. This distinction is in most countries awarded to the most magnificent species of tree which it produces (see Kitto, *Nat. Hist. of Palest.* p. cxxlix). In Palestine, for instance, where the plane does not appear to have been very common, the terebinth seems to have possessed pre-eminence. See OAK. In the celebrated story of Xerxes arresting the march of his grand army

before a noble plane-tree in Lydia, that he might render honor to it, and adorn its boughs with golden chains, bracelets, and other rich ornaments, the action was misunderstood and egregiously misrepresented by Ælian (*Var. Hist.* ii, 14). The Oriental plane endures more northern climates well, and grows to a fine tree, but not to the enormous size which it sometimes attains in the East. Pausanias (l. viii, c. 23) notices a noble plane in Arcadia, the planting of which was ascribed, by tradition, to Menelaus. Pliny (*Nat. Hist.* xii, 1) mentions one in Lycia, in the trunk of which had gradually been formed an immense cavern, eighty feet in circumference. L. Mutianus, thrice consul and governor of the province, with eighteen other persons, often dined and supped commodiously within it. Caligula also had a tree of this sort at his villa, near Velitra, the hollow of which accommodated fifteen persons at dinner, with a proper suite of attendants. The emperor called it "*his nest*;" and it is highly probable that his friend, Herod Agrippa, may occasionally have been one of the fifteen birds who nestled there along with him. A fine specimen of the plane-tree was growing a few years ago (1844) at Vostitza, on the Gulf of Lepanto: it measured forty-six feet in circumference, according to the Rev. S. Clark, of Battersea, who has given an interesting account of it in John's *Forest Trees of Britain* (ii, 206). The plane-trees of Palestine in ancient days were probably more numerous than they are now, though modern travellers occasionally refer to them. Belon (*Obs. Sing.* ii, 105), La Roque (*Voy. de Syrie*, p. 197-199), and others, mention the groves of noble planes which adorn the plain of Antioch; and the last-named traveller records a night's rest which he enjoyed under planes of great beauty in a valley of Lebanon (p. 76). Buckingham names them among the trees which line the Jabok (*Travels in Palestine*, ii, 108). Evelyn (in his *Sylva*) seems to ascribe the introduction of the plane-tree into England to the great Lord Bacon, who planted some which were still flourishing at Verulam in 1706. This was, perhaps, the first plantation of any note; but it appears from Turner's *Herbal* (published in 1551)



Branch of the Plane-tree.

that the tree was known and cultivated in that country before the chancellor was born. The *Platanus Orientalis*, or plane of Palestine and of classical antiquity, must not be confounded with the plane-tree commonly so called in Scotland and England. This last is a maple, *Acer pseudo-platanus*, and, like the rest of its saccharine family, it contains a sweet sap in the liburnum or under bark, for the sake of which it is often tapped by school-boys in spring. Even by those least familiar with plants, the false plane or sycamore may

readily be distinguished from the plane, Oriental and Occidental, by its seeds. In the former they are *keys*, or twin carpels, flattened into wing-like discs; in the latter they are globular caskets or catkins—balls more or less rough, which hang on the branches throughout the winter in graceful strings or tassels, suggesting the name of button-wood, by which the *P. Occidentalis* is usually known in the United States (see Celsii, *Hierob.* i, 512 sq.; Hasselquist, *Trav.* p. 526; *Penny Cyclopaedia*, s. v. Plane). See BOTANY.

Chesul'loth (Heb. with the article *hak-Kesulloth'*, חֶסְלוֹת, *the hopes* [or, according to some, *the loins*, from its position on the "flank" or slope of the mountain; comp. *Chesil*, *Chesalon*, etc.]; Sept. *Χασιλάθ* v. r. *Χασαλάθ*), a city of the tribe of Issachar, mentioned between Jezreel and Shunem, apparently near the border (Josh. xix, 18). It is probably the same with CHISLOTH-TABOR (q. v.) of verse 12, and the simple TABOR of 1 Chron. vi, 77; the modern *Keal* (Robinson's *Researches*, iii, 182; comp. Schwarz, *Palest.* p. 166). Eusebius and Jerome (*Onomast.* s. v. *Ἀρχελίθωθ*, *Archelithuth*; *Χασελούθ*, *Chaselus*) describe it as still extant under the same name (*Χαλαούθ*, *Chasalus*).

Chet'tilm (*Χεττιειμ* v. r. *Χεττειμ*, Vulg. *Cethim*), a Græcized form (1 Macc. i, 1) of the Hebrew CHIR-TIM (q. v.).

Cheverus, JEAN LOUIS, a cardinal of the Roman Church, was born at Mayenne, France, Jan. 28, 1768, of a noble family, and was set apart for the Church, being made prior of Torbechet at thirteen years of age. He received his classical education at the college of Louis-le-Grand, and his theological at the seminary of St. Magloire. He was ordained priest in 1790, and soon after became vicar of Mayenne. During the later troubles of the Revolution he took refuge in England, exercised his ministry for a while in London, and then sailed for Boston, Mass., where he passed many years of successful labor in organizing and spreading the Roman Church. In 1808 he was made bishop, and continued his labors until 1823, when, on account of failing health, he returned to France as bishop of Montauban. In 1826 he was made archbishop of Bordeaux and peer of France. His labors among all classes, rich and poor, in hospitals and prisons, were incessant, during all his service in the highest ecclesiastical posts. In 1836 he was made cardinal, and he died of apoplexy July 19 of that year. Few clergymen of the Roman Church have been more highly and deservedly esteemed by Protestants than cardinal Cheverus.—*Hoeser, Nouv. Biog. Générale*, x, 270; *Christian Examiner*, xxvi, 88; Huen-Dubourg, *Vie de Cheverus* (Engl. tr. Philad. 8vo).

Cheyneil, FRANCIS, an English Nonconformist, was born at Oxford in 1608, and was educated at the University there. He was elected fellow of Merton College in 1629, and took orders; but in 1640 he embraced the side of Parliament, and in 1648 was one of the assembly of divines and rector of Petworth. In 1647 he was made Margaret professor of divinity at Oxford, on leaving which he returned to his rectory at Petworth. At the Restoration (1662) he was deprived of his rectory, and retired to Preston, Sussex, where he died in 1665. He was a strong, if not bitter controversialist, and published, in 1648, *The Rise, Growth, and Danger of Socinianism*, in which archbishop Laud, Hales of Eton, Chillingworth, and other eminent divines are strongly charged with Socinianism. In 1644, after Chillingworth's death, Cheyneil published *Chillingworthi Novissima, or the Sickness, Heresy, Death, and Burial of William Chillingworth*, with a severe, if not abusive dedication to Drs. Bayly, Prideaux, Fell, etc., who had given their imprimatur to Chillingworth's *Religion of Protestants*. After the dedication follows the narration itself, in which Cheyneil relates how he became acquainted with "this man of reason," as he calls Chillingworth; what care he took of him, and how, as

his illness increased, "they remembered him in their prayers, and prayed heartily that God would give him new light and new eyes, that he might see, and acknowledge, and recant his error; that he might decay his carnal reason and submit to faith."—*New Gen. Biog. Dict.* iii, 806; Sketch by Dr. Johnson, *Gentleman's Mag.* March and April, 1765; Calamy, *Nonconformist's Memorial*, ii, 467.

Che'zib (Heb. *Kesib'*, כְּזִיב, *false*; Sept. *Χασιβ*), the birth-place of Shelah, Judah's youngest son by the daughter of Shuah (Gen. xxxviii, 5); probably the same with CHOZABA (1 Chron. iv, 22), and also the ACHZIB (q. v.) of later times (Josh. xv, 44). Schwarz (*Palest.* p. 201) seems to confound it with the more northern city Achzib (Josh. xix, 29), in referring to a Talmudical notice of "the river of Chezib;" an error into which also Grotius was led from the reading (*Κεζιβ*) of the Sept. at Josh. xv, 44. Jerome, however (*Quæst. Hebr.* in loc.), regards the name as an appellation merely (so Aquila, in Montfaucon's ed. of Origen's *Hexapla*, De la Rue's *Orig. Opp.* v, 287), indicating that this was the last of Bathshuah's sons.

Chichester, an ancient city of Sussex, England, the see of a bishop. It was a Roman station. The present cathedral was built in the 13th century; it is 407 feet long, 150 wide, with a tower and spire 300 feet high. The diocese comprises nearly the whole of Sussex, with a total population, in 1861, of 363,785. It has 12 deaneries and 133,512 church sittings. The present (1867) bishop is Achmet Turner Gilbert, DD., consecrated in 1842. Two provincial councils were held here, in 1289 and 1292, convened by Gilbert, bishop of Chichester.—Landon, *Manual of Councils*, p. 180.

Chichele, **Chichley**, or **Chicheley**, HENRY, archbishop of Canterbury, was born at Higham Ferrers in 1362, and was educated at Oxford. In 1407 he was consecrated bishop of St. David's by Pope Gregory XII, and in 1409 he was sent to represent the province of Canterbury at the Council of Pisa (q. v.). In 1415 he became archbishop of Canterbury. He stimulated Henry V to the war against France (see Shakespeare, *Henry V*), which he afterwards bitterly regretted, erecting All Saints' College, which still stands, as a memorial of his penitence. Chichley was a man of vigor and courage; he resisted the king and the pope, when occasion demanded, as energetically as he resisted what he thought to be the heresy of the followers of Wickliffe. He died at Canterbury, April 12, 1443.—*Duck, Life of Chichele* (Lond. 1699, 8vo); Kippis, *Biographia Britannica*, iii, 499; Hook, *Eccles. Biog.* iii, 575 sq.

Chicken (*ποσειον*, *pullus*), a word that occurs but twice in the English Bible (2 Esdr. i, 30; Matt. xxiii, 37), and only in allusion to "a hen (q. v.) gathering her chickens under her wings." See FOWL.

Chl'don (Heb. *Kidon'*, כִּידֹן, a *dart*; Sept. *Χαιδών*, but some omit), the name which in 1 Chron. xiii, 9 is given to the threshing-floor at which the accident to the ark, on its transport from Kirjath-jearim to Jerusalem, took place, and the death of Uzzah; on this account it was afterwards known as PEREZ-UZZAH. In the parallel account in 2 Sam. vi, the name is given as NACHON (q. v.), which is nearly equivalent in sense. Whether there were really two distinct names for the same spot, or whether the one is simply a corruption or alteration of the other, is quite uncertain (see Gesenius, *Thesaur.* p. 683; Simons, *Onom.* p. 339-40). Josephus (*Ant.* vii, 4, 2) has "Chidon" (*Χαιδών*). Some have even ventured to identify the spot with the threshing-floor of Ornan the Jebusite, on Mount Moriah. The Jewish tradition (Jerome, *Quæst. Hebr.* on 1 Chron. xi, 9) was that Chidon acquired its name from being the spot on which Joshua stood when he stretched out the weapon of that name (A. V. "spear") towards Ai (Josh. viii, 18). But this is irreconcilable with all our ideas of the topography of the locality, which was evi-

ently not far N.W. of Jerusalem, possibly at the present ruins *Kharbet el-Bistus* (Van de Valde's Map).

Chief Captain. See CHILMARCH.

Chief Musician. See MUSIC.

Chief of Asia. See ASIARCH.

Chief of Three (שָׁלִישֵׁי שָׂרֵי צְבָאוֹת, *rosh hash-shalishim*), rather שָׁלִישִׁים, *shalishim*, the *third-men*), a title of *limo* (q. v.) the Ezrite, one of David's greatest bravest; Sam. xxiii, 8; Sept. *πρωτος των τριων*; Vulg. *primus inter tres*; A. V. "chief among the captains"), otherwise called Jashobeam (1 Chron. xi, 11, where he text again corruptly has שָׁלוֹשִׁים, *shaloshim*; Sept. *πρωτος των τριων*; Vulg. *primus inter tribus*; A. V. "chief of the captains"), and also of Ishai (2 Sam. xxiii, 18, שָׁלִישֵׁי, *τριων*, *de tribus*, "among three", and Amasa (1 Chron. xii, 18, שָׁלִישֵׁי, *τριων*, *inter triginta*, "of the captains"). In all these passages it designates the superior officer or commander of the *tristata*, *essaris*, or warriors who fought three in a chariot, and formed the phalanx nearest the king's person (Lydius, *Syntagma de re militari* (lib. ii, c. iii, p. 39)). He is also briefly called שָׁלִישֵׁי, *hash-shalish* (lit. *the ternary*) = *aid-de-camp*, a general executive officer (2 Kings vii, 2, 17, 19; ix, 5; xv, 25), like the Roman "master of horse." See CAPTAIN.

Chief Priest. See PRIEST.

Chief Ruler. See SYNAGOGUE.

Child (properly יָלֵד, *ye'led*, *ricknov*; but represented by several other Hebrew and Greek words; comp. CHILDREN). Mothers, in the earliest times, suckled their offspring themselves until they were from thirty months to three years of age. The day on which a child was weaned was a festival (Gen. xxi, 8; Exod. ii, 7, 9; 1 Sam. i, 22-24; 2 Chron. xxxi, 16; Matt. xxi, 16). Nurses were employed, in case the mother died before the child was old enough to be weaned, and when, from any circumstances, she was unable to afford a sufficient supply of milk for its nourishment. In later ages, when matrons had become more delicate, and thought themselves too infirm to fulfil the duties which naturally devolved upon them, nurses were employed to take their place, and were reckoned among the principal members of the family. They are, accordingly, in consequence of the respectable station which they sustained, frequently mentioned in sacred history (Gen. xxxv, 8; 2 Kings xi, 2; 2 Chron. xxii, 11). The sons remained till the fifth year in the care of the women; they then came into the father's hands, and were taught not only the arts and duties of life, but were instructed in the Mosaic law, and in all parts of the religion of their country (Deut. vi, 20-25; xi, 19). Those who wished to have them further instructed either employed private teachers, or sent them to some priest or Levite, who sometimes had a number of other children under his care. It appears from 1 Sam. i, 24-28, that there was a school near the holy tabernacle dedicated to the instruction of youth. There had been formerly many other schools of this kind, which had fallen into discredit, but were restored by the prophet Samuel, after whose time the members of the seminaries in question, who were denominated by way of distinction the *sons of the prophets*, acquired much celebrity. The daughters rarely departed from the apartments appropriated to the females, except when they went out with an urn to draw water, or occasionally joined in the labors of the field—as keeping sheep, which was the practice with those who belonged to those humbler stations in life in which the more ancient simplicity of manners was still retained (Gen. xxiv, 16; xxix, 9; Exod. ii, 16; 1 Sam. ix, 11; Ruth ii, 2; John iv, 7). They spent their time in learning those domestic and other arts, which are befitting a woman's situation and character, until they arrived at

that period in life when they were to be sold, or, by a better fortune, given away in marriage (Prov. xxxi, 13; 2 Sam. xiii, 7). The daughters of such as possessed rank and wealth spent the greater part of their time within the walls of their palaces, and, in imitation of their mothers, amused themselves with dressing, singing, and dancing. Sometimes their apartments were the scenes of vice (Ezek. xxiii, 18). They went abroad very rarely, but they received with cordiality female visitants. The sports of children were doubtless such as have always prevailed among youth, especially in the East. Hackett (*Illustrations of Script.* p. 120) mentions having seen Oriental boys even amusing themselves with flying a kite, and playing at leap-frog and ball.

The more children—especially of male children—a person had among the Hebrews, the more was he honored, it being considered a mark of divine favor, while sterile people were, on the contrary, held in contempt (comp. Gen. xi, 30; xxx, 1; 1 Sam. ii, 5; 2 Sam. vi, 23; Psa. cxxvii, 3 sq.; cxxviii, 8; Luke i, 7; ii, 5). That children were often taken as bondmen by a creditor for debts contracted by the father, is evident from 2 Kings iv, 1; Isa. i, 1; Neh. v, 5. Among the Hebrews a father had almost unlimited power over his children, nor do we find any law in the Pentateuch restricting that power to a certain age; it was, indeed, the parents who even selected wives for their sons (Gen. xxi, 21; Exod. xxi, 9, 10, 11; Judg. xiv, 2, 5). It might of course be expected, while they lived in their father's house, and were in a manner pensioners on his bounty, that he would exercise his authority over the children of his sons, as well as over the sons themselves. In this case the power of the father had no narrow limits, and whenever he found it necessary to resort to measures of severity, he was at liberty to inflict the extremity of punishment (Gen. xxxviii, 24). This power was so restricted by Moses that the father, if he judged the son worthy of death, was bound to bring the cause before a judge. But he enacted, at the same time, that the judge should pronounce sentence of death upon the son if, on inquiry, it could be proved that he had maltreated his father or mother, or that he was a spendthrift, or contumacious, and could not be reformed (Exod. xxi, 15, 17; Lev. xx, 9; Deut. xxi, 18, 21). It would appear, however, that a father's power over his daughters was still greater than that over his sons, since he might even annul a sacred vow made by a daughter, but not one made by a son (Num. xxx, 4, 16). Children cursing or assaulting their parents were punished by the Mosaic law with death (Exod. xxi, 15, 17; Lev. xx, 9), a remarkable instance of which is quoted by Christ (Matt. xv, 4, 6; Mark vii, 9, 13). The authority of the parents, and the service and love due to them, are recognised in the most prominent of the moral laws of the Jewish polity, the Ten Commandments (Exod. xx, 12); but the Pharisees devised a mode of evasion which our Lord strongly reprobates (Matt. xv, 5, 6; Mark vii, 11-13). The prophetic curse or blessing of the father also possessed no little efficacy (Gen. xlix, 2, 28). (On punishing children for their parents' faults, Ezek. xviii, see MUSEUS, *De jure puniendi liberos propter pecc. parent.* Lips. 1714.) Children who were slaves by birth are mentioned in the Scriptures as those born in the house; the children of maid-servants, the sons or children of the house (Gen. xiv, 14; xv, 3; xvii, 23; Psa. lxxxvi, 16; cxvi, 16). Few things appear more shocking to humanity than the custom, of which frequent mention is made in Scripture, of making children pass through fire in honor of Moloch, a custom the antiquity of which is proved by its having been repeatedly forbidden by Moses (Lev. xviii, 21; xx, 1, 5; 2 Kings xvi, 8). See MOLOCH.

There are some allusions in Scripture to the modes in which children were carried. These appear to be adequately represented by the existing usages, as

shown in the following cut, in which fig. 1 represents a Nestorian woman bearing her child bundled at her back, and fig. 2, an Egyptian female bearing her child



Oriental Mothers carrying their Children.

on her shoulder. The former mode appears to be alluded to in several places, and the latter in Isa. xlix, 22. (See Hackett's *Illustrations of Script.* p. 57.)

In Scripture the word "child," or "children," has considerable latitude; disciples are often called children or sons. Solomon, in his Proverbs, says to his disciple, "Hear, my son;" so also our Saviour (John xxi, 5). The descendants of a man, how remote soever, are denominated his sons or children, as "the children of Edom," "the children of Moab," "the children of Israel." Such expressions as "the children of light," "the children of darkness," "the children of the kingdom," signify those who follow truth, those who remain in error, and those who belong to the Church. Persons arrived almost at the age of maturity are sometimes called children. Thus Joseph is termed "the child," though he was at least sixteen years old (Gen. xxxvii, 30), and Benjamin, even when above thirty, was so denominated (Gen. xlv, 20). Solomon called himself a little child when he came to the kingdom of his father (1 Kings iii, 7). See ADOPTION; BIRTH; SON; INHERITANCE; EDUCATION, etc.; and comp. OFFSPRING.

CHILD OF GOD. The terms "child," "children," "babe," etc., are used in the N. T. in the following senses:

I. *Psychologically* these terms are used to denote a state of ignorance and of intellectual narrowness or darkness (Matt. xi, 16; Luke vii, 32; 1 Cor. xiii, 11: "When I was a child, I spake as a child, I understood as a child, I thought as a child;" xiv, 20: "Brethren, be not children in understanding;" Eph. iv, 14: "That we henceforth be no more children, tossed to and fro," etc.; Heb. v, 18: "For every one that useth milk, is unskilful in the word of righteousness: for he is a babe").

II. In the *ethical* sense, they are used, in the abstract, to designate a state of innocence, and, in the concrete, to signify the totality of children, towards whom holy duties are to be fulfilled by the community, and particularly by parents. We see even that the appellation "children" is used by the Lord as an expression of his greatest love (Mark x, 24). Children are then distinguished by moral preference; yet from this it does not follow that they are holy, but merely that they are yet uncontaminated by actual contact with the world. They are, therefore, partly to be imitated, partly to be restrained, and in all cases to be the objects of the greatest moral solicitude. As duties of parents towards children, the N. T. names the providing for their wants, giving them good examples, and bringing them up in the fear and knowledge of the Lord. Children, on the other hand, are to be obedient to their parents. That the N. T. does not give a more systematic view of the relative moral duties of parents and children is to be accounted for on the ground that where faith and love are found, all the rest follows naturally (Matt. vii, 9-11; Luke xi, 11: "What man is there of you, whom if his son ask bread, will he give him a stone? Or if he ask a fish, will he give him a serpent? If ye, then, being evil, know how to give good gifts unto your children, how much more

shall your Father which is in heaven give good things to them that ask him?" xviii, 1-5; Mark ix, 34; Luke ix, 47, 48: "At the same time came the disciples unto Jesus, saying, Who is the greatest in the kingdom of heaven? And Jesus called a little child unto him, and set him in the midst of them, and said, Verily I say unto you, Except ye be converted, and become as little children, ye shall not enter into the kingdom of heaven. Whosoever, therefore, shall humble himself as this little child, the same is greatest in the kingdom of heaven; and whoso shall receive one such little child in my name, receiveth me"). See also Mark x, 18-16; Matt. xix, 18-15; Luke xviii, 15-17; 2 Cor. xii, 14; Eph. vi, 1-4; Col. iii, 20, 21.

III. In the *spiritual* sense, the expression "children" designates those who have become children of God through Christ. To be a child of God through Christ is to have attained the highest (moral) perfection, and the greatest degree of holiness of which human nature is susceptible. This consciousness of its holy purity is one of the characteristics of Christianity (Matt. xi, 19; Luke vii, 33-35: "The Son of man came eating and drinking, and they say, Behold, a man gluttonous, and a wine-bibber, a friend of publicans and sinners. But Wisdom is justified of her children;" i. e. those whom Christ recognises as his prove by words and deeds that they are the children of wisdom. See also Matt. v, 9; xv, 26; John i, 12; Rom. viii, 14-17: "For as many as are led by the Spirit of God, they are the sons of God. For ye have not received the spirit of bondage again to fear; but ye have received the Spirit of adoption, whereby we cry, Abba, Father. The Spirit itself beareth witness with our spirit that we are the children of God. And if children, then heirs; heirs of God, and joint heirs with Christ, if so be that we suffer with him, that we may be also glorified together;" Rom. ix, 8; Gal. iii, 26: iv, 5, 6; Eph. i, 5; Phil. ii, 15; 1 John iii, 1, 2, 9, 10: v, 1, 2; Eph. iii, 15; Luke xx, 36; Rom. viii, 23, etc.). —Krehl, *Handwörterb. d. N. T.* s. v. See ADOPTION.

Childbirth (*ἡγεγονία*, "child-bearing"). The throes of accouchement appear in Gen. iii, 16, to be part of the doom incurred by woman for her agency in the fall in Eden. Her passive lot in thus continuing the race is aptly expressed in that primeval sentence: "Unto the woman he said, I will greatly multiply thy sorrow and thy conception; in sorrow thou shalt bring forth children; and thy desire shall be to thy husband, and he shall rule over thee." See COHABITATION. The language of the apostle in 1 Tim. ii, 15, implies that a patient endurance of this penalty shall contribute to woman's spiritual benefit. The Prayer-book of the Church of England prescribes a form of public thanksgiving to be offered for women after safe delivery in childbed. See BIRTH; CHURCHING.

Childermas. See INNOCENTS' DAY.

Children, CHURCH MEMBERSHIP OF. See INFANT CHURCH MEMBERSHIP.

Children, COMMUNION OF. See INFANT COMMUNION.

Childs, JOHN WESLEY, a minister of the Methodist Episcopal Church South, was born in Calvert Co., Md., in 1800. In 1814 he went to Richmond, Va., where he was employed as a clerk. In 1826 he received license as a local preacher; in 1827 he entered the Baltimore Conference on probation; and in 1829 he was admitted into full connection. In 1844, when the Methodist Episcopal Church was divided on the slavery question, he adhered to the Southern Church, and continued to serve in important appointments up to the year of his death. He died May 9, 1850, at Norfolk, Va., in great peace. "His highest distinction lay in his extraordinary spirituality, his deadness to the world, his devotion to Christ; and in this respect it may reasonably be doubted whether he has had his superior in modern times."—Sprague, *Ancals*, vii, 730.

Chil'ëab (Heb. *Kilab* כִּילָב, *protected by the father*, i. e. *God*; Sept. *Κελεύβ* v. r. *Δαλουβ*), the second son of king David by Abigail, Nabal's widow (2 Sam. iii, 8), called in the parallel passage (1 Chron. iii, 1) by the equivalent name DANIEL (q. v.). The reason of this twofold name is uncertain; but for the rabbinical notions concerning it, and some speculations of his own, see Bochart, *Hieroz.* i, 608.

Chili, a republic of South America, with an area of about 170,000 square miles, and, according to the census of April, 1866, a population of 2,084,945 souls, almost exclusively Roman Catholic. There is one Roman archbishopric at Santiago, and three bishoprics at Serena, la Concepcion, and San Carlos de Chiloe (Ancud). The number of parish priests in 1868 was 153, of convents of monks 41, of convents of nuns 7; and a law provided that in future none of the 18 provinces should have more than one convent of every order. In 1824 the landed property of the Church was confiscated, and since that time the clergy have been paid by the state. In the budget of 1847, 180,080 pesos [Spanish dollars] were appropriated for this purpose. The educational institutions are far ahead of those of any other South American state. At the University of Santiago, which was reorganized in 1842, and which superintends, as the Supreme Educational Board of the state, all other educational institutions, several German Protestant professors have been teaching since 1857. The *Revista Católica*, published at Santiago, is considered by Romanists as one of the best papers of the Roman Church in South America.

In July, 1865, the Chilean Congress had a long and animated discussion on amending Article 5 of the Chilean Constitution, which is as follows: "The religion of the republic of Chili is the Roman Catholic, to the exclusion of the public exercise of any other." The discussion terminated in a way quite satisfactory to the Liberal party, notwithstanding the full strength of the Ultramontane party was brought to bear in favor of the old article. The amendment to the Constitution, as adopted by Congress and sanctioned by the executive, declared: 1. That worship within buildings belonging to private persons is allowed to those who do not profess the Roman Catholic religion; and, 2. That dissenters are allowed to establish and sustain private schools for the instruction of their own children. The first Protestant mission of Chili was established for Americans and Englishmen in Valparaiso in 1846, and has now become self-sustaining. The congregation had in 1867 50 communicants, and the number of Sunday-school scholars rose in 1859 to 100. A second Protestant mission has been established in Valparaiso for the German residents. In Santiago, the capital of the republic, the Protestant (chiefly American) residents in January, 1866, fitted up a chapel at an expense of \$800, capable of seating 125 persons. The press of the city generally made a kindly notice of the opening exercises, in which the American and the English ministers took part, and not the least sign of dissatisfaction was manifested. The Protestants with great unanimity came forward in support of the movement, and within one week after the opening of the chapel all the pews were rented. In 1860 a missionary of the South American Missionary Society (of England), the Rev. Allen Gardiner, established himself at Lota, in Arauco Bay (Southern Chili), a town which derived its chief importance from the coal mines in its neighborhood. In 1859 not less than 84 of these were worked, and some 8000 workmen were connected with them. At the request of the English and Scotch families engaged in the Lota mines, Mr. Gardiner established Sunday services at the mission-house, and a Sunday-school for the children. The opposition at first shown by a portion of the Roman Catholic population was gradually overcome, and the Protestant mission procured and secured religious toleration for the Protestant community of the

Lota mines, by a contract signed to that effect at the company's office in a public manner, and after a public meeting, and without a dissenting voice. The missionaries also took care of the spiritual interests of the sailors visiting Arauco Bay, and provided the German settlers in the neighborhood with opportunities of Christian worship. Having in the meanwhile acquired and perfected themselves in the Spanish language, they, in 1865 and 1866, made several itinerant visits into the territory of the Indians, and took the preliminary steps for establishing the Indian missions upon a firm basis. In 1866 the society had stations at Lota and Coquimbo, at El Carme in Northern Patagonia, Keppel Island (Falkland), besides one or two stations among the Araucanian Indians. In Dec. 1866, the society's ship, the "Allen Gardiner," left England with four natives of the Terra del Fuego, who had received a Christian education in England. The first German missionary was sent to Southern Chili in 1866 by the Gustavus Adolphus Society of Germany. He began preaching half of the time at Orsono, and the other half at Puerto Monte, a (mostly German) town of 15,000 inhabitants, in a region which, as late as 1850, was peopled only by small bodies of savages. The German Protestants of this town have bought a house in the principal square, and propose to build a chapel.

Chiliaroh (χίλιαρχος, *captain of a thousand*; A. V. "high captain," Mark vi, 21; "captain," John xviii, 12; Rev. xix, 18; elsewhere "chief captain"), a military title occurring frequently in the (Greek) New Test. in the following senses. See ARMY. 1. As a general state officer (Mark vi, 21; Acts xxv, 28; Rev. vi, 15; xix, 18; comp. Josephus, *Ant.* vii, 2, 2). 2. Specifically, a *tribune* of the soldiers among the Romans, six of whom formed the field officers of every "legion" (q. v.), corresponding in rank nearly to our colonel (see Smith's *Dict. of Class. Antiq.* s. v. *Exerctus*); in the N. T. spoken individually of Claudius Lysias, who, as military tribune, in the capacity of a modern major, commanded the garrison of Fort Antonia at Jerusalem (Acts xxi, 31 sq.; comp. Herodian, ii, 12, 18; Dion. Hal. *Ant.* vi, 4). 3. Particularly applied to the *prefect* or (Levitical) superintendent of order in the Temple (John xviii, 12). See CAPTAIN.

Chiliaam. See MILLENNIUM.

Chiliasts. See ADVENTISTS; MILLENARIANS.

Chil'ïôn (Heb. *Kilyon* כִּילְיֹן, *pinning*; Sept. *Χελεύβ* v. r. *Χελαίων*), the younger son of Elimelech and Naomi of Bethlehem, and husband of Orpah, Ruth's sister; he died childless in the country of Moab (Ruth i, 2; iv, 9). B. C. 1860.

Chillingworth, WILLIAM, an eminent English divine and controversialist, was born at Oxford, October, 1602. (The following account of him is modified from an article in the *English Cyclopædia*, which is based on the *Biographia Britannica*.) In 1618 he was a scholar, and in 1628 a fellow, of Trinity College in that University. Some curious memoirs of him are preserved by Anth. Wood ("Athen. Oxon." c. 20), who says "he would often walk in the college grove, and dispute with any scholar he met, purposely to facilitate and make the way of *wrangling* common with him, which was a fashion used in those days, especially among the disputing theologians, or those who set themselves apart purposely for divinity." The comparative merits of the English and Romish churches were at that time a subject of zealous and incessant disputation among the University students, and several learned Jesuits succeeded in making distinguished proselytes among the Protestant clergy and nobility. Chillingworth, being an able disputant, was singled out by the famous Jesuit Fisher, alias Johannes Perseus (*Biblioth. Soc. Jew*), by whom he was convinced of the necessity for an infallible living "Rule of Faith." On this he at once adopted the Roman Catholic system, wrote out his reasons for abjuring

Protestantism, and joined the Jesuits in their college at Douay. After the lapse of a few months, the arguments addressed to him by his godfather Laud, then bishop of London, induced him to abandon his new faith, and he returned to Oxford in 1681, where he passed about four years in reconsidering the Protestant tenets. The reading of Daille on the *Right Use of the Fathers* is said to have finally determined him.

In 1685 he published his great work, *The Religion of Protestants, a safe Way to Salvation*. It passed through two editions in less than five months. The principle of Chillingworth is that the volume of Divine Scriptures, ascertained to be such by the ordinary rules of historical and critical investigation, is to be considered the sole authority of Christians, to the utter exclusion of ecclesiastical tradition. The Jesuit Knott, alias Matthias Wilson (*Biblioth. Patrum Soc. Jesu*, p. 185), contended that he "destroyed the nature of faith by resolving it into reason." Cheynell (q. v.) also opposed Chillingworth from the Puritan side. Chillingworth in the mean time, unable to approve every statement in the Thirty-nine Articles, refused to accept any preferment in the Church. "However, in a very short time he was persuaded by the arguments of Sheldon and Laud that peace and union are the real object of subscription, not belief or assent—a doctrine held by Archbishop Sancroft and many other eminent divines. Accordingly he accepted the chancellorship of Salisbury, with the prebend of Brixworth, Northamptonshire, annexed. Chillingworth, in 1640, was deputed by the chapter of Salisbury as their proctor to the Convocation in London. He was attached very zealously to the royal party, and wrote a treatise (unpublished) on *The Unlawfulness of resisting the lawful Prince, although most impious, tyrannical, and idolatrous*." Being present in the army of Charles I at the siege of Gloucester, August, 1643, he acted as engineer, and devised the construction of engines, in imitation of the Roman "testudines cum pluteis," to assault the rebels and take the city by storm. Having accompanied the king's forces under Lord Hopton to Arundel Castle, he was there, with his comrades, taken prisoner by the Parliament army under Sir William Waller, and falling ill, he was thence conveyed to the bishop's palace at Chichester, where he died, and was buried in January, 1644. (The precise date is not ascertained, but it was probably January 30.) Dr. Cheynell, then rector of Petworth, who had shown Chillingworth great kindness during his illness, appeared at the grave, with the work of Chillingworth (*Religion of Protestants*) in his hand, and, after an admonitory oration on the dangerous tendency of its rationalism, he flung it into the grave, exclaiming, "Get thee gone, thou cursed book, which has seduced so many precious souls; get thee gone, thou corrupt, rotten book, earth to earth, dust to dust—go rot with thy author!" See CHEYNELL.

The result of his remarkable proficiency in "wrangling" is stated by his friend Lord Clarendon (*History of the Rebellion*) to have been that "Chillingworth had contracted such an irresolution and habit of doubting, that at last he was confident of nothing." Tillotson styled him "the incomparable Chillingworth;" and Locke says (on "Education"), "If you would have your son to reason well, let him read Chillingworth;" and again (on "Study"), "For attaining right reasoning I propose the constant reading of Chillingworth; for this purpose he deserves to be read over and over again;" but Anth. Wood's opinion is not outdone by any, for he declares that "Chillingworth had such extraordinary clear reason that, if the great Turk or the devil could be converted, he was able to do it." In theology he is classed with the "Latitudinarians" (q. v.). The best edition of *The Religion of Protestants* is that in fol. 1742, with sermons, etc., and a life of the author by Dr. Birch. It has been often reprinted.—Des Maizeaux, *Life of Chillingworth*

(1725, 8vo); Kippis, *Biographia Britannica*, iii, 506 sq.; Hook, *Eccles. Biography*, iv, 1. The best modern edition of his works is that of Oxford, 1828 (3 vols. 8vo). There is also a cheap American edition (8vo), with *Life* by Birch (Philadelphia, 1848).

Chil'mad (Heb. *Kilmad*, כִּילְמַד, etymology unknown; Sept. Χαρμάν v. r. Χαλμάν and Χαλμάρ; Vulg. *Chelmad*), an Asiatic place or country mentioned, in conjunction with Sheba and Asshur, as a trading emporium with the Tyrians (Ezek. xxvii, 23). The only name bearing any similarity to it is *Charmad* (Χαρμάνθη), a "large and flourishing" town near the Euphrates, between the Mascas and the Babylonian frontier (Xen. *Anab.* i, 5, 10; comp. Steph. Byz. p. 784), an identification generally adopted since Bochart (*Canaan*, i, 18, p. 480). Hitzig (*Comment. on Ezek.* l. c.) proposes to alter the punctuation to כִּילְמַד, *Ke-limmad*, giving the sense "Asshur was as thy pupil in commerce," as first suggested by Kimchi (in loc.). The Chaldee Targum has כִּילְמַד, *Medisa*. For other conjectures, see Rosenmüller in loc. See CHALDEEA, p. 158.

Chime. See BELL; CYMBAL.

Chimere (Fr. *chimère*, from the Italian *zimbardo*). The upper robe worn by a bishop, to which the lawn sleeves are generally attached. Before Elizabeth's time the bishops wore a scarlet chimere over the rochet, as they still do when assembled in convocation; but bishop Hooper having scrupled at the scarlet, it was changed for black satin.—Palmer, *Orig. Liturgica*, ii, 819.

Chim'ham (Heb. *Kimham*, כִּמְחָם, *Kim'ham*; Sept. Χιμαάμ v. r. Χαμαάμ), a follower, and probably a son (Joseph. *Αξιμωνος*, *Ant.* vii, 11, 4; and comp. 1 Kings ii, 7) of Barzillai the Gileadite, who returned in his stead from beyond Jordan with David on his restoration after Absalom's rebellion (2 Sam. xix, 37, 38, 40, which last verse gives the name as כִּמְחָם, *Kimham*). B. C. 1023. David appears to have bestowed on him, as a reward for his loyalty, a possession at Bethlehem, on which, in later times, an inn or *khán* (כְּרִית), called after him (Sept. Γηθρωδχαμάμ; Vulg. *peregrinantes in Chamaan*; A. V. "habitation of Chimham"); the text has the name כִּמְחָם, i. e. כִּמְחָם, *Kemuham*; Sept. v. r. Γαβανρωχάμα, γῆ Βαρώδ Χαμάμ, etc.), was standing, well known as the starting-point for travellers from Jerusalem to Egypt (Jer. xli, 17). Blunt notices in this mention of the dwelling of Chimham at Bethlehem an indication of the actual munificence of David to the family of Barzillai, for which we are prepared by the narrative in Samuel and Kings (*Undesigned Coincidences*, 6th ed. p. 150). See INN.

Chimney (אֲרֻבָּה, *arubbah*), a lattice, in the sing., Hos. xiii, 8; Sept. *καρνοδοχῆ*; Vulg. *fumarium*; elsewhere in the plur. a window, as closed by lattice-work instead of glass, Eccl. xii, 8; a *door-cote*, as sealed with lattice-work, Isa. lx, 8, especially in the phrase "windows of heaven" [q. v.], an opening covered with lattice-work through which the smoke passes (Hos. xiii, 8). The same word is elsewhere rendered "window." Houses in the East are not furnished with stoves and fireplaces as among us. The fuel is heaped into a pot, which is placed in a part hollowed out for that purpose in the centre of the paved floor. The smoke, therefore, escapes through the windows (Isa. xlv, 16; xlvii, 14). See HOUSE. Sometimes the fire is placed directly in the hollow place, or hearth, in the middle of the floor, as mentioned by Jeremiah (xxxvi, 22). Chimneys appear to have been employed in the round towers for furnaces, but never in dwelling-houses. They were termed *Cor-Asham*, a smoking furnace, which is the name of a city mentioned in 1 Sam. xxx, 80, probably where many workers in metal resided. Such appears to be referred to by the

“chimneys in Sion” of the Apocrypha (2 Eedr. vi, 4, *caemina*). See FURNACE.

China (see SINIM), a vast country of Asia, extending (including its dependencies) from 20° to 56° N., and from 144° 50' E. to 90° E. Its area is over four and a half million square miles, including one third of Asia, and nearly one tenth of the habitable globe. The empire is divided into three principal parts: first, the eighteen provinces; second, Manchooria; third, colonial possessions. The last includes Mongolia, Sungaria, Eastern Turkistan, Roko-nor, and Thibet. The second is the native country of the Manchoes, the reigning family in China, and includes the territory lying east of the Inner Duarian Mountains, and north of the Gulf of Lian Yung. The first division is China Proper (between 18° and 40° N. lat., including Hainan on the south; and between 98° and 124° E. long.). It is the only part settled by Chinese. “It lies on the eastern slope of the high table-land of Central Asia, and in the south-east angle of the continent, and for beauty of scenery, fertility of soil, salubrity of climate, magnificent and beautiful rivers, and variety and abundance of its productions, will compare with any portion of the globe” (Williams, *Middle Kingdom*, i, 7). Its estimated area is nearly 2,000,000 square miles, or two fifths of the empire.

and impartial judgment; and those who have resided long in the country, and know them well, have arrived at very different conclusions. M. Huc asserts that they are ‘destitute of religious feelings and beliefs,’ ‘skeptical and indifferent to everything that concerns the moral side of man,’ ‘their whole lives but materialism put in action;’ but ‘all this,’ says Mr. Meadows (*The Chinese and their Rebellions*, Lond. 1856), ‘is baseless calumny of the higher life of a great portion of the human race.’ He admits, indeed, that these charges are true of the mass of the Chinese, just as they are true of the English, French, and Americans; but as among these there is a large amount of generosity and right feeling, and also ‘a minority higher in nature, actuated by higher motives, aiming at higher aims,’ so also, he maintains, is there among the Chinese a similar right feeling, and a like minority who live a higher life than the people generally. The Chinese are, as a race, unwarlike, fond of peace and domestic order, capable of a high degree of organization and local self-government, sober, industrious, practical, unimaginative, literary, and deeply imbued with the mercantile spirit. It is to be observed that the inhabitants of China Proper are essentially one people, the differences, except in dialect, being hardly more marked than between the Northumbrian peasant and



Map of China Proper.

I. Population, Usages, etc.—The total population of China Proper was 371 millions in 1815, 396 millions in 1852, and is at present estimated at 410 or 420 millions.

This vast population has an ancient and peculiar civilization. The Chinese are generally classed in the Mongolian variety of the human race. “A tawny or parchment-colored skin, black hair, lank and coarse, a thin beard, oblique eyes, and high cheek-bones, are the principal characteristics of the race. Of the general character of the Chinese, it is not easy to form a fair

the Cornish miner. The south-eastern Chinese—the people of Kwang-tung, Fuh-keen, and the south of Che-keang—are the most restless and enterprising in all the eighteen provinces, and may be regarded as the Anglo-Saxons of Asia. In the mountainous districts of the four south-eastern provinces of China, but principally in Kwang-se, are certain tribes who maintain a rude independence, wear a peculiar dress, and are descended from the aboriginal inhabitants of China. Of these the Meaou-tze are the best known.

"Women hold a very inferior position, and are little better than slaves. Polygamy is not recognised by law, but secondary wives are common, especially when the first proves barren. Infanticide, though regarded as a crime, is undoubtedly practised to some extent, as is proved by edicts issued against it. Milne (*Life in China*) denies its prevalence [but Doolittle (vol. ii, ch. viii) abundantly confirms it]. Parents possess almost unlimited authority over their children. The intercourse of the Chinese with each other, especially in the upper classes, is regulated by a tedious and elaborate etiquette; indeed, they are the slaves of custom, and everything is done by precedent. 'A Chinaman,' says Mr. Oliphant, 'has wonderful command of feature; he generally looks most pleased when he has least reason to be so, and maintains an expression of imperturbable politeness and amiability when he is secretly regretting devoutly that he cannot bastinate you to death.' The *Le-King*, or Book of Rites, regulates Chinese manners, and is one cause of their unchangeableness, for here they are stereotyped and handed down from age to age. The ceremonial usages of China have been estimated at 8000, and one of the tribunals at Pekin—the Board of Rites—is charged with their interpretation.

"In everything that relates to death and sepulture, the customs of the Chinese are singular. They meet their last enemy with apparent unconcern; but, while their future state troubles them little, they regard the quality of their coffins as of vital importance, and frequently provide them during their lifetime; indeed, a coffin is reckoned a most acceptable present, and is frequently given by children to their parents. Education, as the high road to official employment, to rank, wealth, and influence, is eagerly sought by all classes. Literary proficiency (confined, however, to the ancient 'classics' of the country) commands everywhere respect and consideration, and primary instruction penetrates to the remotest villages. Self-supporting day-schools are universal throughout the country, and the office of teacher is followed by a great number of the *litterati*. Government provides state examiners, but does not otherwise assist in the education of the people" (Chambers, *Encyclopædia*, s. v.). The best modern account of the customs and religious usages of the Chinese is given in Doolittle's *Social Life of the Chinese* (N. Y., Harper and Brothers, 1865, 2 vols. 12mo). See also Oliphant, *Narrative of the Earl of Elgin's Mission to China and Japan* (N. Y., Harper and Brothers, 1859, 8vo).

There is a general impression that the climate of China is specially insalubrious. That this is not so may be seen from the following statement, condensed from the *Chinese Repository* (vol. xvi, p. 12 sq.): "From the commencement of Protestant missions in China, by the Rev. Dr. Morrison, A.D. 1807 to 1847, a period of forty years, eighty-six missionaries had entered this field. During that time twelve died, and twenty-three retired from the work. Of those who died, one had lived twenty-seven years in the field, another sixteen years, two for eight years, and the rest for shorter periods. Thus, on an average, during forty years, the number of deaths among the Protestant missionaries was at the rate of one in three years. Of those who retired from the work, some engaged in other departments of labor in China; some returned, for various reasons, to their native land, and others were obliged, in consequence of ill health, to leave the field. Forty-one of the eighty-six are still in China. Of these, one has been more than thirty years in the field, and still enjoys excellent health. Others have been here for twenty, ten, and five years, according to the time they entered the work. We have not the means for making an extensive comparison, but we think these statistics will compare favorably with those of any body of ministers in America or England. It should also be remembered, that as China has only recently been

opened to missionaries, a great part of those referred to in the foregoing calculation labored at other places on the coast, south of China—as Malacca, Singapore, and Batavia—where the climate is warmer and more unwholesome than in China. From these statements, we think ourselves justified in saying that the opinion in regard to the unwholesomeness of this climate is not sustained by facts" (Maclay, in *Methodist Quarterly*, Oct. 1850, p. 596).

II. *Religions of China* (modified from Pierer, *Universal-Lexikon*, iv, 6).—1. *Primitive Religion*. The oldest religion of the Chinese was very simple. Their supreme object of worship was *Schawéi* (supreme ruler; also called during his life *T'ien*, *T'ou*, or *T'ien* [Heaven]). Objects of inferior worship were the spirit of the earth, the spirits of the cities, the mountains, the streams, the tutelar deities of agriculture, of the hearth, of the borders, of the gates, the originators of agriculture and of the raising of silk-worms, the wise men of olden times, the souls of ancestors, particularly of the deceased emperors. The gods were to be propitiated by prayer, and their favor purchased by sacrifices. Nowhere in this system do we find any trace of immortality or of a moral law.

2. *Confucianism*.—After the fall of the *Tschou* dynasty this old religion fell into disuse. About B.C. 551 appeared the reformer Kong-futse (see CONFUCIUS), who attempted to introduce better morals, and at the same time to improve the political and social relations of the people. Confucius taught that from the Original Being *Tai-ti* proceeded *Yang* and *Yin*. *Yang*, the *Perfect*, is the essence of heaven, of the sun, day, heat, and manhood, and is represented by ☰. *Yin*, the *Imperfect*, is the essence of the moon, earth, night, cold, and womanhood, and is represented by ☷. These two, by simple combination, give four signs (See-si-ang), viz. ☱, ☲, ☳, ☴; and by double combination the eight trigrammes of the *Kwa*, viz. ☰, ☷, ☱, ☲, ☳, ☴, ☵, ☶; the original dampness, ☵, ☶, ☱, ☲, ☳, ☴, ☵, ☶; water, ☵, ☶, ☱, ☲, ☳, ☴, ☵, ☶; mountains, ☱, ☲, ☳, ☴, ☵, ☶, ☱, ☲; thunder, ☱, ☲, ☳, ☴, ☵, ☶, ☱, ☲; the earth. These figures, disposed in a circle, were used by Confucius to illustrate the creation of the world. They had also an ethical meaning, being used to represent the cardinal virtues, piety, morality, justice, and chastity. But of any spoken or written revelation there is no trace in his doctrines. Confucius says himself that the Heavens are silent; they are to be known in their effects, but no further. Those who obey the law of Heaven as presented in Nature will be happy; those who do not, become unhappy. In this system we find no notion either of immortality or of religious doctrine; it contemplates this life only, not the future. It has no special priesthood nor temples; each family sacrifices to the tutelar deities of the household in its own dwelling, but the emperor alone is permitted to sacrifice to the highest Heaven. The writings of Confucius are read and expounded with great solemnity on the 1st and 15th of every month by a mandarin in robes of ceremony, and Confucius himself is honored as a saint. His doctrines are followed by the higher and more cultivated classes of China almost universally. The golden rule of the Saviour, which Locke designates as the foundation of all social virtue, is found among the sayings of Confucius in the negative form: "What you do not wish done to yourself, do not do to others." In the "Conversations," bk. xv, ch. xxiii, it appears condensed, like a telegram, into eight characters, a good specimen of Chinese style:

己 所 不 欲 勿 施 於 人
self what not wish not do to man.

8. *Lao-Tse* or *Lǎo-chū*.—Nearly on a level with Confucius we find the reformer and philosopher *Lao-tse* (*Lao-kiun*) or *Lǎo-chū*, who considers the *Tao* (or *Original Reason*) as the origin of all things, from whom pro-

ceeded at first one, then two, then three divine natures (*Ki, Hi, Quei*). His moral teaching is that man is to enjoy life, the highest aim being to become free from external evils and from inward cares. In this religion (the followers of which are called *Tao-see*, *Tauists*) we find a belief in spirits having an influence over the destinies of man. After death the material part only of man belongs to the earth; the higher and lower spiritual parts (*Ling* and *Hu-en*) pass, after this life, into different spirits. Each place has its tutelary spirits; bad spirits always lead man into evil, but they are confined to the earth. This religion has a particular priesthood (in the higher degrees of which celibacy is enforced), and a great number of temples. It was originally embraced by the higher and richer classes, but has much degenerated of late, and its priests have become little better than jugglers.

"*Sang Ching*, the 'Three Pure Ones,' is the title



The Three Pure Ones.

of certain three idols found in temples belonging to the *Tauist* religion and worshipped by *Tauist* priests. The images are seated side by side. One of them, as some explain, represents *Ló-chú*, or the 'Old Boy,' the founder of that religion. Others explain that the three images refer to three different incarnations of *Ló-chú*.

There is very little known among the common people about these divinities, and they are very seldom worshipped by them. *Tauist* priests of both classes universally worship the Three Pure Ones" (Doolittle, *Social Life of the Chinese*, i, 249).

4. *Buddha*.—The third religion of China is that of *Fo*, or *Buddha*, introduced from India about the year A.D. 66, which, however, became commingled with the remains of the old Chinese religion and with the maxims of *Confucius*. With the great majority of the people it has sunk into a coarse idolatry. The *Dalai Lama* is in China replaced by the *Ban-dchi-in-er-de-si* as the spiritual head. • The priests are called *bonzes* (Chinese *Seng* or *Ho-shang*), and number more than one million. The lower orders of priests are ignorant, live in convents, and go about begging; the higher orders (*Ta-ho-shang*) are educated, and obliged to study their religious books. There are also female *bonzes*, living in convents like the *Romanist* nuns. The temples are either mere chapels, or else large edifices surrounded by columns, at the end of which is a hall (*Ting*) containing the image of the god. The larger temples are merely a reunion of several smaller ones, having in the corners pavilions two stories high, in which the image of the god is kept, and which are surmounted by pyramidal octagonal towers (*Taa*) 7

to 10 stories in height, each story being separated from the next by a cornice projecting in imitation of a Chinese roof, and from each angle of which depend dragon-heads and bells. By the side of the hall are the cells of the *bonzes*, and accommodations for a number of animals. On occasions of great ceremony, such as the feast of the temple of *Ti-en* (Heaven) and *Te* (Earth), at *Pekin*, the New Year's day offering, the equinox, the processions of July and August in honor of rain, the feast of the dead, and the emperor's plowing (which is also considered as a religious ceremony), the emperor officiates as high-priest. *Buddhism*, although the religion of the emperor, is not the religion of the state, and is actually only tolerated, like the *Tao-see*. Both systems have been so much altered by the influence of the doctrine of *Confucius* that the three religions can morally be considered as but one.

Religion (so far as professing it is concerned) is in

China confined principally to the educated classes, somewhat like science in other countries. The great mass of the people live on without making any distinction between the different religions, and pray in any temple without inquiring as to its form of worship. But the only worship which really seems to carry the minds and hearts of the people with it is the filial worship of ancestors.

"The hall of ancestors is found in the house of almost every member of the family, but always in that of the eldest son. In rich families it is a separate building, in

others a room set apart for the purpose, and in many a mere shelf or shrine. The tablet consists of a board called *chín chü*, i. e. house of the spirit, about twelve inches long and three wide, placed upright in a block, and having the name, quality, and date of birth and death carved in the wood. A receptacle is often cut



Worshipping the Ancestral Tablet in its Niche.—(From Doolittle's China.)

in the back, containing pieces of paper bearing the names of the higher ancestors, or other members of the family. Incense and papers are daily burned before them, accompanied by a bow or act of homage, forming, in fact, a sort of family prayer. The tablets are ranged in chronological order, those of the same generation being placed in a line. When the hall is large and the family rich, no pains are spared to adorn it with banners and insignia of wealth and rank; and on festival days it serves as a convenient place for friends to meet, or, indeed, for any extraordinary family occasion. A person residing near Macao spent about \$1500 in the erection of a hall, and on the dedication day the female members of the family assembled with his sons and descendants to assist in the ceremonies. The portraits of the deceased are also suspended in the hall, but effigies or images are not now made.

"In the first part of April, during the term called *tsing-ming*, a general worship of ancestors, called *pai shan*, or 'worshipping at the hills,' is observed. The whole population, men, women, and children, repair to their family tombs, carrying a tray containing the sacrifice, and libations for offering, and the candles, paper, and incense for burning, and there go through a variety of ceremonies and prayers. The grave is also carefully repaired and swept, and at the close of the service three pieces of turf are placed at the back and front of the grave, to retain long strips of red and white paper; this indicates that the accustomed rites have been performed, and these fugitive testimonials remain fluttering in the wind long enough to announce it to all the friends, for when a grave has been neglected three years it is sometimes dug over and the land resold" (Williams, *Middle Kingdom*, ii, 268, 269).

Aside from the three above-named religions, there has lately appeared another, the *Tai-ping*, which is a mixture of the ancient religion with some fragments of Christian doctrine made known by the missionaries. This religion is purely theocratic, partly on the model of the O. T. It holds that its God is the only true one; that he came to earth and spoke to his children, telling them what to do and what to avoid. The leader of the movement, Hung-Siu Tsuen, or, as he styles himself, Tien-Wang (king of Heaven), was a native of an insignificant village 80 miles from Canton, and was born in 1813. His parents were too poor to give him the education required for competing successfully at the state examinations. From his 19th year he repaired annually for half a dozen years to Canton to these examinations, but each time failed of success. At one of these visits, an American missionary, Rev. I. J. Roberts, gave him a package of tracts in Chinese. He did not read them until five years later, after his recovery from a severe illness, during which he had seen visions and uttered inflated rhapsodies in regard to his future. He now found in these tracts the key to the visions; he abandoned the belief in the teaching of Confucius, adopted views which were a mixture of ancient Chinese and of Christian doctrines, and betook himself to the mountains to make converts for his views. In 1840 he had made a number of converts, who were called God-worshippers. Not long after, in a single district, the number of his followers was reported to exceed 2000. Attacks on some Buddhist temples brought him into collision with the state authorities, and for several years he again led a retired life, though he seems to have remained in constant communication with his followers. A great change in his views took place in 1850. A rebellion had sprung up in the province of Canton, and the rebels, when pressed by the government troops, endeavored to enlist the influence of the God-worshippers in protecting them. The authorities sought to arrest Siu-Tsuen as their leader, when he, calling together his followers, seized a market-town, and thus, in December, 1850, the *Tai-ping* (great peace) rebellion assumed

more formidable dimensions. Siu-Tsuen gave to several of his most prominent adherents the title Wang (king), and began to issue politico-religious proclamations. He assumed the title Tien-Wang (king of Heaven), and began to claim divine honors. At first he declared himself the brother and equal of Christ, and required the same homage; but subsequently he grouped in his manifestoes God the Father, Jesus Christ, himself, and his son, whom he styles the Junior Lord, as the coequal rulers of the universe. At one time he conferred the title of the third person of the Trinity upon Tung-Wang, the most blood-thirsty of the subordinate kings; but later this title was again withdrawn, and no other divine personages were recognised but those already mentioned. He professed to have often visited heaven, and declared that his favorite wife (he was reported to have 118) had also been permitted to ascend to the heavenly regions. The rebellion made rapid progress, and in 1853 Nanking was captured, and made the capital of the insurrectionary government. The inhabitants of Nanking and other captured towns were treated with extreme severity, which was justified by Tien-Wang by reference to the Old Testament. The people, he said, were idolaters, whom it was his right, as king of Heaven, to destroy. The advance of the rebels was not arrested until, after the conclusion of a peace treaty between the imperial government and England and France, the two latter powers deemed it their interest to come to the aid of the Chinese government (1862). From that time the power of the *Tai-pings* steadily declined, until, on the 19th of July, their capital, Nanking, fell into the hands of the Imperialists. The head of the sect, Tien-Wang, burned himself in his palace with all his wives. Thus the *Tai-pings* lost their centre and nearly all their leaders, and ceased to be formidable, but the rebellion still continued in May, 1867. For several years, however, the political character of the movement had altogether overshadowed the religious. See *Annual American Cyclopaedia* for 1862, s. v. *Tai-ping Rebellion*; for 1863, 1864, 1865, and 1866, s. v. *China*; *Die Gegenwart* (vol. viii, Leipzig, 1852); *Unsere Zeit* (vol. i, Leipzig, 1856; vol. viii, Leipzig, 1864.)

II. *Christianity in China*.—Arnobius (3d cent.) mentions the *Ceres*, who are generally held to have been Christians. It is certain that the Nestorians (q. v.) had flourishing missions, which began in the 7th century (see below). The missions of the Roman Church commenced in the 13th, the Protestant missions in the 18th century (see below). In 1586 Macao was ceded to the Portuguese, under whose dominion it has since remained. In 1842 the English secured the island of Hong Kong, and at the same time five cities (Canton, Fuh-chau, Ningpo, Amoy, and Shanghai) were declared free ports. In 1844 France made a treaty with China, in which China promised toleration of Christianity in the five cities. In 1858, after a two years' war with England and China, treaties were made with France, England, the United States, and Russia, in each of which toleration of Christianity throughout the empire was stipulated. The perfidy of the Chinese government, which tried to evade the execution of the treaties, led to a renewal of the war in 1859 and 1860. It ended with a ratification of treaties with England and France on the 24th and 25th of October, 1860. These treaties not only grant toleration to the professors of Christianity, but expressly acknowledge that the principles and practices of Christianity tend to benefit mankind. Permission was also given to preach and travel in the interior, provided that the missionary be furnished with a passport. The stipulations of the four treaties were as follows (see Schem, *Eccles. Year-book for 1860*, p. 222 sq.):

American Treaty, Article 29. "The principles of the Christian religion, as professed by the Protestant and Roman Catholic churches, are recognised as teaching men to do good, to do to others as they would have

others to do to them. Hereafter, those who quietly profess and teach these doctrines shall not be harassed or persecuted on account of their faith. Any person; either citizen of the United States or Chinese convert, who, according to these tenets, peaceably teaches and practices the principles of Christianity, shall in no case be interfered with or molested."

English Treaty, Article 8. "The Christian religion, as professed by Protestants or Roman Catholics, inculcates the practice of virtue, and teaches man to do as he would be done by. Persons teaching it or professing it, therefore, shall alike be entitled to the protection of the Chinese authorities; nor shall any such, peaceably pursuing their calling and not offending against the laws, be persecuted or interfered with."

French Treaty, Article 18. "The Christian religion having for its essential object to lead men to virtue, the members of all Christian bodies (communions) shall enjoy full security for their persons, their property, and the free exercise of their religious worship; and entire protection shall be given to missionaries who peaceably enter the country, furnished with passports such as are described in Article 8. No obstacle shall be interposed by the Chinese authorities to the recognised right of any person in China to embrace Christianity if he pleases, and to obey its requirements, without being subject, on that account, to any penalty. Whatever has been heretofore written, proclaimed, or published in China, by order of government, against the Christian faith, is wholly abrogated and nullified in all the provinces of the empire."

Russian Treaty, Article 8. "The Chinese government, recognising the truth that the doctrines of Christianity promote the establishment of peace and good order among mankind, promises not to persecute its subjects who may wish to follow the requirements of this faith; but they shall enjoy the same protection which is granted to those who profess other forms of religion tolerated in the empire."

"The Chinese government, believing that Christian missionaries are good men, who seek no material advantages for themselves, hereby permits them to propagate the doctrines of Christianity among its subjects, and allows them to pass everywhere in the country. A fixed number of missionaries passing through the cities or open ports shall be furnished with passports, signed by the Russian authorities."

In March, 1861, the ambassadors of England and France, and in July, 1861, the ambassador of the United States, took up their permanent abode at Peking, and this city became at once a centre for the missionary operations of both Protestants and Roman Catholics. Since that time the free propagation of Christianity has not been again interrupted. After the death of the emperor Hien-Fung (Aug. 22, 1861), the administration of the empire, which, in the name of the minor emperor Ki-Tsiang, was conducted by Prince Kung, became still more favorable to the free and friendly intercourse with Christian nations. Commercial treaties were concluded with almost all the nations of Europe; thus, on Sept. 1, 1861, with Prussia and the German Zollverein (ratified 1863); in 1862, with Spain, Belgium (Aug. 8), and Portugal (Aug. 18); in 1863, with Denmark (July 10). Besides the ambassadors of the United States, England, and France, those of Russia and Spain took up their residence at Peking, while a Portuguese minister was appointed at Macao and a Prussian at Shanghai.

1. *Nestorian Missions.*—The Nestorian patriarchs are said to have sent missionaries to China in the 5th century. Between A.D. 636 and 781, seventy Nestorian missionaries, among whom Olopun (arrived in 696) was distinguished, labored in China. The history of the Nestorian missions is given in an inscription, discovered in 1625 by Jesuit missionaries in Si-anfu. Its genuineness, long doubted, has been recently defended by Abel Remusat and others. In 714 the patriarch Sali-

bazacha is reported to have sent a metropolitan to China. Timotheus, who appears to have been the Nestorian patriarch upwards of forty years, was zealously devoted to Christian missions. During his patriarchate, Sabchaljune, a learned monk from the convent of Beth-oben, after having been ordained bishop, penetrated China, and there extensively preached the Gospel. He was soon followed by others. In the 9th century Christians were found in Southern China by two Arabian travellers, and in 877 many Christians, conjointly with Jews, Mohammedans, and Persians, were massacred in Canton by one Baichu, who had revolted from the emperor. In 845, Wutsung is reported to have ordered 8000 priests from Ta-tsin to retire to private life. Marco Polo, the distinguished traveller of the 13th century, who spent more than twenty years in China, for a time holding a high office, speaks of his meeting with Chinese Christians. Rubruquis, in 1260, tells of fifteen cities where there were Nestorians; and the author of the *l'Etat du gran Caan* (1880) reports 80,000 Nestorians in China. The Nestorian missions seem to have been wholly or nearly extirpated simultaneously with the expulsion of the Monguls in 1269 by the Ming dynasty. At present no Nestorian churches are known to exist in China, and no Nestorian translation of the Bible is known to exist (Newcomb, *Cyclopaedia of Missions*, p. 262). See NESTORIANS.

2. *Roman Catholic Missions.*—(1.) The first period in the history of Roman Catholic missions in China was introduced by the labors of Johannes de Monte Corvino, who entered India in 1291, and after meeting with great opposition, not only from the pagans, but also from the Nestorians, was so successful in his labors that in 1305 he had baptized 6000 converts. His labors were confined principally to the Tartars, whose language he had learned, and into which he translated the N. T. and the Psalms. In 1305 Pope Clement V constituted him archbishop of Peking, and sent seven suffragan bishops (Franciscans) to his assistance. He died in 1308. Another archbishop of Peking was appointed in 1386, and 26 additional laborers joined the mission. In 1369 the Ming dynasty came into power, and seems to have crushed out Christianity altogether, both Roman and Nestorian.

(2.) Several unsuccessful attempts were made in the years 1566, 1575, and 1579, by Dominicans, Franciscans, and Augustines, to re-establish missions in China, but it was left for the Jesuits finally to accomplish it. Matteo Ricci led the way. He reached Macao in 1581, and by persevering efforts made his way to Peking, and into the good graces of the reigning emperor. Several high mandarins were converted through his efforts, chief among whom was Sieu, an officer of the highest rank and of great personal influence. Ricci died in 1610 at the age of 80, and was buried with great pomp and solemnity. In 1628 Adam Schaal, a German Jesuit, arrived, and through the influence of Sieu was favorably received by the emperor. His great talents and extensive acquirements caused him to be ranked among the first men of the empire. In 1631 the Dominicans and Franciscans entered China, but their success was not very great. The cause of Christianity suffered a great loss in 1682 in the death of Sieu. In 1644 the Tartars completed the conquest of China, and with the Ming dynasty the Christian missions almost expired. Schaal, however, by his genius and learning, rose into favor with the new dynasty, and by his influence obtained permission for 14 other missionaries to enter the country, among whom was the celebrated Ferdinand Verbeest. The patron of Schaal died in 1662, and the minor, Kanghi, ascended the throne. The Jesuit star remained for a short time in the zenith, but Schaal was soon thrown into prison, and sentenced "to be cut into a thousand pieces." This decree was not executed; Schaal died in 1669, in the 78th year of his age. Another missionary died in prison, and several Franciscans and 21 Jesuits were banished to Can-

ton. Verbeest became a favorite of the emperor Kanghi after he had dismissed the regents and assumed supreme control. Satisfied of the great abilities of Verbeest, Kanghi commanded him to correct the calendar, which he did with entire satisfaction to the emperor. He was appointed president of the Astronomical Tribunal. He cast many cannon, and in other ways rendered himself serviceable to government.

(8.) For some time after this the missions prospered. In 1708 they numbered 100 churches and 100,000 converts in the province of Nankin alone. But in 1784, not only the Jesuits, but all Roman missionaries, were expelled. Yet many congregations survived under protracted persecutions. Native priests were trained both in seminaries in China and in Europe (in the Propaganda at Rome and in a Chinese seminary at Naples), and many European missionaries were able to penetrate into the interior. Not a few were put to death, but the missions survived. Since the treaties of 1859, which promise liberty of worship for both Roman Catholics and Protestants, great preparations have been made for extending the Romanist missions. A few years ago, when China was divided into 20 Vicariates Apostolic, the Roman Catholic population of China amounted, according to the *Univers*, to about 800,000. Other Roman Catholic writers claim a much higher number, e. g. Huc, who estimates it at 700,000.

Since the treaty with France in 1858, the Roman Catholic missionaries claim to have received large accessions to their congregations, and to have a total membership in their Church of about one million. The number of missionaries, especially French, who have since been sent to China, is considerable. On January 1, 1867, a new cathedral was consecrated at Pekin, which is one of the largest buildings of the capital. A bloody persecution of Roman Catholic missionaries took place in 1866 in one of the dependencies of China, Corea. See COREA.

According to the "Roman Almanac" for 1859 (*Notice per l'Anno 1859*), there were in China 22 Vicariates Apostolic and 8 Prefectures Apostolic, viz.: 1. Shen-si, Franciscans; 2. Shan-si, Franciscans; 3. Hu-pei, Franciscans; 4. Hu-nan, Franciscans; 5. Su-tchuen (North-eastern), Foreign Missionary Seminary of Paris; 6. Su-tchuen (South-eastern), Foreign Missionary Seminary of Paris; 7. Kouei-Kou; 8. Lassa; 9. Kō-konor; 10. Yu-nan, Foreign Missionary Seminary of Paris; 11. Fokeen, Spanish Dominicans; 12. Nankin, Jesuits; 13. Pekin (Northern), Lazarists; 14. Pekin (South-western), Lazarists; 15. Pekin (Eastern), Jesuits; 16. Tcheh-Kiang, Lazarists; 17. Kiang-si, Lazarists; 18. Leao-tung, Foreign Missionary Society of Paris; 19. Tartar Mongolia, Foreign Missionary Society of Paris; 20. Shan-toong, Franciscans; 21. Honan, Lazarists; 22. Corea, Foreign Missionary Seminary of Paris. The 8 Prefectures are as follows: 1. Hong Kong, Propaganda of Rome; 2. Kwang-tung, Kwang-si, and Hainan, Foreign Missionary Seminary of Paris; 3. Labuan. The missions are mostly supported by the "Society for the Propagation of the Faith," which has its centre in France. Special attention to Chinese missions is also paid by the "Society of the Holy Childhood of Jesus," a children's missionary society for buying and baptizing those children who by their parents have been destined to death, and giving to them a Christian education. The receipts of the society amounted in 1856 to 872,000 francs. Up to that year 329,888 children had been bought and baptized, of whom 247,041 had died shortly after baptism.

3. *Protestant Missions.*—The first Protestant mission was undertaken by the London Missionary Society, which in 1807 sent the Rev. Robert Morrison to Canton, principally for the object of translating the holy Scriptures into Chinese. He was appointed (in 1806) translator of the East India Company's factory, with a salary which rendered him independent of the soci-

ety's fund. In 1818 he was joined by the zealous and learned Mr. Milne. The translation of the New Testament was completed in 1814; of the whole Bible in 1818. In 1814 the first Chinese convert was baptized. A valuable assistant the missionaries found afterwards in Leang-Afa (baptized by Milne in 1816), who distinguished himself as the author of several valuable tracts, and by his zeal in preaching the Gospel, and in distributing books at the literary examinations. One of the books distributed on this occasion fell into the hands of the leader of the insurgents, and was the foundation of his earliest Christian impressions. The American missions commenced in 1829, when the American Seamen's Friend Society sent out two missionaries, one of whom, in 1830, transferred his services to the American Board of Commissioners of Foreign Missions, which from that time has had a mission at Canton. The Rhenish Missionary Society sent out, about 1830, Mr. Gütalaff, who soon became perfectly master of the language, and made frequent journeys through the coast countries of China. He was especially active in circulating the Scriptures, which were received with great eagerness. In 1835 the American Protestant Episcopal Church established a mission in Batavia, which in 1842 was removed to Macao. During this first period the continual hostility of the Chinese compelled the English, American, and German missionaries to restrict their labors mostly to the printing and circulating of Christian books. Permanent settlements were only made at Canton, but at Malacca also an Anglo-Chinese college was founded.

The peace of Nankin in 1842, the cession of Hong Kong to the English, and the opening of the five ports to European and American Christians, gave a new impulse to missionary zeal. The London Missionary Society gave instructions to their Chinese missionaries to meet in Hong Kong to consider the plan for future operations. Agreeably to the recommendations of this meeting (August, 1843), the Anglo-Chinese college in Malacca was changed into a theological seminary for the training of a native ministry. Also the printing apparatus of the mission was transferred from Malacca to Hong Kong, and a medical establishment opened in connection with the mission. In 1848 Shanghai was occupied, and in 1844, Amoy. The American Board stationed missionaries at Amoy in 1842, and at Fuh-chau in 1847. The American Episcopal Board, whose missionary, Dr. Boone, while on a visit to the United States, had been consecrated missionary bishop, fixed on Shanghai as the most suitable station. Other missionary societies hastened to occupy the interesting field. The operations of the American Baptist Union commenced in 1842; those of the Southern Baptist Convention (of America) and of the (American) Presbyterian Board in 1844; those of the Church Missionary Society, one of whose missionaries, Rev. George Smith, was appointed bishop of Victoria, in 1849; of the General Baptist Missionary Society (England) in 1845; those of the Methodist Episcopal Church in 1846; those of the (American) Seventh-day Baptists in 1847; those of the Methodist Episcopal Church South in 1848; those of the English Wesleyans and the Free Church of Scotland in 1850.

"The first Protestant mission at Fuh-chau was established by a missionary of the American Board of Commissioners for Foreign Missions in January, 1847. The mission has averaged three or four families since its commencement. In April, 1856, occurred the first baptism of a Chinaman at this city in connection with Protestant missions. In May, 1857, a brick church, called the "Church of the Saviour," built on the main street in the southern suburbs, and about one mile from the Big Bridge, was dedicated to the worship of God. Its first native church, consisting of four members, was organized in October of the same year. In May, 1863, a church of seven members was formed at Chang-loh, distant seventeen miles from the city. In

June of the same year a church of nine members was organized in the city of Fuh-chau, having been dismissed from the church in the suburbs to form the church in the city. For the first ten years of this mission's existence only one was baptized. During the next five years twenty-two members were received into the first church formed. During the next two years twenty-three persons were baptized. Between 1853 and 1858 a small boarding-school, i. e. a school where the pupils were boarded, clothed, and educated at the expense of the mission, was sustained in this mission. Among the pupils were four or five young men, who are now employed as native helpers, and three girls, all of whom became church members, and two of whom are wives of two of the native helpers. There are at present a training-school for native helpers, and a small boarding-school for boys, and a small boarding-school for girls connected with the mission. It employs six or seven native helpers, and three or four country stations are occupied by it. Part of the members of this mission live at Ponasang, not far from the Church of the Saviour, and part live in the city, on a hill not far from the White Pagoda, in houses built and owned by the American Board (see *Statistics of Societies*, below).

"The mission of the Methodist Episcopal Church was established in the fall of 1847. It has had an average number of four or five families. In 1857 it baptized the first convert in connection with its labors. In August, 1856, a brick church, called the 'Church of the True God,' the first substantial church building erected at Fuh-chau by Protestant missions, was dedicated to the worship of God. It is located near Tating, on the main street, in the southern suburbs, about two thirds of the way between the Big Bridge and the city. In the winter of the same year another brick church, located on the hill in the suburbs on the south bank of the Min, was finished and dedicated, called the 'Church of Heavenly Rest.' In the fall of 1864 this mission erected a commodious brick church on East Street, in the city. Its members reside principally on the hill on which the Church of Heavenly Rest is built. One family lives at a country station ten or twelve miles from Fuh-chau. This mission has received great and signal encouragement in several country villages and farming districts, as well as in the

city and suburbs. It has some eight or ten country stations, which are more or less regularly visited by the foreign missionaries, and where native helpers are appointed to preach regularly. It has a flourishing boys' boarding-school, and a flourishing girls' boarding-school, and a printing-press. At the close of 1868 there were twenty-six probationary members of its native churches, and ninety-nine in full communion. It employs ten or twelve native helpers. It has established a system of regular Quarterly Meetings and an Annual Conference in conformity with the Discipline of the Methodist Episcopal Church" (Doolittle, *Social Life of the Chinese*, N. Y., Harper and Brothers, 1865, 2 vols. 12mo). There were, in 1854, 26 stations, 69 missionaries, 5 churches, 24 chapels, 351 church members; 12 boarding-schools, with 376 scholars; 20 day-schools, with 436 scholars (see *Statistics of Societies*, below).

According to the "Directory of Protestant Missions in China," issued in June, 1866, from the press of the American Methodist Episcopal Mission at Fuh-chau, the statistics of Protestant missions were, in 1866, as follows:

Statistics of the various Stations.

STATIONS.	Ordained Missionaries.	Lay Missionaries.	Missionary Ladies.	Total Number of Missionaries.	Native Helpers.	Members rec'd 1866.	Total Members.
Canton	13	1	10	24	28	84	928
Hong Kong	13	1	12	26	22	104	558
Swatow	4	1	8	13	18	80	159
Amoy	10	1	6	16	41	94	592
Ta-kae (Formosa)	10	1	1	11	1	42	224
Fuh-chau	19	5	15	39	42	141	656
Ningpo	9	2	8	19	7	22	243
Shanghai	3	1	2	6	5	4	40
Hankow	1	1	1	3	4	5	17
Kinkiang	3	1	4	8	4	5	41
Chefoo	4	1	5	10	11	8	39
Tungshan	6	1	5	11	5	24	68
Tientsin	9	2	10	21	10	24	68
Pekin	1	1	1	3	2	2	10
Kaigan	1	1	1	3	2	2	10

Total in 1866: ordained missionaries, 97; lay missionaries, 14; missionary ladies, 95; whole number of missionaries, 204; number of native helpers, 206; number of members received in 1866, 282; whole num-

Statistics of Societies.

SOCKETIES.	Ordained Missionaries.	Lay Missionaries.	Missionary Ladies.	Total Number of Missionaries.	Native Helpers.	Members rec'd 1866.	Total Members.
American Board of Commissioners for Foreign Missions (Canton, Fuh-chau, Tientsin, Peking, Kaigan)	8	..	9	17	18	26	88
American Baptist Missionary Union (Swatow, Ningpo)	5	..	5	10	17	49	285
American Methodist Episcopal Church South (Shanghai)	3	..	3	6	1	..	20
American Methodist Episcopal Mission (Fuh-chau)
American Protestant Episcopal Mission (Shanghai, Peking)	2	..	1	3	5	20	69
American (O. S.) Presbyterian Mission (Canton, Ningpo, Shanghai, Chefoo, Tungshan, Peking)	19	3	15	30	32	82	307
American Reformed Dutch Mission (Amoy)	3	..	2	5	19	24	347
American Southern Baptist Convention (Canton, Shanghai, Tungshan)	4	..	4	8	14	18	143
American United Presbyterian Mission (Canton)	1	..	1	2
British and Foreign Bible Society (Shanghai)	..	1	..	1
Berlin Ladies' Society (Hong Kong)	..	1	4	5
Chinese Evangelization Society (Ningpo)	..	3	1	4	3	10	59
Chinese Evangelization Society of Berlin	1	..	1	2	6	68	143
Church Missionary Society	9	..	10	19	19	88	314
English Baptist Mission	2	..	9	11	3	2	14
English Methodist New Connection (Tientsin)	2	..	1	3	2	..	15
Evangelical Missionary Society of Basle (Hong Kong)	5	..	1	6	5	22	200
English Presbyterian Mission (Swatow, Amoy, Ta-kae, Peking)	7	9	8	19	31	81	278
English United Methodist Free Churches (Ningpo)	2	..	2	4
English Wesleyan Mission (Canton, Kinkiang, Hankow)	7	1	3	11	9	4	46
Hong Kong Diocesan Female School (Hong Kong)	1	1
London Missionary Society (Canton, Hong Kong, Amoy, Shanghai, Hankow, Tientsin, Peking)	14	1	13	27	28	68	672
National Bible Society of Scotland (Peking)	..	1	1	2
Rhemish Missionary Society (Hong Kong)	3	..	1	4	7	10	100
Society for promoting Female Education in the East (Hong Kong)	1	1
United Presbyterian Church of Scotland (Ningpo)	..	1	..	1	1
Independent	9	..	8	17	4	10	49

ber of native members, 8142. One of the most remarkable awakenings that is known in the whole history of Protestantism of China took place in 1866, in connection with the out-stations of the Tientsin mission of the English New-Connection Methodists, especially at Lou-Leing, where, in September, 45 persons were admitted to baptism. The converts added to the mission churches of the London Society, in Shanghai, and the province of which it forms the capital, numbered, during the year 1866, 189. An event of considerable importance for the Protestant missions of China is the establishment of a monthly religious paper in the English language (the *Missionary Recorder*) by the missionaries of the Methodist Episcopal Church of Fuh-chau.

4. *Greek Missions*.—A mission of the Greek Church was established by the Russians in Pekin under the reign of Peter the Great. Its object, until recently, was limited to the spiritual care of a colony of Russian subjects, who had been captured on the Amoor and settled near Pekin. A treaty between China and Russia authorized the Russian government to keep six missionaries at Pekin, changing them once in ten years, with the right of having a few students to learn the Chinese and Manchoo language, and to obtain a general knowledge of Chinese affairs. A letter from one of the American missionaries in Pekin, in the *Boston Missionary Herald* (February, 1865), states that "the Russian missionaries in Pekin now labor devoutly for the Chinese in the country as well as in the city. It is an interesting fact, and one which marks a difference between them and the Roman Catholics, that they translate and use the sacred Scriptures. Their version of the New Testament into Chinese is now in print in this city [Pekin]. They have obtained also from the English missionaries the version of the Bible by Messrs. Swan and Hallybras, and published by the British and Foreign Bible Society, for the use of their ministers to the Mongolians, and the versions of the New Testament published by the same society for the use of their missions in Russian Manchuria." In 1866, the Pekin mission numbered about 200 converted Chinese and Tartars. See *Annual American Cyclopaedia* for 1865, s. v. China.

IV. *Literature*.—Pierer, *Universal-Lexikon*, iv, 1-30; Gützlaff (missionary in China), *History of China* (Canton, 1833; translated into German, and continued by Neumann, Stuttgart, 1847); Abeel, *Residence in China* (1830-33, 12mo); Thornton, *History of China* (London, 1844); *Geschichte der katholischen Missionen im Kaiserreiche China* (Vienna, 1845); Davis, *Description of China* (London, 2 vols. 8vo); Wittmann (Rom. Cath.), *Die Herrlichkeit der Kirche in ihren Missionen*; Williams, *Middle Kingdom* (Lond. and N. Y. 1848, 8vo); Morrison, *View of China* (4to); *Annales de la Propagation de la Foi*; *Annual Reports of the Protestant Missionary Societies in America and England*; Dean, *The China Missions* (N. Y. 12mo); Newcomb, *Cyclopaedia of Missions*; Schem, *Ecclesiastical Year-book for 1859*, p. 139, 140, 220 sq.; Edkins, *The Religious Condition of the Chinese* (Lond. 1859, 8vo); Milne, *Life in China* (Lond. 1857, 8vo); Huc, *Journey through the Chinese Empire* (N. Y., Harper and Brothers, 1855, 2 vols. 12mo); Bush, *Five Years in China* (Presbyt. Board); Meadows, *The Chinese and their Rebellions* (Lond. 1856, 8vo); Fortune, *Three Years in China* (Lond. 1847, 8vo); Maclay, *Life among the Chinese* (N. Y. 1860, 12mo); Davis, *General Description of China* (Lond. 1857, 8vo); N. Y. 2 vols. 18mo); Doolittle, *Social Life of the Chinese* (N. Y. 1866, Harper & Brothers, 2 vols. 12mo); Oliphant, *Narrative of the Earl of Elgin's Mission* (Edinb. 1859; N. Y. Harpers, 1860, 8vo); Cobbold, *Pictures of the Chinese by themselves* (Lond. 1859, 8vo); Smith, *Consular Cities of China* (N. Y. 1860, 12mo); Dimon, *Early Christianity in China* (New Englander), Nov. 1858); Whitney, *China and the Chinese*; *China and the West* (New Englander, Feb. 1859, and Jan. 1). See CONFUCIUS; COREA.

Chin'nereth (Heb. *Kinnereth*, כִּנְרֶת; in pause *Kinna'reth* [Josh.], כִּנְרֶת; Sept. *Χενίρεθ* v. r. [in Deut.] *Μαχαναρέθ*), the sing. form (Deut. iii, 17; Josh. xix, 35) of a town, also called in the plur. **CHIN-NEOTH** (Heb. *Kinneroth*, כִּנְרֹת, 1 Kings xv, 20; Sept. *Χενίρεθ*; A. V. "Cinneroth;" or *Kinnaroth*, כִּנְרֹת, Josh. xi, 2, *Χενίρεθ*); or perhaps the latter form designates the region of which the other was the metropolis. A similar variety appears in the name of the adjoining lake, which is perhaps intended in some of the above passages. The town was a fortified city in the tribe of Naphtali, mentioned between Rakkath and Adamah (Josh. xix, 35), the only certain reference to the city exclusively. Whether it gave its name to or received it from the lake, which was possibly adjacent, is uncertain. Jerome identifies *Chemereth* (*Onomast.* s. v., Eusebius *Χενίρεθ*) with the later *Tiberias*. This may have been from some tradition then existing; the only corroboration which we can find for it is the mention in Joshua of Hammath as near it, which was possibly the Emmaus (modern Hummam), near the shore of the lake, a little south of Tiberias. This situation of Chinnereth is denied by Reland (*Palæst.* p. 161) on the ground that Capernaum is said by Matthew (iv, 18) to have been on the very borders of Zebulun and Naphtali, and that Zebulun was to the south of Naphtali. But the evangelist's expression hardly requires this strict interpretation. The town, or the lake, appears to have given its name (slightly altered) to a district—"all Cinneroth" (1 Kings xv, 20). See CINNEBETH.

SEA OF CHINNERETH (כִּנְרֶת; Sept. [η] *θάλασσα Χενίρεθ*, Num. xxiv, 11; Josh. xiii, 27) or **CHIN-NEOTH** (כִּנְרֹת, *Χενίρεθ*, Josh. xii, 8), the inland sea, which is most familiarly known to us by its New-Test. name as the "Lake of Gennesareth," or the "Sea of Tiberias" or "of Galilee." This is evident from the mode in which it is mentioned in various passages in the Pentateuch and Joshua as being at the end of Jordan, opposite to the "Sea of the Arabah," i. e. the Dead Sea, as having the Arabah or Ghor below it, etc. (Deut. iii, 17; Josh. xi, 2; xiii, 8. In the two former of these passages the word "sea" is perhaps omitted). The word is by some derived from the Heb. כִּנְרֶת, *Kinnereth* (*κινυρία, cithara*), a "harp," as if in allusion to the oval shape of the lake. But it is possible that *Chinnereth* was an ancient Canaanite name existing long prior to the Israelite conquest, and, like other names, adopted by the Israelites into their language. The subsequent name "Gennesar" was derived from "Cinnereth" by a change of letters of a kind frequent in the East.—Smith, s. v. See GENNESARETH.

Chin'neroth (Josh. xi, 2; xiii, 8). See CHIN-NEBETH.

Chintin. See WHEAT.

Chi'os (Χίος, according to some, from *χίων, snow*, with which its mountains are perpetually covered; according to others, from a Syrian word for *mastic*, with which its forests abounded), one of the principal islands of the Ionian Archipelago, mentioned in Acts xx, 15, and famous as one of the reputed birthplaces of the poet Homer. It belonged to Ionia (Mela, ii, 7), and lay between the islands Lesbos and Samos, and distant eight miles from the nearest promontory (Arenum Pr.) of Asia Minor. The position of this island in reference to the neighboring islands and coasts could hardly be better described than in the detailed account of the apostle Paul's return voyage from Troas to Caesarea (Acts xx, xxi). Having come from Assos to Mitylene in Lesbos (xx, 14), he arrived the next day over against Chios (ver. 15), the next day at Samos, and tarried at Trogyllium (ὄβ.); and the following day at Miletus (ὄβ.); thence he went by Cos and Rhodes to Patara (xx, 1). See MITYLENE; SAMOS.

In the account of Herod's voyage to join Marcus Agrippa in the Black Sea, we are told (Josephus, *Ant.* xvi, 2, 2) that, after passing by Rhodes and Cos, he was detained some time by north winds at Chios, and sailed on to Mitylene when the winds became more favorable. It appears that during this stay at Chios Herod gave very liberal sums towards the restoration of some public works which had suffered in the Mithridatic war. This island does not appear to have any other association with the Jews, nor is it specially mentioned in connection with the first spread of Christianity by the apostles. When Paul was there, on the occasion referred to, he did not land, but only passed the night at anchor (Conybeare and Howson, *St. Paul*, ii, 211). At that time Chios enjoyed the privilege of freedom (Plin. v, 38; comp. xvi, 6), and it is not certain that it ever was politically a part of the Roman proconsular Asia. No record exists of its connection with Christianity in apostolic times; but after the lapse of ages we read of a bishop of Chios, showing that the Gospel had obtained a footing on the shores. Its length is about 32 miles, and in breadth it varies from 8 to 18 (having a periphery of 900 stadia, Strabo, xiv, 645, or 120 Italian miles, Tournefort, *Voy.* ii, 84). Its outline is mountainous and bold, and it has always been celebrated for its beauty and fruitfulness (Arvieux, *Voy.* vi, 169; Schubert, *Reis.* i, 414). It is very fertile in cotton, silk, and fruit, and was anciently celebrated for its wine (Pliny, xiv, 9; xvii, 84, 22; Strabo, xiv, 687; Horace, *Od.* iii, 19, 5; Virg. *Ecl.* v, 7; Athen. iv, 167; i, 82) and mastic (Pliny, xii, 86; xxiv, 74; Dioscor. i, 90). The principal town was also called Chios, and had the advantage of a good harbor (Strabo, xiv, p. 645). The island is now called by the Greeks *Khio*, and by the Italians *Scio* (Hamilton, *Researches*, ii, 6; Thevenot, *Travels*, i, 98; Chandler, *Asia Minor*, c. 16; Clarke, *Trav.* iii, 236; Sonnini, *Trav.* c. 37; Olivier, *Voy.* ii, 108). The wholesale massacre and enslavement of the inhabitants by the Turks in 1822 forms one of the most shocking incidents of the Greek war of independence (Hughes, *Tract on Gr. Revolution*, Lond. 1822). See also Malte Brun, *Geography*, ii, 86 sq.; Mannert, *Geogr.* VI, iii, 828 sq.; Hassel, *Erdbechr.* xiii, 161 sq.; Cellarii *Notit.* ii, 19; Smith's *Dict. of Class. Geogr.* s. v.; M'Culloch's *Gazetteer*, s. v. Scio. See ASIA MINOR.

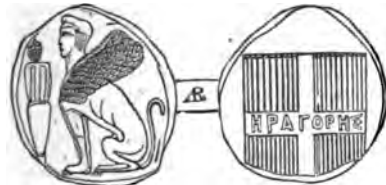

Coin of Chios.

Chis'leu (Heb. *Kislev*, כִּסְלֵי, according to some, from Arabic, i. q. *lethargic*; according to others [Benfey, *Monatnamen*, Berl. 1836], of Persian origin; and as it appears in the Palmyrene Inscription [ed. Swinton, *Philos. Transactions*, xlviii, tab. 29] in the form כִּסְלֵי, i. e. *Kislev*, it probably represents the name of the third of the Amhaspanda or celestial genii [Bournef, *Commentaire sur le Yasna*, p. 146, 151, 174]; Sept. *Χασλεύ*, Anglicized "Casleu" in 1 Macc. i, 54; iv, 59; Chaldee כִּסְלֵי, Targ. on Eccl. xi, 3; Josephus *Χασλεύ* or *Χασλέβ*, *Ant.* iii, 5, 4; 7, 6), the name adopted from the Babylonians, after the Captivity, by the Jews for the third civil or ninth ecclesiastical month (Neh. i, 1; Zech. vii, 1), corresponding to the Macedonian month *Apellaneis* (Ἀπελλαῖος; see Spanheim in Havercamp's *Josephus*, ii, 407), and answering mainly to the moon of November. See MONTH. The following were the days specially memorable for religious exercises: On the 8d, a feast in memory of the idols which the Asmonæans cast out of the Temple; on the 7th,

a fast instituted because king Jehoiakim burned the prophecy of Jeremiah, which Baruch had written (Jer. xxxvi, 23). Scaliger believes that it was instituted on account of Zedekiah's having his eyes put out, after his children had been slain in his sight. This fast Priebeaux places on the 29th of the month; but Calmet, with the modern Jews, makes it the 6th, and places on the 7th a festival in memory of the death of Herod the Great, the son of Antipater. There is also some dispute whether this fast was not observed on the 28th of the month. It is an argument in favor of the earlier day that the other would fall in the middle of the eight days' Festival of the Dedication.

On the 25th, the *Chanuca*, or feast of Dedication (q. v.), so called (John x, 22), and kept as a minor festival in commemoration of the dedication of the altar after the cleansing of the Temple from the pollution of Antiochus by Judas Maccabeus, by whom it was ordered to be observed (1 Macc. iv, 59). This feast lasted eight days. A prayer for the world in general is offered up on the eighth day of the feast. In this month the winter prayer for rain commences; the precise day is sixty days after the autumnal equinox, by the calculations of Rab Samuel, which varies from the 2d to the 6th, but is generally on the 4th of December. See CALENDAR.

Chis'lon (Heb. *Kislon*, כִּסְלֹן, *confidence*; Sept. *Χασλών*), the father of Eldad, which latter was one of the princes of Benjamin, selected on the part of that tribe by Jehovah to divide Canaan (Num. xxxiv, 21). B.C. ante 1618.

Chis'loth-ta'bor (Hebrew *Kisloth' Tabor*, כִּסְלוֹת־תְּבוֹר, *flanks of Tabor*; Sept. *Χασαλωθσαβώρ* v. r. *Χασαλωθσαι* and *Χασαλωθ-βαθώρ*, Vulg. *Ceseleth-tabor*), a place to the "border" (בְּרֵית), of which the "border" (בְּרֵית) of Zebulun extended eastward from Sarid on the southern boundary (Josh. xix, 12), apparently outside its territory, at the western foot of Mt. Tabor. See TRIBE. It is probably the same elsewhere called simply **CHESULLOTH** (Josh. xix, 18) and **TABOR** (1 Chron. vi, 7), and seems to be identical with the *Chasalus* (Χασάλους, Chasalus) of the *Onomasticon* (s. v. Ἀχασελώθ, Achaseluth; comp. s. v. *Χασαλωθσαβώρ*, Chaselatabor; *Χασελοῦς τοῦ Θαβώρ*, Chaselath), near Mt. Tabor, in the plain [of Esdraelon], 8 R. miles E. of Diocæsarea; also with the *Xaloth* (Χαλωθ) mentioned by Josephus (*War*, iii, 8, 1; comp. *Life*, 44) as a village in the great plain, and one of the landmarks of lower Galilee (comp. Zunz, *On the Geography of Palestine from Jewish Sources* in Asher's *Benj. of Tudela*, ii, 482; and Seetzen's *Reisen durch Syrien*, iv, 811). See AZNOTH-TABOR. It is doubtless the modern *Iscal*, seen by Dr. Robinson on his way from Nabulus to Nazareth, "in the plain toward Sahor, on a low rocky ridge or mound, not far from the foot of the northern hills, described as containing many excavated sepulchres" (*Researches*, iii, 182). It was also observed by De Saucy, while passing through the plain of Esdraelon towards Nain, "to the left, and distant a little more than a league, built at the foot of the mountains of Nazareth" (*Narrative*, i, 74). Pococke (ii, 65) mentions a village which he calls *Zal*, about three miles from Tabor.

Chittah. See WHEAT.

Chit'tim (Heb. *Kittim*, כִּיְתִים, a Gentile plur. form of foreign origin, Gen. x, 4; Sept. *Κήτιοι*, A. V. "Kittim;" Num. xxiv, 24, *Kiriatioi*; 1 Chron. i, 7 ["Kittim"], and Dan. xi, 80, *Kiritioi* v. r. *Ρωμαῖοι*; Isa. xxiii, 1, *Κητιῶν* v. r. *Kiriatioi*; or in the longer and more properly national form *Kittiyim*, כִּיְתִיִּים, Jer. ii, 10, *Κερτιεῖμ* and כִּרְתִּיִּים, Isa. xxiii, 12, *Κητιεῖμ* v. r. *Kirteis*; Ezek. xxvii, 6, *Κερτιεῖμ* v. r. *Κερτιεῖμ*), a branch of the descendants of Javan, the son of Japheth (Gen. x, 4; 1 Chron. i, 7), closely related to

the Dodanim, and remotely (as we may conclude from the absence of the conjunction before it) to the other descendants of Javan (see Hiller, *Syntagm. Aermesent.* p. 185). Balaam foretold "that ships should come from the coast of Chittim, and should afflict Asshur [the Assyrians], and afflict Eber" [the Hebrews] (Num. xxiv, 24), thus foretelling the Grecian and Roman invasions. Daniel prophesied (xi, 18) that the ships of Chittim should come against the king of the North, and that he should therefore be grieved and return, which was fulfilled when Antiochus Epiphanes, the king of Syria, having invaded Egypt, was by the Roman ambassadors commanded to desist, and withdrew to his own country (Livy, xlv, 29; xlv, 10). In Isa. xxiii, 1, 12, it appears as a resort of the fleets of Tyre; in Jer. ii, 10, the "isles (צִיִּיִן, i. e. *maritime districts*) of Chittim" are to the far west, as Kedar to the east of Palestine; the Tyrians procured thence the cedar or box-wood, which they inlaid with ivory for the decks of their vessels (Ezek. xxvii, 6, חֲבֵרֹתֵי צִיִּיִן, A. V. "the company of the Ashurites," but rather [ivory] *the daughter of box-wood*, i. e. inclosed in it). At a later period the name was applied to the Macedonians under Alexander the Great (1 Macc. i, 1, *Xerxeium*, A. V. "Chettim") and Perseus (viii, 1, *Kiritium* "Citima"). On the authority of Josephus, who is followed by Epiphanius (*Haer.* xxx, 25, p. 150) and Jerome (*Quest. in Gen.* x), it has generally been admitted that the Chittim migrated from Phoenicia to Cyprus, and founded there the town of *Citium*, the modern *Chitti*: "Chethimus possessed the island of Chethima, which is now called Cyprus, and from this all islands and maritime places are called Chethim (Χεθίμη) by the Hebrews" (Joseph. *Ant.* i, 6, 1). Other ancient writers, it may be remarked, speak of the Citians as a Phoenician colony (Pliny, v, 85; xxxi, 89; Strabo, xv, 682; Cicero, *De Finibus*, iv, 20). Pococke copied at Citium thirty-three inscriptions in Phoenician characters, of which an engraving is given in his *Description of the East* (ii, 218), and which have more recently been explained by Gesenius in his *Monum. Phœnic.* (p. 124-138). From the town the name extended to the whole island of Cyprus, which was occupied by Phoenician colonies, and remained under Tyre certainly until about B.C. 720 (Josephus, *Ant.* ix, 14, 2). With the decay of the Phoenician power (circ. B.C. 600) the Greeks began to found flourishing settlements on its coasts, as they had also done in Crete, Rhodes, and the islands of the Ægean Sea. The name Chittim, which in the first instance had applied to Phœnicians only (for צִיִּיִן = צִיִּיִן, *Hittites*, a branch of the Canaanitish race—Gesenius, *Comment. su Jera.* i, 721 sq.), passed over to the islands which they had occupied, and thence to the people who succeeded the Phœnicians in the occupation of them. The use of the term was extended yet farther so as to embrace Italy (Bochart, *Phaleg*, iii, 5, compares the *Cetia*, *Keria*, in Latium, mentioned by Dionys. Hal. viii, c. 86), according to the Sept. (Dan.), and the Vulgate (Num. and Dan.), to which we may add the rendering of the Chaldee Targum, which gives *Italian* (אִטָּלִיָּה) in 1 Chron. i, 7, and *Apulia* (אִפּוּלִיָּה) in Ezek. xxvii, 6. In an ethnological point of view, Chittim, associated as the name is with Javan and Elishah, must be regarded as applying, not to the original Phœnician settlers of Cyprus, but to the race which succeeded them, viz. the Carians, who were widely dispersed over the Mediterranean coasts, and were settled in the Cyclades (Thucyd. i, 8), Crete (Herod. i, 171), and in the islands called Macaris Insule, perhaps as being the residence of the Carians. From these islands they were displaced by the Dorians and Ionians (Herod. l. c.), and emigrated to the main land, where they occupied the district named after them. The Carians were connected with the Leleges, and must be considered as related to the Pelagic family, though

quite distinct from the Hellenic branch (Knobel, *Völkertafel*, p. 95 sq.). Hengstenberg has lately endeavored (*Hist. of Balaam*, p. 500) to prove that in every passage in the Old Testament where the word occurs it means Cyprus, or the Cyprians.

The most probable view, however, is that expressed by Kitto: "Chittim seems to be a name of large signification (such as our Levant), applied to the islands and coasts of the Mediterranean in a loose sense, without fixing the particular part, though particular and different parts of the whole are probably in most cases to be understood" (*Pict. Bible*, note on Ezek. xxvii, 6).

(For further discussion, see Michaelis, *Spicilegium*, i, 1-7, 108-114; also *Supplem.* p. 1188, 1877-1880; Gesenius, *Thesaur.* p. 726; Newton, *On the Prophecies*, v; Rosenmüller, *Bibl. Geogr.* iii, 878.) See ETENOLOGY.

Chf'un (Heb. *Kiyus'*, חִי'וֹן), a word that occurs only once in the Scriptures, and that in an obscure and variously-interpreted passage (Amos v, 26), "But ye have borne the tabernacle of your Moloch and Chi'm, your images, the star of your god, which ye made to yourselves." The Sept. translates it as a proper name, *Rhephan* (Ραιφάν or Ρηφάν, which became still further corrupted into Ρεμφάν), and it is quoted in that form by Stephen (Acts vii, 43). See REMPHAN. The Syriac translates it by *Satur*, whom the Shemitic nations are known to have worshipped. But it apparently is not a proper name at all, being derived from the root חָנָה, *han*, to stand upright, and therefore signifies simply a statue or idol, as the Vulgate renders it (in connection with the following word), "*imaginem idolorum vestrum*." The same is probably true of the word rendered "Moloch" in the same passage, so that the whole may be translated (with Gesenius), "Ye bore the tabernacle of your king, and the statue of your idols, the star of your god which ye made to yourselves;" referring not to any specific deity by name, but to the secret idolatrous practices which the Jews kept up along with the worship connected with the divine ark in the wilderness, and which reappeared in different forms from time to time in their later history. See CALF. Yet, as a "star" is mentioned, it has naturally been inferred that the worship of some planet is alluded to, and this Jerome supposed to be Lucifer or Venus. Layard thinks the name identical with that of the Egyptian goddess *Kem*, figured on the Egyptian and Assyrian monuments in the character of Astarte or Venus (*Nineveh*, ii, 169); but he admits that her worship was borrowed from Assyria into Egypt at a period later than the Exodus (p. 170). On the whole, the above supposition that the planet Saturn is intended is the most plausible, although this interpretation cannot be successfully defended merely from the name, either in the form Chium or Remphan. (See MALIN, in his *Select. Exercit.* i, 768 sq.; Jahr, *De Chium* [Viteb. 1705]; Harenberg, *De idolis Chium et Remphan* [Brunsv. 1728]; Meyer, *De sacello et basi idolor. etc.* [ad loc.], [Helmet. 1726]; Wolf, *De Chium et Remphan* [Lips. 1741]; Braun, *Selecta Sacra*, p. 477 sq.) See SATURN.

Chlo'ë (Χλόη, *verdure*, a classical name), a female Christian mentioned in 1 Cor. i, 11, some of whose household (ὁπὸ τῶν Χλόης, where there is doubtless an ellipsis of οἰκίῳ, comp. Rom. xvi, 10, 11) had informed the apostle Paul of the fact that there were divisions in the Corinthian Church. A.D. 54. She is supposed by Theophylact and others to have been an inhabitant of Corinth; by Estius, some Christian woman known to the Corinthians elsewhere; by Michaelis and Meyer, an Ephesian, having friends at Corinth. See CORINTHIANS, EPISTLES TO.

Choëch. See THORN.

Cho'ba (Χωβά; Vulg. omits), a place mentioned in Judith iv, 4, apparently situated in the central part of Palestine. It is probably the same place as

Chob'al (*Χωβαλ*), which occurs in Judith xv, 4, 5 (in the latter verse *Χωβά*). The name suggests the **HOBAH** (q. v.) of Gen. xiv, 15 (חֲבוֹאֵן, which agrees with the reading of the Syriac), especially in connection with the mention of Damascus in verse 5, if the distance from the probable site of Bethulia (q. v.) were not too great. Van de Velde suggests (*Memoir*, p. 304) that it is probably the modern *Kubatsiyeh*, a village 1½ hour S. of Jenin, on the highway to Sebastiyeh or Samaria (*Narrative*, I, 368; comp. Stewart, *Tent and Khaw*, p. 421; Robinson, *Later Researches*, p. 120, 121).

Chonix (*χοινίξ*, rendered "measure" in our version, Rev. vi, 6), a Greek measure of capacity, equal in dry commodities to one eighth the modius (see **BUSHEL**), but varying, according to different ancient authors, from one and a half to two pints English. See **METROLOGY**.

Choir (Gr. *χορός*). The Greeks applied the term chorus to a circular dance performed during sacrifices by a company of singers around the altar of a deity. Later it was applied to this body of singing dancers. Actors afterwards were introduced, who related some myth or legend of the deity between the songs of the chorus, thus laying the foundation of the Greek drama. In the perfected drama, the chorus (composed of fifty persons in the tragedy and of twenty-four in the comedy) occupied a position intermediate between the actors and the audience, giving in a recitative manner, rather than in a song, counsel, warning, encouragement, or consolation to the actors.

Similar bodies of singers attended the religious observances of nearly all nations of antiquity. In the Jewish worship they were specially prominent after the time of David, being composed at times of 4000 singers and 288 leaders.

1. In the development of the ritual in the Christian churches, the body of singers received the same name of *chorus*. The French modification of the word, *chœur*, passed into the Norman and early English as *quire* or *choir*. The original term *chorus* is now applied to a body of singers carrying all the parts of music, in distinction from solo, duet, or quartet singers; also to the portion of music sung by this chorus. The two most noted *choirs* of the present day are that of the Vatican, in which the soprano and alto are sung by eunuchs, and the choir of the Cathedral of Berlin, in which the soprano and alto are sung by boys.

In the English Church, strictly, the term denotes a body of men set apart for the performance of all the services of the Church in the most solemn form. Properly speaking, the whole corporate body of a cathedral, including capitular and lay members, forms the choir, and in this extended sense ancient writers frequently use the word. But, in its more restricted sense, we are to understand that body of men and boys who form a part of the foundation of these places, and whose special duty it is to perform the service to music. The choir properly consists of clergymen, laymen, and chorister boys, and should have at least six men and six boys, these being essential to the due performance of the chants, services, and anthems. Every choir is divided into two parts, stationed on each side of the chancel, in order to sing alternately the verses of the psalms and hymns, one side answering the other.

2. The term *choir* is also applied in Roman churches to that portion of the church edifice allotted to the singers, nearly analogous to the chancel (q. v.) of Protestant churches. The choir is usually in the apsis (q. v.), behind the high altar, at the east (in the earlier churches in the west) and of the church. It is generally elevated one step above the level of the rest of the edifice. It has at least one row of seats or stalls. When there is more than one row, each row is a step above that before it. In this ritual sense of *place for the singers*, the choir is sometimes, especially in cruci-

form churches, under the tower or in front of the high altar. Large cathedrals also often have several choirs or chapels for singing mass. In Greek and Armenian churches the stalls for the singers are usually in the nave of the church, to the right and left of the front of the altar. In nunneries the choir is a part of the church, separated from the rest by a screen, where the nuns chant the service.

8. In Protestant churches generally, the word designates the body of singers, composed both of males and females, who conduct the congregational singing, with or without the aid of an organ. The name is also given to the place in the church occupied by the singers. See Bingham, *Orig. Eccles.* bk. viii, ch. vi, § 7; Bergier, *Dict. de Théologie*, I, 461.

Choir-wall, or **Choir-screen**, is the wall or screen of wood, metal, or stone which divides the choir or presbytery from the rest of the church. It is usually ornamented, often with great beauty.

Chol. See **SAND**.

Choled. See **WEASEL**.

Cholin. See **TALMUD**.

Chomer. See **HOMER**.

Chomet. See **SNAIL**.

Choose. See **CHOSKEN**.

Chor. See **LINEN**.

Choral. (I.) This term is applied to that portion of the Liturgy of the Roman and other churches in which simple melodies, usually consisting of but four or five notes, are sung by the officiating priest, with responses from the choir or the congregation. These date their origin from the earliest period of the Christian Church, and are thought by some to have been originally ancient pagan melodies adapted to Christian worship.

(II.) It is also, and more usually, applied to hymn tunes of a slow and majestic or pathetic movement, as "Old Hundred," the "Judgment Hymn," and "Mear." The Germans call all psalm tunes chorals, but they always retain the original slow movement, and all the voices join in the melody, the organ giving the accompaniment. In many Protestant countries all the four parts are sung in chorals as well as in other hymn tunes. For a historical development of choral singing, see **MUSIC (HISTORY OF)**.

Chor-a'shan (Heb. *Kor-Ashan*, כּוֹר־אֶשָׁן, **SMOKING FURNACE**; Sept. *Βαρσάν* v. r. *Βωρασάν* and even *Βηροσβεΐ*, I. e. Beer-sheba; Vulg. *lacus Ashan*; so that both appear to have read אֶשָׁן), one of the places (named between Hormah and Athach) in which "David and his men were wont to haunt," and to his friends in which he sent presents of the plunder taken from the Amalekites who had robbed Ziklag (1 Sam. xxx, 30). The towns named in this catalogue are all south of Hebron; and Chorashan, therefore, is probably identical with the simple **ASHAN** (q. v.) of Simeon (Josh. xv, 42; xix, 7).

Chora'zin (*Χοραζίν* v. r. *Χοραζέιν*, *Χοροζαίν*, and *Χωραζίν*), one of the cities (*πόλεις*) in which our Lord's mighty works were done, but named only in his denunciation (Matt. xi, 21; Luke x, 13; see Scherzer, *Salvatoris oraculum*, *Va tibi Chorazin*, Lips. 1710), in connection with Bethsaida and Capernaum, not far from which, in Galilee, it appears to have been situated. It was known to Jerome, who describes it (*Comm. in Matth.* xi) as on the shore of the lake, 2 miles from Capernaum, or 12 miles, according to Eusebius (*Onomast.* s. v. *Χωραζίν*, Chorozain). Some compare the Talmudical *Kerazin* (q. v.) (כּוֹרִיזִין, *Menachoth*, fol. 85, 1), mentioned as being famous for wheat (Reland, *Palest.* p. 722; Schwarz, *Palest.* p. 189); while others compare "HAROSHETH (q. v.) of the Gentiles" (חֲרוֹשֶׁת

שׁוֹרֵי, Judg. iv, 2); and still others consider the name as having been in the vernacular *Charashis* (חַרְשִׁי), i. e. *woody places* (Lightfoot, p. 160 sq.). Origen and some MSS. write the name *Chora-Zin* (Χώρα Ζιν, H. Ernesti, *Observat.* Amst. 1686, ii, 6), i. e. *district of Zin*; but this is probably mere conjecture. St. Willibald (about A. D. 750) visited the various places along the lake in the following order—Tiberias, Magdala, Capernaum, Bethsaida, Chorazin (*Early Trav.* Bohn, p. 17), being doubtless guided by local tradition, for the knowledge of the site has become utterly extinct (Robinson, *Researches*, iii, 295). Some writers at one time supposed it to be the same with *Kelat el-Horah*, a place on the eastern shore of the Sea of Genesareth, where Seetzen (*Reisen*, i, 844) and Burckhardt (*Trav.* p. 265) describe some ruins; but this is written *K. el-Horah* on later maps. A more recent writer (in the *Hall. Lit.-Zeit.* 1845, No. 238) regards it as a place in *Wady el-Jamus*; but this also lacks authority. Pococky (*East*, ii, 72) speaks of a village called *Gerusi* among the hills west of Tell-Houm, 10 or 12 miles north-north-east of Tiberias, and close to Capernaum. The natives, according to Dr. Richardson, call it *Chorazin*. It is apparently this place which Keith and Van de Velde (*Memoir*, p. 304) call *Kerash*, and describe as containing several pedestals of columns, with levelled shafts, and the remains of a building formed of large hewn stones; while Dr. Robinson (*Later Biblical Res.* p. 860) rejects the identification with disparagement of the antiquities (p. 847), although he did not visit the site (*Biblioth. Sacra*, 1853, p. 187), which Dr. Thomson, nevertheless, confidently adopts (*Land and Book*, ii, 8), apparently with good reason. M. De Saulcy is disposed to identify Chorazin with the fountain *Ain et-Tin*, near the northern extremity of the plain of Genesareth; but his arguments, except the vicinity of the spots to the lake, are frivolous (*Narrative*, ii, 871). The question is intimately connected with that of the position of Capernaum (q. v.). Dissertations on the curse pronounced by Christ against this and the neighboring places (Matt. xi, 21) have been written in Latin by Scherzer (Lips. 1666), Hornbeck (*Miscell. Sacr.* Ultraj. 1687, I, iii, 801 sq.), Schott (Tüb. 1766).

Chorepiscopi (χωρεπίσκοποι, *country bishops*), an order of ministers of ancient origin. Some (e. g. Rhabanus Maurus) derive the name from the fact that the bishop was chosen *ex choro sacerdotum*; others from *cor episcopi* (heart of the bishop), as their function was to assist the city bishop in rural districts, or villages remote from his residence. The most simple and likely derivation is from χώρα, *country*. Some writers hold that they were only presbyters, but it appears certain (see the full discussion in Bingham) that they discharged episcopal functions. They acted, however, in a subordinate capacity, and possessed limited powers, being subject to a city-bishop, and acting as his colleagues or vicars. They held a different rank, but possessed a similar office; they were authorized to give letters of peace and testimonials; to superintend the affairs of the Church in their district; to appoint ecclesiastical officers, readers, subdeacons, and exorcists; and to ordain presbyters and deacons, but without the permission and co-operation of the superior or city-bishop. They possessed the privilege of attending councils in their own right, and not merely as substitutes or representatives of the bishop. The canons of the Council of Nicea, A. D. 325, were subscribed by nine *chorepiscopi*, attached to dioceses of which the bishops also were present. These officers were at first confined to the Eastern Church; in the Western they began to be known about the fifth century. They were never numerous in Spain and Italy, but abounded in Africa and Germany. In the Western Church, Pope Nicholas I (A. D. 864) ordained that they should abstain from all episcopal functions (Mansi, *Conc.* xv, 869); and Leo VII issued a similar re-

script about A. D. 987 (Mansi, xviii, 378); but, according to some writers, they continued in France till the twelfth, and in Ireland till the thirteenth. They were succeeded by archdeacons, rural deans, and vicars-general. In the East the order was abolished, for the same reason, by the Council of Laodicea, about A. D. 365, which decreed (canon 57) that itinerant presbyters, *περοδευται*, should visit the country villages for the future, in lieu of resident chorepiscopi; but the order continued until the tenth century. The necessity of suffragan bishops greatly increased after the cessation of the *chorepiscopi*.—Bingham, *Orig. Eccles.* bk. ii, ch. xiv, § 12; Moehim, *Historical Commentaries*, i, 175 (and references there); Siegel, *Alterthümer*, i, 287 sq.

Chorus. See **CHOIR.**

Chosama's (Χοσαμαίος), a name given in the Apocrypha (1 Eedr. ix, 52) apparently as a surname or epithet of one Simon, in the list of "Temple servants" returned from the Captivity; but nothing corresponding to either name appears in the Hebrew text (Ezra ii, 47).

Chosen (prop. חֲרָשָׁה, *bacher*; ἐλεκτός), "singled out from others to some honorable service or station." "Chosen" warriors are such as are picked out as the most valiant and skilful in an army, or as best adapted to some special and momentous enterprise (Exod. xv, 4; Judg. xx, 6). The Hebrew nation was a 'chosen' people, God having set them apart to receive his word and preerive his worship (Psa. cv, 43; Deut. vii, 7). Jerusalem was 'chosen' to be the seat of his temple (1 Kings xi, 18). Christ is the 'chosen' of God: from eternity he was set apart in the Divine mind as the only fit person to be our mediator and surety (Isa. xlii, 1). The apostles were 'chosen,' fixed upon, and set apart from others to bear witness unto Christ's resurrection (Acts x, 41). There is an error in supposing a certain fixed technical meaning of the word, irrespective of that to which each is 'chosen.' The Christian Church (that is, 'all in every place' to whom the Gospel has been announced) has been chosen to the enjoyment of the benefits and privileges placed within the reach of all to whom such announcement has been made; while others, who remain in ignorance of Christianity, cannot be said to have been thus 'chosen.' Then, again, 'many are called, but few chosen,' viz., as having so profited by their opportunities as to be accepted finally."—Eden, *Church Dictionary*, s. v. See **ELECT.**

Choules, JOHN O., a Baptist minister, was born in Bristol, England, Feb. 5, 1801. He was baptized by Dr. Ryland in 1820, and emigrated to America in 1824. After teaching three years at Red Hook, he became pastor of the Second Baptist Church, Newport, R. I., in 1827, but removed in 1833 to Buffalo. After serving as pastor there and in New York, he returned to Newport, where he remained as pastor of the Second Church during the rest of his life. He died while on a visit to New York, Jan. 7, 1856. He was a frequent contributor to periodicals, and at one time edited the *Boston Christian Times*. Besides smaller works, he published *The Origin and History of Missions*, by J. O. Choules and Thomas Smith (Boston, 1837, 2 vols. 4to). See Hague, *Discourse commemorative of Dr. Choules* (N. Y. 1856).—Duyckinck, *Cyclopaedia of American Literature*, ii, 817; *Christian Review*, 1856, p. 810.

Choze'ba (Heb. *Kozeba'*, כּוֹזְבָא, *lying*; Sept. *Χοζοβὰ*, Vulg. *mendacium*), a place whose inhabitants ("men of Chozeba") are named (1 Chron. iv, 22) among the descendants of Shelah, the son of Judah. The name is sufficiently like the **CHEZIB** (and especially the reading of the Samaritan Codex of that name, כּוֹזִיב) where Shelah was born (Gen. xxxviii, 5) to suggest that the two refer to the same place; that, namely, elsewhere (Josh. xv, 44) called **ACHZIB** (q. v.) in Judah.

Christians. The heathen made a mistake in the name of our Saviour, whom they generally called *Chrestus*, and his followers *Christians* (Suetonius, in *Claud.* 25). This is noted by Justin Martyr (*Apol.* 2), Tertullian (*Apol.* c. 8), and Lactantius (iv, 7). *Christus* is the same with the Hebrew *Messias*, and signifies a person anointed; while *Chrestus*, *χρηστικός*, means good. Tertullian tells the heathen that they were unpardonable for persecuting Christians merely for their name, for both names were innocent and excellent.—Bingham, *Orig. Eccles.* bk. i, ch. i, § 11.

Chrestus, a person named by Suetonius (*Claud.* 25) as having incited a sedition among the Jews at Rome, which led to their expulsion from the city (comp. Acts xviii, 2). Comp. FULVIA. There have been two different opinions as to whom Suetonius meant by *Chrestus* (see Kuinöl, *ad Act.* in loc.); whether some Hellenist, who had excited political disturbances (as Meyer and De Wette suppose; see Conybeare and Howson, *St. Paul*, i, 886), the name *Chrestus* (Gr. *χρηστικός*, *useful*) frequently occurring as borne by manumitted slaves; or whether, as there is good reason to think (Lipsius on Tacit. *Annal.* xv, 44; Grotius, on *Act.* xviii, 2; Neander, *Planting and Training*, ii, 231), Suetonius does not refer to some actual dissension between Jews and Christians, but confounds the name *Christ*, which was most unusual as a proper name, with the much more frequent appellation of *Chrestus* (see Tertullian, *Apol.* 3; Lactantius, *Instit.* iv, 7, 5; Milman, *Hist. of Christianity*, i, 430). Orosius (*Hist.* vii, 6) places Claudius's edict of banishment in the ninth year of his reign (i. e. A.D. 49 or 50), and he refers to Josephus, who, however, says nothing about the matter. In King Alfred's Anglo-Saxon version of Orosius, however, this reference to Josephus does not occur; the register simply connects the expulsion with a famine: "In the ninth year of his government there was a great famine in Rome, and Claudius ordered all the Jews that were therein to be driven out" (Bosworth's Orosius, p. 119 of the Saxon and 179 of the trans. See this statement of Orosius commented on by Scaliger, *Animadv.* on Euseb. *Chron.* p. 192). On the contrary, Pearson (*Ann. Paulin.*) and Vogel (in Gabler's *Journal*), without, however, giving decisive grounds for their opinion, suppose Claudius's twelfth year (i. e. A.D. 52) to be the more likely one. With Anger (*De temporum ratione in Act. Apost.* p. 118), one might, on negative grounds, assert that, so long as Herod Agrippa was at Rome with Claudius, the edict of expulsion would hardly be published; i. e. previous to the year A.D. 49. Dr. Burton, however (*On the Chronology of the Acts*, p. 26), puts the date of the edict some time between A.D. 41 and 46, supporting his opinion by the fact "that no mention is made of Claudius's decree in the Annals of Tacitus which have come down to us; and that, since the lost books of the Annals occupy the first six years of the reign of Claudius, it is probable that Tacitus mentioned this decree in one of those books." The year referred to in Acts xviii, 2, is A.D. 49.—Kitto, s. v. See CLAUDIUS.

Chrism (from *χρισμα*, *oil, unction*), consecrated oil, used in the Roman and Eastern churches in the rites of baptism, confirmation, ordination, and extreme unction.

1. *Origin of the Usage.*—In the N. T. the word is used metaphorically for the grace of the Spirit; e. g. John xi, 20, *Ye have an unction (χρισμα) from the Holy One.* The actual use of oil in Christian rites is ascribed by Beail (and some Romanist writers follow him) to the apostles, but there is no foundation for this. It is probable that the name Christian (*anointed*) itself gave rise, at an early period, to the anointing of heathens before or at their baptism. Unction is mentioned by Tertullian, Cyril of Jerusalem, and the Apostolical Constitutions; and in the fourth century it seems to be found in general use throughout the Church. From

Tertullian's time (A.D. 220) onward we find mention of a double anointing at baptism, one before, the other after. The latter is called, by way of distinction, *χρισμα*. The first (*ἄνωξις*) was preparatory, and took place immediately after exorcism and the signature of the cross. Of the design of chrism, Cyril of Jerusalem (*Cateches. Mystag.* 2) says, "Men were anointed from head to foot with this consecrated oil, and this made them partakers of the true olive-tree, Jesus Christ. For they, being cut out of a wild olive-tree, and ingrafted into a good olive-tree, were made partakers of the fatness of the good olive-tree." Ambrose (*De Sacramento* lib. i, c. 2) compares it to the anointing of the wrestlers before the combat: "Thou camest to the font and wast anointed as a *champion* of Christ, to fight the fight of this world." A distinction between the two anointings is made. "Men were first anointed with the ancient oil, that they may be Christ's; that is, the anointed of God; but they were anointed with the precious ointment after baptism in remembrance of him who reputed the anointing of himself with ointment to be his burial" (Justin Mart. *Respons. ad Orthodox.* qu. 187). The *Apostol. Constitutions* make the same distinction (bk. vii, ch. 22). Chrysostom says, "Every person, before he was baptized, was anointed as wrestlers entering the field; and this not as the high-priest was anointed of old, only on the head, or right hand, or ear, but all over his body, because he came not only to be taught, but to exercise himself in a fight or combat" (*Hom. vi in Coloss.*).

2. *In the Roman and Greek Churches.*—(1) At baptism the catechumen is anointed with "holy oil" on the breast and between the shoulders, by the priest, with the sign of the cross; after the baptism, the chrism is applied to the crown of the head, that the person baptized may know "that he is called a Christian from Christ, as Christ is so called from chrism" (*Catechism of Trent*, p. 185, 186, Balt. ed.). (2) In confirmation, the chrism (made of olive oil and balsam, and consecrated by the bishop) constitutes the *matter* of the sacrament, a doctrine resting ultimately upon the forged decretals (q. v.), and is applied to the forehead of the person confirmed (*Catechism of Trent*, p. 141 sq.). (3) In extreme unction, olive oil alone can be used (without balsam), and it is applied to the organs of the five senses, and also to the loins and feet.

The Greek Church agrees with the Roman as to the spiritual value of chrism, but there are some differences of usage. Both require that the chrism shall be consecrated; but every bishop has the right to consecrate it in the Roman Church, while the Greek confines this power to the patriarchs. The Greek Church, however, uses a chrism compounded of some forty ingredients, besides oil (see list of them in Siegel, i, 397). See CONFIRMATION; EXTREME UNCTION.

In the Protestant churches chrism is not used.—Bingham, *Orig. Eccles.* bk. xi, ch. 9, 10; Siegel, *Alterthümer*, i, 396 sq.; Elliott, *Delineation of Romanism*, bk. ii, ch. 2, 8; Burnet, *On the Articles*, art. xxv.

Chrisome (*chrismale*). In the Roman Church the priest puts on the baptized person after the *Chrism* a white robe, saying, "Receive this white garment, which mayest thou carry unstained, etc." In the baptism of infants a white kerchief is given instead of the garment, with the same words.

By a constitution of Edmund, archbishop of Canterbury, A.D. 736, the chrisomes, after having served the purposes of baptism, were to be made use of only for the making or mending of surplices, etc., or for the wrapping of chalice. A "chrisome child," in old English usage, was a child in its chrisome cloth. Thus Jeremy Taylor: "This day is mine and yours, but ye know not what shall be on the morrow; and every morning creeps out of a dark cloud, leaving behind it an ignorance and silence deep as midnight, and undiscerned as are the phantasms that make a chrisome child to smile" (*Holy Dying*, chap. i, sec. 2).

The first Common Prayer-book of King Edward orders that the woman shall offer the chrism when she comes to be church'd; but, if the child happens to die before her churching, she was excused from offering it; and it was customary to use it as a shroud, and to wrap the child in it when it was buried. Hence, by an abuse of words, the term is now used in England not to denote children who die between the time of their baptism and the churching of the mother, but to denote children who die before they are baptized, and so are incapable of Christian burial.—*Catechism of Trent* (Balt. ed.), p. 186; Hook, *Church Dictionary*, s. v.; Procter, *On Common Prayer*, 378.

CHRIST (*Χριστός*, *anointed*, a Greek translation of the Heb. מָשִׁיחַ, *Messiah*, and so used in the Sept.), the official title of our Saviour (occurring first in 2 Eadr. vii, 29, and constantly in the New Test.), as having been consecrated to his redemptive work by the baptism at Jordan, the descent of the Holy Spirit and his plenary unction, as the prophet, priest, and king of his people. See **CHRIST, OFFICES OF; MESSIAH**. It thus also distinguishes the individual Jesus (q. v.), which is his human appellation, from others of the same name; while his relations to the Godhead are expressed by the term "the Word" or **LOGOS** (q. v.), **CHRIST** therefore is not, strictly speaking, a proper name, but a designation of office. "Jesus Christ," or rather "Jesus the Christ," is a mode of expression of the same kind as "John the Baptist," or Baptizer. In consequence of not adverting to this, the import of many passages of Scripture is misapprehended, e. g. Acts xvii, 3; xviii, 5; Matt. xxii, 42. But the word, though an appellative, intended to denote a particular official character, came to be used as a strictly personal designation of the Lord Jesus. Even the term *Messiah* towards the close of the O. T. came to be used of the expected Redeemer much as a proper name (without the article prefixed); and *Χριστός* is often similarly used in the N. T. (e. g. Luke ii, 11; John iv, 26; especially by Christ himself, John xvii, 8). But as it was not settled in men's minds, when Jesus first appeared, that he was really *Messiah*, we usually find the article prefixed to *Χριστός* "until after the resurrection, when all doubt vanished from the minds of his followers. So, while in the Gospels the name is rarely found without the article, it is almost as rarely found with the article in the Epistles" (Fairbairn, *Hermeneutical Manual*, p. 236).

1. History of the Title.—(1.) **Uction**, from a very early age, seems to have been the emblem of consecration, or setting apart to a particular, and especially to a religious purpose. Thus Jacob is said to have *anointed* the pillar of stone, which he erected and set apart as a monument of his supernatural dream at Beth-el (Gen. xxviii, 18; xxxi, 18; xxxv, 14). Under the Old-Testament economy high-priests and kings were regularly set apart to their offices, both of which were, strictly speaking, sacred ones, by the ceremony of anointing, and the prophets were occasionally designated by the same rite. This rite seems to have been intended as a public intimation of a divine appointment to office. Thus Saul is termed "the Lord's anointed" (1 Sam. xxiv, 6); David, "the anointed of the God of Israel" (2 Sam. xxiii, 1); and Zedekiah, "the anointed of the Lord" (Lam. iv, 20). The high-priest is called "the anointed priest" (Lev. iv, 3). See **ANOINTING**.

(2.) From the origin and design of the rite, it is not wonderful that the term should have been applied, in a secondary and analogical sense, to persons set apart by God for important purposes, though not actually anointed. Thus Cyrus, the king of Persia, is termed "the Lord's anointed" (Isa. xlv, 1); the Hebrew patriarchs, when sojourning in Canaan, are termed "God's anointed ones" (Psa. cv, 15); and the Israelitish people receive the same appellation from the prophet Ha-

bakkuk (iii, 18). It is probably with reference to this use of the expression that Moses is said by the writer of the Epistle to the Hebrews to have "counted the reproach of Christ" (Heb. xi, 26), *τὸν Χριστὸν (λαοῦ)*, the same class who in the parallel clause are termed the "people of God," "greater riches than the treasures of Egypt."

(3.) In the prophetic Scriptures we find this appellation given to an illustrious personage, who, under various designations, is so often spoken of as destined to appear in a distant age as a great deliverer. α. The royal prophet David seems to have been the first who spoke of the Great Deliverer under this appellation. He represents the heathen (the Gentile nations) raging, and the people (the Jewish people) imagining a vain thing "against Jehovah, and against his *Anointed*" (Psa. ii, 2). He says, "Now know I that the Lord saveth his *Anointed*" (Psa. xx, 6). "Thou hast loved righteousness and hated iniquity," says he, addressing himself to "Him who was to come," "therefore God, even thy God, hath *anointed* thee with the oil of gladness above thy fellows" (Psa. xlv, 7). In all the passages in which the Great Deliverer is spoken of as "the Anointed One" by David, he is plainly viewed as sustaining the character of a king.

β. The prophet Isaiah also uses the appellation "the Anointed One" with reference to the promised deliverer, but when he does so, he speaks of him as a prophet or great teacher. He introduces him as saying, "The Spirit of the Lord God is upon me, because the Lord God hath *anointed* me to preach good tidings unto the meek; he hath sent me to bind up the broken-hearted, to proclaim liberty to the captives, and the opening of the prison to them who are bound; to proclaim the acceptable year of the Lord, and the day of vengeance of our God; to comfort all that mourn," etc. (Isa. lxi, 1, etc.).

γ. Daniel is the only other of the prophets who uses the appellation "the Anointed One" in reference to the Great Deliverer, and he plainly represents him as not only a prince, but also a high-priest, an expiator of guilt. "Seventy weeks are determined upon thy people and upon thy holy city, to punish the transgression, and to make an end of sins, and to make reconciliation for iniquity, and to bring in everlasting righteousness, and to seal up the vision and the prophecy, and to *anoint* the most holy. Know therefore and understand that from the going forth of the commandment to restore Jerusalem unto *Messiah* the Prince shall be seven weeks and threescore and two weeks; the city shall be built again, and the wall, even in troublous times; and after threescore and two weeks shall *Messiah* be cut off, but not for himself" (Dan. ix, 24-26). See **SEVENTY WEEKS**.

(4.) During the period which elapsed from the close of the prophetic canon till the birth of Jesus no appellation of the expected deliverer seems to have been so common as the *Messiah* or *Anointed One*, and this is still the name which the unbelieving Jews ordinarily employ when speaking of him whom they still look for to avenge their wrongs and restore them to more than their former honors.

Messiah, *Christ*, *Anointed*, is, then, a term equivalent to consecrated, sacred, set apart; and as the record of divine revelation is called, by way of eminence, *The Bible*, or book, so is the Great Deliverer called *The Messiah*, or *Anointed One*, much in the same way as he is termed *The Man*, *The Son of Man*. See **ANointed**.

2. The import of this designation as given to Jesus of Nazareth may now readily be apprehended.

(1.) No attentive reader of the Old Testament can help noticing that in every part of the prophecies there is ever and anon presented to our view an illustrious personage destined to appear at some future distant period, and, however varied may be the figurative representations given of him, no reasonable doubt can be

entertained as to the identity of the individual. Thus the Messiah is the same person as "the seed of the woman" who was to "bruise the head of the serpent" (Gen. iii, 15); "the seed of Abraham, in whom all the nations of the earth were to be blessed" (Gen. xxii, 18); the great "prophet to be raised up like unto Moses," whom all were to be required to hear and obey (Deut. xviii, 15); "the priest after the order of Melchizedek;" "the rod out of the stem of Jesse, which should stand for an ensign of the people to which the Gentiles should seek" (Isa. xi, 1, 10); the virgin's son, whose name was to be Immanuel (Isa. vii, 14); "the branch of Jehovah" (Isa. iv, 2); "the Angel of the Covenant" (Mal. iii, 1); "the Lord of the Temple," etc., etc. (2b). When we say, then, that Jesus is the Christ, we in effect say, "This is He of whom Moses in the law and the prophets did write" (John 1, 45); and all that they say of Him is true of Jesus.

The sum of this prophetic testimony respecting him is that he should belong to the very highest order of being, the incommunicable name Jehovah being represented as rightfully belonging to him; that "his goings forth have been from old, from everlasting" (Mic. v, 2); that his appropriate appellations should be "Wonderful, Counsellor, the Mighty God" (Isa. ix, 6); that he should assume human nature, and become "a child born" of the Israelitish nation of the tribe of Judah (Gen. x'ix, 10), of the family of David (Isa. xi, 1); that the object of his appearance should be the salvation of mankind, both Jews and Gentiles (Isa. xlix, 6); that he should be "despised and rejected" of his countrymen; that he should be "cut off, but not for himself;" that he should be "wounded for men's transgressions, bruised for their iniquities, and undergo the chastisement of their peace;" that "by his stripes men should be healed;" that "the Lord should lay on him the iniquity" of men; that "exaction should be made and he should answer it;" that he should "make his soul an offering for sin;" that after these sufferings he should be "exalted and extolled, and made very high;" that he should "see of the travail of his soul and be satisfied, and by his knowledge justify many" (Isa. lii, *passim*); that Jehovah should say to him, "Sit at my right hand until I make thine enemies thy footstool" (Psa. cx, 1); that he should be brought near to the Ancient of Days, and that to him should be given "dominion, and glory, and a kingdom, that all people, and nations, and languages should serve him—an everlasting dominion which shall not pass away—a kingdom that shall not be destroyed" (Dan. vii, 18, 14). All this is implied in saying Jesus is the Christ. In the plainer language of the New Testament, "Jesus is the Christ" is equivalent to Jesus is "God manifest in the flesh" (1 Tim. iii, 16)—the Son of God, who, in human nature, by his obedience, and sufferings, and death in the room of the guilty, has obtained salvation for them, and all power in heaven and earth for himself, that he may give eternal life to all coming to the Father through him.

(2.) While the statement "Jesus is the Christ" is thus materially equivalent to the statement "all that is said of the Great Deliverer in the Old Testament Scriptures is true of Him," it brings more directly before our mind those truths respecting him which the appellation "the Anointed One" naturally suggests. He is a prophet, a priest, and a king. He is the great revealer of divine truth; the only explainer of human guilt, and reconciler of man to God; the supreme and sole legitimate ruler over the understandings, consciences, and affections of men. In his person, and work, and word, by his spirit and providence, he unfolds the truth with respect to the divine character and will, and so conveys it into the mind as to make it the effectual means of conforming man's will to God's will, man's character to God's character. He has by his spotless, all-perfect obedience, amid the severest sufferings, "obedience unto death, even the death of the

cross," so illustrated the excellence of the divine law, and the wickedness and danger of violating it, as to make it a righteous thing in "the just God" to "justify the ungodly," thus propitiating the offended majesty of heaven; while the manifestation of the divine love in appointing and accepting this atonement, when apprehended by the mind under the influence of the Holy Spirit, becomes the effectual means of reconciling man to God and to his law, "transforming him by the renewing of his mind." And now, possessed of "all power in heaven and earth," "all power over all flesh," "He is Lord of all." All external events and all spiritual influences are equally under his control, and as a king he exerts his authority in carrying into full effect the great purposes which his revelations as a prophet, and his great atoning sacrifice as a high-priest, were intended to accomplish. See CHRIST, OFFICES OF.

(3.) But the full import of the appellation the CHRIST is not yet brought out. It indicates that He to whom it belongs is the *anointed* prophet, priest, and king—not that he was anointed by material oil, but that he was divinely *appointed, qualified, commissioned, and accredited* to be the Saviour of men. These are the ideas which the term *anointed* seems specially intended to convey. a. Jesus was divinely *appointed* to the offices he filled. He did not assume them, "he was called of God as was Aaron" (Heb. v, 4), "Behold mine ELECT, in whom my soul delighteth." b. He was divinely *qualified*: "God gave to him the Spirit not by measure." "The Spirit of the Lord was upon him," etc. (Isa. xi, 2-4). c. He was divinely *commissioned*: "The Father sent him." Jehovah said to him, "Thou art my servant, in thee will I be glorified," etc. (Isa. xlix, 6). "Behold," says Jehovah, "I have given Him for a witness to the people—a leader and commander to the people." d. He is divinely *accredited*: "Jesus of Nazareth," says the apostle Peter, was "a man approved of God among you by miracles, and wonders, and signs which God did by him in the midst of you" (Acts ii, 22). "The Father who hath sent me," says Jesus himself, "hath borne witness of me" (John v, 37). This he did again and again by a voice from heaven, as well as by the miracles which he performed by that divine power which was equally his and his Father's. Such is the import of the appellation *Christ*.

8. If these observations are clearly apprehended, there will be little difficulty in giving a satisfactory answer to the question which has sometimes been proposed—when did Jesus become Christ? when was he *anointed* of God? We have seen that the expression is a figurative or analogical one, and therefore we need not wonder that its references are varying. The *appointment* of the Saviour, like all the other divine purposes, was of course from eternity: he "was set up from everlasting" (Prov. viii, 23); he "was fore-ordained before the foundation of the world" (1 Pet. i, 20). His qualifications, such of them as were conferred, were bestowed in or during his incarnation, when "God anointed him with the Holy Ghost and with power" (Acts x, 38). His commission may be considered as given him when called to enter on the functions of his office. He himself, after quoting in the synagogue of Nazareth, in the commencement of his ministry, the passage from the prophecies of Isaiah in which his unction to the prophetic office is predicted, declared, "This day is this Scripture fulfilled in your ears." And in his resurrection and ascension, God, as the reward of his loving righteousness and hating iniquity, "anointed him with the oil of gladness above his fellows" (Psa. xiv, 7), i. e. conferred on him a regal power, fruitful in blessings to himself and others, far superior to that which any king had ever possessed, making him, as the apostle Peter expresses it, "both Lord and Christ" (Acts ii, 36). As to his being *accredited*, every miraculous event performed in refer-

ence to him or by him may be viewed as included in this species of anointing, especially the visible descent of the Spirit on him in his baptism.

4. These statements, with regard to the import of the appellation "the Christ," show us how we are to understand the statement of the apostle John. "Who-soever believes that Jesus is the Christ is born of God" (1 John v, 1), i. e. is "a child of God," "born again," "a new creature;" and the similar declaration of the apostle Paul, "No man can say that Jesus is the Lord," i. e. the Christ, the Messiah, "but by the Holy Ghost" (1 Cor. xii, 8). It is plain that the proposition, "Jesus is the Christ," when understood in the latitude of meaning which we have shown belongs to it, contains a complete summary of the truth respecting the divine method of salvation. To believe that proposition, rightly understood, is to believe the Gospel—the saving truth, by the faith of which a man is, and by the faith of which only a man can be, brought into the relation or formed to the character of a child of God; and though a man may, without divine influence, be brought to acknowledge that "Jesus is the Lord," "Messiah the Prince," and even firmly to believe that these words embody a truth, yet no man can be brought really to believe and cordially to acknowledge the truth contained in these words, as we have attempted to unfold it, without a peculiar divine influence. That Jesus is the great comer (ὁ ἐρχόμενος, ὁ ἰδῶν) is the testimony of God, the faith of which constitutes a Christian, the one thing (τὸ ἓν) to which the Spirit, the water, and the blood unite in bearing witness (1 John v, 6-9).—Holmes, in Kitto's *Cyclopædia*, s. v. Jesus Christ, from which this article is taken, with modifications. See JESUS.

CHRIST, ASCENSION OF. See ASCENSION.

CHRIST, CRUCIFIXION OF. See CRUCIFIXION.

CHRIST, DEATH OF. See CRUCIFIXION; JESUS.

CHRIST, DIVINITY OF. See CHRISTOLOGY; INCARNATION.

CHRIST, HUMANITY OF. See CHRISTOLOGY; INCARNATION.

CHRIST, IMAGES AND PORTRAITS OF. The Gospels contain no notice whatever of the personal appearance of Christ. The passages in the O. T. which refer to his person (Isa. lii, 14; liii, 2) seem almost like premonitory warnings against any worship of Christ "after the flesh." The Apostolical Fathers are as silent on this subject as the Scriptures are. "Either the Church was too spiritual to desire such descriptions, or its leaders were too faithful to invent them." So completely, indeed, had all tradition of the personal appearance of Christ died out, that, as early as a hundred years after his death, a long controversy arose as to whether he was in form and features as described by the prophet Isaiah (lii, 14; liii, 2), without comeliness and beauty. Justin Martyr, Tertullian, and Cyril took the ground that Christ was physically uncomely; Cyril even declares that Christ was the "ugliest of the sons of men." Ambrose, Jerome, and the later fathers generally, declared him to have been the most beautiful of mankind (Didron, *Christian Iconography*, i, 268). The spurious letter of Lentulus to the Roman senate, describing Christ as a man of noble appearance, with curled hair parted in front, and falling, dark and glossy, over his shoulders, with a smooth, high forehead, a strong, reddish, and irregular beard, dated probably also from the third century, but has been known, in its present form, only since the eleventh. See LENTULUS.

When persecution arose, the early Christians felt soon the need of some visible sign of their faith. The earliest adopted was the *fish* (q. v.). Afterwards the figures under which Christ presented himself in the New Testament, as the *vine*, the *LAMB* (of God which taketh away the sins of the world), and, above all, as the Good Shepherd (q. v.) carrying a lamb on his shoulders, were introduced into the paintings and

sculptures of the Catacombs of Rome, Naples, and Syracuse. The so-called monogram of Christ, viz. $\chi\rho$ (for $\chi\rho$, the two first letters of the name $\chi\rho\iota\sigma\tau\acute{o}\varsigma$), with or without the letters α , ω (the Alpha and Omega of the Apocalypse), appears about the time of Constantine (\dagger 387). See CHRIST, MONOGRAM OF; ALPHA; AGNUS DEI.

Again, the best class of pagan thinkers in the Roman empire, even before the official adoption of Christianity, had become dissatisfied with the complications of polytheism, and were seeking for a simpler faith. Perhaps the mystery of the unity of the Godhead, which had been celebrated through nearly all forms of paganism in secret rites, had become the common property of educated minds. Egyptian mythology, with the *sun* as its great centre, had also made its impress on the Roman mind. And thus, towards the later periods of the supremacy of paganism in the Roman empire, *Apollo*, as the deity of the sun, had assumed the chief place in heathen worship. As indicating that Christ was the true "light of the world," the "Sun of righteousness"—the most favorite figure used in speaking of the Saviour in the early centuries—this very figure of Apollo was often introduced as indicating Christ. *Orpheus* was also often thus introduced, as indicating that Christ is the true charmer of the evil passions of the human heart—indicated by the beasts that quietly listened to his music, and the true ruler of the powers of nature—indicated by the trees and other plants bowing to his music.

The figure of the Good Shepherd, usually a beardless youth not over twenty years of age, with long, curly hair and a joyful countenance, gave the most usual type of the personal figure of Christ, when represented on the sarcophagi and in some of the frescoes of the Catacombs. Many of these sarcophagi are now in the Museum of the Lateran. One of the most interesting of these youthful figures of the Saviour in sculptured monuments is that in the tomb of Junius Bassus (A. D. 359), in the church of St. Peter, at Rome, in which Christ is represented disputing with the doctors. This type of the Saviour as a youth appeared again in some manuscripts, and in other paintings of the early part of the Middle Ages.

Quite a different type, however, predominated at a later period in all Christian art through the entire Middle Ages. The first example of it occurs in a tablet of ivory now in the Vatican museum. The second, and by far the better example of this type, is a painting in a chapel in the catacombs of Callistus. It is considered by recent Roman archaeologists to be of the second century, but this is not at all probable. It represents the Saviour as about thirty-three years of age, with a somewhat elongated oval face, bearded, with a grave and somewhat melancholy, but still sweet and benign expression of injured innocence. The features are not to be recognised as distinctively Greek, Roman, or Jewish, but they are highly ideal. The brow is high; the beard is sparse, somewhat pointed, and of a reddish hue; the hair parts in the middle, and flows in abundant curling masses over the shoulders. Of the many varieties of representations of Christ, of which Augustine speaks as existing in his day, this type soon gained the predominance in the Christian world, and it has held its place till modern times. In the mosaics of the Basilicas and the Byzantine churches, in Rome, Constantinople, and Ravenna, it gained an inexpressible grandeur, which was not entirely lost during the decadence of the so-called Byzantine period of painting (A. D. 600-1000). Almost its original power was renewed under the hand of Giotto. It finally reached its highest development in Christ as the Redeemer in Leonardo's Last Supper, and in Christ the Judge in Michael Angelo's Last Judgment.

In the scenes of the birth, infancy, and early childhood of the Saviour, attempts have usually been made

to infuse into his face indications of the divinity of his nature. This reached its climax in the miniatures of some Grecian manuscripts, in the paintings of the pre-Raphaelites, and especially in the Christ of the Sistine Madonna (at Dresden). Later in life, even Raphael painted the youthful Christ as merely a blooming or laughing child. Other Italian painters, in the decadence of morals of the seventeenth and eighteenth centuries, painted portraits of beautiful children in the arms of their mistresses as madonnas. Some Flemish and Dutch painters imagined scenes in which Christ, as a dutiful child obedient to the law, was helping his mother in such homely duties as hanging out clothes which she was washing, or as helping his father in his labors as carpenter.

When represented as disputing with the doctors, he is usually placed on a seat above the other figures, with his feet on a stool, as symbol of his high position and authority.

In whatever scene of his life he appeared, he is often represented, after the time of Constantine, with a nimbus (q. v.) around his head, as a symbol of his heavenly nature and origin. This often also included a cross, or the monogram XP . He is usually represented larger than the surrounding figures. As indicating his authority and power, the Saviour is often represented with a globe—the universe—under his feet; or as sitting on the globe, or the rainbow, or with a wand in his hand, especially while performing miracles. The Saviour was usually represented in the early works as wearing a tunic, over which was thrown the *pallium* of the ancients. The tunic often had two bands of purple or of gold on the breast, and, like the *pallium*, it was of white cloth. Sometimes a volume, the New Testament, was placed in his hand, or he was placed between two cases of volumes, the Old and the New Testament.

Besides direct scenes from his own life, or representations indicating his holy mission, the Saviour was, during the first centuries, when symbolism was carried to a very great perfection, sometimes represented in scenes from the Old Testament, as in the fiery furnace with the three worthies, with Daniel in the lions' den, and in the place of Moses, when that patriarch was striking the rock.

Besides these extant representations of the Saviour in Christian art, we know that the Gnostics had what they called images of Christ as early as the second century. Raoul Rochette (*Types de l'Art*, p. 9 sq.) says that the cast of features described above as belonging to the best portraits of Christ was derived from the Gnostic artists. Compare also Irenæus, *adv. Hæc.* i, 25, § 6. A century later, the emperor Alexander Severus (A. D. 222-235) placed among his household gods figures of Abraham and Christ beside those of the heathen deities.

Images of Christ, claimed by the Romanists to be of miraculous origin, are preserved in several churches in Italy and the Orient. Most of them are really of Byzantine origin, and probably dated from between the tenth and twelfth centuries. The power of working miracles is ascribed to these images! One of the most noted of them is the *Veronica* (the picture known as the *Ecce Homo*), on a linen cloth which a woman named Veronica is held by tradition to have given to Christ while bearing his cross to Calvary to wipe his brow. See *VERONICA*. On the cloth is the face of the Saviour, with an expression of great grief, and the brow pierced by the crown of thorns. Another is that which is said to have appeared miraculously when St. Sylvester was consecrating the basilica of St. John Lateran, and which was formerly preserved above the tribune of that church. Another is the *Abgarus* picture, a portrait without colors, which a baseless tradition (of the tenth century) has it that Christ sent to king Abgarus of Edessa, when that king wished Christ

to come and heal him of a sickness, and the original of which picture two churches—the church of St. Sylvester in Prata, near Rome, and a church at Genoa—profess to have. See *ABGARUS*. Another is preserved in the sacristy of the basilica of St. Lawrence, near Rome. There are also several wooden images of the infant Saviour said to have been carved and painted by St. Luke, or by angels!

Paintings or sculptures of the crucifixion [see *CRUCIFIX*] are usually placed over the altar in Romish, Greek, Armenian, and Lutheran churches. In some Protestant churches, other than the Lutheran, the figure of the Saviour is often introduced in paintings of the parables, the miracles, and other Biblical subjects, rendered in a Protestant sense. See Piper, *Mythologie und Symbolik der christlichen Kunst* (Weimar, 1847); Martigny, *Dictionnaire des Antiquités Chrétiennes* (Par. 1865); Roest, *Roma Sotterranea* (Rome, 1866); also the works of Aringhi, Bottari, Perret, etc., on the Catacombs; Glückselig, *Christus-Archæologie* (1868, 4to; reproduces the so-called Edessa picture in colors, and gives six other portraits); Marangoni, *Istoria della Cappella di S. S. di Roma* (Rome, 1747); Mrs. Jamieson, *History of our Lord in Art* (London, 1864, 2 vols. 8vo); Lecky, *History of Rationalism*, i, 221-257; Didron, *Christian Iconography* (Bohn's ed.), i, 242-298; Lewis, *Bible, Miscel, and Breviary* (Edinb. 1858, 2 vols. 8vo), i, 188 sq.; Schaff, *Church History*, iii, 110. See *CATACOMBS*; *IMAGE-WORSHIP*.

CHRIST, LIFE OF. See *JESUS*.

CHRIST, MONOGRAM OF.—In the Catacombs and elsewhere is to be found a monogram in the forms XP , P , XP , P , composed of the Greek letters X and P, the initial letters of the name $\text{X}\rho\iota\sigma\tau\acute{o}\varsigma$, Christ. Sometimes the Greek letters α , ω (Alpha and Omega, the first and the last) are combined with the others, in the form $\alpha\text{X}\omega$, or suspended by chains from the transverse bar, thus P .

The precise date of its origin is unknown; but Killen (*Ancient Church*, p. 817, note) asserts that it is found on coins of the Ptolemies, and cites Aringhi (*Roma Subterranea*, ii, 567) as his authority. But, whatever the origin of the monogram, it came into new prominence and wider use from the fact that Constantine (A. D. 312) applied it to the heathen military standard. See *LABARUM*. It is called, therefore, not only the monogram of Christ, but sometimes also the monogram of Constantine.—Schaff, *Ch. History*, ii, 27; Jamieson, *History of our Lord in Art*, ii, 815; Martigny, *Dict. des Antiquités*, p. 414; Perret, *Les Catacombes de Rome*, iii, 96. See *CATACOMBS*.

CHRIST, OFFICES OF (as *Prophet, Priest, and King*).

I. *Origin and History of this Division.*—Eusebius, in his *Church History* (i, 8), and also in his *Demonstratio Evangelica* (iv, 15), is the first who appears to have considered the mediatorial work of Christ as consisting in the three offices. The division became common in the Greek Church, and it is still usual in the Russian Church. In the Latin Church it has not passed so generally into use, although Bellarmin and many others allow it. Luther, Melancthon, and the other early Lutheran theologians do not use the distinction. It was introduced into Lutheran theology by Gerhard (q. v.) in his *Loci Theologici*, was admitted by Spener into his *Catechism*, and remained prevalent among Lutheran theologians until the time of Ernesti, who wrote against it under the title *De officio Christi triplici*, and was followed by Zacharias, Doederlein, Knapp, and others (see Knapp, *Theology*, § 107). In the Reformed Church it was adopted by Calvin (*Inst.* ii, 15), was admitted into the Heidelberg Catechism, and was generally followed by the dogmatic writers of the Reformed churches, both on the Continent and in England. The modern theology of Germany (as the works of De Wette, Schleiermacher, Tho-

luck, Nitzsch, Liebner, Ebrard, etc.) generally adhere to it, regarding it as an *essential*, and not merely accidental and formal division of the mediatorial work, as the only one which exhausts it. It is used by a majority of the best English theologians. We give here a modification of Ebrard's article on the topic in Herzog's *Real-Encyclopädie*, vi, 607 sq.

11. *Biblical View.*—The prophecies of the O. T. designate the Redeemer as the perfect and model prophet, as the servant of God to whom the attributes of prophecy, priesthood, and royalty alike belong; as the kingly seed of David, or the second, perfect David; and finally as the *priest-king*. He, moreover, in spirit, calls himself, in the Gospels, "prophet," and "son of David." In the Epistle to the Hebrews he is represented as the only true and eternal high-priest. This threefold aspect of his mission is united in the conception of the *Anointed or Messiah*; for as Elisha was by Elijah anointed a prophet (1 Kings xix, 16), so was the promised "servant of God" to be anointed by the Spirit of the Lord; and as the *kings of Israel* were anointed (1 Sam. x, 1; xvi, 13; 1 Kings i, 13; xix, 15, etc.), so was Christ anointed king of righteousness (Heb. i, 8, 9). And as it was ordained by the law that the *high-priest* should be anointed to his office (Exod. xxviii, 41; xxix, 7; xxx, 30; Lev. iv, 3; vi, 22; vii, 36), so Christ was made high-priest "not after the law of a carnal commandment, but after the power of an endless life" (Heb. vii, 16). The conception of the Messiah or Anointed thus divides itself into the three aspects of prophet, priest, and king.

The first prophecy bearing on the subject is in Deut. xviii, 15. The people, afraid of hearing the commandments of God, sent up Moses to hear them (Exod. xx, 19; Deut. v, 27). The Lord "heard" the people (Deut. v, 28), and promised (as they had sent up Moses to hear Him) that He would send them a prophet whom they could and should hear. The God who revealed his law in the midst of thunder and lightning, so that the people durst not approach him, would afterwards approach the people through a prophet. On Mount Sinai the people had to send Moses up to God, and God promised, in the future, to send down a prophet to the people. Thus the difference between the Law and the Gospel is sketched in its dawning outline.

The latter part of Isaiah (chapters xl-lxvi) is related, though not in the most direct way, to the prophecy in Deuteronomy. In Isaiah, not "the prophet," but the "servant of God," is the predominant conception. Isaiah "labors in vain" (xlix, 4); a coming servant of God, however, will accomplish both Isaiah's task in Israel and the mission of the people of Israel to the Gentiles together and perfectly (xlix, 6); and this because he is *more* than a prophet; because he takes upon himself the penalty of our sins (liii, v)—מִפְּנֵי חַטֹּאתֵינוּ, "the chastisement of our peace," i. e. the punishment whose fulfillment secures our exemption. He brings a *sin-offering*, דָּם־זֶבַח (ver. 10). The prophecy does not merely indicate that the prophet's mission should entail death on the servant of God, as was the case with Paul (Col. i, 24; 2 Tim. i, 11), but that he should die as an expiatory sacrifice. And in chap. xlix, 7, he appears as "King of kings," for "kings and princes" are to bow down before him.

Thus we find in Deut. v, 18 a promise of the "prophet," and in Isaiah xlix-lxvi a promise of "a servant of God," of whom prophetic preaching, priestly self-offering, and crowning with kingly power are predicated. But regal dominion is not merely assigned to the future Redeemer as the predicate, or as the issue of his destiny, but, on the contrary, the very root of the Messianic prophecies lies in the promise of "one of the seed of David," whose "throne should endure forever." Redemption from future servitude was promised to the seed of Abraham (Gen. xv). Through Moses, Joshua, and David, this promise, in its outward and

material sense, was gradually fulfilled. It was for this reason that David determined to build a temple to the Lord, that the "Eternal might dwell with his people." But such a union of God, "who is a spirit," with a material place and edifice, did not agree with the divine plan of salvation (compare John iv, 23, 24). Israel was to acknowledge that the temporal redemption, obtained through David, was not yet the true redemption, but a mere faint foreshadowing thereof. This was indicated by the prophecy in the seventh chapter of 2 Samuel, in which it was shown that not David himself, but David's seed after his death, was to build the Lord a house, and that the Lord would assure the throne of his kingdom forever. Even here no mention is made of an *individual*, but merely of a successor of David (chap. vii, 12-15). David at the same time understood that his sinful race was not fit to build the Lord a temple, and to rule on his eternal throne, as he said, "Thou hast spoken also of thy servant's house for a great while to come. And is this the manner of man, O Lord God? (2 Sam. vii, 19; comp. 1 Chron. xvii, 17). The allusion in Psa. ii, 6, 7, to this prediction is unmistakable, and Psa. cx is a poetic explanation of the passage 2 Sam. vii, 19. So Christ himself (Matt. xxii, 42) explains it.

Solomon also was aware that the prediction of Nathan would not have its final fulfilment in his material temple (1 Kings viii, 26-27). After the death of Solomon, prophecy pointed more and more directly towards a certain, particular, future descendant of David, entirely distinct from his then existing posterity (comp. Isaiah vii, 14; ix, 6, with x, 21). From the chastised house of David, the fallen trunk, a fresh branch was to spring (Isaiah xi, 1), and to rule over the nations through a reign of peace and righteousness. Yet that he was not to be an ordinary earthly king, nor a Levitical priest, but a king-priest according to the order of Melchizedek, had already been shown in Psa. cx, 4, and is more fully developed in Zech. vi, 12, 13, with distinct reference to 2 Sam. vii, Psa. cx, and Isaiah xi.

2. *The Manifestation in N. T.*—The carnal Israel awaited a worldly, earthly Messiah, who should establish a worldly kingdom. "The Prophet" (ὁ προφήτης, John vi, 14) appeared to them to be distinct from the Messiah, a sort of precursor of the latter (comp. Mark viii, 27, and John i, 21); but the faithful, enlightened by the spirit of God, thought otherwise. To them had Jesus already been announced by John the Baptist (Matt. iii, 8; comp. with xii, 18, Luke iii, 4) as the "servant of God" promised by Isaiah, in whom the prophetic, priestly, and kingly offices should be united; and the Lord himself appears in these three aspects in his life, his passion, and his death.

When he goes about teaching that the "kingdom of God" has come, and confirming his words by miracles, he does a prophet's work, and therefore the people themselves recognise him as the "prophet" (Luke vii, 16; ix, 8; John ix, 19; vii, 40). But he not only spoke as a prophet, but he *was* and *is* The Prophet, the revealer of the Father in the absolute sense. The key to this perception is given us in the passage Heb. i, 1: "God, who at sundry times and in divers manners spake in times past unto the fathers by the prophets, hath in these last days spoken unto us by his Son," etc., i. e. he has manifested the fullness of his essence and of his will in a personal revelation in Him who from all eternity has been the one God and consubstantial with the Father. Therefore he is in John i, 1, called the *Word*, in whom God ἐν ἀρχῇ expressed his essence to himself (πρὸς τὸν Θεόν), "by whom all things were made; without whom was not any thing made that was made; in whom was life; and the life was the light of men." Christ, as the Word become man, is then no longer a prophet merely in word and action, but is one in his very essence. His whole being and essence is the revelation of the Father (John xiv, 9).

The Epistle to the Hebrews represents Christ as a priest, nay, even as the *eternal high-priest* (Heb. vii). He is the eternal high-priest because of his having offered the only eternally valid sacrifice, the final sacrifice which renders all others henceforth superfluous—*himself*. His being in other parts of the Scriptures considered more as the *hostia* (victim) than as the priest, is merely a formal, not a material difference. Christ, on the one hand, absolutely satisfied the demands of God's law upon man (namely, to be sinless, holy, and filled with the love of God), and thus rendered the *obediencia activa* which we do not render; and, on the other hand, he assumed the penalty which the law inflicted on the sinner, "Thou shalt die the death," on himself; he who owed nothing suffering for those who are debtors. See ATONEMENT; OBE-DIENCE. He thus, by substitution, took upon himself our debt and its penalty, and became an expiatory offering for us. For the fundamental principle of all offerings for sin under the old dispensation was this very substitution of one to suffer death for another; who could have been the mediating priest between Christ and the Father? He himself, the sinless, holy, the *λόγος—προφήτης*, who had ever been with the Father, was the priest who, in eternal high-priestly purity, gave himself as an offering. His actions and his sufferings cannot be divided. He did not make an offering of himself suddenly, *ex abrupto*, with no connection with his previous life. On the contrary, his priestly, holy life brought him to his death. Thus was his offering a priestly one.

From the death of Christ the crown of thorns is inseparable. So from the crown of thorns the crown of kingly dignity and power is inseparable. When, in the days of his humiliation, he was recognised and proclaimed as the promised "Son of David," the expected "Messiah-king," he accepted the title (Matt. ix, 27; xviii, 30; xv, 22; xii, 28; xxi, 9). But the fulfilment of his kingly mission took place in a manner entirely opposite to that which the people had expected. His kingly mission culminated at the very moment when he declared unto Pilate that he was king, and thereupon received the crown of thorns (John xviii, 37, and xix, 2, comp. with verses 12-15 and verse 21). Here the kingly office became closely connected with the priestly. As a reward for this royal abnegation he was crowned with the crown of glory (Heb. ii, 9; Phil. ii, 9, 10), became head of the Church (Ephes. i, 22), and Lord over all (Ephes. i, 21). And all who come to him by faith are given to him as his own (John xvii, 6), and he claims for them a share in his glory (verses 22, 24, 26). The Christian Church is thus fully justified in considering the prayer in John xvii as a true high-priestly prayer of the priestly king and kingly priest (Psa. cx, 4) for his people, and not merely as the intercession of a *prophet* for his disciples.

Finally, redemption by Christ is best understood under this threefold aspect of his entire work. He who in his own person was the revelation of God, the *λόγος* of God to man, has by word and action, and by his advent, revealed to man, in his state of error, ignorance, and sin, the law of God to man, and the mercy of God to the sinner. He who in his own person was the son of man, clothed with priestly holiness, and making of himself a pure offering unto God, has, as a member of a race which is subject to the consequences of sin, preserved his holiness under circumstances which caused the curse of human sin to fall on the head of him, the sinless, and has thereby submitted himself to the judgment of God in our stead, i. e. has given himself as an expiatory offering. He who in his own person was the kingly chief of mankind, has, in order as priest to sacrifice himself, foregone this kingly power and worn the crown of thorns, but thereby has attained the crown of glory, the dominion over the Church he has redeemed, in which and for which he now reigns over heaven and earth.

We find, in all the N. T. account, that in Christ's teachings he was not exclusively a prophet, in his passion he was not exclusively a high-priest, nor was he a king only after his resurrection. On the contrary, the three offices cannot be thus mechanically set off from each other. The Scripture certainly ascribes to Christ a *munus propheticum immediatum* (direct prophetic office) only during his visible life in the state of humiliation (viz. a *propheta persona*, by which his whole being was in itself a revelation of God, and a *propheta officii*, in words and doctrines). But it teaches also that, as Prophet and Revealer, the exalted Christ continues to operate (*munus propheticum mediatum*, mediate prophetic office) by his Word, which he gave once for all, as well as by his Spirit, through which he continues to enlighten the hearts of believers. In the *munus sacerdotale* (priestly office) we distinguish (scripturally) the once-offered oblation from the yet continuing intercession; and in the former, the *obediencia* and *satisfactio activa*, the offering of a holy life, from the *obediencia* and *satisfactio passiva*, the assumption of the undeserved expiatory suffering. Finally, the Scripture teaches that Christ, in his state of humiliation, was already king (*rex fuit*, or *rex natus erat*), as in John xviii, 37. He disclaims only the "exercise" of kingly power, not the fact. We distinguish also the inherent regal glory and power of Christ from his exercise of them—the *dignitas regia* from the *officium*—and in the latter also we distinguish the *regnum gratie*, the governing of his people by his spirit, from the *regnum gloriae*, the dominion over all. There is, in fact, no concrete point in the existence and activity of Christ, whether in the state of humiliation or of glorification, in which the three offices are not found constantly connected. Thus Christ remains in all respects, inseparably, the Revealer of the Father to man, the Intercessor for man with God, and the Chief and King of his people. See Knapp, *Christian Theology*, § 107; Nitzsch, *System der christlichen Lehre*, § 132; Herzog, *Real-Encyclopädie*, vi, 607; Pye Smith, *First Lines of Christian Theology*, bk. v, ch. iv, § 2.

CHRIST, PERSON OF. See CHRISTOLOGY.

CHRIST, RESURRECTION OF. See RESURRECTION.

CHRIST, SINLESSNESS OF. The Christian Church has always held that Christ was absolutely free from sin. (This article is based upon Weiss, in Herzog's *Real-Encyclopädie* [Supplement, i, 193 sq.], and Ullmann, *Sinlessness of Jesus* [Edinburgh trans. 1858].)

I. *Historical*.—1. To the minds of the apostles the perfect sinlessness of their divine Master presented itself as an unquestionable fact, and this view continued to prevail, through the period immediately succeeding, in the development of the Church's doctrine of the person and work of Christ. No explicit statement of it seems to have been made or deemed necessary, but the allusions in the early ecclesiastical writers show that the doctrine was neither rejected as unfounded nor ignored as unimportant. Tertullian inferred the sinlessness of Christ from his divinity; Origen regarded it as a peculiar property of the human soul of Christ, resulting from its union with the divine Logos, by whose virtue it was interpenetrated as red-hot iron is by fire, so that sin became for him an impossibility. Apollinaris, setting out with the belief that human nature implies limitation, mutability, conflict, sin, etc., held that no man can be a perfect man without sin; and in order to preserve, consistently with this view, the sinlessness of Christ, sacrificed his true humanity by adopting the opinion that the Logos took the place of the human soul in Christ, and imparted to him an irresistible tendency to the good. Athanasius held the doctrine of a sinless yet perfectly human nature in Christ, arguing that sin does not belong to human nature *per se*, which was originally pure and sinless;

and that Christ could, consequently, assume the nature of man without thereby being made subject to sin, and thus, by his perfect life as a man, become man's exemplar and guide in his conflict with evil and progress towards the good.

2. At the Council of Chalcedon (A.D. 451) the doctrine of Christ's true yet sinless manhood was formulated in the words, "truly man, with a rational soul and body of like essence with us as to his manhood, and in all things like us, sin excepted;" and there has not since been any change within the accepted Christological doctrine of the Church. The theologians of the Middle Ages contented themselves with the traditional doctrine, without any special efforts for its further development; though in the controversies with regard to the Immaculate Conception of the Virgin Mary, her champions sought to add weight to their arguments by claiming that the acceptance of their views would recognise also the sinlessness of Christ. A doctrinal error of a different sort hence arose, viz. the putting Christ in the background as too holy for mortals to address, and substituting the mediation of the Virgin and the priesthood.

3. One of the chief merits of the Reformers is the fact that they taught that Christ is individually and immediately apprehended by faith, and that the Holy Scriptures, not the dogmatic and liturgical traditions of the Church, are the sources whence Christian truth is derived. They accepted the doctrine of the Roman Catholic Church concerning the person and character of Christ, of which his sinlessness formed an essential part. It was received, as in the apostolical times, as an intuition not needing proof, but "above mere logical demonstration."

4. Socinianism might have been expected to open up a new and fruitful discussion of this subject, yet, apparently in antagonism with its views of the person and office of Christ, it asserted not only the sinlessness of Jesus as a fact, but also the *non posse peccare*, and indeed denied that he was really subject to temptation, because of his supernatural generation.

5. From the rise of German Rationalism, about the middle of the 18th century, this doctrine has been repeatedly impugned by writers of that school. Some (as Reimarus, Bahrtdt, Venturini) even go so far as to characterize Christ as an impostor. So also, among English Rationalists, Newman, *Phases of Faith*, finds imperfections in the moral character of Christ. Strauss denied Christ's sinlessness on the ground principally of its *a priori* impossibility, or of the necessary connection of sin with finite existence. Pécaut, a recent French writer, adduces as proofs of Christ's moral imperfections (*Le Christ et la conscience*, Paris, 1859), his treatment of his mother (Luke ii, 41-52; John ii, 4); the expulsion of the profaners of the Temple (Matt. xxi, 12-17, et al.); the cursing of the fig-tree (Matt. xxi, 17-22; Mark xi, 12-26); the destruction of the swine (Matt. viii, 28-34, et al.); his severe reproofs of the Pharisees (Matt. v, 20, et al.); and also his supposed abnegation of the title good (Matt. xix, 17, et al.); but, in strange contradiction of his own views, he uses such language as this: "To what a height does the character of Jesus Christ rise above the most sublime and yet ever imperfect types of antiquity. . . . Jesus Christ has been humble and patient; holy, holy, holy before God; terrible to devils; without any sin. . . . His moral life is wholly penetrated by God" (Schaff, *Person of Christ, the Miracles of History*, p. 208, 209, 846-848). Other Rationalistic writers (as Kant, Jacobi, and others) have labored to place in clear light the unparalleled moral excellence of Christ, as the abiding type and proof of the divinity of his teachings. The denial of this doctrine, whether open or covert, mostly arises from shallow moral and religious conceptions, or from lowering the fundamental moral nature of sin, justification, etc., into mere relations.

5. On the other hand, Ullmann has laid the Church

under lasting obligations by his monograph, *Die Sündlosigkeit Jesu* (last ed. 1868, Götting), transl. by Brewa, *The Sinlessness of Jesus* (Edinb. 1868, 12mo). Dörner, Schaff, and Weiss have still further contributed to its elucidation (see references at end of this article). The subject has been more or less fully treated: in opposition to Rationalism by Hase (*Streitschriften*, iii, 1837; *Loben Jesu, and Dogmatik*); Schweitzer, in *Studien und Kritiken*, 1834, iii and iv; 1837, iii); in connection with historic-critical examination of the person of Christ, by Keim (*der geschichtliche Christus*, p. 43, 106-116); from the stand-point of the doctrine of Christian morals and Church history, by De Wette (*Christliche Sittenlehre*, vol. i, § 50-58), Weiss (Evangelische Geschichte), Ewald (*Geschichte Christus*, p. 184 f.), Schenkel (*Dogmatik*, and very waveringly in his *Characterbild Jesu*, p. 85 and 89), Weissäcker (*Evangelische Geschichte*, p. 487); from the stand-point of Church confessions, by Thomasius, Hofman, Philippi, and Ebrard; from a purely biblical point of view, by Schmid, Beck, Gess, Garbett (*Christ as Prophet, Priest, and King* [Lond. 1842, 2 vols. 8vo]), Stevenson (*On the Offices of Christ* [Lond. 1884, 8vo]), and Riggenbach; from that of the mediation theology of Schleiermacher, in treatises on the life of Christ, by Neander and others, and in works on dogmatics and the history of dogmas by Rothe, Liehner, Dörner, Nitzsch, J. Müller, Lange, Martensen, Schöberlein, and others.

II. *Statement of the Doctrine.*—The term sinlessness, *ἀναπαρρησία*, involves a twofold idea, first, a negative one, viz., "the absence of antagonism to the moral law and to the divine will, of which that law is the expression; and this not only in relation to separate acts of will and outward actions, but also in relation to the tendency of the whole moral nature, and to its most deep-seated disposition" (Ullmann, *Sinlessness of Jesus*, p. 41), which may be expressed by the term innocence, goodness of nature, etc.; and, secondly, a positive one, viz., the expression in outward form of this inward harmony by a life of complete and perfectly holy activity, working out in full obedience to the will of God the duties of each hour, while keeping both spirit and life unstained by evil. This we term absolute holiness.

We hold, then, that our Saviour, in his humanity, was, in both these senses, sinless; at first relatively, just as Adam before his fall, with a perfectly human nature to which the liability to temptation must be conceded; otherwise no true manhood could have existed, no true example for our race could have been presented in his life. The doctrine of Edward Irving, however, that Christ partook of the sinful nature of Adam after the fall, cannot be allowed. It is not necessary at all to the true conception of his perfect example as a man for sinful men; which, on the contrary, implies that the second Adam should not be placed in his human nature below the original condition of the first, and thus burdened with the sin and weakness of sullied manhood. This view would demand of his divine nature so miraculous a support of the human as to destroy the force of his example. On the contrary, Christ, in his humanity, clothed with man's original purity of nature, lived, suffered, "was tempted in all points like as we are, yet without sin," and so could "justify the ways of God to man," and show that man was made "sufficient to have stood, though free to fall." His relative sinlessness became absolute holiness in the development of his moral life, in his free, yet perfect, active, and passive obedience to the will of his Father. To use the terms of the schoolmen, the *non posse peccare* or *impeccabilitas minor*, in him, grew, through vanquished opposition and the achieved results of perfect obedience in love, into the *non posse peccare* or *impeccabilitas major*, "into the impossibility of sinning, which cannot sin because it will not" (Schaff).

III. *Proofs of the Doctrine.*—1. *A priori.* We may

argue, *a priori*, that as Christ's acknowledged mission on earth was the moral elevation and the salvation of our race from sin, it was fitting, nay, necessary, in order to accomplish these objects, that he should be superior to us in these respects. To raise man from his ruin, the Prince of his salvation must be one "who is holy, harmless, undefiled, separate from sinners, and made higher than the heavens," while his heart, "touched by the feeling of our infirmities," would yearn for the renewal of humanity. How fully Christ's perfect life meets this ideal every Christian feels; and with what deep and grateful confidence does he, when oppressed by the temptations and conflicts of his probation, turn to him who "needeth not daily to offer up sacrifices first for his own sins," and "then for the sins of the people," as did other priests.

2. *A posteriori*, we find that Christianity has exerted and does exert a power for moral good upon the world. Wherever it has taken hold of the hearts and minds of men in its purifying power, we see that they have attained a higher moral and religious state, a condition of life far beyond the pagan or even the Jewish types. How shall we account for this, apart from the life of the founder of Christianity, imparting its renewing power to the hearts of his followers? Mere theories of moral conduct without example are not capable of producing such results. Streams do not rise above the level of their sources; no more do followers of religious systems rise above the laws and principles of religious life prescribed in the conduct as well as teachings of their founders. We may justly claim that the higher moral condition of Christian nations is due mainly to the influence proceeding from the spotless life of Christ.

Many of the early as well as recent opponents of Christianity as a system bear testimony to the surpassing moral greatness of its founder. Pilate declared that he found no fault in him touching the things whereof the Jews accused him, and thrice asked the question, "What evil hath he done?" (Luke xxiii, 22). The Roman centurion, who witnessed his sufferings on the cross, said, "Certainly this was a righteous man." Josephus, if the passage be authentic (*Antiq.* bk. xviii, ch. iii, § iii), says of him that he "was a teacher of such men as receive the truth with pleasure." Porphyry (A.D. 304) says, "But himself is pious, and gone to heaven as other pious men do. Him therefore thou shalt not blaspheme." The celebrated tribute of Rousseau to the Gospel and its author need not be quoted here. A fuller view of the testimony of unbelievers to the person and character of Christ is given in the work of Schaff referred to above.

3. *Biblical View of the Doctrine.*—The doctrine of the Old-Testament writers in regard to the original purity and grandeur of man's moral and intellectual nature is shown conclusively by the language employed in describing his creation and endowments: that he was made in the image of God; that the dominion over the earth and lower animals was given to him, etc. When man by disobedience fell, the promise was given of one to come, who should repair, by his obedience and perfectness, the ruin made, and through whom man might be reconciled to God. The coming of such a Redeemer was prefigured in the worship and sacrifices of patriarchal times, in the separation and Temple services of the Jewish nation, and in those holy men who from time to time appeared as lights amidst the darkness of the world. Throughout all these preparatory manifestations the idea of the sinlessness of the coming Messiah appears. In the spotless victims, in the purifying services, in the strains of the poets of Israel, and in the magnificent imagery and language of the prophets are found, more or less complete, the elements whose union culminates in the idea of the sinless Son of God and Redeemer of men (Isa. ix, xl, xlii; Jer. xxxi, 31 sq.; Ezek. xxxvi, 8 sq., etc.).

The New-Testament writings bear unequivocal and

harmonious testimony to the truth of this doctrine. Christ is described in them as the Holy One, the Just and Righteous (Acts iii, 14; xxii, 14; 1 Pet. iii, 18; 1 John ii, 1, 29; iii, 7); as tempted "like as we are, yet without sin" (Heb. iv, 15); as our example "who did no sin, neither was guile found in his mouth" (1 Pet. xi, 21, 22); as "a lamb without blemish and without spot" (1 Pet. i, 19); as "an high-priest who is holy, harmless, undefiled" . . . "who needeth not daily to offer sacrifices" "for his own sins," as did other priests (Heb. vii, 26, 27); as the Mediator "who knew no sin" (2 Cor. v, 21). These writings, indeed, are full of proofs that his apostles and followers recognised in Christ, because of his holiness, as well as his wonder-working power, the Messiah foretold by prophecy, coming in the fulness of the divine spirit to be the founder, lawgiver, and king of the kingdom of God on earth.

Christ no less unequivocally claims for himself such perfection of nature and life, in the assumption of oneness with God (John x, 30), in the fact that he nowhere prays for forgiveness of his own sins, or recognises that sin exists in himself, and, specifically, in the expression "which of you convinceth me of sin" (John viii, 46).

IV. *Objections.*—But brief notice can be taken here of the objections to this doctrine, which are grouped by Ullmann (p. 148) under two classes, viz. (1) those resting "on a denial of the actual sinlessness of Jesus," and (2) those resting "on a denial of the possibility of sinlessness at all in the sphere of human life; and by Weiss (*l. c.*) under three heads, viz. (1) that unique individuality (*Einsigkeit des Individuums*) contradicts both the nature of the individual and the idea of the human race and its development; (2) that sinlessness is irreconcilable with the nature of man; and (3) that the same is irreconcilable with the actual sinful condition of mankind. The former classification seems the simpler one, and we prefer to follow it. In regard to the objections of Pécaut, which belong to the first class, it may suffice to say that all of them except the last are founded on incorrect conceptions of the spirit and purpose of Christ in the several actions noticed, and of the duty which his office as Messiah imposed on him. Viewed in the proper light, no disobedience of or disrespect to his parents, no outburst of angry passion, no wanton destruction of the property and disregard of the rights or feelings of others can be found. Attention to the scope and import of the question of Christ to the young man, "Why callest thou me Good?" (*τί με λικύεις ἀγαθός*), will show that he does not reject the title good, but seeks to lead the questioner to its true application; the emphasis, as the order of the words shows, rests not on the expression good, but the *why*. "God only is good; but he that hath seen me hath seen the Father."

In reply to the objection that the idea of sinlessness is inconsistent with the growth in wisdom and the development of his moral nature which the Gospel portraiture of Christ assigns to him, we may say that growth and development do not necessarily or commonly imply imperfection. A human being, possessing in infancy and boyhood the maturity and complete development of manhood and age, would be a monstrosity. We expect from infancy, youth, manhood, and age what befits each period, and regard as irregular and imperfect what is contrary thereto. Again, finite nature is not necessarily imperfect. The perfect action of such a nature in conformity with the laws and limitations of its being cannot be sinful, or evidence of imperfection as finite existence, but just the contrary.

The notion that individual pre-eminence is inconsistent with the nature of the individual or the nature of the race is not warranted by the actual past and present history of man. We see that through all periods of time individual men stand out prominently en-

dowed above their fellows. Is it then irrational to suppose that in view of the great work which Christ came to do, he would be superior in purity to those whom he sought to elevate?

In all the relations of his life on earth, Jesus always did what was due to them. He did not seek, in virtue of the connection of his humanity in one personality with his divinity, to exempt his human nature from the influences which legitimately operate on it; but meeting fully life's duties as they came to him, he asserted in himself the triumph of one unfallen nature over the power of evil in the world. Thus his perfect holiness of life stands out clearly in the moral heavens, the unchanging, ever-brilliant star of hope whose light no cloud can ever dim, a safe and surely-guiding beacon to those who traverse the sea of life in search for the Promised Land.

Literature.—Ullmann, *The Sinlessness of Jesus* (Edinb. 1858, 8vo); Schaff, *The Person of Christ* (Boston, Am. Tract. Society, 16mo); Martensen, *Christian Dogmatics* (Edinb. 1866, 8vo); Knapp, *Christian Theology*, p. 336, 7 (Phila. 1853, 8vo); Weiss, in Herzog's *Real-Encyclopædie* (Suppl. i, 193 sq.); Dörner, *De la Sanctité parfaite de J. C.* (in *Suppl. à Revue Chrétienne*, Nov. 1861); Dörner, *Person of Christ* (passim); Niemann, *Jesus Sündenlosigkeit* (Hanover, 1866).

Christ, Order of, KNIGHTS OF THE. After the abolition of the order of Knights Templars, in 1812, king Dionysius of Portugal left to such as resided in his dominions a large share of their estates, and in 1817 reconstituted them into a new spiritual order of "Knights of Christ." It was sanctioned by Pope



Badge of the Portuguese Order of Christ.



Star of the Portuguese Order of Christ.

Encyclopædia, s. v.

Christ, Work of. See ATONEMENT; CHRIST, OFFICES OF; CHRISTOLOGY; REDEMPTION.

Christendom, the kingdom of Christ in its diffusion among men on the earth. In the way of territorial extension, Christendom has been enlarging almost without interruption from the beginning. In the second and third centuries congregations were established in all parts of the Roman empire, and beyond the limits of the empire it collected churches in Parthia, Persia, and India, and extended to several barbarous nations whose languages had never been reduced to writing. The conversion of Constantine established the first Christian state. By A.D. 423 the whole

eastern portion of the Roman empire was free from paganism, which lingered a little longer in the western, without, however, disputing any longer the ascendancy. In the fifth and sixth centuries Christianity conquered in great part Northern Africa, Spain, Gaul, Scotland, England, and a number of the German tribes. The erection of the empire of Charlemagne paved the way for the conversion of Northern Europe. The Saxons consented to accept Christianity in 864 and Scandinavia in the tenth and eleventh centuries. Thence it spread soon to Iceland and Greenland. The conversion of the Slavonians of Eastern Europe commenced in the ninth century, and was nearly completed in the twelfth. In the tenth and eleventh centuries the dissemination of Christianity in Hungary, Transylvania, and Russia commenced. At the same time its territory was lessened in Western Asia, Northern Africa, and a part of Southern Europe, by the progress of Mohammedanism. In the period from the eleventh to the sixteenth century the conversion of Northern Europe, and in particular of Pomerania, Estonia, and Livonia, was completed. A part of Eastern Europe, however, was gained by the Mohammedans, but on the other hand, a large new territory was secured to Christianity in Western Africa, East India, and America, in connection with the discoveries of the Portuguese and Spaniards. After the sixteenth century the newly-discovered continent of America began to be filled up by a Christian population, thus making the second Christian continent. The Roman Church for some time seemed successful in Christianizing Eastern Asia, especially China and Japan, but its progress was stopped by persecution. In the eighteenth century a new Christian state sprang up in South Africa, in connection with the political rule of the Dutch and the English. The nineteenth century opened with brighter prospects than any preceding. In South Africa the territory of Christian nations extended; in Western Africa, Liberia was founded as a Christian republic; in Northern Africa, Algeria is filling up with a Christian population; and in Eastern Africa, Abyssinia, which, in spite of its isolation, has preserved since the fourth century a kind of Christianity, promises to re-enter the union of the Christian states. Australia has already become the third Christian division of the world, with only a few weak remnants of paganism. In Asia the Karens of Farther India have been brought under the influence of Christianity, while in the north nearly one third of the continent forms part of a Christian state. Thus the territory of Christianity at present comprises three out of the five large divisions of the world, with a considerable part of the two others. Moreover, large territories in Asia and Africa, though not yet Christianized, are under the dominion of Christian nations, and hardly a single country is at present left into which Christian missionaries have not forced their way. Thus the time seems near when the extent of Christendom will coincide with the extent of the earth. The following estimate of the Christian population of the world is based upon the latest (1868) works on political and ecclesiastical statistics:

	Total Population.	Roman Catholic.	Protestant.	Christians.
America....	73,800,000	42,700,000	27,500,000	70,200,000
Europe.....	287,000,000	140,200,000	67,300,000	274,200,000
Asia.....	798,600,000	4,800,000	700,000	12,900,000
Africa.....	188,000,000	1,100,000	700,000	4,900,000
Australasia, & Polynesia..	8,800,000	400,000	1,000,000	1,400,000
	1,850,200,000	189,000,000	97,100,000	363,600,000

See also Smith, *Tables of Church History*. Compare CHRISTIANITY.

Christ-emporion (χριστοεμποριον), *selling of Christ*. See SIMONY.

Christening, a name given to the act of baptism, (1) as if thereby the child were made a Christian; or

), as baptism fixes the *Christian* or *Christened* name of the child.

Christian (*Χριστιανός*), the name given to those who believe Jesus to be the Messiah (Acts xi, 26). Commentators and critics are not agreed whether the followers of Christ gave this appellation to themselves, or whether it was bestowed on them by others. Neither view appears to be wholly true or wholly false. Such titles do not usually originate in any arbitrary way, nor do they spring from a single party, but rather arise from a conventional assent to their appropriateness. It was, indeed, the interest of the Christians to have some name which might not, like the Jewish ones (Nazarenes or Galileans), imply reproach. And though the terms *brethren*, *the faithful*, *elect*, *saints*, *believers*, *disciples*, or *the Church*, might suffice among themselves, yet none of them were sufficiently definite or an appellation, and might perhaps be thought to savor of vanity. They would therefore be not disinclined to adopt one, especially for exoteric use. Yet the necessity was not so great as to stimulate them to do this *very soon*; whereas the people at large, in having to speak of this new sect, would soon need some distinctive appellation; and what so distinctive as one formed from the name of its founder? It is therefore most likely to have been suggested by the Gentile inhabitants of Antioch, and to have early come into general use by a sort of common consent. (See Conybeare and Howson's *Life and Epistles of St. Paul*, i, 119.)

There is no reason to think with some that the name "Christians" was given in absolute derision. When used by Agrippa (Acts xxvi, 28), there is no proof that it was a term of reproach; had he intended derision, he might have employed the term Nazarene, which was in frequent use among the Jews, and has continued current in the East, wherever the Arabic language is spoken, to the present day. The early adoption of it by the Christians themselves, and the manner in which they employ it, are sufficient to dispel all idea of this nature (1 Pet. iv, 16). The only reproach connected with the name would be the inevitable one arising from the profession of faith implied in it. Neither is the view of others more probable, that it was a name imposed by divine appointment. The term *χρηματίζω* (translated "called" in the passage first quoted), usually relied upon to sustain this view, has other significations than that of an oracular response, and is fairly capable of the meaning assigned to it in our version.

"This world-famous name (William of Tyre, iv, 9) occurs but three times in the New Testament (Acts xi, 26; xxvi, 28; 1 Pet. iv, 16). In the first of these passages we are informed that it arose in the city of Antioch, during the year spent there in preaching by Paul and Barnabas, A.D. 34. Both Suidas (ii, 8980, s, ed. Gaisford) and Malalas (*Chronograph.* x) say that the name was first used in the episcopate of Evodius at Antioch, who is said to have been appointed by the apostle Peter as his successor (Jerome, *Chronic.* p. 429). That Evodius actually invented the name (Malalas, l. c.) is an assertion which may be disregarded as safely as the mediæval fiction that it was adopted at a council held for the purpose.

"The name itself was only contemptuous in the mouths of those who regarded with contempt him from whom it was derived; and as it was a universal practice to name political, religious, or philosophical societies from the name of their founders (as Pythagoreans, Epicureans, Apollonii, Cesariani, Vitelliani, etc.), it was advantageous rather than otherwise for the Christians to adopt a title which was not necessarily offensive, and which bore witness to their love and worship of their master; a name intrinsically degrading—such as the witty Antiochenes, notorious in the ancient world for their propensity to bestow nicknames, might easily have discovered (Philost. *Vit.*

Apol. iii, 16; Zosim. iii, 11; Ammon. Marcell. xxii; Procop. *Hell. Pers.* ii, 8)—would certainly have retarded the progress of the new religion; and as we see, even in modern times, that it is the tendency of rival sects to brand each other with derisive epithets, it is natural to suppose that the name 'Christians' resulted rather from philosophical indifference than from theological hatred. The Latinized form of the word—Greek in form, Latin in termination—is not indeed a conclusive proof that it emanated from the Romans, because such terminations had already been familiarized throughout the East by the Roman dominion; but it is precisely the kind of name which would have been bestowed by the haughty and disdainful spirit of victorious Rome, which is so often marked in early Christian history (John xviii, 81; Acts xxii, 24; xxv, 19; xviii, 14). That the disciples should have been called from 'Christus,' a word implying the office, and not from 'Jesus,' the name of our blessed Lord, leads us to infer that the former word was most frequently on their lips, 'which harmonizes with the most important fact, that in the epistles he is usually called, not 'Jesus,' but 'Christ' (Lactant. *Div. Instit.* iv, 7). In later times, when the features of the 'exultabilis superstitio' were better known, because of its ever-widening progress (Tacit. *Ann.* xv, 44), this indifference was superseded by a hatred against the name as intense as the Christian love for it, and for this reason the emperor Julian 'countenanced, and perhaps enjoined, the use of the less honorable appellation of Galileans' (Gibbon, v, 812, ed. Milman; Greg. Nazarene, *Orat.* iii, 81). Yet, as Tertullian, in an interesting passage, points out, the name so detested was harmless in every sense, for it merely called them by the office of their master, and that office merely implied one set apart by solemn unction (*Apoloq.* 3).

"It appears that, by a widely prevalent error, the Christians were generally called *Chrestiani* (*Χρηστιανοί*, Sueton. *Nero*, 16; Claud. 25) and their founder *Chrestus* (q. d. *χρηστός*, excellent), a mistake which is very easily accounted for (Lactant. *Instit.* Div. iv, 7), and one which the Christians were the less inclined to regret, because it implied their true and ideal character (Clem. Alex. *Strom.* II, iv, 18; Tert. *Apol.* c. 8). See CHRISTIANS. The explanation of the name Christian, as referring to the 'unction from the Holy One,' although supported by the authority of Theophilus Antiochenus (A.D. 170), 'who lived not long after the death of John' (*ad Autolyc.* i, 12), can only be regarded as an adaptation or an after-thought (see Jer. Taylor, *Disc. of Confirm.* § 8).

"The adoption of the name marks a very important epoch in the history of the Church; the period when it had emerged, even in the Gentile observation, from its Jewish environment, and had enrolled followers who continued *Gentiles* in every respect, and who differed widely from the Jewish proselytes. 'It expressed the memorable fact that a community consisting primarily of Jews, and directed exclusively by them, could not be denoted by that name, or by any name among them. To the disciples it signified that they were witnesses for a king, and a king whom all nations would be brought in due time to acknowledge' (Maurice, *Eccles. Hist.* p. 79). See Buddens, *De origine, dignitate et usu nominis Christiani* (Jen. 1711; also his *Miscell. Sacr.* i, 280 sq.); Wetstenii *Nov. Test.* in Acts xi; Zeller, *Bibl. Wörterb.* s. v. Christen, etc." (Kitto, s. v.).

To be denominated *Christian* was, in the estimation of the confessors and martyrs, their highest honor. This is illustrated in the narrative which Eusebius has copied from an ancient record, of one Sanctus of Vienna, who endured all the inhuman tortures which art could inflict. His tormentors hoped, by the continuance and severity of his pains, to extort from him some acknowledgment which might implicate him; but he withstood them with unflinching fortitude, neither dis-

closing to them his name, nor his native land, nor his condition in life, whether freeman or slave. To all their interrogatories he only replied, *Christianus sum*; affirming that his name, his country, and his kindred all were included in this. Of the same import was the department of the martyr Lucian, as related by Chrysostom. To every question he replied, "I am a Christian." "Of what country are you?" "I am a Christian." "What is your occupation?" "I am a Christian." "Who are your parents?" "I am a Christian."—Bingham, *Orig. Eccles.* bk. i, ch. i.

Christian, first bishop of Prussia, was born at Freienwalde, in Pomerania, in the latter part of the 12th century. He became a monk of the Cistercian order, in which he acquired great eminence for his piety and learning. In 1210 he went as missionary to Prussia, which country had before resisted all attempts at Christianization. He proved successful in his undertaking, and was made bishop of Prussia in 1214. In order to give a permanent protection to the Church, he founded, in 1215, the order of the Knights of Christ. He died in 1241.—Neander, *Ch. History* (Torrey), iv, 48; M'Lear, *Missions in Middle Ages*, p. 341.

Christianity, (1) in the objective sense, is the religion of Christians, including doctrines, morals, and institutions. Of Christianity, the Scriptures of the Old and New Testaments are the sole foundation and source, as containing "all things necessary to salvation; so that whatever is not read therein, nor may be proved thereby, is not to be required of any man that it should be believed as an article of the faith, or be thought requisite or necessary to salvation" (*art. vi of the Church of England*). (2) In the subjective sense, it denotes the Christian faith and life of the individual, in which is manifested the life of Christ, the God-man, imparted through the Holy Spirit. The statement of Christian doctrines, in scientific form, is the object of theology (q. v.). The special doctrines are treated under their proper heads in this dictionary. The proof of the divine origin and authority of Christianity is the province of *Apologetics*, or the *Evidences of Christianity*. See *APOLOGETICS*; *EVIDENCES*. The statement of the practical principles of Christianity belongs to *Ethics* or *Morals* (q. v.). The institutions of Christianity are treated under the heads *CHURCH*, *BAPTISM*, *LORD'S SUPPER*, *MINISTRY*, *SACRAMENTS*. The aggressive movements of Christianity in heathen countries are treated under *MISSIONS*; its present territorial extent under *CHRISTENDOM*.

The *history of Christianity* is the history of the reception of the teachings, ordinances, and institutions of Christ among men, and embraces what is more commonly, but less properly, called the history of the Christian Church. We give a brief survey of the history of Christianity, and divide it for this purpose into five periods.

I. *From the Foundation of Christianity until its Establishment as a State Religion in the Fourth Century.*—When Christ appeared upon earth, both paganism and Judaism had lost their influence over the mass of the people. Presentiments of the proclamation of a purer religion were widely disseminated. Among the Jews, the Messianic hopes which had been awakened by the prophets had gained new strength from the political oppression under which the nation so long suffered. Christ confined his preaching to the Jews, and we read in the Gospels that large crowds of the people were always eager to hear him, though the most influential sects of those times, the Pharisees and Sadducees, opposed him. After the ascension of Christ, the disciples were prepared, by the outpouring of the Holy Ghost on the day of Pentecost, to carry on the dissemination of Christianity. The first congregation was established at Jerusalem, the second at Antioch. In Judea, and especially in Jerusalem, the apostles and other

Christians were cruelly persecuted, and Stephen was stoned and became the first martyr. But one of the leading instigators of the persecution, Saul of Tarsus, was soon converted in a miraculous manner, and established new churches, not only among the Jews in a great many provinces of the Roman empire, but also among the pagans. At Antioch, the followers of Jesus, who during his lifetime had had no distinguishing name, received the name *Christians*. See *CEREBETIAN*. Paul warned the congregation in Corinth not to assume party names, as parties of Apollos, of Paul, of Cephas, or of Christ; but the term is applied, not to distinguish a party among Christians, but to distinguish Christians from pagans and Jews. By the Jews, the Christians were for a long time called Galileans or Nazarenes. The Christians of Jewish extraction separated only by degrees from outward connection with the synagogues, and the fundamental elements of a church constitution were not developed before the second half of the first century. The details of this development have been of late the subject of most minute and ingenious investigations, but the darkness in which the subject, on account of the meagreness of the contemporaneous literature, has been involved, is far from being removed. Comp. *APOSTOLIC AGE*; *CHURCH*. The apostles remained the centre for the Christian churches, and devoted themselves, in connection with so-called evangelists, to the spreading of the Gospel, while under them presbyters (or bishops) were the teachers and superintendents of particular congregations. Deacons, and sometimes also deaconesses, were charged with the care of the poor and other social wants of the community. The spread of Christianity gave rise to repeated persecutions by the Roman emperors, some of which were local, while others were more or less general. Usually ten persecutions are counted, viz. first, under Nero, 64–68, by whose order several Christians of Rome were put to death, Nero, as is reported, charging them with having caused the great conflagration. In the second persecution (98–95), Domitian, misinterpreting the royal office of Christ, ordered the surviving relations of Christ, whom he looked upon as rivals, to be put to death. The third persecution was under Trajan, in Bithynia, in 116. Many were punished as apostates from the state religion, although a report from the younger Pliny bore a good testimony to their character. The fourth persecution, in 118, under Hadrian, did not proceed from the government, but the Christians greatly suffered in many places, especially in Asia Minor, from riots of the mob. The fifth persecution, under Marcus Aurelius, in 177, affected especially the congregations of Lyons and Vienne, in Gaul, and the churches of Asia Minor. Among the martyrs was Polycarp, bishop of Smyrna. From the sixth persecution, under Septimius Severus, in 202, especially the Christians of Egypt and Asia Minor had to suffer. The seventh persecution, under Maximin, in 235, was properly directed only against the bishops and leaders of the congregations, but the Christians suffered greatly during his reign from the mob, especially in Cappadocia, because earthquakes and other calamities of that kind were laid to their charge. Very severe and extensive was the ninth persecution, under the emperor Decius (249–251), who was alarmed at the rapid increase of the Christian population. In consequence of the severity of the persecution, many Christians apostatized and many congregations were destroyed. The ninth persecution, under Valerian, in 257 and 258, was also very cruel. He ordered bishops to be exiled, prohibited the assemblies of the Christians, and declared state officers who were Christians to have forfeited their offices, and, later, also their lives. The tenth and last persecution, under Diocletian, in 303 and 304, was the severest of all. The edict of 303 ordered all the churches of the Christians to be burned, the state officers who were Christians to be declared infamous, and all

free Christians to be made slaves. According to an edict of 304, all Christians were to be compelled by tortures to sacrifice to the pagan gods. With the abdication of Diocletian in 305, the era of persecutions ended (see Benkendorf, *Historie der zehn Hauptverfolgungen*, Leips. 1700, 8vo). Those Christians who, in some way or other, succumbed in the persecution, were called *Lapsi* (q. v.), of whom there were several classes, as *Libellatici*, *Sacrificati*, *Thurificati*, and *Traditores*; those who remained steadfast were called *Confessores*. See CONFESSORS. Christianity was, however, not persecuted by all the Roman emperors, but was tolerated by some, and even favored by a few, e. g. Caracalla, Alexander Severus, and Philipppus. In 306 Constantine established toleration of Christianity in the provinces of Britain, Gaul, and Spain. Conversion to Christianity was expressly permitted by another edict of Constantine in 313, and restoration of the Christian churches ordered. Even an indemnification from the public treasury was promised. Constantine, by a decree of 324, established full religious liberty for the Christian religion in the whole Roman empire, and restored to liberty those who, under Diocletian, had been enslaved. Toward the end of his reign he even issued edicts against paganism. He was baptized himself shortly before his death. See CONSTANTINE.

Christianity during the first period of its history was not only exposed to the persecution of the emperors, but also to the literary attacks of many pagan scholars, as Lucian, Celsus, Porphyrius, Hierocles, and others, which called forth among the Christians a number of apologetic writers. See APOLOGISTS. Dissensions and divisions were very numerous among the Christians from the earliest period of the Church. A strict line of demarcation established itself between the common faith (orthodoxy) and the secessions (heresy). As early as the apostolic age we find the Gnostics, Simonians, Nicolaites, Cerinthians; in the second century the Basilidians, Carpocratians, Valentinians, Nazareans, Ophites, Patrisians, Artemonites, Montanists, Manicheans, and others; in the third century the Monarchians, Samosatensians, Noetians, Sabellians, Novatians, etc. Most of these controversies concerned the person of Christ; some related to the creation of the world and of the spirits; others to the Lord's Supper; only a few had regard to the discipline of the Church and some other points.

The *diocesan* constitution gradually developed itself, the congregations in villages and smaller places seeking a connection with the bishops of the town. Of a regular *metropolitan* constitution, only the first beginning is found during this period, but the bishops of Rome, Alexandria, and Antioch were already regarded as the heads of very extensive ecclesiastical districts. Christian ministers assumed a distinguishing name (*clerici*), and a peculiar dress for divine service, and they were divided into many classes (see Bingham, *Origines Ecclesie*; Planck, *Gesch. der christlich-kirchlichen Gesellschaftsverfassung*, Hanov. 1803). Towards the end of this period, resort began to be had to synods and councils to settle ecclesiastical disputes. See COUNCILS. The form of public worship was gradually fixed in imitation of that of the Jewish synagogue, and consisted of prayer, singing, reading, and interpreting the Scriptures. Baptism was performed in the name of Jesus; the agapæ (q. v.) and the Lord's Supper (q. v.) were celebrated after divine service. The sources of doctrine were the epistles of the apostles and the records of the life of Jesus (the Gospels). Some of the gospels, which are now regarded as apocryphal, were in use in some of the churches, and some importance was also attributed to ecclesiastical tradition. Church discipline was very strict, and all grave offences were punished with exclusion (excommunication). Asceticism and monasticism found their first adherents in this period in Anthony, Paul of Thebes, and others.

II. *From the Death of Constantine the Great to Charlemagne* (A. D. 337 to 800).—The last attempt to suppress Christianity by force, or at least to repress its further advancement, was made by Julian the Apostate (q. v.), but it failed utterly. His successors remained Christians, and Christianity became the religion of court and state. The Church and the state began to exert a powerful and reciprocal influence upon each other. See CHURCH AND STATE. The metropolitan constitution was organized throughout the whole Church, and in connection with it the patriarchal constitution, represented by the four patriarchs of Rome, Constantinople, Alexandria, and Antioch. The bishops of Rome began to claim jurisdiction over the whole Church. Councils and synods became more frequent. In addition to the provincial councils of the first period, oecumenical councils (q. v.) (of which one had been held during the first period, viz. that of Nice, A. D. 325), to which all bishops of the Christian Church were invited, were held at Constantinople (381, 553), at Ephesus (431, 449), at Chalcedon (451). See COUNCILS. They were occasioned by doctrinal controversies, the number of which greatly increased during this period. The doctrine of the Church on the person of Christ was attacked by the Arians, Eunomians, Aëtians, Anomœans, Adoptionists, Nestorians, Eutychians, Monophysites, Jacobites, Monothelites, and other sects; that of the Trinity by the Tritheites; that of the nature of God by the Seleucians and the Anthropomorphites. The Church also rejected the views of the Antidikomarrians, Bonosians, Jovinians, Collyridians, on the Virgin Mary; those of the Euchites and Priscillianists (modified Gnostic-Manichean doctrines); those of the Meletians and Donatists on the constitution of the Church. *Monasticism* was rapidly developed after the fourth century; and as the lower secular clergy were generally ignorant, the missionary work and the culture of letters were almost entirely left to the monks. The ignorance of clergy and people facilitated the introduction of many innovations and corruptions in the doctrine of the Church, such as the veneration of saints and relics. Pomp and magnificence were introduced into the celebration of divine worship, and the arts began to be used to serve ecclesiastical ends. The Latin language was retained in worship, though it was no longer understood by all the people. The changes in the ancient discipline of the Church (for which in many cases even payments of money were substituted) exerted a most disastrous influence on the Christian life. In the literature of this period, the names of Chrysostom, Augustine, Cyril, Theodoret, Isidor of Pelusium, Isidor of Hispalis (Seville), and Johannes Damascenus, stand forth most conspicuous.

III. *From Charlemagne to Gregory VII* (A. D. 800 to 1078).—Among the Germanic tribes, the Franks were attached most firmly to Christianity. Charlemagne in his conquests always sought to make Christianity the established religion, and his wars against the Saxons and Slavonians were wars for the extension of Christianity. The degraded condition of the clergy and the Church in his states induced Charlemagne to attempt various reformatory measures in behalf of the Church. By the establishment of convents and cathedral schools, he sought to promote the education of the clergy. By his order the corrupt translation of the Bible was corrected, the congregational singing improved, more prominence given to the sermon in divine worship, and annual visitations of the diocese by the bishops introduced. See CHARLEMAGNE. While Christianity rapidly advanced in Northern Europe, the body of the Church was divided, in consequence of the rivalry of the bishops of Rome and Constantinople, into the Western or Latin, and the Eastern or Greek Church. The two churches excommunicated each other, and a permanent union has never since been effected. The Greek Church, first enslaved by the emperors of Constantinople, and afterwards trodden down by the Turks,

became petrified and stationary. In the Roman Church the rights of metropolitans and bishops were more and more curtailed, and those of the pope enlarged, especially by the pseudo-Isidorian Decretals. See *DECRETALS*, *FALSE*. Spain, England, and the other European countries gradually surrendered their ecclesiastical independence, and the pope became all-powerful in the exercise of jurisdiction as well as in doctrinal decisions. Bishops and abbots became the possessors of large property; the pope entered the ranks of secular princes, and strove to subject even the secular governments to his influence and rule. Most of the literary institutions founded by Charlemagne were suspended within half a century after his death, and the general ignorance of the clergy became so great that the bishops had to order that "every clergyman must know at least the Apostles' Creed." The theology of this period spoke little of Christ, his work and his merits; the belief in the intercession of the saints, in the efficacy of their relics, and similar points, became prominent in the mind of the Church. The pope reserved to himself the examination of the genuineness of the relics, and the beatification and canonization of holy men. In the eleventh century the rosary (q. v.) came up in England and Holland, and new festivals were introduced, especially festivals in honor of the Virgin Mary. Pilgrimages (q. v.) commenced in this period. In ecclesiastical architecture the Romanic style was developed in the tenth century. Among the doctrinal controversies, those on the Lord's Supper (q. v.) were the most important. Morality was generally at a low ebb, and there was no vice which was not prevalent among the clergy and in the monasteries, and immorality passed over from them to the people.

IV. *From Gregory VII to the Reformation (1078-1517)*.—The oppression of Christianity by the Turks called forth the crusades against the Saracens (1096-1246), in order to deliver the Holy Land. See *CRUSADES*. Palestine was conquered and held for a short time, and several orders of Christian knights were established there for the protection of Christianity; but towards the close of the 13th century it was reconquered by the Saracens, by whom Christianity was barely tolerated. The oppression suffered by the Greek Church led to an attempt at a new union with the Roman, which, however, was soon given up as impracticable. The power of the popes reached its climax under Gregory VII and Innocent III, but it soon began again to decline, especially through the papal schism (1378-1414), during which two papal sees existed—Rome and Avignon. The popes secured the right of the investiture of the bishops and abbots, and the exemption of the clergy, and enforced throughout the Church the celibacy (q. v.) of the clergy. The Bible was less and less appealed to as the rule of faith; the fathers and tradition took its place. The pope became the sole legislator and judge in matters of faith. New doctrines and practices, such as auricular confession, transubstantiation, and indulgences, together with new festivals (e. g. *Corpus Christi*), were established. The Inquisition and the mendicant orders, especially the Franciscans and Dominicans, crushed out all opposition to the ruling Church. Public worship greatly degenerated. The Mass became its centre; sermons became rare, and consisted mostly either in unintelligible scholastic lectures, or in comic invectives against the follies of the times. The increasing corruption among the clergy, and still more the traffic with indulgences, undermined the piety of the people. Attempts to stop the prevailing abuses were frequently made, both by individuals and by smaller and larger denominations, among which the Albigenses (q. v.), Waldenses (q. v.), and Hussites (q. v.) were prominent. At the request of the Church the secular governments proceeded against these sects, and crusades were preached for their extirpation. Most of them were extirpated; but the *Waldenses* in Italy, the *Mo-*

raavian Brethren in Germany, and the *Lollards* in England, survived to see and to share in the great Reformation of the 16th century. In *theological science*, Scholasticism arose, a system full of acute subtleties, but entirely incapable of satisfying the religious wants of the heart. In opposition to the Scholastics (q. v.), many pious Mystics (q. v.) strove to maintain a pure Biblical Christianity, more by ignoring the antiscritptural doctrines of the Church than by openly rejecting them. In ecclesiastical architecture the Byzantine style was supplanted in France, England, Spain, and especially in Germany, by the Germanic or Gothic, which reached the highest stage of development in the 13th and 14th centuries.

V. *From the Reformation until the present Time*.—The controversies called forth by Wycliffe, Huss, and other reformers of the Middle Ages, awakened in large circles the longing for a thorough reformation of the Church. The councils of Constance (q. v.) and Basle (q. v.) at first attempted to carry through this reformation, but they only diminished a few of the grossest abuses, being both unable and unwilling to remedy them thoroughly. The corruption of the Church not only continued, but certain abuses (e. g. the traffic in indulgences) became so flagrant that at the beginning of the 16th century contempt of the Church, her officers, doctrines, and ordinances, became almost general throughout Europe. When, therefore, Luther, Zwingli, and others raised the standard of a radical reformation of the Church on the basis of the Bible, millions of Christians, especially in Germany, Switzerland, Holland, England, Denmark, Sweden, Prussia, at once rallied around it. See *REFORMATION*. Though the Reformers did not agree on all points of doctrine, they were unanimous in claiming the Bible as the rule of faith, decidedly rejecting everything which had crept into the Church in opposition to the Biblical doctrine. The Roman Church made many unsuccessful attempts to suppress these reformatory movements, and the new order of the *Jesuits* (q. v.), the most powerful and influential of all monastic institutions, was instituted for this special purpose. These attempts, which led to the war of the Huguenots in France, and the Thirty Years' War in Germany, were in vain. From some countries the Roman Church was entirely excluded, while in others it had at least to grant to Protestants equal rights and toleration. The Church saw itself also compelled to convoke a General Council [see *TRIDENT*], and to abolish at least a few of the grossest abuses. A few futile efforts were made to bring about a union with the Protestants. The doctrine of the Roman Church received in the Council of Trent its final form, yet since that period several doctrinal controversies (e. g. Jansenism [q. v.] and Quietism [q. v.] in France, and the philosophy of *Hermes* [q. v.] and Gunther in Germany) have required new decisions of the Papal See. The Gallican Church (q. v.) in council, with Bossuet (q. v.) at its head (1682), and a number of distinguished bishops in Germany [see *FERBRONNIUS*], Italy [see *RICCI*], and other countries, protested against making the infallibility claimed by the popes a doctrine of the Church; yet, on the whole, the popes have been so successful in enforcing obedience to their doctrinal definitions and divisions, that in 1854 an entirely novel dogma [see *IMMACULATE CONCEPTION*] was proclaimed by Pope Pius IX, without the sanction of a General Council. Some princes, as Joseph II of Austria, Leopold of Tuscany, and others, have attempted to restrict the absolute power claimed by the pope over clergy and people, mostly without success. Still less successful were certain attempts to establish national "Catholic" churches independent of Rome (viz. the "French Catholic Church" in 1831, the "German Catholics" in 1854). These movements were not made on the ground of the Bible and of revealed Christianity, and therefore necessarily were failures. The relation between the different states of

Europe, in which the Roman Church is recognised as a state religion, and the pope, is regulated by *Concordats* (q. v.).

The *Protestants* in course of time formed a number of different denominations, among which two main tendencies are to be distinguished, viz. the Lutheran and the Reformed Churches. The latter were subdivided into the German Reformed, Swiss Reformed, Dutch Reformed, Presbyterians, Baptist, Congregational, and other minor churches. The Church of England, as far as it identified itself with the Reformation, belongs to the class of Reformed churches; yet it retains also enough elements from the time before the Reformation to leave room for the continuance of a party which rejects altogether the Protestant character of the Church, refuses association with other Protestant denominations, and acknowledges only the churches which claim the so-called apostolical succession of bishops as valid. From the Church of England sprang the *Methodists* (q. v.), who discarded everything un-Protestant in the mother Church, and took at once a prominent place among the Reformed denominations. In the rapidity of their extension they have surpassed all other bodies of Protestant Christians.

In a large part of Europe the Protestant churches have unfortunately allowed to the secular government an undue influence over ecclesiastical affairs—an influence which has generally been used for the entire subjugation of the Church. Only by hard struggles have *dissectors* from state religions secured toleration. Many of them had to cross the Atlantic in order to be at liberty to worship God according to the dictates of conscience. The declaration of American independence was the first heavy blow against state-churchism; and the independence of the Church, which was now, for the first time, carried through on a large scale, worked so well, that all the European churches began to feel the influence of the new principle, and gradually to loosen, at least, the connection between Church and state. The question of a union between various Protestant bodies has been, from the beginning of the Reformation, a favorite idea of many distinguished men, though it has frequently led to an increase of parties and of controversies, especially as generally these schemes of ecclesiastical union have been attempted with the aid of the secular arm. The most important of these attempts was the establishment of the United Evangelical Church (q. v.) of Germany in 1817, through the instrumentality of Frederick William III of Prussia. In modern times the opinion has gained ground that the large number of evangelical denominations has had a beneficial rather than a disastrous influence on the advancement of Christianity, and that it would be better, instead of aiming at ecclesiastical uniformity, to form a cordial alliance of evangelical Christians of all denominations. This led to the formation of the so-called "*Evangelical Alliance*" (q. v.), which soon assumed grand dimensions. It has held some large assemblies, which have been called the first oecumenical councils of Protestant Christianity. The development of theology during this period has centred mostly in Germany. See GERMAN THEOLOGY. The struggle, after the Reformation, between Lutheranism and Calvinism, was soon followed by the more important contest between Christianity and an infidel philosophy, represented by the Deists in England, the Encyclopædists in France, and Rationalism in Germany. The belief in Christianity was for a time undermined in a large proportion of the European population, but with the beginning of the nineteenth century a powerful reaction in favor of Christianity has set in. The influence of Christianity over the political, social, and literary life of mankind is now greater than ever before. But infidel parties have not been wanting in the nineteenth century. Among them may be named Young Germany, the Free Congregations

and German Catholics, the Young Hegelians, the Socialistic Mechanics' Associations in Switzerland and France, the Materialism in natural science, the Positivist followers of Comte, the Westminster Review and its party in England, the Mormons and Spiritualists in America. The movements of these parties have led to a new development of powerful agencies in defence of Christianity. In nearly every department of science and literature the works of former centuries have been surpassed by modern Christian writers. The various denominations vie with each other in establishing religious periodicals, which already form one of the grandest characteristics of the church history of the nineteenth century. Free associations for religious and other charitable purposes have rapidly multiplied; missionary societies, Bible, tract, and book societies have displayed a wonderful and unparalleled activity.

Thus the spread of Christianity from the beginning has been like to the growth of the "grain of mustard seed;" to-day its branches overshadow the whole earth; the prospects of Christ's kingdom on earth are brighter than at any previous period of its history. Compare Smith, *Tables of Church History* (especially the column "General Characteristics"). See CHRISTENDOM; CHURCH HISTORY; THEOLOGY.

Christians (improperly pronounced *Christ-ians*), a denomination usually styled "the Christian Connection."

I. History.—This body is purely American in its origin, having sprung from three different sources widely apart from each other—the Methodist, Baptist, and Presbyterian Churches in different parts of America. (1.) When the so-called "O'Kelly secession" from the Methodist Episcopal Church (q. v.) took place in the year 1798, the seceders at first took the name of "Republican Methodists," but afterward assumed the name of "Christians," avowing the N. T. as their only code of doctrine and discipline. (2.) In the year 1800, Dr. Abner Jones, a member of the Baptist Church in Hartland, Vermont, "becoming dissatisfied with the creed of his church, and with all sectarian denominations, and preferring the Bible alone as the confession of his faith," organized a church of twenty-five members in the town of Lyndon, Vt. In a few years he was joined by ministers from the Close Communion and Free-will Baptist churches, who left their former associations, and, in some cases, brought their flocks with them. (3.) The third source of the new sect was found in Kentucky and Tennessee. About the year 1801, several ministers withdrew from the jurisdiction of the Presbyterian Church, and "organized themselves into a new and independent presbytery, called the Springfield Presbytery. They kept up this organization for about two years, when they formally adopted a new name for themselves and followers—that of Christians." (See Davidson, *Presbyterian Church in Kentucky*, chap. viii.)

The three bodies thus separately organized were finally brought into one society, adopting the common name "Christians." They have become quite numerous.

At the Quadrennial General Conference of this denomination held at Marshall, Michigan, on October 2, 1866, and the following days, the following 40 Annual Conferences were represented by delegates:

CONFERENCE.		No. of Delegates.
1	Passamaquoddy, Me.	18
2	Vermont Western	20
3	Merrimack	15
4	Rockingham	13
5	York and Cumberland	15
6	Stratford	13
7	Massachusetts and Rhode Island	47
8	New York Eastern	40
9	New York Central	14
10	New York Western	40

	CONFERENCES.	No of Delegates.
11	New York Northern.....	11
12	New York Southern.....	14
13	New Jersey.....	14
14	Tioga River, N. Y.....	25
15	Erie, Pa.....	16
16	Canada.....	22
17	Miami, O.....	52
18	Central Ohio.....	29
19	Maumee Valley.....	5
20	Southern Ohio.....	50
21	Deer Creek, O.....	14
22	Eel River, Ind.....	16
23	Antioch and Bluffton.....	42
24	Western Indiana.....	52
25	Mason River, Ill.....	5
26	Northern Illinois and Southern Wisconsin.	23
27	Central Illinois.....	25
28	Spoon River.....	29
29	North-eastern Iowa.....	8
30	Union, Iowa.....	9
31	Des Moines, Iowa.....	23
32	Eastern Michigan.....	17
33	South-east Michigan.....	7
34	Central Michigan.....	19
35	Grand River Valley.....	6
36	Southwestern Michigan.....	12
37	Northern Indiana and Western Michigan.	6
38	Richland Union, Wis.....	6
39	Northern Wisconsin.....	
40	Jacksonville.....	

The Rev. I. C. Goff, of Illinois, was elected President. A letter, expressing harmony of views and fraternal feelings, was read from the Association of General Baptists in England, this being the first communication of the kind since 1823. The General Conference replied by a series of resolutions, reciprocating the feelings of the General Baptists, and by appointing a delegate to attend their next annual meeting. It was resolved to establish a Biblical institute in the State of New York, and to increase the number of denominational periodicals by the establishment of a *Quarterly* and of an *Annual Register*. The original platform of the denomination, namely, "That the name Christian is the only name of distinction which we take, and by which we, as a denomination, desire to be known, and the Bible our only rule of faith and practice," was unanimously reaffirmed.

A convention of members of the denomination in the Southern States ("Southern Christian Convention") was held at Mount Auburn, N. C., on May 2, 1866, at which it was resolved to revive the denominational book concern at Suffolk, Va., which had been destroyed by fire soon after the beginning of the war. See *Annual American Cyclopaedia* for 1866, a. v. Christian Connection; *Minutes of the U. S. Quadrennial Christian Connection* (Dayton, 1866).

II. *Doctrines*.—Each congregation of "Christians" is independent, and they take the Bible as their binding standard of doctrine. The following principles appear to be generally recognised among them: (1) The Scriptures are inspired, and are of divine authority. (2) Every man has a right to interpret the Bible for himself, and therefore differences of theological views are no bar to Church fellowship. (3) There is one God, but the doctrine of the Trinity is not generally received. (4) Christ is a divine being, pre-existent, and is the mediator between God and man. (5) Christ's sufferings atone for the sins of all men, who, by repentance and faith, may be saved. (6) Immersion is the only proper form of baptism, and believers the only proper subjects (rejecting infant baptism). (7) Communion at the Lord's table is open to believers of all denominations.

III. *Government and Usages*.—Though each congregation is theoretically independent, there are "Annual" or "State" Conferences, composed of ministerial and lay delegates from the churches, which receive and ordain pastors, etc., but can pass no laws binding the several churches. They have an American Christian Convention, whose officers from 1866 to 1867 were:

President, D. P. Pike, of Massachusetts; Secretary, N. Summerbell, of Ohio; Secretary of Missionary Department, D. E. Millard, of Michigan; Secretary of Educational Department, J. W. Haley, of Massachusetts; Secretary of the Sabbath-school Department, I. C. Goff, of Illinois; Secretary of the Publishing Department, C. A. Morse, of Ohio. The forms of worship, etc., are in general the same as those in the Baptist churches.

The Constitution of the General Convention, as amended in 1866, is as follows:

ARTICLE I.—This organization shall be styled "The American Christian Convention."

ART. II. The business of the Convention shall be to arrange, direct, or transact such matters as may be thought proper and necessary, in connection with and for the furtherance of the interests and honor of the cause of Christ.

ART. III. The officers of the Convention shall consist of a President, one Vice-president from each state or province connected with the Convention, a Secretary of the Convention, and one Secretary for each department hereinafter provided for; and all the above officers, except the Vice-presidents, shall be chosen by ballot for the term of four years, and until their successors are chosen. The Vice-presidents shall be nominated by the states and provinces represented in the Convention.

ART. IV. It shall be the duty of the President to preside in all meetings of the Convention and of the Executive Board.

ART. V. In the absence of the President at any meeting one of the Vice-presidents shall preside.

ART. VI. The Secretary shall faithfully note and record all the doings of the Convention and of the Executive Board.

ART. VII. The Convention shall consist of the following named departments, viz.: 1. Missionary; 2. the Educational; 3. the Publishing; 4. the Sabbath-school; 5. Treasury Department. Each department shall have an appropriate secretary, who shall have the supervision thereof, subject to the control of the Executive Board hereinafter named.

ART. VIII. The Executive Board shall consist of the President and the six Secretaries above named, whose duty it shall be to carry out any measure determined on by the Convention, and any other measure which it may deem necessary and proper; and such Secretary shall, not less than one month prior to every regular meeting of the Convention, make a written or printed report of the doings of his department, accompanied with recommendations, which, on the opening of the Convention, the President shall lay before it, together with a like report and recommendation made by himself to the Convention.

ART. IX. The Secretary of the Treasury shall keep and invest funds belonging to the Convention, subject only to be drawn by a vote of the Convention or Executive Board; in either case the order to bear the sanction and signature of the President and Secretary of the Convention. He shall give bonds to the acceptance of the Executive Board.

ART. X. Any person shall, on the payment of twenty-five dollars into the treasury, be entitled to a certificate of life-membership; or, on the like payment of three dollars, to a certificate of quadrennial membership. Every Christian benevolent organization, Convention, Conference, and church which shall contribute to the treasury of the Convention shall be entitled to membership, with one vote for every three dollars quadrennially contributed. Also the presidents of our Conferences, state associations or state Conferences, and colleges or Institutes, shall be *ex-officio* members of the Convention.

ART. XI. The Missionary Department shall have charge of the missionary enterprises of the denomination, with the power to acquire and hold the title to real estate, appropriate to church purposes, erect churches, and aid in their erection and maintenance, and in general promote the cause of Christ in all parts of the world. The Educational Department shall establish colleges and Biblical and literary institutes, as well as aid those already established by the denomination, and assist young men preparing for the ministry by pecuniary loan or gifts. The Publishing Department shall have charge of the publishing interests of the denomination, the printing and diffusing of useful books, magazines, papers, tracts, and every form of literature suitable to religious and moral culture. The Sabbath-school Department shall have charge of the cause of Sabbath-schools, their establishment, support, and successful operation throughout the denomination, endeavoring to secure their welfare, and promote interest, zeal, and efficiency in this department.

ART. XII. The sessions of the Convention, under this Constitution, shall be called by the Executive Board quadrennially, and at other times when deemed by them necessary and proper.

IV. *Statistics*.—The denomination published in 1867 in the United States three periodicals, viz. *The Christian Sun* (discontinued during the war, but revived in 1867), at Suffolk, Va.; *The Herald of Gospel Liberty*—the first religious newspaper published in this country, first number issued September 1st, 1808—now pub-

lished at Newburyport, Mass.; and *The Gospel Herald*, at Dayton, O. The statements concerning their statistics greatly vary. Belcher, *The Religious Denominations in the United States* (1854), gives to them 607 organized churches, 489 ministers, and 34,000 communicants. In 1859 they claimed 1500 churches and 1000 ministers, and 150,000 communicants. The denomination has spread in England and the English possessions. Their institutions of learning are Christian Union College, at Merom, Ind.; Graham College, in North Carolina; and academies at Wolfborough, N. H., and Starkey, N. Y. They are to commence a Biblical School, and have fixed its location at Newark, N. Y. More than sixty Conferences have been organized in the United States and Canada, which meet annually.—Winebrenner, *History of all Denominations*; Belcher, *History of Relig. Denom. in the U. S.*; Gorrie, *Churches and Sects*; Schem, *Ecclesiastical Year-book*, p. 78; Baird, *Religion in America*.

Christians, Bible, also called **Bryanites**, after their founder, William Bryan, a Methodist local preacher in Cornwall, who left the Wesleyan body in 1815. He rapidly gathered churches in Devon and Cornwall, but left the party which he had formed in 1819. The denomination commenced its operations in Canada in the year 1831, and was organized there under a separate Conference in 1854. In 1866 the Bible Christians had 37 circuits and 43 home missions in England and 53 abroad, with 245 itinerant preachers, 1691 local preachers, 25,138 members, 1050 on trial, 89,249 scholars, and 8272 teachers. Their creed is Wesleyan, and so is their government, only more popular (Eadie, *Ecll. Dictionary*, s. v.). See **METHODISTS**.

Christians of St. John. "In the middle of the 17th century certain Carmelite missionaries discovered a sect residing in the neighborhood of Basrah and Susa, calling themselves *Nazoreans* or *Mendacians*, and called by the Mohammedans *Sabians* (Sabai, a name taken probably from the Koran), to whom they gave the name of Johannites, or St. John Christians. Comp. Ignatii a Jesu *narratio originis, rituum, et errorum Christianorum S. Johannis* (Rom. 1652, 8vo). One of their books has been published entire (*Codex Nazareus, liber Adamsi appellatus, Syriace transcriptus latineque redditus a Matth. Norberg*, 8 vols. Lond. 1815-16, 4to), and fragments of others, besides many accounts of travellers. In the *Universal Encyclopædia* of Ersch und Gruber, Gesenius has given a general view of their system (art. Zabier), which he shows to be Gnostic-ascetic, and nearly related to that of Zoroaster, John being represented as an incarnate son. The language of their holy books is an Aramaean dialect intermediate between Syriac and Chaldaic. They pretend to have come from the Jordan, and to have been driven thence by the Mohammedans. Some writers admit that they are really the descendants of John's disciples, or of John Baptist's. On the other side, see O. G. Tychsen in *Deutschen Museum*, 1784, ii, 414; Baumgarten Crusius, *Bibl. Theol.* p. 148."—Gieseler, *Church History*, i, § 22; Mosheim, *Commentaries* (N. Y. 1851), i, 60 note; Neander, *Church History* (Torrey's), i, 876. See **HEMERO-BAPTISTS**; **MENDACIANS**; **SABIANS**.

Christians of St. Thomas. This name is now applied only to a people residing on the Malabar coast, in the south of India. But in former centuries St. Thomas Christians were mentioned also in other Eastern countries; thus Cosmas Indicopleustes found them in Arabia before 565. The accounts of the Portuguese navigators, who first visited the Thomas Christians of India in the fifteenth century, represent them as professing to be descendants of the proselytes of the apostle Thomas, who is believed by some to have carried the Gospel into India. Other accounts represent them as the descendants of a colony of Nestorians. It seems most probable that they were originally an off-

shoot of the ancient Christian churches in Persia. In the sixth century they were in regular connection with the Nestorian Church of Western Asia. Under the patriarch Timotheus (778 to 820) they received a metropolitan, and thenceforth, also, their bishops were ordained by the Nestorian patriarch. The Indian princes conferred on them, especially at the beginning of the ninth century, many privileges, for which they were especially indebted to one Thomas Cananaius, also named Mar Thomas, who was probably not a bishop, but a rich and influential merchant. In consequence of the great increase of their number, they afterward formed an independent state, which, after the extinction of the royal line, fell by inheritance to the rulers of Cochin. They greatly suffered from the many contests of the Indian princes among each other, which the Mohammedans skilfully turned to their advantage. The St. Thomas Christians, therefore, offered, in 1502, the crown to Vasco de Gama. Their connection with the Nestorian patriarchate seems to have been early interrupted. Between 1120 and 1280 their ecclesiastical head, John, is said to have gone to Constantinople to ask for the episcopal consecration, and from there to Rome; later the church and the clergy became altogether extinct, so that only one deacon was left. Hence, in 1490, two delegates were sent to the Nestorian patriarch to ask for a bishop. The patriarch ordained the two delegates priests, and sent home with them two bishops, Thomas and John. John remained in India, but Thomas soon returned. Patriarch Elias († 1502) sent him again to India, with one metropolitanite Jaballaha, and two bishops, Jacobus and Denha. They reported that they found bishop John still alive, and 80,000 Christian families in twenty towns. Later Portuguese reports estimate the number of families at 16,000. On account of their poverty, and the oppression which they suffered from many sides, they invoked the protection of the Portuguese. The Portuguese protectorate was soon followed by the establishment of Jesuit missions among them. In 1599 the archbishop of Goa prevailed upon them to submit to the pope, and to accept the decrees of the synod held by him at Diamper. Only a few congregations in the mountains kept aloof from this union. But in 1658 a large number of them broke off the connection with Rome, and established the independence of the Church. In 1869 the number of (non-united) Thomas Christians was estimated at 70,000; of those united with Rome, 150,000, of whom 96,000, with 97 churches, still follow their old Syrian rite, while the others have entirely identified themselves with the Latin rite. They are, under the British government, free from any ecclesiastical restraint, and form among themselves a kind of spiritual republic, under a bishop chosen by themselves, and in which the priests and elders administer justice, using excommunication as a means of punishment. They are said still to acknowledge dependence on the patriarch of Antioch. They call themselves *Syrian Christians*, or *the Syrian Church of Malagala*. They still celebrate the agapæ; and their ideas respecting the Lord's Supper incline to those of the Protestants, but in preparing the bread they are said to use salt and oil. They anoint with oil the body of the infant at baptism. Their priests are distinguished by the tonsure, and are allowed to marry. Their churches contain, except the cross, no symbols or pictures. Syriac is the language employed in their liturgies and other church-services, but the Scriptures are expounded in Malabar. See Herzog, *Real-Encyclopædie*, x, 279; Schem, *Ecclesiastical Year-book* for 1860.

Christie, WILLIAM B., an eminent Methodist Episcopal minister, was born in Clermont County, Ohio, 1803, studied at Augusta College, Kentucky, entered the itinerant ministry in 1825, and died in Cincinnati, March, 1842. During his term of service in the ministry he occupied the most important pulpits of the denomination with great honor and usefulness.

His stations were, 1825, Union; 1826, Piqua; 1827-8, Zanesville; 1829, Cincinnati; 1830, Lebanon District; 1834, Cincinnati; 1835-8, Cincinnati District; 1839-40, Urbana. He was three times elected a member of the General Conference. His mind was of broad compass, and he was well versed in theology and ecclesiastical polity. In all discussions in the conferences he was an able and successful debater, and seldom failed of his aim. In the pulpit he was pre-eminent. His preaching was logical and vigorous, and he poured forth a flood of fervid and passionate eloquence that carried his audiences with him, and brought very many to Christ. His death was triumphant. — *Minutes of Conferences*, iii, 847; Sprague, *Annals*, vii, 708.

Christmas, the day (December 25th) which is celebrated throughout nearly the whole of Christendom as the birthday of our Saviour. "It is occupied, therefore, with the event—the incarnation—which forms the centre and turning-point of the history of the world. It is, of all the festivals, the one most thoroughly interwoven with the popular and family life, and stands at the head of the great feasts in the Western Church year. It continues to be, in the entire Catholic world, and in the greater part of Protestant Christendom, the grand jubilee of children, on which innumerable gifts celebrate the infinite love of God in the gift of his only-begotten Son. It kindles in mid-winter a holy fire of love and gratitude, and preaches in the longest night the rising of the Sun of Life and the glory of the Lord. It denotes the advent of the true Golden Age, of the freedom and equality of all the redeemed before God and in God. No one can measure the joy and blessing which from year to year flow forth upon all ages of life from the contemplation of the holy child Jesus in his heavenly innocence and divine humility" (Schaff, *Church History*, iii, § 77).

The observance of Christmas is not of divine appointment, nor is it of N. T. origin. The day of Christ's birth cannot be ascertained from the N. T., or, indeed, from any other source. The fathers of the first three centuries do not speak of any special observance of the nativity. The baptism of Jesus was celebrated in the Eastern Church by A.D. 220, but not in the Western until the fourth century; and the Eastern Church finally adopted the Christmas festival from the Western (about A.D. 380). Some writers (e. g. Cave, *Primitive Christianity*, pt. i, ch. vii, p. 194) trace the observance to the 2d century, about the time of the emperor Commodus. Cave cites, to prove that it was observed before the time of Constantine, the following sad story from Baronius (*An.* 801, p. 41): "While the persecution raged under Diocletian, who then kept his court at Nicomedia, the tyrant, finding multitudes of Christians, young and old, met together to celebrate Christ's nativity, commanded the church door to be shut, and fire put to it, which reduced them and the church to ashes." But it is historically certain that the Christmas festival proper "is of comparatively late institution. This may doubtless be accounted for in the following manner. In the first place, no corresponding festival was presented by the Old Testament, as in the case of Easter and Pentecost. In the second place, the day and month of the birth of Christ are nowhere stated in the Gospel history, and cannot be certainly determined. Again, the Church lingered at first about the death and resurrection of Christ, the completed fact of redemption, and made this the centre of the weekly worship and the Church year. Finally, the earlier feast of Epiphany afforded a substitute. The artistic religious impulses, however, which produced the whole Church year, must sooner or later have called into existence a festival which forms the groundwork of all other annual festivals in honor of Christ" (Schaff, l. c.). To account for the origin of Christmas, therefore, it is not necessary to trace it, as some writers do, to the feast of dedication celebrated by the Jews; or, as others do, to the heathen

Saturnalia. Jablonaki endeavors to show that it originated with the Basilidians in Egypt (*Opuscula*, ii, 872). "The institution may be sufficiently explained by the circumstance that it was the taste of the age to multiply festivals, and that the analogy of other events in our Saviour's history, which had already been marked by a distinct celebration, may naturally have pointed out the propriety of marking his nativity with the same honorable distinction. It was celebrated with all the marks of respect usually bestowed on high festivals, and distinguished also by the custom, derived probably from heathen antiquity, of interchanging presents and making entertainments." At the same time, the heathen winter holidays (Saturnalia, Juvenalia, Brumalia) were undoubtedly transformed, and, so to speak, sanctified by the establishment of the Christmas cycle of holidays; and the heathen customs, so far as they were harmless (e. g. the giving of presents, lighting tapers, etc.), were brought over into Christian use.

The Christmas Cycle of festivals gradually grew up around the observance of the day of nativity. It embraced Christmas eve, or Vigils, which were celebrated with especial solemnity, because, though the precise day of Christ's birth could not be ascertained, it is certain that he was born in the night (Luke ii, 8). The four Sundays before Christmas were made preparation days for the festival, and called Advent-Sundays. See ADVENT. Memorial days, etc., for the Martyr Stephen (Dec. 26), St. John (Dec. 27), Massacre of the Innocents (Dec. 28), were established in the fourth century. The festival of Circumcision and New Year (Jan. 1) is of later origin, while Epiphany (Jan. 8) is earlier than Christmas.

In later ages many observances, some pleasant, others absurd, grew up around the Christmas festival. Accounts of old English Christmas usages may be found in Chambers, *Book of Days* (Edinb. 1864, 2 vols. 8vo), and in Brand, *Popular Antiquities* (Lond. 1841, 8 vols. 12mo). Among them are the following. It was customary to light candles of large size, and to lay upon the fire a huge log, called a *Yule clog* or *Christmas block*, a custom not yet extinct in some parts of England. Yule (from *huel*, a wheel) was a sun-feast, commemorative of the turn of the sun and the lengthening of the day, and seems to have been a period of pagan festival in Europe from ancient times. At court, among many public bodies, and in distinguished families, an officer, under various titles, was appointed to preside over the revels. Leland, speaking of the court of Henry VII, A.D. 1489, mentions an *Abbot of Murrule*, who was created for this purpose, who made much sport, and did right well his office (*Collect.* iii, *App.* 256). In Scotland he was termed the *Abbot of Unreason*; but the office was suppressed by act of Parliament, A.D. 1555. Stow (*Survey of London*, p. 79) describes the same officer as *Lord of Murrule*. The Puritans regarded these diversions, which appear to have offended more against good taste than against morality, with a holy horror. Prynne says, in his strong way (in *Histrio-Mastix*), "Our Christmas lords of misrule, together with dancing, masks, mummeries, stage-players, and such other Christmas disorders, now in use with Christians, were derived from these Roman Saturnalia and Bacchanalian festivals, which should cause all pious Christians eternally to abominate them." The dishes most in vogue were formerly, for breakfast and supper on Christmas eve, a boar's head stuck with rosemary, with an apple or an orange in the mouth, plum porridge, and minced pies. Eating the latter was a test of orthodoxy, as the Puritans conceived it to be an abomination; they were originally made long, in imitation of the manger in which our Lord was laid (Selden's *Table-Talk*). The houses and churches were dressed with evergreens, and the former especially with mistletoe—a custom probably as old as the Druidical worship. Whether this festi-

val was always celebrated on December 26th is a subject of dispute. It was not till the sixth century that the whole Christian world concurred in celebrating the nativity on the same day. As to the question of the date of Christ's birth, see **NATIVITY**.

Christmas day is observed by nearly all churches in the world except the Dissenters of the British Islands, and the American churches that have sprung from them. In the Roman Church three masses are performed: one at midnight, one at daybreak, and one in the morning. Sometimes, however, the three masses are said directly one after the other. Both in the Greek and Roman churches, the manger, the holy family, etc., are sometimes represented at large. In the Church of England, and in the Protestant Episcopal Church, divine service is held always on Christmas day. In the former, the Athanasian Creed is required to be said or sung. If Christmas fall on a Friday, it is not to be a fast. In the Wesleyan Methodist Church in England the day is always observed, and generally in the Methodist Episcopal Church in the large cities.—Bingham, *Orig. Eccles.* bk. xx, ch. iv; Coleman, *Christian Antiquities*, ch. xxi, § 4; Dornier, *Person of Christ*, i, 178; Neander, *Life of Chrysostom* (Lond. 1845, 8vo), p. 340 (gives Chrysostom's *Christmas Homily*); Thompson, *Christmas and the Samaritania* (*Bibliotheca Sacra*, xii, 144); *North British Review*, viii, 202 (Christmas Literature); Siegel, *Christlich-kirchliche Alterthümer*, ii, 189; Cassel, *Weihnachten-Ursprünge, Bräuche, und Aberglauben* (Berl. 1861); Marbach, *Die heilige Weihnachtszeit* (Frankfort, 1865).

Christology, a word of comparatively recent origin in theological science, now used to denote the doctrine of or concerning Christ. Trench (*Study of Words*) finds it in use in one or two cases among the English divines of the 17th century. Owen gave the title *Χριστολογία* to his treatise on the Person of Christ (Owen's *Works*, Russell's ed. 1826, vol. xi). Fleming's *Christology* (Lond. 1705-8, 3 vols. 8vo), contains (1) general view of Christology; (2) concerning Christ as the Logos; (3) concerning Christ as he is Logos made man. The word has only been common in English theology within the last twenty years; and both the common use of the term and the special treatment of the subject are due to German theologians within the present century.

As to the scope of Christology, and its proper place in systematic theology, some writers include under it all that relates to the history, the person, and the work of Christ. Hase (*Evangel.-protest. Dogmatik*) makes Christology the second chief division of Dogmatics, and includes under it not only the person and work of Christ as commonly defined, but also Christ in the Church, the sacraments, etc. Coquerel (*Christologie*, Paris, 1858, 2 vols. 12mo) gives the following definition: "Une Christologie est une étude de la personne ou de la nature de Jésus Christ, de ses rapports avec Dieu et avec l'humanité, ainsi que de son œuvre en ce monde" (p. 1). Christology and Soteriology are closely related to each other. Some writers (e. g. Pelt) include the former under the latter. Kling includes under Christology both the person and the work of Christ; it is impossible, he says, to separate them, because Christ is the Saviour of men in virtue of what he is in his divine human person, and this person is necessary to the accomplishment of the work (Herzog, *Real-Encyclopädie*, ii, 688). The latest tendency appears to be to confine the word Christology more strictly to the doctrine of the person of Christ, leaving his work to be treated separately, though in close and vital connection with his person. (So Hagenbach, *History of Doctrines*; Shedd, *History of Doctrines*; Beck, *Dogmengeschichte*, etc.) In this article we confine ourselves to this narrower use of the term. The work of Christ (*ἔργον*, John iv, 34; xvii, 4, rendered in the Latin Church *munus, officium*) is treated under the heads **CHRIST, OFFICES OF; ATONEMENT; IN-**

TERCESSION; JUSTIFICATION; REDEMPTION; SAVIOUR.

The doctrine of the person of Christ is the central doctrine of Christianity. Our view of the whole character and issues of his redemption, and consequently our whole system of thought, both theological and ethical, depends upon our view of the person of Christ. The Church has always, with a sure instinct, understood the fundamental importance of this doctrine; but after the settlement of the early disputes by the Council of Chalcedon (see below), the discussion of other topics (e. g. sin, grace, and predestination), especially in the Western Church, became necessary, and Christology was apparently thrown into the background. So, at a later period, the discussions concerning the atoning work of Christ, and of the merits of his death, took precedence of that of his person. But all classes of orthodox theologians, in all communions, have held to the fundamental importance of Christology; and with the subsidence of what may be called minor discussions, Christology has of late assumed new prominence. The Puritan theology, no less than the so-called sacramental theology, holds that Christ is the centre of the Christian system. So Flavel: "The knowledge of Christ is the very marrow and kernel of all the Scriptures, the scope and centre of all divine revelations; both Testaments meet in Christ. The right knowledge of Christ, like a clew, leads you through the whole labyrinth of the Scriptures" (*Fountain of Life opened*, Sermon. 1). Liebner, a modern German divine, expresses the same thought in more scientific form (*Christologie*, Göttingen, 1849): "The question, What do you think of Christ: whose son is he? has become again, in its full force, the cardinal question of theology; theologians become pre-eminently Christologists; the stone which the (theological) builders had rejected has again, in reality, become the corner. And there arises again for our age, with peculiar adaptedness for apologetic purposes, that grand and majestic train of Christological truths, from the centre of which all is seen in true evangelical fulness, and in the proper evangelical order, up to the doctrine concerning the Triune and only true God, and down to every question connected with Christian ethics. And what here comes to light is, to say it in a few words, the system of all systems. The ancient Church has in sanctified and gigantic speculations laid the foundation; the Church of every succeeding period, when alive to her calling, has continued her efforts in the same direction, and its completion will require the efforts of the Church to the end of days. It is the system of the eternal divine thoughts that are laid down in the facts of revelation, and have been actualized most distinctly in Christ, the only-begotten Son, and which are reproduced by the believer, who by a living faith has received these facts within himself. We shall grow in the knowledge of Jesus Christ as *the truth*, in whom all riches of wisdom and knowledge are hid, and shall learn to understand and show more clearly that only those views of God, of creation, of the world, of men, of sin and grace, that have their root in the Christological truths, are tenable and victorious; in short, that Christianity embodies all true philosophy as well as all spiritual life." So, with reference to the theological conflicts of the age, especially in Germany, Dornier remarks: "It is gratifying to see how, in the long conflict between Christianity and reason, the point, on the handling of which the decision of the controversy turns, has become ever more and more distinct to the consciousness. The energies of all parties engaged in this conflict are gathered ever more and more around the person of Christ, as the central point at which the matter must be determined. The advantage of this is obvious as respects the settlement of this great strife; as in other things, so here, with the right statement of the question, the answer is already half found."

It is easy also to see that, in point of fact, all lies in the question whether such a Christ as dwells, if not always in the words, yet ever in the mind of the Church—one in whom the perfect personal union of the divine and human appeared historically—be necessary and actual. For let us suppose that philosophy could incontrovertibly establish and carry to the conviction of all thoughtful men that the person of a Christ in the sense above set forth is a self-contradiction, and therefore an impossibility, there would be no longer any conflict between Christian theology and philosophy, because with the person of Christ would be abolished the Christian theology, as well as the Christian Church altogether. And, conversely, were it brought under the recognition of philosophy that the idea of an historical as well as an ideal Christ is necessary, and were a speculative construction of the person of Christ once reached, it is clear that philosophy and theology, essentially and intrinsically reconciled, would thenceforward have a common work, or, rather, properly speaking, would have become one, and philosophy would consequently not have relinquished her existence, but confirmed it." Care is to be taken, however, not to run into the Romanist error of substituting the incarnation for the death of Christ, and of putting aside the work of the Holy Spirit, which is the special life of the present dispensation of grace. The "sacramental" system tends to this by its theory that Christ is present in "the body" in his Church, instead of in his Holy Spirit. See HOLY SPIRIT.

The Christology of the Old Testament will be treated under the article MESSIAH. See also the article CHRIST. We here discuss, briefly, I. The Christology of the N. T.; II. The Christology of the Church; III. The principal Christological heresies.

I. CHRISTOLOGY OF THE NEW TESTAMENT.—The older divines generally adduce the passages of the N. T. which treat of the person of Christ under the heads of (1) the Divinity of Christ; (2) the Humanity of Christ. The first class of passages adduced generally includes those which assert the pre-existence of Christ; then follow passages which ascribe divine functions and attributes to Christ; and, thirdly, those which give him divine titles (comp. Watson, *Theol. Institutes*, I, ch. xxv-xxxii; Hill, *Divinity*, book iii). The recent discussions as to the origin of the Gospels, and as to the so-called development of doctrine in the N. T., have made it more convenient to state the Christology of the N. T. under the following heads: (1) Christ's own testimony as to his person, with the doctrine taught by his acts, as recorded in the Gospels, (a) the Synoptists; (b) John; (2) The Christology of the apostles. Pyle Smith (*Scripture Testimony to the Messiah*, books iii, iv) makes the two heads following: 1. The Person of Christ, as taught in the Gospels and in our Lord's assertions and intimations; 2. The Person of Christ, as taught by the Apostles.

1. *The Synoptical Gospels, with the Testimony of Christ as to His Person* (see Dorner, *Person of Christ*, vol. i, p. 52 sq.; and Schaff, *Person of Christ the Miracle of History*, p. 115 sq.; both of whom are used in what follows).—(1.) Christ calls himself *υἱὸς Θεοῦ*, *Son of God*, and this in the highest sense, as implying the divinity of his own person (Matt. xxvi, 63; xvi, 16, 17). "He is not merely a son of God (as David, the kings of Israel, or the prophets were so styled); not merely one of the sons of God, but *The Son*, the only, the well-beloved (Matt. iii, 17; xvii, 5; xxii, 42-45). David's son is David's Lord. The phrase "Son of God" has three meanings in the synoptical Gospels: (1) What may be called the *physical* meaning (Matt. i, 23; Luke i, 35), because he has this name by nature, and on account of the mode of his birth. Of John it is said, "He shall be filled with the Holy Ghost from his mother's womb" (Luke i, 15), where the existence of the person of John precedes the filling with the Holy Ghost. But of Jesus it is said that, because he comes

into being through the power of the Holy Ghost (Luke i, 35), because he is conceived by the power of the Holy Ghost (Matt. i, 20), and so is from a divine essence, he has the name Son of God (Luke i, 35, 32); *God with us* (Matt. i, 23); God has in him redeemed his people (Luke ii, 11), yea, all mankind (Luke ii, 14, 31). And it is not one of the natures that has this name, but the entire person. But what this is by nature and in itself, that must it become through a truly human development. So far as he verifies and morally realizes this natural divine Sonship, we have (2) the *second* meaning of the phrase "Son of God," viz. the *ethical* sonship (Luke ii, 49, 52; iv, 3, 9). That he also, in this sense, perfectly represented the Sonship of God was, for the time preceding this public manifestation, attested by the attestation at his baptism (Matt. iii, 17). Without the physical sonship as a presupposition, the ethical would be impossible, whereby he is the Holy One of God, the sinless man, come to bring, personally in himself, the divine law into actual manifestation (Matt. v, 17); but even on that account, in a perfectly human way, in a progressive manifestation, advancing through conflict (Matt. xix, 16, 17; Mark x, 18; Luke iv, 13; xiii, 49, 50). So (3) without both the physical and the ethical, the *official* sonship would be impossible; which, conversely, is as naturally and necessarily the end of both the others as the ethical is of the physical. This third meaning of the phrase is, indeed, that commonly attributed to it, as a designation of the Messiah, by his contemporaries; but this will not justify us in reducing the Christian idea of the divine Sonship within the meagre limits of the Jewish ideas of the Messiah" (Dorner, vol. i, 52 sq.). See MESSIAH; SON OF GOD. (2.) Christ calls himself also, and most commonly, *υἱὸς ἀνθρώπου*, *Son of Man* (about eighty times in all the Gospels. See *Englishman's Greek Concordance*, s. v.). The use of this phrase clearly denotes his true and perfect manhood. "But why should Christ use it? Why call himself 'a man?' Is it not because, in the mind of Christ, the sense of human sonship was secondary to that of the divine? But why call himself, not simply man, or the son of a man, but 'the Son of Man?' Is it not because he, being divine, could not be simply a man, like others, imperfect, or even sinful? Does not the phrase, as thus used by Christ, indicate, not simply that there lies in him, of necessity, a perfect equality with others in what is essential to humanity, but also that, at the same time, he corresponds to the ideal conception of man?" (Dorner, l. c.). The expression, *the Son of Man*, while it places Christ, "in one view, on common ground with us, as flesh of our flesh and bone of our bone, already indicates, at the same time, that he is more than an ordinary individual; not merely a son of man, like all other descendants of Adam, but *the Son of Man*; the Man, in the highest sense; the ideal, the universal, the absolute Man; the second Adam, descended from heaven; the Head of a new and superior order of the race, the King of Israel, the Messiah" (Schaff, l. c.). So also Trench: "He was '*Son of Man*,' as alone realizing all which in the idea of man was contained, as the second Adam, the head and representative of the race—the one true and perfect flower, which ever unfolded itself, of the root and stock of humanity. Claiming this title as his own, he witnessed against opposite poles of error concerning his person—the Ebionite, to which the exclusive use of the title, 'Son of David,' might have led, and the Gnostic, which denied the reality of the human nature that bore it." *Notes on the Parables*, 9th Lond. ed. p. 84. (Matt. ix, 27; xv, 22; xii, 23; xxxi, 9; xxii, 41 sq., etc.)

"The appellation *the Son of Man* does not express, then, as many suppose, the humiliation and condescension of Christ simply, but his elevation rather above the ordinary level, and the actualization, in him and through him, of the ideal standard of human nature under its moral and religious aspect, or in its re-

lation to God. This interpretation is suggested grammatically by the use of the definite article, and historically by the origin of the term in Dan. vii, 13, where it signifies the Messiah, as the head of a universal and eternal kingdom. It commends itself, moreover, at once, as the most natural and significant, in such passages as, 'The Son of Man hath power to forgive sins' (Matt. ix, 6; Mark ii, 10); 'The Son of Man is Lord even of the Sabbath day' (Matt. xii, 8; Mark ii, 28); 'The Son of Man shall come in the glory of his Father'; 'The Son of Man is come to save' (Matt. xviii, 11; comp. Luke xix, 10). Even those passages which are quoted for the opposite view receive, in our interpretation, a greater force and beauty from the sublime contrast which places the voluntary condescension and humility of Christ in the most striking light, as when he says, 'Foxes have holes, and birds of the air have nests, but the Son of Man hath not where to lay his head' (Luke ix, 58); or, 'Whosoever will be chief among you, let him be your servant; even as the Son of Man came not to be ministered unto, but to minister, and to give his life a ransom for many' (Matt. xx, 27, 28). Thus the manhood of Christ, rising far above all ordinary manhood, though freely coming down to its lowest ranks with the view to their elevation and redemption, is already the portal of his Godhead.' (Schaff, *Person of Christ*, 118 sq.). Christ also, in many passages, calls himself simply "The Son," who stands to the Father in relations so peculiar that he never calls God "Our Father," as he directs his followers to do, but "My Father," from whom he received witness at the Transfiguration as the only and well-beloved Son. Among the acts ascribed to Christ in the synoptical Gospels (leaving out his miracles), one of the most significant is the forgiveness of sins, which he claims as his attribute as the "Son of Man" (Matt. ix, 2, 6; Luke, v, 20, 24); and which the Pharisees considered blasphemous, as well they might, if Christ had been simply man. In instituting the rite of baptism, he puts his own title, "Son," along with that of the Father and of the Holy Ghost. Further, he ascribes to himself a power infinitely beyond the human, and in this respect puts himself on an equality with God (Luke x, 22; Matt. xxviii, 18) (Dorner, l. c.). See *SON OF MAN*.

2. *John's Gospel*.—Here it is not necessary to dilate as with regard to the Synoptical Gospels, inasmuch as in St. John the Christological doctrine takes a more definite, if not more scientific form, and its teaching is not matter of dispute, at least to the same extent. John's Gospel teaches the pre-existence of Christ. "It ascribes to the Son not merely a moral, but an essential divinity; a not merely economical, but an ontological or metaphysical relation to the Father. It also teaches the true manhood of Christ, and its perfect historical reality; and, finally, that the Son, with the Father and the Holy Ghost, complete the end of creation in the reconciliation of man with God (John i, 1, 2, 14, 18 [comp. xvii, 2]; i, 32, 34, 51; iv, 6; v, 26, 27; vi, 58; viii, 16; x, 15, 38; xii, 84; xiv, 23; xix, 26, 30; xx, 17)" (Dorner, l. c.; Bloomfield, *Five Lectures on the Gospel of St. John* [1823, 12mo]; Sadler, *Emmanuel*, ch. i, § 3 [Lond. 1867, 8vo]).

3. *The Apostles*.—(1) St. Paul gives his testimony both as to the divinity and the humanity of Christ, his sonship and his Messianic work, as fully as St. John, especially setting forth the purely Christian idea of the Messiah (Rom. i, 8; v, 6-10; vi, 8-10; ix, 5; viii, 3; 1 Cor. ii, 7; viii, 6; x, 16; xv, 8-8 [comp. Acts xxii, 8-10]; 1 Cor. xv, 47 [1 Cor. xii, 18-18; 2 Cor. v, 16-19]; Gal. iv, 4, 5; Eph. i, 20-23; Phil. ii, 6-10; Col. i, 15-17, etc.; comp. Heb. i, 6, 10-12). The testimony of Paul is well stated by Sadler, *Emmanuel*, ch. i, § 2. See also Dorner, i, 51.

(2) The Epistle of James has been called an Ebionitish Gospel, as if its Christology were of a lower type. But James evidently presupposes the faith, as the

groundwork of the ethical teaching which is the main object of his epistle. He calls Christ "our Lord Jesus Christ, the Lord of Glory" (ii, 1), in which passage the royal function of Christ is expressly set forth, as also in his second coming to judgment (v, 7-9; comp. iv, 12).

(3) "The Discourses of Peter in the Acts, having for their object the establishment of the faith among unbelievers, all present the Christology as their centre-point, yet rather in the Old Testament form. For instance, the appellation 'Servant of God,' *παῖς Θεοῦ*, is taken from the prophets, and also the assertion of the anointing with the Holy Ghost. As respects particulars, the fortunes of Christ are, according to Peter, predicted by the prophets (Acts i, 16; ii, 16, 34; iii, 18, 22-26; x, 34; 1 Pet. ii, 7, 22-26; i, 10), as well as the outpouring of the Holy Ghost (Acts ii, 16, 28, 31; i, 16). Christ himself is anointed with the Holy Ghost and with power (x, 38); by God is made both Lord and Christ (ii, 36), as God hath glorified him (iii, 18), appointed him to be Prince and Saviour, the Judge of the living and the dead. Here everything, in accordance with the historical starting-point, proceeds from the humiliation of Christ; but the end at which this representation aims from the first is, that He is the Prince of Life (Acts iii, 15), whom the bonds of death could not hold; who has gone up into heaven (ii, 33; xxiv, 31), and is now Lord of all (x, 38-42)."

In the epistles of Peter it is not only the case, as in the Acts, that the life and death of Christ are spoken of as fulfilling the O. T., but the O. T. dispensation is made to look to and depend on Christianity (1 Pet. i, 10, 11). "In the prophets the *πνεῦμα Χριστοῦ* was operative; it wrought in them its own preparation, foretelling the grace in Christ, his sufferings, and the glory that should follow. In Christ are we chosen from eternity (1 Pet. i, 2); we are eternally contemplated by the Father as standing in the sanctification of the spirit; as destined for obedience and for purifying, through the blood of Jesus Christ (1 Pet. i, 20). As respects the historical appearance of Christ, there is ascribed to him true manhood (1 Pet. iii, 18; iv, 1). Thus the epistle is as far from Docetism as from Ebionitism.

Jude places Christ along with the Father in the formula of salutation (ver. 2) and in the doxology (ver. 24, 25); the being kept in the true and most holy faith (ver. 20) is a being preserved in Christ Jesus (ver. 1, 8) and in the Holy Ghost (ver. 20). The persons whom Jude opposes are not merely such as have practically swerved from the right way (ver. 8, 15); they are also teachers of error, because they deny the only God and our Lord Jesus Christ (ver. 4).

The *Second Epistle of Peter* has more definitely to do with errorists, especially the "heretics" who "deny the Lord that bought them" (ii, 1). To Christ belong *μεγαλειότης* (i, 16), *δόξα και ἀπείρη* (i, 3); he is the beloved Son of God, in whom he is well pleased (i, 17); he is our *σῶτηρ* (i, 1, 11, etc.), our Lord (i, 2, 8, etc.), who hath an everlasting kingdom (i, 2), and whose exaltation is not taught in cunningly devised myths, but is attested by the prophets and eye-witnesses (i, 16, 18; iii, 2) (Dorner, i, 72).

On the Christology of the N. T., see, besides the works already cited, Gess, *Lehre von der Person Christi* (Basel, 1856, 8vo); Sadler, *Emmanuel* (Lond. 1867, 8vo, especially ch. 1); Schaff, *Apostolic Church*, § 148; Goodwin, *Christ the Mediator* (Plymouth, 1819, 8vo); Hooker, *Eccles. Polity*, bk. v, 51; Waterland's *Works* (12 vols.), vol. iv; Pyle Smith, *First Lines of Theology*, bk. ii, chap. iv; Gurney, *Biblical Notes to Confirm the Deity of Christ* (Lond. 1880, 8vo), and the writers generally on the Trinity, on the Divinity of Christ, and the Life of Christ. Prof. Beysechlag, of Halle, in his *Christologie des N. T.* (Berlin, 1866, 8vo), attempts to show that the N. T. represents Christ as divine, but not as pre-existent, or equal with the Father.

II. CHRISTOLOGY OF THE CHURCH. The doc-

trine of the person and work of Christ formed the main topic of theological speculation and controversy in the early Church, and is again the most prominent religious problem of modern times. The peculiarity of his Person consists in the perfect union of the divine and human which constitutes him the Mediator between God and man, and the Saviour of the fallen race. This has always been the faith of the Christian Church, but in every age it has had to encounter a new enemy, or the old enemy in ever-varying phases, and to achieve new triumphs in the refutation of error and the vindication of truth. The orthodox Christology is derived from the New Testament, especially from St. Paul and St. John (see above), and has gradually been unfolded in sharp conflict with a large number of Christological heresies, each serving to elicit a clearer view of some particular aspect either of the divinity or of the humanity of Christ, or of the union of the two natures. "The person of Jesus Christ in the fulness of its theanthropic life cannot be exhaustively set forth by any formulas of human logic. Even the imperfect, finite personality of man has a mysterious background that escapes the speculative comprehension; how much more, then, the perfect personality of Christ, in which the tremendous antithesis of Creator and creature, infinite and finite, immutable, eternal Being and changing temporal becoming, are harmoniously conjoined! The formulas of orthodoxy can neither beget the faith nor nourish it; they are not the bread and the water of life, but a standard for theological investigation and a rule of public teaching" (Schaff).

The *Orthodox Christology* is essentially the same in the Greek, Latin, and evangelical Protestant churches. It forms (like the doctrine of the Trinity, so closely connected with it) one of the fundamental bonds of union between the great divisions of Christendom. Yet there have been some new features brought out since the Reformation. We subdivide it into oecumenical, scholastic, and evangelical.

1. THE OECUMENICAL OR CATHOLIC CHRISTOLOGY was prepared in the ante-Nicene age (see Bull's *Defensio fidei Nicenae*), and fully matured in the Nicene and post-Nicene age. The doctrine of the person of Christ, in inseparable connection with the doctrine of the Holy Trinity, was the chief problem of theological speculation from the third to the middle of the fifth century, and was settled by the four great oecumenical councils of Nicæa (325), Constantinople (381), Ephesus (431), and Chalcedon (451). The first two were mainly concerned with the assertion of the strict divinity of Christ against its partial denial by Arianism and Semi-Arianism. The last two set forth the relation of the divine and the human nature of the one person against the opposite extremes of Nestorianism and Eutychianism. The decree of the Council of Ephesus was more negative, a condemnation of Nestorius. But the Council of Chalcedon gave a clear and full statement of the positive doctrine of Christ's person, and summed up the final result of those deep, earnest, and violent Trinitarian and Christological controversies which had agitated the Church so long.

The Christological symbol of the Chalcedonian or fourth oecumenical Synod of 451 ranks next in authority to the Apostles' and Nicene Creeds, and has not been superseded to this day. "It does not aspire to comprehend the Christological mystery, but contents itself with setting forth the facts and establishing the boundaries of orthodox doctrine. It does not mean to preclude further theological discussion, but to guard against such erroneous conceptions as would mutilate either the divine or the human in Christ, or would place the two in a false relation. It is a lighthouse to point out to the ship of Christological speculation the channel between Scylla and Charybdis, and to save it from stranding upon the reefs of Nestorian Dyophysitism, or of Eutychian Monophysitism. As the Nicene doctrine of the Trinity stands midway be-

tween Tritheism and Sabellianism, so the Chalcedonian formula strikes the true mean between Nestorianism and Eutychianism. But it contents itself with setting forth, in clear outlines, the final result of the theanthropic process of incarnation, leaving the study of the process itself to scientific theology" (Schaff).

The Chalcedonian symbol is as follows:

"Following the holy fathers, we unanimously teach one and the same Son, our Lord Jesus Christ, complete as to his Godhead and complete as to his manhood, truly God and truly man, of a reasonable soul and human flesh subsisting; consubstantial with the Father as to his Godhead, and consubstantial also with us as to his manhood; like unto us in all things, yet without sin; as to his Godhead begotten of the Father before all worlds, but as to his manhood, in these last days born, for us men and for our salvation, of the Virgin Mary, the mother of God; one and the same Christ; Son, Lord, Only-begotten, known in (*α*) two natures (*by duo personarum, in duabus naturis*, or, with the present Greek text, *α* *ἁγιωσύνης*, of two natures, which signifies essentially the same thing), without confusion (*ἀσπρίμιον*), without conversion (*ἀτρέπτος*), without severance (*ἀδιασπῆτος*), and without division (*ἀχωριστός*); the distinction of the natures being in no wise abolished by their union, but the peculiarity of each nature being maintained, and both concurring in one person and hypostasis. We confess not a Son divided and sundered into two persons, but one and the same Son, and Only-begotten, and God-Logos, our Lord Jesus Christ, even as the prophets had before proclaimed concerning him, and he himself hath taught us, and the symbol of the fathers hath handed down to us." See CHALCEDON.

The same doctrine is set forth in a more condensed form in the second part of the so-called Athanasian Creed, which originated probably in the school of Augustine during the fifth century, and is the third of the oecumenical symbols:

"Furthermore, it is necessary to everlasting salvation that we believe also rightly in the incarnation of our Lord Jesus Christ. Now the right faith is, that we believe and confess that our Lord Jesus Christ, the Son of God, is God and man; God, of the substance of the Father, begotten before the worlds; and man, of the substance of his mother, born in the world. Perfect God; perfect man, of a reasonable soul and human flesh subsisting. Equal to the Father as touching his Godhead; inferior to the Father as touching his manhood. And although he is God and man, yet he is not two, but one Christ. One, not by conversion of the Godhead into flesh, but by assumption of the manhood into God. One altogether, not by confusion of substance, but by unity of person. For as the reasonable soul and flesh is one man, so God and man is one Christ, who suffered for our salvation," etc.

(For an analysis and criticism of this oecumenical or Catholic Christology, see Shedd's *History of Christian Doctrines*, i, 899 sq.; Schaff's *Church History*, iii, 747-762, and the respective sections of the works of Baur, Dorner, and others quoted below.)

2. THE SCHOLASTIC CHRISTOLOGY of the Middle Ages is represented mainly by Anselm (the author of *Cur Deus homo*, with his epoch-making theory of the *attonement*; see ANSELM), Peter the Lombard, and Thomas Aquinas. It differed itself, as regards the person of Christ, to a dialectical analysis and defense of the old Catholic dogma, with some unfruitful speculations on minor points, especially on the abstract question whether Christ would have become incarnate if the Fall had not taken place. Thomas Aquinas decided for the former, as the safer formula (*si homo non peccasset, Deus incarnatus non fuisset*); Ruprecht of Deutz, Duns Scotus, and Alexander Hales for the other view. This question has recently been taken up again and ably discussed by J. Müller against, Dorner and Lieber for, the doctrine of Incarnation without a Fall. See *Brit. and For. Evang. Review*, Jan. 1861, art. iv.

3. THE PROTESTANT OR EVANGELICAL CHRISTOLOGY. The churches of the Reformation, both Lutheran and Reformed or Calvinistic, adopted in their confessions of faith, either in form or in substance, the three oecumenical Creeds (the Apostles', the Nicene, and the Athanasian), and with them the ancient Catholic doctrine of the Trinity and Christ's divine-human character and work, which doctrine is, in fact, the sum and substance of those symbols. We quote from the principal Protestant confessions:

The *Augsburg Confession* of the Lutheran Church, Art. III. De Filio Dei:

"*Rom docent, quod Verbum, hoc est, Filius Dei, assumptis humanam naturam in utero beatae Mariae virginis, ut sint duae naturae, divina et humana, in unitate personae inseparabiliter conjunctae, unus Christus, vero Deus, et vero homo, natus ex Virgine Maria, vero passus, crucifixus, mortuus et sepultus, ut reconciliaret nobis Patrem, et hostia esset non tantum pro culpa originalis, sed etiam pro omnibus actualibus hominum peccatis.*"

The *Thirty-nine Articles of the Church of England*, Art. II. Of the Word or Son of God, which was made very man :

"The Son, which is the Word of the Father, begotten from everlasting of the Father, the very and eternal God, and of one substance with the Father, took man's nature in the womb of the blessed Virgin, of her substance: so that two whole and perfect natures, that is to say, the Godhead and manhood, were joined together in one Person, never to be divided, whereof is one Christ, very God and very man; who truly suffered, was crucified, dead, and buried, to reconcile his Father to us, and to be a sacrifice not only for original guilt, but also for actual sins of men."

The *Westminster Confession*, which gives the clearest and strongest expression to the faith of the strictly Reformed or Calvinistic churches, thus states the doctrine of Christ's person in ch. viii, § 2 :

"The Son of God, the second person in the Trinity, being very and eternal God, of one substance and equal with the Father, did, when the fulness of time was come, take upon him man's nature, with all the essential properties and common infirmities thereof, yet without sin, being conceived by the Holy Ghost in the womb of the Virgin Mary, of her substance: so that two whole, perfect, and distinct natures, the Godhead and the manhood, were inseparably joined together in one person, without conversion, composition, or confusion. Which person is very God and very man, yet one Christ, the only Mediator between God and man."

The 2d Article of the Methodist Episcopal Church is the same as that of the Church of England, except that the words "begotten from everlasting of the Father," and "of her substance," are omitted (probably by typographical error).

On this general basis of the Chalcedonian Christology, and following the indications of the Scriptures as the only rule of faith, the Lutheran and Reformed churches have built some additional views or developed new aspects of Christ's person. Protestantism cannot consistently adopt any doctrinal or disciplinary decisions of the Church as strictly infallible and as an absolute *finale*, but simply with the reservation of the right of further research, and with the understanding of a constant progress in theology—not, indeed, of a progress beyond Christ and the Bible, but in the ever-deepening apprehension and subjective appropriation of Christ and his infallible word. There is a characteristic difference between the Christology of the Lutheran and that of the Reformed Confessions which affects the whole system. Upon the whole, we may say that the former has a leaning towards the Eutychian confusion of the divine and human nature, the latter to the Nestorian separation; yet both distinctly disown the Eutychian and Nestorian heresies. (On the difference between the Lutheran and Reformed Christology, compare especially the very able and acute treatise of Schneckenburger, *Die orthodoxe Lehre vom doppelten Stande Christi nach lutherischer und reformirter Fassung* [Pforzheim, 2d ed. 1861]; also his *Vergleichende Darstellung d. lutherischen u. reformirten Lehrgriffe*, edited by Güder [Stuttgart, 1855].) The progress made in Christology since the Reformation within the limits of the Chalcedonian orthodoxy, or, at all events, not in conflict with it, relates to the communion of the two natures, and to the states and the offices of Christ.

(a) The doctrine of the *communicatio idiomatum*, the communication of attributes or properties of one nature to the other or to the whole person. The beginning of it may be found in Cyril of Alexandria and John of Damascus; but it has been much more fully developed by the Lutheran Church in the interest of her peculiar tenet of the ubiquity of Christ's body, in order to support Luther's eucharistic theory of consubstantiation so called. It was embodied in the *Formula Concordia*, but has never been adopted in the Re-

formed or Calvinistic churches. The Lutheran divines distinguish three kinds of the *communicatio idiomatum*, which is derived from the *communio naturarum*: (1) *genus idiomaticum* (or *ιδιοποιητικόν*), whereby the properties of one nature are transferred and applied to the whole person (Rom. i, 8; 1 Pet. iii, 18; iv, 1); (2) *genus copulematicum* (*κοινοποιητικόν*), whereby the *ἀποτελισματα*, i. e. the redemptory functions and actions which belong to the whole person are predicated only of one or the other nature (1 Tim. ii, 5 sq.; Heb. i, 2 sq.); (3) *genus auctematicum* (*αὐχμητικόν*) or *majestaticum*, whereby the human nature is clothed and magnified by the attributes of the divine nature (John iii, 18; v, 27; Matt. xxviii, 18, 20; Rom. ix, 5; Phil. ii, 10). Under this head the Lutheran Church claims a certain ubiquity or omnipresence for the body of Christ, on the ground of its personal union with the divine nature; yet she makes this ubiquity dependent on the will of Christ, who can be present with his whole person wherever he pleases to be or has promised to be. But for this very reason the Reformed divines reject the whole doctrine of the *communicatio idiomatum*, and pronounce the *propositiones idiomaticae* to be mere figures of speech (*ἀλλοιωσις*, a rhetorical exchange of one part for another). See COMMUNICATIO IDIOMATUM.

(b) The doctrine of a twofold state of Christ—the state of *humiliation* and the state of *exaltation*. This is based upon Phil. ii, 5-9, and is no doubt substantially true. The *status exinanitionis* (*humiliationis*) embraces the supernatural conception, birth, circumcision, education, earthly life, passion, death, and burial of Christ; the *status exaltationis* includes the resurrection, ascension, and the sitting at the right hand of God. As to the descent into hell, or Hades rather, the Lutheran and the Reformed churches differ according to their different conceptions of this difficult article in the Apostles' Creed. The Lutheran Confessions, regarding it as a triumph over hell, make the *descensus ad inferos* the first stage of the *status exaltationis*, while the Reformed Confessions view it as the last stage of the *status exinanitionis*. It is properly the turning-point from the one state to the other, and thus belongs to both. The Lutheran Creed, moreover, refers the two states only to the human nature of Christ, regarding the divine as not susceptible of any humiliation or exaltation. The Reformed symbols refer them to both natures, so that Christ's human nature was in a state of humiliation as compared with its future exaltation, and his divine nature was in the state of humiliation as to its external manifestation (*ratione occultationis*). With them the incarnation itself is the beginning of the state of humiliation, while the Lutheran symbols exclude the incarnation from the humiliation. Between the Lutheran divines of Tübingen and Gießen there was a controversy in the 17th century about the question whether Christ in the state of humiliation entirely abstained from the use of his divine attributes (*κένωσις*), or whether he used them secretly (*κρυψίως*). The divines of Gießen defended the former, those of Tübingen the latter view. Both schools were agreed as to the possession (*κτῆσις*), and differed only as to the use (*χρησις*), of the divine attributes. This controversy has been renewed, in a modified form, among recent German divines. See KENOSIS.

(c) The threefold office of Christ. (1) The *prophetic* office (*munus, or officium propheticum*) includes teaching and the miracles of Christ. (2) The *priestly* office (*munus sacerdotale*) consists in the satisfaction made for the sins of the world by the death on the cross, and in the continued intercession of the exalted Saviour for his people (*redemptio et intercessio sacerdotalis*). (3) The *kingly* office (*munus regium*), whereby Christ founded his kingdom, defends his Church against all enemies, and rules all things in heaven and on earth. The old divines distinguish between the reign of nature (*regnum naturae sive potentiae*), which

embraces all things; the reign of grace (*regnum gratiæ*), which relates to the church militant on earth; and the reign of glory (*regnum gloriæ*), which belongs to the church triumphant in heaven.

4. *Modern Christological speculations.* Upon the whole, the orthodox doctrine has laid the main stress upon the divine element in Christ, and left the human element more or less out of sight, without ever denying it. Rationalism, on the contrary, developed the human element to the exclusion and denial of the divine. When evangelical theology revived after the reign of Rationalism in Germany, it endeavored to do justice to both elements, and so to reconstruct the old Christology as to set forth the sinless, yet truly human character of Christ from his infancy to full maturity, without prejudice to his deity. Schleiermacher opened a new era of Christological speculation, but, forsaking the Chalcedonian basis of two natures in one person, he discarded the proper idea of the incarnation as the union of the eternal personal Logos with human nature, and, after all, presented Christ merely as a perfect model man without sin, in whom God dwelt in a peculiar manner, as he did in no other man before or since. This indwelling of God is with him only a principle, a power of life, and not the second person of the Holy Trinity. Schleiermacher's view of the Trinity is essentially Sabellian. From him and from Hegel's philosophy proceeded two opposite currents of Christological speculation—a humanitarian, negative and infidel, culminating in Strauss and Renan (see below, under the second division, No. 15), and an evangelical, positive and in the main orthodox, which labors to reconcile the old faith of the Church in the God-Man with the demands and forms of modern thought. The principal evangelical writers on the Christological problem, under its latest phases, are Dorner, Lange, Goeschel, Liebner, Martensen, Thomasius, Gess, Kahnis, Ebrard. Some of these, especially Thomasius, Gess, and Godet (Commentary on John), have strained the Pauline idea of the *kenosis*, the self-limitation, self-renunciation of the Logos, far beyond former conceptions, even to a partial or entire self-emptying of the divine essence and suspension of the inner Trinitarian process during the earthly life of Christ, while others restrict the *kenosis* to the laying aside of the divine form of existence or divine dignity and glory. Dorner opposes these modern Kenotics or Kenosists (*Kenotiker*) as a new sect of Theopaschites and Patripassians, and he assumes a gradual ethical and vital unification of the pre-existent Logos and the human nature, by a condescension of the former and an elevation of the latter. This view leaves room for the growth of the Messianic consciousness, but makes the incarnation itself a process of growth which was not completed till the resurrection, or at least till the baptism of Christ.

These modern inquiries, however, earnest, profound, and valuable as they are, have not yet led to definite and generally-accepted results. English and American theology have not been affected by them to any considerable extent; Dr. Shedd, in his able though incomplete *History of Christian Doctrine*, even ignores them altogether, and pronounces the Chalcedonian symbols the *ne plus ultra* of Christological knowledge, "beyond which it is probable the human mind is unable to go in the endeavor to unfold the mystery of Christ's complete person" (i, 403). But there certainly have been very important advances made within the last thirty years in the critical history of the life of Christ, and in the manifold exhibition of his perfect humanity, which itself is an overwhelming proof of his divinity. (For a review of the recent Christological speculations, see Dorner, in his large work on the history of Christology, ii, 1260 sq., Engl. trans., div. 2d, iii, 100 sq., and in several dissertations upon the immutability of God in the *Jahrbücher für Deutsche Theologie*, 1856 and 1858; also Woldemar Schmidt, *Das*

Dogma vom Gottmenschlichen, mit Beziehung auf die neuesten Lösungsversuche der Gegensätze [Leipzig, 1865].)

III. CHRISTOLOGICAL HERESIES. The numerous Christological errors may be divided into three classes, according as they relate either to the divine or to the human nature of Christ, or to the union of the two. Ebionism, Socinianism, and Rationalism, in its various shapes, deny, either in whole or in part, the divinity of Christ; Gnosticism, Manichæism, Apollinarianism, deny, more or less, his real humanity; while Nestorianism, Eutychianism, Monophysitism, and Monothelitism admit the Godhead and manhood of Christ, but place them in a false relation to each other. We present them here in chronological order.

1. EBIONISM (see that article), the earliest Christian heresy, was essentially Jewish, and looked upon Christianity merely as a perfected Judaism, upon the Gospel as a new law, and upon Christ as a second Moses. Origen derived the name of the sect from the poverty of their doctrine of Christ (עִיּוֹנִיּוּת, *poor*); but they regarded themselves as the genuine followers of the poor Christ. They held that Jesus was, indeed, the promised Messiah, the Son of David, and the supreme lawgiver of the Church; yet a mere man, the son of Joseph and Mary, and that his death had no atoning efficacy. With this were closely connected other heresies. The *pseudo-Clementine Homilies* (see CLEMENTINES) differ from the ordinary Ebionism by peculiar speculative and semi-Gnostic ideas, and teach that Christ was the last and highest representative of the primitive religion which appeared in the seven pillars of the world, Adam, Enoch, Noah, Abraham, Isaac, Jacob, Moses, and Christ. These are, in reality, only different incarnations of the same Adam, or primitive man, the true prophet of God. Christianity and Moses are identical, and both coincide with the religion of Adam. Whether a man believe in Moses or Christ is all the same, provided he blaspheme neither. Christianity is an advance only in extending this primitive religion to the Gentiles (comp. Schliemann, *Die Clementinen und der Ebionismus*, 1844, p. 362-552).

2. GNOSTICISM, which flourished in the second century (see article), varied in its Christology according to its numerous schools of Cerinthus, Basilides, Valentine, Marcion, etc., and generally dealt more in vague notions and speculative fancies than in solid, clearly-defined doctrines and arguments. But its Christology was a radical denial of the mystery of the incarnation, and therefore anti-Christian, according to the criterion of John (John i, 4), although from a view the very opposite of Ebionism. While the latter denied the divinity of Christ, Gnosticism was *doctæstic* (hence *Doctetism*), i. e. it denied the realness of Christ's human nature, and resolved it into an empty show and deceptive appearance (*δόκησις, φάντασμα*), or a transient vision, after the manner of the Indian Mythology. The real Christ, or Saviour, is one of the æons or divine powers, which either assumed this spectral form of humanity, or united himself temporarily, at the baptism in Jordan, with the man Jesus of Nazareth, to forsake him again at the passion. But he entered into no real contact with a human body which, as a part of matter (*ὄλη*), was regarded as essentially evil and antagonistic to God; he was not actually born, he did not suffer and die, nor rise again. He appeared like a meteor from the sky, to disappear again. Reduced to a modern philosophical conception, the Gnostic Christ is, in the end, nothing more than the ideal spirit of man himself, the Christ of Strauss and modern pantheism. Valentinus, the most ingenious among the Gnostics, distinguished the *ἀνω Χριστός*, or heavenly Christ; the *σωτήρ*, or Jesus; and the *κύριος Χριστός*, the Jewish Messiah, who passed through the body of Mary as water through a pipe, and was crucified by the Jews, although, having no material body, he did not actually suffer. With him Soter, the proper re-

deemer, united himself at the baptism in Jordan, to announce his divine gnosis on earth, and lead spiritual persons to perfection.

3. The MANICHEAN system, which we know best from the writings of St. Augustine (who himself belonged to the sect for nine years, and was thereby better able to refute it), was essentially Gnostic and Doceticist, and by its perverted view of body and matter as essentially evil, wholly excluded the idea of an incarnation of God. The Manichæans held that the apostles corrupted and falsified the real teachings of Christ, but that Mani, the promised Paraclete, has restored them. Traces of the Manichæan heresy run through a number of sects of the Middle Ages.

4. ANTE-NICENE UNITARIANISM, or MONARCHIANISM.—The Antitrinitarians of the third century must be divided into two distinct classes: (a) The *rationalistic* or *dynamic* Monarchians denied the divinity of Christ, or explained it as a mere power (*δύναμις*), although they generally admitted his supernatural generation by the Holy Spirit. To these belong the ALOGIANS, THEODOTUS and the THEODOTIANS, ARTEMON and the ARTEMONITES, and PAUL OF SAMOSATA. (See the several articles.) (b) The *Patripassians* (so called first by Tertullian) held, in connection with their idea of the divine unity or monarchy, the doctrine of the divinity of Christ, but they sacrificed his independent personality to the divinity, and merged it into the essence of the Father, so that the Father was asserted to have suffered and died on the cross, which is absurd. This school was represented by PRAXEAS, NOËTUS, CALLISTUS (Pope Callixtus I), BERYLLUS of Bostra, and, in connection with a very original and ingenious doctrine of the Trinity, by SABELLIUS, all of the third century. (See the separate articles on these heretics, and the relevant sections of the Doctrine histories of Münscher, Hagenbach, Neander, Baur, Beck, etc.)

5. ARIANISM, so called after Arius, presbyter of Alexandria († 336), shook the Church to its very base during the greater part of the fourth century, and called forth the first two œcumenical councils, viz. Nicæa, 325, and Constantinople, 381. Its doctrine was, that Christ is a middle being between God and man, a sort of demi-god, who pre-existed before this world, and who created this world, yet was himself created out of nothing, the first creature of God, and consequently of a different essence (*ἕτερο-ουσία*), and not eternal (*κτίσμα ἐξ οὐκ ὄντων, ἢν ποτε ὄτε οὐκ ἦν*). Against this view the Nicene Creed asserts that Christ is "God of God, Light of Light, very God of very God, begotten, not made, being of one substance (*ὁμο-ουσία*) with the Father." (On the history of ancient and modern Arianism and its literature, comp. the articles ARIANISM in vol. i, p. 888-893; ATHANASIUS, i, 505-508; also Schaff's *History of the Christian Church*, iii, 616-670.)

6. SEMI-ARIANISM is an inconsistent middle doctrine between the Arian heresy and the Athanasian or Nicene orthodoxy. It asserts the similarity of Christ to the Father (*ὁμο-ουσία*—a very elastic term), in opposition to the Nicene co-equality (*ὁμο-ουσία*) and the Arian difference of substance (*ἕτερο-ουσία*). It was a strong political church party, under the emperor Constantius († 361), and was led by Eusebius, bishop of Nicomedia, but it disappeared before the second œcumenical council in 381, which marked the final downfall of Arianism within the limits of the Roman empire, while it continued to linger, without vitality, among the barbarians till the seventh century.

7. APOLLINARIANISM is a partial denial of the humanity, as Arianism of the divinity of Christ. Apollinaris the younger, bishop of Laodicea (died about 390), otherwise orthodox, and highly esteemed for his learning and piety, ascribed to Christ a human body (*σῶμα*) and a human (animal) soul (*ψυχὴ ἀλογος*), but not a human spirit or reason (*ψυχὴ λογικὴ*, anima rationalis, *νοῦς*, *πνεῦμα*); putting the divine Logos in the place

of the human reason. He wished to secure a true incarnation and vital unity of the eternal Word with the human nature, but at the expense of the most important constituent in man, and thus he reached, instead of the idea of the God-man, *θεῶν θρωσκός*, only the idea of a *θεὸς σαρκοφόρος* (the very opposite of the Nestorian *ἀνθρώπος θεοφόρος*). This heresy was condemned by a council at Alexandria in 382. (For particulars, see art. APOLLINARIUS, vol. i, p. 296, 297; and Schaff, *Church History*, vol. iii, p. 708-714.)

8. NESTORIANISM, from Nestorius, patriarch of Constantinople, who died in exile about A.D. 440, had its roots in the Antiochian school of theology, of which Nestorius was a pupil, and agitated the Church with great violence from 428-451. Nestorius believed that Christ was fully God and fully man, but he put the two natures only into an external mechanical relation to each other (*συνάρηα*, affinity, intercourse, attachment, as distinct from *ἕνωσις*, true interior union). He pressed the distinction of the two natures at the expense of the unity of the person. Hence he took great offence at the term *Mother of God* (*θεοτόκος*, *Deipara*, *Mater Dei*), which then began to be applied to the Virgin Mary, and has since passed into the devotional and theological vocabulary of the Greek and Latin Church. He denounced the term as heathenish, absurd, and blasphemous, since the eternal Godhead could not be born in any sense whatever. This gave rise to the Nestorian controversy, in which the violent Cyril of Alexandria took the most prominent part, as the champion of the honor of the Holy Virgin and the doctrine of a real incarnation, although with a decided leaning to the opposite extreme of Monophysitism. See art. CYRIL OF ALEXANDRIA. Nestorius was condemned by the third œcumenical council, held at Ephesus in 431, and deposed from the sacerdotal office; but his name and doctrine are perpetuated to this day in the sect of the Nestorians. (See the articles NESTORIUS and NESTORIANS, and the literature below.)

9. EUTYCHIANISM, so called from Eutyches (q. v.), an aged presbyter and archimandrite of Constantinople (died soon after 451), is the exact counterpart of Nestorianism, and presents the consistent development of the Alexandrian school of theology as opposed to the Antiochian. Eutyches likewise held Christ to be the God-man as well as Nestorius, but he pressed the unity of person to the exclusion of the distinction of the two natures. He denied that two natures could be spoken of *after* the incarnation. The human nature was absorbed in the divine by that act, or deified by the personal Logos, so that even his body was unlike ours, of a heavenly character and substance (*σῶμα ἀνθρώπου*, but not a *σῶμα ἀνθρώπινον*). Hence it was proper to say, God is born, God suffered, God was crucified and died. The strongest opponent of this view was Theodoret, the well-known Church historian, a friend of Nestorius. At first Eutychianism triumphed at the Robber Synod, so called, which was held at Ephesus A.D. 449, under the lead of the violent patriarch Dioscurus of Alexandria, who inherited all the bad and none of the good qualities of his predecessor Cyril. But the fourth œcumenical council, held at Chalcedon (near Constantinople) A.D. 451, reversed this decision, condemned the Eutychian doctrine as heresy, and set forth in clear and precise terms the orthodox doctrine of the person of Christ, maintaining with equal decision the distinction of natures against Eutyches, and the unity of person against Nestorius. (See sub. I, 1. above.) In this triumph of the orthodox faith, Leo I, bishop of Rome, had an important share, and his dogmatic letter to Flavian of Constantinople was made the basis of the synodical decision.

10. MONOPHYSITISM is only a modification and continuation of Eutychianism. As the term indicates, the Monophysites, although they rejected the Eutychian notion of an absorption of the human nature into the

divine, nevertheless held firmly to the doctrine of but one nature in Christ. They conceded, indeed, a composite nature (*μία φύσις σύνθετος* or *μία φύσις διττή*), but not two natures. They assumed a diversity of qualities without corresponding substances, and made the humanity of Christ a mere accident of the immutable divine substance. Their liturgical shibboleth was, *God has been crucified*, which they introduced into the trisagion (*ἄγιος ὁ θεός, ἄγιος ἰσχυρός, ἄγιος ἀθάνατος, ὁ σταυρωθεὶς δι' ἡμᾶς, ἐλέησον ἡμᾶς*—an extension of the seraphic ascription, Isa. vi, 8). Hence they were also called *THEOPASCITES* (*θεοπασχίται*). The Monophysite controversies commenced soon after the Council of Chalcedon, which failed to pacify the Church, and convulsed the East, from patriarchs and emperors down to monks and peasants, for more than a hundred years. The detailed history will be presented in a special article. The fifth oecumenical council, held at Constantinople A.D. 553, which was to end these violent strifes, resulted in the condemnation of the Antiochian (Nestorian and semi-Nestorian) theology, and a partial victory of the Alexandrian Monophysitism, as far as it could be reconciled with the symbol of Chalcedon. Notwithstanding this concession, the Monophysites, like their antipodes, the Nestorians, continued as separate sects in hostile opposition to the orthodox Greek Church. They are divided into separate branches, the *Jacobites* in Syria, the *Copts* in Egypt, the *Abyssinians*, the *Armenians*, and the *Maronites*. (See the respective articles.)

11. The *MONOTHELITE* controversy is a continuation of the Nestorian and Eutychian controversies, and relates to the question whether Christ had but one will (*θέλημα*) or two, a divine and a human. Nestorianism, of course, required two wills as a complement of two natures, while the Monophysites taught but one will. The emperor Heraclius proposed a compromise formula—one divine human energy (*μία σταυρωθεὶς ἐνέργεια*), but it was opposed in the West. The sixth oecumenical council in Constantinople, A.D. 680, settled the dispute by teaching the doctrine of two wills harmoniously co-operating, the human will following the divine (*ὄμο φύσικὰ θέληματα, ὄχι ὑπεναντία, ἀλλ' ἐπόμουν τὸ ἀνθρώπινον αὐτοῦ θέλημα καὶ ὑποτασσόμενον*). Thus Monothelism was condemned, but was adhered to by the Maronites on Mount Lebanon till the time of the Crusades. The Monophysites (q. v.) are all Monothelites (q. v.).

12. The *ADOPTIAN* controversy arose in Spain toward the close of the eighth century, and turned upon the question whether Christ, according to his human nature, was the Son of God by nature (*naturaliter*), or only by adoption (*nuncupative*). The latter doctrine was condemned as heretical in a synod at Frankfurt on the Maine, 794. (See article *ADOPTIANISTS*, vol. i, 76, and *ELIPANDUS* of Toledo and *FELIX* of Urgel.)

13. *SOCINIANISM*, a system of ultra and pseudo Protestantism, founded by Lilius Socinus (died 1562) and his nephew Faustus Socinus (died 1604), returned almost to the poor and meagre Christology of the Ebionites and Nazarenes, and added to it the heathenish notion of an apotheosis of Christ after his death. It teaches that Jesus of Nazareth, though supernaturally conceived, was a mere man, but favored by God with extraordinary revelations, elevated to heaven, deified in reward of his holy life, and intrusted with the government of the Church which he founded. It substitutes for an incarnate divinity a created and delegated divinity. Invocation of Christ is allowed, but not enjoined; it is an adiaiphoron. See *SOCINIANS*; *SOCINUS*.

14. Modern *UNITARIANISM* in England and America has no uniform and settled belief concerning the person of Christ, and branches out into two very different tendencies, the conservative, represented by Channing, which in its approach towards orthodoxy rises to a sort of high Arianism, and the radical, represented by the

erratic Theodore Parker, which sinks almost to the mythical Christ of Strauss, and sacrifices his sinless perfection, although Parker has some eloquent passages on the superiority of Christ over all other sages. The more serious class of Unitarians make great account of the perfect example of Christ, and Channing's sermon on the "Character of Christ" (*Works*, vol. iv, p. 1-29), is one of the noblest tributes to the moral perfection of Jesus of Nazareth. See *UNITARIANISM*.

15. *RATIONALISM* has assumed different phases, and resorted to various theories concerning the person of Christ, which agree only in the denial of his divinity, and of all the supernatural or miraculous events in his history. The Wolfenbüttele Fragmentist (Reimarus) represents the hypothesis of wilful imposture; Paulus of Heidelberg the hypothesis of innocent delusion, which mistook extraordinary medical cures for supernatural miracles, and an extraordinary man for a divine being; Strauss and Renan, the theory of poetical fiction, the one in its mythical, the other in its legendary form. (Comp. on these different Christological hypotheses, Schaff, *The Person of Christ; the Miracle of History, with a Reply to Strauss and Renan, and a Collection of Testimonies of Unbelievers*, 1865.) But all these rationalistic attempts, instead of explaining the mystery of Christ's life, only substitute an unnatural prodigy for a supernatural miracle. They have been tried and found wanting; one has in turn superseded the other, even during the lifetime of their champions. Paulus rejects the hypothesis of Reimarus; Strauss most acutely refutes Paulus; Renan, in part at least, dissents from Strauss; the unprincipled Schenkel makes a half-way approach to both in his insignificant *Characterbild Jesu*, and is in turn treated with contemptuous scorn and the keenest sarcasm by Strauss. (See *Die Halben und die Ganzen*, 1865.) The old and ever young faith in the divine-human Redeemer has outlived all these attacks, and is now stronger than ever, the only refuge and comfort of a sinful world. It is in conflict with these latest forms of unbelief that the evangelical theology of Germany has achieved its greatest triumphs and most lasting merits. France, England, and America have engaged in the battle, and contributed their share towards the defeat of the modern anti-Christ, and the defence of the true Christ of the Gospels and of the Church, on whom the salvation of the world depends.

Literature.—Besides the works on special topics already quoted, we mention on the general subject Dionysius Petavius (Jesuit, died 1852), *De theologicis dogmatibus* (Paris, 1644-50, and other editions), tom. iv and v, *de incarnatione Verbi* (the most profoundly learned Roman Catholic work on doctrinal history); George Bull, *Defensio fidei Nicenae* (Oxford, 1685, and often since; a standard work in defence of the essential identity of the Trinitarian and Christological faith of the first four centuries, though defective in not admitting a gradual development of doctrine and logical statement, which is entirely compatible with the essential identity of religious faith); Dan. Waterland, *Vindication of Christ's Divinity* (Oxf. 1719; a very able defense of the orthodox faith against the high Arianism of Dr. Sam. Clarke and Dr. Whitby); Chr. W. F. Walch, *Vollständige Kirchen- und Ketzerhistorie* (Lpzg. 1762 sq. vols. i-ix; exceedingly learned and minute, but dry and tedious); Edw. Burton, *Testimonies of the Ante-Nicene Fathers to the Divinity of Christ* (2d ed. Oxford, 1829); F. Chr. Baur, *Die christliche Lehre von der Dreieinigkeit und Menschwerdung in ihrer geschichtlichen Entwicklung* (Tübingen, 1841-43, 3 vols; very learned, able, and critical, but skeptical); J. A. Dörner, *Entwickelungs geschichte der Lehre von der Person Christi* (1836, 2d ed.; Stuttgart, 1845-53, in 2 vols.; the most learned and complete history of Christology; Eng. transl. by Alexander and Simon in Clark's Foreign Theol. Library, Edinb. 1861, 5 vols.); R. Wilberforce, *The Doctrine of the Incarnation of our Lord Jesus*

Christ (4th ed. London, 1852); M. F. Sadler, *Emmanuel; or, the Incarnation of the Son of God the Foundation of immutable Truth* (Lond. 1867); Schaff, *History of the Christian Church* (N. York, 1867, vol. iii, p. 706-783). Among the *Lives of Christ* which have to do mainly with his history and character as a man on earth we mention those of J. J. Hees (1781), K. Hase (1829; 5th ed. 1865), Neander (1837; 6th ed. 1863; Eng. transl. by M'Clintock and Blumenthal, N. Y. 1848), Sepp (1848; new ed. 1862, in 6 vols.), Lange (1847, 3 vols. Engl. transl.; Edinb. 1865, in 6 vols.), Ewald (1854) and J. J. van Oosterzee (1853, 8 vols.), Riggenbach (1858), C. J. Ellicott (1861), S. J. Andrews (N. Y. 1862), Pressensé (Paris, 1865; Eng. transl. Lond. 1866, 8vo). To these must be added a number of smaller works on the moral character of Christ and his sinless perfection as an argument for his divinity, viz. Ullmann, *Die Sündlosigkeit Jesu* (Hamburg, 7th ed. 1864); J. Young, *The Christ of History* (London and N. Y. 1855); Horace Bushnell, *The Character of Jesus, forbidding his Classification with Men* (N. York, 1861, ch. x of his work on Nature and the Supernatural, and also separately printed); Phil. Schaff, *The Person of Christ, the Miracle of History, etc.* (Boston, 1865; the same in German, Dutch, and French transl.); *Ecce Homo* (Lond. and N. Y. 1866, a theological-sensation-book by an anonymous author), and its counterparts, *Ecce Deus* (Edinb. 1867; likewise anonymous) and *Deus Homo: God-man* (by Prof. Theoph. Parsons, a Swedenborgian, Chicago, 1867).

Christopher, Sr. (Christophorus, *Christ-bearer*), a saint and martyr of the Roman and Greek calendars. The legends make him twelve feet high, and enormous statues of him are still to be found in cathedrals. The place and time of his birth, and, in fact, his very existence, are doubtful. He is said to have suffered martyrdom under Decius. His day in the Greek calendar is May 9; in the Roman, July 25. Of the curious legend of St. Christopher, and the representations of it in mediæval art, see Mrs. Jamieson, *Sacred and Legendary Art*, ii, 489-450. See also *Acta Sanctorum*, July 25; Butler, *Lives of Saints*, July 25; Hoefer, *Biog. Générale*, s. v.

Christopher, Pope. See CHRISTOPHORUS.

Christophörus (Χριστοφόρος, *Christ-bearer*), an epithet applied originally to Christians, especially to martyrs, as "bearing all for Christ," and therefore "bearing Christ." It afterwards became a proper name (Christopher). See Eusebius, *Ch. Hist.* iii, 10; Bingham, *Orig. Eccles.* bk. i, ch. i, § 4.

Christophörus, Pope (Nov., 903, to June, 904), deposed his predecessor Leo V, and imprisoned him; but was, in his turn, soon driven from power by a revolt of the Romans, led by the monster Sergius (q. v.), and forced to retire into a convent, where, in June, 904, he met with a wretched death. Some Roman Catholic writers count him not among the regular popes, but among the anti-popes.

Christo-sacrum, a society founded at Delft, Holland (1797-1801), for the purpose "of promoting the union of all Christian denominations which admit the divinity of Jesus Christ and redemption by the merits of his passion." It was established by two members of the Reformed Church, one of whom (*Onder van Vyngaard-Comenius*) was burgomaster of Delft. It separated "worship" from "teaching," and used a liturgy framed after that of the Church of England. It numbered at one time some 8000 members, mostly Methodists, but has now nearly, if not quite died out. See an apology and sketch of the society in the work *Het genootschap Christo Sacrum vinnen Delft* (Leyden, 1801).—Hase, *Ch. History*, § 486; Wetzer u. Welte, *Kirchenlexikon*, ii, 514; Herzog, *Real-Encyklop.* ii, 688.

Christa, FALSE (ψευδόχριστοι, Mark xiii, 22). No fewer than twenty-four different persons have appeared

making pretensions to be the Christ. In the maintenance of their claims to the Messiahship there has been a great expenditure of blood and treasure. They have appeared at different times, from an early date in the second century till 1682. The first was called Caziba, or Barcocheba (q. v.); and the Jews admit that, in the defence of this false Messiah, they lost between five and six hundred thousand souls. The last that gained any considerable number of converts was Mordecai, a Jew, of Germany, who lived in 1682. Our Lord warned his followers that such false Christs should make their appearance (Matt. xx, 24). See ANTICHRIST.

Chrodegang, bishop of Metz in the eighth century, was born of noble Frankish parents, brought up at the court of Charles Martel, and made his recorder (*referendarius*). In 742 he was raised by Pepin to the bishopric of Metz, and was very active in building churches, and in increasing the influence of Rome during the rest of his life. He is chiefly known as the founder of the Order of Cathedral and Collegiate Canons, and as the author of a Rule of Monastic Life (*Regula Sincera*) for the regulation of the monks of the monastery that he founded, whither he transported the reliques of Gorgonus, Nabor, and Nazarius, given him by Paul I. See CANONS. He died A. D. 766. His Rule (that of Benedict of Nursia modified) consists of thirty-four canons and a preface, in which he says that "the necessity of his new rule arises from the clergy neglecting the rules already in existence, and therefore he comes forward to remind them how they should live."—D'Achery, *Spicileg.* i, 665; Pertz, *Monum. Germ.* ii, 267; Mansi, *Concil.* xiv, 313; Mosheim, *Ch. Hist.* c. viii, pt. ii, ch. ii, n. 23; Neander, *Ch. History* (Torrey's), vol. iii, 106 sq.

Chromatius, bishop of Aquileia (after 888), a distinguished theological writer of the Latin Church. The place and date of his birth are not known. He was a friend of Jerome, Ambrose, Rufinus, and other distinguished men of that period. It was Chromatius who induced Jerome to translate the Old Testament into Latin, and Jerome dedicated to him the commentary on Habakkuk. When the controversy on the writings of Origen broke out between Jerome and Rufinus, Chromatius in vain endeavored to reconcile the former friends. He disapproved of the writings of Rufinus, whom he had baptized, and who had dedicated to him several works. When bishop Anastasius of Rome condemned Rufinus, and communicated the sentence to Chromatius, the latter deemed it his right to dissent from the Roman bishop, and received Rufinus into the communion of his church. Chromatius was a warm defender of Chrysostom, and the latter wrote him a letter of thanks. Most of the works of Chromatius are lost, among others his *Letter to Jerome* (on Rufinus), and his *Letter to the Emperor Honorius* (in defence of Chrysostom); but there are still extant *Discourses on the Eight Beatitudes*, treatises *On the Fifth and Sixth Chapters of St. Matthew and On Baptism*, and a small number of Letters. These works have been edited at Basle (1528 and 1551), Louvain (1646), in Galland's *Bibliotheca Patrum*, vol. vii, and by Pietro Baida, at Udine (*Sancti Chromatii episcopi Aquilejensis Scripta, sive Opuscula, etc., Utinam*, 1816, 4to).—Wetzer and Welte, *Kirchen-Lexikon*, ii, 526; Cave, *Script. Eccles. Hist. Liter.* i, 878 sq.

Chronicles (חִיבוֹנִים, *chibonim hay-yamim'*, words [or acts] of the days, 1 Kings xiv, 19, Sept. ῥήματα τῶν ἡμερῶν, Vulg. *verba dierum*; 1 Chron. xxvii, 24, βιβλίον λόγων, *fasti*; Esth. vi, 1, *μνημόσυνα, annales*; 1 Eedr. ii, 12, *ὑπομνηματισμοί*; 1 Macc. xvi, 24, βιβλίον ἡμερῶν), journals or diaries, i. e. the record of the daily occurrences; the name originally given to the record made by the appointed historiographers in the kingdoms of Judah and Israel, usually called more simply "book of the kings of Israel and Judah"

(1 Chron. ix, 1); so also of separate sovereigns, e. g. Solomon (1 Kings xi, 41), Jehu (2 Chron. xx, 34), etc. See HISTORY.

CHRONICLES, (FIRST and SECOND) BOOKS OF, the designation in the English Bible of the last of the historical books of the Old Test. preceding Ezra; but in the Heb. Scriptures they conclude the entire volume. See BIBLE.

I. *Name*.—The Hebrews call them *דברי הימים* (see above), *registers of days*, and reckon them but one book. The Sept. translators, who regarded them as two books, used the appellation *Παραλειπόμενα*, *things omitted*, as if they were *supplementary* to the other historical records belonging to the Old-Test. canon. The Vulg. retains both the Heb. and Greek name in Latin characters, *Dabre jamnim*, or *hajamim*, and *Paralipomenon*. Jerome tells us (*ad Dominion. et Rogatian.*) that in his time they formed only one book in the Heb. MSS., but had been divided by the Christian churches using the Sept. for convenience, on account of their length. In his *Ep. to Paulinus* he further explains the name *Paralipomenon*, and eulogizes the book. The name *Chronica*, or *Chronicorum liber*, which is given in some copies of the Vulg., and from which we derive our English name of "Chronicles," seems to be taken from Jerome's saying in his *prologus Galeatus*, "*Dibre hajamim*, i. e. *words of days*, which we may more significantly call the *Chronicon* of the whole divine history." It was possibly suggested to him by his having translated the *Chronica* of Eusebius into Latin. Later Latin writers have given them the name of *Ephemerides*. The division into two books, after the example of the Sept. and later versions, was adopted by Bomberg in his Heb. Bible, since which time it has been universal.

II. *Contents*.—(a.) In 1 Chron. i-ix is given a series of genealogical tables, interspersed with historical, geographical, and other notices. These genealogies are not complete: the generations of Adam to Abraham (ch. i, 1-28); of Abraham and Esau (i, 28-54); of Jacob and his son Judah (ii); of king David (iii); of Judah in another line (iv, 1-23); of Simeon (iv, 24-43); of Reuben, Gad, and Manasseh, with historical and topographical notices (v); two lists of the sons of Levi (vi, 1-30); genealogical registers of Heman and Asaph (vi, 31-48); of Merari (vi, 44-50); of Aaron, with a list of the residences of the Levitical families (vi, 50-81); list of the sons of Issachar (vii, 1-5); of Benjamin and Naphtali (vii, 6-18); of Manasseh (vii, 14-19); of Ephraim, with notices of their possessions (vii, 20-29); of Asher (vii, 30-40); a second list of the descendants of Benjamin, with the genealogy of Saul (viii); list of families dwelling at Jerusalem, with intimations of the tribes to which they belonged (ix).

(b.) 1 Chron. x-xxix contains the history of David's reign from the death of Saul, partly agreeing with the account given of him in the books of Samuel, though with several important additions relating to the Levites.

2 Chron. i-ix contains the history of Solomon.

2 Chron. x-xxviii furnishes a succinct account of the kingdom of *Judah* while *Israel* still remained, but separate from the history of the latter.

2 Chron. xxix-xxxvi describes the kingdom of *Judah* after the downfall of *Israel*, especially with reference to the worship of God.

From this analysis it appears that the Chronicles contain an epitome of sacred history, particularly from the origin of the Jewish nation to the end of the first captivity. Besides important notices of a historical character not found in the other books, there are others of a doctrinal and devotional nature. There is one psalm (1 Chron. xvi, 7-86), the first which David assigned for public worship (verse 7).

III. *Diction*.—This is such as suits the time immediately subsequent to the Captivity. It is substantial-

ly the same with that of Ezra, Nehemiah, and Esther, which were all written shortly after the Babylonian exile. It is mixed with *Aramaisms*, marking at once the decline of the Jews in power and the corruption of their native tongue. The pure Hebrew had then been laid aside. It was lost during their sojourn in Babylon. The *orthography* is characterized by an adoption of the *matres lectionis* and frequent interchanges of the weak letters, with other peculiarities (see below, § 4).

IV. *Age and Author*.—Internal evidence sufficiently demonstrates that the Chronicles were written after the Captivity. Thus the history is brought down to the end of the exile, and mention is made of the restoration by Cyrus (2 Chron. xxxvi, 21, 22). It is certain that they were compiled after the time of Jeremiah (2 Chron. xxxv, 25), who lived to see the destruction of Jerusalem by the Chaldeans. The same opinion is supported by the character of the *orthography* and the nature of the *language* employed, as we have already seen, both which are Aramaean in complexion, and harmonize with the books confessedly written after the exile. The Jews generally (unanimously, according to Huet, *Demonst. Evangelica*, iv, 14) ascribe the Chronicles to Ezra (*Baba Bathra*, f. xv, c. 1). In fact, the internal evidence as to the time when the books of Chronicles were compiled seems to tally remarkably with the tradition concerning their authorship. Notwithstanding this agreement, however, the authenticity of *Chronicles* has been vehemently impugned by De Wette and other German critics, whose arguments have been successfully refuted by Dahler, Keil, Movers, and others. It has been clearly shown that the attack was grounded not upon any real marks of spuriousness in the books themselves, but solely upon the desire of the critics in question to remove a witness whose evidence was fatal to their favorite theory as to the post-Babylonian origin of the books of Moses. If the accounts in the books of Chronicles of the courses of priests and Levites, and the ordinances of divine service as arranged by David, and restored by Hezekiah and Josiah, are genuine, it necessarily follows that the Levitical law as set forth in the Pentateuch was not invented after the return from the Captivity. Hence the successful vindication of the authenticity of Chronicles has a very important bearing upon many of the very gravest theological questions.

There is particularly the circumstance that these books bring down the genealogy of David (1 Chron. iii, 19, etc.) to a period admitted on all hands to be subsequent to the restoration. Indeed, from the resemblance of several of the names given in that list with some of those in the ancestry of Christ (Luke iii, 25, 26), the genealogy of David is there brought down to the ninth generation after Zerubbabel (Strong's *Harmony and Exposition of the Gospels*, p. 17, note m). This passage, however, may have been added by final editors of the sacred canon, traditionally reputed to have been the members of the Great Synagogue (q. v.). That the author was at least a contemporary of Zerubbabel is clear; and to show still more the writer's intimate acquaintance with and interest in him, Shelomith, a daughter of Zerubbabel, is inserted, and numerous details given about the family. The name Hattush (verse 22) occurs also in Ezra viii, 2, as that of a descendant of David who returned with Ezra from Babylon: this would favor the view advanced if the identity could be established; but for this there is no evidence. But a more important note of time is the notice in 1 Chron. ix, 17, 18, regarding the Levitical porters, "who hitherto (לְפָנֵי הַמֶּלֶךְ, *amīl now*, to the time of the writer) waited in the king's gate;" and of two of which, Akkub and Talmon, mention is made in Neh. xii, 25, 26, as "keeping the ward at the thresholds of the gates . . . in the days of Nehemiah, and of Ezra the priest the scribe."

These conclusions of date from historical notices are confirmed by various peculiarities of expression and by the whole literary character of the composition. Of the peculiarities marking the late age of the writer is the term *בֵּית הַמִּקְדָּשׁ* (*birah*, "palace"), applied to the Temple, instead of the old and usual *הֵיכָל* (*heykal*). This was an imitation of the great Persian cities, in correspondence with which Jerusalem is conceived of as having its palace, afterwards called *Bâpuc*. See *BABYLON*. Another term with which the Hebrews became acquainted in Babylon was *בִּזְיָא* (*buts*, *byssus*, which occurs in none of the older books, notwithstanding the frequent mention of *שָׁשׂ* (*sheek*), or "fine linen," and is found only in 1 Chron. iv, 21; xv, 27; 2 Chron. ii, 14; iii, 14; v, 12; Esth. i, 6; viii, 15; and in a book written in Chaldæa, Ezek. xxvii, 16 (Eichhorn, *Einleitung*, § 493). So also the mention of *אֲדָרְכֹן* (*adarikon*, "drum," but more correctly *daric*, 1 Chron. xxix, 7; also Ezra ii, 69; viii, 27; Neh. vii, 70), a Persian coin, the current money of the time. Jahn (*Einleitung*, § 50) refers to a remark in 2 Chron. iii, 8, that the cubit was after the "first (or old) measure," intimating that a new standard was in use in the time of the writer. The literary character of the work, in general, entirely betokens a period when the language was greatly deteriorated through foreign influences, particularly during the exile, manifesting many peculiarities of style and orthography. Many examples of the latter, as the interchange of *aleph* with *he* quiescent, may be seen on comparing the two lists of David's heroes in 1 Chron. ix and 2 Sam. xiii. With respect, again, to the later books, more particularly that of Ezra, there are many important resemblances, a list of which may be found in Hävernick, p. 270.

This determination of the age of the composition narrows the ground of inquiry as to its authorship. The Jewish opinion that Ezra was the author of the Chronicles was universally received down to the middle of the seventeenth century, when it was called in question by the English deistical writer Hobbes, who assigned to it an earlier date. It was Spinoza who first referred it, on the contrary, to a later period than the time of Ezra, bringing it down to the time of the Maccabees, a view adopted in modern times by Gramberg, and partly by De Wette. Carpzov, Eichhorn, Hävernick, Welte, and modern writers in general, consider Ezra to be the author. Ewald (*Geschichte des Volkes Israel*, 2d ed., i, 252) admits that the Chronicles and the book of Ezra are by the same author, and even contends that they originally formed one work, not the production of Ezra himself, but a much later writer. Jahn denies all appearance of similarity between the Chronicles and Ezra, and ascribes the former to some unknown writer at the close of the Captivity.

The identity of authorship of the books of Chronicles and Ezra can be established by numerous arguments, besides the marks of similarity in expression already adverted to. The internal relation of the Chronicles and the book of Ezra was early recognised. This is seen from the arrangement of the two adopted by the Sept. different from that of the Jewish canon. Further, the writer of the *third* (apocryphal) book of Ezra has wrought up the two writings into one. The conclusion of Chronicles and the beginning of the book of Ezra are almost identical in expression, from which it is but reasonable to infer that the one was intended to be a continuation of the other; the one history terminating with the decree for the restoration from captivity, the other narrating how that decree was obtained and how it was carried out. Without this connection the opening words of the book of Ezra must appear exceedingly abrupt, presenting a form of commencement which is in reality only a continuation. (See Ezra i, 1.) The connection thus indicated is further evinced by the style, the manner of

narration, and of regarding events from a Levitical point of view, common to the two works; the whole spirit, in fact, and characteristics are identical. Thus the frequent citations of the law, and in similar terms, as *כַּמ־מִשְׁפָּט* (*kam-mishpat*), meaning "according to the law of Moses" (1 Chron. xxiii, 81; 2 Chron. xxxv, 18; Ezra, iii, 4; yet also in Neh. viii, 18). The descriptions of the sacrificial rites are in the two books very full, and in nearly the same terms (comp. Ezra ii, 2-5, with passages like 1 Chron. xvi, 40; 2 Chron. viii, 18; xiii, 11); so also the account of the celebration of the passover (Ezra vi, 19, etc., and 2 Chron. xxx, 85), and the order of the Levites in charge of the Temple (Ezra iii, 8, 9; 1 Chron. xxxiii, 2, 3). What presents the greatest apparent contrast in the two books is the high-priest's genealogy in 1 Chron. vi, 1-15, in the descending line, terminating with the Captivity, and in Ezra vii, 1-5, in the ascending line, from that priest himself to Aaron; but a little consideration will reconcile the discrepancy. The two lists are partly parallel, and partly the one is a continuation of the other; as regards the latter point there can be no conflict, and as to the former it will be observed that the list in Ezra is considerably abridged, many links being omitted (Bertheau), and this could the more readily be done if the writer had elsewhere given a complete register. See *EZRA* (BOOK OF).

The only serious objection to their authorship by Ezra is the fact (above noticed) that certain genealogies (e. g. of Zerubbabel (1 Chron. iii, 19-24; comp. that of the high-priests, Neh. xii, 11) are continued much later than his time; but these few verses may have been inserted by a later hand, without affecting his general authorship, just as the notice of the death of Moses (Deut. xxxiv) must have been added to the Pentateuch by another hand than his own. See *CANON* (OF SCRIPTURE).

V. *Scope and Method.*—The books of Chronicles, as compared with those of Kings, are more *didactic* than *historical*. The *historical* tendency is subordinated to the *didactic*. Indeed, the purely historic form appears to be preserved only in so far as it presented an appropriate medium for those religious and moral observations which the author specially aimed to adduce. Samuel and Kings are more occupied with the relation of *political* occurrences, while the Chronicles furnish detailed accounts of *ecclesiastical* institutions. Thus 1 Chron. xvii, 11-14, compared with 2 Sam. viii, 12-16, manifests more distinctly the Messianic character of the promises made to David (see *PYE*, *Script. Testimony*, i, 171). So, too, in the genealogical table, while no place is given to some of the tribes, as Dan and Asher, that of Judah in the line of David is traced down to the writer's own time (1 Chron. i, 1-27; ii, 1, 8-15; iii), beyond any other historical notice of the O. T., and connecting with the genealogy of Christ (Matt. i). See *GENEALOGY*.

The *plan* of these books, of which the book of Ezra is a continuation, forming one work, immediately becomes apparent if we consider it as the compilation of Ezra, or some one nearly contemporary with him. One of the greatest difficulties connected with the Captivity and the return must have been the maintenance of that genealogical distribution of the lands which yet was a vital point of the Jewish economy. Accordingly it appears to have been one to which both Ezra and Nehemiah gave their earnest attention, as David, Hezekiah, and other kings had done before them. Another difficulty intimately connected with this was the maintenance of the Temple services at Jerusalem. This could only be effected by the residence of the priests and Levites in Jerusalem in the order of their courses; and this residence was only practicable in case of the payment of the appointed tithes, first-fruits, and other offerings. As soon as these ceased the priests and Levites were obliged to

disperse to their own villages to obtain a livelihood, and the Temple services were neglected. But then, again, the registers of the Levitical genealogies were necessary in order that it might be known who were entitled to such and such allowances, as porters, as singers, as priests, and so on, because all these offices went by families; and, again, the payment of the tithes, first-fruits, etc., was dependent upon the different families of Israel being established each in his inheritance. Obviously, therefore, one of the most pressing wants of the Jewish community after their return from Babylon would be trustworthy genealogical records, and if there were any such in existence, the arrangement and publication of them would be one of the greatest services a person in Ezra's situation could confer. But further, not only had Zerubbabel (Ezra iii, v, vi), and after him Ezra and Nehemiah (Ezra ii, viii; Neh. vii, viii), labored most earnestly in the teeth of immense difficulties to restore the Temple and the public worship of God there to the condition it had been in under the kings of Judah, but it appears clearly from their policy, and from the language of the contemporary prophets, Haggai and Zechariah, that they had it much at heart to reinfuse something of national life and spirit into the bosom of the people, and to make them feel that they were still the inheritors of God's covenanted mercies, and that the Captivity had only temporarily interrupted, not dried up, the stream of God's favor to their nation. Now nothing could more effectually aid these pious and patriotic designs than setting before the people a compendious history of the kingdom of David, which should embrace a full account of its prosperity, should trace the sins which led to its overthrow, but should carry the thread through the period of the Captivity, and continue it, as it were, unbroken on the other side; and those passages in their former history would be especially important which exhibited their greatest and best kings as engaged in building or restoring the Temple, in reforming all corruptions in religion, and zealously regulating the services of the house of God. As regards the kingdom of Israel or Samaria, seeing it had utterly and hopelessly passed away, and that the existing inhabitants were among the bitterest "adversaries of Judah and Benjamin," it would naturally engage very little of the compiler's attention. These considerations explain exactly the design of that historical work which consists of the two books of Chronicles and the book of Ezra. For, after having in the first eight chapters given the genealogical divisions and settlements of the various tribes, the compiler marks distinctly his own age and his own purpose by informing us, in ch. ix, 1, of the disturbance of those settlements by the Babylonian Captivity, and, in the following verses, of the partial restoration of them at the return from Babylon (2-24); and that this list refers to the families who had returned from Babylon is clear, not only from the context, but from its reinsertion, Neh. xi, 3-22, with additional matter evidently extracted from the public archives, and relating to times subsequent to the return from Babylon, extending to Neh. xii, 27, where Nehemiah's narrative is again resumed in continuance with Neh. xi, 2. Having thus shown the re-establishment of the returned families, each in their own inheritance according to the houses of their fathers, the compiler proceeds to the other part of his plan, which is to give a continuous history of the kingdom of Judah from David to his own times, introduced by the closing scene of Saul's life (ch. x), which introduction is itself prefaced by a genealogy of the house of Saul (ix, 35-44), extracted from the genealogical tables drawn up in the reign of king Hezekiah, as is at once manifest by counting the thirteen or fourteen generations, from Jonathan to the sons of Azel inclusive, exactly corresponding to the fourteen from David to Hezekiah inclusive. This part of the plan extends from 1 Chron. ix, 35, to the end of

the book of Ezra; 1 Chron. xv-xxii, xxii-xxix; 2 Chron. xiii-xv, xxiv-xxvi, xxix-xxxii, and xxxv are among the passages wholly or in part peculiar to the books of Chronicles, which mark the purpose of the compiler, and are especially suited to the age and the work of Ezra (q. v.).

VI. *Sources*.—It is evident that the Chronicles were compiled not only from former inspired writers, but, for the most part, from public records, registers, and genealogies belonging to the Jews. That national annals existed there can be no doubt. They are expressly mentioned, as in 1 Chron. xxvii, 24. They contained an account of the most important events in the history of the Hebrews, and were generally lodged in the tabernacle or Temple, where they could most conveniently be consulted.

The following are the explicit references by the compiler himself to older memoirs or historical works: (1) The book (סְפָרֵי שְׁמוּאֵל, *words or acts*) of Samuel the seer, the book of Nathan the prophet, and the book of Gad the seer (1 Chron. xxix, 29). This cannot mean the inspired books of Samuel, because they do not contain the entire history of David ("his acts first and last"). It refers to a history of his own times written by Samuel, and to a continuation of it, embracing succeeding times, written by Nathan and Gad, from which it is probable that part of the contents of the present books of Samuel was drawn. See NATHAN; GAD. (2) The book of Nathan the prophet, the prophecy of Ahijah the Shilonite, and the visions of Iddo the seer (2 Chron. ix, 29). See AHJAH; IDDO. (3) The book of Shemaiah the prophet, and of Iddo the seer concerning genealogies; or, as De Wette translates it, *after the manner of family-registers* (2 Chron. xii, 15). See SHEMAIAH. (4) The story, or, rather, the interpretation (שְׁפָרֵי יִדְדוֹ, *midrash*) of the prophet Iddo (2 Chron. xiii, 22). (5) The book of Jehu the son of Hanani, inserted in the book of the Kings of Israel (2 Chron. xx, 34). See JEHU. (6) The history of Uzziah, by Isaiah the son of Amos (2 Chron. xxvi, 22). (7) The vision of Isaiah the prophet, in the book of the Kings of Judah and Israel (2 Chron. xxxii, 82). See ISAIAH. (See Gesenius's *Commentar über den Jesaja; Einleit.* § 4.) (8) The sayings of the seers (2 Chron. xxxiii, 19). See HOZAI. (9) The interpretation of the book of the Kings (2 Chron. xxiv, 27). (10) The book of the Kings of Judah and Israel (2 Chron. xvi, 11; xxv, 26; xxvii, 7; xxviii, 26; xxxv, 27; xxxvi, 8). This could not have been our present books of Kings, but *public annals*, because, in several instances where the reader is referred to them for farther information, our books of Kings contain less than what is stated in the Chronicles. (11) The book of the Kings of Israel (2 Chron. xx, 34). (12) The words or histories of the Kings of Israel (2 Chron. xxxiii, 18). It is probable that Nos. 10, 11, and 12 refer to the same historical work. See KINGS (BOOKS OF). (13) The Chronicles of King David (1 Chron. xxvii, 24). (14) The Lamentations (2 Chron. xxxv, 25). This, however, has been thought by some not to mean the Lamentations of Jeremiah which we now have, but other Lamentations, composed by the prophet on the death of Josiah, and long since lost. See LAMENTATIONS.

In addition to the above avowed documents, the compiler must have had others. Thus the lists of David's heroes (xi, 10-47), of those who came to him at Ziklag (xii, 1-22), of the captains, princes of the tribes, and officers of David's household (xxvii), the number and distribution of the Levites, and the minute information given respecting divine worship (xxiii-xxvi), must have been derived from written sources not included in the *book of the Kings of Israel and Judah*. Some documents are mentioned by the compiler which he did not use. Thus a writing of Elijah, addressed to Jehoram, is spoken of in 2 Chron. xxi, 12. See ELLIAH.

In 1 Chron. i, 9, we have only a few references to the origin of the genealogical lists. Throughout most of this portion the compiler relied on registers, which he carefully followed, but does not definitely cite (yet see 1 Chron. v, 7, 17; vii, 7; ix, 1). Although the genealogies of 1 Chron. i-ii, 2, are substantially the same as in Genesis, greatly abridged, and with the omission of nearly all the historical notices, these matters being already so well known as to render repetition unnecessary—a strong, because indirect argument for the authority of the Mosaic writings—yet the greater portion of those which follow is found nowhere else. Even in this abridgment of the older genealogies there is manifested much independence. In proof of this it is only necessary to observe some of the appended notices, e. g.: 1 Chron. i, 51, "Hadad died also," an addition to Gen. xxxvi, 89, it being inferred by Hengstenberg (*Genesis of the Pentateuch*, ii, 245) and others, from the latter passage, that Hadad was still living in the time of Moses. See HADAD. After 1 Chron. ii, 2, the genealogical lists are interspersed with fuller details, and the work attains to more completeness and independence.

It has been inquired whether our present books of Samuel and Kings were among the sources whence the Chronicle writer drew his materials? The question is answered in the affirmative by De Wette, Movers, and Bleek; by Hävernick and others in the negative. The first-named critic adduces three arguments in favor of the hypothesis that the parallel accounts were derived from the earlier books, only one of which appears to us valid, viz., the certainty of the Chronist's having known the earlier books. After denying the force of all these arguments, Keil proceeds to adduce some positive grounds against the hypothesis that the books of Kings and Samuel were used as sources. The considerations adduced by him, however, are singularly wanting in validity (*Einleitung*, p. 480-482, Pref. 1858). If the compiler of Chronicles knew the canonical books, why should it be thought that he abstained from using them? They would have facilitated his work. The most convincing proof that he both knew and used them is furnished by some forty parallels, which are often verbal. Thus, in 2 Chron. i, 14-17, there is a paragraph almost verbally coinciding with 1 Kings x, 26-29. Again, 1 Chron. xvii and xviii are in many places verbally parallel with 2 Sam. vii and viii. Compare also 1 Chron. xix, 1-xx, 1, with 2 Sam. x-xi; 2 Chron. x, 1-xi, 4, with 1 Kings xii, 1-24; 2 Chron. xv, 16-18, with 1 Kings xv, 18-15; 2 Chron. xxv, 1-4, 17-28, with 2 Kings xiv, 1-6, 8-20; 2 Chron. xxxiii, 1-9, with 2 Kings xxi, 1-9; 2 Chron. xxxiii, 21-25, with 2 Kings xxi, 19-28, etc. Nor can all these coincidences be explained by a common use of the older documents, for in many of the passages, evidently abridgments, the compression or selection is identical. See SAMUEL (BOOKS OF).

On the other hand, many particulars, more especially in the lives of David and Solomon, recorded in these books, are entirely passed over in the Chronicles, and in their stead are given notices of the state of religion and of public worship.

(1.) *The principal omissions in the Chronicles* are: The family scene between Michal and David (2 Sam. vi, 20-23); David's kindness to Mephibosheth (2 Sam. ix); his adultery with Bathsheba (2 Sam. xi, 2-xii, 25); his son Amnon's defilement of Tamar, and the rebellion of Absalom (2 Sam. xiv-xix); the revolt of Sheba (2 Sam. xx); the delivering up of Saul's sons to the Gibeonites (2 Sam. xxi, 1-14); the war with the Philistines (2 Sam. xxi, 15-17); David's psalm of thanksgiving, and last words (2 Sam. xxii-xxiii, 7); Adonijah's attempted usurpation, and the anointing of Solomon (1 Kings i); David's last will (1 Kings ii, 1-9); Solomon's throne established by the punishment of his opponents (1 Kings ii, 18-46); his marriage with Pharaoh's daughter (1 Kings iii, 1); his wise decision (1

Kings iii, 16-28); his officers, glory, and wisdom (1 Kings iv); his strange wives, and idolatry (1 Kings xi, 1-40). The entire omission of the history of the kingdom of Israel, except that it was carried away captive by the Assyrians, as a punishment for its sins (1 Chron. v, 25, 26), is noteworthy (see above, § 5).

(2.) *Matter peculiar to the Chronicles*.—The list of the heroes who came to David at Ziklag, and of the hosts who came to Hebron to make him king (1 Chron. xii); David's preparation for building the Temple (ch. xxii); the enumeration and order of the Levites and priests (ch. xxiii-xxvi); the order of the army and its captains (ch. xxvii); David's directions in public assembly shortly before his death (ch. xxviii, xxix); Rehoboam's fortifications, his reception of the priests and Levites who fled from the kingdom of Israel, his wives and children (2 Chron. xi, 5-24); Abijah's war with Jeroboam (xiii, 8-20); the notice of Abijah's wives and children (xiii, 21); Asa's works in fortifying his kingdom and his victory over Zerah the Cushite (xiv, 8-14); a prophecy of Azariah, which induced Asa to put down idolatry (xv, 1-15); the address of the prophet Hanani (xvi, 7-10); Jehoshaphat's endeavors to restore the worship of Jehovah, his power and riches (xvii, 2-xviii, 1); his instructions and ordinances as to judgment (ch. xix); his victory over the Ammonites and Moabites (xx, 1-30); his provision for his sons, and their death by his son and successor, Jehoram (xxi, 2-4); Jehoram's idolatry and punishment (xxi, 11-19); the death of the high-priest Jehohada, and the apostasy of Joash (xxiv, 15-22); Amaziah's warlike preparations (xxv, 5-10); his idolatry (xxv, 14-16); Uzziah's wars, victories, and forces (xxvi, 6-16); Jotham's war with the Ammonites (xxvii, 4-6); Hezekiah's reformation and passover (xxix, 8-xxxii, 21); his riches (xxxii, 17-30); Manasseh's captivity, release, and reformation (xxxiii, 11-17).

(3.) *Matter more fully related in Chronicles*.—The list of David's heroes (1 Chron. xii, 11-47), of which the names (ver. 42-47) are wanting in 2 Sam. xxiii, 8, etc.; the removal of the ark from Kirjath-jearim to Mount Zion (1 Chron. xiii, xv, 2-24; xvi, 4-48; comp. with 2 Sam. vi); the candlesticks, tables, and courts of the Temple (2 Chron. iv, 6-9; comp. with 1 Kings vii, 38, 39); the description of the brazen scaffold, on which Solomon knelt (2 Chron. vi, 12, 13, with 1 Kings viii, 22); in Solomon's prayer, the passage 2 Chron. vi, 41, 42, from Ps. cxxxiii, 7-9; the mention of the fire from heaven consuming the burnt-offering (2 Chron. vii, 1, etc.); the enlargement of the divine promise (2 Chron. vii, 12, 16, with 1 Kings ix, 8); Shishak's invasion of Judaea; the address of the prophet Shemaiah (2 Chron. xii, 2-8, with 1 Kings xiv, 28); Amaziah's victory over the Edomites (2 Chron. xxv, 11-16, with 2 Kings xiv, 7); Uzziah's leprosy; its cause (2 Chron. xxvi, 16-21, with 2 Kings xv, 5); the passover under Josiah (2 Chron. xxxv, 2-19, with 2 Kings xxii, 21, etc.).

(4.) Other peculiarities distinguishing the book of Chronicles, and fitting it for the altered circumstances in the time of its composition, are the substitution of modern and more common expressions for such as had become unusual or obsolete (comp. in the original 1 Chron. x, 12, with 1 Sam. xxxi, 12; 1 Chron. xv, 29, with 2 Sam. vi, 16, etc.), particularly the substitution for the old names of places, those which were in use in the writer's own day; thus, Gezer (1 Chron. xx, 4), instead of Gob (2 Sam. xxi, 18); Abel Maim, Abel on the water [Merom] (2 Chron. xvi, 4), instead of Abellath-Maachah (1 Kings xv, 20). So also the omission of geographical names which had become unknown, or had ceased to be of interest, as Helam (2 Sam. x, 16, 17), omitted in 1 Chron. xix, 17; so also Zair (2 Kings viii, 21; comp. with 2 Chron. xxi, 9). See particularly 2 Sam. xxiv, 4-8, compared with 1 Chron. xxi, 4. There is also the endeavor to substitute more definite expressions for such as were indefinite, and so possibly ambiguous (as 2 Chron. xxxviii, 8; comp. with

2 Kings xvi, 8; 2 Chron. xxiv, 24, with 2 Kings xxii, 16).

Other lists occur in Chron., which are given with considerable extension or in a different connection in the earlier books, e. g. the ancestors of David, 1 Chron. ii, 10-12; comp. Ruth iv, 19-22. Still other lists are peculiar to the Chronicles, as ii, 18-58; iii, 16-24; iv, 2-28, 84-48; v, 1-26, 88-86; vi, 1-84. These latter genealogies are obviously transcribed from some register, in which were preserved the genealogies of the tribes and families drawn up at different times. This appears from the very different ages at which different genealogies terminate, indicating of course the particular reign when each was drawn up. Thus, e. g. the line of the high-priests (1 Chron. vi, 1-15) must have been drawn up during the Captivity; that in 50-58, in the time of David or Solomon; those of Heman and Asaph, in the same chapter, in the time of David; that of the sons of Zerubbabel (1 Chron. iii, 19-24) as late at least as the close of the canon, and so on.

The same wide divergence in the age of other materials embodied in the books of Chronicles is also apparent. Thus the information in 1 Chron. i, concerning the kings of Edom before the reign of Saul, was obviously compiled from very ancient sources. The same may be said of the incident of the slaughter of the sons of Ephraim by the Gittites, 1 Chron. vii, 21; viii, 18; and of the account of the sons of Shela, and their dominion in Moab, 1 Chron. iv, 21, 22. The military census of the tribes of Issachar, Benjamin, and Asher, in 1 Chron. vii, evidently formed part of the returns made to David (2 Sam. xxiv, 9). The curious details concerning the Reubenites and Gadites in 1 Chron. v, must have been drawn from contemporary documents, embodied probably in the genealogical records of Jotham and Jeroboam, while other records used by the compiler are as late as after the return from Babylon, such as 1 Chron. ix, 2 sq.; 2 Chron. xxxvi, 20 sq.; and others, as Ezra ii and iv, 6-28, are as late as the time of Artaxerxes and Nehemiah. Hence it is further manifest that the books of Chronicles and Ezra, though put into their present form by one hand, contain, in fact, extracts from the writings of many different writers, which were extant at the time the compilation was made. For the full account of the reign of David, he made copious extracts from the books of Samuel the seer, Nathan the prophet, and Gad the seer (1 Chron. xxix, 29). For the reign of Solomon he copied from "the book of Nathan," from "the prophecy of Ahijah the Shilonite," and from "the visions of Iddo the seer" (2 Chron. ix, 29). Another work of Iddo supplied an account of the acts, and the ways, and sayings of king Abijah (xiii, 22); while yet another book of Iddo concerning genealogies, with the book of the prophet Shemaiah, contained the acts of king Rehoboam (xii, 15). For later times the "Book of the kings of Israel and Judah" is repeatedly cited (2 Chron. xxv, 26; xxvii, 7; xxxii, 82; xxxiii, 18, etc.), and "the sayings of the seers," or perhaps of Hozai (xxxiii, 19); and for the reigns of Uzziyah and Hezekiah "the vision of the prophet Isaiah" (xxvi, 22; xxxii, 82). In other cases, where no reference is made to any book as containing farther information, it is probable that the whole account of such reigns is transcribed. Besides the above-named works, there was also the public national record, called "book of the Chronicles" (סֵפֶר הַיְהוּדִים וְהַלְוִיִּם), mentioned in Neh. xii, 23, from which doubtless the present books took their name, and from which the genealogies and other matters in them were probably derived, and which are alluded to as having existed as early as the reign of David, 1 Chron. xxvii, 24. These "Chronicles of David" (סֵפֶר הַיְהוּדִים וְהַלְוִיִּם לְדָוִד) are probably the same as those (the יְהוּדִים) above referred to, as written by Samuel, Nathan, and Gad. From

this time the affairs of each king's reign were regularly recorded in a book called at first "the book of the acts of Solomon" (סֵפֶר הַיְהוּדִים וְהַלְוִיִּם), 1 Kings xi, 41), by the name of the king, as before of David, but afterwards in both kingdoms by the general name of chronicles, as in the constantly-recurring formula, "Now the rest of the acts (הַיְהוּדִים) of Rehoboam, Abijah, etc.; Jeroboam, Nadab, etc., are they not written in the book of the Chronicles of the kings of Judah" or "of Israel" (1 Kings xiv, 28; xv, 7, etc.)? This continues to the end of Jehoiakim's reign, as appears from 2 Kings xxiv, 5; 2 Chron. xxxvi, 8. It was doubtless from this common source that the passages in the books of Samuel and Kings identical with the books of Chronicles were derived. All these several works have perished, but the most important matters in them have been providentially preserved to us in the Chronicles.

VII. *Discrepancies and Contradictions.*—The credibility of the books of Chronicles has been greatly contested by rationalistic writers, but by none with more tenacity than De Wette, first in his *Beiträge zur Einleitung* (Halle, 1806, i, 1-182), and subsequently in the successive editions of his *Einleitung*, where he has brought together every sort of difficulty and alleged contradiction, many of which rest only on assumptions which would not be tolerated if applied to any other than a Biblical writer. It indeed cannot be denied that many difficulties do exist in this portion of Scripture, and not a few apparent contradictions between its statements and those of the other historical books, particularly as regards proper names and numbers; but these, even if they cannot be satisfactorily explained, scarcely warrant calling in question the sincerity or the credibility of the writer. Thus, for instance, it is objected that 1 Chron. ii, 6 is a false combination of 1 Kings v, 11 [iv, 81]; but nothing is more common than the recurrence of the same names in different families and tribes, and at different periods; and although Hävernick unnecessarily admits that some of the names in the two passages are identical, it would certainly indicate rare confusion on the part of the writer of the Chronicles to bring together times and persons so far apart from one another. Ethan the Ezrahite, of the family of Merari (1 Chron. vi, 29 [44]), was one of David's masters of song (1 Chron. xv, 17), and the author of Psa. lxxxix. Heman, also an Ezrahite, and author of Psa. lxxxviii, was a leader of David's sacred choir (1 Chron. xv, 17), and it is utterly inconceivable that persons, as it would appear, so well known to the writer of the Chronicles, should so inconsiderately be reckoned among the posterity of Judah, and assigned to a time so long antecedent to that of David. See HEMAN.

There are, however, real difficulties, particularly in the genealogical tables, and also in various numerical statements, and these, it may be supposed, arose in a great measure from corruption of the text; for it is in such cases that there is the greatest facility for the rise and the perpetuation of false readings, the context affording little aid for their detection, or rectification if detected. The text of the Chronicles furnishes many instances of such corruptions, although in several cases, where it differs from the corresponding passages in the books of Samuel and of Kings, it is just as possible that it shows the true reading. A remarkable case is 1 Chron. vi, 18 [28], "And the sons of Samuel, the first-born Vashni and Abiah," comp. with 1 Sam. viii, 2, "Now the name of his first-born was Joel, and the name of his second Abiah." It is easy to see how this contradiction has arisen. The name Joel had fallen out of 1 Chron. vi, 18, and some transcriber, seeing the necessity for some name after "the first-born," transformed וַשְׁנִי (*vo-hash-sheni*), "and the second," into a proper name, Vashni. The mistake is as old as the Sept.—*ὁ πρῶτοτοκος Σανὶ καὶ*

'*Asiá*. The Syriac and Arabic read as in Samuel (*Jour. of Sac. Lit.* April, 1852, p. 198).

(1.) Passages where the readings in Chronicles are obviously corrupt; sometimes the work itself showing the erroneous nature of the reading, e. g. 2 Chron. iii, 15; iv, 5, compared with 1 Kings vii, 15, 26, etc.

(2.) Passages where the correct reading is that of the Chronicles. The father of Amasa is designated in 1 Chron. ii, 17, "Jether, the *Iakmaélite*;" in 2 Sam. xvii, 25, "Ithra, an *Israelite*." Examples of numerical statements: 1 Chron. xviii, 4, compared with 2 Sam. viii, 4; 1 Chron. xix, 18, comp. with 2 Sam. x, 18; 1 Chron. xxi, 12, with 2 Sam. xxiv, 13; 2 Chron. iii, 15, and 1 Kings vii, 16, with 2 Kings xxv, 17, where the height of the "chapters" on the brazen pillars, as given in the first two passages, is confirmed by Jer. lii, 22; 2 Chron. ix, 25, compared with 1 Kings iv, 26; 1 Chron. xi, 11, compared with 2 Sam. xxiii, 8; 2 Chron. xxvi, 1, 3, 8, etc. comp. with 2 Kings xv, 1, 6, etc.

(3.) Passages where the correct reading is doubtful: 2 Chron. ii, 2, 17 [18], comp. with 1 Kings v, 80 [16]; 2 Chron. viii, 10, comp. with 1 Kings ix, 23; 2 Chron. viii, 13, comp. with 1 Kings ix, 28, etc. (On the numerical discrepancies, see Reinke, *Beiträge zur Erklärung des alt. Testaments*, I, i.) See NUMBER. In Movers, Kennicott, and Gramberg, others may be found which are injudiciously brought forward as truly at variance; yet 2 Chron. viii, 18, compared with 1 Kings ix, 28; 1 Chron. xxi, 5, comp. with 2 Sam. xxiv, 9, where the numbers of Judah are different, and other places that might be quoted, present contradictions which evince that the text is corrupt. It is well known, although the cause has not fully hitherto been ascertained, that the text of the books of Samuel, Kings, and Chronicles is in a worse condition than that of the other inspired writings. Jerome (*Præf. ad Paral.*) speaks of the Greek text of Chron. as being hopelessly confused in his days, and assigns this as a reason why he made a new translation from the Hebrew. Many of the names and words that are differently written should be referred to this head. Some omissions and some interpolations also belong to it. But the principal contradictions relate to numbers. These seem to have been expressed in various ways; and copyists, having different methods of marking them, were naturally exposed to errors. Sometimes numbers were designated by letters, occasionally by ciphers, and again they were marked by words. See ABBREVIATION.

(4.) Passages erroneously regarded as contradictory: Between 2 Chron. xxviii, 20, and 2 Kings xvi, 7-9, there is no contradiction, as they relate to different stages of the war; and it is quite possible that the mercenary Tiglath-pileser from an ally became an opponent; a fact even intimated in 2 Kings xvi, 18, by Ahaz's removal of a gallery, which might afford access to an enemy. Between 1 Chron. xi, 23, "An Egyptian, a man of great stature, five cubits high, and in the Egyptian's hand was a spear like a weaver's beam," and 2 Sam. xxiii, 21, "An Egyptian, a goodly man, and the Egyptian had a spear in his hand," there is no contradiction; the one passage being more specific, but still in accordance with and its purport implied in the other. The Egyptian's noticeable appearance was his stature, with which also his spear corresponded. 2 Chron. xxxiv, 8-7, places the reformation under Josiah in the twelfth year of his age, while 2 Kings xxii, 3, assigns to it the eighteenth; the former referring only to the beginning of the work, while the other passage points to some great progress in it, the rooting out of idolatry, as is required by 2 Chron. xxxv, 19. Many other passages, which are usually adduced under this head, do not belong to it: e. g. 2 Chron. ix, 25, compared with 1 Kings iv, 26; 2 Chron. xxii, 2, with 2 Kings viii, 26; 1 Chron. xxi, 1, with 2 Sam. xxiv, 1; 1 Chron. xxi, 5, with 2 Sam. xxiv, 9; 1

Chron. xxi, 25, with 2 Sam. xxiv, 24; 2 Chron. xiii, 2, with 1 Kings xv, 10; on the true mode of harmonizing which we refer to Davidson's *Sacred Hermeneutics*, p. 544-554, where they are resolved. A large class of the discrepancies in question, affecting the ages and reigns of the kings, is due simply to the mode of reckoning either (a) according to the civil as distinct from the sacred year, or (b) according to dates of association with the respective fathers on the throne (*Math. Quart. Rev.*, Oct. 1856, p. 619 sq., where all these are reconciled). See CHRONOLOGY.

Many less important deviations are here passed over, as being referable to the arbitrary choice of the compiler, such as omissions, additions, difference of order, change of style, etc. Most or all of the real difficulties, with respect to facts, will be examined under the several articles to which they relate. Many of the obscurities, and not a few discrepancies, are apparently insoluble, owing to the loss of the original data, which alone could serve to explain them. These are more numerous and formidable, perhaps, in the Chronicles than in any other book of Scripture; yet the discrepancies, even were there no satisfactory solution, cannot greatly affect the character of the writer of the Chronicles; for the probability as regards correctness will be found on the part of the later writer, who, having the earlier works before him, would not unnecessarily, in matters of fact and plain numerical statements, where differences and contradictions were so easily discernible, vary from the earlier accounts favored by the authority arising from age and prior acceptance. There can be no question, moreover, that many of the discrepancies are owing to the fault of copyists, while in some they are the result of the different views and designs of the respective writers, or the brevity of their statements. In proof, however, of the accuracy of the Chronicles, the following particulars are worthy of consideration:

a. The writer is exceedingly definite in his statements. Thus the time when it occurred to David to build the Temple of the Lord is indicated (2 Sam. vii, 1), "It came to pass when (*כִּי*) the king sat in his house," etc., but more definitely stated in 1 Chron. xvii, 1 (*כִּי*), "as soon as he sat," etc. (see Hengstenberg, *Christol.* i, 144, Berlin, 1854); while the omission of the words, "and the Lord had given him rest round about from all his enemies," removes the chronological difficulty in that statement. Of his accuracy, again, in the genealogical notices, the following example may suffice. In 1 Chron. ii, 16, mention is made of two sisters of David, Abigail and Zeruiah, the latter of whom was the mother of Joab, Abishai, and Asahel, who are never designated after their father, but always after their more illustrious mother (2 Sam. ii, 18; xxi, 17, etc.). Amasa is referred to as a blood relation of David (2 Sam. xix, 14); according to 2 Sam. xvii, 25, Amasa was a son of Abigail, and she sister of Zeruiah, the mother of Joab; but the daughter of Nabsah, not positively of Jesse, and thus perhaps only the half-sister of David. See NAHASH. Therefore it is that, in the genealogy of Jesse (1 Chron. ii, 13-17), she is not styled his daughter, but only referred to as the sister of David; a distinction which does not at first sight strike the reader, and the force of which could not indeed be learned without the information furnished in the book of Samuel. So also 2 Chron. vii, 7-10 explains the abbreviated statement (1 Kings viii, 65), and the otherwise contradictory expression "the eighth day," verse 66—a proof how many of the discrepancies arise simply from the brevity of the statement.

b. The scrupulous exactness with which the writer excerpts from the original documents is vouched for by the fact of his sometimes retaining the very words, although involving expressions no longer applicable to his own time—a practice which, strange to say, has furnished ground to assail his accuracy. Thus the

Simeonites are said to possess the seats of the Amalckites in Mount Seir, dwelling there "unto this day" (1 Chron. iv, 42, 43), although, long prior to the composition of the history, they had been removed from all their possessions. So also, in the account of the removal of the ark to Solomon's Temple, it is added, "and there it is unto this day" (2 Chron. v, 9).

c. But of more importance is the indirect confirmation given to several statements in the Chronicles by other passages of Scripture. Thus Hezekiah's preparations in fortifying Jerusalem when threatened by Sennacherib—his stopping the fountains and "the brook that ran through the midst of the land" (2 Chron. xxxii, 1-6), are fully confirmed by Isa. xxii, 8-11. Again, Psalm xlviii, 13, etc., probably refers to the victory of Jehoshaphat (2 Chron. xx). A further reference to this victory of Jehoshaphat is found in Joel iv [iii], the prophetic vision resting on this history, which is thus the foundation of the divine judgment on the enemies of the theocracy. (See Hävernick, *Einleitung*, II, i, 216.) In the reign of Jehoram the Philistines and Arabians invaded Judah, plundered the royal palace, and carried away the king's sons and wives (2 Chron. xxi, 16, 17). To this incident the prophet Joel refers (ch. iv [iii], 5, 6), where the Philistines are threatened for their plundering of the Lord's property and sale of the Israelitish captives; the same also in Amos i, 6. The Philistines again, in the time of Ahaz, invaded the south of Judah, and took several important cities (2 Chron. xxviii, 18). With this agrees the prophecy of Isa. xiv, 28-32, which again finds its fulfilment in 2 Kings xviii, 8.

It is important also to notice how the Chronicles form a commentary on various passages of the other books, and evince the accuracy of such statements as at first sight seem to contain discrepancies. Thus, in 2 Sam. vii, 5, no reason is assigned why David should not build the house of the Lord; and in 1 Kings v, 17 [8], in the message of Solomon to Hiram, an external reason only is assigned, as the heathen prince could not comprehend the deeper one. This, however, is given in David's communication first to Solomon (1 Chron. xxii, 8), and afterwards to Israel in assembly (1 Chron. xxviii, 8). The addition, "But I have chosen Jerusalem, that my name might be there" (2 Chron. vi, 6, comp. with 1 Kings vii, 16), is exceedingly important: the choice of Jerusalem, as the centre of the theocracy, was dependent on the choice of David to be ruler over Israel—the one was included in the other (2 Sam. vii). The truthfulness of the history may be said to be even attested by the names of the exiles born shortly before the restoration, from their so naturally reflecting the hopes which about that time must have been strongly entertained. Thus 1 Chron. iii, 19, 20: Hananiah (*Jehovah's grace*); Berechiah (*Jehovah's blessing*); Hasadiah (*Jehovah's mercy*); and Jushabhesd (*mercy's return*).—Kitto, s. v.; Smith, s. v.; Fairbairn, s. v.

VIII. *Exegetical Helps*.—The principal works introductory to these books specially are: Dahler, *De lib. Paralipomenon auctoritate* (Argent. 1819, 8vo); Gramberg, *Die Chronik nach ihrem geschichtl. Charakter* (Halle, 1823, 8vo); Movers, *Unters. üb. d. Chronik* (Bonn, 1824, 8vo); Keil, *Veruch üb. d. Chronik* (Beri. 1833, 8vo); also De Wette, *Hist.-krit. Unters. üb. d. Bücher d. Chronik*, in his *Beitr. zur Kritik des A. T.* i, 1-152; and against this, Hertz's *Vers. s. Vertheid. d. Chronik* (Altona, 1822, 8vo). Compare the *Einleitungen* of De Wette, Eichhorn, Jahn, Hävernick, Keil, and especially Bleek (1860); also Davidson in Horne's *Introduct.* (new ed. ii, 673-688); finally, the remarks by Gesenius, *Gesch. d. hebr. Sprache* (Lpz. 1815). See **INTRODUCTION**.

Express commentaries on Chronicles are few and defective; in the following list, the most valuable are indicated by an asterisk [*] prefixed: Jerome, *Questiones* (in his *Opp. [Spuria]*, iii, 789); Theodoret,

Questiones (Opp. i, pt. 1); Procopius, *Scholía* (in *Opp.* viii, 1); Maurus, *Commentarii* (Opp.); Rashi and Kimchi's *Commentaries* (in Buxtorf's *Biblia Hebr.* iv); Sarcer, *Commentarius* (Basil, 1660, 4to); Strigel, *Commentarius* (Lips. 1583, 1591, fol.); *Lavater, *Commentarius* (Zür. 1578; Heidelberg, 1599, fol.); Leonhart, *Hypomnemata* (Erf. 1608, 1614, 8vo); Serrarius, *Commentaria* (Mogunt. 1609-10, 2 vols. fol.); Sanctius, *Commentarii* (Antw. 1624; Lyons, 1625, fol.); Bonfrère, *Commentarius* (Tornaci, 1648, 2 vols. fol.); Jackson, *Annotationes* (Camb. 1646, 2 vols. 4to); Beck, *Paraphrasia Chaldaica cum notis* (Aug. Vind. 1680, 4to); Wilkins, *Rabbi Josephi Paraphr. Chald.* (Cantab. 1717; Amsterd. 1725, 4to); Corn. a Lapide, *Lit. Paralip.* (in his *Commentaria*); Michaelis and Rambach, in the *Annotationes in Hagiogr.* iii, 245 (Hal. 1720); *Horsley, *Notes* (in the *Bibl. Crit.* i); Jeitteles, *פירושים* (Vienna, 1835, 8vo); Weisse, *פירושים* (Prague, 1836, 8vo); Königsfeldt, *Annotationes* (Havn. 1839, 8vo); *Bertheau, *D. Bücher Der Chronik erklärt* (Lpz. 1854, 8vo, being Lief. 15 of the *Exeg. Hand.*; also in English, Edinburgh, 1857, 8vo); Rahmer, *Commentar* (Thorn, 1866, 6vo, vol. i). See **COMMENTARY**.

Chronology, the science which measures time by the succession of events that occur in the heavens or on the earth. Accordingly, chronology may be divided into two kinds, theoretical or technical, and practical or applied; in other words, into *mathematical and historical*. The former is, of course, the most trustworthy, as being the result of fixed laws; while the latter is, to a great degree, contingent and irregular. In this article we have to do only with Biblical dates and the method of their determination. See **ASTRONOMY**.

I. *Elements*.—The knowledge of the Hebrews in chronology rested altogether on appearances; not a trace of anything like a scientific view is to be found in their literature. The books of the Old Testament recognise none of the great eras which other nations have employed. Nor is it until the first book of the Maccabees that any such guide is found. Instead of these, the Hebrew writers usually employ more limited and local or national epochs. (See below.) Genealogical tables, indeed, are not wanting, but they are of little service for the general purposes of chronology. (See below.) Formerly great exactness was hoped for in the determination of Hebrew chronology. Although the materials were often not definite enough to fix a date within a few years, it was nevertheless expected that the very day could be ascertained. Hence arose unsoundness and variety of results, and ultimately a general feeling of distrust. At present critics are rather prone to run into this latter extreme. The truth, as might be expected, lies between these two extreme judgments. The character of the records whence we draw our information forbids us to hope for a perfect system. The Bible does not give a complete history of the times to which it refers; in its historical portions it deals with special and detached periods. The chronological information is, therefore, not absolutely continuous, although often, with the evident purpose of forming a kind of connection between these different portions, it has a more continuous character than might have been expected. It is rather historical than strictly chronological in its character, and thus the technical part of the subject depends, so far as the Bible is concerned, almost wholly upon inference. See **HISTORY**.

In one particular, however, great care has usually been exercised in the Hebrew records, namely, the prevention of error by the neglect or accumulation of *fractional parts of a year* in the continuous series of generations, dynasties, or reigns. This has been systematically done (as in most other ancient chronologies) by adding these into the beginning of each successive number, i. e. by reckoning, in all cases, from a

fixed point in the calendar, so that the years are always to be accounted "full" unless specified as current. Nevertheless, in consequence of the brief and sometimes double lines of *seras*, beginning at various seasons of the year, confusion, or at least difficulty, has often crept into the statements, which is enhanced by the fact that the rule here stated is not observed with absolute uniformity. All this is especially illustrated in the parallel lists of the kings of JUDAH and ISRAEL (q. v.).

1. *Generations*.—It is commonly supposed that the genealogies given in the Bible are invariably continuous. When, however, we come to examine them closely, we find that many are broken, without being in consequence *technically* defective as Hebrew genealogies. A notable instance is that of the genealogy of our Saviour given by Matthew, where Joram is immediately followed by Ozias, as if his son—Ahaziah, Josiah, and Amaziah being omitted (Matt. i, 8). That this is not an accidental omission of a copyist is evident from the specification of the number of generations from Abraham to David, from David to the Babylonian Captivity, and from the Babylonian Captivity to Christ, in each case fourteen generations. Probably these missing names were purposely left out to make the number for the interval equal to that of the other intervals, such an omission being obvious and not liable to cause error. In Ezra's genealogy (Ezra vii, 1-5) there is a similar omission, which in so famous a line can scarcely be attributed to the carelessness of a copyist. There are also examples of a man being called the son of a remote ancestor, as "Shebuel the son of Gershom [Gershom], the son of Moses" (1 Chron. xxvi, 24). So, in historical narratives, Jehu is called "the son of Nimshi" (1 Kings xix, 16; 2 Kings ix, 20; 2 Chron. xxii, 7), as well as "the son of Jehoshaphat the son of Nimshi" (1 Kings ix, 2, 14). Lehan is called "the son of Nahor" (Gen. xix, 5) for grandson (xxviii, 2, 5; comp. xxii, 20-23). We cannot, therefore, venture to use the Hebrew genealogical lists to compute intervals of time except where we can prove each descent to be immediate, and where the length of each generation is given. See **GENEALOGY**. Ideler remarks that Moses reckons by generations (*Handbuch*, i, 506); but this is not the manner of Herodotus, who assumes an average of three generations to a century (ii, 142). There is no use of a generation as a division of time in the Pentateuch, unless, with some, we suppose that דור, a "generation," in Gen. xv, 16, is so used; those, however, who hold this opinion make it an interval of a hundred years, since it would, if a period of time, seem to be the fourth part of the 400 years of verse 18; most probably, however, the meaning is that some of the fourth generation should come forth from Egypt. See **GENERATION**.

2. *Divisions of Time*. See **TIME**. (1.) *Hour*.—The hour is supposed to be mentioned in Daniel (iii, 6, 15; iv, 16, 80 [Engl. 19, 33; v, 5]), but in no one of these cases is a definite period of time clearly intended by the Chald. term שעה, שעות, שעות, שעות employed. The Egyptians divided the day and night into hours like ourselves from at least B.C. cir. 1200 (Lepsius, *Chronologie der Äg.* i, 180). It is therefore not improbable that the Israelites were acquainted with the hour from an early period. The "sun-dial of Ahaz," whatever instrument, fixed or movable, it may have been, implies a division of the kind. See **DIAL**. In the N. T. we find the same system as the modern, the hours being reckoned from the beginning of the Jewish night and day. See **HOUR**.

(2.) *Day*.—For the civil day of 24 hours we find in one place (Dan. viii, 14) the term ערב בקר, "evening-morning," Sept. *συνθήμερον* (also in 2 Cor. xi, 25, A. V. "a night and a day"). Whatever may be the proper meaning of this Hebrew term, it cannot be

doubted here to signify "nights and days." The common word for day as distinguished from night is also used for the civil day, or else both day and night are mentioned to avoid vagueness, as in the case of Jonah's "three days and three nights" (Jon. ii, 1 [A. V. i, 17]; comp. Matt. xii, 40). The civil day was divided into night and natural day, the periods of darkness and light (Gen. i, 5). It commenced with night, which stands first in the special term given above.

The night, לילה, and therefore the civil day, is generally held to have begun at sunset. Ideler, however, while admitting that this point of time was that of the commencement of the civil day among all other nations known to us which followed a lunar reckoning, objects to the opinion that this was the case with the Jews. He argues in favor of the beginning of deep night, reasoning that, for instance, in the ordaining of the Day of Atonement, on the 10th of the 7th month, it is said "in the ninth [day] of the month at even, from even unto even, shall ye celebrate (literally, rest) your Sabbath" (Lev. xxiii, 32); where, if the civil day began at sunset, it would have been said that they should commence the observance on the evening of the 10th day, or merely on the 10th day, supposing the word "evening" (ערב) to mean the later part of our afternoon. He cites, as probably supporting this view, the expression בין הערבים, "between the two evenings" used of the time of offering the passover and the daily evening sacrifice (Exod. xii, 6; Num. ix, 3; xxviii, 4); for the Pharisees, whom the present Jews follow, took it to be the time between the 9th and 11th hours of the day, or our 8 and 5 P.M., although the Samaritans and Karaites supposed it to be the time between sunset and full darkness, particularly on account of the phrase כבוד השמש, "when the sun is setting," used in a parallel passage (Deut. xvi, 6) (see *Handbuch*, i, 482-484). These passages and expressions may, however, be not unreasonably held to support the common opinion that the civil day began at sunset. The term "between the two evenings" can scarcely be supposed to have originally indicated a long period; a special short period, though scarcely a point, the time of sunset, is shown to correspond to it. This is a natural division between the late afternoon, when the sun is low, and the evening, when his light has not wholly disappeared—the two evenings into which the natural evening would be cut by the commencement of the civil day, if it began at sunset. There is no difficulty in the command that the observance of so solemn a day as that of Atonement should commence a little before the true beginning of the civil day, that due preparation might be made for the sacrifices. In Judaea, where the duration of twilight is very short at all times, the most natural division would be at sunset. The natural "day" (יום) probably was held to commence at sunrise, morning-twilight being included in the last watch of the night, according to the old as well as the later division; some, however, made the morning-watch part of the day. See **DAY**; **NIGHT**. Four natural periods, smaller than the civil day, are mentioned. These are ערב, evening, and בקר, morning, of which there is frequent mention, and the less usual ערבים, "the two lights," as though "double light," noon, וצאת השמש, or —הערב, "half the night," midnight. No one of these with a people not given to astronomy seems to indicate a point of time, but all to designate periods, evening and morning being, however, much longer than noon and midnight. The night was divided into watches (אשכולות). In the O. T. but two are expressly mentioned, and we have to infer the existence of a third, the first watch of the night. (In Lam. ii, 19, אשכולות ראש אשכולות, of course refers to, without absolutely designating, the first watch.) The middle watch

(הַאֲשֵׁמֶרֶת הַחֵמִיכָה) occurs in Judg. vii, 19, where the connection of watches with military affairs is evident: "And Gideon and the hundred men that [were] with him went down unto the extremity of the camp at the beginning of the middle watch; [and] they had but set the watchmen הַשָּׁמֶרֶת." The morning-watch (אֲשֵׁמֶרֶת הַבֹּקֶר) is mentioned in Exod. xiv, 24, and 1 Sam. xi, 11; in the former case, in the account of the passage of the Red Sea; in the latter, in that of Saul's surprise of the Ammonites when he relieved Jabesh-gilead. Some Rabbins hold that there were four watches (Ideler, *Handbuch*, i, 486). In the N. T. four night-watches are mentioned, which were probably adopted from the Romans as a modification of the old system. All four occur together in Mark xiii, 35: *ὄψις*, the late watch; *μισσοκρασιον*, midnight; *ἀλεκτροφωνία*, the cock-crowing; and *πρωτὴ*, the early watch. See WATCHES OF NIGHT.

(3.) *Week* (שָׁבֻעַ, a hebdomad).—The Hebrew week was a period of seven days, ending with the Sabbath; therefore it could not have been a division of the month, which was lunar, without intercalation. But there was no such intercalation, since the Sabbath was to be every seventh day; its name is used for week, and weeks are counted on without any additional day or days. The mention together of Sabbaths and new moons proves nothing but that the two observances were similar, the one closing the week, the other commencing the month. The week, whether a period of seven days, or a quarter of the month, was of common use in antiquity. The Egyptians, however, were without it (with Dion Cassius, xxxvii, 19, comp. Lepsius, *Chronol. d. Äg.* i, 181, 188), dividing their month of 30 days into decades, as did the Athenians. The Hebrew week, therefore, cannot have been adopted from Egypt; probably both it and the Sabbath were used and observed by the patriarchs. See WEEK; SABBATH.

(4.) *Month* (חֹדֶשׁ יָמִים, חֹדֶשׁ יָרֵד).—The months by which the time is measured in the account of the Flood may have been of 30 days each, possibly forming a year of 360 days, for the 1st, 2d, 7th, and 10th months are mentioned (Gen. viii, 18; vii, 11; viii, 14, 4, 5). Ideler, however, contends this, arguing that as the water first began to sink after 150 days (and then had been 15 cubits above all high mountains), it must have sunk for some days ere the ark could have rested on Ararat, so that the second date must be more than 150 days later than the first (*Handbuch*, i, 69, 70, 478, 479). This argument depends upon the meaning of "high mountains," and upon the height of those—"the mountains of Ararat" (viii, 4), on which the ark rested, questions connected with that of the universality of the Flood. See DELUGE. On the other hand, it must be urged that the exact correspondence of the interval to five months of 30 days each, and the use of a year of 360 days, in prophetic passages of both Testaments, are of no slight weight. That the months from the giving of the Law until the time of the Second Temple, when we have certain knowledge of their character, were always lunar, appears from the command to keep new-moons, and from the unlikelihood of a change in the calendar. These lunar months have been supposed to have been always alternately of 29 and 30 days. Their average length would of course be a lunation, or a little (44') above 29½ days, and therefore they would in general be alternately of 29 and 30 days; but it is possible that occasionally months might occur of 28 and 31 days, if, as is highly probable, the commencement of each was strictly determined by observation; that observation was employed for this purpose is distinctly affirmed in the Babylonian Talmud of the practice of the time at which it was written, when, however, a month was not allowed to be less than 29, or more than 30 days in length. The first day of the month is called חֹדֶשׁ, "new moon;"

Sept. *νεομηνία*, from the root חָדַשׁ, *to be new*; and in speaking of the first day of a month this word was sometimes used with the addition of a number for the whole expression, "in such a month, on the first day," as בְּיוֹם הַחֹדֶשׁ בְּחֹדֶשׁ הַשְּׁלִישִׁי, "On the third new-moon . . . on that day" (Exod. xix, 1); hence the word came to signify month, though then it was sometimes qualified (חֹדֶשׁ יָמִים). The new-moon was kept as a sacred festival (q. v.). In the Pentateuch and Joshua, Judges and Ruth, we find but one month mentioned by a special name, the rest being called according to their order. The month with a special name is the first, which is called חֹדֶשׁ נְאֻמֵיב (Sept. *μηνὸν ὠνὸν νεῖον*), "the month of ears of corn," or "Abib," that is, the month in which the ears of corn became full or ripe, and on the 16th day of which, the second day of the feast of unleavened bread, ripe ears, כֹּמֶץ, were to be offered (Lev. ii, 14; comp. xxxiii, 10, 11, 14). This undoubted derivation shows how erroneous is the idea that *Abib* comes from the Egyptian *Epiphā*. In 1 Kings three other names of months occur, *Zif*, זִיף, or זִי, the second; *Ethanim*, אֶתְנָנִים, the seventh; and *Bul*, בּוּל, the eighth. These names appear, like that of *Abib*, to be connected with the phenomena of a tropical year. No other names are found in any book prior to the Captivity, but in the books written after the return the later nomenclature still in use appears. This is evidently of Babylonian origin, as the Jews themselves affirm. See MONTH.

(5.) *Year* (שָׁנָה).—It has been supposed, on account of the dates in the narrative of the Flood, as already mentioned, that in Noah's time there was a year of 360 days. These dates may indeed be explained in accordance with a year of 365 days. The evidence of the prophetic Scriptures is, however, decisive as to the knowledge of a year of the former length. The "time, times and a half" of Dan. (vii, 25; xii, 7), where *time* means *year* (see xi, 18), cannot be doubted to be equivalent expressions to the 42 months and 1260 days of Rev. (xi, 2, 3; xii, 6), for $360 \times 3\frac{1}{2} = 1260$; and $50 \times 42 = 2100$. We have also the testimony of ancient writers that such a year was known to some nations, so that it is probable that the year of Noah was of this length, whatever may have been that of the months referred to by Moses in the narrative of the Flood (q. v.).

The characteristics of the year instituted at the Exodus can be clearly determined, though we cannot absolutely fix those of any single year. There can be no doubt that it was essentially tropical, since certain observances connected with the produce of the land were fixed to particular days. It is equally clear that the months were lunar, each commencing with a new moon. It would appear, therefore, that there must have been some mode of adjustment. To ascertain what this was, it is necessary first to decide when the year commenced. On the 16th day of the month *Abib*, as already mentioned, ripe ears of corn were to be offered as first-fruits of the harvest (Lev. ii, 14; xxxiii, 10, 11). The reaping of the barley commenced the harvest (2 Sam. xxi, 9), the wheat following (Ruth ii, 23). Josephus expressly says that the offering was of barley (*Ant.* iii, 10, 5). It is therefore necessary to find when the barley becomes ripe in Palestine. According to the observation of travellers, the barley is ripe, in the warmest parts of the country, in the first days of April. The barley-harvest therefore commences about half a month after the vernal equinox, so that the year would begin at about that tropical point were it not divided into lunar months. We may conclude that the nearest new moon about or after the equinox, but not much before, was chosen as the commencement of the year. Ideler, whom we have thus far followed as to this year, concludes that the right

new moon was chosen through observation of the forwardness of the barley-crops in the warmer districts of the country (*Handbuch*, i, 490). There is, however, this difficulty, that the different times of barley-harvest in various parts would have been liable to cause confusion. It seems, therefore, not unlikely that the Hebrews adopted the surer means of determining their new-year's day by observations of heliacal risings or similar stellar phenomena known to mark the right time before the barley-harvest. Certainly the ancient Egyptians and the Arabs made use of such means. The method of intercalation can only have been that which obtained after the Captivity—the addition of a thirteenth month, whenever the twelfth ended too long before the equinox for the first-fruits of the harvest to be offered in the middle of the month following, and the similar offerings at the times appointed. This method would be in accordance with the permission granted to postpone the celebration of the Passover in the case of any one who was either legally unclean or journeying at a distance, for a whole month, to the 14th day of the second month (Num. ix, 9-13), of which permission we find Hezekiah to have availed himself for both the reasons allowed, because the priests were not sufficiently sanctified and the people were not collected (2 Chron. xxx, 1-8, 15). The later Jews had two beginnings to the year, or, as it is commonly, but somewhat inaccurately said, two years. At the time of the Second Temple these two beginnings obtained, the seventh month of the civil reckoning being Abib, the first of the sacred. Hence it has been held that the institution at the time of the Exodus was merely a change of commencement, and not the introduction of a new year; and also that from this time there were the two beginnings. The former opinion is at present purely hypothetical, and has been too much mixed up with the latter, for which, on the contrary, there is some evidence. See YEAR.

(6.) *Seasons.*—The ancient Hebrews do not appear to have divided their year into fixed seasons. We find mention of the natural seasons, *קַיִץ*, "summer," and *חֹרֵף*, "winter," which are used for the whole year (in Psa. lxxiv, 17; Zech. xiv, 8; and perhaps Gen. viii, 22). The former of these properly means the time of cutting fruits, and the latter that of gathering fruits; the one referring to the early fruit season, the other to the late one. Their true significations are, therefore, rather summer and autumn than summer and winter. There can be no doubt, however, that they came to signify the two grand divisions of the year, both from their use together as the two seasons, and from the mention of the "winter-house" (*בַּיִת חֹרֵף*) and the "summer-house" (*בַּיִת קַיִץ*, Amos iii, 15). The latter evidence is the stronger, since the winter is the time in Palestine when a palace or house of different construction would be needed from the light summer pavilion, and in the only passage besides that referred to in which the winter-house is mentioned, we read that Jebiakiim "sat in the winter-house in the ninth month;" that is, almost at mid-winter; "and [there was a fire] on the hearth burning before him" (Jer. xxxvi, 22). It is probable, however, that "winter," or *חֹרֵף*, when used without reference to the year, as in Job xxix, 4, has its original signification. The phrase *קַיִץ חֹרֵף*, "cold and heat," in Gen. viii, 22, is still more general, and cannot be held to indicate more than the great alternations of temperature, which, like those of day and night, were promised not to cease (Ideler, *Handbuch*, i, 494). There are two agricultural seasons of a more special character than the preceding in their ordinary use. These are *זֶמַן*, "seed-time," and *קַצִּיר*, "harvest." Ideler makes these equal to the foregoing seasons when similarly used together; but he has not proved this, and the passage he quotes (Gen. i. c.) cannot be held to afford any evidence of the

kind, until some other two terms in it are proved to be strictly correspondent. See SEASON.

3. *Festivals and Holy Days.*—Besides the Sabbaths and new-moons, there were four great festivals and a fast in the ancient Hebrew year, and a great celebration every seventh and fiftieth year. See FESTIVAL.

(1.) The Feast of the Passover (*פֶּסַח*) was properly only the time of the sacrifice and eating of the paschal lamb, that is, the evening, *בֵּינָיִם הַלַּיְלָה*, "between the two evenings" (Lev. xxiii, 5)—a phrase previously considered—of the 14th day of the first month, and the night following, the Feast of Unleavened Bread (*חֶמֶת הַמַּצּוֹת*) commencing on the morning of the 15th day of the month, and lasting seven days, until the 21st inclusive. The 15th and 21st days of the month were Sabbaths, that is, holy days. See PASSOVER.

(2.) The Feast of Weeks (*חֶג הַשָּׁבֹעוֹת*), or Pentecost, was kept at the close of seven weeks, counted from the day inclusive following the 16th of the 1st month. Hence its name means the feast of seven weeks, as indeed it is called in Tobit (*ἀγία ἑβδομάδων*, ii, 1). As the ears of barley as first-fruits of the harvest were offered on the 16th day of the 1st month, so on this day thanksgiving was paid for the blessing of the harvest, and first-fruits of wheat offered as well as of fruits; hence the names *חֶג הַקַּצִּיר*, Feast of the Harvest, and *יּוֹם הַבְּרִיּוֹת*, Day of the First-fruits. See PENTECOST.

(3.) The Feast of Trumpets, *יּוֹם תְּרוּמָה* (lit. *day of trumpet-sound*), also called *שְׁמֵחוֹן וְקִירוֹן הַתְּרוּמָה*, i. e. "a great festival of celebration by the sound of the trumpet," was the 1st day of the 7th month, the civil commencement of the year. See TRUMPET.

(4.) The Day of Atonement, *יּוֹם הַכִּיפּוּרִים*, was the 10th day of the 7th month. It was a Sabbath, that is, a holy day, and also a fast, the only one in the Hebrew year before the Babylonish Captivity. Upon this day the high-priest made an offering of atonement for the nation. This annual solemn rite seems more appropriate to the commencement than to the middle of the year; and the time of its celebration thus affords some evidence in favor of the theory of a double beginning. See ATONEMENT (DAY OF).

(5.) The Feast of Tabernacles, *חֶג הַסֻּכּוֹת*, was kept in the 7th month, from the 15th to the 22d days inclusive. Its chief days were the first and last, which were Sabbaths. Its name was taken from the people dwelling in tabernacles, to commemorate the Exodus. It was otherwise called *חֶג הַתְּאֻמָּה*, i. e. "the feast of gathering," because it was also instituted as a time of thanksgiving for the end of the gathering of fruit and of the vintage. See TABERNACLES (FEAST OF).

The small number and simplicity of these primitive Hebrew festivals and holy days is especially worthy of note. It is also observable that they are not of an astronomical character; and that when they are connected with nature, it is as directing the gratitude of the people to him who, in giving good things, leaves not himself without witness. In later times many holy days were added. Of these the most worthy of remark are the Feast of Purim, or "Lot," commemorating the deliverance of the Jews from Haman's plot, the Feast of the Dedication, recording the cleansing and re-dedication of the Temple by Judas Maccabæus, and fasts on the anniversaries of great national misfortunes connected with the Babylonish Captivity. These last were doubtless instituted during that period (comp. Zech. vii, 1-5). See PURIM; DEDICATION.

(6.) *Sabbatical and Jubilee Years.*—The sabbatical year, *שְׁמֵטָה*, "the fallow year," or possibly "year of remission," or *שְׁמֵטָה* alone, also called a "sabbath," and a "great sabbath," was an institution of strictly the same character as the Sabbath—a year

of rest, like the day of rest. It has not been sufficiently noticed that as the day has a side of physical necessity with reference to man, so the year has a side of physical necessity with reference to the earth. Every seventh year appears to be a very suitable time for the recurrence of a fallow year, on agricultural principles. Besides the rest from the labors of the field and vineyard, there was in this year to be remission, temporary or absolute, of debts and obligations among the people. The sabbatical year seems to have commenced at the civil beginning of the year, with the seventh month. Although doubtless held to commence with the first of the month, its beginning appears to have been kept at the Feast of Tabernacles (Deut. xxxi, 10), while that of the jubilee year was kept on the Day of Atonement. This institution seems to have been greatly neglected, as indeed was prophesied by Moses, who speaks of the desolation of the land as an enjoying the sabbaths which had not been kept (Lev. xxvi, 34, 35, 48). The seventy years' captivity is also spoken of in 2 Chron. (xxvi, 21) as an enjoying sabbath; but this may be on account of the number being sabbatical, as ten times seven, which, indeed, seems to be indicated in the passage. After the lapse of seven sabbatical periods, or forty-nine years, a year of jubilee was to be kept, immediately following the last sabbatical year. This was called שָׁמֵר יְהוֹיָכִן, "the year of the trumpet," or יְהוֹיָכִין alone, the latter word meaning either the sound of the trumpet or the instrument itself, because the commencement of the year was announced on the Day of Atonement by sound of trumpet. It was similar to the sabbatical year in its character, although doubtless yet more important. In the jubilee year debts were to be remitted, and lands were to be restored to their former owners. It is obvious from the words of the law (Lev. xxv, 8-11) that this year followed every seventh sabbatical year, so that the opinion that it was always identical with a sabbatical year is untenable. There is a further question as to the length of each jubilee period, if we may use the term, some holding that it had a duration of fifty, but others of forty-nine years. The latter opinion does not depend upon the supposition that the seventh sabbatical year was the jubilee, since the jubilee might be the first year of the next seven years after. That such was the case is rendered most probable by the analogy of the weekly Sabbath, and the custom of the Jews in the first and second centuries B.C.; although it must be noted that, according to Maimonides, the jubilee period was of fifty years, the fifty-first year commencing a new period, and that the same writer mentions that the Jews had a tradition that after the destruction of the first Temple only sabbatical years, and no jubilee years, were observed (Ideler, *Handbuch*, i, 508, 504). The testimony of Josephus does not seem to us at all conclusive, although Ideler (*l. c.*) holds it to be so; for his language (ταῦτα πενήκοντα μὲν ἴσθιν ἐστὶν τὰ πάγια, *Ant.* iii, 12, 8) cannot be held to prove absolutely that the jubilee year was not the first year of a sabbatical period, instead of standing between two such periods.—It is important to ascertain when the first sabbatical year ought to have been kept; whether the sabbatical and jubilee periods seem to have been continuous; what positive record there is of any sabbatical or jubilee years having been kept; and what indications there are of a reckoning by such years of either kind. 1. It can scarcely be contested that the first sabbatical year to be kept after the Israelites had entered Canaan would be about the fourteenth (Jennings, *Jewish Antiquities*, bk. iii, cap. 9). It is possible that it might have been somewhat earlier or later; but the narrative will not admit of much latitude. 2. It is clear that any sabbatical and jubilee years kept from the time of Joshua until the destruction of the first Temple would have been reckoned from the first one, but it may be questioned if any

kept after the return would be counted in the same manner: from the nature of the institutions, it is rather to be supposed that the reckoning, in the second case, would be from the first cultivation of the country after its reoccupation. The recorded sabbatical years do not enable us to test this supposition, because we do not know exactly the year of return, or that of the first cultivation of the country. The recorded dates of sabbatical years would make that next after the return to commence in B.C. 528, and be current in B.C. 527, which would make the first year of the period B.C. 584-8, which would not improbably be the first year of cultivation; but in the case of so short a period this cannot be regarded as evidence of much weight. 3. There is no positive record of any jubilee year having been kept at any time. The dates of three sabbatical years have, however, been preserved. These were current B.C. 168, 185, and 87, and therefore commenced in each case about three months earlier than the beginning of these Julian years (Josephus, *Ant.* xii, 9, 5; xiii, 8, 1; xiv, 16, 2; xv, 1, 2; *War.* i, 2, 4; and 1 *Macc.* vi, 49, 58). 4. There are some chronological indications in the O. T. that may not unreasonably be supposed to be connected with the sabbatical system. The prophet Ezekiel dates his first prophecy of those in the book "in the thirtieth year," etc., "which [was] the fifth year of king Jehoiachin's captivity" (i, 2); thus apparently dating in the former case from a better known era than that of Jehoiachin's captivity, which he employs in later places, without, however, in general again describing it. This date of the 80th year has been variously explained; some, with Usher, suppose that the era is the 18th year of Josiah, when the book of the law was found, and a great passover celebrated (see Hävernick, *Commentar über Ezech.* p. 12, 18). This year of Josiah would certainly be the first of the reckoning, and might be used as a kind of reformation-era, not unlike the era of Simon the Maccabees. Others suppose that the thirtieth year of the prophet's life is meant, but this seems very unlikely. Others again, including Scaliger (*De Emendatione Temporum*, p. 79, 218, ed. 1688) and Rosenmüller (*Schol.* in loc.), hold that the date is from the commencement of the reign of Nabopolassar. There is no record of an era of Nabopolassar; that king had been dead some years; and we have no instance in the O. Test. of the use of a foreign era. The evidence, therefore, is in favor of Josiah's 18th year, B.C. 623. There seems to be another reference to this date in the same book, where the time of the iniquity of Judah is said to be 40 years; for the final captivity of Judah (*Jer.* lii, 80) was in the 41st year of this reckoning. In the same place (*Ezek.* iv, 5, 6) the time of the iniquity of Israel is said to be 390 years, which sum, added to the date of the captivity of this part of the nation, B.C. 720, goes back to B.C. 1111. This result leads to the indication of possible jubilee dates; for the interval between B.C. 1111 and B.C. 623-2 is 488-9 years, almost exactly ten jubilee periods; and it must be remembered that the seventy weeks of the prophet Daniel seem to indicate the use of such a great cycle. It remains to be asked whether the accounts of Josiah's reformation present any indications of celebrations connected with the sabbatical system. The finding of the book of the Law might seem to point to its being specially required for some public service. Such a service was the great reading of the Law to the whole congregation at the Feast of Tabernacles in every sabbatical year (Deut. xxxi, 10-13). The finding of the book was certainly followed by a public reading, apparently in the first month, by the king to the whole people of Judah and Jerusalem, and afterwards a solemn passover was kept. Of the latter celebration it is said in Kings, "Surely there was not holden such a passover from the days of the Judges that judged Israel, nor in all the days of the kings of Israel, nor of the kings of Judah" (2 Kings xxiii, 22); and in

Chronicles, "There was no passover like to that kept in Israel from the days of Samuel the prophet; neither did all the kings of Israel keep such a passover as Josiah kept" (2 Chron. xxv, 18). The mention of Samuel is remarkable, since in his time the earlier supposed date (B.C. 1111) falls. It may be objected that the passover is nowhere connected with the sabbatical reckoning; but these passovers can scarcely have been greater in sacrifices than at least one in Solomon's reign, nor is it likely that they are mentioned as characterized by greater zeal than any others whatever, so that we are almost driven to the idea of some relation to chronology. See **SABBATICAL YEAR**; **JURILEX**.

4. *Eras*.—There are indications of several historical eras having been used by the ancient Hebrews, but our information is so scanty that we are generally unable to come to positive conclusions. Some of these possible eras may be no more than dates employed by writers, and not national eras; others, however, can scarcely have been used in this special or individual manner from their referring to events of the highest importance to the whole people. See **EPOCH**.

(1.) The Exodus is used as an era in 1 Kings vi, 1, in giving the date of the foundation of Solomon's Temple. This is the only positive instance of the occurrence of this era, for we cannot agree with Ideler that it is certainly employed in the Pentateuch. He refers to Exod. xix, 1, and Num. xxxiii, 38 (*Handbuch*, i, 507). Here, as elsewhere in the same part of the Bible, the beginning of the Exodus-year—not, of course, the actual date of the Exodus (see *Regnal years*, below)—is used as the point whence time is counted; but during the interval of which it formed the natural commencement it cannot be shown to be an era, though it may have been, any more than the beginning of a sovereign's reign is one. See **EXODUS**.

(2.) The foundation of Solomon's Temple is conjectured by Ideler to have been an era. The passages to which he refers (1 Kings ix, 10; 2 Chron. viii, 1) merely speak of occurrences subsequent to the interval of 20 years occupied in the building of the Temple and the king's house, both being distinctly specified; so that his reading ("Zwanzig Jahre, nachdem Salomo das Haus des Herrn erbaute") leaves out half the statement, and so makes it incorrect (*Handb.* i. c.). It is elsewhere stated that the building of the Temple occupied seven years (1 Kings vi, 37, 38), and that of Solomon's house thirteen (vii, 1), making up the interval of twenty years. See **TEMPLE**.

(3.) The era once used by Ezekiel, and commencing in Josiah's 18th year, we have discussed above. See **JOSIAH**; **EZEKIEL**.

(4.) The era of Jehoiachin's captivity is constantly used by Ezekiel. The earliest date is the 5th year (i, 2), and the latest the 27th (xxix, 17). The prophet generally gives the date without applying any distinctive term to the era. He speaks, however, of "the fifth year of king Jehoiachin's captivity" (i, 2), and "the twelfth year of our captivity" (xxiii, 21), the latter of which expressions may explain his constant use of the era. The same era is necessarily employed, though not as such, where the advancement of Jehoiachin in the 37th year of his captivity is mentioned (2 Kings xxv, 27; Jer. lii, 81). We have no proof that it was used except by those to whose captivity it referred. Its first year was current B.C. 598, commencing in the spring of that year. See **JEHOIACHIN**.

(5.) The beginning of the seventy years' captivity does not appear to have been used as an era; but the destruction of Jerusalem by the Babylonians is occasionally referred to for chronological purposes (Ezek. xl, 1). See **CAPTIVITY**.

(6.) The return from Babylon does not appear to be employed as an era; it is, however, reckoned from in Ezra (iii, 1, 8), as is the Exodus in the Pentateuch. See **EZRA**.

(7.) The era of the Seleucids is used in the first and second books of Maccabees. See **SELEUCUS**.

(8.) The liberation of the Jews from the Syrian yoke in the first year of Simon the Maccabee is stated to have been commemorated by an era used in contracts and agreements (1 Macc. xiii, 41). The years 1, 2, and 3 on the coins ascribed to Simon [see **MOSEY**; **SHEKEL**] are probably of this era, although it is related that the right of coining money with his own stamp was not conceded to him until somewhat later than its beginning (xv, 6), for it may be reasonably supposed either that Antiochus VII confirmed privileges before granted by his brother Demetrius II (comp. xv, 5), or that he gave his sanction to money already issued (*Encycl. Brit.*, 8th ed., s. v. Numismatics, p. 379, 380). See **MACCABEES**.

(9.) *Regnal Years*.—By the Hebrews regnal years appear to have been counted from the beginning of the year, not from the day of the king's accession. Thus, if a king came to the throne in the last month of one year, reigned for the whole of the next year, and died in the first month of the third year, we might have dates in his first, second, and third years, although he governed for no more than thirteen or fourteen months. Any dates in the year of his accession before that event, or in the year of his death after it, would be assigned to the last year of his predecessor and the first of his successor. The same principle would apply to reckoning from eras or important events, but the whole stated lengths of reigns or intervals would not be affected by it. See **KING**; **KINGDOM**.

II. *Data*.—The historical part of Hebrew chronology is not less difficult than the technical. The information in the Bible is indeed direct rather than inferential, although there is very important evidence of the latter kind; but the present state of the numbers makes absolute certainty in some cases impossible. In addition to this difficulty, there are several gaps in the series of smaller numbers which we have no means of supplying with exactness. When, therefore, we can compare several of these smaller numbers with a larger number, or with independent evidence, we are frequently prevented from putting a conclusive test by the deficiencies in the first series. Lately some have laid great stress upon the frequent occurrence of the number 40, alleging that it and 70 are vague terms equivalent to "many," so that "40 years" or "70 years" would mean no more than "many years." *Primâ facie* this idea would seem reasonable, but on a further examination it will be seen that the details of some periods of 40 years are given, and show that the number is not indefinite where it would at first especially seem to be so. Thus the 40 years in the wilderness can be divided into three periods: 1. From the Exodus to the sending out of the spies was about one year and a quarter (1 year, 1 + x [2?] months, Num. ix, 1; x, 11; comp. ver. 29, showing it was this year, and xiii, 20, proving that the search ended somewhat after midsummer); 2. The time of search, 40 days (Num. xiii, 25); 3. The time of the wandering until the brook Zered was crossed, 38 years (Deut. ii, 14)—making altogether almost 83½ years. This perfectly accords with the date (yr. 40, m. 11, d. 1) of the address of Moses after the conquest of Sihon and Og (Deut. i, 8, 4), which was subsequent to the crossing of the brook Zered. So, again, David's reign of 40 years is divided into 7 years 6 months in Hebron, and 38 in Jerusalem (2 Sam. ii, 11; v, 5; 1 Chron. iii, 4; but 1 Kings ii, 11, 7 years, omitting the months, and 38). This, therefore, cannot be an indefinite number, as some might conjecture from its following Saul's 40 years, and preceding Solomon's. The last two reigns, again, could not have been much more or less from the circumstances of the history. The occurrence of some round numbers, therefore, does not warrant our supposing the constant use of vague ones. See **NUMBER**.

The attempt to "correct" or improve the Hebrew chronology by means of the data lately deciphered from the Egyptian and Assyrian inscriptions has been a favorite method of late, as was in previous times a similar comparison with the relics of ancient records in heathen authors. But, unfortunately, these statements are so discrepant with one another, and the results vary so widely, as to be of very little practical value for such a purpose. The hieroglyphical data are too fragmentary and disconnected, as well as too uncertainly translated hitherto, to afford any definite chronological chain; and the cuneiform legends do not rise so early as the disputed part of Biblical chronology. See EGYPT; ASSYRIA.

1. *From Adam to Abram's departure out of Haran.*—All the numerical data in the Bible for the chronology of this interval are comprised in two genealogical lists in Genesis, the first from Adam to Noah and his sons (Gen. v, 8 to the end), and the second from Shem to Abram (xi, 10-26), and in certain passages in the same book (vii, 6, 11; viii, 13; ix, 28, 29; xi, 32; xii, 4). The Masoretic Hebrew text, the Septuagint Version, and the Samaritan Pentateuch greatly differ, as may be seen by the following table, while the parallel

causes whatever. As no high degree of the lists correspond throughout, and as a high degree of antiquity undoubtedly belongs to them all, each has had its advocates as the true original. The cardinal importance of the subject demands a clear, full, and impartial examination of the arguments that bear upon their authority severally, as well as upon the accuracy of particular numbers. As a preliminary, it must be noted that the variations are the result of design, not accident, as is evident from the years before the birth of a son and the residues agreeing in their sums in almost all cases in the antediluvian generations, the exceptions, save one (Lamech), being apparently the result of necessity that lives should not overlap the date of the Flood (comp. Clinton, *Fasts Hellen.* i, 285). We have no clew to the date or dates of the alterations, except that we can trace the Sept. form to the 1st century of the Christian era, if not higher, and the Heb. to the 4th century; if the Samar. numbers be as old as the text, we can assign them a higher antiquity than what is known as to the Heb. The little acquaintance most of the early Christian writers had with Hebrew makes it impossible to decide, on their evidence, that the variation did not exist when they wrote; the testimony of Josephus

PATRIARCHS.	Before Birth of Heir				After Birth of Heir.			Total Age.			
	Hebrew.	Samar.	Septuagint.	Josephus.	Hebr.	Samar.	Septuagint.	Hebr.	Sam.	Sept.	Josephus.
Adam	130	130	330	230 [330]	800	800	700	930	930	930	930
Seth	105	105	205	205 [105]	807	807	707	912	912	912	912 [906]
Enos	90	90	190	190	815	815	715	905	905	905	905 [910]
Cainan	70	70	170	170	840	840	740	910	910	910	910
Mahalael	65	65	165	165	830	830	730	895	895	895	895
Jared	162	62	162	162	800	785	800	962	847	962	962
Enoch	65	65	165	(165) [187]	800	800	200	865	865	865	865
Methuselah	187	67	187 [167]	187 [171]	732	658	732 [802]	969	730	969	969
Lamech	182	53	185	182 [52]	565	600	565	777	653	758	777 [707]
Noah at the Flood	600	600	600	600							
Noah	(1656)	(1307)	(2262)	(2266)							
Shem	(502)	(502)	(502)		(448)	(448)	(448)	950	950	950	950 [906]
Interval after Flood	2	2	2	19							
Arphaxad	85	85	85	185	408	308	400 [480]		438		
Cainan			180				380				
Salah	80	180	180	180	403	308	330		433		
Eber	84	184	134	184	430	270	270 [370]		404		
Pelag	80	130	180	180	303	100	200		239		
Ren	39	139	139	130	307	107	207		239		
Serug	80	130	130	132	200	100	200		230		
Nahor	80	79	79 [170]	120 [100]	119	69	139 [125]		148		
Terah	70	70	70	70 [180]				205	145	205	205
Abram leaves Haran	75	75	75	75							
From the Flood	(367)	(1017)	(1147)	(1069) 867							
From Creation	(3023)	(2324)	(3309)	(3325) 3575							

accounts of Josephus (*Ant.* i, 8, 3, and 4, 9; 6, 5; 7, 1) do not exactly tally with any of them. The Latin Vulgate strictly conforms to the Hebrew. The principal various readings are given between brackets, and the numbers which are combined from statements in the text are enclosed in a parenthesis. In this period there are a number of serious difficulties.

(1.) The number of generations in the Sept. is one in excess of the Heb. and Samar., on account of the "Second Cainan," whom the best chronologists are agreed in rejecting as spurious. He is found elsewhere only in some copies at 1 Chron. i, 17, and in Luke iii, 36. Josephus, Philo, and the earlier Christian writers appear, however, to have known nothing of him, and it is therefore probable either that he was first introduced by a copyist into the Gospel and thence into the Sept., or else that he was found in some MSS. of the Sept. and thence introduced into the Gospel, and afterwards into all other copies of the Sept. See CAINAN.

(2.) The remarkable discrepancies in nearly all the names as to the respective ages before and after the birth of the eldest son, while the totals given generally agree, has occasioned greater variety in the schemes of different Biblical chronologers than any or all other

is here of more weight, but in his present text it shows contradiction, though preponderating in favor of the Sept. numbers. A comparison of the lists would lead us to suppose, on internal evidence, that they had first two forms, and that the third version of them originated from these two. This supposed later version of the lists would seem to be the Samar., which certainly is less internally consistent, on the supposition of the original correctness of the numbers, than the other two. The cause of the alterations is most uncertain. It has indeed been conjectured that the Jews shortened the chronology, in order that an ancient prophecy that the Messiah should come in the sixth millenary of the world's age might not be known to be fulfilled in the advent of our Lord. The reason may be sufficient in itself, but it does not rest upon sufficient evidence. It is, however, worthy of remark, that in the apostolic age there were hot discussions respecting genealogies (Tit. iii, 9), which would seem to indicate that great importance was attached to them, perhaps also that the differences, or some difference, then existed. The different proportions of the generations and lives in the Sept. and Heb. have been asserted to afford an argument in favor of the former. At a later period, however, when we find instances of longevity

recorded in all versions, the time of marriage is not different from what it is at the present day, although there are some long generations. A stronger argument for the Sept., in view of the unity of the human race, is found in the long period required from the Flood to the Dispersion and the establishment of kingdoms. This supposition would, however, require that the patriarchal generations should be either exceptional or represent periods. For the former of these hypotheses we shall see there is some ground in the similar case of certain generations, just alluded to, from Abraham downwards. With respect to probability of accuracy, arising from the state of the text, the Heb. certainly has the advantage. There is every reason to think that the Rabbins have been scrupulous in the extreme in making alterations; the Sept., on the other hand, shows signs of a carelessness that would almost permit change, and we have the probable interpolation of the post-diluvian Cainan. If, however, we consider the Samar. form of the lists as sprung from the other two, the Sept. would seem to be earlier than the Heb., since it is more probable that the antediluvian generations would have been shortened to a general agreement with the Heb., than that the post-diluvian would have been lengthened to suit the Sept.; for it is obviously most likely that a sufficient number of years having been deducted from the earlier generations, the operation was not carried on with the later. It is noticeable that the stated sums in the post-diluvian generations in the Samar. generally agree with the computed sums of the Heb., and not with those of the Sept., which would be explained by the theory of an adaptation of one of these two to the other, although it would not give us reason for supposing either form to be the earlier. The general presumption, on external grounds, would certainly be in favor of the Heb., both as being unquestionably the original from which the others (except perhaps the Samar., which, singularly enough, is the least probable, on other considerations, of all) are known to have been translated—and a version can never rise higher in authority than its source; and also because of the manifestly greater state of purity in which this text has been transmitted to us, in comparison with either of the others. See SEPTUAGINT; SAMARITAN PENTATEUCH. The text of Josephus is too corrupt in its numbers to be at all relied upon, as may be seen from the slightest comparison of the sums in the title of the chapters with the detailed contents, having doubtless been tampered with by readers who used only the Sept. or Vulg. versions.

There can be no question that the author or last redactor of the book of Genesis intended that the narrative should be connected by this continuous series of time-marks. Jewish and Christian chronographers accepted the statements unquestioned, and held that the series of years of the world thus formed, from the creation of the first man to the death of Joseph, accorded with the truth of facts. The import and the authority of the numerical statements were to them unimpeachable; the only question was that which related to their genuine form. And supposing the inquirer to have decided in favor of the Greek text, even so there are diversities to be discussed, for the Sept. has various readings of some of the numbers both before and after the Flood; in particular, while most of the copies have a second Cainan after Arphaxad, with a descent of 190 years, this addition is ignored by other copies and by important authorities (see Browne, *Ordo Saecul.* § 807, and note; Mill, *On the Descent and Parentage of the Saviour*, p. 143 sq.). These considerations will account for the enormous discrepancy which appears in the estimates formed by different chronologists of the number of years contained in the book of Genesis. The Hebrew numbers, from Adam to Terah's 70th year, make 1656 plus 292 years; the Sept., with its various readings, 2242 or 2262 plus 942, or 1042, or 1072, or 1172; the Samaritan, 1807 plus 942.

This last, however, need not come into consideration, since it is well understood that the Samaritan text, here as elsewhere, is merely fabricated from the Greek (Hengstenberg, *Auth. des Pent.* 1, 82 sq.); and those who treat it as an independent authority (e. g. Lepsius, *Chronol. der Äg.* p. 897 sq.) only show themselves ignorant of the results of criticism on this subject. Of course the Sept., in one or more of its enumerations, would be followed by those early inquirers who had access to that text only; the earliest extant estimate, by Demetrius, an Alexandrine Jew of the third century B.C. (quoted from Alexander Polyhistor by Eusebius, *Præp. Evang.* ix, 21, 12), makes the interval from Adam to the birth of Abraham 2262 plus 1072. Josephus certainly did not follow the Sept.; his numbers in the generations before and after the Flood have been forced into conformity with the Greek by a later and unskilful hand, which betrays itself by leaving its work incomplete (Browne, *Ordo Saecul.* § 819–821). As the chronology of Dr. Hales (which some still accept as authoritative) professes to be based on the Sept., rectified by the aid of Josephus, it ought to be known that the text of this author, besides having been palpably vitiated in this portion of it (*Ant.* 1, 3, 4; 6, 5), swarms with gross inconsistencies, caused, it would seem, by his adopting, without reflection, statements belonging to different chronological systems (see Niebuhr, *Geschichte Assurs u. Babels*, p. 347 sq.). Of the Christian writers of the first three centuries Origen alone knew Hebrew, and he first leaves the Sept., but only in part; Jerome, the learned Hebraist, declares for “the Hebrew verity,” and as his recension of the old italic version forms the basis of the Sixtine Vulgate, which a canon of Trent declares, under anathema, to be canonical and infallible, the Hebrew chronology is virtually perpetuated in the churches of the Roman obedience. The Greek Church still holds by the Sept. Our own popular Bible chronology (Usher's, which Bishop Lloyd attached to the margin of our Bibles) follows the Hebrew. During the last century there has been a disposition, in some of our own and the Continental writers, to abandon the Hebrew for the Sept., chiefly prompted by the wish to enlarge the period before Abraham, so as to allow more time for the growth of nations after the Flood, and (more recently) to facilitate the “connection of sacred and profane chronology” in the earliest ages of mankind, especially with respect to Manetho's Egyptian chronology. The question of probability and inducement—to enlarge on the part of the Alexandrine Jews (comp. Bunsen, *Äg. St.* v, 68), to contract on the part of the Masoretes—is discussed in Browne's *Ordo Saeculorum*, § 808 sq.; and the artificial processes by which the Sept. numbers are formed from the Hebrew, and not *vice versa*, have been exposed by the same writer, *ib.* § 818 sq., and further in *The Cycles of Egyptian Chronology*, § 72 (Arnold's *Theological Critic*, ii, 145 sq.). The fundamental importance of the subject in Biblical chronology requires a more exact and detailed examination than we find in the Dictionaries of Smith and Kitto, from which the preceding investigations are chiefly taken, and are also portions of subsequent discussions in this article.

(a.) *General Internal Evidence.*—It is a noticeable fact that in the antediluvian portion the Heb. is the only list (unless we except that of Josephus, which has no independent value) in which every number is corroborated by the corresponding one in some one or other of the rest; while in the post-diluvian line, after the exclusion of the second Cainan, it stands almost alone: the preponderance of evidence from this method of comparison is therefore about balanced. Again, it is a most suspicious circumstance in the Samar. that its numbers, where there is any variation, regularly lessen the period prior to parentage, as the lineage descends, by removing the irregular hundred years before the Flood, and annexing it to the ages below that

point; while the Sept. (and Josephus) attain a similar uniformity by adding one hundred years to the deficient numbers throughout; whereas the Heb. exhibits no such marks of gradation, but presents a natural irregularity in this respect, although the numbers, on the whole, decrease as the period of longevity contracts; while, on the other hand, if either of the other lists be assumed as the prototype, no possible reason can be assigned or imagined for the arbitrary enlargement or diminution here and there of a particular number. The briefer scheme of the Heb. post-diluvian genealogy is also exactly sustained by the sum 867 (i. e. the birth of Abram 292 years from the Deluge + 75 years to his departure from Haran) definitely given by Josephus, in opposition to his own magnified numbers in detail, although the weight of this argument is affected by the existence of various readings of that aggregate in his text. We must not omit to observe that those who espouse the schedule transmitted by the Sept. and Josephus, as affording the longer space between the Creation and the Deluge for the extensive propagation of the antediluvian race, and also after the Flood for the dissemination of mankind into powerful nations in the earliest times, herein only defeat their own argument; for it is obvious that, so long as the entire length of each patriarch's life remains unchanged, by whatever amount the period prior to marriage is augmented, just so much time is taken from the remainder for procreation: the earlier the age of paternity, the greater will naturally be the increase of population in a given number of generations. The rapid advance in adolescence after the Deluge, so marked in the Heb. numbers, was doubtless providential for the purpose of replenishing the earth as speedily as possible after that catastrophe.

(b.) *Individual Discrepancies.*—In addition to the post-diluvian Caiman noticed above, the following names appear to furnish decided proof of the superior trustworthiness of the Heb. list (see the conclusive treatise of Michaelis on this subject, translated in the *Amer. Bib. Repos.*, 2d ser., vi, 114 sq.; also some judicious remarks by Dr. Pond in the *Meth. Quart. Review*, July, 1867).

[1.] In the cases of Adam and Seth, the addition of 100 years to their age before paternity disturbs the average ratio between the season of growth and the total life, which in man, as in other animals, is a well-established proportion. These two patriarchs passed nearly one quarter of their lives childless, although their immediate successors were blessed with offspring when they had advanced but about one tenth to one twelfth in life. Was the command to "increase and multiply and fill the earth" so much less urgent in the first centuries of the world than subsequently? In the numbers assigned to the first two generations, moreover, the various readings found in the text of Josephus nearly destroy the support which it gives to the Sept., leaving the balance of evidence decidedly in favor of the tallying numbers in the Heb. and Samar.; and in the next three generations there is at least an equipoise between the authorities, which are arrayed in the same manner.

[2.] The Heb. numbers in the case of Jared are sustained by all the other lists except the Samar., which not only deducts the century from his minority, but also arbitrarily curtails his subsequent years by a different amount (25 years), evidently in order to force the total life into conformity with the plan of gradual reduction below the length of the preceding generation. In the next name, that of Enoch, the Heb. and Samar. again appear in unison against the Sept. and Josephus, the testimony of the last being impaired by the corrupt state of his numbers at this point.

[3.] The numbers given under Methuselah and Lamech, however, most decisively betray, according to the settled laws of internal criticism, marks of intentional corruption in all but the Heb. list. Not only

are the years of each of the others totally unsupported by one another, where they differ from this, under both these names, and also embarrassed by various readings of a glaring character, but a comparison of them with the date of the Deluge shows unmistakably that they were altered so as to place the demise of these two patriarchs "high and dry" beyond the reach of this event. Those who have sneeringly remarked that, according to the Hebrew chronology of Usher, "Methuselah was drowned in Noah's Flood by act of British Parliament" (which sanctioned that prelate's scheme by authorizing its insertion in the margin of the English Bible), are not only incorrect in that particular (for Methuselah [q. v.], according to the Heb. numbers, died a full month before the Deluge began), but they reason uncritically, inasmuch as so palpable an objection only shows the honesty of the Masoretic editors, who allowed it to remain upon the face of their text, when they might, by a slight alteration, so quietly have obviated it. The ingenious tinkers of the Samar. and Greek chronologies, on the contrary, have carefully attempted to remove this stumbling-block from the way of their version by a violent modification of the numbers in question, docking off here, and splicing on there, to suit circumstances. Yet, like forgers usually, they have, after all, fallen into confusion, and convicted themselves by their own traces; the Samar. and most of the readings of the Greek copies do but make the year of the death of these patriarchs coincide with that of the Flood, while the very suspicious fact remains that the lives of these two alone (besides that of Jared in the Samar.) are abbreviated not only in comparison with the longer and more difficult dates of the other lists, but suddenly, as if for a special purpose, between instances of greater longevity immediately before (excluding Enoch, who was translated alive) and after. The Heb. list can alone be defended at this point on critical grounds.

[4.] The general agreement in greater age assigned to the post-diluvian patriarchs by the Samar. and Greek lists is not more difficult to explain to the advantage of the Heb. If the former be the original form, no reason can be assigned for the change; but if the latter be assumed as giving the genuine numbers, it is easy to perceive how readily they may have been augmented in order to swell the primitive era of repopulation after the Flood into a nearer conformity with the extravagant mythical periods of early heathen histories. With the Egyptians, among whom the Sept. is known to have originated, the influence of which may plainly be traced in the present account of Josephus (and possibly, through some indirect channel, that of the Samar. also), this temptation would be peculiarly strong. The internal evidence here, however, it must be confessed, is rather in favor of the Samar. numbers, corroborated as they are throughout as to the age of paternity by those of the Sept. and (but less accurately) Josephus; and we might even be inclined to adopt them, as consistent in gradation with those preferred in the antediluvian portion, did not the manifest want of authority in the non-Hebrew schemes for that part cast a strong doubt of accuracy over them in this part likewise. This suspicion is confirmed by the want of harmony between the Samar. and Sept. as to the post-diluvian ages after paternity, the latter list conforming in this respect quite closely to the Heb. If we turn to the evidence of ancient records and tradition, we find the numbers of the Sept. confirmed rather than those of the Heb. The history and civilization of Egypt, as well as of Assyria and Babylonia, reach to a time about as early as the Heb. date of the Flood. Moreover, the concurrent evidence of antiquity carries the origin of Gentile civilization to the Noachian races. On the acceptance, therefore, of the Heb. numbers we must place (as we easily may) the dispersion of nations [see ETENOLOGY] very soon

after the Deluge. Important aid in this approximation of sacred with profane chronology is afforded by the considerable extension of the Biblical period of the Judges, noticed below, beyond that fixed by Usher.

(3.) An important rectification of the last generation is required in all the lists. According to them; it would appear that Terah was 70 years old at Abram's birth. "Terah lived seventy years, and begat Abram, Nabor, and Haran" (Gen. xi, 26). It is afterwards said that Terah went from Ur of the Chaldees to Haran, and died there at the age of 205 years [Samar. 145] (xi, 31, 32); and the departure of Abram from Haran to Canaan is then narrated (comp. Acts vii, 4), his age being stated to have been at that time 75 years (xii, 1-5). Usher therefore conjectures that Terah was 130 years old at Abram's birth (205 - 75 = 130), and supposes the latter not to have been the eldest son, but mentioned first on account of his eminence, as is Shem in several places (v, 32; vi, 10; vii, 18; ix, 18; x, 1), who yet appears to have been the third son of Noah, and certainly not the eldest (x, 21). To this it has been objected, however, that it seems scarcely probable that if Abram had been born to his father at the age of 130 years, he should have asked in wonder, "Shall [a child] be born unto him that is a hundred years old? and shall Sarah, that is ninety years old, bear?" (Gen. xvii, 17). But the force of this objection is almost entirely obviated when it is considered that Terah had previously had a son, whereas Abraham at the time of his observation was altogether childless. It is better, therefore, to adopt this arrangement, than to make an arbitrary change in the numbers, as the Samar. apparently has done.

2. *From Abram's departure out of Haran to the Exodus.*—The length of this period is stated by Paul as 430 years from the promise to Abraham to the giving of the Law (Gal. iii, 17), the first event being held to be that recorded in Gen. xii, 1-5. The same number of years is given in Exodus (xii, 40, 41), where the Heb. reads, "Now the sojourning of the children of Israel who dwelt in Egypt [was] four hundred and thirty years. And it came to pass at the end of the four hundred and thirty years, even the self-same day it came to pass, that all the hosts of the Lord went out from the land of Egypt." Here the Sept. and Samar. add after "in Egypt" the words "and in Canaan," while the Alexandrian and other MSS. of the former also add after "the children of Israel" the words "and their fathers." It seems most reasonable to regard both these additions as glosses; if they are excluded, the passage appears to make the duration of the sojourn in Egypt 430 years, but this is not an absolutely certain conclusion. The "sojourning" might well include the period after the promise to Abraham, while that patriarch and his descendants "sojourned in the land of promise as [in] a strange country" (Heb. xi, 9), for it is not positively said "the sojourning of the children of Israel in Egypt," but "who dwelt in Egypt." As for the very day of close being that of commencement, it might refer either to Abraham's entrance or to the time of the promise. A third passage is the divine declaration to Abraham of the future history of his children: "Know of a surety that thy seed shall be a stranger in a land [that is] not their's, and shall serve them; and they shall afflict them four hundred years; and also that nation, whom they shall serve, will I judge; and afterward shall they come out with great substance" (Gen. xv, 13, 14; comp. Acts vii, 6, 7). The four hundred years cannot be held to be the period of oppression without a denial of the historical character of the narrative of that time, but can only be supposed to mean the time from this declaration to the Exodus. It is also noticeable that after the citation given above the events of the whole sojourn are repeated, showing that this was the period spoken of, and perhaps, therefore, the period defined (xv, 15, 16) as "the fourth generation."

But the question, From what point of time are these years reckoned? has been variously answered, and chronological schemes vary accordingly. Some, as the Sept., Josephus, the Jewish Chronology, and most Christian writers, assign the period to the entire sojourn in Canaan and Egypt, beginning either with the Call of Abraham (Gen. xii), or the Promise (xv); others date it from the close of the period during which the Promises were made (Perizonius, Schöttgen); some (as Bengel) from the birth of Jacob; while numerous recent writers give the whole period to the sojourn in Egypt, reckoned from the descent of Jacob and the patriarchs into that country (see Knobel, in loc.; Browne, *Ordo Secl.* § 284-288). The genealogy of Moses is inconsistent with so long an interval as 430 years between Jacob's 180th and Moses' 80th year; for we learn that between Levi and Moses were only two descents—indeed, by the mother's side (Jochebed, "daughter" of Levi), only one; and as the sum of the lives of Levi, Kohath, and Amram is 137 + 138 + 137, it follows that from the birth of Levi to the birth of Moses must be considerably less than 407 years. So also the other genealogies, in which (with one exception, and that only apparent) we constantly arrive at contemporaries of Moses in the 4th, 5th, and 6th descent from the twelve patriarchs (Browne, *Ordo Secl.* § 284-288). Hence we must measure this interval of 430 years (Gal. iii, 17) from the call of Abraham, in his 76th year (Gen. xii, 4), after the death of Terah (Acts vii, 4; Gen. xi, 32), to the Exodus.

The narrative affords the following data, which we place under two periods—that from Abram's leaving Haran to Jacob's entering Egypt, and that from Jacob's entering Egypt to the Exodus.

(a.)	Age of Abram on leaving Haran.....	75 yrs.
	Age of Abram at Isaac's birth.....	100
	Difference.....	25
	Age of Isaac at Jacob's birth.....	60
	Age of Jacob on entering Egypt.....	130
		<hr/> 215
(b.) (1.)	Age of Levi on entering Egypt.....	cir. 45
	Residue of his life.....	99
	Oppression after the death of Jacob's sons (Exod. i, 6, 7, sq.).....	?
	Age of Moses at Exodus.....	80
		<hr/> 179
(2.)	Age of Joseph on Jacob's entering Egypt....	89
	Residue of his life.....	71
	Oppression.....	?
	Age of Moses at Exodus.....	80
		<hr/> 161

These data make up at least 387 or 366 years, to which some addition must be made, since it appears that all Joseph's generation died before the oppression commenced, and it is probable that it had begun some time before the birth of Moses. The sum we thus obtain cannot be far different from 430 years, a period for the whole sojourn that these data must thus be held to confirm.

The genealogies relating to the time of the dwelling in Egypt, if continuous, as there is much reason to suppose that some are, do not seem repugnant to this scheme; but, on the other hand, only one of them, that of Joshua, in 1 Chron. (vii, 23, 25, 26, 27), if a succession, can be reconciled with the opinion that dates the 430 years from Jacob's entering into Egypt. Another important historical point of evidence is the increase of the Israelites from the few souls who went with Jacob into Egypt, and Joseph and his sons, to the six hundred thousand men who came out at the Exodus. At the former date the following are enumerated: "besides Jacob's sons' wives," Jacob, his twelve sons and one daughter (13), his fifty-one grandsons and one granddaughter (52), and his four great-grandsons, making, with the patriarch himself, seventy souls (Gen. xli, 8-27). See JACOB. The generation to which children would be born about this date may thus be held to have been of at least 51 pairs, since all

are males except one, who probably married a cousin. This computation takes no account of polygamy, which was certainly practised at the time by the Hebrews. This first generation must, except there were at the time other female grandchildren of Jacob besides the one mentioned (comp. Gen. xvi, 7), have taken foreign wives, and it is reasonable to suppose the same to have been constantly done afterwards, though probably in a less degree. We cannot, therefore, found our calculation solely on these 51 pairs, but must allow for polygamy and foreign marriages. These admissions being made, and the especial blessing which attended the people borne in mind, the interval of about 215 years does not seem too short for the increase.—On the whole, we have no hesitation in accepting the 430 years as the length of the interval from Abram's leaving Haran to the Exodus.

8. *From the Exodus to the Foundation of Solomon's Temple.*—There is but one passage from which we obtain the length of this period as a whole (see Walthar, in Baumgarten's *Sammlungen*, 1748, ii, 818-488). It is that in which the Foundation of the Temple is dated in the 480th (Heb.), or 440th (Sept.) year after the Exodus, in the 4th year 2d month of Solomon's reign (1 Kings vi, 1). This sum we have first to compare with the detailed numbers. These are as follows: (a.) From the Exodus to the death of Moses, 40 years. (b.) Leadership of Joshua, 7+x years. (c.) Interval between Joshua's death and the First Servitude, y years. (d.) Servitudes and rule of Judges until Eli's death, 480 years. (e.) Period from Eli's death to Saul's accession, 20+z years. (f.) Saul's reign, 40 years. (g.) David's reign, 40 years. (h.) Solomon's reign to Foundation of Temple, 8 years. Sum, 580+x+y+z years. It is possible to obtain approximately the length of the three wanting numbers. (1.) Joshua's age at the Exodus was at least 20 years (Num. xiv, 29, 30), and at his death, 110; therefore the utmost length of his rule must be 110-(20+40)=50 years. The duration of Joshua's government is limited by the circumstance that Caleb's lot was apportioned to him in the 7th year of the occupation, and therefore of Joshua's rule, when he was 85 years old, and that he conquered the lot after Joshua's death. Caleb cannot be supposed to have been a very old man on taking his portion, and it is unlikely that he would have waited long before attacking the heathen who held it, to say nothing of the portion being his claimed reward for not having feared the Anakim who dwelt there, a reward promised him of the Lord by Moses and claimed of Joshua, who alone of his fellow-spies had shown the same faith and courage (Num. xiv, 24; Deut. i, 36; Josh. xiv, 6 *ad fin.*; xv, 18-19; Judg. i, 9-15, 20). The least length of Joshua's rule would be about 10 years. Josephus (*Ant.* v, 1, 29) fixes it midway between these limits, or at 25 years, which may be adopted as the probable length. (2.) The interval between Joshua's death and the First Servitude is limited by the history of Othniel. After Joshua there is the time of the elders who overruled him, then a period of disobedience and idolatry, a servitude of 8 years, deliverance by Othniel the son of Kenaz, the nephew of Caleb, and rest for 40 years, until Othniel's death. He was already a warrior when Caleb conquered his lot; he lived to deliver Israel from the Mesopotamian oppressor, and died at the end of the subsequent 40 years of rest. Supposing Othniel to have been 80 years old at the time of his first exploits, and 110 years at his death, then 110-(80+18+8+40)=24 years would remain for the interval in question. Josephus (*Ant.* vi, 5, 4) reasonably fixes it at 18 years, which cannot be far from correct. (3.) The residue of Samuel's judgeship after the 20 years from Eli's death, ending with the solemn fast and victory at Mizpeh, can scarcely have much exceeded 20 years; Josephus (*Ant.* vi, 18, 5) assigns it a length of 12 years. Samuel must have been still young at the time of Eli's

death, and he died near the close of Saul's reign (1 Sam. xxv, 1; xxviii, 8). If he were 20 years old at the former date, and judged for 12 years after the victory at Mizpeh, he would have been near 85 years old (20+20+12+82=84) at his death, which appears to have been a long period of life at that time. We thus arrive at the following numbers for the various portions of this period:

Years.	Years.
Wandering in the Desert. 40	Fifth Servitude. 15
Joshua's Rule 26	Jephthah's Judgeship 6
Surviving Elders 18	Ibsan's Judgeship 7
First Servitude 8	Elon's Judgeship 10
Othniel's Judgeship 40	Abdon's Judgeship 5
Second Servitude 15	Sixth Servitude. 40
Ehud's Judgeship (including Shamgar's) 80	Samson's Judgeship 20
Third Servitude 20	Eli's Judgeship 40
Barak's Judgeship 40	Seventh Servitude. 20
Fourth Servitude 7	Samuel's Judgeship 12
Gideon's Judgeship 40	Saul's Reign 40
Abimelech's Reign. 8	David's Reign 40
Tola's Judgeship. 23	Solomon's first years 3
Jair's Judgeship. 22	Total. 645

Two independent large numbers seem to confirm this result. One is in Paul's address at Antioch of Pisidia, where, after speaking of the Exodus and the 40 years in the desert, he adds: "And when he had destroyed seven nations in the land of Chanaan, he divided their land unto them by lot. And after that he gave [unto them] judges about the space of four hundred and fifty years, until Samuel the prophet. And afterward they desired a king" (Acts xiii, 19, 20, 21). This interval of 450 years may be variously explained—as commencing with Othniel's deliverance and ending with Eli's death, a period which the numbers of the earlier books of the Bible, if added together, make 442 years; or as commencing with the First Servitude, 8 years more, which would be exactly 450 years; or with Joshua's death, which would raise these numbers by about 18 years; or again, it may be held to end at Saul's accession, which would raise the numbers given respectively by about 82 years. However explained, this sum of 450 years supports the authority of the detailed numbers as forming an essentially correct measure of the period; and the precise coincidence with one of the foregoing modes of computation seems to show that it was that which Paul adopted. The other large number occurs in Jephthah's message to the king of the Children of Ammon, where the period during which Israel had held the land of the Amorites from the first conquest either up to the beginning of the servitude from which they were about to be freed, or up to the very time, is given as 800 years (Judg. xi, 26). The above detailed numbers, including the uncertain periods, would make these intervals respectively 344 and 362 years. Here, therefore, there appears to be an agreement, although not positive, since the meaning might be either three centuries, as a vague sum, or about 800 years. So far as the evidence of the numbers goes, we must decide in favor of the longer interval, from the Exodus to the building of the first Temple, in preference to the period of 480 or 440 years.

The evidence of the genealogies has been held by some to sustain a different conclusion. These lists, as they now stand, would, if of continuous generations, be decidedly in favor of an interval of about 300, 400, or even 500 years, some being much shorter than others. It is, however, impossible to reduce them to consistency with each other without arbitrarily altering some, and the result, with those who have followed them as the safest guides, has been the adoption of the shortest of the numbers just given, about 800 years. The evidence of the genealogies may therefore be considered as probably leading to the rejection of all numerical statements, but as perhaps less inconsistent with that of 480 or 440 years than with the rest.

The statement in 1 Kings vi, 1, is accepted by Hillel, the author of the modern Jewish chronology, who makes the 480 years one of the elements for the con-

struction of his Mundane era; by Usher also, by Petavins, who, however, dates the period from the Eisode, and by many others. In more recent times, Hengstenberg (*Authentic des Pentateuchs*, ii, 28 sq.), Hofmann (in the *Studien u. Kritiken*, 1838), Thenius (*on 1 Kings vi, 1*), Tiele (*Chronol. des A. T.*), Gehring (*über die biblische Äre*), Niebuhr (*Gesch. Assurs u. Bab.*), uphold the statement as historical. But though this measure, by bridging over the interval from Moses to Solomon, enables the chronologist, when he has formed his mundane series down to the Exode, to assign the year *anno mundi* of 4 Solomon and so of 1 David, or, having traced the reckoning B.C. up to 1 Solomon, to give the year B.C. of the Exode, the whole tract of time occupied by the Judges is still loose at either end, and needs much management to define its bearings. For the items actually enumerated, being (even if the entire 40 years of Eli and the 20 years of the Ark at Kirjath-Jearim be included in the 890 of the Judges) 47 + 890 + 48 = 490, no room is left for Joshua and the elders, Samuel and Saul. Accordingly, the chronologists who accept this measure are obliged to resort to violent expedients—the assumption that some of the servitudes were contemporary, and others, which it is clearly impossible to exalt above the rank of ingenious conjectures. But the number 480 is, in fact, open to grave suspicion. The Sept. has instead of it 440. Josephus takes no notice of either, and on various occasions makes the interval 592, 612, and 632 years; the early Christian chronographers also ignore the measure—thus Theophil. Antioch. reckons 498 to 1 David; Clem. Alex. to 1 Saul, 490; Africanus, 677 years. Paul's enumeration, in Acts xiii, 18-21, also proves at least this, that Jews in his time reckoned the interval in a way which is inconsistent with the statement in 1 Kings vi, 1. He gives from the Exode to 1 David 40 + 450 + 40 = 530; therefore to 4 Solomon, 578 years. Paul's term of 450 years is evidently the interval from the First Servitude to the end of those 20 years of the Ark, 1 Sam. vii, 2 (composed of 390 + 40 + 20). Clinton (*Fasts Hell.* i, 812) dates the 450 from the partition of lands (47th after Exode), assumes 20 years for Joshua and the elders, and another term of 12 years between the 20 years of the Ark (1 Sam. vii, 2) and the 40 years which he gives entire to Saul, thus making the sum 612 years. It remains only to state that the text in 1 Kings vi, 1, cannot be impugned on strictly critical grounds, excepting the various reading in the Sept.; the other versions and the Heb. MSS. are uniform in their testimony: that date, therefore, must be summarily rejected as an early interpolation, as is done by most modern chronologers. For a further examination of the period in question, see JUDGES. For the value of Egyptian dates of the Exode, see below. (See also in the *Stud. u. Kritiken*, 1863, iv.)

4. *From the Foundation of Solomon's Temple to its Destruction.*—We have now reached a period in which the differences of chronologers are no longer to be measured by centuries, but by tens of years and even single years, and towards the close of which almost perfect accuracy is attainable. The most important numbers in the Bible are here generally stated more than once, and several means are afforded by which their accuracy can be tested. The principal of these tests are the statement of kings' ages at their accessions, the double dating of the accessions of kings of Judah in the reigns of kings of Israel and the converse, and the double reckoning by the years of kings of Judah and of Nebuchadnezzar. Of these tests the most valuable is the second, which extends through the greater part of the period under consideration, and prevents our making any very serious error in computing its length. The notices of kings of Egypt and Assyria, contemporary with Hebrew sovereigns during this period, are also of importance, and are likely to be more so, when, as we may expect, the chronological places of all these contemporaries are more nearly determined. All rec-

ords, therefore, tending to fix the chronologies of Egypt and Assyria, as well as of Babylonia, in these times, are of great value, from their bearing on Hebrew chronology. At present the most important of such records is Ptolemy's Canon, from which no sound chronologer will venture to deviate. In the Biblical statements the number and importance of inconsistencies has usually been much exaggerated, since several supposed disagreements depend upon the non-recognition of the mode of reckoning regnal years from the commencement of the year, and not from the day of the king's accession; still a few difficulties cannot be resolved without the supposition that numbers have been altered by copyists. Many of the dates are reckoned from a joint accession of several of the kings with their respective fathers, and a few are even posthumous. Two interregna in the kingdom of Israel have generally been supposed, and none others are necessary; namely, one of 11 years, between Jeroboam II and Zachariah, and the other of 8 years, between Pekah and Hoshea. The former supposition might seem to receive some support from the words of the prophet Hosea (x, 3, 7, and perhaps 15), which, however, may only imply a lax government, and the great power of the Israelite princes and captains, as an absolute anarchy. The following table exhibits the length of this period as thus adjusted, according to the double line of kings; for the details of the chronology, see ISRAEL (KINGDOM OF); JUDAH (KINGDOM OF).

JUDAH.		ISRAEL.	
	Years.		Years.
Solomon (residue)	87	Jeroboam I.	21
Rehoboam	17	Nadab	1
Abijah	3	Baasha	28
Asa	41	Elah	1
		Zimri	0
		Tibni	4
		Omri (alone)	7
Jehoshaphat	25	Ahab	20
		Ahaziah I.	1
Jehoram II.	8	Jehoram I.	12
Ahaziah II.	1		
<i>Synchronism</i>	90	<i>Synchronism</i>	90
Attaliah	6	Jehu	28
Jehosh I.	40	Jehoahaz I.	16
Amaziah	29	Jehoash II.	16
Uzziah	53	Jeroboam II.	41
		Interregnum	11
		Zachariah	1
Jotham	16	Shallun	1
Ahaz	14	Menahem	10
Hesekiah (beginning)	6	Pekahiah	2
<i>Synchronism</i>	233	Pekah	20
Hesekiah (residue)	28	Interregnum	8
Manasseh	55	Hoshea	9
Amon	2	<i>Assyrian Captivity</i>	258
Joshiah	31		
Jehoahaz II.	0		
Jehoiakim	11		
Jehoiachin	0		
Zedekiah	10		
<i>Babylonian Captivity</i>	835		
Total	433 years of duration of Temple.		

The gross sum total of the regnal years of Judah, to the year of the Assyrian Captivity, is 260, as the numbers stand in the text; of the Ten Tribes, 243; but, as they may be corrected by synchronal data, only 257 and 238 years respectively. This deficit of 19 years has been by most chronologists taken to imply that the two gaps in the Israelite succession, which are brought to light by the synchronisms, were intervals of anarchy, filled up (as above) by interregna—one of 11 years, between the death of Jeroboam II, in 27 Uzziah, and the accession of Zachariah, in 38 Uzziah; the other, of 8 years, between the death of Pekah, in 4 Ahaz, and the accession of Hoshea, in the 12th of the same reign. But later writers prefer to liquidate the reckoning by assuming an error in the regnal years of Jeroboam II and Pekah. Thus Ewald, making the difference 21

years, gives these kings 53 and 29 years respectively, instead of 41 and 20 (*Gesch. des Volkes Isr.* iii, 1, p. 261-818); Thenius (*die BB. der Könige*, p. 346), by a more facile emendation, makes the numbers 51 and 30 (א for נ, and ב for ז); J. v. Gumpach (*Zeitr. der Bab. u. Assy.*), though reducing the total amount to 241 years, gives Pekah 29 years and retains the 41 of Jeroboam; Lepsius (*Chronol. der Eg.*) makes the reigns 52 and 30; and Bunsen (*Ägyptens Stelle*, b. iv, p. 381, 395, 402) makes Jeroboam reign 61 years, and retains for Pekah his 20 years. Movers (*die Phönizier*, ii, 1, 158), by a peculiar method of treatment, reduces the reigns of Israel to 233 years, and brings the reigns of Judah into conformity with this sum by making Jehoram co-regent with Jehoshaphat 4 years, Uzziah with Amaziah 12, and Jotham with Uzziah 11 years. How arbitrary, and therefore unjustifiable, such reduction of numbers is, must be evident to every critical eye. The supposition of co-regencies is only allowable in order to explain the apparent discrepancies in some of the kings' years, but in no case are they suffered to disturb the length of reigns, as given in the text. See each name in its alphabetical place in this Cyclopaedia. (See Wolff, in the *Theol. Stud. u. Krit.* 1858, iv).

5. *From the Destruction of Solomon's Temple to the Return from Babylon.*—The determination of the length of this period depends upon the date of the return to Palestine. The decree of Cyrus leading to that event was made in the first year of his reign (Ezra i, 1), which, if it date from his conquest of Babylon (q. v.), as determined by Ptolemy's Canon, would be B.C. 538; but the decree in question appears to date from his personal superseding of "Darius the Mede" (q. v.) at Babylon, B.C. 536, where the edict was evidently issued. See CYRUS. Others date the decree from the earlier point, and suppose that so great a migration must have occupied much time; they therefore allow two years as not too long an interval for its complete accomplishment after the promulgation of the decree.

Another method of arriving at the time in question is by means of fixing the termination of the so-called "70 years' captivity." Two numbers, held by some to be identical, must here be considered. One is the period of 70 years, during which the tyranny of Babylon over Palestine and the East generally was to last, prophesied by Jeremiah (xxv), and the other, the 70 years of the city's overthrow and utter depopulation (2 Chron. xxxvi, 21; Dan. ix, 2). The commencement of the former period is plainly the 1st year of Nebuchadnezzar (as viceroy), and 4th (according to Dan. i, 1, the 8d complete) year of Jehoiakim (Jer. xxv, 1), B.C. 606, when the successes of the king of Babylon began (xli, 2), and the miseries of Jerusalem (xxv, 22); and its conclusion will be the fall of Babylon (ver. 26). The famous 70 years of captivity would seem to be the same period as this, since it was to terminate with the return of the captives (Jer. xxix, 10). The second period of 70 years dates from the burning of the Temple, late in B.C. 588 (Ezek. xl, 1), and terminates with its complete reconstruction, some time in B.C. 517 (Ezra vi, 15). The two passages in Zechariah, which speak of such an interval as one of desolation (i, 12), and during which facts connected with the captivity had been kept (vii, 5), are quite reconcilable with this explanation. These two passages are of the 2d and 4th years of Darius Hystaspis, in whose 6th year the Temple was finished.

The details of this period are made up of the following Babylonian reigns, from profane sources:

	Years.	Years.
Nebuchadnezzar (viceroyship)	18	
Nebuchadnezzar (residue)	26	27
"Evil-Merodach"	2	3
Nerikolassar	4	4
"Belshazzar," vice Nabonned.	17	17
<i>Capture of Babylon</i>		63
"Darius the Mede," or Cyaxares	3	2
Cyrus's Decree		70

	Years.
Cyrus (residue)	6
"Ahasuerus," or Cambyses	8
"Artaxerxes," or Smerdis	0
"Darius," i. e. Hystaspis (beginning) ...	5
<i>Temple rebuilt</i>	70

6. From this point downward, the coincidence with Grecian and Roman annals becomes so clear, to the junction with the Christian era, that there can be no doubt respecting the chronology as a whole. The prophetic period of Daniel's "Seventy Weeks" (q. v.) covers this period, and accurately sketches the outline of Jewish history. The details will be considered under the special heads to which they belong, e. g. DANIEL; EZRA; NEHEMIAH; MACCABEES; JESUS; ACTS, etc.

III. *Synchronisms with Profane Annals.*—There are a number of leading dates which may be regarded as more or less settled by a comparison of the foregoing Biblical statements with those found in classical, Judæo-ecclesiastical, and monumental history.

1. *The Deluge.*—The Flood, according to the foregoing adjustments, would end near the close of B.C. 2515, and would have begun near the close of B.C. 2516. It is most reasonable to suppose the Noachian colonists to have begun to spread not long after the Flood; scriptural intimations, as commonly interpreted, assign their dissemination to the beginning of the second century after that event. If the Division at Peleg's birth be really the same as the Dispersion (q. v.) after the building of the Tower of Babel, this supposed interval would not necessarily have to be lengthened, for the text of the account of the building of the Tower does not absolutely prove that all Noah's descendants were concerned in it, and therefore some may have previously taken their departure from the primeval settlement. See PELEG. The chronology of Egypt, derived from the monuments and Manetho, is held by some to indicate for the foundation of its first kingdom a much earlier period than would be consistent with this scheme of approximative Biblical dates; but other and more careful authors greatly reduce these computations (see J. C. K. Hofmann, *Ägyptische u. Isr. Zeitrechnung*, Nördl. 1847, 8vo). The Assyrians and Babylonians have not been proved, on satisfactory grounds, to have reckoned back to so remote a time as the Egyptians; but the evidence of their monuments, and the fragments of their history preserved by ancient writers, as in the case of the Egyptians, cannot well be reconciled with the short interval preferred by Usher. The most cautious calculations, based upon independent historical evidence, points to no earlier period than the middle of the 25th century B.C. as the time of the foundation of kingdoms, although the chronology of Egypt reaches to about this period (Osburn, *Monumental Hist. of Egypt*, p. 684, concludes that Menes founded the Egyptian empire at Memphis in B.C. 2429), while that of Babylon and other states does not greatly fall short of the same antiquity, although the Assyrian empire was much later (Layard, *Babylon and Nineveh*, p. 531, dates, according to the latest conclusions from the inscriptions, the reign of the first Ninevite king, Derceto, from B.C. 1250). See NOAH.

2. *The Exodus.*—Arguments founded on independent evidence afford collateral means of deciding which is the most probable computation from Biblical evidence of the date of this event. A comparison of the Hebrew calendar with the Egyptian has led a late writer (Poole, *Horæ Ægyptiacæ*, p. 217) to the following result: The civil commencement of the Hebrew year was the new-moon nearest to the autumnal equinox; and at the approximative date of the Exodus obtained by the reckoning given above, we find that the Egyptian vague year commenced at or about that point of time. This approximative date, therefore, falls about the time at which the vague year and the Hebrew year, as dated from the autumnal equinox, nearly or exactly coincided in their commencements. It may reasonably be supposed that the Israelites in

the time of the oppression had made use of the vague year as the common year of the country, which, indeed, is rendered highly probable by the circumstance that they had to a considerable extent and in no very private manner adopted Egyptian religious customs (Josh. xxiv, 14; Ezek. xx, 7, 8), the celebrations prescribed by which were kept according to this year. When, therefore, the festivals of the Law rendered a year virtually tropical necessary, of the kind either restored or instituted at the Exodus, it seems most probable that the current vague year was fixed under Moses. If this supposition be correct, we should expect to find that the 14th day of Abib, on which fell the full-moon of the Passover of the Exodus, corresponded to the 14th day of a Phenomenon, in a vague year commencing about the autumnal equinox. It has been ascertained by computation that a full moon fell on the 14th day of Phenomenon, on Thursday, April 21st, in the year B.C. 1652. A full moon would not fall on the same day of the vague year at a shorter interval than 25 years before or after this date, while the triple coincidence of the new moon, vague year, and autumnal equinox could not recur in less than 1500 vague years (*Encyclopæd. Brit.*, 8th. ed., s. v. Egypt, p. 456). The date thus obtained is but four years earlier than Hale's, and the interval from it to that of the Foundation of Solomon's Temple, B.C. 1010, would be 642 years, or only six years in excess of that previously obtained from the numerical statements in the Bible. This coincidence is at least remarkable, although the want of exact correspondence in the dates detracts considerably from the force of the argument based upon this comparison. See EXODE.

Setting aside Usher's preference for the 480 years of 1 Kings vi, 1, as resting upon evidence far less strong than the longer computation, we must mention the principal reasons urged by Bunsen and Lepsius in support of the Rabbinical date (see Bunsen, *Bibelwerk*, i, p. cxi, cexiii, ccxxiii sq.; Lepsius, *Chronol. der Egypter*, i, 314 sq.). The reckoning by the genealogies, upon which this date rests, we have already shown to be unsafe. Several points of historical evidence are, however, brought forward by these writers as leading to or confirming this date. Of these the most important is the supposed account of the Exodus given by Manetho, the Egyptian historian, placing the event at about the same time as the Rabbinical date. This narrative, however, is, on the testimony of Josephus (*Apion*, i, 14; also 26, etc.), who has preserved it to us, wholly devoid of authority, being, according to Manetho's own showing, a record of uncertain antiquity, and of an unknown writer, and not part of the Egyptian annals. An indication of date has also been supposed in the mention that the name of one of the treasure-cities built for Pharaoh by the Israelites during the oppression was Raameses (Exod. i, 11), probably the same place as the Rameses elsewhere mentioned, the chief town of a tract so called. See RAMESSES. This name is the same as that of certain well-known kings of Egypt of the period to which by this scheme the Exodus would be referred. If the story given by Manetho be founded on a true tradition, the great oppressor would have been Rameses II, second king of the 19th dynasty, whose reign is variously assigned to the 14th and 18th centuries B.C. It is further urged that the first king Rameses of the Egyptian monuments and Manetho's lists is the grandfather of this king, Rameses I, who was the last sovereign of the 18th dynasty, and reigned at the utmost about 60 years before his grandson. It must, however, be observed, that there is great reason for taking the lower dates of both kings, which would make the reign of the second after the Rabbinical date of the Exodus, and that in this case both Manetho's statement must be of course set aside, as placing the Exodus in the reign of this king's son, and the order of the Biblical narrative must be transposed, that the building of Raameses

should not fall before the accession of Rameses I. The argument that there was no king Rameses before Rameses I is obviously weak as a negative one, more especially as the names of very many kings of Egypt, particularly those of the period to which we assign the Exodus, are wanting. It loses almost all its force when we find that a son of Aahmee, Amosis, the head of the 18th dynasty, variously assigned to the 17th and 16th centuries B.C., bore the name of Rameses, which name, from its meaning (*son of Ra*, or the sun, the god of Heliopolis, one of the eight great gods of Egypt), would almost necessarily be a not very uncommon one, and Raameses might therefore have been named from an earlier king or prince bearing the name long before Rameses I. The history of Egypt presents great difficulties to the reception of the theory together with the Biblical narrative, difficulties so great that we think they could only be removed by abandoning a belief in the historical character of that narrative; if so, it is obviously futile to found an argument upon a minute point, the occurrence of a single name. The historical difficulties on the Hebrew side, in the period after the Exodus, are on this view not less serious, and have induced Bunsen to antedate Moses's war beyond Jordan, and to compress Joshua's rule into the 40 years in the wilderness (*Bibelwerk*, p. ccxxviii sq.), and so, we venture to think, to forfeit his right to reason on the details of the narrative relating to the earlier period. This compression arises from the want of space for the Judges. The chronology of events so obtained is also open to the objection brought against the longer schemes, that the Israelites could not have been in Palestine during the campaigns in the East of the Pharaohs of the 18th, 19th, and 20th dynasties, since it does not seem possible to throw those of Rameses III earlier than Bunsen's date of the beginning of the conquest of western Palestine by the Hebrews (see the Duke of Northumberland's paper in Wilkinson's *Anc. Egypt*, i, 77-81). There does not, therefore, appear to be any good reason for abandoning the definite statements of the Hebrew records in favor of the yet crude and conflicting constructions of synchronical dates from the Egyptian monuments (see Kenrick's *Egypt under the Pharaohs*, vol. ii). See EGYPT.

8. *Rehoboam and Shishak*.—The Biblical evidence for this synchronism is as follows: Rehoboam came to the throne in B.C. 978. The invasion of Shishak took place in his fifth year, or B.C. 969. Shishak was already on the throne when Jeroboam fled to him from Solomon (1 Kings xi, 40). This event happened during the building of Millo, etc., when Jeroboam was head of the workmen of the house of Joseph (1 Kings xi, 27). The building of Millo and repairing of the breaches of the city of David was after the building of the house of Pharaoh's daughter, that was constructed about the same time as Solomon's house, the completion of which is dated in his 24th year (1 Kings vi, 1, 87, 88; vii, 1; 2 Chron. viii, 1, where 8+20=10+18). This building is recorded after the occurrences of that year of Solomon, for Pharaoh's daughter remained in Jerusalem until the king had ended building his own house, and the Temple, and the wall of Jerusalem round about (1 Kings iii, 1), and Millo was built after the removal of the queen (ix, 24); therefore, as Jeroboam was concerned in this building of Millo and repairing the breaches, and was met "at that time" (xi, 29) by Ahijah, and in consequence had to flee from the country, the 24th or 25th year is the earliest possible date. Thus Shishak appears to have come to the throne at most 21 or 22 years (40-28 [or 24]+4) before his expedition against Rehoboam. An inscription at the quarries of Silsilis, in Upper Egypt, records the cutting of stone in the 22d year of She-shonk I, or Shishak, for constructions in the chief temple of Thebes, where we now find a record of his conquest of Judah (Champollion, *Lettres*, p. 190, 191).

On these grounds we may place the accession of Shishak at B.C. cir. 990. The evidence of Manetho's lists, compared with the monuments, would place this event within a few years of this date, for they do not allow us to put it much before or after B.C. 1000, an approach to correctness which at this period is very valuable. See SHISHAK.

4. *Josiah and Pharaoh Necho*.—The death of Josiah can be clearly shown on Biblical evidence to have taken place in the 21st year before that in which the Temple was destroyed—that is, in the Jewish year from the spring of B.C. 609 to the spring of 608. Necho's first year is proved by the Apis tablets to have been the Egyptian vague year, either January, B.C. 609–8, or probably B.C. 610–09. The expedition in opposing which Josiah fell (2 Kings xxiii, 29) cannot reasonably be dated earlier than Necho's second year, B.C. 609–8 or 608–7. See Necho.

6. *Jehoiakim and Nebuchadnezzar*.—In Jer. xxv, 1, the first year of Nebuchadnezzar coincides, wholly or in part, with 4 Jehoiakim; 2 Kings xxiv, 12, the epoch of Jeconiah's captivity and of Zedekiah's reign lies in 8 Nebuchadnezzar; *ibid.* xxv, 8, the 11th of Zedekiah, the 5th month, 10th day, lies in 19 Nebuchadnezzar; and Jer. lii, 81, the 87th of Jeconiah, 12th month, 25th day, lies "in the year that Evil-merodach began to reign." From these synchronisms it follows demonstrably that, in this reckoning, Nebuchadnezzar has 45 years of reign, two years more than are assigned to him in the Astronomical Canon, where his reign of 43 years begins *E. Nab.* 144 = B.C. 604; consequently, that his reign in the Jewish reckoning bears date from the year B.C. 606 (Browne, *Ordo Saec.* § 151–171, 488). Hence it results that the year of the taking of Jerusalem and destruction of the Temple is B.C. 588. Those chronologists who, not having carefully enough collated and discussed the testimonies, accept unquestioned the year B.C. 604 as *that* first year of Nebuchadnezzar which coincides with 4 Jehoiakim, place the catastrophe two years later, B.C. 586. With this latitude for difference of views, the synchronism 1 Nebuchadnezzar = 4 Jehoiakim = B.C. 606 or 604, has long been generally taken by chronologists as the connecting link between sacred and profane annals, the *terminus a quo* of the ascending reckoning. See NEBUCHADNEZZAR.

6. *Hezekiah's Synchronisms*.—In 2 Kings xviii, 18; xix, 9, it appears that Sennacherib, king of Assyria, and Tirhakah, king of Ethiopia, were both contemporary with Hezekiah, and at the 14th year of his reign. Now, in the recently-recovered Armenian version of Eusebius's *Chronicle*, we have it on the authority of Berossus (quoted from Polyhistor) that from Sennacherib to Nebuchadnezzar were 88 years (the names and numbers are given, and agree with the expressed sum); this account places the accession of Sennacherib at B.C. 692, which is 20 years later than the lowest date that the Biblical numbers will allow for 14 Hezekiah. Accordingly, Niebuhr (*Kl. histor. u. philol. Schriften*, i, 209) proposed to strike out that number of years from the 55 assigned to Manasseh; then the interval to 4 Jehoiakim = 1 Nebuchadnezzar, would be 15 + 85 + 2 + 81 + 8 = 86. Since Niebuhr's time an important Assyrian monument of the time of Sennacherib, interpreted by Rawlinson and Hincks, informs us that the invasion of Judaea, which in the book of Kings is said to have been in the 14th of Hezekiah, took place in Sennacherib's third year. Hence the interval to 4 Jehoiakim becomes 86 years. Of itself this does not prove much, and Ewald, iii, 364; Thenius, p. 410; Bunsen, iv, 398, retain the Biblical number, which also the younger Niebuhr (*Gesch. Assters u. Babels*, p. 99–106) learnedly upholds against his father's objections. With the assistance, too, of the Canon, and of the extract from Abydenus's account of the same times, it is not difficult to bring the statements of Berossus into conformity with the Biblical

numbers, as by Browne (*Ordo Saeculorum*, § 489 sq.), Brandis (*Reser. Assyriarum tempora emendata*, p. 40 sq.; retracted, however, in his later work, *Ueber den hist. Gewinn aus der Entziff. der Assy. Inschr.* p. 46, 78), and in the work just cited of the younger Niebuhr. On the other hand, Lepsius (*Königs-Buch der Ägypter*), Movers (*die Phönizier*, ii, 1, 152 sq. [whose arguments A. v. Gutschmid, *Rhein. Mus.*, 1857, thinks unanswerable]), Scheuchzer (*Phul u. Nabonassar*), and J. v. Gumpach (*Abriss der bab.-assy. Gesch.* p. 98 sq.) contend for the reduced numbers. See TIRHAKAH.

The Tirhakah in question is undoubtedly the Tarko, Tarakos of Manetho's 26th dynasty, in which, according to the uncorrected numbers, his reign begins 1704 (Africanus), 188 or 186 (Euseb. in Gr.), 185, 187, or 193 (Euseb. Armen.) before Cambyses, B.C. 525; the extremes, therefore, are B.C. 635 and 718 for his epoch. But we are not dependent on the lists for the time of this king Taharka. The chronology of the 26th dynasty had already been partially cleared up by funerary inscriptions (now in the museums of Florence and Leyden), which, by recording that the deceased, born on a given day, month, and year of Neko II, lived so many years, months, and days, and died in a given year, month, and day of Amœis, enabled us to measure the precise number of years (41) from the epoch of the one king to the epoch of the other (Böckh, *Manetho*, p. 729 sq.); and now it is placed beyond further question by Mariette's discovery of a number of inscriptions, in each of which the birth, death, day of funeral, and age of an Apis are recorded in just the same way (see Mariette's own account, *Reneignement sur les 64 Apis, trouvés dans les souterrains du Sérapéum*—*Bulletin Archéol. de l'Athènes Française*, Oct., 1855; and the selection from these by Lepsius, *On the 22d Dynasty*, translated by W. Bell, 1856). There remains only a slight doubt as to the epoch of Cambyses; whether with the canon this is to be referred to B.C. 525 (the usual date), or with De Rougé to 527, for which Von Gumpach also contends, or 528, with Dr. Hincks (*On the Age of the 26th Dynasty*), or even 529 (Böckh, *Manetho*, p. 739 sq.). The main result is, that Psametik I began to reign 138 years before the epoch of Cambyses, therefore B.C. 663 (or at most three years earlier). Now Mariette (No. 2087) records that an Apis born 26 Taharka, died 20 Psametik I, 12th month, 20th day; its age is not given. As the Apis was not usually allowed to live more than 25 years, though some of the inscriptions record an age of 26 years, on this, as an extreme supposition, the interval from 1 Taharka to 1 Psametik will be at most 31 years, and the highest possible epoch for Tirhakah (B.C. 697). This result, in itself, is not necessarily opposed to the Biblical date for 14 Hezekiah; for in the narrative itself, while a "Pharaoh, king of Egypt," is mentioned, xviii, 21, this Tirhakah is styled "king of Ethiopia," and he seems to appear on the scene as an unexpected enemy of Sennacherib (Niebuhr, *ut sup.* p. 72 sq. 178, 458). He may have reigned in Ethiopia long before he became king of Egypt; though, on the other hand, it is clear that this originally Ethiopian dynasty was contemporaneous in its lower part with the 26th, a Saite dynasty of Lower Egypt, and probably in its upper part with the preceding Saite dynasty, as Lepsius makes it. The real difficulty, however, consists in this, that the "So (ΣΩ) king of Egypt," whose alliance against Assyria was sought by Hoshea in his 5th or 6th year (2 Kings xvii, 4), can be no other than one of the two predecessors of Tirhakah, Sebek I or II, to the first of whom Manetho gives 8 (v. r. 12), to the other 14 years of reign. Thus, at the earliest, the former would begin to reign B.C. 723, which is at least one year too low for the Biblical date. As a conjectural remedy for this "desperate state of things," Von Niebuhr, p. 459, suggests that the 50 years of the 26th dynasty were possibly not continuous; failing this, either an error must be assumed in the canon

somewhere between its 28th and its 128d year, both of which are astronomically attested, or else the reign of Manasseh must be reduced. On the whole, it seems best to wait for further light from the monuments. At present these attest the 12th year of Sebek II, but give no dates of his predecessor; the genealogical connection of the two and of Taharka is unknown; of Bocchoris, the only occupant of the preceding dynasty, no monument has been discovered, and but scanty and precarious traces of the Tanite kings of the 28d dynasty, the last of whom, Zet, may even be the Sethos whom Herodotus, ii, 141, makes the hero of the miraculous defeat of Sennacherib's army. Indeed, Isa. xix, 2; xxx, 4, both seem to imply that Zoan (Tanis) was at that time the residence of the Pharaoh of Lower Egypt. Here is ample scope for conjecture, and also for discoveries, which may supersede all necessity for conjecture. See So.

The mention of "Merodach-Baladan, son of Baladan, king of Babylon," apparently in or not long after 14 Hezekiah (2 Kings xx, 12), forms yet another synchronism in this reign. For Sennacherib's inscription records his defeat of this Babylonian king in his first year; a Marudakh-Baldan appears in Polyhistor's extract from Berossus as king in Babylon early in Sennacherib's reign, but with circumstances which make it extremely difficult to make out the identity of the three persons with each other, and with either the *Mardak* Empad, who in the Canon reigns in Babylon from 721 to 709, or the Mesesi *Mordak* of the same document, from 692 to 688. See MERODACH-BALADAN. Here it may be sufficient to mention that Dr. Hincks (*Trans. of Royal Irish Academy*, vol. xxii, 364), retaining the 55 years of Manasseh, proposes to solve the difficulty by placing Sennacherib's invasion of Judæa in Hezekiah's 25th instead of his 14th year, at the date 701 B.C.; Hezekiah's illness remains at its earlier date. Bunsen, tacitly adopting this construction, makes 3 Sennacherib fall in 24 Hezekiah, and imagines that the invasion which terminated disastrously to the Assyrian king was a second, in Hezekiah's 28th year, on which latter occasion it was that Tirhakah came to the relief of Jerusalem (*Eg. St. b.* iv, p. 506). Retaining for this Egyptian king an epoch B.C. 712, which is plainly disproved by the Apis inscriptions (see above), he makes it possible for So=Sevek II to have been contemporary with Hoshea. It must be owned that the received chronology of Hezekiah's reign is beset with difficulties on the side both of Egypt and of Assyria and Babylon. But from neither have we as yet all the facts we need, and the fuller and clearer information which is confidently expected from the cuneiform inscriptions, in particular, will probably make much bright that is now dark. Colonel Rawlinson indeed regards it as "now generally admitted that there were two invasions of Palestine during the reign of Hezekiah; the first in B.C. 701, when Sennacherib overran the country and exacted a heavy tribute, as stated in the inscriptions and 2 Kings xviii, 18-16, and the second some thirteen or fourteen years later, which ended in the discomfiture of the Assyrians" (*London Athenæum*, August 22, 1868, p. 247 b). But the learned antiquarian has ignored the fact that the same inscriptions do not speak of two invasions, and the Bible expressly identifies those here assumed as distinct. Indeed, the paper in which this and other wholesale changes of the Biblical numbers are advocated contains in itself abundant evidence of the precarious elements upon which the whole system of reconstructed Assyrian chronology, as drawn from the monuments, is based; and we feel only the more confirmed by its perusal in the belief that we cannot safely correct the definite and consecutive dates of the Biblical accounts by means of such vague and incoherent data. At least the attempt is yet evidently premature, and we are justified, by the changes which these decipherers and collaters of the cuneiform

legends are constantly obliged to make in their own computed results, in waiting until they have arrived at some settled and consistent chronology before we adopt it as the basis for rectifying the established points of Scriptural history. See SENNACHERIB.

In connection with this discussion, a passage of Demetrius Judæus has been deemed important (Von Gumpach, *ut sup.* p. 90, 180). He seems to have put forth a chronological account of the Biblical history, from which Eusebius, *Prep. Ev.* ix, 21, 29, gives—quoting it from Polyhistor—what relates to the patriarchs and Moses; another passage, preserved by Clem. Alex. *Strom.* i, § 141, is a summary of the period elapsed from the captivity of the Ten Tribes to his own times. Its substance is as follows: From Sennacherib's invasion of Judah to the last deportation from Jerusalem by Nebuchadnezzar, 128 years 6 months; from the captivity of the Ten Tribes to Ptolemy IV (Philopator), 478 years 9 months (so we must read for 578); from Nebuchadnezzar's deportation from Jerusalem, 888 years 3 months. As the epoch of Ptolemy IV in the Canon is B.C. 222 (24th October), this gives for Nebuchadnezzar's "last deportation" B.C. 560 (July); for Sennacherib's invasion, B.C. 688 (Jan.); and for the captivity of Samaria, B.C. 695 (Jan.). But unless we are prepared to set aside the Astronomical Canon, at least its dates for Nebuchadnezzar and Evilmerodach, the captivity under Nebuchadnezzar, whether it be that in his 19th year (11th Zedekiah), or "the last," in his 28d year, Jer. lii, 30, cannot fall so low as B.C. 560. That the final deportation is meant is plain from the exact correspondence of the sum with the Biblical items—Hezekiah, 15; Manasseh, 55; Amon, 2; Josiah, 31; Jehoiakim, 3; Nebuchadnezzar, 22=128 years. The 6 months over are perhaps derived from the 3 of Jehoahaz and 3 of Jeconiah. M. v. Niebuhr, *ut sup.* p. 102 sq., sets himself to solve the difficulty; but the whole matter may easily be explained by an error in the ordinal of the Ptolemy referred to. Set the goal at Ptolemy III (Euergetes)=B.C. 247, Oct.; then we have for the captivity of the Ten Tribes, 720 (Jan.); for Sennacherib in Judæa, 718 (Jan.); for the deportation in 23 Nebuchadnezzar, 585 (July); and consequently 589 for the destruction of the Temple—very nearly in accordance with the date for the last, assigned by Clement of Alexandria, B.C. 588, *Strom.* i, § 127. In fact, the chronological statements in this portion of the *Stromata* swarm with numerical errors, and a careless scribe might easily misread TETAΠΤΟΥ for ΤΟΥΤΠΙΤΟΥ. Be that as it may, it is a great mistake to suppose that Demetrius or any other Jew, of his or later times, can be competent to rule a question of this kind for us. He may have been, as M. v. Niebuhr thinks, "a sensible writer" (though others, judging from the fragments preserved by Eusebius, may fairly think otherwise); that "he may have handed down good materials" is just possible; the probability is that he gives us the results of his own inquiries, confined to the text of the sacred books, except that he gathered from the Astronomical Canon the year corresponding to 23 Nebuchadnezzar, the last recorded in the sacred books. See HEZEKIAH.

7. An argument tending to lower the whole time of the kings, and the date of the building of Solomon's Temple, has been deduced from some ancient data of Tyrian chronology. Josephus (*c. Ap.* i, 17) announces that the building of the Temple lies 143 years 8 months before the founding of Carthage; he gives this on the authority of Menander of Ephesus, meaning his own summation of that author's enumeration of reigns professedly copied from public monuments. In proof, he quotes the regnal numbers of the kings from Hirom, the friend of Solomon, to Pygmalion inclusive, eleven in all, making a sum (not however expressed) of 177 years 8 months. He adds, from his author, "It was in the seventh year of Pygmalion that Elisa fled from Tyre, and founded Carthage in Libya;" and from

himself, "The sum of years from the reign (epoch) of Hirom to the founding of Carthage is 155 years 8 months; and since it was in 12 Hirom that the Temple was built, the time from thence to the founding of Carthage is 148 years 8 months." (The interval, as the numbers stand in the text, is, in fact, 177 years 8 months, minus 12 of Hirom and 40 of Pygmalion, i. e. only 125 years 8 months: it does not concern us here to consider how the missing 18 years may be restored; the number, 148 years 8 months, given twice by Josephus, is not affected by errors that may have crept into the details.) Now the founding of Carthage is placed by Timæus (Dion. Hal. i, 74) 88 years before Ol. 1, i. e. B.C. 814-18; by Trogus (Justin, xviii, 6) 72 years before the building of Rome, i. e. B.C. 825. Niebuhr (the father), accepting the date B.C. 814-18 as indisputable, deduces for the building of Solomon's Temple the year B.C. 957-56 (*Lect. on Anc. Hist.* iii, 159); Movers (*Phönizier*, ii, 1, 140 sq.), preferring the other, gets the date B.C. 969. Again, Josephus (*Ant.* viii, 8, 1), after stating that 11 Hirom is 4 Solomon, and the year of the building of the Temple, adds (probably from Menander) that the year in question was 240 years from the building of (New) Tyre. It does not appear that he found the 11 or 12 Hirom expressed by Menander or Dios as answering to the 4 Solomon. Probably he obtained the synchronism from his own investigation of the various places in 2 Samuel, 1 Kings, and 1 Chronicles, where Hiram is mentioned; but the number 240 is probably Tyrian. Now Trogus (Justin, xviii, 8) states that Tyre was founded by the Sidonians in the year before the fall of Troy. Among the numerous ancient dates assigned to that event, one is B.C. 1208 (Ephorus, followed by the *Parian Chron.* and other authorities). But B.C. 1209-240=969, precisely the year which resulted from the former argument. Such is the twofold proof given by Movers, accepted by J. v. Gumpach and others, and highly applauded by A. v. Gutschmid (in the *Rhein Museum*, 1857). On the other hand, it should be considered—1. That between the flight of Elisa, in Pygmalion's seventh year, which is the goal of these 148-4 years, and the founding of the city, there certainly occurred a train of events (the settlement in Byrsa=*Bozrah*, and the growth around it of the *Magalga*=*Ma'hal*, which eventually became the New-Town, *Kartharasa*=Carthage) which implies a considerable tract of time; and, 2. That as the ancient dates of the fall of Troy vary over a range of about 180 years, Timæus placing it at 1388, Herodotus at 1270, Eratosthenes at 1183, Aretinus, 1144, besides intermediate dates (Müller, *Fragmenta Chronol.* § 17), the 240 years may be so measured as to fall near enough to the time given to 4 Solomon by the usual chronology. It has generally been received hitherto that the *Æra* of Tyre dates from cir. B.C. 1250, and there seems to be no sufficient reason to the contrary (Bunsen, iv, 280 sq.). The concurrence of the two lines of argument in the year B.C. 969 is one of those coincidences which are so perpetually occurring in chronological combinations that the practised inquirer at last pays little heed to them. In fact, it may only imply that Justin's author got from Menander the date 384 Tyre=7 Pygmalion, mistakenly, as by Josephus, identified with 1 Carthage; and having also obtained from the same or some other source the year equivalent to 1 Tyre, would so arrive at his datum for 1 Carthage, or, *vice versa*, from the latter would rise to the former. And, after all, when we inquire what is the worth of Josephus as a reporter, and, supposing him accurate, what is the value of the Tyrian annals, the answer is not of necessity unfavorable to the claims of the Biblical chronology of the kings of Judah and Israel. Furnished, as this is, by an annalistic series incomparably more full and exact than any profane records of the same times which have come to us at second hand, it is not to be impeached by any but

clear contemporary monumental evidence (such as Mariette's Apis records); and if the entire Hebrew tale of years from 4 Solomon to 11 Zedekiah is to be materially lowered on the scale of the series B.C., this can only be done by proving some capital error in the Astronomical Canon. See TYRE.

8. In fact, an attempt has lately been made in this direction, which, if successful, must set our Biblical chronology adrift from its old bearings. It is contended by Mr. Boanquet (*Readjustment of Sacred and Profane Chronology*, Lond. 1858) that a lower date than 604-606 B.C. for the accession of Nebuchadnezzar is imperatively demanded by the historical connection of that event with the famous "Eclipse of Thales:" which, according to Herodotus (i, 74, 103), occurring during a pitched battle between the Medes and Lydians, was the occasion of a peace, cemented by marriages, between Cyaxares and Halyattes, after which, as Herodotus seems to imply, the former turned his arms against Assyria, and, in conjunction with Labynetus (the Nabopolassar of Berosus and the Canon), took and destroyed Nineveh. The dates assigned by the ancients to that eclipse lie between Ol. 48 and 50. Kepler, Scaliger, and Sir Isaac Newton made it B.C. 585; Bailly (*Philos. Trans.*, 1811) and Oltmanns (*Scr. der Berlin. Akad.* 1812-18) found it 80th Sept. B.C. 610, which date was accepted by Ideler, Saint-Martin, and most subsequent writers. More recently it has been announced by Mr. Airy (*Philos. Mag.* 1853) and Mr. Hind (*Athenum*, Aug. 1867), as the result of calculation with Hansen's improved tables, that in the eclipse of 610 the moon's shadow traversed no part of Asia Minor, and that the only suitable one is that of 28th May, B.C. 585, which would be total in Ionia, Lydia, Lycia, Pamphylia, and part of Cilicia. It has, indeed, been contended by Mr. Adams that the tables need a further correction, the effect of which (as Mr. Airy remarked, *Athenum*, Oct. 1859) would be such as to render the eclipse of 585 inapplicable to the recorded circumstances; but it appears that the astronomer-royal no longer entertains any doubts on this point, having quite recently (see *Athen.* Sept. 1861) expressed his "unaltered conviction that the tables of Hansen give the date of the great solar eclipse, which terminated the Lydian war, as the most reliable records of antiquity placed it, in the year 585 B.C." Indeed, however the astronomical question may ultimately be decided, it would appear, from all that is known of the life of Thales, that he could hardly have predicted an eclipse in Ionia so early as B.C. 610 (Röth, *Gesch. unserer abendländischen Philosophie*, ii, 96). But that the "Eclipse of Thales" occurred at the conjuncture indicated by Herodotus rests only on his testimony, and in this he might easily be mistaken. Either he may have confounded with the eclipse predicted by Thales an earlier one occurring during the war of Cyaxares and Halyattes—possibly that of 610, for no locality is mentioned, and there is nothing to forbid our seeking the battle-field in some suitable situation (e. g. with Niebuhr, p. 508, in Atropatene, or with Von Gumpach, *Zeitrechnung der Bab. u. Aegy. p.* 94, in Armenia); or, he may have assigned to that earlier war what really took place during a later war of the Medes and Lydians under *Astages* and Halyattes. The latter supposition is not without support of ancient authors. Cicero (*de Divinat.* i, 50), from some lost authority, places the eclipse, without date or mention of the war, under *Astages*. Pliny (*H. N.* ii, 9), giving the date Ol. 48.4=B.C. 585, says, also without mention of the war, that the eclipse occurred in the reign of Halyattes (this lasted, in the usual chronology, from B.C. 620 to 563). Solinus (c. 15, 16) assigns Ol. 49.1 as date of eclipse and battle, but (c. 20) he speaks of the war as between Halyattes and *Astages*. From Eudemus, a much earlier author, Clement of Alexandria (*Strom.* i, 14, § 65) gives the date of the eclipse "about Ol. 50," with the addition that it was the time of the war be-

tween Cyaxares and Halyattes—in which Eudemus, if more than the date be his, merely repeats Herodotus; but the addition is as likely to be Clement's own. The Eclipse of Thales, therefore, is by no means so cardinal an event as has been assumed; and to uphold the loose statement of Herodotus, in connection with the earlier date B.C. 610, is as precarious a proceeding as is the attempt to urge it with the lower, and, in all probability, authentic date, B.C. 585, to the subversion of the received chronology. Mr. Bosanquet, however, holds that from the testimony of this eclipse there is no escape; and supporting by this the arguments described under the above heads, together with others derived from new combinations, he does not hesitate to interpose "25 years of Scythian rule in Babylon" between Nabopolassar and Nebuchadnezzar, thereby lowering the epoch of the latter from B.C. 604 to 579. The effect of this is to bring the destruction of the Temple to B.C. 560; Sennacherib's 3d and Hezekiah's 14th year to 689; and the 4th of Solomon to 989 or 990. Of course this involves the necessity of extensive changes in the history and chronology of the lower portion of the 6th century B.C. Thus Cyrus is made into two persons of the name; the first, beginning to reign in Persia B.C. 559, succeeded by Cambyses as viceroy 535 (which is made the 1st year of Evil-merodach), and as king, B.C. 529, together with a second Cyrus as joint-king of Media in 18 Cambyses = B.C. 523. The length of reign of this Cyrus II is not assigned; he disappears from Mr. B.'s table, together with Cambyses, who, with Smerdis between, is followed at 516 by Darius Hystaspis as king, which Darius had become viceroy in Babylon and Media in B.C. 521. It should be remarked that this "readjustment" of the chronology is proposed with a view to a fulfilment of Daniel's Prophecy of the Seventy Weeks (*Chronol. of the Times of Daniel, Ezra, and Nehemiah*, 1849)—namely, the predicted seventy years of desolation reach from the destruction of the Temple, B.C. 560 to B.C. 490; the date of Daniel's prophecy in the first Babylonian year of Darius Hystaspis, then "62 years old" (Dan. vi, 1), is made B.C. 493, whence to the birth of Christ, which the author places (wrongly) in B.C. 3, are the seventy times seven years foretold; also this year 493 is itself the goal of an earlier period of 490 years, reckoned from B.C. 983, Mr. B.'s date of the dedication of Solomon's Temple. So extensive a refashioning of the history will hardly be accepted on the strength of the alleged proofs, especially as the prophecy of Daniel in question is itself susceptible of a better chronological solution. This view was boldly followed out, in ignorance or scorn of all Gentile chronology, by the framers of the Jewish Mundane Era. Assuming that a period of 490 years *must* reach from the destruction of the first Temple to that of the second, which latter they set at A.D. 69 (a year too early), they obtained for 19 Nebuchadnezzar = 11 Zedekiah, the year B.C. 422 (which, in profane chronology, lies in the reign of Darius Nothus). On like grounds Lightfoot does not hesitate to place the first year of Cyrus 490 years before the Passion, for which his date is A.D. 38. "From this year [B.C. 458] to the death of Christ are 490 years; and there is no cause, because of doubtful records among the heathen, to make a doubt of the fixedness of the time, which an angel of the Lord had recorded with so much exactness" (*Harmony of the Old Testament*, in *Works*, i, 312). A late noble writer (Duke of Manchester, *Daniel and his Times*, 1845), with the like end in view, identifies the Darius of Ezra, Haggai, and Zechariah, and of Dan. viii, 1 (made different from him of vi, 1), with Darius Nothus; and, in order to this result, sets himself to show that the founder of the Persian monarchy, whom the Greeks call Cyrus, is in fact Nebuchadnezzar I (the Nabopolassar of the Canon), for the "Persians" and the "Chaldeans" are the same people; his son Cambyses is the Nebuchadnezzar of the

Bible, destroyer of the Temple; Belshazzar is the last king of the Cyrus dynasty at Babylon; his conqueror, "Darius the Mede," Dan. vi, 1, is Darius Hystaspis; and the Biblical Koresh, the restorer of the Jews (and Cyrus of Xenophon, altogether different from him of Herodotus and Ctesias), is a satrap, or feudatory of Xerxes and Artaxerxes. Strange to say, this wild speculation, with its portentous conglomeration of testimonies, sacred and profane, ancient and modern, genuine and spurious (conspicuous among these the "Philo" and "Megasthenes" of the impudent forger Anniius of Viterbo), has not only been gravely listened to by scholars of Germany, but has found among them zealous advocacy and furtherance (Ebrard in the *Theol. Studien u. Kritiken*, 1847; Metzke, *Cyrus der Gründer des Pers. Reiches war nicht der Befreier der Juden sondern der Zerstörer Jerusalems*, 1849). See SEVENTY WEEKS. It should, however, be remarked, that the identification of Ezra's Darius with D. Nothus has commended itself (still with a view to Daniel's prophecy) to more than one eminent writer. Proposed by Scaliger, it is advocated by the late Dr. Mill (in his *Treatise on the Descent and Parentage of our Saviour*, 1842, p. 168). See DARIUS.

9. *Apocryphal Books of the Old Testament*.—(1.) The Book of *Tobit* (q. v.) contains an outline of Assyrian history (from the deportation of the Ten Tribes to the fall of Nineveh), to which the moral fiction is attached (Browne, *Ordo Saecul.* p. 555, note; Niebuhr, *Gesch. Assurs.* p. 100, note; comp. Fritzsche, *Das Buch Tobit*, 1853, p. 14 sq.; Ewald, *Gesch. des V. Test.* iv, 238 sq.). To treat it as a narrative of facts, and apply it to purposes of chronological proof, as some, even recent, writers have done (e. g. Von Gumpach, *Babyl. Zeitr.* p. 188), is quite to mistake its character.—(2.) As regards the Book of *Judith* (q. v.), it is surprising that any one conversant with history and criticism should fail to see that this is not a record of facts, but a religious, quasi-prophetic allegory (*Ordo Saecul.* p. 556, note; Fritzsche, *Das B. Judith*, p. 123 sq.; Ewald, *Gesch. des V. Israel*, iv, 541. See also Movers in the *Bonn. Zeitschr. für kath. Theologie*, 1835, p. 47). Niebuhr, acknowledging this (*u. s.* p. 212-285), nevertheless finds in its dates, according to the Lat. version, a background of historical truth with reference to the times of Nebuchadnezzar. V. Gumpach (*u. s.* p. 161 sq.) maintains its historical character, and applies it to his own purposes with extraordinary confidence (see also Scholz, *Eins. in die heil. Schriften*, 1845).—(3.) In the books of *Maccabees* (q. v.) the years are regularly counted, under the name ἔτη τῆς βασιλείας τῶν Ἑλληνῶν, meaning the era of the Seleucidae, beginning in the autumn of B.C. 312; except that in the first book the epoch is made 1 Nisan of that year, while in the second book it is 1 Tisri of the following year, B. C. 311, i. e. eighteen months later. This, which has been sufficiently proved by earlier writers (see Ideler, *Hdb. der Chronol.* i, 581 sq.; *Ordo Saecul.* § 440-42), is contested on inadequate grounds by Von Gumpach (*Zwei chronol. Abhandl.* 1854).

IV. *New-Testament Chronology*.—The Gospels and Acts of the Apostles have (with one exception, Luke iii, 1) no express dates; in the absence of these, combinations, more or less probable, are all that the chronologist has to go by.

1. For the *Nativity* (q. v.), the criterion limit is furnished by the death of Herod (Matt. ii, 1, 19; Luke i, 5), the year of which event, as it is nowhere named by Josephus or any other extant historian, has to be determined by various circumstances. These are the mention of an eclipse of the moon not long before it (*Ant.* xvii, 6, 4 fin.), which, by calculation, can only have been that of March 12-13, B.C. 4; and the length of Herod's reign, together with the recorded date of its commencement (*Ant.* xvii, 8, 1; comp. xiv, 14, 5; 16, 4), and of that of his sons—Archelaus (*Ant.* xvii, 18, 3; comp. *War*, ii, 7, 3), the consular year of whose de-

posal is given by Dion Cass. iv.; Herod Philip (*War*, xviii, 4, 6, length of reign and year of death); for Herod Antipas, Josephus (*Ant.* xviii, 7, 2) gives the date of deposit, but not length of reign; this, however, is known from coins (Eckhel, *Doct. Num.* iii, 489) to have reached his 43d year. All these indications point to B.C. 4, not long before the Passover, as the time of Herod's death. See HEROD. Those who would impugn this conclusion urge other, discrepant statements in Josephus, or call in question either the fact of the eclipse or its calculated date, or contend that the death of Herod could not have taken place so soon after it. The inducement is that our Lord's age may not exceed thirty years at the time of his baptism, i. e. at the earliest in the 15th year of Tiberius, for if this note of time is to be taken strictly, the earliest date for the Nativity should be the year B.C. 8. The year being supposed to be known, it is attempted to approximate to the day by calculating the order of the sacerdotal cycle, and finding at what time in the given year "the course of Abijah" (Luke i, 5) entered upon office. The starting-point for the reckoning is furnished by a Jewish tradition (*Mishna*, iii, 298, 8), and it is assumed that the conception of John the Baptist ensued at the expiration of Zechariah's week of service, and the Annunciation five months later (Luke i, 28-26, 86; but in the Church calendars six months). Here it should be observed that we have no reason to suppose the ancients to have been in possession of the true date, either year or day. Having ascertained, as they supposed, the year and day of the Baptism, they counted back 80 years to the Nativity (see a paper by H. Browne, on *S. Clemens Alex. on N.-T. Chronology in the Journal of Classical and Sacred Philology*, 1854, i, 827 sq.). Also, it would be well that all such considerations as the "fitness of things" prescribing a particular year, or day of the year, for this or any other event of sacred history, should be banished from chronological investigations. See JESUS.

2. Luke's date, "15th of Tiberius" (iii, 1), interpreted by the rule of the imperial annals (and also of the canon), would denote the year beginning August A.D. 28, and ending in the same month of A.D. 29. Referred to the current consular year, it might mean either A.D. 28 or 29. Taken in the Jewish sense, it might be the year beginning either 1 Nisan or 1 Tisri A.D. 28, or even 1 Tisri A.D. 27. The hypothesis of a dating of the years of Tiberius from an epoch earlier by three years than the death of Augustus has, however, been generally adopted from the 16th century downward, and is demanded (see Strong's *Gr. Harmony*, p. 842 sq.) by the age of Jesus at his baptism (80 years), added to the length of his ministry (8 years), as compared with the date of the Crucifixion (see below). In A.D. 11, Tiberius appears to have assumed the government of the provinces, and from this time his reign would naturally be reckoned by the Jews (see Jarvis, *Introd.* p. 229 sq.). This would give Luke's date of John's mission B.C. 27. See TIBERIUS.

3. The note of time (John ii, 10) connected with the Passover after the Baptism points, if the "forty and six years" are reckoned from Herod's announcement of his purpose in his eighteenth year (*Ant.* xv, 11, 1) to A.D. 27; if from the actual commencement, after all the materials were provided, it may denote either A.D. 28, or 29, or 30, according to the length of time supposed to be spent in preparation. But here, again, besides discrepant statements in Josephus as to the epoch of Herod's reign, it chances that the earlier account of the same proceedings (*War*, i, 21, 1) dates this undertaking of Herod in his *fifteenth* year. It does indeed admit of proof, even from the context, that the 15th year is too early; but it may, plausibly enough, be urged by those who wish to do so, that, if Josephus is wrong in the one statement, he is just as likely not to be right in the other. See TEMPLE.

4. The Crucifixion (q. v.) certainly cannot be placed

earlier than A.D. 28, in which year the 15th of Tiberius began, and it has never been proposed by inquirers of any note to place it later than A.D. 33. The astronomical element of the question—namely, that in the year of the Passion the 14th of Nisan fell on a Friday—if it be rigorously applied, i. e. according to a definite rule of Jewish usage and the results of strict lunar calculation, indicates only one of the six years mentioned, viz. A.D. 29, in which 14 Nisan was 18th March and Friday. If a certain laxity as to the rule be allowed, the 14th Nisan may possibly have fallen on 3d April, Friday, in A.D. 33. But if, in compliance with the apparent import of the first three Gospels, without explanation from the fourth, it is contended that the Crucifixion took place on the day after the Passover, the year may have been A.D. 30, in which the 15th Nisan fell on Friday, 7th April, or A.D. 33, in which it was (in strictness) Friday, 3d April. Lastly, if it be maintained that the Jewish Passover-day was regulated, not by actual observation of the moon's phases, but by cycles more or less faulty, any year whatever of the series may be available in one form or other of the hypothesis. See PASSOVER.

Ancient testimony, if that is to have weight in this question on the supposition that the year was known, either by tradition or by access to public records (the *Acta Pilati*, to which the ancients so confidently appeal), certainly designates the Passover of the year 29, *coes. duobus Geminis*, the 15th proper year of Tiberius. In the Western Church the consent to this year is all but general; in the Eastern, the same year is either named or implied in the two earliest extant testimonies, Clem. Alex. (*Strom.* i, 21, § 101-143; see *Journ. of Class. and Sac. Philol.* u. s.) and Julius Africanus. See JESUS.

5. In the *Acts*, the mention of the death of Herod Agrippa (xii, 23), interposed between an arrival of Paul at Jerusalem and his return thence to Antioch (xi, 80; xii, 25), would yield a firm resting-point for that portion of the narrative, viz. Easter, A.D. 44 (Josephus, *Ant.* xviii, 8, 2; comp. xix, 5, 1; *War*, ii, 11, 6), could we be certain that the death of Agrippa took place soon after, or even in the same year with the Easter mentioned xii, 8, 4. (The time of Agrippa's death is determinable with high probability to the beginning of August of that year.) But as it is possible that the writer, after his narrative of the acts of this king, thought fit to finish off all that he had to say about him before going on with the narrative about Paul and Barnabas, it may be that their mission to Jerusalem, and return, after the martyrdom of James and deliverance of Peter, took place before the year 44. It might even be inferred from xi, 26 (*ἡμετέρας ἡμετέρας ἡμετέρας*), that the prophecy of Agabus was delivered before, or quite in the beginning of A.D. 41, as the famine is known to have prevailed at Rome during the first two years of Claudius (A.D. 41, 42; Dion Cass. ix, 11), but that it appears not to have been felt in Judea till after the death of Agrippa, in the procuratorship of Cuspius Fadus and Tiberius Alexander (A.D. 45-47; Josephus, *Ant.* xx, 2, 5; 5, 2). Conclusive reasons for assigning this second visit of Paul to Jerusalem to the year 44 must be sought elsewhere. (See Lehmann, in the *Stud. u. Krit.* 1858, ii.) See AGRIPPA.

6. In Gal. i, 2, Paul speaks of two visits to Jerusalem, the one (i, 18) "after three years" (viz. from his conversion), the other (ii, 1) "fourteen years afterward" (*διὰ δεκατεσσάρων ἐτῶν*). The first of these is evidently that of Acts ix, 26; that the other must be the second of those mentioned in the Acts, viz. that of xi, xii, has been understood by many, and probably would have been by all, could it have been made to square with their chronology. The argument, restricted from irrelevant issues, lies in a very narrow compass. To make good his assertion (i, 11 sq.) that he received not his gospel and commission from Peter, or any other man, but direct from Christ himself, the

apostle begins to enumerate the occasions on which alone he saw and conversed with the other apostles at Jerusalem. Now, if the visit Gal. ii, 1, be not that of Acts xi, 12, it must be later (no one wishes to put it earlier); but, if so, then it would seem he has not enumerated all the occasions on which he saw the other apostles. It is hardly satisfactory (comp. Meyer on Gal. p. 41) to allege (with Wieseler, *Chronol. des apost. Zeitalters*, p. 180) that the apostle, not writing a history, is not bound to recite all his visits to Jerusalem, or (with Ewald, *Gesch.* vi, 50) that he is concerned to enumerate only those visits which he made for the purpose of conferring with the apostles. His intention is plainly to state that he had no intervening opportunity of consulting them. Accordingly, Schleiermacher (*Einleit. ins N. T.* p. 569), Neander (*Pfham. u. Leit.* i, 188 of the 4th ed.), De Wette (*Komm.* in loc.), Meyer (*u. s. p.* 47), find the conclusion inevitable that Luke was misinformed in saying that Paul went up to Jerusalem as related in Acts xi, 30, because the apostle himself declares that between his first visit, which can be no other than that of ix, 26, and the other, which can only have been that to the council, as related in Acts xv, there was none intermediate. But, in fact, the circumstances of the visit, Gal. ii, 1, are perfectly compatible with those of Acts xi, xii, the only difficulty being that which is supposed to lie in the chronology; nor, on the other hand, is the discrepancy between Gal. ii, 1 sq., and Acts xv, such that it is difficult to see how they can relate to the same fact, although the incongruity in the latter case has been deemed by Baur (*Paulus*, p. 120 sq.) so great as to furnish an argument in support of his position that the Book of Acts is the work, not of a companion of Paul, but of some much later hand (in the second century). Wieseler, to evade this conclusion, gives up the assumed identity of Gal. ii, 1, with Acts xv, and labors to show that it was the visit of xviii, 22, a hypothesis which needs no discussion, unless we are prepared to say that the apostle was not even present at the council, Acts xv; for that a council was held is not denied, even by those who contend that the account given of it in the Acts is not authentic; and, if Paul was present at it, it is impossible to explain his passing it by in silence, as if it had no bearing upon the point which he is concerned to substantiate. The time of Acts xii being defined to A.D. 44, a term of 17 years, the sum of the 8 and the 14, supposed to be consecutive, would lead to A.D. 27, which cannot possibly be the year of Paul's conversion; and, if both terms are supposed to be dated from the same epoch, it would follow that the conversion took place A.D. 80, a date still too early for those who assign the Crucifixion to that or to a later year. But it is not too early if the year of the Passion be A.D. 29; and it is in exact accordance with the most ancient traditions recorded by ecclesiastical writers, according to which the martyrdom of Stephen took place within a year after the Ascension, and Paul's conversion, which clearly was not much later, in the year after the Ascension, i. e. in this year 80 (Browne, *Ordo Saec.* § 102). On the other hand, this date of Paul's conversion is equally compatible with the reference of the second visit in question to Acts xv, which took place A.D. 47; the reckoning of the 14+8 years of Gal. i being in that case continuous from the conversion in A.D. 80. On either view, however, there is clearly an error in the ordinary chronology, which brings down the conversion to A.D. 84, and yet dates the visit of Acts xi in A.D. 44, and that of Acts xv in A.D. 46; a system which there is other and independent reason to suspect (see *Met. Quart. Review*, July, 1850, p. 500). See PAUL. The chronological difficulty, which would present itself as soon as the ancient date of the Passion was abandoned for a later year, has induced the conjecture, seemingly as early as the *Chron. Pasch.* p. 486, ed. Bonn, that for 14 should be read 4 (ΔΙΑ Δ' for ΔΙ' ΙΔ'); see Meyer

u. s. p. 49. On this supposition the conversion might be assigned to A.D. 87, the first visit to A.D. 40, the second to A.D. 44. With this would accord the note of time 2 Cor. xii, 2, according to the ancient date of that epistle, viz. A.D. 54, that year being 14 years after the date so assigned to the first visit and the trance (Acts xvii, 17). But there is no need of this conjectural emendation, for the vision of 2 Cor. xii, 2 (which is distinguished from that of Acts xxii, 17, by the fact that the apostle was forbidden to divulge the revelations of the former, whereas he relates what was said to him in the latter) may naturally have happened during the ten years which he spent in his native neighborhood (Gal. i, 21; comp. 2 Cor. xii, 24, 25).

7. The mention of Gallio (xviii, 12) would furnish a note of time, were the date of his proconsulate in Achaia on record. We can only conjecture that it was through the interest of his brother Seneca, who, disgraced and in exile from 41 to 48, thereafter stood in the highest favor with Claudius and Agrippina, that Gallio was presently made consul (suffect) and then proconsul of Achaia (Plin. *H. N.* xxxi, 38; comp. Senec. *Ep.* 105). So the date would be not earlier than 49, and not much later. See GALLIO.

8. The decree of Claudius for the expulsion of all Jews from Rome (xviii, 2) is mentioned by Suetonius in a well-known passage (*Claud.* 25), but neither dated nor placed in any discoverable order of time (Dion Cass. ix, 6, relates to merely restrictive measures taken or contemplated in the beginning of the reign). If, as is likely, it formed part of a general measure for the expulsion of the "astrologers" (*Chaldaei, mathematici, astrologi*), its date may be as late as A.D. 52, in which year a severe statute of this nature was enacted ("De mathematicis Italia pellendis factum SC. atrox et irritum," Tacit. *Ann.* xii, 52). But Zonaras (p. 972, ed. Reimar), in the summary compiled from Dion Cass., places an expulsion of the astrologers from Italy immediately after the elevation of Agrippina, A.D. 49, and before the arrival of Caracacus at Rome, A.D. 50; and in Tacitus (*u. s.* 22) we find Agrippina, just after her marriage, accusing her rival Lollia of dealings with Chaldeans and Magi. It is not likely that any general severe measure against the Jews would be taken while the younger Agrippa, a special favorite of Claudius, was still at Rome, as he certainly was to the end of 48, when he succeeded his uncle Herod as king of Chalcis (Josephus, *Ant.* xx, 5, 2; 7, 1; *War.* ii, 14, 4, where for *ἐπτακαίδεκαρον* we must read *ἑννακαίδ.*). The insurrectionary movements in Judæa early in A.D. 49 may have been connected with the decree as cause or effect (*Ant.* xx, 5, 8, 4). All these indications point to the year 49, and it is remarkable that that is the year named by Orosius (*Hist.* vii, 6, "ninth year of Claudius"), from some lost source of intelligence ("ut Josephus tradit," he says; but that is a mistake). See CLAUDIUS.

9. The year of the recall of Felix and appointment of Festus as his successor (*Acts* xxiv, 27) is not on record, and the arrival of Paul at Rome, in the spring of the following year, has been assigned to every one of the years, from A.D. 56 to 63 inclusive. The earliest is that given by the ancients, and is advocated by Browne, in *Ordo Saeculorum*, § 108 sq. But one principal argument there used is not tenable. From the statement of Josephus (*Ant.* xx, 8, 9), that Felix, on his return to Rome, escaped condemnation upon the charges laid against him before Nero chiefly through the influence of his brother Pallas, whose consideration with that emperor was "just then at its highest" (*μάλιστα δὴ τότε διὰ τμητῆς ἔχων ἰσχύον*), combined with the fact, related by Tacitus (*Ann.* xiii, 14, 15), of Pallas's removal from his office at the head of the *fiscus* shortly before the death of Britannicus, who had nearly completed his 14th year, and with the latter part of the statement in Sueton. (*Claud.* 27), that Britannicus was born "vigesimo imperii die inque secundo consulatu"

(= A. D. 42), Browne inferred that not long before Feb., A. D. 56, Pallas had ceased to be at the height of imperial favor; consequently the recall of Felix could not be placed later than the summer of A. D. 55. This must be rejected; for Tacitus (*u. s.* 15) evidently places the death of Britannicus *early* in 55, the events of which year begin at ch. xi and end with ch. xxv; therefore the former part of Suetonius's statement is alone true—that Britannicus was born on the 20th day of the reign of Claudius, = 18th Feb., A. D. 41. Dion Cassius, indeed, mentions the birth under the second year (lx, 10), but not until he has expressly returned to the former year (*τῷ προτέρῳ ἔτει*). Hence it is clear that if the date of Pallas's loss of office is decisive for the date of his brother's recall, this must have occurred, at latest, in 54, before the death of Claudius (18th Oct. of that year), and no part of the procuratorship of Felix would have been under Nero; a result totally incompatible with the narrative of Josephus (*Ant. xx, 8; War, ii, 13*). On the other hand, it is hard to say at what conjuncture in Nero's time Pallas could be said to have been held thus at his highest estimation. At the very beginning of the reign it is noted of him that his arrogance had excited the emperor's disgust (*Tacit. Ann. xiii, 2*); within a month or two he is removed from the *ſæcus*; about a year later, when impeached, together with Burrus, his reputation for insolence stood in the way of his acquittal (*Tacit. u. s.* 23); as the ally of Agrippina he was an object more of fear than of favor; and his great wealth caused his removal by death, A. D. 62, as his longevity seemed to preclude the hope of the emperor's otherwise possessing it (*Ann. xiv, 65*). This affords strong reason to suspect that in this matter of Pallas's influence, exercised on behalf of his brother, Josephus was misinformed. Of very material circumstances relative to Felix he certainly was ignorant, unless we are to suppose that Tacitus, on the other hand, had no documentary warrant for the very circumstantial account which he gives under the year 52 (*Ann. xii, 54*); how Felix had then been some time governor of Judæa ("jam pridem Judæa impositus"), holding a divided command with Cumanus, the latter being over the Galileans, while Felix was over the Samaritans ("ut huic Galilæorum natio, Felici Samaritæ paterent"). He may have mistaken the nature of this divided rule; in fact, there is reason to believe that Felix held a military command, as Suetonius relates (*Claud. 28*: "Felicem legionibus et aliis provinciisque Judæa impositus"), and Victor (in the *Epitome*, p. 861: "Felicem legionibus Judæa præfeci"). Of that associated government, and of Felix's equal share in the wrongs of which Cumanus was accused, Josephus is ignorant; but what he says of Pallas and Felix is far more suitable to that earlier conjuncture, as described by Tacitus, than to the later occasion to which he refers it. At that time, viz. when Cumanus was deposed, "Felix would certainly have suffered for the wrongs done by him to the Jews but for the intercession of his brother Pallas, whom the emperor [Claudius] at that very time held in the highest consideration;" for that Pallas just then had reached the pinnacle of his commanding influence, Tacitus shows in the preceding recital of the public honors decreed to him, and by him recorded as the crowning glory of his life in his own epitaph (*Plin. Ep. vii, 29; viii, 6*). Even in the account Josephus gives of that earlier conjuncture (in which he speaks only of Cumanus and the final hearing before Claudius, *Ant. xx, 6, 8*), he mentions the "very great exertions made by the emperor's freedmen and friends for Cumanus and the Samaritans." The absence of dates, of which Josephus is not sparing when he has them, of itself implies that his materials for the account of Felix were scanty; and the way in which Burrus is introduced, after the passage relating to Pallas (*Ant. xx, 8, 9*), strengthens the suspicion raised by the conflicting account in Tacitus, that the Jewish historian in this paragraph is mixing up, with his recital of what took

place on the recall of Felix, occurrences of an earlier time. Certainly the accompanying notice (*καὶ ἀγαγός*), "he was the tutor of Nero," is more apposite to that earlier conjuncture in the time of Claudius (A. D. 52), when Nero was barely fourteen years old. It might still, in some sense, be notable as the ground of Burrus's influence in the beginning of Nero's reign, when he and Seneca are spoken of having charge of the imperial youth ("rectores imperatoris juvenæ," *Tacit. Ann. xiii, 2*); but the description is very strange when referred to the year 61, the last of Burrus's life, especially as this is not the first mention of him. See FELIX.

10. The argument for the year 61, as the date of Paul's arrival at Rome, is thus put by Wieseler (*Chronologie des Apost. Zeitalters*, p. 66 sq.). The narrative of Josephus (*Ant. xx, 8; War, ii, 13*), from Nero's accession (18th Oct., A. D. 54) to the defeat of the "Egyptian," implies at least two years; this impostor, claiming to be another Moses, would of course make his appearance at the Passover, i. e. at the earliest, that of A. D. 57. That this must have been at least a year before Paul's arrest is implied in the tribune's expression, "before these days" (*Acts xxi, 38*); therefore the earliest possible date for this arrest is A. D. 58, Pentecost; the "two years" of xxiv, 27, gives A. D. 60 as the earliest possible date for the arrival of Festus, and the spring of 61 for the apostle's arrival at Rome. The latest possible is given by the liberty allowed Paul (*Acts xxviii, 31*), for the Neronian persecution began July, A. D. 64. The extreme date hence resulting is limited by further considerations. Pallas and Burrus were living and influential men at the time when Felix was recalled; but Pallas died in the latter half, and Burrus in the first or second month of A. D. 62; consequently Felix arrived in 61 at latest. But Paul was delivered to the *one præfect* of the prætorian guards, *τῷ σπαρτορείδῳ*, who must therefore be Burrus, before and after whom there were two. As Burrus died Jan. or Feb., and Paul arrived May or June, the year could not be 62, and the latest possible date would be A. D. 61. Latest possible and earliest possible thus coinciding, the date, Wieseler thinks, is demonstrated. To this it is objected, and justly, that *τῷ σπαρτορείδῳ* of necessity means no more than the præfect concerned (*Meyer, Komm. in Apostelgesch.*, p. 19; Lange, *Apost. Zeit.* ii, 9). In favor of the later date (A. D. 62), it is urged that on the hearing before Nero of the complaints relative to Agrippa's building overlooking the Temple (Josephus, *Ant. xx, 8, 10, 11; War, ii, 14, 1*), the Jews obtained a favorable judgment through the influence of Poppæa, "Nero's wife." But Poppæa was married May, 62, and undoubtedly Festus's successor, Albinus, was at Jerusalem in the Feast of Tabernacles of the same year (Josephus, *War, vi, 5, 3*). Hence it is argued that unless Josephus's expression, "at that time" (*κατὰ τὸν καιρὸν τούτου*, *Ant. xx, 8, 11*), is taken with undue latitude, Festus cannot have entered upon the province earlier than A. D. 61 (*Meyer, u. s.*). Ewald (*Gesch.* vi, 44) also urges the ἀνωλύτως, "no man forbidding him," of *Acts xxviii, 30*, for this year 62, and calls attention to the circumstance that the imperial rescript, rescinding the Jewish isopolity, obtained by the Greeks of Cæsarea through the influence of Burrus (Josephus, *Ant. xx, 8-9*), is spoken of as something recent in the beginning of the rebellion (spring of A. D. 66); indeed (in *War, ii, 14, 4*), it seems as if the rescript had but just then reached Cæsarea. Ewald surmises that the death of Festus and of Burrus may have retarded the process. But the fact may be (as was suggested above) that Josephus in that passage has confused some exercise of Burrus's influence in behalf of the Cæsarean Greeks, in the time of Claudius, or early in the time of Nero, with the much later matter of the rescript, which would officially pass through Burrus's hands as secretary for the East (*τάξιν τῶν ἐπιτοῶν Ἑλληνικῶν ἐπιστολῶν πεπιστευμένως*), and the opera-

tion of which may have been delayed through the influence of Poppæa (who died Aug., A.D. 65). That Poppæa is spoken of as Nero's "wife," on the occasion above mentioned, may be merely euphemistic anticipation: this woman ("dū pellex, et adulteri Neronis, mox mariti potens," Tacit. *Ann.* xiv, 60) may have befriended the Jews in the former capacity (at any time after A. D. 58, *Ann.* xiii, 45). In fact, the marriage could not have taken place at the time when she is said to have aided them, unless it be possible to crowd the subsequent occurrences of Josephus (*Ant.* xx, 8, 11 and 9, 1) into the space of three or four months (Browne, *Ordo Sæcl.* p. 122). Nor can any certain inference be drawn from the narrative in Josephus (*Life*, 3) of certain priests whom Felix had sent to be tried at Rome, and for whom Josephus, after his own 26th year, which was complete A.D. 64, was enabled, through the good offices of "Cæsar's wife," Poppæa, to obtain their liberty. The men had been prisoners three years at least, and, for aught that appears, may have been so seven or eight years or more. That they were obscure and insignificant persons is evident from the fact that Ismael and Helkias, whom the "devout" Poppæa, two years before, had graciously detained at her court, appear to have made no intercession for their release. See NERO.

But Wieseler (p. 99), after Anger (*De temp. in Act. Ap. ratione*, p. 106), has an argument to which both attach high importance, derived from the notice of a Sunday (Acts xx, 7), the twelfth day after leaving Philippi, which departure was "after the days of Azyma" (15-21 Nisan), and, indeed, very soon after, for the apostle "hasted, if it were possible, to reach Jerusalem for the Pentecost" (verse 16); and of the 49 days which he had before him from 22 Nisan to the day of Pentecost, the days specified or implied in the narrative (Acts xx, xxi), amount to 35 to the landing at Cæsarea (comp. Chrysost. in *Act. Hom.* xlv, 2), leaving but eight days for the stay there (*ἡμέρας πλείους*, xxi, 10) and the journey to Jerusalem. Wieseler concludes that the departure from Philippi was on the 23d Nisan, which, being twelve days before the Sunday at Troas, would be Wednesday, consequently the 15th Nisan fell on a Tuesday. According to his method of Jewish calendar reckoning, from A.D. 56 to 59 inclusive, the only year in which 15th Nisan would fall on a Tuesday would be 58, which is his date for Paul's arrival at Jerusalem. Were it worth while, the argument might be claimed for the year 55 (the date assigned by the ancients), in which year the day of true full moon=15 Nisan was 1st April and Tuesday. But, in fact, it proves nothing; the chain is no stronger than its weakest link, and a single "perhaps" in the reckoning is enough to invalidate the whole concatenation. See PASSOVER.

On the whole, it seems that, if not in the Acts (q. v.), then neither in the history of the times from other sources, have we the means of settling this part of the chronology with absolute certainty. Josephus in particular, from whom are derived the combinations which recent German writers deem so unanswerable, is discredited in this part of the history (written probably from his own resources and the inaccurate recollections of his boyhood) by the infinitely higher authority of Tacitus, who drew his information from the public records. Only, in whatever degree it is probable that Paul's first residence at Corinth commenced A.D. 49 (§ 3, above), in the same it is probable that the arrest at Jerusalem belongs to the year 55, six years being sufficient, as nearly all inquirers are agreed, for the intermediate occurrences. Then, if the arrival at Rome took place, as the ancients say, in the second year of Nero, it will be necessary (with Petavius) to refer the "two years" (*ἑτέρα, xxiv, 27*) to the term of Felix's (sole) procuratorship. See CORINTHIANS (EPISTLES TO).

That the two years' imprisonment, with which the narrative in the Acts ends, did not terminate in the

apostle's death, but that he was set at liberty, and suffered martyrdom under Nero at a later time, appears to have been the unanimous belief of the ancients (see the testimonies in Browne's *Ordo Sæcl.* § 180). Indeed, in no other way is it possible to find a place for the three pastoral epistles, and especially to account for statements in the Second Epistle to Timothy (q. v.). Wieseler's forced explanations have satisfied and can satisfy no one. (See also Lange, *Apostol. Zeitalter*, ii, 386 sq., and Huther, in Meyer's *Krit. exeg. Komm.* p. 25 sq. Meyer himself, *Römerbr.* Einleit, p. 12 sq., owns that the three pastoral epistles "stand or fall together," and that, if they be genuine, the conclusion is inevitable; which he turns into an argument against their genuineness.) But if, after his release, the apostle visited not only Spain (as Ewald admits, *Gesch.* vi, 631, on the unquestionable testimony of Clemens, *Rom.* c. 5), but Greece and Asia, as is clear from the Epistles to Timothy and Titus, scant room is left for these movements between the late dates assigned, with almost one consent, by recent German writers, to the close of the first imprisonment (A.D. 63 and 64), and the year 65 or 66, which the ancients give as the date of Paul's martyrdom. So far, therefore, it is more probable that the first imprisonment ended in one of the years 58-60. Another consideration points the same way: when Poppæa's influence was established (A.D. 58-65), which, after she became a proselyte or *θεοσεβής* (i. e. at least as early as 61), was freely used in favor of the Jews, it would certainly have been invoked against the apostle by his enemies (comp. Ewald, vi, 621); and, even if he escaped with life, his confinement would not have been of the mild character described in the concluding verse of the Acts, more especially as his "bonds in Christ were manifest in all the palace" (pretorium), (Phil. i, 18), and among his converts were some "of Cæsar's household" (iv, 22).

We may add that if the Narcissus (q. v.) of Romans xvi, 11, was the celebrated freedman of Claudius, the Epistle to the Romans (q. v.), written shortly before the apostle's last visit to Jerusalem, cannot be placed so late as A.D. 58 or 59, for Narcissus died very soon after Nero's accession (Tacit. *Ann.* xiii, 1). See PAUL.

V. *Results*.—The following table exhibits at one view the Julian or calendar years of the most important Biblical events from the Creation, and also the Vulgar or Christian *Æra*, according to the preceding investigations (for a complete and self-verifying tabular construction of all the Scriptural dates, with their adjustment to each other and the demands of history, and the authority upon which it rests, see the *Metk. Quart. Review*, October, 1856, p. 601-638). In cases where it is uncertain whether an event occurred in the latter part of one Julian year or in the beginning of the next, the earlier number is set down, and has a star prefixed. In the centuries adjacent to the birth of Christ, many events affecting Palestine are inserted from the Apocrypha, Josephus, and other sources, in addition to those properly Biblical.

A.M.	B.C.	
	1	4173 Creation of Adam.
*181	4042	Birth of Seth.
*236	3937	Birth of Enos.
*326	3847	Birth of Cainan.
*396	3777	Birth of Mahalaleel.
*461	3713	Birth of Jared.
*623	3550	Birth of Enoch.
*683	3485	Birth of Methuselah.
*875	3298	Birth of Lamech.
*981	3243	Death of Adam.
*988	3156	Translation of Enoch.
*1048	3180	Death of Seth.
1068	3115	Birth of Noah.
*1141	3032	Death of Enos.
*1236	2937	Death of Cainan.
*1291	2882	Death of Mahalaleel.
*1428	2750	Death of Jared.
*1557	2616	Birth of Japheth.
*1559	2614	Birth of Shem.
*1652	2521	Death of Lamech.
1667	2516	Death of Methuselah.
		Beginning of the Flood.

A.M.	B.C.	
1658	2515	End of the Flood.
*1659	2514	Birth of Arphaxad.
*1694	2479	Birth of Salah.
*1724	2449	Birth of Eber.
*1758	2415	Birth of Peleg.
*1788	2385	Birth of Heu.
*1820	2353	Birth of Serug.
*1829	2353	Birth of Nahor.
*1879	2294	Birth of Terah.
*1949	2224	Birth of Haran.
*1997	2176	Death of Peleg.
*1998	2175	Death of Nahor.
*2007	2166	Death of Noah.
*2009	2164	Birth of Abram.
*2019	2154	Birth of Sarah.
*2027	2146	Death of Heu.
*2050	2123	Death of Serug.
*2084	2089	Death of Terah.
2085	2088	Abram's Departure from Haran.
*2095	2078	Birth of Ishmael.
*2097	2076	Death of Arphaxad.
2109	2064	Circumcision instituted.
		Promise of Isaac.
3110	3063	Birth of Isaac.
*3127	3046	Death of Salah.
*3146	3027	Death of Sarah.
*3149	3024	Marriage of Isaac.
*3159	3014	Death of Shem.
*3169	3004	Birth of Jacob and Esau.
*3184	1989	Death of Abraham.
*3185	1985	Death of Eber.
*3000	1964	First Marriage of Esau.
*3332	1941	Death of Ishmael.
2246	1927	Flight of Jacob from Home.
2253	1920	Marriage of Jacob to Leah and Rachel.
3254	1919	Birth of Reuben by Leah.
3235	1918	Birth of Simeon by Leah.
2256	1917	Birth of Levi by Leah.
		Marriage of Jacob with Bilhah.
2257	1916	Birth of Judah by Leah.
		Birth of Dan by Bilhah.
		Marriage of Jacob with Zilpah.
2258	1915	Birth of Naphtali by Bilhah.
		Birth of Gad by Zilpah.
2260	1914	Birth of Issachar by Leah.
		Birth of Asher by Zilpah.
		Birth of Zebulun by Leah.
2260	1913	Birth of Dinah by Leah.
		Birth of Joseph by Rachel.
2266	1907	Departure of Jacob from Laban.
2278	1895	Sale of Joseph by his Brethren.
2288	1885	Dreams of the Baker and Butler.
2289	1884	Death of Isaac.
2290	1883	Promotion of Joseph.
2298	1875	First Journey of the Patriarchs into Egypt.
2299	1874	Migration of Jacob's Family to Egypt.
*2316	1857	Death of Jacob.
*2370	1803	Death of Joseph.
2435	1738	Birth of Moses.
2475	1698	Flight of Moses into Midian.
2515	1658	Exodus of the Israelites.
2516	1657	Setting up of the Tabernacle.
2554	1619	Return of the Israelites to Kadesh.
		Death of Aaron.
2555	1618	Death of Moses.
		Entrance of the Israelites into Canaan.
2561	1612	Conquest of Canaan completed.
*2580	1593	Death of Joshua.
*2598	1575	Subjugation by Chushan-Rishathaim.
*2596	1567	Deliverance by Othniel.
*2646	1527	Subjugation by Eglon.
*2664	1509	Deliverance by Ehud.
*2474	1420	Judgeship of Shamgar.
		Subjugation by Jabin.
*2764	1409	Deliverance by Barak.
*2804	1369	Subjugation by the Midianites.
*2811	1362	Deliverance by Gideon.
*2831	1322	Usurpation by Abimelech.
*2834	1319	Appointment of Tola as Judge.
*2877	1276	Appointment of Jair as Judge.
*2899	1274	Subjugation by the Ammonites.
*2917	1256	Deliverance by Jephthah.
*2925	1250	Appointment of Ibzan as Judge.
*2930	1245	Appointment of Elon as Judge.
*2940	1233	Appointment of Abdon as Judge.
*2945	1225	Subjugation by the Philistines.
*2988	1185	Deliverance by Samson.
*3008	1165	Appointment of Eli as Judge.
3045	1125	Capture of the Ark by the Philistines.
3049	1124	Restoration of the Ark by the Philistines.
3065	1105	Deliverance by Samuel.
*3080	1095	Accession of Saul.
3089	1084	Defeat of the Ammonites by Saul.
3090	1083	Birth of David.
3100	1073	War of Saul with the Philistines.
3108	1070	Capture of Agag by Saul.
*3105	1068	Secret Anointing of David by Samuel.
*1110	1063	Combat of David with Goliath.
		Flight of David from Saul's Court.

A.M.	B.C.	
3112	1061	Refuge of David at Gath, etc.
3113	1060	Death of Samuel.
3118	1056	Second Sparing of Saul by David.
3119	1054	Residence of David at Zikiag.
3120	1053	Accession of David at Saul's Death.
3127	1046	Coronation of David over all the Tribes.
3128	1045	Defeat of the Philistines by David.
3129	1044	Expulsion of the Jebusites by David.
3130	1043	Removal of the Ark to Jerusalem.
*3136	1037	Kindness of David to Saul's Family.
3185	1035	Adultery of David with Bathsheba.
3188	1034	Birth of Solomon.
*3140	1033	Incest of Amnon with Tamar.
3150	1023	Rebellion of Absalom.
3153	1015	Usurpation of Adonijah.
3159	1014	Birth of Rehoboam.
		Appointment of Solomon as Viceroy.
3160	1013	Accession of Solomon at David's Death.
3163	1010	Founding of Solomon's Temple.
3170	1003	Dedication of Solomon's Temple.
3200	973	Accession of Rehoboam.
		Secession under Jeroboam I.
3203	970	Apostasy of Rehoboam.
3204	969	Invasion of Judah by Shishak.
*3217	966	Accession of Adijah over Judah.
3220	953	Accession of Aza over Judah.
3222	951	Accession of Nadab over Israel.
3223	950	Accession of Baasha over Israel.
*3226	947	Birth of Jehoshaphat.
3234	939	Invasion of Judah by Terah.
3245	928	International War.
3246	927	Accession of Elah over Israel.
		Accession of Zimri over Israel.
		Secession under Omri of Israel.
		Accession of Tibni over Israel.
*3250	923	Birth of Jehoram II.
		Death of Tibni.
*3256	917	Appointment of Ahab as Viceroy.
3258	915	Accession of Ahab over Israel.
		Gout of Aza.
3261	912	Accession of Jehoshaphat over Judah.
*3267	906	Birth of Ahaziah II.
3277	896	Appointment of Jehoram II. as Viceroy.
3278	895	Accession of Ahaziah I. over Israel.
3279	894	Accession of Jehoram I. over Israel.
3283	890	Second Appointment of Jehoram II. as Viceroy.
*3286	887	Accession of Jehoram II. over Judah.
3289	884	Birth of Jehoash I.
		Accession of Ahaziah II. over Judah.
*3290	883	Accession of Jehu over Israel.
		Usurpation of Athaliah over Judah.
3296	877	Accession of Jehoash I. over Judah.
*3311	862	Birth of Amaziah.
*3318	855	Accession of Jehoahaz I. over Israel.
3335	838	Accession of Jehoash II. over Israel.
3336	837	Accession of Amaziah over Judah.
*3338	835	Appointment of Jeroboam II. as Viceroy
*3349	824	Birth of Uzziah.
*3350	823	Accession of Jeroboam II. over Israel.
3366	808	Accession of Uzziah over Judah.
*3367	806	Birth of Jotham.
*3391	763	Death of Jeroboam II., followed by an Interregnum in Israel.
		Earthquake and Leprosy of Uzziah.
		Appointment of Jotham as Viceroy.
*3397	776	Birth of Ahaz.
3408	770	Accession of Zechariah over Israel.
		Accession of Shallum over Israel.
3404	769	Accession of Menahem over Israel.
*3414	759	Accession of Pekahiah over Israel.
*3416	757	Accession of Pekah over Israel.
*3417	756	Accession of Jotham over Judah.
		Appointment of Ahaz as Viceroy.
*3422	751	Birth of Hezekiah.
3431	742	Subjugation of the Ammonites by Jotham.
3433	740	Accession of Ahaz over Judah.
*3436	737	Death of Pekah, followed by an Interregnum in Israel.
*3444	739	Accession of Hoshea over Israel.
3445	728	Subjection of Hoshea by Shalmaneser.
3447	726	Accession of Hezekiah over Judah.
		First Revolt of Hoshea from Assyria.
3448	725	Imprisonment of Hoshea by the Assyrians.
3449	724	Second Revolt of Hoshea from Assyria.
3450	723	Siege of Samaria by Shalmaneser.
3453	720	Assyrian Captivity.
3455	715	Capture of Ashdod by Sargon.
3460	713	Invasion of Judah by Sennacherib.
		Diversion of the Assyrians by Tirhakah.
3461	712	Dismemberment of Sennacherib.
		Sickness of Hezekiah.
3462	711	Ambassadors of Merodach-Baladan to Hezekiah.
*3464	709	Birth of Manasseh.
*3476	697	Accession of Manasseh over Judah.
*3509	664	Birth of Amon.
*3525	643	Birth of Josiah.
*3531	642	Accession of Amon over Judah.
*3535	640	Accession of Josiah over Judah.
*3539	634	Birth of Jehoiakim.

A.M.	B.C.	
*3540	638	Conversion of Josiah.
*3541	638	Birth of Jehoshaph II.
3545	625	Reformation by Josiah.
3550	623	Repairs of the Temple by Josiah.
*3554	619	Birth of Zedekiah.
*3557	616	Birth of Jehoiachin.
3564	609	Slaughter of Josiah by Pharaoh-Necho. Accession of Jehoshaph II. over Judah. Accession of Jehoiachin over Judah.
3567	606	Invasion of Judah by Nebuchadnezzar as Viceroy. Deportation of Daniel.
3570	603	Dream of Nebuchadnezzar interpreted by Daniel.
3575	598	Accession of Jehoiachin over Judah. First general Deportation by the Babylonians. Accession of Zedekiah over Judah.
3584	589	Siege of Jerusalem by the Babylonians.
3585	588	Destruction of Jerusalem by the Babylonians. Second general Deportation by the Babylonians.
3591	582	Third general Deportation by the Babylonians.
3591B	581	Release of Jehoiachin by Evil-Merodach.
3593	583	Capture of Babylon by "Darius the Mede."
3597	536	Decree of Cyrus for the Return of the Jews. Return under Zerubbabel.
3598	535	Foundation of the Second Temple.
3599	530	Renewal of Building the Second Temple.
3656	517	Completion of the Second Temple.
3690	453	Divorce of Vashti.
3694	479	Marriage of Esther.
3699	474	Plots of Haman against the Jews.
3700	473	Deliverance by Esther.
3714	459	Second Decree for the Jews' Return. Beginning of Daniel's 70 Weeks. Arrival of Ezra at Jerusalem.
3715	458	Divorce by the Jews of their Gentile Wives.
3726	447	Information to Nehemiah of Jerusalem's State.
3727	447	Visit of Nehemiah to Jerusalem.
3733	438	Return of Nehemiah to Persia.
3763	410	Reformation at Jerusalem resumed by Nehemiah.
3767	406	Close of the O.-T. Canon.

B.C.	
339	Samaritan Temple built on Mt. Gerizim.
390	Ptolemy I. (Lag) conquers Palestine.
391	Onias I. Jewish High-priest.
394	Antigonus seizes upon Palestine.
399	Simon (the Just) Jewish High-priest.
401	Ptolemy (Lag) again reduces Palestine.
403	Eleazar Jewish High-priest.
464	Palestine the Scene of War between Egypt and Syria.
480	Mannasseh Jewish High-priest.
494	Onias II. Jewish High-priest.
519	Simon II. Jewish High-priest.
518	Antiochus the Great seizes the most of Palestine.
517	Palestine again reverts to Egypt.
502	Antiochus retakes Palestine.
199	The Egyptians once more occupy Palestine.
198	Onias III. Jewish High-priest.
196	Antiochus again seizes Palestine.
173	Palestine finally ceded to Egypt.
176	Palestine once more a Syrian Province. Heliodorus attempts to plunder the Jewish Temple.
175	Jason purchases the Jewish High-priesthood.
173	Jewish High-priesthood conferred on Menelaus (Onias).
170	Antiochus Epiphanes plunders the Jewish Temple.
167	The Syrian General Apollonius besieges Jerusalem and supplants the Worship of Jehovah, but is at length resisted by Mattathias.
166	Judas Maccabæus routs the Syrians.
164	Jewish Temple Services renewed, 25th Kislev.
163	Antiochus acknowledges the Jews' Independence.
161	Alicimus reinstated as Jewish High-priest.
159	Judas Maccabæus succeeded by Jonathan.
159	Jonathan nominated as Jewish High-priest.
147	Jonathan takes the Field against Demetrius.
145	Jonathan goes over to Demetrius.
144	Jonathan declares for Antiochus.
143	Jonathan succeeded by Simon Maccabæus.
149	The Jews freed from Foreign Tribute.
141	Simon gets Possession of the Citadel of Jerusalem.
130	Simon becomes Hereditary Prince of the Jews.
128	War between Simon and Antiochus Sidetes.
126	Simon succeeded by John Hyrcanus as Jewish Prince and High-priest.
63	Jerusalem taken by Pompey.
40	Herod (the Great) appointed King by the Romans.
37	Herod takes Jerusalem by Storm.
36	Ananel (a Babylonian) Jewish High-priest.
33	Jesus and Simon successively Jewish High-priests.
31	Herod begins the Reconstruction of the Temple.
6	Births of John (the Baptist) and of Christus.
5	Matthias Jewish High-priest.
4	Death of Herod the Great.
3	Jonas, Eleazar, and Joshua successively Jewish High-priests.

A.D.

- 1 Beginning of the Vulgar Christian Æra.
- 6 Archelaus banished to Gaul.
- 6 Coponius Procurator of Judæa.

A.D.

- 7 Joazar (son of Boëthus) Jewish High-priest.
Christ's Visit with his Parents to Jerusalem.
- 9 M. Ambivivus Procurator of Judæa.
- 11 Tiberius made Associate Emperor.
- 12 Annus Rufus Procurator of Judæa.
Ananus Jewish High-priest.
- 14 Tiberius succeeds Augustus as sole Emperor.
- 15 Valerius Gratus Procurator of Judæa.
- 21 Ishmael (son of Phabi) Jewish High-priest.
- 22 Eleazar (son of Ananus) Jewish High-priest.
- 23 Simon (son of Camithus), and next (Joseph) Calaphas Jewish High-priest.
- 25 Christ baptized by John.
- 26 Pontius Pilate Procurator of Judæa.
- 28 John the Baptist beheaded.
- 29 Crucifixion of Christ.
- Martyrdom of Stephen.
- 30 Conversion of Paul.
- 32 Conversion of Cornelius.
- 36 Pilate succeeded by Marcellus as Procurator.
- Jonathan (son of Ananus) Jewish High-priest.
- 37 Caligula Roman Emperor.
Theophilus (brother of Jonathan) Jewish High-priest.
- 39 Herod Antipas banished to Gaul.
- 40 Claudius Roman Emperor.
- 41 Herod Agrippa I. Ruler of Palestine.
- 42 Simon Cantheras Jewish High-priest.
- 43 Matthias (son of Ananus) Jewish High-priest.
- 44 Elionas (son of Cantheras) Jewish High-priest.
Martyrdom of James.
Death of Herod Agrippa I.
- 45 Cuspius Fadus Procurator of Judæa.
- 47 Tiberius Alexander Procurator of Judæa.
- 48 Joseph (son of Kaml) succeeded in the Jewish High-priest-hood by Ananias (son of Nebedæus).
- 49 Ventidius Cumanus Procurator of Judæa.
- 53 Felix Procurator of Judæa.
Herod Agrippa II. "King" of Trachonitis, etc.
- 54 Nero Roman Emperor.
- 55 Porcius Festus Procurator of Judæa.
- Ishmael (son of Fabb) Jewish High-priest.
- 56 Paul's First Arrival in Rome.
- 62 Martyrdom of James (the Less).
Albinus Procurator of Judæa.
Joseph Kabi Jewish High-priest.
- 64 Martyrdom of Paul.
- 65 Gessius Florus Procurator of Judæa.
- 66 Breaking out of the final Jewish War.
Cestius Gallus besieges Jerusalem.
- 67 Vespasian General of the Roman Forces in Judæa.
Theophilus succeeded by Phannius as Jewish High-priest.
- 68 Galba Roman Emperor.
Simon (son of Gloras) ravages Judæa.
- 69 Otho, Vitellius, and Vespasian successively Roman emperors.
Three Jewish Parties in Jerusalem.
- 70 Titus destroys Jerusalem.
- 71 Bassus sent to take charge of Judæa.
- 73 Fulvius Byva sent as Roman General into Judæa.
- 79 Titus Roman Emperor.
- 81 Domitian Roman Emperor.
- 96 Banishment of the Apostle John to Patmos.
Nerva Roman Emperor.
- 98 Trajan Roman Emperor.
- 100 Close of the N.-T. Canon.

VI. *Controversies and Literature.*—The distance of the Creation from the Christian era, which has been stated with about 140 variations, is given in the Indian Chronology, as computed by Gentil, at 6174 years; in the Babylonian, by Bailly, at 6158; in the Chinese, by Bailly, at 6157; in the Septuagint, by Abulfargius, at 5508; while Jewish writers bring it down below the computation of Capellus, namely, 4000, and one, Rabbi Lipman, to so contracted a sum as 3616.

1. The chronology of the English Bible was regulated by the views of Usher (*Annales Vet. et Nov. Test.* first ed. fol. Lond. 1650, 1654), who followed, in general, the authority of the Hebrew text. Other chronologers have put themselves under the guidance of the Septuagint and Josephus, maintaining that the modern Hebrew text has been greatly vitiated in the whole department of chronology, and more especially in the genealogical tables which respect the antediluvian patriarchs, as well as the ten generations immediately after the Flood. The examination above does not sustain this conclusion. Yet the shortened scheme, adopted by Usher from the Masoretic Jews, is recent in its prevalence among Christians when compared with the more comprehensive chronology of the Septuagint.

This last was used before the advent of our Lord, and, being followed by the Greek fathers of the Church, was generally current, till, in the eighth century, a disposition to exchange it for the Rabbinical method of reckoning was first manifested by the venerable Bede. Roman Catholic authors, however, have usually adopted the latter, from the influence of the Latin Vulgate, which strictly follows the Hebrew numbers. Isaac Vossius, in his treatise *De Vera Ætate Mundi* (Hag. 1659, 4to), was the first of any note who forsook the Hebrew dates. Pezron, in his work *L'Antiquité des Temps rétablie et défendue contre les Juifs et les nouveaux Chronologistes* (Amst. 1687, 12mo), produced a great impression in favor of the lengthened period advocated by Vossius. It was not, however, till the middle of the last century that Jackson produced his great work, the *Chronological Antiquities* (Lond. 1752, 8 vols. 4to). He advocated the longer chronology of the Septuagint. In the beginning of the present century Dr. Hales published the first volume of a laborious work entitled *A New Analysis of Chronology*, an undertaking which ultimately extended to four volumes, chiefly in confirmation and illustration of the conclusions of Jackson. Mr. Faber, in his work on pagan idolatry, offers some judicious observations on the chronology of ancient history, treading generally in the footsteps of Hales. The *Origines* of Sir William Drummond proceeds also on the ground supplied by the Septuagint chronology. A detailed statement of grounds for admitting the authority of the Septuagint in preference to that of the original Hebrew may be found in a preliminary dissertation prefixed to the first volume of Dr. Michael Russell's *Connection of Sacred and Profane History, from the Death of Joshua to the Decline of the Kingdoms of Israel and Judah* (Lond. 1827, 8 vols. 8vo).

2. Upon the data we have considered above, three principal systems of Biblical Chronology have been founded, which may be termed the Long System, the Short, and the Rabbinical. All, or almost all, have erred on the side of claiming for their results a greater accuracy than the nature of the evidence upon which they rested rendered possible. Another failing of these chronologers is a tendency to accept, through a kind of false analogy, long or short numbers and computations for intervals, rather according as they have adopted the long or the short reckoning of the patriarchal genealogies than on a consideration of special evidence. It is as though they were resolved to make the sum as great or as small as possible. The Rabbinical have in their chronology afforded the strongest example of this error, having so shortened the intervals as even egregiously to throw out the dates of the time of the Persian rule. The German school is here an exception, for it has generally fallen into an opposite extreme, and required a far greater time than any derivable from the Biblical numbers for the earlier ages, while taking the Rabbinical date of the Exodus, and so has put two portions of its chronology in violent contrast. We do not lay much stress upon the opinions of the early Christian writers, or even Josephus; their method was uncritical, and they accepted the numbers best known to them without any feeling of doubt.

The chief advocates of the Long Chronology are Jackson, Hales, and Des Vignoles. They take the Sept. for the patriarchal generations, and adopt the long interval from the Exodus to the Foundation of Solomon's Temple. The Short Chronology has had a multitude of illustrious supporters, owing to its having been from Jerome's time the recognised system of the West. Usher may be considered as its most able advocate. He follows the Hebrew in the patriarchal generations, and takes the 480 years from the Exodus to the Foundation of Solomon's Temple. The Rabbinical Chronology has lately come into much notice from its partial reception, chiefly by the German

school. It accepts the Biblical numbers, but makes the most arbitrary corrections. For the date of the Exodus it has virtually been accepted by Bunsen, Lepsius, and Lord A. Hervey. The system of Bunsen we may regard as constituting a fourth class of itself, based upon theories not only independent of, but repugnant to the Bible. For the time before the Exodus he discards all Biblical chronological data, and reasons altogether, as it appears to us, on philological considerations.

	Peta- vis.	Usher.	Hales.	Jack- son.	Bunsen.
Creation of Adam....	B.C. 8983	4004	5411	5426	cir. 20,000
Flood	2327	2348	3185	3170	cir. 10,000
Abram leaves Haran .	1861	1921	2078	2023	
Exodus	1581	1491	1648	1593	1920
Foundation of Temple	1012	1012	1027	1014	1064
Destruction of Temple	539	588	586	586	686

In the post-diluvian period Hales rejects the Second Cainan, and reckons Terah's age at Abram's birth 130 instead of 70 years; Jackson accepts the Second Cainan, and does not make any change in the second case; Usher and Petavius follow the Heb., but the former alters the generation of Terah, while the latter does not. Bunsen requires "for the Noachian period about ten millenia before our æra, and for the beginning of our race another ten thousand years, or very little more" (*Outlines*, ii, 12). These conclusions necessitate the abandonment of all belief in the historical character of the Biblical account of the times before Abraham. The writer does indeed speak of "facts and traditions;" his facts, however, as far as we can perceive, are the results of a theory of language, and tradition is, from its nature, no guide in chronology. It is, however, certain that no Semitic scholar has accepted Bunsen's theory. For the time from the Exodus to the Foundation of Solomon's Temple, Usher alone takes the 480 years; the rest adopt longer periods, according to their explanations of the other numbers of this interval; but Bunsen calculates by generations. The period of the kings, from the foundation of Solomon's Temple, is very nearly the same in the computations of Jackson, Usher, and Petavius: Hales lengthens it by supposing an interregnum of 11 years after the death of Amaziah; Bunsen shortens it by reducing the reign of Manasseh from 55 to 45 years. The former theory is improbable and uncritical; the latter is merely the result of a supposed necessity.

3. The best authorities on chronology in general are Ideler's thorough *Handbuch d. math. u. technisch. Chronologie* (Berl. 1825, 2 vols.) and *Handbuch d. Chronol.* (Berl. 1831). The methods and results of these works most pertinent to Biblical chronology are also pursued in the first part of Browne's excellent *Ordo Saeculorum* (Lond. 1844). Comp. Matzka, *Chronol. in all. s. Epochen* (Wien, 1844). Jarvis's *Intro. to the History of the Church* (N. Y. and Lond. 1845), is a fundamental investigation of ancient æras with reference to the Christian, and is remarkable for the evidence there given of an error in the Roman annals between B.C. 45 and A.D. 160, in consequence of which the author carries every event between these points one year farther back. A synopsis of the argument is given in Strong's *Harm. and Expos. of the Gospels* (N. Y. 1852), Appendix I.

One of the earliest Christian systematic chronologies is the *Pentabiblion* of Julius Africanus (in the 3d cent.), of which only a few fragments remain. Another is the *Chronicon* of Eusebius (4th cent.), of the Latin translation of which by Jerome an edition with notes was published by Scaliger in 1658; and the Armenian version has since been discovered and published, with a Latin translation, at Venice, 1818. There is also a famous Spanish commentary upon this chronicle by Alfonso Postato (Salamanca, 1506, 5 vols. fol.). The *Chronicon Paschale* (ed. Dufresne, Par. 1689, fol., and by Dindorf, Bonn, 1832) is a Byzantine work ar-

ranged upon the basis of the Easter festival. There is also the Jewish *Chronicon mundi majus et minus*, or *Seder Olam* (סדר עולם), in Hebrew, Amsterd. 1711, 4to; in Latin, with a commentary, by J. Meyer, Amsterd. 1649, 4to), the former part of which is reputed to have been composed about A.D. 180, while the latter is of more recent date.

The foundation of the modern science of chronology may be said to have been laid by J. Scaliger, in his work *De Emendatione Temporum* (Par. 1583, fol.; enlarged, Leyd. 1598; also Geneva, 1629). Another important work of that age is that of D. Petavius (or Petau), *De Doctrina Temporum* (Par. 1627, 2 vols. fol.), with its continuation, *Uranologion* (Par. 1630, fol.), and the abridgment, *Rationarium Temporum* (Par. 1630, 8vo, and since). Other important treatises bearing more or less directly on Biblical chronology, besides those mentioned above, are: Calvisii *Opus Chronologicum* (Lips. 1605, and since); Riccioli, *Chronologia Reformata* (Bon. 1669); Florentini, *De anno primitivo* (Aug. Vind. 1621); Labbii et Briettii *Chronologia historica* (Par. 1670); Des Vignoles, *Chronologie de l'Histoire Sainte* (Berl. 1788, 2 vols. 4to); Marsham, *Canon Chronicus* (Lond. 1672; Lpz. 1676; Frctf. 1696); Newton, *Chronology* (Lond. 1728); Blair, *Chronology and History* (London, 1754, 1768); Kennedy, *Astronom. Chronology* (London, 1672); Playfair, *System of Chronol.* (Edinb. 1784); Clinton, *Fasti Hellenici* (Oxf. 1824-30); Clemencet, *L'Art de vérifier les dates* (Par. 1818). More specific are: Vitringa, *Hypotyposis hist. et chronologica* (Havn. 1774); Bengel, *Ordo temporum* (2d ed. Stuttg. 1770); Bennigsen, *Bibliche Chronologie* (Lpz. 1784); Frank, *Nov. syst. chronologiae* (Gött. 1788; abridgm. Dess. 1788); Tiele, *Chronol. d. alt. Test.* (Brem. 1839); Archinard, *Chronol. sacrae* (Par. 1841); Seyffarth, *Chronol. sacra* (Lpz. 1846); Akers, *Biblical Chronology* (Cincin. 1855); Anon. *Palmoms* (Lond. 1851); also Capellus, *Chronologia Sacra* (Par. 1655); Allen, *Chain of Script. Chronol.* (Lond. 1659); Bedford, *Script. Chronology* (Lond. 1780); Cunningham, *Chronology*, etc. (Lond. 1834 sq.); Bosanquet, *Chronology of Dan.* (Lond. 1848); also *Assyr. and Heb. Chronology compared* (in the *Jour. Royal As. Soc.*, Lond. 1864, p. 148 sq.); Fausset, *Sacred Chronology* (Oxf. 1855); with many others of less extent. Compare also Pridaux, *Old and New Testament Connected*; Shuckford, *Sacred and Profane History of the World Connected*; *Mémoires de l'Académie des Inscriptions et Belles-Lettres*; Michaelis, *Zeitrechnung von der Sündfluth bis Salomo* (in the *Götting. Mag. der Wissensch.* 1 Jahrg.); Gesenius, *De Pentateuchi Samarit. Origine* (Hal. 1815); Hegewisch, *Einkl. in die hist. Chron.* (Alt. 1811); Beer's *Abhandlungen zur Erläut. d. alten Zeitrechn.* (Leipz. 1752); Silberschlag, *Chronologie der Welt* (Berl. 1783); Parker, *Chronology* (Lond. 1869); Röckerath, *Bibliche Chronologie* (Münst. 1865); Lewin, *Fasti Sacri* (Lond. 1865); Shimeall, *Bible Chronology* (N. Y. 1860); Von Gumpach, *Altjüd. Kalendar* (Brüss. 1848), and *Zeitrechn. d. Bab. u. Assyr.* (Heidelb. 1852). See VULGAR ÆRA.

CHRONOLOGY, CHRISTIAN.—The first Christians, in their civil relations, used the civil chronology of the countries they lived in. The ecclesiastical chronology of the early Church was limited to the use of the Jewish week, which began with a work-day and closed with the Sabbath, and in which the several days were not named, but counted. Gradually the day of rest was changed from the last day of the week to the first, and the other days of the week came to have a special ecclesiastical name. Both these changes proceeded from the commemoration of the day of the suffering and the resurrection of Jesus Christ—Sunday being the day of the resurrection, Friday the day of the crucifixion, and Wednesday the day of the trial. The two latter, as days of mourning and fasting, are mentioned by Tertullian (*de jejun.* c. 2) and by Clement of Alexandria (*Strom.* vii, 12, § 75); but they are prob-

ably of an earlier origin, for the name *statio* (*στάσις*), by which they were generally designated at the time of Tertullian, occurs in the *Pastor Herma* (lib. 3, simil. 5). Sunday, as a day of rejoicing, is first mentioned in the Epistle of Barnabas (chap. xv), and its celebration seems to reach back to the apostolic age. These three prominent days were called in the Latin Church, *feria quarta, feria sexta* or *parasceve*, and *dies dominicus* or *dominica*, and by the Greeks *τρίτη, παρασκευή, ἡμέρα κυριακή* (also abbreviated *κυριακή* or *κυρία*), or *ἀναστasiaτικὴ ἡμέρα*. The oldest witnesses for the names of the station-days are again Tertullian and Clement. The former is also the first to mention the name of *dominica*, while *κυριακή* is first found in the epistles of Ignatius (*ad Magnes.*). The other week-days were designated by the Latins with the same name as the station-days (*feria*), and counted from *feria secunda* to *feria sexta* or *parasceve*, while the Greeks counted from *ἡμέρα δευτέρα* to *ἔκρη* or *παρασκευή*. The last day retained its Jewish name *sabbatum*, and *σάββαρον* or *σάββατα*. The planetary appellation of days which emanated from the pagan astronomers in Alexandria (see Ideler, *Handbuch der mathem. und techn. Chronologie*, Berlin, 1825) is first mentioned by Tertullian, who mentions the *dies solis* (Sunday) and *dies Saturni* (Saturday); by Justin Martyr, who mentions *τοῦ ἡλίου ἡμέρα* (Sunday) and *ρομυκή* (Saturday); and by Clement of Alexandria, who mentions Ἐρμῆ (Wednesday), and Ἀφροδίτης (Friday) ἡμέρα. Still another way of designating the week-days is found in the Easter Canon of Hippolytus, which marks the days of the week (beginning with Sunday) by the first letters of the alphabet, A to G.

Among the weeks of the year, the one including the anniversaries of the death and the resurrection of Christ came early to be celebrated with special solemnity. The time on which the former of these anniversaries should be commemorated even became the occasion of one of the greatest ecclesiastical controversies of the ancient Church, one party, which claimed to follow the example of the apostles John, Philip, and Paul, insisting that it should be celebrated on the anniversary day of the month (the full moon's day of the Jewish month of Nisan), and the other party, which appealed to the other apostles as their authorities, urging the celebration on the anniversary day of the week (Friday). The Church of Rome followed the latter, and the churches of Asia Minor the former practice. Both customs required either a compliance with the Jewish Calendar or a special calculation of the Christian Easter. Of the latter class, the most ancient known to us is one found on the marble statue of Hippolytus, and computed to the first year of the emperor Alexander Severus (A.D. 222). It fixes the 18th of March as the time of the equinox, is arranged according to the sixteen years' cycle, and determines the Easter Sundays according to the Latin rule, that, whenever the Easter Sundays fall upon Saturdays, Easter is to be celebrated, not upon the next, but upon the second next Sunday. In the Eastern churches special calculations were made by Dionysius of Alexandria, Anatolius of Laodicea, and others. Gradually the Alexandrine Easter Canon, the authority of which is ascribed by Jerome and Bede to Eusebius, dislodged all others, and obtained general usage in the Church. It appointed for the celebration of Easter the Sunday following the day of the full moon which falls on or comes next after the equinox. The bishops, by paschal letters, informed the churches of the proper time of Easter in every year. A third, which is mentioned by Tertullian, tried to fix the 14th day of the month of Nisan, in the death-year of Christ (the 25th of March), as the immovable anniversary of the death, and the 16th day of Nisan as the anniversary of the resurrection of Christ. See EASTER.

Constantine the Great, in 821, ordered a civil observance of Sunday by prohibiting all secular business,

and transferred the pagan *Nundina* of the old Romans to Sunday. A Roman Calendar, compiled in the middle of the fourth century, divides the whole year, from the 1st of January, according to *Nundina* and weeks, by placing in parallel columns the eight Nundinal letters A-H, and the seven week letters A-G. The entire suppression of the *Nundina* is thought to have been effected by the Sunday laws of Theodosius the Great.

But while the week supplanted the *Nundina*, the Christian appellation of the week-days gave way gradually, at least in the Western countries, to the pagan planetary names. The change was, however, not effected without considerable resistance. Philastrius (about 387) counts the use of the planetary names for week-days among the heresies. Ambrose and Gregory of Tours (died 594) censure the use of the name Sunday (*dies solis*). A bishop of Iceland, in 1107, suppressed the planetary names and substituted for them numbers. The Spaniard Campanella made an attempt to introduce, in the place of pagan names of the week-days, the names of the seven sacraments, and in place of the usual names of months those of the twelve apostles. In the Eastern churches the planetary names never came into general use. The Slavi, Lithuanians, and Finns count the days of the week, calling Monday the first day (after the Sabbath).

The months of the Christians (except among the Copts and Abyssinians, who still use the old Alexandrine months) are still those of the Julian Calendar. The names of the Roman months have also in most Christian countries come into general use. In the Byzantine empire, the Syro-Macedonian names of the months maintained themselves by the side of the Roman until late in the Middle Ages, and among the Germanic and Slavic nations efforts were made to introduce native names, but the Roman names always prevailed. The Armenian, Syrian, Coptic, and Abyssinian Christians still use the national names of months exclusively. The "Society of Friends" (Quakers) reject both the planetary names of days and the Roman names of months, and simply count both (as "first day," instead of Sunday, and "first month," instead of January).

With the names of the Roman months also the Roman way of dating was extensively used. In the Latin Church it remained in use until the establishment of the modern languages (in Germany until the 14th century). Isolated instances of the present way of counting the days are found in a fragment of a Gothic Calendar in the 4th century; in an Anglo-Saxon Calendar of the 10th century; in the works of Pope Gregory the Great (594-604), and elsewhere. The designation of the days of the months by the names of saints came into use early in the Middle Ages. In the Byzantine Church the Roman way of dating seems to have been supplanted in the 7th century by the present way of counting the days. In Asia, the Roman way of dating was used only by way of comparison with the national method.

The beginning of the year in the Christian countries has remained, as it was fixed in the Julian Calendar, on the 1st of January. Dionysius Exiguus, in order to give the beginning of the year a Christian character, called it the "day of circumcision" (*dies circumcisionis*). Several attempts were made to substitute for the 1st of January another beginning of the year, relating to some prominent event in the history of Christianity. Thus several popes began to use for that purpose the first day of March, probably on the ground that March was the usual month of the Passover, and Venice used in its public documents this day until the downfall of the republic. Another Roman new-year's day was the 25th of March (the festival of the Annunciation), and this was used in Pisa and Florence until 1749. But the most common was Christmas (*a Nativitate Domini*), which was even call-

ed *mos*, or *stilus curia Romanae*. It was not until Pope Innocent XII (1691) that this habit was altogether abandoned. In Germany, the calendarium of Charlemagne has the 1st of January; the 25th of March was in frequent use until the 11th century, when it gave way to Christmas, which maintained itself until the peace of Westphalia. France, under the Merovingians, used the 1st of March; under the Carolingians, Christmas; under the Capetings, until the 16th century, Easter; the latter was also for a long time in use in Holland and in Cologne. Spain and Portugal long used the 25th of March, and from the 14th to the 16th century, Christmas. The Anglo-Saxons, according to Bede, began the year on Christmas; but gradually three different years were distinguished—the historical, legal or civil, and ecclesiastical. The beginning of the first has long been on the 1st of January; that of the second was the 25th of December until the 13th century, after that the 25th of March until 1752, when it was fixed at the 1st of January. In the Byzantine empire the 1st of January was in the 5th century supplanted by the 1st of September (the epoch of the Indictions), which the Russians abandoned for the 1st of January in 1700, and the kingdom of Greece in 1821. The Chaldeans have adopted the 1st of September, while the Nestorians and Jacobites stick to the 1st of Tishri. The Copts and Abyssinians still adhere to the 1st of Thoth.

Of a special church year there are no traces until the time of Constantine the Great. Its beginning seems at first to have been made with the sun-month corresponding to the Jewish Nisan. Thus the Apostolic Constitutions designate December as the ninth, January as the tenth, and "Xanthicus" (which is usually identified with Nisan) as the first month. Epiphanius follows the same calculation; and Victorius, Dionysius, and Beda speak of the Easter month as the first. The epoch of the first Sunday of Advent originated with the Nestorians, and is first found in the *Responsoriale* of Gregory the Great, but seems to have been general in the Latin churches as early as the 7th century. The Greek Church has retained the 1st of September as the beginning of the church year. See Herzog, *Real-Encyclopädie* s. v. *Zeitrechnung* (which we have chiefly followed in the above article). See also *ÆRA*; *CHURCH-YEAR*; *CYCLE*.

Chrysaργύριον (*χρυσάργυρον*), a tax on trade and commerce under the later Roman emperors, so called because paid in gold and silver; and also *tributum iustrale*, because paid once in every five years (*istrum*). Even the poorest tradesmen were not exempt from it; and it was called an intolerable tax (*φόρος ἀφόρητος*, Libanius, *Oraz.* 14, cont. Florent.). Yet Constantius freed the lower clergy, who gained their bread by trade or labor, from this tax; and later emperors confirmed the exemption.—Bingham, *Orig. Ecles.* bk. v, ch. iii, § 6.

Chrys'olite (*χρυσόλιθος*, *golden stone*), the precious stone which garnished the seventh foundation of the New Jerusalem in John's vision (*Rev.* xxi, 20); according to Schleusner, a gem of golden hue, or, rather, of yellow streaked with green and white (see *Plin.* xxxvii, 9, 42; *Isidor. Orig.* xvi, 14). It was called by some *chrysophyllum* (*χρυσόφυλλον*, Epiphanius, *De geminis*, x). It was a name applied by the ancients to all gems of a golden or yellow color, but it probably designated particularly the *topas* of the moderns (see, however, Bellermann, *Urim et Thummim*, p. 62). In the Sept. the word is employed for שֵׁשׁ־בֵּרִיל, *tsrahikil*, the "beryl" of our version (*Exod.* xxviii, 20; *Ezek.* x, 9). See *BERYL*; *TOPAZ*.

What is usually termed chrysolite is a crystalline precious stone of the quartz kind, of a glossy fracture. In chemical composition it is a ferriiferous *silicate of magnesia*. The prevailing color is yellowish-green, and pistachio-green of every variety and degree of

shade, but always with a yellow and gold lustre. There are two particular species of chrysolite: one, called the Oriental chrysolite, of a pistachio-green, transparent, and, when held up to the light in certain positions, often with a cherry-red shade; the other is the granulous chrysolite, of different shades of yellowish-green color, half transparent and nearly pellucid (see the *Penny Cyclopædia*, s. v.). See GEM.

Chrysológus, **Petrus**, archbishop of Ravenna, was born at Imola about 400, and was consecrated archbishop about 438. He was noted for strictness of discipline, and especially for eloquence, from which his surname was derived. Eutyches sought to gain the eloquence and reputation of Chrysológus for his party, but the latter not only repelled him, but strenuously opposed his doctrine. He died at Imola, according to one account, Dec. 2, 450; according to another, in 458. A number of *Sermons* (176) are preserved, of which the first edition, by Vincentius, appeared in 1584; another at Venice, 1750, fol. One of the best editions is *Sermones, editio omnium certè castigatissima* (Aug. Vind. 1758, fol.). These and the few letters of his that remain are collected in a complete edition in Migne's *Patrologia* (1846, imp. 8vo).—Migne, *Dict. de Biographie*, iii, 425.

Chrysoprasus (*χρυσόπρασος*, mentioned in Rev. xxi, 20, as the tenth row of stones in the foundation of the heavenly Jerusalem), a precious stone of greenish-golden color, or apple-green, passing into a grass-green (Pliny, *Hist. Nat.* xxvii, 20, 21); an Indian translucent gem, so called as resembling in color the juice of the leek (*πράσον*), with golden spots (*χρυσός*)—a species of beryl, supposed to be possessed of healing power in diseases of the eyes. Its spotted character may be inferred from the name given to it by Pliny (*Hist. Nat.* xxxvii, c. 3), *pardaisos*, or, rather, *pantherion*, from its resembling the leopard-skin (see Braun, *de Vest. Sac. Heb.* ii, c. 9, p. 509). The chrysoprase of the ancients is by some supposed to be identical with the stone now so called, viz. the apple or leek-green variety of agate, or uncrystallized quartz (*London Encyclopædia*, s. v.), which owes its color to oxide of nickel; this stone at present is found only in Silesia; but Mr. King (*Antique Gems*, p. 59, note) says that the true chrysoprase is sometimes found in antique Egyptian jewelry set alternately with bits of lapis-lazuli. See GEM.

In Gen. ii, 12, the Sept. renders the word *כִּינֹז*, *chō'kām*, by chrysoprase (*λίθος ὁ πράσινος*), but they were probably different gems. See BERYL.

Chrysostom, **St.**, born 347 at Antioch, died in exile 407. His proper name was JOHN, but since the seventh century he is better known as CHRYSOSTOM (*Χρυσόστομος*), the golden-mouthed pulpit orator of the Greek Church. Like Gregory of Nazianzen, and Augustine, he had a most excellent Christian mother, Anthusa, who, by her exemplary virtue and piety, commanded even the admiration of the heathen. It was with reference to her that Libanius, the most distinguished rhetorician and literary representative of heathenism at the close of the fourth century, felt constrained to exclaim, "Ah, gods of Greece! what wonderful women there are among the Christians!" Anthusa was married to a prominent military officer at Antioch, but became a widow in her twentieth year, and continued in that state, devoting herself exclusively to religion and the education of her children. She planted the seeds of early piety in the soul of Chrysostom, although, like Gregory Nazianzen, Augustine, and other sons of Christian mothers, he was not baptized till mature age. She gave him, at the same time, the benefit of the best intellectual culture of the age in the school of Libanius, who esteemed him his best scholar, and desired him to become his successor as professor of rhetoric or forensic eloquence. Chrysostom entered the career of a rhetorician, but

shortly after he broke with the world, and resolved to devote himself exclusively to religion. After the usual course of catechetical instruction, he was baptized by bishop Meletius, of Antioch. His first impulse after his conversion was to embrace the monastic life, which, since St. Anthony of Egypt, the patriarch of monks, had set the example, and such men as Athanasius, Basil the Great, the two Gregories, Ambrose, Jerome, and Augustine had given it the sanction of their great authority, carried away many of the noblest and most earnest youths of the Church, as a mode of life best adapted to secure personal holiness and salvation, and to benefit the world by presenting to it, in bold contrast to its perishing vanities, the beauty and power of heroic self-denial and true happiness in the unbroken communion with God. Anthusa, however, defeated his design for a season. She took him by the hand, led him to her room, and by the bed where she had given him birth, she remonstrated with him in tears and tender entreaties not to forsake her. Like an obedient son, he yielded to her wishes; and although he, after her death, spent some time in monastic retreat, and retained ascetic habits even on the patriarchal throne, yet the greater part of his life was devoted to the active service of the Church in some of her most influential positions. He commenced the clerical career as reader in the church of Antioch under Meletius, and would soon have been promoted to a bishopric, but he evaded the election by a sort of pious ruse, and thrust it upon his friend Basilus (not of Cæsarea, but of Raphanea, in Syria), whom he considered worthier, but who bitterly complained of the deception. Chrysostom defended his conduct, and justified the theory of accommodation, or economy (*οἰκονομία*), as he called it, wherever it may be practised from pure motives, and as a means to a good end; unwarrantably appealing to Paul, who became a Jew to the Jews, and a Gentile to the Gentiles. Other fathers (e. g. Jerome) had the same lax views on the duty of veracity, which find no support in the Bible, but were universally entertained among the heathen philosophers, especially the Greek sophists. Even Plato vindicates falsehood, and expressly recommends it to physicians as a help to the healing of the sick, and to rulers for the good of the people (*De Republ.* iii, p. 266). No wonder that even to this day strict veracity is so rare in the Oriental churches. This occurrence was the occasion of Chrysostom's famous treatise on the priesthood (*Περί ἱερωσύνης, De Sacerdotio, libri 8*), which, notwithstanding the serious defect alluded to, is one of the most useful works on the duties and responsibilities of the holy ministry, and has been often separately edited (by Erasmus, Cave, Bengel, etc.) and translated into modern languages (into English by Hollier, 1740; Bunce, 1759; Mason, 1826 (Phila. 12mo); Marsh, 1844, and B. Harris Cowper, 1866).

After the death of his mother Chrysostom fled from the seductions and tumults of city life to the monastic solitude of the mountains near Antioch, and there spent six happy years in the study of the Bible, in sacred meditation and prayer, under the guidance of the learned abbot Diodorus (afterwards bishop of Tarsus, †394), and in communion with such like-minded young men as Theodore of Mopsuestia, the celebrated father of Antiochian (Nestorian) theology (†429). Monasticism was to him a profitable school of experience and self-government; because he embraced this mode of life from the purest motives, and brought into it intellect and cultivation enough to make the seclusion available for moral and spiritual growth. He thus describes the life of his brethren on the mountain solitude near Antioch: "Before the rising of the sun they rise, hale and sober, sing as with one mouth hymns to the praise of God, then bow the knee in prayer under the direction of the abbot, read the Holy Scriptures, and go to their labors; pray again at nine, twelve, and three o'clock; after a good day's work, enjoy a simple meal of bread

and salt, perhaps with oil, and sometimes with pulse; sing a thanksgiving hymn, and lay themselves on their pallets of straw without care, grief, or murmur. When one dies they say, 'He is perfected;' and they all pray God for a like end, that they also may come to the eternal Sabbath-rest and to the vision of Christ."

In this period he composed his earliest writings in praise of monasticism and celibacy, and his two long letters to the fallen Theodore (subsequently bishop of Mopsuestia), who had regretted his monastic vow and resolved to marry. Chrysostom regarded this small affair, from the ascetic stand-point of his age, as almost equal to an apostasy from Christianity, and plied all his oratorical arts of sad sympathy, tender entreaty, bitter reproach, and terrible warning to reclaim his friend to what he thought the surest and safest way to heaven.

By excessive self-mortification Chrysostom undermined his health, and returned about 380 to Antioch. There he was ordained deacon by Meletius (who died in 381), and presbyter by Flavian in 386. By his eloquence and his pure and earnest character he soon acquired great reputation and the love of the whole church. During the sixteen or seventeen years of his labors in Antioch he wrote the greater part of his Homilies and Commentaries, his work on the Priesthood, a consolatory epistle to the despondent Stagirus, and an admonition to a young widow on the glory of widowhood and the duty of continuing in it. He disapproved second marriage, not as sinful or illegal, but as inconsistent with an ideal conception of marriage and a high order of piety.

Chrysostom was chosen, without his own agency, patriarch of Constantinople. At this post he labored several years with happy effect. By talent and culture he was peculiarly fitted to labor in a great metropolis. He happily avoided the temptation of hierarchical pride and worldly conformity. In the midst of the splendors of New Rome he continued his ascetic habits, and applied all his income to the sick and the poor. He preached an earnest, practical Christianity, insisted on church discipline, and boldly attacked the vices of his age, and the hollow, worldly, and hypocritical religion of the imperial court.

But his unsparing sermons aroused the anger of the empress Eudoxia, a young and beautiful woman, who despised her husband and indulged her passions. His rising fame, moreover, excited the envy of the ambitious patriarch, Theophilus of Alexandria, who could not tolerate a successful rival in Constantinople. An act of Christian love toward the persecuted Origenistic monks of Egypt involved him in the Origenistic controversy, which raged at that time with great violence in Egypt and Syria, and at last the united influence of Theophilus and Eudoxia overthrew him. Persecution and suffering were to test his character and to throw around his memory the halo of martyrdom for the cause of purity and charity. Theophilus first sent the aged Epiphanius, so well known for his orthodox zeal and his hatred of the arch-heretic Origen, to Constantinople, as a tool of his hierarchical plans, in the hope that he would destroy the thousand-headed hydra of heresy, and ruin Chrysostom for his apparent connection with it. Chrysostom, as a pupil of the Antiochian school of theology and as a practical divine, had no sympathy with the philosophical speculations and allegorical fancies of Origen, but he knew how to appreciate the merits of this great man, and was prompted by a sense of justice and Christian love to intercede in behalf of the Origenistic monks, whom Theophilus had unmercifully expelled from Egypt, and he showed them kindness when they arrived at Constantinople, although he did not admit them to the holy communion till their innocence should be publicly established. Epiphanius himself found that injustice had been done to those monks, and left Constantinople with the words, "I leave to you the city, the palace, and hypoc-

risy." He died on board the ship on his return to Cyprus (408). Theophilus now proceeded to Constantinople in person, and at once appeared as accuser and judge of Chrysostom. He well knew how to use the dissatisfaction of the clergy, of the empress Eudoxia, and of the court, with Chrysostom, on account of his moral severity and his bold denunciations. In Chrysostom's own diocese, on an estate, "at the oak" (synodus ad quercum), in Chalcedon, he held a secret council of thirty-six bishops against Chrysostom, and there procured, upon false charges of immorality, unchurched conduct, and high treason, his deposition and banishment in 403. Among the twenty-nine charges were these: that Chrysostom called the saint Epiphanius a fool and demon; that he wrote a book full of abuse of the clergy; that he received visits from females without witnesses; that he bathed alone and ate alone.

Chrysostom was recalled, indeed, in three days, in consequence of an earthquake and the dissatisfaction of the people, but was again condemned by a council in 404, and banished from the court, because, incensed by the erection of a silver statue of Eudoxia close to the church of St. Sophia, and by the theatrical performances connected with it, he had, with unwise and unjust exaggeration, opened a sermon, on Mark vi, 17 sq., in commemoration of John the Baptist, with the personal allusion, "Again Herodias rages, again she raves, again she dances, and again she demands the head of John [Chrysostom's own name] upon a charger" (Sozrates, *Hist. Eccl.* vi, c. 18). From his exile in Cucusus and Arabissus he corresponded with all parts of the Christian world, took lively interest in the missions in Persia and Scythia, and appealed to a general council. But even the powerful intercession of pope Innocent I and the sympathy of the people at Constantinople were of no avail against the wrath of the court and the envy of a rival patriarch. The enemies of Chrysostom procured from Arcadius an order for his transportation to the remote desert of Pityus. On the way thither he died at Comana in Pontus, A.D. 407, in the sixtieth year of his age, praising God for everything, even for his unmerited persecutions. His last words were: *Δόξα τῷ Θεῷ πάντων ἑνεκεν*. They express the motto of his life and work.

Chrysostom was venerated by the people as a saint; and thirty years after his death, by order of Theodosius II (438), his bones were brought back in triumph to Constantinople, and deposited in the imperial tomb in the Church of the Apostles. The emperor himself met he remains at Chalcedon, fell down before the coffin, and in the name of his guilty parents, Arcadius and Eudoxia, implored the forgiveness of the holy man. The age could not, indeed, understand and appreciate the bold spirit of Origen, but was still accessible to the narrow piety of Epiphanius and the noble virtues of Chrysostom.

John Chrysostom is the greatest commentator and preacher of the Greek Church, which reveres him above all fathers. He left a spotless name behind him. As a divine, he was eminently sound, moderate, and practical; less profound and original than Athanasius or Augustine, but superior to both as an exegete and sermonizer. He is the best representative of the Antiochian school as distinct from that of Alexandria. He avoided the errors into which his friend Theodore of Mopsuestia, and his successor, the unhappy Nestorius, of the same school, fell soon afterwards. Neander compares him to Spener, the practical reformer of the Lutheran Church in the 17th century. Villemain claims for him "the union of all the oratorical attributes, the natural, the pathetic, and the grand, which have made St. John Chrysostom the greatest orator of the primitive Church, and the most distinguished interpreter of that remarkable epoch." Carl Hase says of him that "he complemented the sober clearness of the Antiochian exegesis and the rhetorical arts of Li-

banish with the depth of his warm Christian heart, and that he carried out in his own life, as far as mortal man can do it, the ideal of the priesthood which, in youthful enthusiasm, he once described" (*Church History*, § 104). Niedner characterizes him thus: "In him we find a most complete mutual interpenetration of theoretical and practical theology, as well as of the dogmatical and ethical elements, exhibited mainly in the fusion of the exegetical and homiletical. Hence his exegesis was guarded against barren philology and dogma, and his pulpit discourse was free from doctrinal abstraction and empty rhetoric. The introduction of the knowledge of Christianity from the sources into the practical life of the people left him little time for the development of special dogmas" (*Geschichte d. chr. Kirche*, 1846, p. 323).

We have from Chrysostom over six hundred homilies, delivered at Antioch and Constantinople, by far the most valuable of his writings. They are consecutive expository sermons on Genesis, the Psalms, and most of the books of the New Testament. They contain his exegesis, and hence are so often quoted by modern commentators, especially the homilies on the Epistles of Paul. Besides them he wrote discourses on special occasions, among which the twenty-one homilies on the Statutes, occasioned by a rebellion at Antioch in 387, are the most celebrated. The other works of Chrysostom are his youthful treatise on the priesthood already alluded to; a number of doctrinal and moral essays in defence of the Christian faith, and in commendation of celibacy and the nobler forms of monastic life; and two hundred and forty-two letters, nearly all written during his exile between 408 and 407. The most important of the letters are two addressed to the Roman bishop Innocent I, with his reply, and seventeen long letters to his friend Olympias, a pious widow and deaconess. They all breathe a noble Christian spirit, not desiring to be recalled from exile, convinced that there is but one misfortune—departure from the path of piety and virtue, and filled with cordial friendship, faithful care for all the interests of the Church, and a calm and cheerful looking forward to the glories of heaven. The so-called *Literary* of Chrysostom, which is still in regular use in the Greek and Russian churches, bears the unmistakable marks of a later age.

Literature.—The best edition of the works of Chrysostom in the original Greek, with a Latin translation, is the Benedictine, prepared by Bernard de Montfaucon, first published in Paris 1718–1788, in 18 fol. vols.; reprinted in Venice 1784–'41; in Paris (Gaugne), 1834–'39; and in Migne's *Patrologia*, 1859–'60. The Homilies have been often translated into French, German, English, and other languages (English translation in the Oxford library of the Fathers, 1842–'53); so also his youthful work on the Priesthood (see above). On the life and character of Chrysostom see especially the *Vita* in vol. xiii of the *Opera*, p. 91–178; Tillemont, *Mémoires*, vol. xi, p. 1–405; Stilling, *Acta Sanctorum* for Sept. 14; Neander, *Der heil. Chrysostomus* (Berlin, 1821, 8d ed. 1848, in 2 vols. (the first volume translated by Stapleton, Lond. 1838); Villemain, *Tableaux de l'éloquence chrétienne au IV^e siècle* (Par. 1849, p. 154–217); Perthes, *Life of Chrysostom* (Boston, 1854, 12mo); Abbé Rochet, *Histoire de St. Jean Chrysostome* (Par. 1866). Comp. also Schaff's *Church History*, 1866, vol. iii, p. 702 sq. and 963 sq. (from which a part of the above sketch has been taken).

Chub [pron. *Cub*] (כּוּב, Heb. *Kub*, deriv. uncertain; Sept. apparently *Λιβυες*, but transposes; Vulg. *Chub*), a word occurring only once as the name of a people in alliance with Egypt in the time of Nebuchadnezzar (Ezek. xxx, 5): "Cush, and Phut, and Lud, and all the mingled people (כּוּבִים), and Chub (Sept. Πέρσαι καὶ Κρήτες καὶ Ἄνδοι καὶ Λιβυες καὶ πάντες οἱ ἐπίμικτοι ἐν αὐτῶν v. r. Λιβυες καὶ Λιβύ-

οιες καὶ Ἄνδοι καὶ πᾶσα ἡ Ἀραβία), and the children of the land of the covenant shall fall by the sword with them" (i. e. no doubt the Egyptians; see ver. 4). The first three of these names or designations are of African peoples, unless (but this is improbable) the Shemite Lud be intended by the third (see, however, xxvii, 10; xxxviii, 5; Isa. lxvi, 19; Jer. xlvi, 9); the fourth is of a people on the Egyptian frontier; and the sixth probably applies to the remnant of the Jews who had fled into Egypt (comp. Dan. xi, 28, 30, 82, especially the last, where the covenant is not qualified as "holy"), which was prophesied to perish for the most part by the sword and otherwise in that country (Jer. xlii, 16, 17, 22; xlii, 12, 18, 14, 27, 28). This fifth name is therefore that of a country or people in alliance with Egypt, and probably of Northern Africa, or of the lands near Egypt to the south. Some have proposed to recognise *Chub* in the names of various African places—*Cobé* (Κοβή), a port on the Indian Ocean (Ptol. iv, 7, § 10); *Chobat* (Χωβάρ or Χωβάρδ), in Mauritania (iv, 2, § 9); and *Cobion* (Κώβιον or Κωβιον), in the Maeroitic nome in Egypt (iv, 5)—conjectures which are of no value except as showing the existence of similar names where we might expect this to have had its place. Bochart strangely regards it as the city *Paferus*, in Marmarica (Strabo, xvii, 838); while Hävernick seeks it in the people called *Kufa* on the Egyptian monuments (Wilkinson, i, 879 sq.). Others, however, think the present Heb. text corrupt in this word. It has been therefore proposed to read *Nub* (כּוּב) for *Nubia*, as the Arab. vers. has "the people the *Noobeh*," whence it might be supposed that at least one copy of the Sept. had derived the first letter (ν for the usual λ); one Heb. MS. indeed reads thus (כּוּב, Cod. 409, ap. de Rossi). The Arab. vers. is, however, of very slight weight, and we have no authority of this kind for applying the word *Nub* (or *Kenub*, its Egyptian pronunciation; see Bunsen, *Egypt. Stell.* ii, 6) to *Nubia*, or rather the *Nuba* (Νουβαί, Strabo, xvii, 786, 819; iv, 7, 80; Plin. vi, 85; Steph. Byz. p. 586), the countries held by whom from Strabo's time to our own are by the Egyptian inscriptions included in Keesh or Keah, that is, Cush; the Nuba, however, may not in the prophet's days have been settled in any part of the territory which has taken from them its name. Another conjecture (regarded as quite equal in probability by Gesenius, *Theos. Heb.* p. 664) is the emendation which Hitzig proposes (*Begriff der Kritik*, p. 129), namely, *Lub* (כּוּב). The *Lubim*, doubtless the Mizraite *Lehabim* of Gen. x, 13; 1 Chron. i, 11, are mentioned as serving with Cushim in the army of Shishak (2 Chron. xii, 2, 3), and in that of Zerah (xvi, 8; comp. xiv, 9), who was most probably also a king of Egypt, and certainly the leader of an Egyptian army. See CUSH; ZERAH. Nahum speaks of them as helpers of Thebes, together with Put (Phut), while Cush and Egypt were her strength (iii, 8, 9); and Daniel mentions the Lubim and Cushim as submitting to or courting a conqueror of Egypt (xi, 48). The Lubim might therefore well occur among the nations suffering in the fall of Egypt. There is, however, this objection, that we have no instance of the supposed form *Lub* in the sing., the noun being always given in the plural—LUBIM (q. v.); hence Hitzig has himself since rejected this view (*Kurzgef. eeg. Hdb. in Esachiei*, in loc.). The suggestion of Hävernick, that the name Chub is to be connected with *Kufa*, which occurs on the Egyptian monuments as that of a people conquered by the Egyptians (Wilkinson, *Anc. Egypt.* i, 867, 871), would be deserving of notice were it not that it involves the somewhat violent proposition that a people, of whom we only know that they were the allies of the Egyptians, should be identified with a people of whom we only know that they were the conquered enemies of the Egyptians; though it is certainly possible that they who were at an early period foes, may at a later period have be-

come allies. Worthy of notice also is the suggestion of Fürst, who says, "It is possible that it is to be connected with *Coba*, the existing name of an Ethiopian port, and which, perhaps, was formerly the name of a district" (*Heb. Handb.* s. v.).—Smith, s. v.; Kitto, s. v.

Chubb, THOMAS, an English Deist, was born at East Harnham, a village near Salisbury, in 1679. His father dying, left his family poor, and Chubb was apprenticed to a glover in 1694. At this trade, and that of tallow-chandler, he supported himself, and at the same time cultivated his uncommon natural ability by diligent study. He died at Salisbury Feb. 8, 1746-7. His first work, which appeared in 1715, was entitled *The Supremacy of the Father asserted* (8vo), and denied the divinity of Christ. It was followed by a series of publications, in which his skepticism was more and more fully developed. Among them are *Inquiries concerning Liberty of Conscience and Sin* (Lond. 1717, 8vo); and a great number of tracts on authority, human nature, miracles, etc. He was largely involved in controversy with Warburton, Stebbing, Fleming, and others. His posthumous tracts were published in 2 vols. 8vo, 1748; and were answered by Fleming, in *True Deism the Basis of Christianity*; or, *Observation on Chubb's posthumous Works*; and by Leland (*View of Deistical Writers*, vol. 1). "Chubb was a working man, endowed with strong native sense, who manifested the same inclination to meddle with the deep subject of religion which afterwards marked the character of Thomas Paine and others, who influenced the lower orders later in the century. In his general view of religion, Chubb denied all particular providence, and, by necessary consequence, the utility of prayer, save for its subjective value as having a reflex benefit on the human heart. He was undecided as to the fact of the existence of a revelation, but seemed to allow its possibility. He examined the three great forms of religion which professed to depend upon a positive revelation, Judaism, Mohammedanism, and Christianity. The claims of the first he wholly rejected, on grounds similar to those explained by Morgan, as incompatible with the moral character of God. In reference to the second he anticipated the modern opinions on Mohammedanism by asserting that its victory was impossible if it had not contained truth which the human spirit needed. In examining the third he attacked, like Morgan, the evidence of miracles and prophecy, and asserted the necessity of moral right and wrong as the ground of the interpretation of Scripture" (Farrar, *Critical History of Free Thought*, p. 142). There is a full account of Chubb, with the opinions of various writers concerning him, in the *Biographia Britannica*, iii, 521-532.

Chun [pron. *Cus*] (Heb. *קֻן*, *qun*, deriv. uncertain; Sept. *Ἰδακρόν*, Vulg. *Chus*), a Syrian city mentioned in connection with Tibhath, as one of the "cities of Haddarzer," from which David procured brass for building the Temple (1 Chron. xviii, 8). In the parallel passage (2 Sam. viii, 8) these two cities are called respectively Betah and BERTHAI. It is perhaps the same with the *Consa* mentioned in the *Itin. Antonini* as situated between Laodicea and Baalbek. The rendering of the Sept. seems to imply that instead of "from Chun" (כֻן) it had read *Berod* (בְּרוֹד, q. d. בְּכִיר, i. e. בְּחִיר, *choice*); but Josephus supports the present Heb. text (*Máχων*, *Ant.* vii, 5, 3). See BERTHAI.

Church. I. *The word Church*.—1. The origin of the word is uncertain. In the Germanic and Slavonic languages it is found as follows: Anglo-Saxon, *cyrica*, *circ*, *cyric*; English, *church*; Scottish, *kirk*; German, *kirche*; Low-German, *karke*; Frisian, *tsierke* or *tsiarke*; Danish, *kyrke*; Swedish, *kyrka*; Bohemian, *cyrkew*; Polish, *kerkiew*; Russian, *serbow*. The following derivations have been assigned to the word:

(1) Heb. קֻן and קֻרָה; (2) Teutonic, *kōra*, *ka-ra*; (3) Celtic, *cyrc* or *cylich*, *cyrcra* or *cylicra*; (4) Latin, *curia*; Greek, *κυριακόν* (*the Lord's house*, from *κύριος*, *Lord*). The preponderance of opinion is in favor of the last derivation (Gieseler, *Ecol. Hist.* § 1; Hooker, *Ecol. Pol.* v, 13; Pearson, *On the Creed*, Oxf. 1820, i, 504; and, the principal authority, Jacobson, *Kirchenrechtliche Versuche*, Königsb. 1833, 8vo). On the other hand, Meyrick, in Smith's *Dictionary of the Bible* (iii, Appendix, p. c), argues at length against this derivation chiefly on the ground (1) that the Greek missionaries, who are supposed to have carried the Word among the Northern tribes, used *ἐκκλησία*, not *κυριακόν*; and that Ulphilas uses *aikkliþs* (Rom. xvi, 23 et al.); (2) that the Roman Church (and the Roman languages after it) adopted the Greek word *ἐκκλησία*, not *κυριακόν*, from its Greek teachers. His conclusion, after dropping the first derivation, is that "it is difficult to say what is to be substituted. There was probably some word which, in the language from which the Teutonic and Slavonic are descended, designated the old heathen places of religious assembly, and this word, having taken different forms in different dialects, was adopted by the Christian missionaries. It was probably connected with the Latin *circus*, *circulus*, and with the Greek *κύκλος*, possibly also with the Welsh *cylich*, *cyll*, *cychle*, or *caer*. Lipsius, who was the first to reject the received tradition, was probably right in his suggestion, 'Credo et a circo Kirck nostrum esse, quia veterum templa instar Ciroi rotunda' (*Epist. ad Belgas*, Cent. iii, Ep. 44)."

2. *N. T. uses of the word Church*.—The Greek word *ἐκκλησία* in the New Testament (Matt. xvi, 18; xviii, 17; 1 Cor. x, 32; Eph. i, 22), corresponding to the Hebrew קֻרָה, קֻרָה, קֻרָה, is from *καλεῖν*, to call (*ἐκλήσας*, a calling; *ἐκληροί*, called), and is rendered by our word church. The meaning of the word would thus seem to be, in the N. T., the whole company of God's elect, those whom he has called to be his people under the new dispensation, as he did the Israelites under the old. Such is the signification in one of the two instances in which Christ uses the word in the Gospels: "Upon this rock I will build my church" (Matt. xvi, 18). The other (Matt. xviii, 17) refers to the single congregation. Instead of *ἐκκλησία*, Christ generally used the terms "kingdom of God," "kingdom of heaven," or simply "kingdom," or thy kingdom, or the Son of Man's kingdom (John iii, 8; Matt. vi, 32; *ib.* iv, 23, etc.; *ib.* xx, 21; *ib.* xiii, 41; xvi, 26). The word "church" is first applied by St. Luke to the company of original disciples at Jerusalem on the day of Pentecost (Acts ii, 47), and is afterwards applied (in the Acts, Epistles, and Apocalypse) to, 1. The whole Christian body or society, as the sanctified of God (Eph. v, 27); 2. The whole number of those who profess the Christian religion under pastors, etc. (1 Cor. xii, 18); 3. Particular societies of Christians in particular cities or provinces, e. g. the church in Jerusalem (Acts viii, 1); 4. Religious assemblies of these societies and the places in which they met, e. g. (Rom. xvi, 5), "Greet the church that is in their house," etc. (1 Cor. xi, 18; xiv, 19, 28).

3. *Common uses of the word Church*.—1. The most common sense in which the word church is used is to denote the body of the acknowledged followers of Christ, or his visible body. 2. It is also used to denote the community of true believers, whether known to be such or not. 3. It is used as "church militant" and "church triumphant" to distinguish between believers yet on earth, and still contending with opposition, and believers already glorified in heaven. 4. It is used to designate the house of Christian worship. 5. Any particular denomination of Christian people, as the Lutheran, or the Protestant Episcopal, or Methodist Episcopal Church. 6. A particular congregation of any one denomination of Christians. 7. The religious

establishment of any particular nation or government, as the Church of England. 8. The sum of the various Christian denominations in a country, as the Church in America. These are the ordinary uses of the word, and it is important, in order to a right understanding of its force in any case, to know in which of these senses it is employed. Much confusion might be avoided if disputants would always clearly state in which of all these equally admissible senses they use the word.

II. *Idea of the Church.*—The Christian religion (subjectively considered) is a divine life wrought in the soul of the believer in Jesus by the Holy Ghost, whereby the man is united through Christ unto God, walks before him in holiness, and finally dies in his favor, and is received into his eternal glory. The personal relation lies wholly between the individual and God. But the instinct of this new life is to propagate itself by diffusion, and for this diffusion it must have organization. This organization is found in the Church, whose function it is to make universal the religion of the individual. Moreover, the individual believer, for the nourishment of his own spiritual life, seeks communion with other believers; and this communion is furnished by the Church. "The Christian Church is a religious-moral society, connected together by a common faith in Christ, and which seeks to represent in its united life the kingdom of God announced by Christ" (Gieseler, *Ecol. Hist.* vol. i, § 1). "Christianity contains, on the one hand, a divine philosophy, which we may call its religion, and a divine polity, which is its Church" (Arnold, *Miscell. Works*, N. Y. p. 11). The Church is the particular form or expression of the kingdom of God, the institution through whose agency this spiritual and eternal kingdom is to be made effective among men.

But, although there are elements of truth in the statements already made, it is further true that the Church, under the dispensation of the Spirit, is the necessary form or body of Christianity in the world. Not that the Church is Christianity, any more than the body of man is his life. The object of Christianity is the redemption of mankind; and the Church is the divinely constituted means of the ordinary application of redemption to individuals of mankind. It is therefore something altogether more and higher than a mere form of society, or an organization springing, like any merely human society, from the common wants and sympathies of those who unite to form it. It is "the kingdom and the royal dwelling-place of Christ" upon the earth (Neander). It has, therefore, a life of its own, of which Christ is the source, independent of the ordinary life of the order of nature. Christ, indeed, is the central source of life for both kingdoms (the kingdom of nature, and the kingdom of grace), but the mode of his vivifying operation is very different in the one from what it is in the other. But the Romanist view (and so the Greek and High Anglican) assumes that the Church is a form of organic life imposed upon the Christian society in a sort of outward way. The Protestant doctrine, on the other hand, is, that the Church is the divinely inspired organic growth of the Christian life; not, therefore, a merely human society, but the society of the faithful, constituted by the Divine Spirit. The Romanist view makes the outward form of the Church essential, and regards the internal nature as derivative; the Protestant view regards the internal life as the essence, and the outward and visible form as derivative, but both as divinely inspired and constituted (John x, 16; Matt. xvi, 18; xviii, 15-18).

1. *The Scripture Idea.*—In the N. T. the Church denotes "that one mystical body of which Christ is the sole head, and in the unity of which all saints, whether in heaven, or on earth, or elsewhere, are necessarily included as constituent parts." For this Church Christ gave himself (Eph. v, 23). This Church, chosen in him before the foundation of the world (Eph. i, 4;

1 Peter i, 2), he nourisheth and cherisheth as his own flesh (Eph. v, 23, 30). The Church is called the House, the City, the Temple of God. To whom coming—ye are built up a spiritual house, a holy temple (1 Peter ii, 4, 5). This spiritual temple is composed of all God's people, and is his dwelling-place (1 Cor. iii, 17; 2 Cor. vi, 16; Rev. xxi, 8; xxii, 14, 15). The Church is uniformly represented in the N. T. as the company of the *saved*; and they are spoken of as the body of Christ (1 Cor. xii, 27), as one body (Eph. iii, 6; iv, 4; 1 Cor. xii, 13, 20). Of this body Christ is the Saviour (Eph. v, 23). They are also his bride (Eph. v, 31, 32; Rev. xxi, 9, 10), and his fulness (Eph. i, 23). They are termed also the light of the world (Matt. v, 14), and the salt of the earth (Matt. v, 13), as indicating the Church to be the true source of spiritual illumination and the instrument of salvation to the world. For the work which the Church is to accomplish for Christ by teaching, disciplining, comforting, etc., it must necessarily be visible, though all its members may not always be known.

2. *The Creeds and Dogmatic Definitions.*—The Apostles' Creed says, I believe "in the Holy Catholic Church, the communion of saints," to which the Nicene Creed adds apostolicity. The Catechism in use in the Greek Church gives the following definition: "The Church is a divinely-instituted community of men, united by the orthodox faith, the law of God, the hierarchy, and the sacraments" (*Full Catechism of the Orthodox, Catholic, Eastern Church*, Moscow, 1889). In speaking of the unity of the Church, Platon says: "From this unity of the Church all those have separated who either do not receive the divine word at all, or mix with it their own absurd opinions" (see *Bibliotheca Sacra*, xxi, 827). The Roman Catholic Church (*Catechism of Trent*) says, "The Church is one, because, as the apostle says, there is 'one faith, one Lord, one baptism;' but more especially because it has one invisible Ruler, Christ, and one visible, viz., the occupant for the time being of the chair of St. Peter at Rome." . . . "The Church is holy, first, because it is dedicated to God; secondly, because the Church, consisting of good and evil mixed together, is united to Christ, the source of all holiness; thirdly, because to the Church alone has been committed the administration of the sacraments, through which, as efficient instruments of divine grace, God makes us holy; so that whoever is truly sanctified must be found within the pale of the Church. The Church is catholic or universal because it is diffused throughout the world, embracing within its pale men of all nations and conditions, and also because it comprehends all who have believed from the beginning, and all who shall believe henceforward to the end of time. The Church is termed apostolic, both because it derives its doctrines from the apostles, whereby it is enabled to convict heretics of error, and because it is governed by an apostolic ministry, which is the organ of the Spirit of God" (*Catechism, Conc. Trid.* c. x, § 1). Bellarmine defines the Church thus: "It is a society of men united by a profession of the same Christian faith, and a participation of the same sacraments, under the government of lawful pastors, and especially of the one vicar of Christ upon earth, the Roman pontiff." The Lutheran Church defines the Church to be "a congregation of saints, in which the Gospel is purely preached and the sacraments are rightly administered" (*Confession of Augsburg*, sec. vii). "The sum of what we here profess to believe is therefore this: I believe that there is upon earth a certain community of saints, composed solely of holy persons, under one Head, collected together by the Spirit; of one faith and one mind, endowed with manifold gifts, but united in love, and without sects or divisions" (Luther's *Larger Catechism*). The Reformed Confessions:—The Church of England: "A congregation of faithful men, in which the pure word of God is preached, and the sacraments be duly administered according to

Christ's ordinance in all those things that are of necessity requisite to the same" (art. xix).—The same definition is given by the Methodist Episcopal Church.—"The Church is a community of believers or saints, gathered out of the world; whose distinction it is to know and to worship, through the Word and by the Spirit, the true God in Christ our Saviour, and by faith to participate in all the blessings freely given to us through Christ. Those are all citizens of one polity, subjects of the same Lord under the same laws, and recipients of the same spiritual blessings" (*Helvetic Confession*, 1566).—"The Catholic Church is the community of all true believers, viz., those who hope in Christ alone for salvation, and are sanctified by his Spirit. It is not attached to any one place or limited to particular persons, the members of it being dispersed throughout the world" (*Belg. Confession*, sec. 27, 29).—The Scotch Confession (*Conf. Scot.* art. xvi) defines the Church "to be a society of the elect of all ages and countries, both Jews and Gentiles; this is the catholic or universal Church. Those who are members of it worship God in Christ, and enjoy fellowship with him through the Spirit. *This Church is invisible, known only to God, who alone knows who are his*, and comprehends both the departed in the Lord and the elect upon earth."—The Confession of Polish churches: "There are particular churches and the Church universal. The true universal Church is the community of all believers dispersed throughout the world, who are and who remain one catholic Church so long as they are united by subjection to one Head, Christ, by the indwelling of one spirit and the profession of the same faith; and this though they be not associated in one common external polity, but, as regards external fellowship and ecclesiastical regimen, be not in communion with each other."—"A true particular Church is distinguished from a false one by the profession of the true faith, the unmutated administrations of the sacraments, and the exercise of discipline" (*Declaratio Thoruniensis*).—Dr. Gerhart, speaking for the German Reformed Church of America in its later form of thought, under the influence of the so-called Mercersburg theology, says: "The Christian Church is a divine-human constitution in time and space: divine as to its ultimate ground and interior life, and human as to its form; brought into existence by the miraculous working of the Holy Ghost on the day of Pentecost, who is sent by Christ as the bearer of his incarnate life and salvation, in order to continue and develop this life and salvation, according to the law of the Spirit, in its membership down to the end of time uninterruptedly. As such, it is not a collection of units, but an objective organism that has a principle, a unity, a law, organs, and resources of power and grace, which are in it and its own absolutely" (*Bibliotheca Sacra*, 1868, p. 58, 54. See also Dr. Nevin, in *Mercersburg Review*, vol. ix [articles on "Hodge on Ephesians"]; vol. x ["Thoughts on the Church," two articles]).

Such is the notion of the Church as presented in the great leading symbols of the principal churches and by their representative men. The subject is one beset with difficulties, because of the failure always to discriminate between the visible and invisible Church, and because every denomination, in order to render itself powerful and practical, must assume the form of a Church, and is consequently driven to define the Church to suit its own position and history. The distinction between the visible and invisible Church was recognised by Augustine; in his controversy with the Donatists, who held that to predicate catholicity of the Church it was necessary it should have subjective purity in its members, and that, so soon as it allowed corrupt and unworthy members, it ceases to be catholic, he maintained, "Many, by partaking of the sacrament, are *with* the Church, and yet are not *in* the Church." Further: "Those who appear to be the

Church, and to contradict Christ, therefore do not belong to that Church which is called the body of Christ" (see Neander, *Christian Dogmas*, ii, 895). That there is one visible Church all these Confessions concede; but whether or not there be a visible Church on earth entitled to be called the true Church, and the only true Church, is the question at issue between Romanists and Protestants. Certainly, "if we judge of the various churches into which Christendom is divided by their conforming in all respects by the principles and requirements of the Gospels, we cannot allow that any one of them is the perfect representation of that ideal state at which they all aim; nor, on the other hand, can we entirely deny the name of a Christian Church to any one which professes to be built on the Gospel of Christ. They have all so much in common in this religious faith and life, and so much which distinguishes them from all other religious societies, as to justify us in considering them as one whole, and calling them, in a wide sense, The Christian Church" (Gieseler, *Church History*, vol. i, § 1).

8. *Notes, Faith, and Attributes of the Church.*—(1) The notes of the Church are the signs by which the visible Church is distinguished, and differ according to the views which are held in the definition of the Church. (a) The Roman Catechism states them to be unity, sanctity, catholicity, and apostolicity (*Cat. Conc. Trid.* p. 80, 81). Bellarmine assigns, in addition to these, antiquity, uninterrupted duration, amplitude, agreement in doctrine with the primitive Church, sanctity of doctrine, efficacy of the doctrine, the glory of miracles, the light of prophecy, the confession of adversaries, the unhappy end of the Church's enemies, and temporal felicity (*Bellarmino's Notes of the Church examined and refuted by eminent English Divines*, Lond. 1840). The "unhappy end of the Church's enemies" and "temporal prosperity" are rejected by Tournely, Bailly, and generally by modern Romish theologians (see Palmer, *On the Church*, i, 27). (b) The Church of England has no authoritative declaration beyond its sixth article—the preaching of the pure word of God and the due administration of the sacraments, etc.; but the proper administration of the sacraments by ministers regularly authorized has led to a difference of opinion in determining these notes, which has become a wide divergency, the one side adhering to a free interpretation, in common with all Protestants, and the other approaching to the stricter Roman Catholic view. The strict, so-called, churchly interpretation begins with the inclusion of apostolicity (Palmer), and extends to truth of doctrine, use of means (as well as sacraments) instituted by Christ, antiquity without change of doctrine, lawful succession without change of doctrine, and universality in the successive sense, i. e. the prevalence of the Church successively in all nations (Dr. Field). This tendency towards Romanizing views has culminated in what is, for convenience, termed the High-Church, or Sacramentarian party, some of whom openly advocate a union of the Church of England with the Church of Rome and the Greek Church, in order to realize their note of the visible unity of the Church. "It is worthy of remark," says Litton, "that every theory of the Church, whether it profess to be Romanist or not, which teaches that the true being thereof lies in its visible characteristic, adopts instinctively the Romish notes, and rejects the Protestant." (c) The distinctively "Protestant notes"—the preaching of the pure word of God and the right administration of the sacraments—are applicable not to the mystical body of Christ, but to the visible Church, or, rather, to churches or congregations of believers. "The Protestant says, in general, the church (or a part of it) is there where the Word and the sacraments are; and the society in which the one is preached and the other administered is a legitimate part of the visible Catholic Church" (Litton, *On the Church*, Phila. p. 254). "Some formularies, e. g. the Scotch Conf. (art.

18) add the exercise of discipline" (*ibid.*); and this it loses very properly, for if purity of doctrine and life is to be maintained, it must always be a mark of a true Church that there be discipline. But inasmuch as it is impossible to discern always who are inwardly pure, and also perfectly to enforce discipline, the visible Church will always be liable to the intrusion of the wicked, and hence cannot claim to be identical with the mystical body of Christ in any one place, but may claim to be a part of it, so far as in its doctrine and life it conforms to the requirements of the Gospel. "As notes" (the sacraments and the ministry of the Word), "therefore, serve to assure us of the existence of that mystical body which in itself is an object not of sense, but of faith; by which the charge brought of old against Protestant doctrine—that its invisible Church is a fiction of the imagination—is abundantly refuted" (Litton, p. 257).

(2.) *Faith*.—The faith of the Church is given, in authoritative, though not in dogmatical form, in the Word of God. "The Church, as the body of believers in Christ, existed before the New Testament was written. It was to the Church that the Word was addressed. It is by the Church that the authenticity of the Word has been witnessed from the beginning. But the Word was given to the Church as its test and standard of faith. The 'faith' was in the Church before the Word was written; but the Word was given to be the norm of faith, by which the Church might and should, in all ages, test the faith, or any proposed modifications or developments of the faith."

The Church's faith, as drawn from, and resting on, the Word of God, is expressed in her creeds or confessions. At successive periods, as the exigencies of the times have required, or have seemed to require, its leading minds have convened, sometimes by civil, sometimes by ecclesiastical authority, at other times by both, in general councils, when, by consent, the doctrines of the Church have been thrown into the form of confessions or symbols. In these symbols, the floating, undefined, but current beliefs of the general Church have crystallized, and thus have been transmitted to us. The first is the Apostles' Creed. This is universally accepted in the Church, and is of highest authority. Though the most ancient of all the formularies of belief, there is no evidence that the apostles composed it as it now reads; the best explanation is that it grew into shape from the common and general confession of faith in the primitive Church until it very early assumed the form it now has. It is the germ of all subsequent creed development. The next is the Nicæno-Constantinopolitan symbol, commonly called the Nicene Creed, which was the work of two œcumenical councils in 325 and 381. This has always been of great weight, as chiefly settling the doctrine of the Trinity, and expresses the general view of the Church to this day. The Chalcedon symbol followed in 451; and then the Athanasian Creed, called after Athanasius, though it is doubtful if he was the author. There were no other confessions until the Reformation, since which we have the Lutheran symbols (7); the Reformed (18); the papal (Canones et Decreta Concilii Tridentini, 1545; *Professio fidei Tridentina* of Pope Pius IV, etc.); confessions of the Greek Church; Arminian and Socinian confessions; but none of these are of universal authority, as are the original four of the early Church.

(3.) The *attributes* of the Church are unity, holiness, catholicity, and apostolicity. These also are explained differently, according to the theory of the Church maintained. Protestants generally find these attributes only in the invisible Church. There is evidently a unity of faith (Eph. iv, 18), a unity of love (1 Cor. xiii, 18), one spirit (Eph. iv, 4), one hope (*ibid.* 12), one body (Rom. xii, 5), one head (Eph. iv, 15), and one object of worship (Eph. iv, 6). That this unity is under one common earthly head is held

by Roman Catholics, but denied by Protestants. By these a spiritual unity is affirmed to exist, even where there is not uniformity of Church polity, nor entire agreement of doctrine, nor, indeed, any internal bond save that of the "communion of saints." Holiness is ascribed to the Church as expressing the moral purity of its members; they are addressed in the N. T. as "saints," "sanctified," by reason of their union with Christ as their living head, and the possession of the Holy Ghost, the Sanctifier (1 Cor. i, 2; vi, 19). Because this holiness is a personal work in the hearts of believers *as such*, it can be predicated strictly only of the invisible Church, but it ought to be manifested in the individual and corporate life of the Church, in order that she may fulfil its original constitution. Catholicity was first applied to the Christian Church to designate not only its universality as embracing all true believers, but also the oneness of those believers as excluding all heretics. In modern times it is used to mean the universally diffused nature of the Church by its presence, without respect to local or national boundaries. The Romanist claims that all, and those only, who are united to the pontiff at Rome belong to the Catholic Church; while Protestants admit it to be the whole body of Christians, in whatever visible communion they may be: hence composed of all the churches of all nations (Mark xv, 15; Acts x, 84, 85), the same in all time (Matt. xxviii, 20), and possessed, by reason of the presence of its great head, of the means of saving grace (*ibid.*; Eph. i, 22). Apostolicity is not insisted upon by Protestants; when used, however, by them, it means the possession by the Church of true apostolic doctrine, spirit, and life; while by Roman Catholics it means having a ministry regularly and visibly succeeding to the apostles.

The attributes (unity, holiness, catholicity, perpetuity) are unquestionably essential to the true Church, and are ascribed to her in the New Testament. But neither the N. T. nor the Apostles' Creed define the Church as a visible organization, but as the "communion of saints." This Church has always existed; but no visible corporation or society on earth has ever been endowed with the attributes above named. See this argument well stated in the *Princeton Review* (Oct. 1853); compare Barrow, *Sermon on the Unity of the Church*, iii, 811 (N.Y. 1845).

III. *History of the Doctrine of the Church*.—The apostles and their immediate successors were too much engrossed with the work of spreading the Gospel to pause to define the nature of an institution which was sure to grow into shape as the necessities of the case required. The apostles themselves were too earnestly employed in fulfilling the command of Christ to disciple all nations, and those directly following them partook too largely of their spirit, and understood too fully their mind, to be turned aside by the necessity of defining what they knew to be a fact. Hence "no exact definitions of the Church are found previous to the time of Cyprian" (Hagenbach, *History of Doctrines*, vol. i, p. 198). The definitions of the latter (Cyprian) make an epoch in the history of this doctrine. The first difficulty arose as to the unity of the Church, in confounding the inward with the outward. "Irenæus shows the first germs of this perversion; it was matured by Cyprian" (Neander, *Christian Dogmas*, vol. i, p. 220), "Thus the Jewish stand-point (a theocracy), which at first had been overcome, made its way into the Church in another form" (*ibid.*). Irenæus says the Church alone contains all the riches of truth; Clement describes the Church as a mother, both as a mother and virgin, as the body of the Lord; Origen, though usually mild towards heretics, knows of no salvation out of the Church; Tertullian claimed that whoever separated from the connection with the outward communion, which was of apostolic origin, and had at its head the *sedes apostolica*, in so doing renounced Christ, though after joining the Montanists he essentially changed his

opinion. "It is of no avail, says Cyprian, what a man teaches; it is enough that he teaches out of the Church; where the bishop is, there is the church, etc. The roots of the extreme church doctrine are to be traced thus early. A reaction, however, soon took place, growing out of a more scientific discernment of the spiritual idea of the Church. Clement calls the Church a community of men led by the divine *Logos*, an invincible city upon earth, which no force can subdue, where the will of God is done as it is in heaven. Others combated the outward unity of the Church as unscriptural. Montanism insisted that the unity is inward; it regarded the internal fact of possessing the Spirit as the fundamental thing—not the ordinary influence of of the spirit in sanctification, but his extraordinary power in giving new revelations, which were the sources of authority and unity in the Church. A farther reaction of separatism against the Catholic idea took place in Novatian and his followers. They insisted that the Catholic Church is essentially holy in all its members, and hence must exclude from its communion all unworthy members, and never readmit them, otherwise it would lose its catholicity. They consequently withdrew, and claimed to be the Catholic Church. "The false idealism of the Gnostics, and the subjective, heretical, and schismatical tendencies of separate sects, especially of the Montanists and the followers of Novatian (the primitive Puritans), form a striking contrast with this false external unity of the Catholic Church" (see Hagenbach and Neander). "Two causes contributed (in the second period of the Church history) to determine about the Church: 1. The external triumph of the Church itself in its victory over Paganism, and its rising power under the protection of the state. 2. The victory of Augustinism over the doctrines of the Pelagians, Manichæans, and Donatists, which in different ways threatened to destroy ecclesiastical unity. In opposition to the Donatists, Augustine asserted that the Church consists of the sum total of all who are baptized, and that the (ideal) sanctity of the Church is not impaired by the impure elements externally connected with it. The bishops of Rome impressed upon this catholicism the stamp of the papal hierarchy by claiming for themselves the primacy of Peter. But, whatever variant opinions were held respecting the seat and nature of the true Church, the proposition that *there is no salvation out of the Church* was firmly adhered to, and carried out in all its consequences" (Hagenbach, vol. i, p. 352). It is worthy of note that at this period Jovinian taught that "the Church is founded on Faith, Hope, and Love. In this Church there is nothing impure; every one is taught of God; no one can break into it by violence or steal into it by artifice." "As Jovinian taught the Pauline doctrine of faith, so he did the Pauline idea of the invisible Church, while Augustine obstructed his similar fundamental idea by a mixture of the Catholic idea of the Church." "Here again we have a sign of the Protestant element in Augustine" (his comment on the "Thou art Peter"), "that all religious consciousness is immediately to be traced up to Christ, and that with him the community originates which is called the Church" (Neander, *Christian Dogmas*, vol. ii, p. 897, 898).

Until the 14th century the Roman hierarchy had comparatively no opposition in carrying out supremacy in the West to its fullest extent; at this time a freer spirit began to show itself. Even on the Catholic stand-point a difference was stirred respecting the relation of the changeable and unchangeable in the development of the Church; on the position of the papacy in respect of the Church; whether the pope was to be regarded as its representative or sovereign head; whether the general councils or the pope stood highest. The University of Paris, with chancellor Gerson at its head, led on this controversy. See GERSON. "The mystical idea of the Church and the notion of a univer-

sal priesthood, which was intimately connected with it, was propounded, with more or less accuracy of definition, by Hugo of St. Victor, as well as by the forerunners of the Reformation, Wycliffe, Matthias of Janow, Hus, John of Wesel, Weasel, and Savonarola" (Hagenbach). These tendencies were fully developed in the Reformation and in its results. The Western religious world became divided in the statement of the Church dogma, as it looked at the question of salvation. The Protestant, regarding the doctrine of justification by faith as fundamental, said the Church is approached through it; the Romanist, still adhering to the Church as the fountain of spiritual life, affirmed that justification is obtained through the Church. Protestants assert that the Church consists in the invisible fellowship of all those who are united by the bonds of true faith, which ideal union is but imperfectly represented by the visible Church, in which the true Gospel is taught and the sacraments are rightly administered; the Roman Catholics, that the Church is a visible society of all baptized persons who adopt a certain external creed, have the same sacraments, and acknowledge the pope as their common head.

The recent controversies concerning the idea and nature of the Church all revolve about the one point, viz., whether the Church of which Christ is the "Head" is, or is not, a visible corporation here on earth, entitled to the promises, privileges, and authority which the Scriptures assign to the spiritual Church. Protestants generally deny; the Romanists, the High-Anglicans, and a few writers in other branches of the Protestant Church, affirm. The so-called New-Lutheran divines of Germany have developed a theory of the Church in which the Protestant idea gives way to the hierarchical; in which the sacraments are not merely notes of the true Church, but the real guards of its continued life. The profound and mysterious synthesis of the divine and human is found in faith, according to the old Protestant system; according to the new, it is found in the sacraments (compare Schwartz, *Zur Geschichte d. neuesten Theologie*, bk. iii, ch. iii). Rothe has developed, with his usual vigor, a theory of the Church akin to that of Arnold, viz., that the Church is indispensable to the moral education of humanity; but that, as humanity improves, the necessity for the Church diminishes; and, finally, the state will become religious (a real theocracy), and the Church will become absorbed in the state.

IV. *Constitution of the Church.*—Christ did not so much create a Church during his sojourn on earth as implant principles which would be subsequently developed into a Church. Whilst he was yet with his disciples, they needed no other bond to hold them together than his person. The founder of the new manifestation of the kingdom of God seemed not to design to collect about him numerous adherents, but to implant deeply into the minds of a few the higher animating spirit of this kingdom, which through their lives should work out into a complete and effective organization. He found those whom he called for this work Jews; he associated with and instructed them after the customs of Judaism. He distinctly told them, however, that they, in their persons, faith, life, and teaching, were to constitute the beginning and the agency of a new order of things. They were commanded to go forth after his death and disciple all nations, and to baptize them in the name of the Father, the Son, and the Holy Ghost, and thus bring all people into the kingdom of God. It is thus clear that the religion of Christ was designed by him to supersede all others, not only by its spirit and essence, but also in the particular method or form of its manifestation. He made provision for this result by constituting apostles, who should authoritatively command and teach, should open and shut the kingdom of heaven, bind and loose on earth, and so render visible and powerful his Word among men.

Before entering upon their mission, they were to tarry in Jerusalem until endued with power from on high (Luke), which power they were assured would come not many days after the ascension of their Lord. That they already recognised themselves as chosen for a high especial work is evident by their filling up the vacancy in their number caused by the apostasy and death of Judas Iscariot with the selection of another, Matthias, to fill his place (Acts i, 15, 26). Thus complete, they continued to wait and pray for the space of seven days. When the day of Pentecost had fully come, "while the apostles and disciples, a hundred and twenty in number, were assembled in or near the Temple for the morning devotions of the festal day, and were waiting in prayer for the fulfilment of the promise, the exalted Saviour poured down from his heavenly throne the fulness of the Holy Ghost upon them, and founded his Church upon earth" (Schaff, *Church History*, vol. i, p. 59). The day of Pentecost may be regarded as the birthday of the Christian Church. Then it was formed; thence its gradual development proceeded. There is a diversity of opinion as to the internal polity it assumed, as might be expected; but it must be conceded by all that the apostles would have "sufficient guidance" as to the manner in which it was to be organized. This guidance does not imply that its particular form must have been given to them by Christ, but only such direction as would lead them to pursue the wisest methods. Consequently they began by preaching; and, as converts were made, by baptizing them, and then taking them into a closer fellowship for the celebration of the Lord's Supper, spiritual instruction, and worship (Acts iii, 42, etc.). As they were Jews, it was likely they would adopt the methods of worship, government, etc., to which they were accustomed. Archbishop Whately says (*Kingdom of Christ delineated*, p. 88): "It appears highly probable, I might say morally certain, that the synagogue was brought—the whole or chief part of it—to embrace the Gospel. The apostles did not, then, so much form a Christian Church (or congregation, *ecclesia*) as make an existing congregation Christian by introducing the Christian sacraments and worship, and establishing whatever regulations were necessary for the newly-adopted faith, leaving the machinery (if I may so speak) of government unchanged; the rulers of synagogues, elders, and other officers, whether spiritual or ecclesiastical, or both, being already provided in the existing institutions." Vitringa (see his *De Synagoga Veteri*), Neander, Litton, and many others, agree in this opinion, that the synagogues were the pattern which the apostles proposed to themselves, though it is by no means certain that they adopted any model.

1. All that can be done in the determination of the polity of the *apostolic Church* is to trace the practice of the apostles as recorded in their acts and writings. This polity is not presented as legislative enactments, but simply as facts, showing how the apostles acted in given cases. In the first account we find the Church composed of the apostles and other disciples, and then of the apostles and "the multitude of them that believed." Hence it appears that the Church was at first composed entirely of members standing on an equality with one another, and that the apostles alone held a higher rank, and exercised a directing influence over the whole, which arose from the original position in which Christ had placed them in relation to other believers (Neander, *Planting and Training*, p. 32). The apostles, as necessity required, created other offices, the first of which we have mention is that of *deacon* (*διακονία*) (Acts vi, 1), followed soon after by that of *elder* (*πρεσβυτερος*) (Acts xi, 30). The time of the creation of the office of elder or presbyter is not given, from which it is not clear whether it arose before or after the diaconate. The first reference to elders assumes their existence. The office of

elder and that of bishop are generally conceded to be identical. The apostles, deacons, and elders, with the whole body of believers in every place, constituted the membership and government of the Church. See BISHOP. The deacons were overseers of the poor, and probably conducted religious worship and administered the sacraments (Acts viii, 28). The clerical function of the deacon is disputed (see *American Presb. and Theol. Review*, vol. v, p. 184). The elders were appointed not only to teach and administer the sacraments, but also to govern the Church or churches in the absence of the apostles (Acts xx, 28, etc.). The ministry, however, was not confined to these orders; it was rather a gift which any one possessing could exercise under due regulations. By reference to 1 Cor. xii, 4–12, also 28, it will be seen that "apostles," "prophets," "helps," and "governments," all pertain to the ministry; also in the corresponding passage, Ephes. iv, 11, 12, the ministerial office is ascribed to the direct agency of the Holy Ghost: "He gave some, apostles; and some, prophets; and some, evangelists; and some, pastors and teachers; for the perfecting of the saints, for the work of the ministry, for the edifying of the body of Christ." "These passages establish nothing respecting the ministerial offices of the apostolic age; what they do teach us is that the spiritual endowments necessary for the office of an apostle, a pastor, a teacher, or a governor of the Church, whether these functions were united in the same person or not, flow directly from Christ, and are a part of the standing spiritual constitution of the Church" (Litton, p. 374). The manifold gifts of the Spirit were termed generically *charismata* (*χαρισματα*), and were either a natural endowment, sanctified and applied under the influence of the Holy Spirit to the edifying of the Church, or a supernatural gift of a miraculous character, in the exercise of which the divine agent was more conspicuous than the human. Another division is into those which displayed themselves in *word*, and those which had a more particular reference to action (Litton; Neander, *Planting and Training*; Olshausen, Hooker, etc.). These gifts, it appears, were not confined to any particular class, but were bestowed as the Spirit saw fit to distribute them. See GIFTS, SPIRITUAL. The priestly function pertained to the ministerial office only in the sense that all believers were priests, to offer up spiritual sacrifices to God by Christ (1 Peter ii, 4, 5, etc.); and in no sense was there a sanctity attaching to the minister which did not attach to the ordinary believer, except, perhaps, to the apostles, whose office was not to be permanent in the Church. No human mediation is represented in the New Test. as necessary to the soul seeking the forgiveness of sins and the fruits of the Spirit except such as may assist knowledge and faith, but never as *indispensable*. Christ and his salvation are equally accessible to minister and people, and on the same terms.

The *discipline* of the apostolic Church comprehended four particulars in its exercise: 1. Nothing scandalous or offensive unto any, especially unto the Church of God, could be allowed (1 Cor. x, 32); 2. All things were to be done with seemliness and in order (1 Cor. xiv, 40); 3. All unto edification (1 Cor. xiv, 26); 4. All unto the glory of God (1 Cor. x, 31). The *sphere* of its government was strictly spiritual. The apostles honored the civil authority as a divine institution, and enjoined obedience in the days of Claudius and Nero, as did our Saviour in all temporal matters render obedience to Herod, and command that "the things which belong to Cæsar should be rendered to Cæsar." But in the spiritual calling the rule was "to obey God rather than man," and for this principle they were ready to die.

Since the apostolic times the Constitution of the Christian Church has undergone various modifications. The first of these changes is the distinction be-

tween bishop and elder. It is maintained by extreme advocates of Episcopacy that St. Paul, in empowering Timothy at Corinth, and Titus in Crete, in the capacity of presbyters, to ordain elders in every city, and to exercise jurisdiction over officers of that class, as well as those who held the office of deacon, appointed them thus to be permanent, and so created the office known in after times as the local bishop. The moderate Episcopalians and the Presbyterians hold that the mission of Titus and Timothy was peculiar, contemplating a special work, and that the mission ceased with its accomplishment. On the whole, on this case, as well as on that of St. James at Jerusalem, and the angels of the apocalyptic churches, Litton says, "Respecting the origin of the episcopal order, Scripture leaves us very much in the dark. No order of ministers other than these three—apostles, presbyters, and deacons—are mentioned in the New Testament as forming part of the then existing polity of the Church; for every attempt to establish a distinction between the presbyter and the bishop of Scripture will prove fruitless, so abundant is the evidence which proves they were but different appellations of one and the same office (p. 412)." As to the rise of episcopacy, it is said "to these successors of the apostolic delegates" (such as Timothy) "came to be appropriated the title of bishop, which was originally applied to presbyters. At the commencement of the second century and thenceforward, bishops, presbyters, and deacons are the officers of the Church wherever the Church existed. Ignatius's epistles (in their unadulterated form), and the other records which are preserved to us, are on this point decisive. . . . They (the bishops) retained in their own hands authority over presbyters and the functions of ordination, but with respect to each other they were equals" (Smith's *Dict. of Bible*, art. CHURCH). Dr. Hitchcock (*Am. Presby. and Theol. Rev.* vol. v, no. 17) affirms, "Thus throughout do we find in Clement the original New Testament polity (identity of presbyters and bishops) as yet unchanged" (p. 187). "In short, the Ignatian Episcopacy, instead of having the appearance of a settled polity, handed down from the apostles, has the appearance of being a new and growing institution, unlike what went before, as well as what was coming after it" (*ibid.* p. 146). "The wavering terminology of Irenæus is indicative not of apostolic tradition, but of later genesis and growth, and that growth not yet completed" (*ibid.* 147). "No hesitation in Tertullian in accepting the Episcopal regimen. Evidently this had become the settled polity. The maturity of the system is indicated by entire steadiness in the use of term" (*ibid.* 148). "In Cyprian of Carthage, between 248-258, we find the system fully matured. Now these are tokens of growth, and are inconsistent with the idea of apostolic tradition" (*ibid.* 158). There is but little doubt the bishops at first succeeded to office by seniority, and afterwards, as the difficulties of the office increased, A.D. 200, they became elective (Hilary). As the Church multiplied and expanded, the older churches and the most numerous became relatively more important and influential, and their bishops more powerful; hence we find the episcopacy undergoing marked changes: 1. The bishoprics at Jerusalem, Rome, Antioch, Alexandria, Ephesus, and Corinth are termed by pre-eminence *sedes apostólicas*, without, however, the concession of superior authority; 2. Consequent upon provincial synods the metropolitan dignity arose; also, 3. The patriarchal; and 4, finally, the papacy. Cyprian allowed that "precedency should be given to Peter, 'that the Church of Christ may be shown to be one.'" "The same propensity to monarchical unity, which created out of the episcopate a centre, first for each congregation, then for each diocese, pressed on towards a visible centre for the whole Church. Primacy and episcopacy grew together" (Schaff, *History of the Christian Church*, vol. 1, p. 427). The high antiquity of the Roman Church;

the missionary labors at Rome of Peter and Paul, the two leading apostles; the political pre-eminence of the metropolis of the world; the executive wisdom and orthodox instinct of the Roman Church, and other secondary causes, favored the ascendancy of the Roman see (*ibid.*). The early fathers, as Ignatius, Irenæus, Tertullian, Hippolytus, Cyprian, etc., concede precedence to the Church at Rome, but only in honor, not in jurisdiction. After the conversion of Constantine, and the removal of the Roman capital to Byzantium (afterwards called Constantinople), the see of the new capital boldly disputed the supremacy with the see of Rome, from which time, as new agitations arose in the Church, and the empire gradually fell to decay, the two great divisions into the Eastern or Greek, and Western or Roman Catholic took place, and became the settled forms and sources of ecclesiastical dominion.

Additional and inferior orders of the ministry rapidly multiplied in the Church. These were, archdeacons, deaconesses, subdeacons, acolytes, exorcists, lecturers or readers, ostiarii or door-keepers, psalmists or singers, copists or fossarii, catechists, defensores or syndics, economi or stewards, besides others (Bingham's *Antiquities of Christ. Ch.* vol. i, p. 126). There were four several ways of designating persons to the ministry in the apostolic and primitive Church: 1. By casting lot; 2. By choice of the first-fruits of the Gentiles; 3. By particular direction of the Holy Ghost; 4. By common suffrage and election. Ordination was first by the laying on of the hands of the apostles or elders, and afterwards of a bishop or bishops (see *ibid.*).

As to the powers of the clergy in the government of the Church, two principal, distinct, and opposite theories obtain. The Roman Catholic is, that "the government of the Church is a hierarchy, or the relation of the clerical body to the Christian people is that of a secular magistracy to its subjects, and Christian ministers are mediators between God and man—that is, are priests in the proper sense of the word" (Litton, p. 395). "The hierarchism of Rome is the natural and inevitable consequence of the doctrine that the clergy are *ἐκκλησίαν*, the Church" (*ibid.* 397). Bellarmine sums up the Romish doctrine thus: "It has always been believed in the Catholic Church that the bishops in their diocese, and the Roman pontiff in the whole Church, are real ecclesiastical princes; competent by their own authority, and without the consent of the people or the advice of presbyters, to enact laws binding upon the conscience, to judge in causes ecclesiastical like other judges, and, if need be, to inflict punishment" (Bellarm. *De Rom. Pont.* b. iv, c. 15). The Protestant theory is that all believers are a spiritual priesthood, and, as such, constitute the Church, and that the whole Church, thus composed of believers differing in gifts according to the operation of the Spirit, is the fountain of authority in the administration of government. "In short, no principle of ecclesiastical polity is more clearly deducible from Scripture than that the sovereignty of a church resides not in the people apart from their pastors. This, however, being admitted, the converse also remains true, that the sovereignty of a church is not in the pastors exclusively of the people" (Litton, p. 399). Dr. Schaff says, in reference to the first council of Jerusalem, "though not a binding precedent, (it) is a significant example, giving the apostolic sanction to the synodical form of church government, in which all classes of the Christian community are represented in the management of public affairs and in settling controversies respecting faith and practice" (*Ch. Hist.* vol. i, p. 136). By many Protestants this view of the council is questioned, and the right of laymen to an equal participation in church government, from this and other apostolic examples, denied; so that, to this day, the relative powers of ministry and laity, in the administration of ecclesiastical government, remain undefined among some of the great Protestant churches.

Membership of the Church.—"Church members are those who compose or belong to the visible church. As to the real church, the true members of it are such as come out from the world, 2 Cor. vi. 17; who are born again, 1 Peter i. 23; or made new creatures, 2 Cor. v. 17; whose faith works by love to God and all mankind, Gal. v. 6; James ii. 14, 26; who walk in all the ordinances of the Lord blameless. None but such are members of the true church; nor should any be admitted into any particular church without evidence of their earnestly seeking this state of salvation.

Fellowship.—"Church fellowship is the communion that the members enjoy one with another. The ends of church fellowship are, the maintenance and exhibition of a system of sound doctrine; the support of the ordinances of evangelical worship in their purity and simplicity; the impartial exercise of church government and discipline; the promotion of holiness in all manner of conversation. The more particular duties are, earnest study to keep peace and unity; bearing of one another's burdens, Gal. vi. 1, 2; earnest endeavors to prevent each other's stumbling, 1 Cor. x. 28-38; Heb. x. 24-27; Rom. xiv. 18; steadfast continuance in the faith and worship of the Gospel, Acts ii. 42; praying for and sympathizing with each other, 1 Sam. xii. 23; Eph. vi. 18. The advantages are, peculiar incitement to holiness; the right to some promises applicable to none but those who attend the ordinances of God, and hold communion with the saints, Psalm xciii. 13; cxxxii. 13, 16; xxxvi. 8; Jer. xxxi. 12; the being placed under the watchful eye of pastors, Heb. xiii. 7; that they may restore each other if they fall, Gal. vi. 1; and the more effectually promote the cause of true religion" (Watson, s. v.).

Literature.—Besides the works already cited, see Hooker, *Ecclesiastical Polity*, i. 346; ii. 226, 345; iii. 442 (Oxford, 1798, 8 vols. 8vo); Calvin, *Institutes*, bk. iv. ch. i; Pearson, *Exposition of the Creed*, art. ix; Cramer, *Works*; Burnet, *On the 39 Articles*, art. xix; Browne, *On the 39 Articles*, art. xix; Palmer, *Treatise of the Church* (Anglican: N. Y. 1851, 2 vols. 8vo); Litton, *The Church of Christ* (Protestant view: London, 1851, 8vo); Philadelphia, revised ed. 1863, 8vo); Stone, *The Church Universal* (Protestant: N. Y. 1846; new ed. 1867); Watson, *Theological Institutes*, pt. iv. ch. i; Schaff, *Apostolical Church*, ch. ii; Rothe, *die Anfänge d. christlichen Kirche* (vol. i. 1887). In the Romanist view, Perrone, *Prælectiones Theologicae*, i. 181 sq.; Mähler, *Symbolism*, p. 380 (N. Y. 1844, 8vo). Against the Romanist view, Cramp, *Text-book of Popery*, p. 42; Elliott, *Delineations of Romanism*, bk. iii. ch. i; Jackson and Sanderson, *On the Church*, edited by Goode (Philadelphia, 1844, 18mo); Whately, *Kingdom of Christ* (N. Y. 1843, 12mo). On the doctrine of the Church in the creeds of the churches, Guericke, *Allgemeine christliche Symbolik* (3d ed. Lpzg. 1861, § 71; partly translated from 1st ed. in *Evangelical Review*, 1858, art. ii); Ebrard, *Christliche Dogmatik*, ii. § 459-490; Winer, *Compar. Darstellung*, xix. See also Coleman, *Ancient Christianity*, ch. vi; *N. Brit. Review*, Feb. 1853, art. v; *Land. Quart. Rev.* (Methodist), June, 1854; April, 1855; Cunningham, *Historical Theology*, vol. i. ch. i. For the Congregational view, Ripley, *Church Polity* (Boston, 1867, 18mo); B. Cooper, *Free Church of Ancient Christendom* (Lond. n. d., 18mo); Dexter, *On Congregationalism*, ch. ii (Boston, 1865, 8vo).

CHURCH, ABYSSINIAN. See ABYSSINIAN.

CHURCH AND STATE. 1. *Pagan Nations.*—In the Pagan states the religious life has been, on the whole, part of the political, and religion an affair of the state. In general, the priestly dignity was vested in the chief of the state government. In Athens and other Greek republics the popular assemblies had the final decision on religious affairs. In Rome the priestly dignity was originally united with the person of the kings; after the establishment of the republic, the Senate had supreme control of religious affairs; on the

establishment of the empire, the emperor became *Pontifex Maximus*.

2. *Among the Jews.*—Among the Jews, the whole government of the state was based upon the idea that Jehovah was the ruler of the people. All the national institutions were destined to promote the worship of the King of Israel, and to make the people obedient to his precepts as they were laid down in the Old Testament. God, the king of Israel, ruled the people through the organs which he appointed—through Moses, Aaron and his descendants, Joshua and the judges, and the prophets. The demand of the Jews for a king was therefore censured by Samuel as a weakening of the perfect theocracy; but even the king always remained in the Jewish law the earthly representative of Jehovah, and he had no right to give new laws, but simply to execute and enforce the laws given directly by Jehovah. See THEOCRACY.

3. *Teaching of Christ and the Apostles.*—The teaching of Christ on the relation of the Church founded by him to the state was very plain. He distinctly recognised the absolute law-giving power of the state governments in all secular affairs, and enjoined upon his followers to obey the state laws in everything that was not opposed to the precepts of their religion. His reply to the Pharisees, "Render unto Cæsar the things which are Cæsar's, and unto God the things that are God's" (Matt. xxii. 21), distinctly pronounces the separation between the Church and the State. He declares the powers of the civil rulers to be of divine authority by saying to Pilate, "Thou couldest have no power at all against me except it were given thee from above." The apostles enjoin upon Christians obedience to the existing state governments: thus Paul, in the Epistle to the Romans (xiii. 1, 2), "Let every soul be subject to the higher powers. For there is no power but of God; the powers that be are ordained of God. Whosoever, therefore, resisteth the power, resisteth the ordinance of God; and they that resist shall receive unto themselves damnation." Similar precepts are given in 1 Tim. ii. 1, 2; 2 Titus iii. 1; 1 Pet. ii. 13. Only in case of demands directly contrary to the Christian religion, obedience was to be refused. Thus Peter and the other apostles, when commanded not to teach in the name of Jesus, answered, "We ought to obey God rather than men" (Acts v. 29).

4. *Christianity in the Time of Constantine.*—In compliance with these teachings of Christ and the apostles, the first Christians conformed themselves to all secular laws; and only when things were demanded of them contrary to Christian law, such as the open renunciation of their faith, they refused obedience, but submitted to the penalties imposed upon them. The persecutions which the Christians had to suffer during the first three centuries arose not from any active opposition on their part to the Roman laws, but chiefly from the application of the ancient laws, which forbade any Roman citizen to worship divinities not recognised by the state, and any conquered nation to propagate its religion in other parts of the empire. Hence the more the outward distinction of the Christians from the Jews became apparent, the more they exposed themselves to the application of the Roman law. Most of the persecutions were, however, of short duration, and some of the emperors even showed themselves favorable to the Christians. As civil and military offices frequently brought the occupants into situations in which they had to pay some homage, direct or indirect, to the pagan state religion, the Christians naturally regarded it as dangerous to perform the duties of such offices. The fact, however, that Christian senators and Christian soldiers are mentioned in the early history of the Church, shows that the holding of such offices was, in itself, not deemed incompatible with the religious duties of a Christian.

5. *From Constantine to Charlemagne.*—A new era in the history of the relation between Church and State

begins with the reign of Constantine the Great. In the years 312 and 313 full freedom was guaranteed to the Christian Church throughout the empire. Soon imperial edicts granted many privileges to the clergy. They received the same immunities which were possessed by the pagan priests, and soon were preferred to the latter; the particular churches obtained the right of receiving legacies; the bishops received some kind of independent jurisdiction. The emperor, in conferring these rights, acted from the old Roman standpoint of chief of the state in matters religious as well as secular. Thus the first exhibition of a Christian state churchism was a direct emanation from pagan views transferred to the Christian Church. The emperor retained the *insignia* and the name of *Pontifex Maximus*. Gratian was the first who laid aside the *insignia*, but the name was retained much longer. On the coins Constantine placed the cross, as a symbol of Christianity, by the side of the sun-god, as the representative of the old religion. The emperors thus from the start began to view themselves more as patrons than as members of the Christian Church, and the chiefs of the Church were, on the whole, well pleased with the privileges which were conferred upon them, and thought little of disputing the influence which the emperor gradually claimed to exercise upon Church affairs. In the East, this subjection of the ecclesiastical authorities to the state governments went much further than in the West, and has remained a characteristic of the Eastern churches up to the present day. The emperors convoked the synods, and claimed the right of sanctioning their resolutions. Even doctrinal formulas were sometimes drawn up by the emperors, and only promulgated by the bishops. The banishment of bishops for not concurring in the resolutions passed by synods convoked by the emperors, and frequently acting under the direct influence of the emperors, began even during the reign of Constantine.

In the western countries of the empire, the prominent position which was early awarded the bishop of Rome, and subsequently the local separation from the seat of the empire, weakened the power of the emperor in Church affairs. Some of the most prominent bishops and priests (Ambrose, Jerome, etc.) repelled in energetic language the right claimed by the emperors to decide Church questions. Several of the Eastern emperors thought it, moreover, in their interest to gain the friendship of the Roman bishops by making to them large concessions, and thus encouraged the aspirations of the latter to a supreme power in the Church. The Roman bishop Gelasius, in 494, claimed a superiority of the ecclesiastical over the secular power, and a synod convoked by the Roman bishop Symmachus, in 502, condemned the encroachment of king Odoacer upon the rights of the Church. When the German tribes, and in particular the Franks, became Christians, their kings gave to the clergy great privileges, and a great influence upon the administration of national affairs, but in return claimed the supreme power in ecclesiastical as well as secular affairs. Meetings of the clergy could not take place without royal permission, and all their resolutions needed, before being promulgated, the sanction of the kings. Even the appointment of the bishops soon came to be regarded as a royal prerogative. Charlemagne, who was crowned by Pope Leo III as Roman emperor, conceived the bold idea of a universal Christian monarchy. In his opinion, it was the chief duty of the emperor to defend the Church of Christ everywhere against pagans and infidels, and to extend her territory. The Church, on the other hand, was to aid in the execution of this plan by spiritual means. The pope, in his eyes, was the first clergyman of the empire, whose election, as well as that of the bishops, had to be ratified by the emperor. He was anxiously intent upon avoiding all conflicts between Church and State, but reorganized the whole ecclesiastical constitution of the

empire, and even issued decisions on doctrinal questions, as, for instance, the heresy of the Adoptionists.

6. *From Charlemagne to the Reformation.* — The weak successors of Charlemagne were not able to carry through the ideas of the great emperor; and the natural tendency of the Church, and in particular of the popes, to elevate their dignity at the expense of that of the emperors, met with but little resistance. The synods of this time generally propounded the doctrine that the pope held the highest position in the government of the Christian Church, and the emperor the highest position in the secular government of the Christian world; but that the Church was more important than the state, and the dignity of the pope higher than that of the emperor. This doctrine was in particular propagated by the pseudo-Isidorian decretals, which about this time obtained a leading influence upon Church legislation. The independence of the imperial power found, however, some very energetic champions even among the bishops; as, for instance, Hincmar of Rheims (†881). During the ninth and tenth centuries the authority of the papal see greatly suffered from the immoral character of some of its occupants, and it was therefore easy for the great German emperors of this time to increase the imperial power at the expense of the papal. The emperors still deemed it their duty to execute the laws of the Church, and excommunication was frequently followed by the ban; but, at the same time, the emperors recovered their former influence upon the election of the popes. This lasted until the middle of the 11th century, when the papal see, under the influence of the monk Hildebrand, began to exhibit greater strength, and put forth more exorbitant claims than ever before. In 1059 Nicholas II annulled the direct power of the emperors in the election of popes, which was transferred to the College of Cardinals, while to the emperor only the confirmation of the pope elect was left. When Hildebrand himself, in 1073, under the name of Gregory VII, ascended the papal throne, he boldly and vigorously proclaimed a new theory of the relation between Church and State. He claimed for the Church alone a divine origin, ascribing to all secular institutions, and in particular to the state itself, a human origin. The Church, therefore, was to be the highest power in society, and the state, for its legal existence, required the sanction of the Church. In the Church he enforced the law of celibacy, in order to separate the clergy entirely from the laity, and the absolute subordination of priests to bishops, and of both to the pope, in order to concentrate all power in the hands of the latter, and to make him the real head of the universal Christian monarchy. Gregory and his successors had an unceasing conflict with the German emperors with regard to this theory, and in particular as to the appointment of bishops and other ecclesiastical dignities by the secular power. Many bishops and priests took sides with the emperors, who repeatedly caused the election of anti-popes. Nevertheless, the theory which maintained the superiority of the Church to the state continually gained ground. The views of Gregory VII were further developed by Alexander III and Innocent III. The latter maintained that the State and the world had not the nature of a divine institute, but were the products of human power and will. The Church, which is of divine origin, is therefore higher than the state. The state, in itself, is only a body which is dead until a soul is infused into it. This soul is the Church. The state is like the moon, an opaque body, which needs to be illumined by the Church. Christ gave to Peter the government over all the world, and the pope is the legitimate successor of Peter. To him, therefore, belongs the final decision in all affairs, and in particular the decision as to who is to govern the states. All the decrees of secular rulers require the sanction of the popes. But neither Innocent nor any of the following popes suc-

ceeded in carrying out these theories fully in practice. The emperors and kings, aided in general by the laity and a large number of the clergy, opposed the papal claims, in spite of all the excommunications which were hurled against them. Even men like Bernard of Clairvaux expressed their dissent from these ultrapapal theories. The last pope who endeavored to enforce these claims was Boniface VIII, who, in his notorious bull, *Unam Sanctam*, maintained it to be necessary for salvation to believe that the Roman popes had power over everything on earth. Boniface had to pay for this extraordinary assumption of power with imprisonment and ill-treatment which caused his death. The transfer of the papal see to Avignon, and subsequently the Great Schism, were fatal blows to the practical execution of the mediæval theory of Church and State, although the theory itself was never formally renounced, and the notorious bull, *Unam Sanctam*, of Boniface VIII, which, as far as France was concerned, had been revoked by one of the Avignon popes (Clement V), was formally restored by Leo X in 1516. But the popes had not sufficient power to prevent the emperors and kings from passing laws by which the rights of the state governments were enlarged, and many salutary reforms introduced into the churches.

7. *From the Reformation to the present time.*—The great reformers of the 16th century—Luther, Calvin, Zwinglius, Melancthon, and others—were all agreed in condemning the confusion by the Church of Rome of spiritual and secular power. They all insisted on keeping the two powers apart, and especially in their earlier writings favored the self-government of the Church. But these views were not consistently carried through. As all the bishops opposed the reform of the Church, the princes and the municipal governments were invited by the reformers to see to the execution of the Church reform, and to the reconstruction of the Reformed churches. No provision being made for a common bond of union between the Reformed churches in different countries, the power of the state government in each particular country over the Church grew almost without opposition. To this must be added that most of the reformers adhered to the idea of a Christian state whose authorities were invested with the right to punish those who denied the fundamental doctrines of Christianity. See *SERVETUS*. Thus State-Churchism was established in all the Lutheran and Reformed countries, and developed the more rapidly, as the churches had never so powerful a representative as the Church of Rome had had during the Middle Ages. The constant efforts of the Roman Catholic states to root out Protestantism by force naturally led to retaliatory measures on the part of Protestant princes, and thus the dangerous principle came gradually to be developed, *Cujus regio ejus religio* (the religion of a country must conform to that of the prince). The application of this principle led, on the one hand, to many and bloody wars, but, on the other, it induced the Roman Catholic princes to claim, like the Protestant princes, a greater influence over religious affairs than the popes had ever conceded during the Middle Ages. The success of the Reformation had shown the weakness of the popes, and their opposition to the radical changes in the relation of the Church of Rome to the states was more nominal than efficient. The last coronation of an emperor of the West by the pope was that of Charles V in 1530. The popes protested in 1648 against the peace of Westphalia, in 1701 against the creation of a kingdom of Prussia, and in 1815 against the treaty of Vienna, but all these and similar acts had no influence whatever.

The growth of rationalism and infidelity in the 17th and 18th centuries accustomed princes and statesmen to regard the churches as part of the state organism, and just as absolutely subject to the government of every territory as the civil administration. This is the

era of the territorial system, the period of the greatest debasement of the Christian churches. Nearly all the Church assemblies, viz. the convocations in England; the national synods and general assemblies of the Protestant churches in France, Germany, and other countries; the national, provincial, and diocesan synods of the Church of Rome, were forbidden, or fell into general disuse. In the Church of Rome, during this period, the claims of the pope were not only denied by the state governments, but strenuous efforts were made in France, Germany, Italy, and other countries to reduce the papal prerogatives in matters purely ecclesiastical, and to increase that of the bishops and of the national churches. These efforts, however, were less successful than those of the state governments.

The French Revolution of 1789 shook the structure of society of Europe, political as well as ecclesiastical, to its very foundations. The principles of the Revolution did not prevail, but the governments of Europe saw the necessity of reconstructing the administration of the states. Several important changes date from the Congress of Vienna in 1815. The long alliances of Protestant and Roman Catholic governments in the war against France, and the territorial changes introduced by the Congress of Vienna, led to an interchange of toleration, as far as the Lutheran, Reformed, and Roman Catholic churches were concerned. Some states recognised all three as state churches, entitled to support by the state governments; and in most of the others there was at least a gradual approach to giving to the members of the three churches equality of political rights. The relation of the Roman Catholic Church, in both Roman Catholic and Protestant countries, to the pope was regulated by concordats and conventions [see *CONCORDATS*], which stipulated what rights the state governments should allow the pope to exercise upon the Church of a particular country, and what influence the state governments (even the Protestant) should have upon the election of bishops, the appointment of other ecclesiastical dignitaries, the direction of Roman Catholic schools, the management of Church property, and other denominational affairs. In the Protestant churches, a consciousness awoke of the unworthy servitude into which the Church had been forced in the 17th and 18th centuries, and the demand grew stronger and stronger for the restoration of at least a part of the self-government of the churches, by means of convocations, synods, assemblies, and councils. A new impulse was given to these demands by the revolutionary movements of the year 1848, and by the agitation for political reforms which has since been going on in nearly all the European states. The regular convocation of elective Church assemblies, and the transfer to them of a greater or lesser part of the government of the Church, has, since 1848, been the general tendency in all the Protestant churches of Europe. As regards the Church of Rome, public opinion more and more declared itself against the conclusion of concordats, and in favor of a regulation of the Roman Catholic affairs of every particular country by special laws, due regard being had to the recognition by the Roman Catholics of the pope as the head of the Church.

While the Lutheran and Reformed churches assumed almost from their very beginning the character of state churches, a number of minor sects sprang up in the 16th and the following centuries, which, meeting, on the hand of the state governments, with nothing but persecution, were led to demand from the state not only toleration for themselves, but freedom of religious belief in general. Especially was this the case in England, where the Nonconformists gained greater strength and influence than any dissenters on the Continent of Europe, and became true pioneers of the principle of a complete separation between Church and state. Persecution drove many of the dissenters to the New World, and here their principles found a genial soil. In some of the colonies Church and State

were united, more or less closely, until after the Revolution. At the declaration of independence, the United States established the absolute separation of Church and State, and the legal equality of all forms of belief, as fundamental institutions. The United States have always remained true to this principle, and in the several states of the Union it is now practically carried out. The prosperous growth of the free American churches, and their influence upon society, has had great effect upon opinion in the Old World. The experience of America has largely added to the number of the friends of free churches in Europe. The number of dissenting churches which claim absolute independence of the state is everywhere on the increase, and with them sympathise a large political party of Radicals, who make entire separation between Church and State a part of their political platform. In 1848, the principle of separation of Church and State was formally acknowledged in the new constitutions of France, Austria, Prussia, and other states. This triumph of the American principle was of only short duration; but none of the European countries have since ceased to have a large political party which aims at conforming legislation on Church affairs to that of the United States, and at carrying through the principle of entire separation between Church and State. It is a very remarkable fact that even men like Dr. Pusey have of late shown themselves favorable to the separation of Church and State, in order to put an end to the servile condition of the Church. One of the most prominent Protestant statesmen and writers of France, Count de Gasparin, speaks on the subject as follows: "Let no one be surprised at the extreme importance I attach to the separation of Church and State. For two centuries past the Church and society have been at war. In abolishing the unjust and worn-out pretences of both Church and State, their separation would give both to the Church and to society the peace they require. It would seem nowadays as though the citizen and the Christian were two different persons, having different rights and different duties. The Christian is taught to curse liberty as the poisonous fruit of philoSophy and revolution; the citizen is taught to look upon the Church as the natural enemy of modern institutions. Thus arises a sullen enmity, a deep-rooted anxiousness in the minds of the people, and, so to speak, two nations within the same society. Yet nothing would be more erroneous than this distinction. Christianity is so far from being the enemy of free institutions, that these institutions have never existed but in Christian countries; the nations which obey the law of Brahma, of Buddha, and of Mohammed, know of no other form of government than despotism. Liberty is the fruit of the Gospel; it proceeds from the only religion which intrusts the individual with the care and the salvation of his own soul; materialism kills it, faith makes it live; and, in return, by an intimate and mysterious connection, despotism kills faith, liberty nourishes it. What is this opposition which divides the Church and society? Nothing but a misunderstanding, whose mist shall disappear before the sun of liberty. The ideal of the Christian is also the ideal of the citizen. The state would gain no less than the Church by their mutual independence. We never attempt with impunity to rule that which God has created to be free. For two centuries the state has dragged on the Church, or has been dragged by it; the result was mutual suffering and mutual servitude. Separation restores each to its proper place. The state has no longer but citizens to deal with; it has no longer to fear the murmurs of conscience, or those invisible enemies which sap and weaken its foundations. Free in its action, authority gains both in strength and in respect; the vestry-quarrel, which are the plague of all state religions, are at an end. Union made the Church the enemy of the state, separation makes them friends. Conscience revolts against the hand of the state, it

loves a power which guarantees it freedom." See TOLERATION.

Among the Liberal party of the Roman Catholic countries of Europe the principle of a separation between Church and State has likewise found many advocates. Of the great statesmen of Europe in modern times, few have given so cordial an adhesion to the principle as count Cavour, who, during his whole political career, stood up for a free Church in a free state; and baron Ricasoli, whose famous letter to the Italian bishops, dated Nov. 26, 1866, is a complete commentary on the subject, and a document which, in the history of European State-Churchism, will remain of lasting importance. We give the following extract from it: "The decisions adopted by the government arise from the desire that perfect liberty in the relations between Church and State should pass from the abstract religion of principle in which it had hitherto remained into the reality of fact. The government, therefore, desires that Italy may very soon enjoy the magnificent and imposing religious spectacle now afforded to the free citizens of the United States of America by the National Council of Baltimore, wherein religious doctrines are freely discussed, and whose decisions, approved by the pope, will be proclaimed and executed in every town and village without *exequatur* or *placet*. It is liberty which has produced this admirable spectacle; liberty, professed and respected by all, in principle and in fact, in its amplest application to civil, political, and social life. In the United States every citizen is free to follow the persuasion that he may think best, and to worship the Divinity in the form that may seem to him most appropriate. Side by side with the Catholic Church rises the Protestant temple, the Mussulman mosque, the Chinese pagoda. Side by side with the Romish clergy the Genevan consistory and the Methodist assembly exercise their office. This state of things generates neither confusion nor clashing. And why is this? Because no religion asks either special protection or privileges from the state. Each lives, develops, and is followed under the protection of the common law, and the law, equally respected by all, guarantees to all an equal liberty. The Italian government wishes to demonstrate as far as possible that it has faith in liberty, and is desirous of applying it to the greatest extent compatible with the interests of public order. It therefore calls upon the bishops to return to their sees whence they were removed by those very motives of public order. It makes no conditions save that one incumbent upon every citizen who desires to live peaceably—namely, that he should confine himself to his own duty and observe the laws. The state will insure that he be neither disturbed nor hindered; but let him not demand privileges if he wishes no bonds. The principle of every free state, that the law is equal for all, admits of no distinctions of any kind. The government would be glad to cast off all suspicion and abandon every precaution, and if it does not now wholly act up to this wish, it is because the principle of liberty which it has adopted and put into practice is not equally adopted and practised by the clergy. Let your lordships remark the difference between the condition of the Church in America and the condition of the Church in Europe. In those virgin regions the Church is established amid a new society, but which carried with it from the mother country all the elements of civil life. Representing the purest and most sacred of the social elements, the religious feeling which sanctions right, and sanctifies duty, and carries human aspirations far above all earthly things, the Church has here sought only the empire pleasing to God, the empire of souls. Companion of liberty, the Church has grown beneath its shelter, and has found all that sufficed for free development and the tranquil and fecund exercise of its ministry. It has never sought to deny to others the liberty which it enjoyed, nor to turn to its exclusive advantage the in-

stitutions which protected it. In Europe, on the other hand, the Church arose with the decadence of the great empire that had subjugated the earth. It was constituted amid the political and social cataclysms of the barbarous ages, and was compelled to form an organization strong enough to resist the shipwreck of all civilization amid the rising flood of brute force and violence. But while the world, emerging from the chaos of the Middle Ages, re-entered the path of progress marked out by God, the Church impressed upon all having any relation with it the immobility of the dogma intrusted to its guardianship. It viewed with suspicion the growth of intelligence and the multiplication of social forces, and declared itself the enemy of all liberty, denying the first and most incontestable of all, the liberty of conscience. Hence arose the conflict between the ecclesiastical and the civil power, since the former represented subjection and immobility, and the latter liberty and progress. The conflict, from peculiar circumstances, has greater proportions in Italy, because the Church, thinking that a kingdom was necessary to the independent exercise of its spiritual ministry, found that kingdom in Italy. The ecclesiastical power, from the same reason, is here in contradiction not only with the civil power, but national right. The bishops cannot be considered among us as simple pastors of souls, since they are at the same time the instruments and defenders of a power at variance with the national aspirations. The civil power is therefore constrained to impose those measures upon the bishops which are necessary to preserve its rights and those of the nation. How is it possible to terminate this deplorable and perilous conflict between the two powers—between Church and state? Let us 'render unto Cæsar the things that are Cæsar's, and unto God the things that are God's,' and peace between Church and state will be troubled no more."

See Herzog, *Real-Encyclop.* vol. xix (Suppl.), s. v. *Staat und Kirche*; a complete history of the relation of the Christian Church to the state was begun by Riffel (Rom. Cath.), but not completed (*Geschichtliche Darstellung der Verhältnisse zwischen Kirche und Staat*, vol. i, Mainz, 1836, embracing the time from the foundation of Christianity to Justinian I); Vinet, *Essai sur la manifestation des conceptions religieuses et sur la séparation de l'église et de l'état envisagée comme conséquence nécessaire et comme garantie du principe* (Paris, 1842; translated into English, Lond. 1843, 12mo); Laurent, *L'Eglise et l'Etat*; Hundeshagen, *Ueber einige Hauptmomente in der geschichtlichen Entwicklung des Verhältnisses zwischen Staat und Kirche*, in Dove's *Zeitschrift für Kirchenrecht*, vol. i (Berlin, 1861); Rocovány (Rom. Cath.), *Monumenta Catholica pro independentia ecclesie ex potestate civili*, tom. i (Quinque Ecclesie, 1847); Richter, *Geschichte der evangel. Kirchenverfassung in Deutschland* (Leipzig, 1851); the manuals of Church law (*Kirchenrecht*) by Richter, Walter, Phillips, and others. Lord Montague pleads for the State Church in *The Four Experiments in Church and State* (London, 1863), maintaining that only four forms of Church and State are possible: 1. When the Church is identical with the state, i. e. when it is a national Church; 2. When the Church is under the state; 3. When the Church overrides the state; 4. When there is no Church at all. In the author's opinion, the national is the only normal form of Church and state. In each of the other forms the Church and state are depraved. See also Dupin, *Traité de la Puissance ecclésiastique et temporelle* (Paris, 1707); Dupin's *Manuel du Droit Ecclésiastique* (Paris, 4th ed. 1845; claiming the rights of Roman Catholic state governments over the Church of Rome); Zacharias, *Einheit des Staats und der Kirche* (1797); De Maistre, *Du Pape* (the most celebrated defense of ultra-papal theories); Archbishop Wake, *The Authority of Princes*; Warburton, *Alliance of Church and State* (1786); Hobbes, *Leviathan* (1608); Gladstone, *State in Relation to Church* (2 vols. 4th ed.

1841); Pusey, *Royal Supremacy* (1847); Coleridge, *Constitution of Church and State* (1890); Chalmers, *National Churches* (1838); Vincent, *Protestantism in France*, p. 190; Brownson's *Review* (Rom. Cath.), Oct. 1854; Dexter, *Congregationalism* (Bost. 1865), p. 209; D'Aubigné, *Essays* (N. Y. ed.), p. 239; Palmer, *On the Church*, ii, 291 sq.; *Church of England Quarterly*, Jan. 1855, art. vi; Schaff, *Church History*, ii, 90, 856; Calvin, *Institutes*, bk. iv, ch. 20; *English Review*, vol. xi and foll. (many articles); *Catholic World*, April, 1867, art. i; Wardlaw, *On Church Establishments* (London, 1839, 8vo); Noel, *On the Union of Church and State* (N. Y. 1849, 12mo); Cunningham, *Discussion of Church Principles* (Edinb. 1868, 8vo).

CHURCH, ARMENIAN. See ARMENIAN CHURCH.

CHURCH, ASSOCIATE. See PRESBYTERIAN (ASSOCIATE) CHURCH.

CHURCH, BAPTIST. See BAPTISTS.

CHURCH, CATHOLIC APOSTOLIC. See CATHOLIC APOSTOLIC CHURCH.

CHURCH, CONGREGATIONAL. See CONGREGATIONALISTS.

CHURCH CONGRESS, a name given to free gatherings of ministers and laymen of the Established Church of England, which since 1861 have annually been held for the purpose of discussing important religious and ecclesiastical questions. The first congress was convoked by a self-constituted committee, which invited men of all theological parties to be present. In order to maintain the neutral character of the Church Congress, no resolutions were to be passed. Although this original plan has been adhered to, the High-Church party has been in an unmistakable ascendancy at all the congresses, and the Low-Church party, on that account, in 1866, formed a design (not yet executed) of calling a separate Low-Church Congress. The congresses held from 1861 to 1866 were as follows: 1861, Canterbury; 1862, Oxford; 1863, Manchester; 1864, Bristol; 1865, Norwich; 1866, York. At each of these congresses the bishop of the diocese presided. The attendance in every case was large, and a number of bishops, and prominent clergymen and laymen, took part in the proceedings. A curious difficulty stood in the way of the congress of 1865, which deserves mention, as it shows the relation of the bishops of England to these meetings. When it was resolved by the congress of 1864 (at Bristol) to hold the next one at Norwich, it was understood that the sanction and co-operation of the bishop of that city had been obtained. But this proved to be a mistake; and when the bishop was applied to by the official residuum of the congress, he did not consider the authority of the persons constituting it sufficient to entitle them to his consideration. The request from a public meeting, and a vote taken in the diocese of Norwich on the subject, was deemed no more sufficient. Only when the chapter of Norwich (including the honorary canons) had declared in favor of the congress, the bishop consented to preside. See Rivington's *Ecclesiastical Year-book for 1865* (London, 1866). The "Year-book" gives, at p. 135 to 172, a full account of the Congress of Norwich). The full proceedings of each meeting of the congress have been published in a special report.

CHURCH, CONSTITUTION OF. See ECCLESIASTICAL POLITY.

CHURCH, CUMBERLAND PRESBYTERIAN. See PRESBYTERIAN (CUMBERLAND) CHURCH.

CHURCH DIET (*Kirchenstag*), a name given to free gatherings of clergymen and laymen of the German Protestant state churches, held since 1848 for the discussion of religious and ecclesiastical questions. The Church Diets were called into existence in consequence of the revolutionary movements of the year 1848, which appeared to tend to a separation between Church and State, and to endanger the influence of the evangelical Church upon society. Members of

the Lutheran, the Reformed, and the United Evangelical churches took part, and the High Church "Confessionalists," under Stahl and Hengstenberg, worked hand in hand with the Evangelical party, under men like Nitzsch, Bethman-Hollweg, and others, at the first annual meetings of the Diet of Wittenberg (1848 and 1849), Stuttgart (1850), Elberfeld (1851), Bremen (1852), Berlin (1853), Frankfurt (1854), Lübeck (1856), Stuttgart (1857), Hamburg (1858). But in 1860 the former party did not appear, because the executive committee had refused to put the Disenter and the Civil Marriage questions on the programme of the meeting. Consequently, at the assembly of Barmen (1860), and the following ones at Brandenburg (1862) and Altenburg (1864), the Evangelical party (the "Consensus" party) was alone represented. Simultaneously with every meeting of the Church Diet has been held an assembly of the Congress for Home Missions. See HOME MISSIONS. The full proceedings of each meeting of the diet have been published in a special report. A briefer account is given in the annual *Kirchliche Chronik* by Matthes. See also Dorner, *Reform d. evangel. Landeskirchen* (1848); *Entstehung und Gesch. des Kirchentages* (1853).

CHURCH DISCIPLINE. See DISCIPLINE.

CHURCH, DUTCH REFORMED. See HOLLAND; REFORMED PROTESTANT DUTCH CHURCH.

CHURCH EDIFICES. Under *Architecture* (q. v.) a brief history has been given of the development of ecclesiastical architecture. The present article will contain various particulars concerning the history of some of the most prominent churches, their names, form, site, position, the arrangement of the interior, the outer buildings connected with the Church service, etc.

I. *History of the Erection of Churches.*—Until the second century Christians were not permitted to erect churches, but were compelled to worship in private houses, in the open fields, or, to escape persecution, in the Catacombs (q. v.) and other concealed places. On the suspension of persecution, we find, from A. D. 202 and forwards, notices of Church edifices in Nicomedia, Edessa (Odessa), and other cities. Diocletian issued an edict (A. D. 305) ordering all Christian churches to be razed to the ground. Under Constantine these were rebuilt, and great numbers of new ones erected over the whole Roman empire. Chief among them were the magnificent basilicas [see BASILICA] of St. Peter, St. Paul, and Maria Maggiore in Rome. The form of the buildings and the continuation of idolatry prevented the general changing into Christian houses of worship of the old pagan temples, many of which were destroyed. Still some of them were thus converted, especially after the time of Theodosius I, and the materials of others were largely used. Justinian I (A. D. 565) rebuilt twenty-four churches in Constantinople alone, and many other churches, cloisters, resting-places for pilgrims, and other religious buildings, over the entire empire of the Orient, and especially in Palestine. The church of St. Sophia (q. v.) he rebuilt with great beauty and splendor. This served as a pattern for Church edifices through the whole Christian world. Such was the splendor of the new St. Sophia that Justinian exclaimed, *Νεκικκά σε, Σολομών*, "I have surpassed thee, O Solomon!" The emperor appointed for the service of this church sixty presbyters, one hundred deacons, forty deaconesses, ninety sub-deacons, one hundred and ten readers, twenty-five singers, one hundred door-keepers, making five hundred and twenty-five of the clergy and attendants. From the death of Justinian (A. D. 575) to the eighth century but few Church buildings of great note were erected. During the reign of Charlemagne many churches were erected in North-western Europe. The belief that the world was to be destroyed in the year A. D. 1000 paralyzed all energy, and it was not till that year had passed that the great revival of all

departments of human activity called forth the spirit of princes and cities, as well as of the clergy, to the erection of the many grand monuments of ecclesiastical architecture that adorn the history of the Middle Ages. This zeal in church-building became so modified into a spirit of pride, ambition, and corruption during the fifteenth and sixteenth centuries as to become one of the chief causes that produced the Reformation. The system of selling indulgences to raise money for building churches, first introduced in the eleventh century, was carried to such excess in raising funds for rebuilding the gorgeous St. Peter's (q. v.), that the reformer had in this a most powerful argument in their contest with the Romish Church. In Europe, the building, repairing, and maintaining of edifices for the national churches is provided for entirely, or at least to a great extent, from the general national taxes. Other churches build their edifices by voluntary contributions. This is universally the case in the United States of America.

In the remainder of this article we chiefly follow Bingham, *Orig. Eccles.* bk. viii, ch. i), making use of Farrar's abridgment, with modifications and additions.

II. *The ancient Names of Churches.*—The word *dominicium*, or *domus Dei*, the Lord's house, occurs in the 4th century. Cyprian uses it to denote the Lord's day, and also the Lord's Supper; yet it is used by Jerome for a building set apart for divine worship. It answers to the Greek *ναὶακόν*. See CHURCH. *Domus Dei*, *domus ecclesie*, *domus divina*—that is, "the Lord's house," "the house of the church," "the house of God"—are expressions in frequent use from the third century. In Eusebius we have *οἶκος ἐκκλησίας*, *the house of the church*. *Domus divina*, the house of God, was a term employed to designate the palace of the Roman emperor; but the Christians transferred the appellation to their churches. Tertullian uses the name *domus columbar*, the house of the dove, or, as Mede explains it, the house of the dove-like religion, or the house of the dove-like disciples of Christ. As the Temple of God at Jerusalem is frequently in Scripture styled the house of prayer, so Christian churches are called *προσευκτήρια*, or *οἶκοι εὐκτήριου*, *oratories*, or *houses of prayer*. In later times these titles were appropriated to smaller or domestic chapels. Some early writers distinguish between *ἐκκλησιαστήριον* and *ἐκκλησία*, the former signifying the *building*, and the latter the *congregation*; but in the writings of Ignatius, Clement of Alexandria, Tertullian, Cyprian, and others, the word *ἐκκλησία* usually means the *building*, and at length became the current expression. *Basilica* was originally applied to the imperial palace, or public halls, and was not used to designate places of worship until Christian emperors had appropriated such buildings to the use of the Church. See BASILICA. *Ἀνάκτορον* is synonymous with *basilica*, and was occasionally applied to places of divine worship called by emperors. Churches were sometimes called *τίμῆ* (*τίμιον*), either from the inscription of dedication, or from the sign of the cross. The term *τρόπαια*, *tropaea*, occurs in Eusebius. The reason of this name is sought in the reported appearance of the cross to Constantine, and the *Labarum*, on which, according to Eusebius, was inscribed *τοῦ σταυροῦ τῶραιον*. *Μαρτύριον*, or *memoria*, denoted a church dedicated to the memory of a martyr. If the person in memory of whom the church was built was a prophet or an apostle, then the church respectively took the name *ἀποστολείον* and *προφήτειον*. In addition, we find at different times, and for various reasons, the following names given to Christian churches: *σπηνή*, *conciha*, *concihabula*, *conveciacula*, *οἶα*, *σύνοδοι*, *μοναστήριον*, *κοιμητήριον*, *εὐρυς Χριστι*, *ναός*, *νήσος*, and many others. The titles *sanctum* and *delubrum* were at all times rejected as profane.

Names of individual Churches.—Individual churches were, soon after the time of Constantine(?), dedicated to

certain saints, and called by the names of those saints. Some of the Protestant denominations name their church edifices after the apostles, but only for the purpose of distinction from each other. Puritans, and the churches influenced by them, name their churches by their ordinal numbers, as the first, second, etc., or by the street on which they are located. In the Methodist Church the names of the apostles are often used; and church edifices are sometimes named in honor of Wesley or some other distinguished leader in the Church.

III. *Forms of Churches.*—The earliest ground-forms were oblong. The basilicas (q. v.) were fashioned after the analogy of a ship, or perhaps, rather, after the oblong form had been settled upon by other influences—as of architectural convenience, etc.—that part of the church to receive believers was called the nave (*navis*, ship). This was afterward connected with allegorical or mystical meanings; e. g. to denote the dangers to which the Church was exposed, and the safety which it offered to its members. The boat of Peter and the ark of Noah were explained as emblematic of the Church in these two respects. On the other hand, the Byzantine churches, and many that were influenced by them, were round. During the Lombard, or early Round-arch period of architecture, the churches assumed the form of a cross. In the late Gothic they had the head of the cross bent, to represent the bowing of the head of the Saviour when he died: thus at Rouen (St. Ouen). The transepts of the cross often did not extend beyond the walls, not appearing at all in the external architecture.

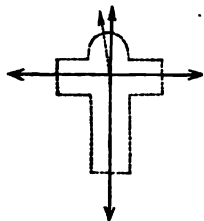

IV. *The Site.*—This was generally chosen on the summit of a mountain or other elevated place, for two reasons, viz. security and retirement from the bustle of the world, and a notion that elevated places were specially holy. The Temple of Solomon had been built on a hill; and the Christians remembered the expression, "I will lift up mine eyes to the hills, from whence cometh my help." At first, exposed situations were avoided; but when the impediment arising from persecution was removed, they were preferred. At other times they erected their churches over the graves of martyrs, and occasionally the cemeteries were used for devotional purposes. In the tenth and eleventh centuries there were many places of this kind called *κρυπταί*, *cryptas*.

V. *Aspect.*—The earliest churches faced eastward; at a later period (4th or 5th century) this was reversed, and the sacramental table was placed at the east, so that, in facing it in their devotions, they were turned towards the east. The Jewish custom was to turn to the west in prayer. "As the Jews began their day with the *setting sun*, so the followers of Christ began theirs with the *rising sun*. The eye of the Christian turned with peculiar interest to the east, in remembrance of the Morning Star, the Saviour, the Sun of Righteousness. This idea was mixed up with many religious observances. After baptism the newly-admitted members of the church were turned with their faces eastward; and the dead were usually buried in the same position, under the conviction that Christ at His second coming should appear in the east."

VI. *Internal Arrangement.*—No particular structure or arrangement of the interior prevailed during the first three centuries. From the fourth century we find uniformity prevailing in the *basilicas* both of the East and West. The body of the church was divided into three parts, corresponding with the threefold division of the Christians—into *clergy*, including the servants of the congregation; *faithful*, or *believers*; and *catechumens*. This arrangement was also in conformity with the division of the ancient Temple—into the holy of

holies, the sanctuary, and the court. The three parts were: 1. The *bema*, or sanctuary, in which the clergy officiated. 2. The *naos*, or nave, appropriated to the faithful, the lay-members of the church. 3. The *ναῦτες*, or ante-temple, the place of penitents and catechumens. Sometimes four or five divisions are enumerated: this arises from subdividing the narthex into outer and inner, and also reckoning the *εξέδρα*, or outer buildings, a portion of the church.

1. *The Bema, or Sanctuary.*—The inner part of the church appropriated to the clergy: from *βαίνειν*, for *ἀναβαίνειν*, to ascend. This name was sometimes given to the raised platform which supported the throne or chair of the bishop and the seats of the presbyters, and sometimes to the whole of that part of the church in which the platform and the altar stood. It was also called *ἅγιον*, *ἅγιασμα*, *ἅγιον ἁγίων*, the *holy*, or the *holy of holies*; *ἱερατεῖον* and *προσβυτήριον*, *presbytery*, because it was the place in which the presbyters sat and discharged their duties; *δυσιαστήριον*, because the altar stood here; *ἀδύτον*, *ἄβατον*, or more commonly in the plural, *ἄδύτα*, *ἄβατα*, *places not to be entered or trodden*, because laymen and females were not allowed to enter. Because kings and emperors were privileged with a seat within this inclosure, it was called *ἀνέκροτον*, *royal palace*. The platform of this part of the church was an elliptical recess, with a corresponding arch overhead, and separated from the nave by a rail curiously wrought like net-work, called *camelli*, *chancel*. Within were the bishop's throne, and subordinate seats right and left for the lower clergy. The bishop's throne was usually covered with a veil, and for this reason was called *cathedra velata*. In the middle stood the altar, in such a position as to be easily encompassed on every side. On one side of it was a small table for receiving oblations; on the other a recess, called *σκευοφυλάκιον*, into which the vessels were conveyed after the sacrament.

2. *The Nave.*—This was the main body of the church, and called by different names, derived from the uses to which it was applied. It was called the oratory of the people, because they there met for religious worship, reading the Scriptures, prayer, and hearing the word. It was also called the place of assembly, and the quadrangle, from its quadrangular form, in contrast with the elliptical form of the chancel. In a central position stood the *ambo*, *suggestum lectorum*, or reader's desk, elevated on a platform above the level of the surrounding seats. This was sometimes called the pulpit, and the tribunal of the church, in distinction from the *βῆμα*, or tribunal of the choir. The choristers were provided with seats near this desk. The seats on either side, in front, were occupied by the faithful, or the communicants. The gospels and epistles were chanted from before the altar. The sermon was also delivered by the preacher standing on the platform of the sanctuary, or on the steps leading to it. But when large churches were erected, it became difficult for the preacher to make himself heard from this position. To remedy this inconvenience, a platform was erected for him in front of the *bema*, within the body of the nave. The rules of the primitive churches required the separation of the sexes, and this was generally observed. The men occupied the left of the altar, on the south side of the church, and the women the right, on the north. They were separated by a veil, or lattice. In the Eastern churches the women occupied a gallery, while the men sat below. The catechumens occupied a part near to the believers, arranged in their several classes; but they were required to withdraw at the summons of the deacons—*ἴτε, catechumeni!* In the rear of the catechumens sat the penitents, who had been allowed a place again within the church. The walls of the church were surrounded by ante-chambers and recesses for the accommodation of the assembly, for meditation, reading, and prayer. There were aisles surrounding the nave which separated it

from the chambers. It was separated from the chancel by a partition or lattice-work, with a curtain, and the entrance to the choir was by folding-doors in this partition. These doors were provided with curtains, which, as well as the larger curtain, called *κατακίτασμα* and *κατακίτασμα μυστικόν*, were drawn aside during the celebration of the Eucharist, and during the delivery of the sermon.

8. *The Narthex, or Ante-temple.*—This was the outer division within the walls. It was called *πρόναος*, *ante-temple*; *πρόκυλα*, *portico*; and *νάθηξ*, or *ferula*. The latter name is supposed to have been given it in consequence of its oblong shape, resembling in this respect a *ferula*, or rod. It was an oblong section of the building, extending quite across the front of the church.

It was entered by three doors leading from the outer porch. The great entrance was at the west, opposite to the altar; it was called (after the corresponding part of the temple) *ἄραια* or *βασιλική*, the *beautiful* or *royal gate*. The *vestibula*, or *πρόναος*, in the stricter sense, was allotted to the catechumens and penitents. Heretics and unbelievers were also allowed a place here, though this was forbidden by some Eastern synods. The *πρόκυλα*, or *portico*, was chiefly used for the performance of funerals. But, in the larger churches, meetings on ecclesiastical affairs were held in it. The primitive Christians were accustomed to wash before entering a church, as a symbol of the purity becoming that holy place. In due time the vessel used for that purpose was introduced into the porch. The vessel

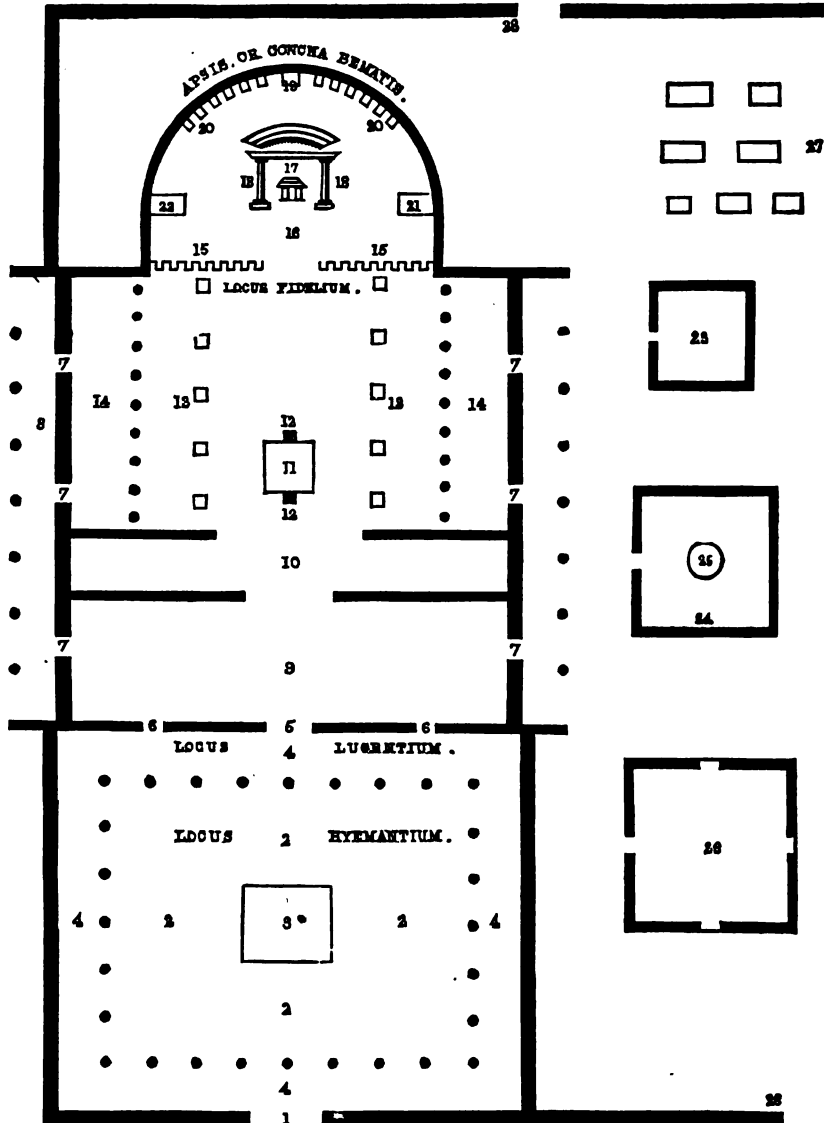

Plan of an ancient Basilica, with its Exedra.

1. *Propylæum, or vestibulum magnum*, the great porch, or first entrance into the area before the church.
2. *The atrium*, or area leading from the porch to the church.
3. *Cantinaris, or pátela*: the fountain of water in the middle of the square.
4. The porticoes, or cloisters about the area, otherwise called the exterior *narthex* of the church, and places of mourners.
5. The great gate into the church.
6. The two smaller gates on each side of the other.
7. The northern and southern gates.
8. The cloisters on the north and south sides of the church.
9. The inner *narthex*, where the catechumens and hearers stood.
10. The place of the *substanti*, behind the *ambo*.
11. The *ambo*, or reading-desk.
12. The ascent on both sides of the *ambo*.
13. The inner porticoes, or cloisters for men below.
14. The *catechumenaria*, or *lyceæ*, upper galleries for women, above the porticoes of the men, upon pillars.
15. *Canelli sematis*, the rails of the chancel.
16. *Bema*, or chancel.
17. The altar, or communion-table.
18. The arched canopy over the altar.
19. The bishop's throne.
20. The seats of presbyters, in a semicircle about the altar.
21. *Diacoenium subæ*, the inner vesty.
22. *Prothæsis, or paratorium*.
23. *Diacoenium magnum*, the great repository, or greeting-house.
24. The baptistery.
25. The font.
26. *Psalteria*, dwelling-houses, libraries, school-rooms, etc.
27. *Exedra*, outer buildings.
28. *Περίβολος*, the outermost boundary allowed for refuge, or sanctuary.

was called *κρήνη, φιάλη, φρέαρ, κολυμβήθιον, λεοντάμιον, contharus*.

VII. *The outer Buildings, or Exedrae.*—All the buildings attached to the church, such as courts, side-buildings, wings, and other erections and places in the area connected with it, were called *exedrae*. The enclosure around the church was known by the names *περίβολος, στοά, περιστύλιον, τετραστύλιον, τετραστυλιον, ambulus, peristylia*. The open space between the extreme circumference and the church is called by Eusebius *αἶθρον, impluvium*, but is no other than the Latin *atrium*, and is synonymous with the word *area*. In this space stood the emergentums, and that class of penitents called *προσέλαιωντες, or penites*. They were also called *χειμάζοντες, or χειμαζόμενοι*, from the circumstance of their standing in the open air, exposed to all the changes of the weather. The most important of the *exedrae* were the *baptisteries*. In these places the candidates were instructed and prepared for baptism, and there were separate apartments for men and women: here also councils and ecclesiastical meetings were held, and hence it may be inferred that they were of capacious dimensions. These baptisteries were not attached to all churches, but were generally erected adjacent to cathedral churches, denominated, on this account, *baptismal* and *central* churches. There were also several other smaller buildings, such as the *diaconicum magnum*, in which the sacred utensils, and the ornaments and robes of the clergy, were kept. This was called *κειμηλιαρχεῖον, γαζοφυλάκιον, σκευοφυλάκιον*. Here the clergy were accustomed to retire for private exercises preparatory to the public services: hence it was called *secretum, or secretarium*. It was also a general audience-room, and denominated *salutatorium, receptorium*. Many are of the opinion that the building was used as a prison for the confinement of delinquent clergymen. There was another class of buildings called *pastophoria*. This is a word borrowed from the Septuagint translation of Ezek. xl, 17, where it denotes the chambers in the outer courts of the Temple. Learned men are divided in opinion as to the uses of the *pastophoria*: some suppose them to have been watch-houses, others apartments for the accommodation of the clergy. Libraries were attached to many churches. In these collections were included not only the liturgical and other church-books, and the manuscript copies of the holy Scriptures, in the original languages and translations, but also homilies, *catecheses*, and other theological works. From the libraries of Jerusalem and Caesarea, both Eusebius and Jerome chiefly derived the materials for their writings. Schools were, in later times, established in connection with some churches. If no building was provided for the purpose, the catechumens, or younger clergy, were taught in the baptistery or vestry. Other buildings were *οικοί βασιλικοί, the habitations of the bishop and clergy; λουτρά, baths; ἀνακαμπτήρια, lodging-places*, supposed by some to have been a kind of inn, by others a common place of resort for rest or recreation.

Doors.—Churches were usually provided with three doors, in imitation of the Temple. The principal entrance was called *πύλη*,

and *πύλη ὤραια* or *βασιλική*. They were sometimes made of brass, and often richly ornamented. The date of the building or dedication of the church was usually inscribed on the door. Sometimes a motto was affixed, a doctrinal sentiment, a prayer, or doxology. Later, the doors were often of bronze, ornamented with Biblical scenes, etc. In the early Round-arch period (A.D. 700-1000) the columns beside the doors usually rested on the backs of crouching lions, griffins, or other real or imaginary animals, who symbolized a guardianship of the entrance to the church.

The doorway was often highly ornamented with clusters of beautifully-wrought columns, and with a correspondingly decorated arched way overhead. This arch later contained angels or saints sculptured in the stone.

Pavements.—From the fourth century downwards, great attention was paid to the pavement of the church. In large churches, the narthex had a pavement of plaster; the nave one of wood; and the sanctuary, or part immediately around the high altar, was adorned with a tessellated pavement of polished and parti-colored marble, constituting a rich mosaic work.

Windows.—The Christian churches from the first were well provided with windows. It is customary to refer the origin of glass to the third century; but this is incorrect. The Phœnicians, Egyptians, Greeks, and Romans used glass long before the Christian era. (See GLASS.) In France, windows of both colored and cut glass were in use in the sixth century.

The following statement with regard to the mediæval and more modern churches and cathedrals is taken from Chambers, *Encyclopædia*, s. v.

“In the larger and more complete churches, the nave, and frequently also the choir, are divided longitudinally by two rows of pillars into three portions, the portion at each side being generally somewhat narrower and less lofty than that in the centre. These side por-

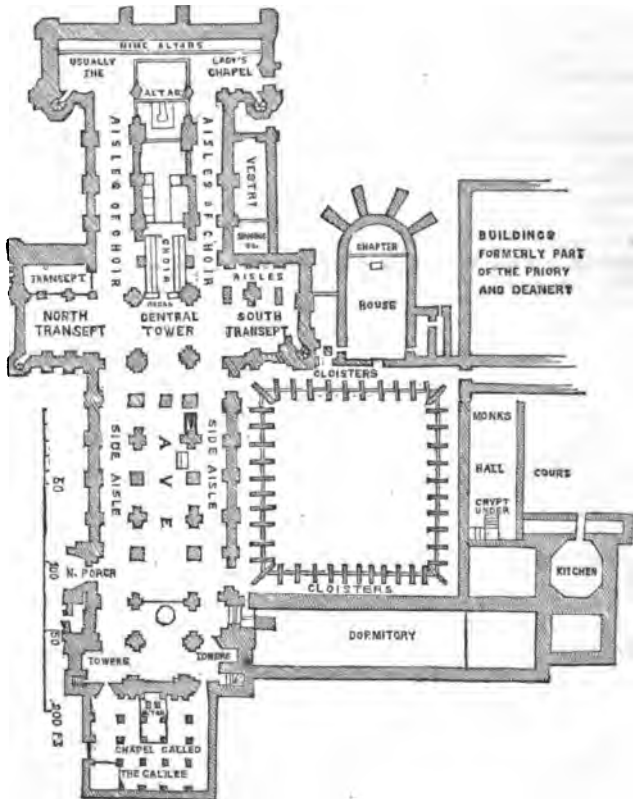

Plan of Durham Cathedral.

tions are called the aisles of the nave, or of the choir, as the case may be. In some churches the aisles are continued along the transepts, thus running round the whole church; in others there are double aisles to the nave, or to both nave and choir, or even to nave, choir, and transept. Behind, or to the east of the choir, is situated the 'Chapel of the Virgin,' with sometimes a number of altars; and it is not unusual for side chapels to be placed at different places along the aisles. These usually contain the tombs of the founder, and of other benefactors to, or dignitaries connected with, the church. The extent to which these adjuncts exist depends on the size and importance of the church, and they are scarcely ever alike in two churches, either in number, form, or position. Vestries for the use of the priests and choristers generally exist in connection with the choir. Along the sides of the choir are ranged richly-ornamented seats or stalls, usually of carved oak, surmounted with tracery, arches, and pinnacles; and among these seats, in the case of a bishop's church, the highest and most conspicuous is the so-called *caathedra*, or seat for the bishop, from which the cathedral takes its name. The larger English cathedral and abbey-churches have usually a chapter-house attached to them, which is of various forms, most commonly octagonal, and is often one of the richest and most beautiful portions of the whole edifice. On the Continent, chapter-houses are not so common, the chapter (q. v.) being usually held in the cathedral itself, or in one of the chapels attached to it. Cloisters (q. v.) are also frequent, and not unusually the sides of those which are farthest removed from the church or chapter-house are enclosed by other buildings connected with the establishment, such as a library, and places of residence for some of the officials of the cathedral. It is here that, in Roman Catholic churches, the hall, dormitories, and kitchens for the monks are commonly placed. Beneath the church there is frequently a crypt (q. v.). In some cathedral churches, the crypt is in reality a second underground church of great size and beauty. The baptistery (q. v.) is another adjunct to the church, though frequently forming a building altogether detached. Most of the parts of the church which we have mentioned may be traced on the annexed ground-plan of Durham Cathedral, but it must not be supposed that their position is always that which is there represented. The position of the nave, choir, or chancel, aisles and transepts, are nearly invariable, but the other portions vary, and are scarcely alike in two churches." Modern Church edifices vary greatly in form, structure, and arrangements. See Bingham, *Orig. Eccles.* bk. viii; Coleman, *Christian Antiquities*, ch. xiii; also Siegel, *Handbuch der christlich-kirchlichen Alterthümer*, ii, 366, 427, and references there. On the adaptation of ancient art to modern Church architecture, and its dangers, see Cloese, *Church Architecture Scripturally considered* (Lond. 1844, 8vo); T. K. Arnold, *Remarks on Cloese's Church Architecture* (London, 1844); and a series of articles on Church architecture in the *Christian's Monthly Magazine* (Lond. 1844, 1845); Milman, *History of Latin Christianity*, vol. viii, ch. viii.

CHURCH, EVANGELICAL. See PRUSSIA.

CHURCH FATHERS. See FATHERS.

CHURCH, FRENCH REFORMED. See FRANCE, REFORMED CHURCH OF.

CHURCH, GALLICAN. See GALLICAN CHURCH.

CHURCH, GERMAN REFORMED. See GERMAN REFORMED CHURCH.

CHURCH, GREEK. See GREEK CHURCH; RUSSIA.

CHURCH HISTORY. See ECCLESIASTICAL HISTORY.

CHURCH, LUTHERAN. See LUTHERAN CHURCH.

CHURCH, METHODIST (EPISCOPAL AND OTHER). See METHODISTS.

CHURCH MISSIONARY SOCIETY. See MISSIONARY SOCIETIES.

CHURCH, MORAVIAN. See MORAVIANS.

CHURCH MUSIC. See MUSIC; PSALMODY.

CHURCH, NEW JERUSALEM. See SWEDENBORGIANS; NEW JERUSALEM.

CHURCH OF ENGLAND. See ENGLAND, CHURCH OF.

CHURCH OF GOD, a denomination of Baptists in the United States, organized in 1830 by John Winebrenner, formerly a minister of the German Reformed Church at Harrisburg, Pa.

I. History.—During the period of Winebrenner's pastorate, revivals of religion were frequent within the bounds of his charge, and extended from it gradually to other churches and congregations, although some ministers of the German Reformed Church opposed the movement. As, in the mean time, Mr. Winebrenner's sentiments in regard to theology and church government underwent a change, and other preachers were raised up from among the converts whose views agreed with his, a call was made in 1830 for a Convention to organize an association. Mr. Winebrenner was chosen moderator of the Convention, and it was resolved to form a separate denomination, under the name "*Church of God.*" The Church took root chiefly in Pennsylvania and the Western States, having (in 1867) no eldership in the New England States and in New York, and but one eldership in the Southern-Texas. The latter, at the beginning of the war, separated from the General Eldership because of the anti-slavery doctrines professed by it. At an annual meeting held in 1866, the Texas eldership expressed a desire to reunite with the General Eldership, but no definite resolutions were passed.

The eighth triennial General Eldership of the Church was held at Decatur, Illinois, on May 31, 1866, and the following days. The following Annual Elderships were represented: East Pennsylvania, West Pennsylvania, East Ohio, West Ohio, Indiana, Southern Indiana and Illinois, Iowa, German, Michigan. A. F. Shoemaker was elected speaker. Centralia College, in Kansas, was recognised as an institution of the Church, and it was resolved to establish another college in Ohio, West Pennsylvania, Indiana, or Illinois. The subscription list of the weekly denominational organ, the *Church Advocate*, was reported to be 2700, and resolutions were passed in favor of the establishment of a Sunday-school paper by the Board of Publication, and of a German paper by Rev. J. F. Weishampel. A series of resolutions was also adopted on the duty of loyalty, against slavery, and in favor of equal rights of all men, irrespective of color.

II. Doctrines.—(Gorrie, cited below.) The following is a full statement of the views of the denomination:

1. She believes the Bible, or the canonical books of the Old and New Testament, to be the Word of God, a revelation from God to man, and the only authoritative rule of faith and practice.

2. She believes in one Supreme God, consisting of Father, Son, and Holy Spirit, and that these three are co-equal and co-eternal.

3. She believes in the fall and depravity of man; that is to say, that man by nature is destitute of the favor and image of God.

4. She believes in the redemption of man through the atonement, or vicarious sacrifice of Jesus Christ.

5. She believes in the gifts and office-work of the Holy Spirit; that is, in the enlightening, regenerating, and sanctifying influence and power of the Spirit.

6. She believes in the free moral agency of man; that he has moral ability, because commanded to repent and believe. In order to be saved; and that the doctrine of unconditional election and reprobation has no foundation in the oracles of God.

7. She believes that man is justified by faith in Christ and not by the works of law, or by works of his own righteousness.

8. She believes in the necessity of regeneration, or the new birth; or in the change of man's moral nature, after the image of God, by the influence and power of the word and Spirit of God, through faith in Christ Jesus.

9. She believes in three positive ordinances of perpetual

standing in the Church, viz. Baptism, Feet-washing, and the Lord's Supper.

10. She believes two things essential to the validity of baptism, viz. faith and immersion—that faith should always precede immersion; and that where either is wanting there can be no scriptural baptism.

11. She believes that the ordinance of feet-washing, that is, the literal washing of the saints' feet, according to the words and example of Christ, is obligatory upon all Christians, and ought to be observed by all the churches of God.

12. She believes that the Lord's Supper should be often administered, and, to be constant, to Christians only, in a sitting posture, and always in the evening.

13. She believes in the institution of the Lord's day, or Christian Sabbath, as a day of rest and religious worship.

14. She believes that the reading and preaching of God's word, the singing of psalms and hymns and spiritual songs, and the offering up of prayers, are ordained of God, and ought to be regularly and devoutly observed by all the people and churches of God.

15. She believes in the propriety and utility of holding fast-days, experience meetings, anxious meetings, camp-meetings, and other special meetings of united and protracted efforts for the edification of the Church and the conversion of sinners.

16. She believes that the Gospel ministry, Sabbath-schools, education, the religious press, the Bible, missionary, temperance, and all other benevolent causes, ought to be heartily supported.

17. She believes that the Church ought to relieve and take care of her own poor saints, supernumerated ministers, widows, and orphans.

18. She believes that the manufacture, traffic, and use of ardent spirits as a beverage or common drink, is injurious and immoral, and ought to be abandoned.

19. She believes the system or institution of involuntary slavery to be impolitic or unchristian.

20. She believes that all civil wars are unholly and sinful, and in which the saints of the Most High ought never to participate.

21. She believes that civil governments are ordained of God for the general good; that Christians ought to be subject to the same in all things, except what is manifestly unscriptural; and that appeals to the law, out of the Church, for justice and the adjustment of civil rights, are not inconsistent with the principles and duties of the Christian religion.

22. She believes in the necessity of a virtuous and holy life, and that Christ will save those only who obey him.

23. She believes in the visibility, unity, sanctity, universality, and perpetuity of the Church of God.

24. She believes in the personal coming and reign of Jesus Christ.

25. She believes in the resurrection of the dead, "both of the just and the unjust;" that the resurrection of the just will precede the resurrection of the unjust.

26. She believes in the creation of new heavens and a new earth.

27. She believes in the immortality of the soul; in a universal and eternal judgment; and in future and everlasting rewards and punishments.

III. *Church Government.*—"In church government this body is independent and congregational; yet the members of all churches, when duly organized, are subject to the supervision of a Church Council, composed of the preachers in charge and the elders and deacons of each church, all of whom are elected by the members. In addition to the councils of each local church, they have a confederation of churches called an 'Eldership,' consisting of all the pastors within certain bounds, and an equal number of ruling elders as delegates. She has, in addition to her local churches or stations, larger fields of operation, called circuits. Hence her ministers are some of them stationed, and others travel on circuits, and others are missionaries at large." The elderships meet annually. The General Eldership, which consists of delegates from Annual Elderships, is held every three years. The General Eldership owns and controls all the common property of the Church. No minister can be delegated to it who has not held a preacher's appointment for five years previous (Gorrie, cited below).

IV. *Statistics.*—The Church has a domestic and foreign missionary society and a printing establishment, all which are under the control of the General Eldership. A weekly paper, the *Church Advocate* (in 1867, 32d volume), and a Sunday-school paper, called the *Gem* (established in 1867), are published at Lancaster, Pa. The denomination in 1867 had 11 elderships, about 400 churches, 350 ministers, and 25,000 members. See Gorrie, *Churches and Sects*; Winbrenner, *History of Religious Denominations*; *American Baptist*

Almanac; *Annual American Cyclopaedia* for 1866, p. 112.

CHURCH OF JESUS CHRIST OF THE LATTER-DAYS SAINTS. See MORMONS.

CHURCH OF THE MESSIAH, a religious sect established in 1863, in Maine, by a person named Adams, who previously had been a Mormon elder. The founder of the sect claimed to have visions and special inspirations. Among the peculiar points of the new faith were, that its members are of the tribe of Ephraim, and that, "as the curse was now taken off from Palestine," the time had come for the lost ten tribes to return to the land of their fathers. They anticipated the re-establishment at Jerusalem of the throne of David in greater than Solomon's splendor. In expectation of the near advent of the Messiah, 156 members of the sect from the State of Maine went in 1866 to Palestine, and established a colony at Jaffa, the sea-port of Jerusalem, with one president (Adams) and two bishops as its leaders. Through the efforts of the American and English consuls in Jerusalem, they met with a kind reception on the part of the Turkish pacha and the people of Jaffa. Land had been secured for them before their arrival, through the American vice-consul at Jaffa. The colonists built quite a number of houses and a three-story hotel, having brought the lumber all the way from Maine. Complaints made by the colonists of the hardships they were forced to endure induced the government of the United States to send, at the beginning of 1867, an agent (the Rev. Dr. Bidwell, of New York) to Jaffa, in order to make a thorough examination into the affairs and prospects of the colony. In the course of the year 1867, a considerable number of the colonists became dissatisfied with their condition and the rule of president Adams, and returned home.—See *Annual American Cyclop. for 1866*, s. v. *Messiah, Church of*.

CHURCH OF ROME. See ROMAN CATHOLIC CHURCH.

CHURCH OF SCOTLAND. See SCOTLAND; SCOTLAND, FREE CHURCH OF.

CHURCH POLITY. See ECCLESIASTICAL POLITY.

CHURCH, PRESBYTERIAN. See PRESBYTERIAN CHURCH.

CHURCH, PROTESTANT EPISCOPAL. See PROTESTANT EPISCOPAL CHURCH.

CHURCH, REFORMED. See REFORMED CHURCH.

CHURCH, REFORMED PRESBYTERIAN. See PRESBYTERIAN (REFORMED) CHURCH.

CHURCH, STATES OF THE (*Patrimonium Petri*), the territory governed by the Pope as secular prince.

I. *History.*—The Church of Rome, which became at an early date one of the chief Christian churches of the world, received in 321, by a special edict of the emperor Constantine, the right to accept legacies. The story, however, that Constantine presented bishop Sylvester and the Roman Church with the city of Rome and other territories is an invention, and the pretended document of donation is a late forgery, taken from the so-called *Constitutum Sylvestri*, which was compiled from the *Gesta beati Sylvestri* (see Münch [Rom. Cath.], *Ueber die erdichtete Schenkung Constantin des Grossen*, Freiburg, 1824; Biener, *de donatione a Constantino M. imperatore in Sylvestrum pontificem collata*, in his work *de collectionibus canonum ecclesie Græcæ*, Berlin, 1827). Under the later emperors, a large amount of property of every description, including many landed estates in various parts of Italy and France, was presented to the Roman Church; and, moreover, the emperors conferred upon the bishops of Rome many lucrative privileges, as Gratian upon Damasus in 378, Valentinian upon Leo the Great in 445, etc. The ecclesiastical prerogatives which the popes claimed as heads of the Church, and which were gradually conceded by the emperors and acquiesced in by the bishops, greatly enlarged the secular power and

wealth of the popes. Under Gregory I the landed property belonging to the Roman Church was very extensive, especially in Sicily and Gaul. But until the eighth century the Roman bishops held all this landed property subject to the sovereign authority of the emperors. The first independent possession of the popes was the town of Sutri, which Gregory II, in 728, obtained from the Longobardian king Luitprand, who had wrested it, with other territories, from the Byzantine emperors. The friendly relations between the Roman See and Luitprand ceased under Gregory III (731-741), and most of the papal territory was reconquered by the Longobardians. The pope invoked the intercession of Charles Martel, in consequence of which Luitprand, in 742, restored to Pope Zachary not only the former property of the Roman bishops, but also the four Byzantine towns of Amelia, Orta, Bomarzo, and Bieda. The pope even succeeded in disposing the king amicably toward the exarch, in reward for which he received from the Byzantine emperor two villas. King Aistulph conceived the plan of conquering and annexing all Italy, and thus forced Pope Stephen II (752-757) to invoke again the aid of the Franks. Pepin, who owed his crown partly to the influence of the pope, twice (754 and 756) undertook a campaign into Italy, declined the demand of the Byzantine emperor to restore to him his former Italian possessions, gave to the pope, in addition to his former possessions, the Exarchate and the Pentapolis (the five cities of Rimini, Pesaro, Fano, Sinigaglia, and Ancona), and assumed himself the title of patricius (patron) of Rome. The original document of donation is no longer extant. The Longobardian king Desiderius found means to put off the complete execution of the stipulations made by Pepin, and ultimately new hostilities broke out, which induced Adrian I to invoke the aid of Charlemagne, who in 744 put an end to the Longobardian kingdom, and enlarged the donations of his fathers. As the original deeds of these donations are lost, their extent can no longer be fixed with entire accuracy. The extant document in which Louis le Débonnaire sanctions the donations of Charlemagne is a forgery. In consequence of the coronation of Charlemagne as emperor by Leo III, in 800, the connection of the pope with the Eastern empire entirely ceased, and the papal documents were henceforth dated after the beginning of the reign of the new emperor. The king of the Franks, as Roman emperor, had thus become the real sovereign of Rome, who had to sanction the election of a pope. The temporal power of the popes rapidly increased under the weak Carolingians, after whose extinction (888) the imperial dignity was, until 923, conferred upon Italian grandees, and subsequently was for some time discontinued altogether. When Otto I, in 952, reassumed the dignity of Roman emperor, he at once confirmed the papal possessions (the original document is lost, but a copy somewhat modified in the eleventh century is extant). A document containing a donation from Otto III to Sylvester II is a forgery, and there are no other reasons for the existence of that pretended donation. In 1052 the Roman See obtained feudal right over Benevento. The countess Matilda of Tuscany promised to the pope to bequeath to him her extensive territory; but on her death the property became the subject of a violent and protracted dispute, and the claims of the popes were not recognised until 1201, by Otto IV. In the agreement between Otto and the pope the following territory was designated as papal possessions: the country from the defiles of Ceperano (on the frontier of Naples), as far as the fort of Radicofano (on the Tuscan frontier), the exarchate of Ravenna, the Pentapolis (see above), the Marche, the duchy of Spoleto, the possessions of the countess Matilda, the county of Brittenorium, with other adjacent lands expressly mentioned in the documents of the emperors from the times of Louis (which latter clauses recognised the contents of a number of

spurious documents). Otto IV also promised to defend the claims of the pope to the kingdom of Sicily. Thus the States of the Church were firmly established, and as, since 1059, the election of the pope had been independent of the emperor, the high political position of the popes in the Christian world was confirmed.

During the following centuries the popes were more intent upon preserving than upon enlarging their possessions. In 1273, Philip III presented to Gregory X the county of Venaisin, and in 1848 Clement VI purchased Avignon from Joanna, queen of Sicily and countess of Provence. During the residence of the popes at Avignon, and during the schism, the popes had to concede extensive privileges to various cities. Other parts were given as fiefs to Italian princes: thus, in 1448, Alphonso I of Naples was made papal vicar of Benevento and Terracina; but Nicholas V (1447-1455), Pius II (1458-1464), and Sixtus IV (1471-1484) reconsolidated the papal possessions. Julius II (1503-1512) reconquered from the Venetians all the places which had formerly belonged to the pope, and even added to his territory Parma, Piacenza, and Reggio, thus giving to the States of the Church the most extensive frontier they have ever had. Parma and Piacenza were soon lost again, but in their place Camerino and Nepi were obtained. Reggio had to be abandoned in 1523, and Modena in 1527; but, on the other hand, a number of republican communities were fully subjected, as Ancona in 1532, Perugia in 1540, and the feudal relations of others, as Ferrara (1598), Urbino (1636), and the duchy of Castro (the dispute concerning which lasted until 1735), were abolished. About fifty years later the States of the Church entered into a period of rapid decline. In 1788 the government of Naples declared the feudal relation in which that kingdom had stood to Rome as terminated. In 1792 Avignona and Venaisin were annexed to France, and in 1796 another considerable tract of territory was lost. At the peace of Tolentino, Feb. 19, 1797, Pius VI had to cede all the papal possessions situate in France, and to agree that the districts of Ferrara, Bologna, and Romagna should be incorporated with the new Transpadan Republic. On the 16th of February the republic was proclaimed in the city of Rome, the papal government was declared abolished, and the pope himself was carried into captivity. The treaty of Vienna, in 1815, restored to the pope the Marche, with Camerino, the duchy of Benevento, with the principality of Ponte-Corvo, the legations of Ravenna, Bologna, and Ferrara; and gave to the emperor of Austria the right of garrisoning Ferrara and Comacchio. Nothing was said in the treaty of Vienna about the papal claims to Avignon and Venaisin, on which account the pope protested against the portion of the treaty relating to the States of the Church.

Certain acts of Leo XII (1824) created general indignation among the inhabitants of the papal territory. In February, 1831, an insurrection broke out in Bologna, which soon spread through the whole province, and from there through the larger portion of the States of the Church. A provisional government was established, and on the 26th of February an assembly of deputies declared the abolition of the temporal power of the popes. The intervention of Austria put, however, an end to the insurrection. The representatives of the great powers found the civil administration so unsatisfactory that they urgently recommended the introduction of reforms. As these were not granted, a new insurrection occurred, which caused another intervention of Austria, and the occupation of Bologna by Austrian troops. This was at once followed by an occupation of Ancona by France, which was unwilling to leave the pope under the sole patronage of Austria. Both occupations lasted until 1838. Gregory XVI (1831-1846) convoked an assembly of deputies, in order to learn the wishes of the people, but it led to no reforms of any account. The discontent of the people contin-

ed, and showed itself in repeated revolutionary outbreaks. Pius IX (elected June 16, 1846) began to introduce important changes into the public administration *motu proprio* of 2d and 14th of October, 1847, fundamental statute of 14th of March, 1848, etc.), and thus gave an impulse to a political movement which he soon found himself unable to control. He had to grant, on the 14th of March, 1848, a constitutional form of government, which was soon followed by the appointment of a liberal ministry (Mamiani) and the convocation of a Constituent Assembly. An attempt to curb the liberal movement by the appointment of a conservative ministry (Count Rossi) failed, and the pope was compelled to consent to the appointment of a democratic ministry. On the 25th of November the pope fled from Rome in disguise, and took up his residence at Gaeta, in the kingdom of Naples. In consequence of this movement a provisional government was established at Rome, which declared the temporal power abolished, and proclaimed the republic (February, 1849). This led to a new intervention of Austria (after the defeat of Sardinia) in the legations, and to the landing in the Papal States of a French army, under Oudinot, in April, 1849. The city of Rome surrendered on the 2d of July, the papal rule was restored, and all the reforms of the first years of the reign of Pius were abolished. The political and financial condition of the States of the Church after the restoration of the pope was most deplorable, and the people continued to be dissatisfied with the papal rule. When, in 1859, in consequence of their defeat at Magenta, the Austrians had to withdraw their troops from Central Italy, Bologna and the neighboring legations (the Romagna) at once shook off the papal rule, and, together with Parma and Modena, organized them, under the name of Emilia, into a provisional state under the dictatorship of Farini. After the treaty of Zurich (Nov. 10, 1859), Austria and France proposed the convocation of a congress for the regulation of the Italian affairs, but the pope refused to take part in it, as the great powers did not agree to guarantee to him the restoration of the Romagna. Victor Emmanuel consequently, by a decree of the 18th of March, 1860, after a popular vote had declared in favor of annexation, incorporated the Romagna with the kingdom of Italy. The papal government now tried to organize a powerful army, chiefly of foreign volunteers, under the French general Lamoricière. When, after the conquest of Naples by Garibaldi, a part of the old Neapolitan army had been united with the papal troops, the Italian government demanded the discharge of the foreign volunteers as menacing the unity of Italy, and, when the papal government refused to comply with this request, the king marched troops into the papal territory, defeated the papal troops at Castellidardo on the 18th of September, and captured the remainder at Ancona. Umbria and the Marches now declared at once in favor of annexation, and, a popular vote having been taken, were incorporated with Italy by decree of the 17th of December. As, after the fall of Gaeta, Rome became the refuge of the expelled king of Naples, and the centre of all plots against Italian unity, the Italian Party of Action loudly demanded the conquest of Rome, and in March, 1861, even the Italian Parliament declared the city of Rome the natural and indispensable capital of the kingdom. Attempts made by the Italian prime minister Cavour to prevail upon the pope to consent to a separation between his temporal and ecclesiastical power failed; and the same was the case with a proposition of Louis Napoleon to bring about a reconciliation between the Italian and the Roman governments on the basis of the existing extent of the papal territory. In 1862, Garibaldi made an attempt, at the head of an army of volunteers, to conquer Rome, and deliver Italy both from the rule of the pope and that of the French, but this movement was promptly suppressed by the Italian government. On the 15th of Septem-

ber, 1864, France concluded with the government of Italy a convention, by which France promised to withdraw its army of occupation from Rome within two years, while Italy, on the other hand, promised not to attack the papal territory, and even to protect it against any foreign attacks, to assume a proportional part of the papal debt, and not to oppose the organization of a papal army, provided the latter should not threaten the safety of Italy. In accordance with the provisions of this convention, the city of Rome and the papal territory were evacuated by the French troops in December, 1866. The pope has, up to this time, persistently declined all proposals to abandon his claims to the provinces which have been incorporated with the kingdom of Italy, and still more to renounce the temporal power altogether. See TEMPORAL POWER.

II. *Ecclesiastical Statistics.*—The Papal States had in 1858 an area of 17,494 square miles, and, according to the census, a population of 8,124,668 souls, among whom were 9287 Israelites and 268 Protestants, while the rest were Roman Catholics. They had nine archbishoprics, viz., Rome (whose metropolitane is the pope himself, represented through a cardinal vicar), Benevento, Fermo, Ferrara, Ravenna, Urbino, Bologna, Camerino, Spoleto—the last three without suffragans. The number of bishoprics was seventy-nine, of which, however, many had been permanently united, so that the actual number of bishops amounted only to fifty-eight. All the eight archbishoprics and most of the bishoprics lie in the provinces which in 1859 were annexed to Sardinia. The States of the Church, thus reduced, had in 1867 about 700,000 inhabitants. The city of Rome had, in 1866, 210,701 inhabitants, among whom were 4567 Israelites and 429 Protestants. Convents are very numerous. There were, in 1845, 1824 convents of monks and 612 of nuns. The secular clergy were estimated at 85,000, monks 10,000, nuns 8000. The former belong to 50, the latter to 21 different orders. The total number of clerical persons in the city of Rome was (in 1866) 7878. The superiors of most of the orders reside in Rome. See MONASTICISM. As the seat of the central government of the Roman Catholic Church, the States of the Church (more particularly Rome) have a number of ecclesiastical offices and boards, which are treated of in separate articles. See POPE; CARDINAL; CONGREGATION; CURIA ROMANA. See Herzog, *Real-Encyclop.* vii, 676 sq.; Wetzer und Welte, *Kirchen-Lexikon*, vi, 175; Sugenheim (Protest.), *Geschichte der Entstehung und Ausbildung des Kirchenstaats* (Leipzig, 1854); Scharpf (Roman Catholic), *Entstehung des Kirchenstaats* (1854; transl. Baltimore, 1860); Döllinger (Rom. Cath.), *The Church and Churches* (Munich, 1861; transl. 1863); Brockhaus, *Conversations-Lexikon*, viii (11th edition, 1866), 823 sq.

CHURCH, UNITED PRESBYTERIAN. See PRESBYTERIAN (UNITED) CHURCH.

CHURCH-WARDENS, officers in the Church of England, whose business is to look to the church, church-yard, and to observe the behavior of the parishioners; to levy a shilling forfeiture on all such as do not go to church on Sundays, and to keep persons orderly in church time, etc. By Canon 89, church-wardens or questmen in every parish are required to be chosen by the joint consent of the minister and the parishioners, if it may be; but if they cannot agree upon such a choice, then the minister shall choose one and the parishioners another, and without such a joint or several choice none shall take upon them to be church-wardens. But if the parish is entitled by custom to choose both church-wardens, then the parson is restrained of his right under this canon. The duties of English church-wardens are laid down in Prideaux, *Practical Guide to the Duties of Church-wardens* (10th ed. Lond. 1835, 12mo). In the Protestant Episcopal Church in America, their duties in general are to protect the church building, to see that worship is duly

provided for and performed, and to represent the body of the parish when occasion may require. They are chosen, with the vestrymen, "annually in Easter-week, according to the canons of the various dioceses." Their duties are enjoined by diocesan, not by general canons. — Hook, *Church Dictionary*, s. v.; Staunton, *Ecclesiastical Dictionary*, s. v.

CHURCH-YARD, a piece of ground adjoining a church, set apart for the interment of the dead. During the first three centuries of our era the Christians followed the law of pagan Rome, according to which every one could select his burying-place outside of the towns. The Christians generally preferred to be buried near the graves of the martyrs, and thus they early obtained common burying, or, as they called them, sleeping-places (*coemeteria, dormitoria*), which were sometimes above the ground (*area*), and sometimes in subterranean caves. See **CATACOMBS**. When the persecution of Christianity ceased, and the relics of the martyrs were transferred to the churches within the towns, the places around the churches, or the vestibules of the churches, were commonly selected for burying the dead; for a burial in the church itself was strictly forbidden, and only granted as a special distinction to bishops, princes, and other persons of high ecclesiastical or political position. Thus gradually the church-yards became an established institution in connection with the church. In large cities every particular church had its church-yard, and not until the 14th century are the church-yards to be found without the town. Gradually it became general to close the church-yards in the towns, and to remove them out of the towns, until ultimately the governments of most of the states enforced this rule from sanitary reasons.

In the Church of Rome, church-yards are consecrated with great solemnity. If a church-yard which has been thus consecrated shall afterwards be polluted by any indecent action, or profaned by the burial of an infidel, a heretic, an excommunicated or unbaptized person, it must be *reconciled*; and the ceremony of the reconciliation is performed with the same solemnity as that of the consecration! (Buck). See **CONSECRATION**.

In the Protestant churches of Germany and other countries, church-yards were set apart by praying and reading of the Scriptures; in England and Sweden a formal consecration is still in use.

In England the church-yard is the freehold of the parson; but it is the common burial-place of the dead, and for that reason it is to be fenced at the charge of the parishioners, unless there is a custom to the contrary, or for a particular person to do it, in respect of his lands adjoining to the church-yards; and that must be tried at common law (Hook). See **BURIAL; CEMETERY**.

The control of the church-yards has given rise to many conflicts between Church and State. The Church of Rome forbids the burial of heretics, suicides, excommunicated persons, and unbaptized children upon the Roman Catholic cemetery; while the state governments, both Protestant and Roman Catholic, regarding the cemetery as public and not ecclesiastical property, have frequently endeavored to compel the burying of all dead without distinction in the same cemetery. In the United States the government does not meddle with the places and modes of burial, and religious bodies, as well as single congregations and individuals, can make any provisions they please for the burial of their dead. — Wetzler u. Welte, *Kirchen-Lex.* vi, 201; Herzog, *Real-Encyclop.* vii, 706.

CHURCH-YEAR. Neither the New Testament nor the Church literature of the first three centuries contain any intimation that the Christians of that time viewed the year from any other stand-point than that of subjects of the Roman emperor or other princes. See **CALENDAR; CHRONOLOGY, CHRISTIAN**. The first impulse to the idea of a church year distinct from the

civil year was given by the establishment of anniversaries of prominent events in the life of Christ. The most ancient of these anniversaries were those of his death and resurrection [see **EASTER**]; gradually were added to them those of his birth [see **CHRISTMAS**], of the outpouring of the Holy Ghost [see **PENTECOST**], of the circumcision [see **EPIPHANY**], of the ascension [see **ASCENSION DAY**]. Christmas, Easter, and Pentecost came each to be regarded as the centre of a cycle, the three cycles together embracing a commemoration of every thing memorable in the life of the Redeemer. When the worship of the Virgin Mary and of the saints was developed in the Church of Rome, a number of festivals commemorating events in the life of the Virgin Mary, and the death-days of the apostles, martyrs, and saints, were added to the ecclesiastical calendar. This combination suggested to the writers of the Church the idea that the church-year is to celebrate, within the compass of a civil year, the commemoration of all the memorable events in the life of the Church, from the birth of, or, rather, the announcement of the birth of Christ to the death of the last saint. The habit of beginning this year with the first Sunday of Advent is first found among the Nestorians, and was only gradually adopted by the Church of Rome. There are, in all, four Sundays of Advent, intended to prepare the mind for the proper celebration of Christmas (25th of December). Christmas, like Epiphany, Easter, Ascension, and Pentecost, were each followed by an "octave" (commemorative services referring to the great festival during eight days, the chief festival itself being counted in), the Sunday immediately following the festival being denominated the Sunday "within the octave." The Sundays following the "Sunday within the octave of Epiphany" were called the "second, etc., Sunday after Epiphany," until the Sunday Septuagesima began the Easter cycle. It was followed by the Sundays Sexagesima, Quinquagesima, four Sundays of Lent, Palm Sunday, and Easter Sunday; Sunday within the octave of Easter ("Low Sunday"), second, third, etc., Sundays after Easter, until the Sunday within the octave of Ascension forms the boundary-line between the Easter and the Pentecost cycles. Whitsunday (Pentecost) opens the Pentecost cycle; and the following Sundays are called the first (festival of the "most Holy Trinity"), second, etc., Sunday after Pentecost. They run on until the close of the church-year, when the recurrence of the first Sunday of Advent opens the new year. The last festival which Rome added to her church-year was that of *Corpus Christi* (q. v.), to be an annual celebration of the doctrine of transubstantiation. According to the importance attributed to the several festivals, the Church of Rome makes the distinction of "simple," "semi-double," and "double" festivals; the latter being again subdivided into "double second class" and "double first class" (the highest festivals). The Church books, as Missal and Breviary, have special services for each particular festival, and for each class of festivals. See **BREVIARY** and **MISSAL**. Roman Catholic writers have often dwelt on a mysterious correspondence between the seasons of the church-year and those of the natural year (Christmas, the appearance of Christ in the lost world in winter, when nature appears to be dead; Easter, in spring, when nature seems to revive; Pentecost, in summer, when every thing is in highest bloom), entirely forgetting that this correspondence holds good only of the northern hemisphere. Other writers have more reasonably traced in this correspondence an influence of pagan festivals, in which this kind of correspondence can be traced to a very large extent, upon the doctrines and institutions of the Church of Rome; but although in some instances the influence is undeniable, it is difficult to say how far it extended. The chief features of the church-year were fully developed when the separation between the Latin

and Greek churches took place, and there is, therefore, but little difference in the church-year of the two churches. The Greeks begin their year on the 1st of September, and have, of course, none of the saints of the Roman Church who either lived or were canonized after the separation, while the Latins do not recognise the few saints which the Greek Church has added to the catalogue of the ancient saints.

Luther and the Lutheran Church retained, on the whole, the Roman Catholic idea of the church-year. They rejected the Corpus Christi festival and the days of the saints, but retained most of the festivals of Mary as being based upon events mentioned in the Bible, and the celebration of the days of the apostles and the angels. In the conflict between High-Church and Low-Church Lutherans in the 19th century, the former party strongly insisted upon retaining every thing to which Luther and the other fathers of the Lutheran Church had not objected, and some leading men of the school even showed a disposition to strain every thing in common between the early Lutheran and the Roman Catholic churches as far as their membership in the Lutheran Church would possibly admit. This tendency shows itself also with regard to Church festivals and the idea of a church-year. The Reformed churches desired to return to the form of divine worship as it existed in the primitive service, and therefore showed a tendency to reject the whole idea of a church-year. In Geneva, at the time of Calvin, only the Sunday was celebrated, and the same habit prevailed in most of the Reformed churches of Switzerland. In Germany the opposition of the Reformed to the church-year was not so thorough. In modern times the celebration of Good Friday has been introduced into most of the Reformed churches (in Geneva since 1820). In the Church of England, the High-Church party retained much more of the Latin church-year than was done by the Lutherans; and in modern times efforts have even been made to conform the Anglican church-year in almost every particular to that of the Church of Rome. The Dissenting churches of England and the Protestant churches of the United States have generally rejected the idea of a church-year, with its system of peculiar festivals. Easter and Good Friday, however, are celebrated by church services in many of the Dutch and German Reformed and Methodist churches, and some others; and in the German Reformed Church the idea of a church-year, as it was developed in the Latin Church of the Middle Ages, has found many defenders. See Herzog, *Real-Encyclopädie*, vii, 648 sq.; Wetzer u. Welte, *Kirchen-Lexikon*, vi, 161 sq. The most important Roman Catholic works on the church-year are Gretzer, *De Fests Christianorum*; Benedict XIV, *De Fests*; Staudenmaier, *Geist des Christenthums*; Nickel, *Die hist. Zeiten*; Binterim, *Denkwürdigkeiten*. Protestant works: Straus, *Das evangel. Kirchenjahr* (Berlin, 1856); Bobertag, *Das evangel. Kirchenjahr* (Breslau, 1858).

Church, John Hubbard, D.D., a Congregational minister, was born at Rutland, Mass., March 17, 1772. He graduated at Harvard 1797, and was installed pastor in Pelham, N. H., Oct. 31, 1798. He died in June, 1840. Dr. Church was trustee of Dartmouth College, President of N. H. Bible Society, and filled several other honorable stations. He published a number of occasional sermons.—Sprague, *Annals*, ii, 445.

Church, Thomas, D.D., a divine of the Church of England, was born 1707, and educated at Brazenose College, Oxford. In 1740 he was made vicar of Battersea, and afterwards prebend of St. Paul's. He died in 1756. Among his publications are, *Essay on the Demoniacs of N. T.* (Lond. 1787, 8vo); *Doctrine of the Church of England on Regeneration* (Lond. 1789, 8vo); *Vindication of the miraculous Powers of the Church in the first three Centuries* (answer to Middleton

[Lond. 1750, 8vo]). He wrote also several tracts against Wesley and the Methodists, notices of which may be found in Wesley's *Journals* (*Works*, v, 265, vi, 145).

Churching OF WOMEN, a form of public thanksgiving for women after *child-birth*, used in the Greek and Roman churches, in the Church of England, and in the Protestant Episcopal Church. "It is in all probability of Jewish origin, and derived from the rite of purification enjoined in the twelfth chapter of Leviticus. The rubric [of the English Church] commands that the office be used only in the church. Churching in private houses is inconsistent with the very name of the office, and with the devotions prescribed by the office." The Roman Catholic Church allows, in exceptional cases, churching in private houses, and the churching of mothers of illegitimate children.—Eden, *Churchman's Dictionary*, s. v.; Procter *On Common Prayer*, p. 427; Brownell, *Comm. on Prayer-book*, p. 490; Wetzer u. Welte, *Kirchen-Lexikon*, i, 562 (s. v. *Aussehung*).

Churl (כֹּרֵל, *kilyal'*, Isa. xxxii, 5; or כֶּלַי, *kelay'*, ver. 7), a *deceiver* (as it should have been rendered); while CHURLISH is the proper rendering (of כָּשָׁה, *kashah'*, rough, as often elsewhere rendered) for a coarse, ill-natured fellow (1 Sam. xxv, 8; compare 2 Macc. xiv, 20; Eccles. xviii, 18; xlii, 14), like Nabal (q. v.).

Churning (צִיָּץ, *mits, squeezing*) signifies the act of pressing (Prov. xxx, 83), being the same word rendered "wringing" and "forcing" in the same verse, and agrees with the Eastern mode of making butter (see Thomson, *Land and Book*, i, 893). See BUTTER.

Churton, RALPH, a minister of the Church of England, was born near Bickley, Cheshire, Dec. 8, 1754. He was educated at Malpas Grammar-school, and at Brazenose College, Oxford, where he was entered in 1772, and became fellow in 1778. In 1785 he delivered the Bampton lecture *On the Prophecies respecting the Destruction of Jerusalem* (Oxf. 1785, 8vo). In 1792 he became rector of Middleton Cheney; in 1805 he was made archdeacon of St. David's. For forty years he labored diligently and faithfully as a parish priest, and was engaged also in frequent and useful literary labors. He died March 23, 1831. Besides the Bampton lecture, he published *Memoir of Archdeacon Townson* (1778, 1828, 1880); *Lives of Bishop Smith and Sir Richard Sault* (1800, 8vo); *Life of Dean Nowell* (1809, 8vo); and numerous detached sermons and pamphlets.—*Annual Biography and Obituary* (Lond. 1832), xvi, 278.

Chu'shan-rishatha'im (Heb. *Kushan' Rishatha'yim*, כֹּשְׁתָרִישָׁתַיִם, Sept. *XovavpacaTaiu*, Vulg. *Chusan-Rasathaim*), the king of Mesopotamia who oppressed Israel during eight years (B.C. 1575-1567) in the generation immediately following Joshua (Judg. iii, 8). The name, if Hebrew, would signify *Cush* (comp. CUSHAN, Hab. iii, 7) of the two *wickednesses*; but Fürst (*Heb. Handwörterb.* s. v.) compares the Arabic signification, *chief of two governments* (see Abulf. *Ann.* ii, p. 100), with reference to the twofold form of Aram-Naharaim (q. v.). Josephus (*Ant.* v, 8, 2) calls him "*Chusarthus* (*Xovavpacos*), king of the Assyrians." The seat of his dominion was probably the region between the Euphrates and the modern Khabour, to which the name of Mesopotamia always attached in a special way. In the early cuneiform inscriptions this country appears to be quite distinct from Assyria; it is inhabited by a people called *Natri*, who are divided into a vast number of petty tribes, and offer but little resistance to the Assyrian armies. No centralized monarchy is found, but as none of the *Assyrian* historical inscriptions date earlier than about B.C. 1100, which is some centuries later than the time of Chushan, it is, of course, quite possible

that a very different condition of things may have existed in his day. In the weak and divided state of Western Asia at this time, it was easy for a brave and skilful chief to build up rapidly a vast power, which was apt to crumble away almost as quickly. Bunsen, however, calls him merely "a Mesopotamian satrap," assuming that he must have been posterior to the Assyrian supremacy (*Egypt*, iii, 272). Chushan-Rishathaim's yoke was broken from the neck of the people of Israel at the end of eight years by Othniel, Caleb's nephew (*Judg.* iii, 10), and nothing more is heard of Mesopotamia as an aggressive power. The rise of the Assyrian empire; about B.C. 1270, would naturally reduce the bordering nations to insignificance (see Rawlinson, *Hist. Evidences*, p. 800).—Smith, s. v. See MESOPOTAMIA.

Chu'ai (Χουαί v. r. Χούς, Vulg. omits), a place named only in *Judith* vii, 18, as near Ekrebel, and upon the brook Mochmur. If the history be at all genuine, this was doubtless in Central Palestine, but all the names appear to be very corrupt, and are not recognisable. See *JUDITH*.

Chu'za [pron. *Cúsa*] (rather *Chusas*, Χουζάς, for Chald. ܫܘܙܐ, i. e. ܫܘܙܐܝܬ, possession), the "steward" (ἐπιτροπος) of Herod (Antipas), whose wife Joanna (q. v.), having been cured by our Lord either of possession by an evil spirit or of a disease, became attached to that body of women who accompanied him (A.D. 27) on his journeyings (*Luke* viii, 8); and, together with Mary Magdalen and "Mary the mother of James," having come early to the sepulchre on the morning of the resurrection (A.D. 29), to bring spices and ointments to complete the burial, brought word to the apostles that the Lord was risen (*Luke* xxiv, 10). These circumstances would seem to imply that she was at this time a widow.

Chytræus, DAVID (properly *Kochlaffe*), one of the most eminent of the Lutheran theologians of the second half of the sixteenth century, was born at Ingeltingen, Feb. 28, 1530. Having studied the ancient languages at Tübingen, he went to Wittenberg about 1548, and became a pupil of Melancthon in theology. In 1548 he began to lecture at Wittenberg on physics, and also on theology. After an extended journey in Germany, Switzerland, and Italy, he was called in 1551 to Rostock; and his character for scholarship and wisdom gained him great influence in Mecklenburg, and also in wider spheres. He was employed by Maximilian II to arrange ecclesiastical affairs in Austria. He was principal author of the statutes of the University of Helmstädt, and was one of the authors of the *Formula of Concord* (q. v.). He died June 26, 1600. Among his writings are, *Historia Confessionis Augustanæ* (Frankfort, 1578, 8vo); *De Morte et Vita Æterna* (Rostock, 1590, 8vo). His works were collected and printed in 2 vols. folio (Leipzig, 1599; Hanover, 1604). A biography of Chytræus, with a selection from his works, was published by Pressel in the 8th vol. of the work, *Leben u. ausgewählte Schriften der Väter der kath. Kirche* (Elberfeld, 1868). See Schutzius, *De Vita D. Chytræi* (Hamburg, 1720-28, prefixed to the writings of Chytræus, 8 vols. 8vo); Melchior Adam, *Vita Theologorum* (Frankfort, 1706), p. 528; Herzog, *Real-Encyclopædie*, ii, 701.

Ciborium (κίβριον, a cup), a large chalice (a species of *πυξ*, q. v.) or cup, often of gold or silver, with a cover, surmounted commonly by a cross. It is used to contain the host, or consecrated wafer, in the mass. The name *ciborium* was also given to a canopy on the altar, supported by four columns, to which the cup, in the shape of a dove, was attached by chains, containing the wafer for the communion of the sick.—Wetzer u. Welte, *Kirchen-Lexikon*, ii, 645.

Cicoar (ܟܝܟܪ, *hikkar'*, circuit, esp. of the Jordan).

--- TOPOGRAPHICAL TERMS; TALENT.

Cieling. See *СКИПЦА*.

Cil'icia (Κιλικία; on the deriv., see below), a maritime province in the south-eastern part of Asia Minor, bounded on the west by Pamphylia; separated on the north from Cappadocia by the Taurus range, and on the east by Amanus from Syria; and having the Gulf of Issus (Iskenderoon) and the Cilician Sea (*Acts* xxvii, 5) on the south. These lofty mountain barriers can be surmounted only by a few difficult passes, the former by the Portæ Amanides, at the head of the valley of the Pinarus, the latter by the Portæ Cilicia, near the sources of the Cydnus; towards the south, however, an outlet was afforded between the Sinus Issicus and the spurs of Amanus for a road, which afterwards crossed the Portæ Syria in the direction of Antioch (hence the close connection which existed between Syria and Cilicia, as indicated in *Acts* xv, 23, 41; *Gal.* i, 21). The sea-coast is rock-bound in the west, low and shelving in the east; the chief rivers—Sarus, Cydnus, and Calycadnus—were inaccessible to vessels of any size from sand-bars formed at their mouths. By the ancients the eastern part was called *Cilicia Propria* (ή ἰδιωτὴ Κιλικία, Ptolemy), or the level Cilicia (ή πεδιάς, Strabo); and the western, the rough (ή τραχεία, Strabo, xiv, 5), or mountainous (ή ὄρηνη, Herod. ii, 84). The former was well-watered, and abounded in various kinds of grains and fruits (*Xenoph. Anab.* i, 2, § 22; *Ammianus Marcell.* xiv, 8, § 1). The chief towns in this division were *Issus* (*Xenoph. Anab.* i, 4), at the south-eastern extremity, celebrated for the victory of Alexander over Darius Codomanus (B.C. 338), and not far from the passes of Amanus (τῶν Ἀμανίδων λεγομένων Πυλῶν, Polyb. xii, 8); *Sola*, originally a colony of Argives and Rhodians, the birthplace of Menander, the comic poet (B.C. 262), the Stoic philosopher Chrysippus (B.C. 206), and of Aratus (q. v.), author of the astronomical poem τὰ Φαινόμενα (B.C. 270); and *Tarsus*, the birthplace of the apostle Paul (q. v.). Cilicia Trachæa furnished an inexhaustible supply of cedars and firs for ship-building; it was also noted for a species of goat (*Martial.* xiv, 188), of whose skins cloaks and tents were manufactured. Its breed of horses was so superior, that 360 (one for each day of the year) formed part of the annual tribute to the king of Persia (Herod. iii, 90). The neighborhood of Corycus produced large quantities of saffron (*Plin. Nat. Hist.* xxi, 17). Josephus identified Cilicia with the *Tarsihah* of Gen. x, 4 (*Ant.* i, 6, 1). Herodotus says that the first inhabitants of the country were called *Hypachæi* (Ἰψαχαιοί); and derives the name of Cilicia from Cila, son of Agenor, a Phœnician settler (vii, 91). This is confirmed by Phœnician inscriptions, on which the name is written *Chalak* (ܟܠܚܟ, Gesenius, *Moson. Phœn.* p. 279). Herodotus also states that the Cilicians and Lycians were the only nations within the Halys who were not conquered by Croesus (i, 28). Though partially subjected to the Assyrians, Medes, Persians, Syrians, and Romans, the Eleuthero- (or free) Cilicians, as the inhabitants of the mountainous districts were called, were governed by their own kings ("Reguli," Tacit. ii, 78), till the time of Vespasian. The sea-coast was for a long time occupied by pirates, who carried on the appropriate vocation of slave-merchants, and found ample encouragement for that nefarious traffic among the opulent Romans (Mannert, *Geogr.* vi, 1; Strabo, xiv, 5); but at last their depredations became so formidable that Pompey was invested with extraordinary powers for their suppression, which he accomplished in forty days. He settled the surviving freebooters at *Sola*, which he rebuilt and named Pompeiopolis. Cicero was proconsul of Cilicia (B.C. 52), and gained some successes over the mountaineers of Amanus, for which he was rewarded with a triumph (*Epist. ad Fam.* xv, 8). As the more level portion was remarkable for its beauty and fertility, as well as

for its luxurious climate, it became a favorite residence of the Greeks after its incorporation into the Macedonian empire, and its capital, Tarsus (q. v.), was elevated into the seat of a celebrated school of philosophy. The connection between the Jews and Cilicia dates from the time when it became part of the Syrian kingdom (see 1 Macc. xi, 14; 2 Macc. iv, 36; comp. Judith i, 7, 12; ii, 21, 25). Antiochus the Great is said to have introduced 2000 families of the Jews into Asia Minor (Josephus, *Ant.* xii, 3, 4), many of whom probably settled in Cilicia (Philo, *De legat. ad Caium*, 30). In the apostolic age they were still there in considerable numbers (Acts vi, 9). Cilician mercenaries, probably from Trachea, served in the body-guard of Alexander Jannæus (Joseph. *Ant.* xiii, 13, 5; *War*, i, 4, 8). The synagogue of "them at Cilicia" (Acts vi, 9) was a place of Jewish worship in Jerusalem, appropriated to the use of the Jews who might be at Jerusalem from the province of Cilicia. See SYNAGOGUE. Cilicia was, from its geographical position, the high road between Syria and the West, and it was also the native country of Paul; it was visited by him, first, soon after his conversion (Gal. i, 21; Acts ix, 30), on which occasion he probably founded the Church there (Neander, *Planting and Training*, i, 114; Conybeare and Howson, *St. Paul*, i, 17-25, 249), and again in his second apostolical journey, when he entered it on the side of Syria, and crossed Anti-Taurus by the Pylos Ciliciæ into Lycaonia (Acts xv, 41). Christianity continued to flourish here until the 8th century, when the country fell into the hands of the Saracens, by whom, and by their successors the Turks, the light of true religion has been almost extinguished. According to the modern Turkish divisions of Asia Minor, Cilicia Proper belongs to the pashalic of Adana, and Cilicia Trachea to the Liwah of Itchil in the Mouselimlik of Cyprus (see *Penny Cyclopædia*, s. v.; Smith, *Dict. of Class. Geogr.* s. v.; Vict. Langlois, *Voyage dans la Cilicie*, Par. 1861).—Kitto, s. v.; Smith, s. v. See ASIA MINOR.

Cimeliarch. See CEIMELIARCHE; SACRISTAN.

Cinnamon (קִינָמוֹן, *kinnamon'*; Gr. κινάμων; a word, according to Herodotus [iii, 111], of Phœnician origin; according to Gesenius [*The. Heb.* p. 1223], from קָיַם, to stand upright) occurs first in Exod. xxx, 23, where it is enumerated as one of the ingredients employed in the preparation of the holy anointing oil: "Take thou also unto these powerful spices, myrrh, and of sweet cinnamon half as much (i. e. 250 shekels), together with sweet calamus and cassia." It is next mentioned in Prov. vii, 17: "I have perfumed my bed with myrrh, aloes, and cinnamon." Again, in Cant. iv, 14: "Spikenard and saffron, calamus and cinnamon, with all trees of frankincense; myrrh and aloes, with all the chief spices." In Rev. xxiii, 13, among the merchandise of Babylon (Rome), we have "cinnamon, and odors, and ointments, and frankincense." Also in Eccles. xxiv, 15, "I gave a sweet smell, like cinnamon and aspalathus." Cinnamon was probably an article of commerce in ancient Babylon. The Hebrews received this Indian production through the Midianites and Nabathæans, who brought it from the Arabian Gulf. It seems that the Arabians at an early period had commercial intercourse with Ceylon and Continental India, as they were the first navigators of the Indian Ocean (Gen. xxxvii, 25). Many writers have doubted whether the *kinnamon* of the Hebrews is the same article that we now call cinnamon. Celsius quotes R. Ben-Melech (*ad Cant.* iii, 14) and Saadias (Exod. xxx) as considering it the *Lign Aloe*, or *Agallochum*. Others have doubted whether our cinnamon was at all known to the ancients. But the same thing has been said of almost every other drug which is noticed by them. The word κινάμωμον occurs in many of the Greek authors, as Herodotus, Hippocrates, Theophrastus, Dioscorides, Galen, etc. The

first of these, writing 400 years before the Christian era, describes Arabia as the last inhabited country towards the south, and as the only region of the earth which produces frankincense, myrrh, cinnamon, cassia, and ledanum (iii, 107). He states, moreover, that the Arabians were unacquainted with the particular spot in which it was produced, but that some asserted it grew in the region where Bacchus was educated. From all this we can only infer that it was the production of a distant country, probably India, and that it was obtained by the route of the Red Sea. Theophrastus (ix, 5) gives a fuller but still fabulous account of its production; and it is not until the time of Dioscorides, Galen, and the Periplus of the Erythrean Sea, that we get more definite information. Galen says that cassia and cinnamon are so much alike that it is not an easy matter to distinguish the one from the other. Cinnamon of the best quality is imported in the present day from Ceylon, and also from the Malabar coast, in consequence of the cinnamon plant (*Cinnamomum Zeylanicum*) having been introduced there from Ceylon. An inferior kind is also exported from the peninsula of India, the produce of other species of *cinnamomum*, according to Dr. Wight. From these countries the cinnamon and cassia of the ancients must most likely have been obtained, though both are also produced in the islands of Sumatra and Borneo, in China, and in Cochin China. Cinnamon is imported in bales and chests, the bundles weighing about 1 lb. each. The pieces consist of compound quills, are about three feet long, slender, and inclose within them several smaller quills. These are thin, smooth, of a brownish color, of a warm, sweetish, and agreeable taste, and fragrant odor; but several kinds are known in modern markets, as they were in ancient times. In Ceylon cinna-



Cinnamomum Zeylanicum.

mon is carefully cultivated, the best cinnamon-gardens being on the south-western coast, where the soil is light and sandy, and the atmosphere moist from the prevalent southern winds. This little tree belongs to the laurel family, and the leaf is not unlike the laurel, though of a lighter green. The white blossom comes out with great profusion, and for many miles around Colombo brightens all the landscape in its season, although it diffuses hardly any perceptible odor through the air. The tree is about twenty feet in height, and spreads into numerous branches; the fruit or nut is about the size of a damson, and when ripe is of a black color. The plants begin to yield cinnamon when about six or seven years old, after which the shoots may be cut every three or four years. The best kinds of cin-

namon are obtained from twigs and shoots; those less than half an inch, or more than two or three inches in diameter, are not peeled. "The peeling is effected by making two opposite, or, when the branch is thick, three or four longitudinal incisions, and then elevating the bark by introducing the peeling-knife beneath it. In twenty-four hours the epidermis and greenish pulpy matter are carefully scraped off. In a few hours the smaller quills are introduced into the larger ones, and in this way congeries of quills are formed, often measuring forty inches in length. The bark is then dried in the sun, and afterwards made into bundles, with pieces of split bamboo twigs" (Parcival's *Account of Ceylon*, p. 386-351). Besides cinnamon, an oil of cinnamon is obtained in Ceylon, by macerating the coarser pieces of the bark, after being reduced to a coarse powder, in sea-water for two days, when both are submitted to distillation. A fatty substance is also obtained by bruising and boiling the riper fruit, when an oily body floats on the surface, which, on cooling, concretes into a dirty-whitish, rather hard, fatty matter. As this oil burns with a delightful fragrance, when receiving ambassadors and on high state occasions, the kings of Candy used to have lamps of it burning in their audience-chamber. The wood itself is pervaded by the same grateful perfume, and walking-sticks of cinnamon-wood are highly prized, as well as little articles of cabinet-work. Some camphor may be procured from the roots. Cassia bark, as we have seen,



Cinnamomum Cassia.

was distinguished with difficulty from cinnamon by the ancients. In the present day it is often sold for cinnamon; indeed, unless a purchaser specify *true* cinnamon, he will probably be supplied with nothing but cassia. It is made up into similar bundles with cinnamon, has the same general appearance, smell, and taste; but its substance is thicker and coarser, its color darker, its flavor much less sweet and fine than that of Ceylon cinnamon, while it is more pungent, and is followed by a bitter taste; it is also less closely quilled, and breaks shorter than genuine cinnamon. Its decoction gives a blue color when treated with tincture of iodine, which the true cinnamon does not. "The great consumers of cinnamon are the chocolate-makers of Spain, Italy, France, and Mexico, and by them the difference in the flavor between cinnamon and cassia is readily detected. An extensive dealer in cinnamon informs me that the Germans, Turks, and Russians prefer cassia, and will not purchase cinnamon, the delicate flavor of which is not strong enough for them. In illustration of this, I was told that some cinnamon (valued at \$s. 6d. per lb.), having been by mistake sent to Constantinople, was unsalable there at any price, while *cassia lignea* (worth about 6d. per lb.) was in great request" (Pereira's *Materia Medica*, p. 1306).
 In the various sources, independently of the differ-

ent qualities, it is evident, as in the case of cinnamon, that the ancients might have been, as no doubt they were, acquainted with several varieties of cassia. These, we have no doubt, are yielded by more than one species. Besides cassia bark, there is also a cassia oil and cassia buds, supposed to be produced by the same tree. There can be no reasonable doubt, as cinnamon and cassia were known to the Greeks, that they must have been known to the Hebrews also, as the commerce with India can be proved to have been much more ancient than is generally supposed. —Kitto, s. v. Cinnamon; Fairbairn, s. v. (See the *Penny Cyclopaedia*, s. v. Cinnamon; Celsii *Hierobot.* ii. 350 sq.; Bodæi a Stapel, *Comm. in Theophr.* p. 284; Knox, *Travels in Ceylon*, p. 82; also Ritter, *Erdk.* VI. iv, pt. ii, p. 123 sq.; Geiger, *Pharmac. Botan.* i, 330 sq.; especially Nees v. Esenbeck, *De Cinnamomo* [Bonn, 1823], and Blume in Wiegmann's *Archiv. für Naturgesch.* 1831, i, 116 sq.; Martius, *Pharmakog.* p. 182, 141; Smith's *Dict. of Class. Antiq.*, Amer. ed., s. v. Cinnamomum.) Comp. **CASSIA**.

Cin'nereth (Heb. *Kinné' reth*, כִּנְרֵת, a *harp*; Sept. *Xevipés*, Vulg. *Cenereth*, Auth. Vers. "Chinnereth;" Num. xxxiv, 11; Deut. iii, 17; Josh. xiii, 27; xix, 85), or **Cin'neroth** (Heb. *Kimmeroth*, כִּמְרֹת, *harps*; Josh. xi, 2, Sept. *Xevipós*, Vulg. *Cemeroth*, Auth. Vers. "Chinneroth;" Josh. xii, 8, Sept. *Xevipés*, Vulg. *Cemeroth*, Auth. Vers. "Chinneroth;" 1 Kings xv, 20, Sept. *Xevipés*, Vulg. *Cemeroth*, Auth. Vers. "Cineroth"), one of the "fenced cities" of the tribe of Naphtali (Josh. xix, 85; compare Deut. iii, 17; Josh. xi, 2; 1 Kings xv, 20). In the last two of the texts cited it seems to indicate a *district*, since it is named with the "land of Naphtali" and other northern places as having been laid waste by Benhadad, king of Damascus, the ally of Asa, king of Judah (1 Kings xv, 20). It probably took its name from the adjacent city or lake of the same name, and was possibly the small enclosed district north of Tiberias, and by the side of the lake, afterwards known as "the plain of Gennesareth." The expression "All Cinneroth" is unusual, and may be compared with "All Bithron"—probably, like this, a district and not a town. It is also the earlier name of the lake *Gennesareth* (which is supposed to be a corruption of *Cinnereth*, Lightfoot, *Works*, i, 496), from which we may collect that the town lay on the western border of the lake, and was of sufficient consequence to give its own name to it (Josh. xii, 8; xiii, 27; Num. xxxiv, 11). Jerome says, but merely on rumor ("ferunt," *Onomast.* s. v. Chennereth), that Tiberias was originally called Cinnereth; which Beiland disputes (*Palæst.* p. 161), as being opposed to Matt. iv, 13. The Jewish Rabbins, moreover, identify (Lightfoot, *Works*, ii, 228) Tiberias with the Rakkath (q. v.) of Josh. xix, 85-88. See **CHINNERETH**. M. de Sauley thinks he has identified the village of *Abu Shakh*, lying on the western edge of the plain el-Ghuweir, on an eminence about at its midlength, at the entrance of wady Rubuduyeh, with the site of Cinnereth (*Narrative*, ii, 359, 364). See **GENNESARET**.

Cippus (Lat. a *post*), a small, low column used by the ancient Romans as a mile-post, or to mark divisions of land; also a tomb-stone of small dimensions, containing a diminutive orifice or place to receive the ashes of the dead, being thus the original of the modern tomb-stone.

Cir'ama, a place whose people (*ἱε Κιραμαῖς*; Vulg. *Gramas*), together with those of Gabdes, came up with Zorobabel from Babylon (1 Esdr. v, 20); for which the Heb. texts (Ezra ii, 26; Neh. vii, 30) have **RAMAH** (q. v.).

Circle (צִיר, *chug*), any part of a curve, an arch. The word is applied (Job xxii, 14, where, however, it is translated "circuit") to the *heavens*, which the ancients supposed to be a hollow sphere. They imagined

that the sky was solid, and extended like an arch over the earth. The word is also referred to the *earth* in Isa. xl, 22, and to the surface of the ocean in Prov. viii, 27, where it is rendered "compass;" in both which passages it still seems to mean the celestial vault, as spanning these. In Wisd. xiii, 2, the Greek term *κύκλος* is so rendered, with reference to the path of the stars. See CIRCUT.

Circuit (קִיפּוּף, *tekyupah'*) signifies the act of going round, as, for example, the apparent diurnal revolution of the sun around the earth (Psa. xix, 6); it is also used with reference to the completion of a year in the original of 2 Chron. xxiv, 28; Exod. xxxiv, 22 (in which passages it is rendered "end"; or of the term of pregnancy in 1 Sam. i, 20 ("when . . . was come about"). The Scriptures, however, afford us very little information as to the astronomical knowledge of the Jews. See ASTRONOMY. In Job xxii, 14, the Heb. word is different. See CIRCLE. In 1 Sam. vii, 16, and Eccles. i, 6, also, a different form of expression is used in the original to signify, in the former passage (קִיפּוּף, elsewhere usually rendered "compass"), a regular tour of inspection, and in the latter (קִיפּוּף) the periodical series of gyrations, or, rather, directions of the winds, which in the East are quite regular in their seasons. In Eccles. xxiv, 5, the original word is γύρος, the rotation of the heavens; but in 2 Macc. vi, 4, it is simply περιβόλος, an enclosure, e. g. of the Temple.

CIRCUIT. In the Methodist Episcopal Church, a single church, supplied by a pastor, is called a *station*; but when one or more appointments, within a definite territory, are united into one charge, under one or more ministers, it is called a "circuit." The English minutes of 1746 give "the first intimation of definite circuits, though it is supposed they existed before. All England was mapped into seven of these itinerant districts." In America the circuit system was universal in the beginning of Methodism, and it is still widely in use in rural districts and in the Western States.—Stevens, *History of Methodism*, i, 818. See METHODIST EPISCOPAL CHURCH.

Circumcellians, a fanatical sort of Donatists in the fourth century, of uncertain origin. From their wandering habits, they were called *Circumcelliones* (from *cella*, the cottages of the peasants around which they hovered, *cellas circumcipientes rusticorum*). They rambled up and down, plundering, burning houses, and murdering all who resisted them, professing to seek the crown of martyrdom. They called themselves *Milites Christi Agonistici*. There is no evidence to show that their conduct was approved by the Donatists, but their proceedings brought great odium on that party.—Mosheim, *Ch. Hist.* cent. iv, pt. ii, ch. v, and cent. v, pt. ii, ch. v; Gieseler, *Ch. History*, per. ii, div. i, § 84; Gibbon, *Decline and Fall*, ch. xxi, xxiii. See DONATISTS.

Circumcision (מִלּוּחַ, *milah'*; Sept. and N. T. technically *περιτομή*, which is translated by the Latin *circumcisio*, i. e. a cutting around), a custom among many Eastern nations of cutting off part of the prepuce, as a religious ceremony. The Jews, through Abraham, received the rite from Jehovah; Moses established it as a national ordinance; and Joshua carried it into effect before the Israelites entered the land of Canaan (see generally Michaelis, *Laws of Moses*, iv, 80 sq.). Males only were subjected to the operation, and it was to be performed on the eighth day of the child's life; foreign slaves also were forced to submit to it on entering an Israelite's family. Those who are unacquainted with other sources of information on the subject besides the Scriptures might easily suppose that the rite was original with Abraham, characteristic of his seed, and practised among those nations only who had learned it from them. This, however, ap-

pears not to have been the case (Celsus, ap. Orig. *contra Celsum*, i, 17, 250; Julian, ap. Cyril, *contra Julianum*, x, 354; compare Marsham, *Canon Chron.* p. 78 sq.; Bauer, *Gottesdienstl. Verfass.* i, 87 sq.; Jahn, i, ii, 277 sq.; see Borheck, *Ist die Beschneidung ursprünglich hebräisch?* [Duisb. and Lemgo, 1798]).

I. Pagan Circumcision.—First of all, the Egyptians were a circumcised people. Vonck (*Observ. miscell.* c. i, p. 66), followed by Wesseling (*ad Herod.* ii, 87) and by numerous able writers, alleged that this was not true of the whole nation, but of the priests only; that at least the priests were circumcised is beyond controversy. No one can for a moment imagine that they adopted the rite from the despised shepherds of Goshen; and we are immediately forced to believe that Egyptian circumcision had an independent origin. A great preponderance of argument, however, appears to us to prove that the rite was universal among the old Egyptians, as long as their native institutions flourished, although there is no question that, under Persian and Greek rule, it gradually fell into disuse, and was retained chiefly by the priests, and by those who desired to cultivate ancient wisdom (see Origen, *ad Jer.* iv, 19; *Ezech.* xxxi, 18; xxxii, 19; and *ad Rom.* ii, 13; Jerome *ad Gal.* iv, p. 477; Horapoll. *Hierogl. Æg.* i, 14, p. 13, ed. Paun; Clem. Alex. *Strom.* i, 180). Herodotus distinctly declares that the Egyptians practised circumcision; and that he meant to state this of the whole nation is manifest, not only since he always omits to add any restriction, but because, immediately following his first statement of the fact, he annexes this remark: "The priests, moreover, shave their whole body every other day," etc. (Herod. ii, 87). It is difficult to suppose that the historian could have been mistaken on this point, considering his personal acquaintance with Egypt. (Artapanus, however, makes a distinction between Jewish and Egyptian circumcision, ap. Euseb. *Præp. Ev.* iv, 27.) Further, he informs us that the Colchians were a colony from Egypt, consisting of soldiers from the army of Sesostrius. With these he had conversed (ii, 104), and he positively declares that they practised circumcision. Yet if the rite had been confined to the priestly caste of Egypt, it could hardly have been found among the Colchians at all. The same remark will apply to the savage Troglodytes of Africa, every branch of whom except one (the Kolobi), as Diodorus informs us (iii, 81), was circumcised, having learned the practice from the Egyptians. The Troglodytes appear to have been widely diffused through Libya, which argues a corresponding diffusion of the rite; yet, from the silence of Diodorus concerning the other savage nations whom he recounts as African Ethiopians, we may infer that it was not practised by them. The direct testimony of Diodorus (i, 28), Philo (*Opp.* ii, 310), and Strabo (xii, 824; comp. Agatharch. ed. Hudson, i, 46) is to the same effect as that of Herodotus respecting Egypt; yet this can hardly be called confirmatory, since in their days the rite was no longer universal. Josephus (*contra Ap.* ii, 13) speaks of it as practised by the priests only; he, however, reproaches Apion for neglecting the institutions of his country in remaining uncircumcised. Origen, in the passage above referred to, confirms the statement of Josephus. In Kenrick's *Herodotus* (ii, 87), the French commissioners who examined some Egyptian mummies are quoted as establishing from them the fact of Egyptian circumcision. Herodotus, moreover, tells us (ii, 104) that the Ethiopians were also circumcised; and he was in doubt whether they had learned the rite from the Egyptians, or the Egyptians from them. By the Ethiopians we must understand him to mean the inhabitants of Meroë or Sennaar. In the present day the Coptic Church continues to practise it, according to C. Niebuhr (quoted by Michaelis); the Abyssinian Christians do the same (Ludolf, *Hist. Æthiop.* i, 19, and *Comment.* p. 268 sq.); and that it was not in-

introduced among the latter with a Judaical Christianity appears from their performing it upon both sexes. (It is scarcely worth while to invent a new name, resection, or resection, for accuracy's sake.) Oldendorp describes the rite as widely spread through Western Africa—16° on each side of the line—even among natives that are not Mohammedan. In later times it has been ascertained that it is practised by the Kafir nations in South Africa, more properly called Kosa or Amakosa, whom Prichard supposes to form “a great part of the native population of Africa to the southward of the equator.” He remarks upon this: “It is scarcely within probability that they borrowed the custom from nations who profess Islām, or we should find among them other proofs of intercourse with people of that class. It is more probable that this practice is a relic of ancient African customs, of which the Egyptians, as it is well known, partook in the remote ages” (Prichard, *Physical Hist. of Man*, 8d ed. ii, 287). Traces of the custom have even been observed among the natives of some of the South Sea Islands (Pickering, *Races of Men*, p. 153, 199, 200, etc.).

How far the rite was extended through the Syro-Arabian races is uncertain (but see Strabo, xvi, 776; Epiphanius, *Hær.* ix, 80; Origen ad *Gen.* i, 10). In the 9th section of the Epistle of Barnabas (which, whether genuine or not, is very old), the writer comments as follows: “But you will say the Jews were circumcised for a sign. And so are all the Syrians, and the Arabians, and the idolatrous priests; . . . and even the Egyptians themselves are circumcised.” This language is vague and popular; yet it shows how notorious was the wide diffusion of the custom (see Hug, in the *Freib. Zeitschrift*, iii, 213). The Philistines, in the days of Saul, were, however, uncircumcised; so also, says Herodotus (ii, 104), were all the Phœnicians who had intercourse with the Greeks. That the Canaanites, in the days of Jacob, were not all circumcised, is plain from the affair of Dinah and Shechem. The story of Zipporah (Exod. iv, 25), who did not circumcise her son until fear came over her that Jehovah would slay her husband Moses, proves that the family of Jethro, the Midianite, had no fixed rule about it, although the Midianites are generally regarded as children of Abraham by Keturah. On the other hand, we have the distinct testimony of Josephus (*Ant.* i, 12, 2) that the Ishmaelite Arabs, inhabiting the district of Nabathæa, were circumcised after their 18th year: this must be connected with the tradition, which no doubt existed among them, of the age at which their forefather Ishmael underwent the rite (*Gen.* xvii, 25). St. Jerome also (quoted by Michaelis) informs us that, to his day, “*usque hodie*,” the tribes dwelling round Judæa and Palestine were circumcised, “especially all the Saracens who dwell in the desert.” Elsewhere he says that, “except the Egyptians, Idumæans, Ammonites, Moabites, and Ishmaelites of the desert, of whom the greater part are circumcised, all other nations in the world are uncircumcised.” A negative argument is more or less dangerous; yet there is something striking in the fact that the books of Moses, of Joshua, and of Judges never bestow the epithet *uncircumcised* as a reproach on any of the seven nations of Canaan, any more than on the Moabites or Ammonites, the Amalekites, the Midianites, or other inland tribes with whom they came into conflict. On the contrary, as soon as the Philistines become prominent in the narrative, after the birth of Samson, this epithet is of rather common occurrence. The fact also of bringing back as a trophy the foreskins of slain enemies never occurs except against the Philistines (1 Sam. xviii). We may perhaps infer, at least until other proof or disproof is attained, that while the Philistines, like the Sidonians and the other maritime Syrian nations known to the Greeks, were wholly strangers to the practice, yet among the Canaanites, and all the more inland ones, it was at least so far common that no general

description could be given them from the omission. It appears from Josephus (*Ant.* xiii, 9) that when Hyrcanus subdued the Idumæans, he forced them to be circumcised on pain of expatriation. This shows that they had at least disused the rite. But that is not wonderful, if it was only a custom, and not a national religious ordinance; for, as Michaelis observes, the clause of it may have dated from the edict of Antiochus Epiphanes, of which it is said (1 Macc. i, 41, 42). “The king Antiochus wrote to all his kingdom that all should be one people; and that all should keep the ordinances of his country; and all the nations acquiesced according to the word of the king.” The rather obscure notices which are found in Jeremiah and Ezekiel of the circumcision of the nations who were in immediate contact with Israel admit of a natural interpretation in conformity with what has been already adduced (*Jer.* ix, 25; *Ezek.* xxxi, 18; also xxxii, 19, *et passim*). The difficulty turns on the new *moral* use made of the term “uncircumcised,” to mean simply *impure*. The passage in Jeremiah is thus translated by Ewald: “Behold, the days come that I visit all the uncircumcised circumcised ones; Egypt and Judah, Edom, and the children of Ammon and Moab; and all the dwellers in the wilderness that are shaven on the temples: for all the heathen are uncircumcised, and so is all the house of Israel uncircumcised in heart.” The shaving of the temples appears to be a religious custom of the same kind: Herodotus (iii, 8) ascribes it to the Arabs generally, and Josephus rather strangely regards the epithet *τρογοκορυπίδες*, in the ancient Greek poet Choerilus (*c. Ap.* i, 22), as a description of his own countrymen. Knowing that the Egyptians were circumcised, it no longer remains doubtful how the *reproach of Egypt* (*Josh.* v, 9) should be interpreted.

How far the rite of circumcision spread over the south-west of Arabia no definite record subsists. The silence of the Koran confirms the statement of Abulfeda (*Histor. Ante-Islamica*, p. 180, ed. Fleischer, 1851) that the custom is older than Mohammed, who, it would appear, in no respect regarded it as a religious rite. Nevertheless it has extended itself with the Mohammedan faith, as though it were a positive ordinance. Pococke (*Specimen Hist. Arab.* p. 809) cites a tradition, which ascribes to Mohammed the words, “Circumcision is an ordinance for men, and honourable in women.” This extension of the rite to the other sex might, in itself, satisfy us that it did not come to those nations from Abraham and Ishmael. We have already seen that Abyssinian circumcision has the same peculiarity; so that it is every way probable that Southern Arabia had the rite from the same source or influence as Ethiopia. In fact, the very closest relations are known to have subsisted between the nations on the opposite coasts of the Red Sea. Another passage of Abulfeda (*Annales Muslemici*, i, 92) gives specific information on this subject. In the battle of Ohod, in the third year of the Hegira, “Hamza, the uncle of the Prophet, committed great slaughter. When Sabbah ben-Abd-ul-Uzza, whose mother was a circumciser in Mecca, passed by him, Hamza called out, Come on, you son of a she-circumciser [*resectricis nympheturum*]!” The form of the word proves that this was strictly the trade of the old woman, and that the custom, as applied to females, was no innovation of those days. Niebuhr had ocular demonstration of female circumcision in Arabia (*Travels*, ii, 261).

Pococke quotes the ecclesiastical historian Philostorgius for the fact that the Himyarite Arabs circumcise their children on the *eighth day*. He adds a passage from Al Gazzali, in which the writer says that the Arabs differ from the Jews as to the time; for they postpone it until the child has teeth, which he thinks safer. Finally, he cites Ibn Athir, who, writing of the times antecedent to Mohammed, says that the Arabs were accustomed to circumcise between the tenth and

fifteenth years. The origin of the custom amongst this large section of those Gentiles who follow it is to be found in the Biblical record of the circumcision of Ishmael (Gen. xvii, 25). Josephus relates that the Arabians circumcise after the thirteenth year, because Ishmael, the founder of their nation, was circumcised at that age (*Ant.* i, 12, 2; see Lane's *Mod. Eg.* ch. ii). Though Mohammed did not enjoin circumcision in the Koran, he was circumcised himself, according to the custom of his country; and circumcision is now as common amongst the Mohammedans as amongst the Jews.

The statement of Philostrorgius may give light from the Arab historians, who relate (Jost, *Geschichte der Israeliten*, v, 286 sq.) that about a century before the Christian era, several Jewish sovereigns reigned in the region called Sheba by the Jews, and Yemen by the moderns, where the Himyarites (or Homerites) dwelt. The few facts preserved show that they were not close observers of the Mosaic law, and the suspicion might arise that they were called Jews chiefly from their having received Jewish circumcision. We have, however, a collateral evidence of much importance, to prove that the influence acting on them had really come from Judea; namely, it is well known that in Abyssinia a nation called the Falasha still exists, which has very thoroughly adopted the Jewish religion, inasmuch as to have invented legends that allege their descent from the Hebrews. They possess the Old Testament in the Gheez language and character, but their own language is said to be quite alien from the Hebrew; facts which prove that they were really proselyted by the Jews at some early period. See ABYSSINIA. At that same time, it is credible, the Hebrew faith met with similar success on the opposite coast of the Red Sea. Jost believes that, during the war of the Maccabees, great numbers of Jews migrated into Arabia; and it is certain that in later times they were very numerous in Yemen, and their influence great. Wherever they were settled proselytes must have been made; and great zeal was doubtless used to induce them to circumcise their children duly according to the Mosaic rite. We can then quite understand Philostrorgius's fact, if we are allowed to suppose that he spoke loosely of "the Himyarites" doing that which was done by a great many of them. An interesting story is told by Josephus—the date so late as the reign of the Emperor Claudius (*Ant.* xx, 2)—how Izates, the young king of Adiabene, and his mother Helena, were converted by Jewish teachers to a belief in the one true God, the God of the Hebrews: and how, when Izates was desirous of being circumcised, and his mother dreaded that it would alienate his subjects, his Jewish instructor Ananias warmly seconded her views, with a heart like that of Paul; telling him that if he was resolved to imitate Jewish institutions, he could, without being circumcised, adore the true divinity; and that this was far more important than circumcision. At the time he satisfied the young monarch; but afterwards, another Jew, named Eleazar, came from Galilee, and inveighed so strongly on the impety of his disobedience, that, without more delay, Izates submitted to the rite. It is evident that, in a controversy of this sort, the more narrow-minded teacher had the advantage; and, in consequence, it appears that "proselytes of righteousness" were always circumcised (*Judith* xiv, 10, and *Tacit. Hist.* v, 5). The facility with which whole nations have adopted the practice from the Mohammedans proves that it is not so serious an obstacle to the spread of a religion as some have thought it (see the *Penny Cyclopædia*, s. v.).

II. *Jewish Circumcision.*—1. *History.*—When God announced to Abraham that he would establish his covenant with him, he said to him, "This is my covenant, which ye shall keep between me and you, and thy seed after thee: Every man-child among you shall be circumcised. And ye shall circumcise the flesh of

your foreskin; and it shall be a token of the covenant betwixt me and you" (Gen. xvii, 10, 11). It was also ordained that this should be extended to servants belonging to Abraham and his seed, as well as to their own children; and that in the case of children it was to be done on the eighth day after birth. This was appointed as an ordinance of perpetual obligation in the Abrahamic family, and the neglect of it entailed the penalty of being cut off from the people (12-14). In compliance with this, Abraham, though then ninety-nine years of age, was himself circumcised and all his household, including Ishmael. On the birth of his son Isaac, the rite was attended to with regard to him (Gen. xxi, 4); and it continued to be observed by his posterity, and distinctively to characterize them from the people amidst whom they dwelt (Gen. xxxiv, 14, 15). The usage thus introduced by Abraham was formally enacted as a legal institute by Moses (*Lev.* xii, 8; comp. *John* vii, 22). Slaves, whether home-born or purchased, were circumcised (Gen. xvii, 12, 13); and foreigners must have their males circumcised before they could be allowed to partake of the passover (*Exod.* xii, 48), or become Jewish citizens (*Judg.* xiv, 10. See also *Esth.* viii, 17, where for Heb. מְצִיטֵי יְהוּדִים, "became Jews," the Sept. has *περιεμύοντο καὶ Ἰουδαίων*). In short, it was appointed to be observed in relation to all who became proselytes from heathenism to Judaism (comp. *Judith* xiv, 10; *Maimonides, Issure Biah*, c. 18, cited by Lightfoot, *Harmonia Evang.* sec. 12). The penalty of death for a neglect of this ordinance appears in the case of Moses to have actually been demanded of the father, when the Lord "sought to kill him" because his son was uncircumcised (*Exod.* iv, 24-26). During the passage through the wilderness the practice fell into disuse, so that of those who entered Canaan none had been circumcised. As this was fatal to their title under the covenant to take possession of the land, Joshua, in obedience to God's command, caused all the males to be circumcised (*Josh.* v, 2-9). The most satisfactory explanation of this neglect appears to be, that the nation, while bearing the punishment of disobedience in its forty years' wandering, was regarded as under a temporary rejection by God, and was therefore prohibited from using the sign of the covenant. This agrees with the mention of their disobedience and its punishment, which immediately follows in the passage in Joshua (verse 6), and with the words (verse 9), "This day have I rolled away the reproach of Egypt from off you." The "reproach of Egypt" was the threatened taunt of their former masters that God had brought them into the wilderness to slay them (*Exod.* xxxii, 12; *Num.* xiv, 18-16; *Deut.* ix, 28), which, so long as they remained uncircumcised and wanderers in the desert for their sin, was in danger of falling upon them. (Other views of the passage are given and discussed in Keil's *Commentary on Joshua*, p. 129.) From this time forward it became the pride of the nation to observe this ordinance; on all those people who did not observe it they looked down with contempt, not to say abhorrence (*Judg.* xiv, 8; *xv*, 18; *1 Sam.* xiv, 6; *xvii*, 26; *2 Sam.* i, 20; *Isa.* lii, 1; *Ezek.* xxxi, 18; *Ephes.* ii, 11, etc.); and so much did it become a rite distinctive of them, that their oppressors sought to prevent their observing it—an attempt to which they refused to submit, though threatened with the last penalties in case of disobedience (*1 Macc.* i, 48, 50, 60-62). The introduction of Christianity was the signal for the abolition of this rite in the Church of God; as the old covenant had waxed feeble and was passing away, that which was the token of it also ceased to be binding; the rule was proclaimed that "in Christ Jesus neither circumcision availeth anything nor uncircumcision, but a new creature" (*Gal.* vi, 15; *Col.* iii, 11), though among the Jewish Christians were still found many who clung tenaciously to

their ancient distinctive rite, and would have imposed it even on the Gentile converts to Christianity (Acts xv, 1; Gal. vi, 12, etc.). Our Lord himself was circumcised, because it became him who was of the seed of Abraham according to the flesh to fulfil all righteousness, and because he was "a minister of the circumcision for the truth of God, to confirm the promises made unto the fathers" (Rom. xv, 8); and Paul caused Timothy to be circumcised to avoid offence to the Jews, his mother being a Jewess; but the spirit of Christianity was averse from such institutions (Acts xv, 1-11; Gal. ii, 8, etc.).—for the outward carnal circumcision it sought to substitute that of the heart (Rom. ii, 28, 29), "the circumcision not made with hands in putting off the sins of the flesh, even the circumcision of Christ" (Col. ii, 11).

Among the ancient Jews, the rule that circumcision should take place on the eighth day after birth was rigidly followed (Luke i, 59; ii, 21; Phil. iii, 5), save in such very exceptional cases as those mentioned Exod. iv, 25; Josh. v, 5. Even their reverence for the Sabbath did not prevent the Jews from observing it on that day (John vii, 22, 23); according to the Rabbin's 'circumcision "pellit Sabbatum" (Lightfoot, *Hor. Heb. in Joan. vii, 22*). The operation might be performed by any Israelite, but usually it was performed by the father of the child; in special cases women might perform it (Exod. iv, 25). The instrument used in the earlier times was a sharp stone or a knife of flint (Exod. iv, 25; Josh. v, 2, 3; comp. the *λίθος Αἰθιοπικός*, used by the Egyptians in preparing bodies for embalming, Herod. ii, 86). See KNIFE. The operation was a painful one, at least to grown persons (Gen. xxxiv, 25; Josh. v, 8), and requires about three days for the inflammation to subside (Arvieux, iii, 146). It was usual to connect the naming of the child with the circumcision (Gen. xxi, 3, 4; Luke i, 59; ii, 21), a practice which probably had respect to the fact that it was in connection with the institution of the rite that God gave to the ancestor of the race his name of Abraham (Gen. xvii, 5). See NAME.

2. *Obtiteration by apostate Jews.*—Some of the Jews in the time of Antiochus Epiphanes, wishing to assimilate themselves to the heathen around them, built a gymnasium (*γυμνάσιον*) at Jerusalem, and, that they might not be known to be Jews when they appeared naked in the games, "made themselves uncircumcised" (1 Macc. i, 15, *ἐποίησαν ἑαυτοῖς ἀποβυστρία;* *vulg. fecerunt sibi prepucia;* Joseph. *Ant. xii, 5, 1, τὴν ῥαυ αἰδοῦσιν περιτομὴν ἐγκαλιπτεῖν*). Sometimes this was done by a surgical operation, such as Celsus describes (*De Medic. vii, 25*; comp. Galen, *Meth. Med. xiv, 16*; Paul Ægin. vi, 53; Epiphanius, *De pond. et mens. p. 538*, ed. Basil. 1544), sometimes by other means (Dioscor. iv, 157). The term for this was *ἐπισπᾶσθαι* (Talm. *מְשַׁח עֵרְוָה*), i. e. *drawing over again*, sc. the prepuce (4 Macc. vii; see Bartholin. *Morb. bibl. xxvi*). Against having recourse to this practice from an excessive anti-Judaistic tendency, the apostle Paul cautions the Corinthians in the words, "Was any one called being circumcised, let him not become uncircumcised" (*μη ἐπισπᾶσθω*, 1 Cor. vii, 18). See the Essay of Groddeck, *De Judaicis prepucibus attrahentibus* (Lips. 1699); also in Schöttgen's *Hor. Hebr. ii*; and in Hassel et Ikenii *Nov. The. ii, 798 sq.*; and in Ugolini *Theaur. xxii*; Engel, *De Judæorum prep. attrah.* (Lips. 1699); Lossius, *De epispasmo Judæico* (Jen. 1665); also in Schlegleri *Dis. rar.* (Helmst. 1743, ii, 89 sq.); Wedell, *Æsercitt. med. philol. I, v, 1 sq.*; Ludolf, *Comm. in Hist. Æth. p. 270*; Lühkert in the *Stud. u. Krit.* 1886, iii, 657; comp. Fabricii *Bibliogr. Anfig. p. 546 sq.* See FORESKIN.

3. *Figurative Use of the Term.*—The moral meaning of the word "uncircumcised" was a natural result of having been made legally essential to Hebrew

faith. "Uncircumcised in heart and ears" was a metaphor to which a prophet would be carried, as necessarily as a Christian teacher to such phrases as "unbaptized in soul," or "washed by regeneration." It was a well known and readily understood symbol of purity.—Kitto, s. v.; Smith, s. v.

4. *Modern Usages.*—The ceremony of circumcision, as practiced by the Jews in our own times, is thus: If the eighth day happens to be on the Sabbath, the ceremony must be performed on that day, notwithstanding its sanctity. When a male child is born, the godfather is chosen from amongst his relations or near friends; and if the party is not in circumstances to bear the expenses, which are considerable (for after the ceremony is performed a breakfast is provided, even amongst the poor, in a luxurious manner), it is usual for the poor to get one amongst the richer, who accepts the office, and becomes a godfather. There are also societies formed amongst them for the purpose of defraying the expenses, and every Jew receives the benefit if his child is born in wedlock. The ceremony is performed in the following manner, in general.

The circumcisor being provided with a very sharp instrument, called the circumcising knife (see Quandt, *De cultus circumcisoris Judæorum*, Regiom. 1719), plasters, cummin-seed to dress the wound, proper bandages, etc., the child is brought to the door of the synagogue by the godmother, when the godfather receives it from her and carries it into the synagogue, where a large chair with two seats is placed; the one is for the godfather to sit upon, the other is called the seat of Elijah the prophet, who is called the angel or messenger of the covenant. As soon as the godfather enters with the child, the congregation say, "Blessed is he that cometh to be circumcised, and enter into the covenant on the eighth day." The godfather being seated, and the child placed on a cushion in his lap, the circumcisor performs the operation, and, holding the child in his arms, takes a glass of wine into his right hand; and says as follows: "Blessed be thou, O Lord our God, King of the Universe, Creator of the fruit of the vine. Blessed art thou, O Lord our God! who hath sanctified his beloved from the womb, and ordained an ordinance for his kindred, and sealed his descendants with the mark of his holy covenant; therefore for the merits of this, O living God! our rock and inheritance, command the deliverance of the beloved of our kindred from the pit, for the sake of the covenant which he hath put in our flesh. Blessed art thou, O Lord, the Maker of the Covenant! Our God, and the God of our fathers! preserve this child to his father and mother, and his name shall be called in Israel, A, the son of B. Let the father rejoice in those that go forth from his loins, and let his mother be glad in the fruit of her womb; as it is written, 'Thy father and mother shall rejoice, and they that begat thee shall be glad.'"

The father of the child says the following grace: "Blessed art thou, O Lord our God, King of the Universe! who hath sanctified us with his commandments, and commanded us to enter into the covenant of our father Abraham." The congregation answer, "As he hath entered into the law, the canopy, and the good and virtuous deeds." (See Buxtorf, *Synagoga Judaica*, ch. ii.)

III. *Design of the Institution.*—Herodotus long ago declared that it was adopted by the Egyptians for cleanliness (*καθαριότητος ἕνεκα*); and a slight acquaintance with the ideas of the Turks concerning personal defilement will make it easy to believe that an idea of cleanliness continued the practice among nations which had once become habituated to it. In the ancient Egyptians this Turkish spirit was carried to a great height; nor is it wonderful that in hot climates detailed precepts of cleanliness form a very large part of primitive religion. But we can hardly rest in this as a sufficient account of the origin of the rite (see

Deyling, *Observatt.* ii, 38 sq. [also in *Ugolini Theaur.* xxii]; Buddei *Hist. Eccl.* V, I, l. 175 sq.; Meyer, *De tempp. et fest. Hebr.* ii, 7, p. 512 [*Ugolini Theaur.* i]; Grappii *Diss. an circumcisio ab Eg. fuerit derivata* [Jen. 1722]; Witaii *Æg.* iii, 6, p. 283 sq.; Bynæus, *De circumcis. Christi* [Amst. 1689], p. 27 sq.; Carpzov, *Appar.* p. 602 sq.; Sturz, *Circumcisio a barbaris gentibus translata* [Ger. 1790]). It is more important to state that an adequate physical reason for performing the operation on females of several African races has been fully substantiated. The curious reader will find in Laurence's *Lectures* (chap. v) the decisive testimony of Mr. Barrow and Dr. Somerville on this point, with an allusion to the efforts of the Romish missionaries to forbid the practice in Abyssinia, and the unexpected consequences which thwarted them. No positive evidence has yet been obtained that the operation is equally expedient for the males in any of the same races; yet the analogy of the two cases forces us to believe that in both the custom has a physical or medical ground, especially when it is remarked to predominate so much in Africa, where alone (as far as yet appears) such physical peculiarities of structure exist. It was practised, moreover, by the males of African tribes so savage, and so little addicted to religious ceremonialism, that a broader ground must be sought for it than simple cleanliness. We have already named the Troglodytes. Strabo mentions two other tribes of Africa, whom he calls Kreophagi and Kolobi (xvi, 4, p. 387-390, 392, ed. Tauch.), who practised on themselves a yet more shocking mutilation (*κολοβοι τὰς βαλάνους*), ascribed to the Kolobi by Diodorus also. The fact, also, that most of these nations performed whatever operation it was, not on infants, but on those who were advancing towards marriageable age, conspires to indicate that some physical inconvenience gradually showed itself (as with the Bushmen females), of which they desired to get rid. Jost looks upon *infans* circumcision as the distinguishing mark of Judaism; and this may be nearly correct, though we have seen that, according to Abulfeda, some Arabs delayed it only till after teething. In fact, Diodorus (iii, 31), when speaking of that branch of the Troglodyte nations which was called Kolobi, declares that they were subjected to the operation in infancy (*ἐκ νηπίου*). Their unnatural and cruel custom is possibly to be referred to superstition. Some, indeed, have looked on circumcision itself as a softened form of the barbarous rite by which the Galli, or priests of Cybele, were qualified for their office. The Kolobite custom might, on the contrary, be a carrying out of that barbarity to the extreme point possible, short of exterminating the population of a tribe. Traditionary or superstitious reasons certainly can alone explain the presence of the custom among the Sandwich Islanders (Michaelis, *Orient. Biblioth.* xiv, 50 sq.), and aboriginal Americans (Gumilla, *Histoire de l'Oroquois*, Avign. 1708, i, 183 sq.), for physiological considerations, seem to fail (see Burdach, *Physiol.* iii, 386). If an independent and human origin has been discovered for Egyptian circumcision, the thought of necessity arises that the Israelites must have had it from the same sources as the nations around them, and it has been discussed (Spencer, *De Leg. Heb.* I, iv, 4, p. 70 sq.) whether they even borrowed it from the Egyptians. (Movers thinks [*Phœnic.* i, 362] that the latter borrowed it from the Phœnicians, resting on the myth of Saturn, in Sanchoniatho, *Fragm.* p. 36.) The idea has naturally given much offence; but, in truth, the question involves no peculiar difficulty; it is only a part of another far wider inquiry. It is notorious that many other ancient nations had various ceremonies and institutions in common with the Jews, and that the Hebrew law is by no means in all points original. That sacrifice pre-existed is on the surface of the Bible history. The same, however, is true of temples, tabernacles, priests, ever-burning fire, oracles, etc. The fact has been often de-

noted by saying that the Jewish institutions are a selection, revision, and re-enactment of an older patriarchal religion. Other treatises on the Gentile origin of circumcision are by Hofmann (Altorf, 1771), Rus (Jen. 1707), Zeibich (Ger. 1770), Anton (Lips. 1682).

Circumcision, then, as practised by the Gentiles, was simply an expedient to promote health, facilitating cleanliness, and preventing certain painful affections, such as that of the *gonorrhœa spuria* (from *phymosis*, or stricture), and especially the *ἀνθραξ*, or "carbuncle," to which, in hot climates, men are subject (Josephus, *cont. Apion.* ii, 13; Niebuhr, *De l'Arabie*, ch. xix), or an unusual prolongation of the part in question (Thevenot, i, 58; Haquet, in Voigt's *Magas. für Phys.* vi, 443; but see Danz, in Baldinger's *Magas. für Aerzte*, xiv, 416 sq.). In so far as it served this end, the Israelites had, of course, the benefit of it; but that this formed the reason and design of its appointment by God, though asserted by some men of learning and ability, seems utterly untenable; for, in the first place, this opinion is without the slightest support from Scripture; often as the subject is referred to there, we find no hint as to this being the purpose of the observance; 2dly, This hypothesis is quite opposed to the account given by Moses of the introduction of the rite among the Israelites; 3dly, It is absurd to suppose that a mere prophylactic usage should by God be elevated to the solemnity of a religious ordinance; 4thly, Whatever advantages in a hygienic respect might accrue from the practice, these were confined to individuals; circumcision is not necessary for health to men generally in hot climates (Niebuhr, loc. cit.); and therefore to oblige the whole male community to undergo this process in infancy for purposes of health would have been to act as unwise a part as if it had been enjoined that every one should lose a limb, because it was possible that some one might contract severe disease in that limb if allowed to remain; and, 5thly, If circumcision was a mere hygienic precaution, why should it have been abolished by Christianity? why should the apostles have held it to be so hostile to Christianity? and why should the difficulty of becoming a Christian have been increased by the prohibition to those who embraced Christianity of a necessary condition of their children's health? See Philo, *De Circumcis.* in *Opp.* ii, 210 sq.; Ackermann, in *Weise's Materialien für Gottesgelahrtheit* (Gera, 1784), i, 50 sq.; Schulz, *Exercitiat.* i, ii; Michaelis, *Orient. Bibl.* xxii, 8 sq.; Rust, *Handb. d. Chirurgie*, v, 80; Hoffmann, *De causa fecunditatis gentis circumcisæ* (Lips. 1789); Wolfshelmer, *De causis fecunditatis Hebræor.* (Hal. 1742); Vogel, *Dubia de usu circumcisiois medico* (Gott. 1768); Meiners, *De circumcis. origine et causis* (in the *Comment. Soc. Gott.* xiv, 207 sq.; and his *Krit. Gesch. d. Relig.* ii, 478 sq.). On the supposed tendency of the custom to prevent excessive venery (Michaelis in Bertholdt's *Journ.* iv, 356), especially onanism (Buxtorf, *Lex. Chald.* col. 112 sq.), see Schneider in Henke's *Zeitschrift f. Staatsarzneik.* v, iv, 223. For other reasons, see Photius, *Ep.* 205.

When first appointed by God, circumcision was expressly set forth as a token of the covenant which God had made with Abraham; and the apostle tells us that Abraham received "the sign of circumcision as a seal of the righteousness of that faith which he had, being yet uncircumcised" (Rom. iv, 11); so that to Abraham it was not only a sign or token of God's covenant, but also an obsequation or certificate that he was in a state of acceptance before he was circumcised. As a Mosaic institution, it was also the sign of the covenant which God made with Israel, which is hence called the "covenant of circumcision" (Acts vii, 8). In consequence of this, it became the medium of access to the privileges of the covenant, and entailed on all who received it an obligation to fulfil the duties which the covenant imposed (Rom. ii, 25; iii, 1; Gal. v, 8). In a word, it was the token which assured to Abraham

and his descendants the promise of the Messiah (Gen. xvii). It was thus made a necessary condition of Jewish nationality. Circumcision served also to separate the people of the Jews from the rest of the nations, as a people set apart to God. These were its uses. As respects its meaning, that was symbolical, and the things which it symbolized were two: 1. Consecration to God; and, 2. Mental and spiritual purification (Exod. vi, 12; Lev. xix, 25; Deut. x, 16; xxx, 6; Isa. lii, 1; Jer. iv, 4; vi, 10; Rom. ii, 25-29; Col. ii, 11, etc. Compare Philo, *De Circumcisione*; Jones, *Figurative Language of Scripture*, Lecture v, p. 185). "There was thus involved the concept of consecration, and along with this that of reconciliation, in circumcision; and it was thereby, as Ewald rightly remarks (*Alerth.* p. 95), an offering of the body to Jehovah, which, according to the true meaning of all the offerings, as fully developed and raised to their true elevation by the prophets, had to be presented to him as an offering of the soul. Only as this inner offering was perfectly presented could the obligation to be a priestly kingdom and a holy people be fulfilled" (Vaihinger in Herzog's *Real-Encykl.* ii, 110).—Kitto, s. v.

On this subject in general, see Spencer, *De Legibus Heb. ritualibus*, i, 5; Michaelis, *Commentaries on the Laws of Moses*, iii, 58-98; Witsius, *De Fœdere*, bk. iv, 6, 8; Lokevitz, *De circumcissione Judæorum* (Vitæb. 1769-80); Smeets, *De circumcissione Abrahamo divinitus data* (Franec. 1690); Bergson, *Beschneidung vom historischen, krit. u. med. Standpunkt* (Berlin, 1844); Brescher, *Die Beschneidung der Israeliten von der hist., praktisch-operativen u. ritualen Seite* (Vienna, 1845); Heymann, *Die Beschneidung in pathol. Bedeutung* (Magdeb. 1844); M. G. Salomon, *Die Beschneidung, hist. u. medicinisch beleuchtet* (Braunsch. 1844); S. Salomon, *Phimosiæ nebst Beschneidung* (Hamb. 1838); Schmid's ed. of Maimonides, tract פְּרָקִי (Strasb. 1661, 1700); Wolfers, *Die Beschneidung der Juden* (Lamförd. 1831).

IV. *Christian Views on the Subject.*—"The attitude which Christianity, at its introduction, assumed towards circumcision was one of absolute hostility, so far as the necessity of the rite to salvation, or its possession of any religious or moral worth were concerned (Acts xv; Gal. v, 2). But while the apostles resolutely forbade its imposition by authority on the Gentiles, they made no objection to its practice, as a mere matter of feeling or expediency. Paul, who would by no means consent to the demand for Titus, who was a Greek, to be circumcised (Gal. ii, 8-5), on another occasion had Timothy circumcised to conciliate the Jews, and that he might preach to them with more effect as being one of themselves (Acts xvi, 8). The Abyssinian Christians still practice circumcision as a national custom (see Gibbon, *Decline and Fall*, N. Y. edition, iv, 565). In accordance with the spirit of Christianity, those who ascribed efficacy to the mere outward rite are spoken of in the N. T. almost with contempt as 'the concision' or 'amputation' (*τῆν κατατομήν*); while the claim to be the true circumcision is vindicated for Christians themselves (Phil. iii, 2, 8). An ethical idea is attached to circumcision in the O. T., where uncircumcised lips (Exod. vi, 12, 30), or ears (Jer. vi, 10), or hearts (Lev. xxvi, 41) are spoken of, i. e. either stammering or dull, closed as it were with a foreskin, or rather rebellious and unholy (Deut. xxx, 6; Jer. iv, 4), because circumcision was the symbol of purity (see Isa. lii, 1). Thus the fruit of a tree is called uncircumcised, or, in other words, unclean (Lev. xix, 23). In the N. T. the ethical and spiritual idea of purity and holiness is fully developed (Col. ii, 11, 18; Rom. ii, 28, 29)" (Smith, s. v.).

V. *Relation to Christian Baptism.*—1. The ethical and spiritual value of circumcision did not depend on its existence or use prior to its adoption by God as a symbol of true religion. The condescension of Christ consecrated and elevated old rites to new spheres,

upon the principle that "what God hath cleansed that call not thou common." On this principle he elected the baptismal purification, and the simple elements of his Supper. When the covenant with Abraham had reached its full development, including all the seminal elements for the future growth of his Church in the world, God ratified it by the seal of circumcision. Whatever was afterwards added to the polity of the Church or nation worked no modification of the great principles involved, but was rather called into being by the exigencies of times and circumstances. This rite, as a symbol, bespoke the consummation of the Abrahamic covenant in all its power and fulness of temporal, as well as eternal and heavenly interests.

2. This ordinance included in its significance, as a fitting and most impressive emblem, deep spiritual truths. The history of circumcision, in its connection with the Abrahamic covenant and religion, clearly exhibits the nature of the things it symbolized by the direction of its figurative applications. In involving and engaging moral and mental purity, through faith and worship towards Abraham's God, it became the token of spiritual blessings to the pious Israelite in whatever foreign regions he might dwell, notwithstanding he might never be permitted to behold Palestine or the holy city. For he alone was a Jew and a real son of Abraham, entitled to the immunities of the Covenant, whose circumcision was "of the heart; in the spirit, and not in the letter; whose praise is not of men, but of God" (Rom. ii, 28, 29). Profligacy in the national government, though it might bring afflictions, could not nullify the spiritual law, or make void the seal upon the faithful. "All are not Israel which are of Israel" (Rom. ix, 6). The *Πετροποιή καρδίας, ἐν πνεύματι*—"Circumcision in heart, in spirit"—was then, as it is now, the only means of union with the Messiah; and, regarding the nation, therein was Abraham's seed an *imperium in imperio*.

3. The relation, therefore, of CIRCUMCISION to CHRISTIAN BAPTISM is manifest. Both are initiations into peculiar religious privileges and immunities, the emblems of inward cleansing, the signs and seals of consecration to and faith in the God of Abraham. Baptism follows and succeeds to the ancient rite, not because of external likeness, but on account of identity of offices and import, in sealing and imaging the same spiritual truths. For the saving economy of Jehovah has been the same from the beginning; only the instruments, furniture, and external appliances have undergone change. The Zion of the old is the Zion of the newly-arranged Church; the *ἱερόσολον*—has only been purged, its arena enlarged, and the machinery of the garnering process changed from a specific to a general object, from the national to the comital. The pious patriarch was a Christian in everything but name and extent of privilege. The longitude of the atonement is for all time, and the existence of the blessed; its latitude the breadth of the race. The change of the symbolic seal adapts it to a wider sphere, yet it is only in the visible form, not in the substance; it becomes a new and more eligible likeness of the same things. "Circumcision and baptism correspond in meaning. They both relate to the renewal of the heart" (Carson, p. 867). It was a mark of distinction made upon those entering into covenant with God for worship and salvation; can baptism be either less or more? Compare Andrew Fuller, *Lect. Gen. xvii*; Dr. L. Chase, *Design of Baptism*, in *Eagl. Tracts for the Times*, p. 26.

4. The writers of the N. T. bear testimony to the view here presented. St. Paul uses the very impressive words "buried with him" (Christ) "in baptism"—*συναφέντες αὐτῷ ἐν τῷ βαπτισματι* (Col. ii, 12), as synonymous with and explanatory of *ἡ περιτομή τοῦ Χριστοῦ*, "the circumcision of Christ." Whatever is

tensity there is in the words "buried with him," it was only the effort of the apostle to show how "baptism into Christ" was like circumcision; it "put off the body of the sins of the flesh." Had such not been the scriptural meaning of circumcision, Paul would never have thus reasoned. What better testimony could be desired to prove the relation of the two rites, and that the one had succeeded the other? Objections from a want of external agreement or circumstances of administration can be of no force. The Greek *κτετορομή*, the Latin *circumcisio*, are etymological parities, but they are neither of them analogical forms with the Heb. כְּרִית, employed as a *technic* in Gen. xvii. Yet the idea of the rite is, perhaps, as perfect under the Shemitic as under the European form.

5. The early ecclesiastical writers universally held the views here given. Their doctrine, made dependent on John iii, 5, that *βάπτισμα ἐξ ὕδατος καὶ πνεύματος*, baptism of water and the Spirit, was equivalent to *ἀναγέννησις ἐξ ὕδατος καὶ πνεύματος*, regeneration by water and the Spirit, caused them to speak of baptism as *ἡ περιτομή πνευματικῆ*, spiritual circumcision, because the Spirit was always joined with the water in the baptism of an infant, or a converted, believing adult.

6. In Justin Martyr baptism is very frequently alluded to as the "true circumcision," of which the ancient rite was a type (Apol. i, 61; Dial. c. Trypho. 41). "God commands you to be washed with this purification, and to be circumcised with the true circumcision" (*λουσασθαι ὑμῖν τοῦτο τὸ λουτρὸν κλεῖδι ὁ Θεός, καὶ περιτέμνεσθαι τὴν ἀληθινὴν περιτομὴν*) (Dial. c. Trypho. § 18). He says that Christians "had not received the fleshly circumcision, but the spiritual one, which Enoch and those like him made use of; and we received it—*διὰ τοῦ βαπτίσματος—through baptism*," etc. (*ib.* § 43; comp. § 19). In § 29 of this dialogue he speaks of circumcision under the law as baptism. He says, "What need have I for circumcision who have the testimony of God in my favor?" (*Τίς ἐκτείνου τοῦ βαπτίσματος χρεια ἀγίῳ πνεύματι βεβαπτισμένῳ*); "What need have I of baptism" (circumcision) "who have been baptized with the Holy Ghost?" This must be esteemed as a remarkable identification of the two rites, for we should not forget that, as the ordinance of baptism was to Justin "the water of life" (Dial. c. Trypho. § 14), so to receive it was to be baptized with the Holy Ghost. From the same point of view Basil asks certain ones who delayed baptism, "Do you put off the circumcision made without hands—*ἀχειροποιήτων περιτομῆν*—in putting off the flesh, which is performed in baptism?" (*ἐν τῷ βαπτίσματι τελειομένην*), *Orat. exhort. ad Bapt.* t. ii, ed. Ben. (Par. 1721). Cyprian and his council, *Ep.* lxiv, ad Fid., held in the baptism of infants that the analogy then followed of ancient circumcision should not be binding (*Nec spiritalium circumcicionem impediri carnalium circumcicionem debere*): "Nor ought the spiritual circumcision" (baptism) "to be hindered by the carnal circumcision." On the principle that Christ was the real baptism in the Christian rite, Tertullian calls Christ *Novæ circumcicionis Purgator*, "the PURIFIER of the new circumcision" (*adv. Jud.* 3, 4; comp. Ambrose, lib. ii, *De Abrahamo Patr.* c. 11; Irenæus, *Har.* lib. iv, 80).

7. It remains to be observed, briefly, that the objection to circumcision (Acts xv; Gal. v, 2) was not to the rite itself, which was a seal of the covenant of promise, not of law, and must stand till abrogated by the perfection of the seed in Christ, and a new symbol be adopted in its stead. As the objects of the covenant were to be attained not by seminal propagation, but by moral and spiritual means, among all nations, it was fitting that the seal should correspond to these in its import. The "hostility," therefore, was not to circumcision, but to the claim of salvation through the keeping of the law which it enjoined. In this, Christ

would be set aside. Circumcision, in its proper sphere, was not "worthless," or it never had been "the seal of the righteousness of faith." The ancient symbol was gradually to melt away in the affections of the Jew, and by a wise moderation the apostles saw it accomplished. See, on this subject, Wardlaw, *Diss. on the Script. Authority of Infant Baptism*, p. 29-87; Hibbard, *Christian Baptism*, p. 61-63; Pond, *On Baptism*, p. 82-85; Rice, *On Baptism of Infants*, ch. iii; Fairbairn's *Typology of Scripture*, i, 274-277; Dwight, *Theology*, Serm. cxlviii; Watson, *Institutes*, ii, 616-626; Wesley, *Works*, N. Y. ed. vi.; Buchanan, *On Justification*, Edinb. 1867, p. 68-78.

CIRCUMCISION, FESTIVAL OF THE, a festival celebrated in the Roman and English churches on the 1st of January, in commemoration of the circumcision of Christ. After the introduction of the festival of Christmas, the 1st of January was distinguished as *octava natalis Domini*, the octave of the nativity, as Christ was circumcised on the eighth day. "At first it was observed rather as a day of humiliation than of feasting; and this was designed to mark the difference between the manners of Christians and those of the heathen, who celebrated the kalends of January, as the chief day of their saturnalia, with great licentiousness" (Farrar, s. v.). The festival originated, probably, in the 7th century.—Siegel, *Handbuch d. kirchlich-christlichen Alterthümer*, I, 207, and references there.

Cis (Κίς v. r. Κείς), the Græcized form (Acts xiii, 21) of the name of KISH (q. v.), the father of king Saul.

Cis'ai (rather *Cisæus*, Κισαῖος), another Græcized form (Esth. xi, 2) of the name of KISH (q. v.), the great-grandfather of Mordecai (Esth. ii, 5).

Cisleu. See CHISLEU.

Cisneros. See XIMENES.

Cistercians (or CISTERTIANS), an order of monks founded in the year 1098 by Robert, a Benedictine, and abbot of Molême, in Burgundy. Finding it impossible to preserve discipline in his convent, he retired, with twenty of his best monks, to Cîteaux, in the diocese of Chalons, where he laid the foundations of the famous order named from the place. Robert, being ordered by the pope to resume the government of the abbey of Molême, was succeeded in that of Cîteaux by Alberic; and pope Paschal II, by a bull of the year 1100, took Cîteaux under his protection. Alberic drew up the first statutes for the monks of Cîteaux, or Cistercians, in which he enjoined a strict observance of the rules of St. Benedict. The habit of the order was a white robe in the form of a cassock: it was at first black; but they pretend that the holy Virgin, appearing to Alberic, gave him a white habit, and from this time they changed the black for white, retaining the black scapular and hood: their garment was girt with a black girdle of wool: in the choir they had a white cowl, and over it a hood, with a rochet hanging down before to the waist, and in a point behind to the calf of the leg. In memory of the change of habit, a festival was observed on the 5th of August, called "The descent of the blessed Virgin at Cîteaux, and the miraculous changing from black to white." The order made surprising progress. "From the very first, the Cistercians were the spoiled children of the apostolic see, and every conceivable privilege and exemption was heaped upon them" (*Christian Remembrancer*, July, 1867, p. 4). About 1128 the first Cistercian abbey in England was founded by Giffard, bishop of Winchester, at Waverley, Surrey. The order spread in England rapidly, and accumulated vast estates. Eighty-five abbeys in various parts of England owned the maternity either of Cîteaux or Clairvaux. Fifty years after its institution the order had five hundred abbeys; and one hundred years after it boasted of one thousand eight hundred abbeys, most of which had been founded before the year 1200.

The government of the order was in the hands of twenty-five *definitores*, the first of whom was the abbot of Cîteaux, who, as abbot general, was the head of the whole order. Next to him in dignity were the abbots La Ferté, Pontigny, Clairvaux, and Morimond, the four oldest convents after Cîteaux. The abbot of Cîteaux appointed four other *definitores*. The abbots of La Ferté, Pontigny, Clairvaux, and Morimond nominated together twenty (five each), four of whom, i. e. one of each nomination, were rejected by the abbot general. The legislative assembly, called the General Chapter, met originally annually. They did not settle in any diocese before the bishop had accepted the Charta Charitatis, the fundamental law of the order, which had been given in 1119 by abbot Stephen of Cîteaux. In 1148 the king of Portugal imposed upon his whole kingdom the duties of vassalage towards the abbey of Clairvaux, so that (in 1578) claims were laid by the latter to all Portugal. The decay of the Cistercians began with the rise of the mendicant orders. Their history consists mostly in efforts of popes and some abbots to stay the flood of corruption which early overflowed the whole order. These efforts were usually unsuccessful, but led to the establishment of a number of reformed congregations, which received from the popes the privilege of an independent organization. The most important are those founded in Spain in 1469, in Tuscany in 1497, and that founded by pope Urban VIII in 1680. The present number of abbeyes is very limited. There were in 1848 16 abbeyes, with 499 members, in Austria; 9 in Italy, several of which have since been suppressed by the Sardinian government; 8 in Switzerland, of which one has since been suppressed; 1 in Belgium; and 1 in Poland. Since then they have re-established themselves also in England, at St. Susan's, Lullworth, and Mount St. Bernard, in Leicestershire. Several other monastic organizations owe their origin directly or indirectly to the Cistercians. The Templars received their rule from St. Bernard of Clairvaux. The Spanish knights of Calatrava, Alcantara, and Montesa, and the Portuguese of Avis and Christ, were affiliated to the Cistercians. The Feuillants took their origin in 1574 in the reformed Cistercian abbey of Feuillans, near Toulouse. The austere congregation that sprung from them are the Trappists, founded in 1662. See Fehr, *Geschichte der Mönchsorden*, i, 90 sq.; *A concise History of the Cistercian Order* (London, 1852, sm. 8vo); Maillard, *Dark Ages*, p. 858; Luard, *Annales Monastiques*, vols. i, ii (Lond. 1864, 1865); *Christian Remembrancer*, July, 1867, art. i. See TRAPPISTS.

CISTERCIAN NUNS (*Bernardines*), a religious



Cistercian Monk and Nun.

order founded in 1120 by abbot Stephen of Cîteaux for the convent of Tarb. They followed the rule of Cîteaux under the superintendence of the abbot general of the Cistercians. Later, they were frequently subjected to the jurisdiction of the bishops. Their habit was white, with a black veil, scapular, and girdle. They gradually amassed immense riches, and numbered as many as 6000 convents. In Germany some of the abbesses were raised to the dignity of princesses of the empire, and remained so until 1803. Among all their convents, that of *Port Royal* (q. v.), in France, became the most celebrated. Only a few convents are left, viz. in Switzerland (which has now by far the largest number), in Italy, Bavaria, Saxony, and France. See TRAPPISTS.

Cistern (מֵאֵרָה, בּוֹר, from מֵאֵרָה, to dig or bore, Gesenius, *Theas. Heb.* p. 176; Sept. usually λάκκος; Vulg. *cisterna* or *lacus*; A. V. generally "pool"), a receptacle for water, either conducted from an external spring, or proceeding from rain-fall (Jer. ii, 13; Prov. v, 15; Eccles. xii, 6; Jer. xxxvi, 16; a *pit*, as often rendered; the mod. Arab. *birkeh*). Thus the cistern is essentially distinguished from the living spring מַיִם, *a'yim*; but from the well מְעַרְבֵי, *me'ar'ib*, only in the fact that *beir* is almost always used to denote a place ordinarily containing water rising on the spot, while בּוֹר, *bor*, is often used for a dry pit, or one that may be left dry at pleasure (Stanley, *Palest.* p. 512, 514). See AIN. But the pit into which Joseph was cast by his brethren (Gen. xxxvii, 24) was a *beer* or dry well (Thomson, *Land and Book*, i, 442).

The dryness of the summer months between May and September in Syria, and the scarcity of springs in many parts of the country, make it necessary to collect in reservoirs and cisterns the rain-water, of which an abundance falls in the intermediate period (Shaw, *Travels*, p. 636; Jerome, quoted by Harmer, i, 148; Robinson, ii, 98; Kitto, *Phys. Geogr. of Palest.* p. 802, 808). See WELL. Hence the frequent mention of cisterns in Scripture, and more especially of those which are found in the open country. These were, it seems, the property of those by whom they were formed (Num. xxi, 22). They are usually little more than large pits (see Eccles. i, 8), but sometimes take the character of extensive subterranean vaults, open only by a small mouth, like that of a well. They are filled with rain-water, and (where the climate allows) with snow during winter, and are then closed at the mouth with large flat stones, over which sand is spread in such a way as to prevent their being easily discovered (comp. the "sealed fountain" of Cant. iv, 12). If by any chance the waters which the shepherd has thus treasured up are lost by means of an earthquake or some other casualty, or are stolen, both he and his flocks are exposed to great and imminent danger, as are also travellers who hasten to a cistern and find its waters gone (comp. Judith vii, 21). For this reason a failure of water is used as the image of any great calamity (Isa. xli, 17, 18; xlv, 8). There is usually a large deposit of mud at the bottom of these cisterns, so that he who falls into them, even when they are without water, is liable to perish miserably (Gen. xxxvii, 22 sq.; Jer. xxxviii, 6; Lam. iii, 53; Psa. xl, 2; lxix, 15). In cities the cisterns were works of much labor, for they were either hewn in the rocks or surrounded with subterranean walls, and lined with a fine incrustation. See BETHESDA. The system which in this respect formerly prevailed in Palestine is doubtless the same that exists at present; and indeed there is every probability that most of the cisterns now in use were constructed in very ancient times. Dr. Robinson assures us that "the main dependence of Jerusalem at the present day is on its cisterns; and this has probably always been the case" (*Researches*, i, 480). Both large and small cisterns are frequent throughout the whole of Syria and Pales-

time, and for the construction of them the rocky nature of the ground affords peculiar facilities, either in original excavations or by enlargement of natural cavities. Dr. Robinson remarks that the inhabitants of all the hill country of Judah and Benjamin are in the habit of collecting water during the rainy season in tanks and cisterns, in the cities and fields, and along the high roads, for the sustenance of themselves and their flocks, and for the comfort of the passing traveler. Many of these are obviously antique, and exist along ancient roads now deserted. On the long-forgotten way from Jericho to Bethel "broken cisterns" of high antiquity are found at regular intervals. Jerusalem, described by Strabo as well supplied with water, in a dry neighborhood (xvi, 760), depends mainly for this upon its cisterns, of which almost every private house possesses one or more, excavated in the rock on which the city is built. The following are the dimensions of four belonging to the house in which Dr. R. resided: 1, 15 × 8 × 12 feet deep; 2, 8 × 4 × 15; 3, 10 × 10 × 15; 4, 80 × 80 × 20. The cisterns have usually a round opening at the top, sometimes built up with stone-work above, and furnished with a curb and a wheel for the bucket (Ecol. xii, 6), so that they have externally much the appearance of an ordinary well. The water is conducted into them from the roofs of the houses during the rainy season, and with care remains sweet during the whole summer and autumn. In this manner most of the larger houses and public buildings are supplied (*ib.*). Josephus (*War*, iv, 4, 4) describes the abundant provision for water supply in the towers and fortresses of Jerusalem, a supply which has contributed greatly to its capacity for defence, while the dryness of the neighborhood has in all cases hindered the operations of besiegers. Thus Hezekiah stopped the supply of water outside the city in anticipation of the attack of Sennacherib (2 Chron. xxxii, 3, 4). The progress of Antiochus Sidetes (B.C. 134) was at first retarded by want of water, though this want was afterwards unexpectedly relieved (Joseph. *Ant.* xiii, 8, 2; Clinton, iii, 381). Josephus also imputes to divine interposition the supply of water with which the army of Titus was furnished after suffering from want of it (*War*, v, 9, 4). The Crusaders also, during the siege A.D. 1099, were harassed by extreme want of water, while the besieged were fully supplied (Matth. Paris, *Hist.* p. 46, 49, ed. Wat.). Benjamin of Tudela says very little water is found at Jerusalem, but the inhabitants drink rain-water, which they collect in their houses (Bohn's ed. of *Early Travels*, p. 84). Barclay gives the most complete description of the subterranean reservoirs of Jerusalem, particularly those under the Haram enclosure (*City of the Great King*, p. 226, etc.). See JERUSALEM. The defense of Masada by Joseph, brother of Herod, against Antigonus was enabled to be prolonged owing to an unexpected replenishing of the cisterns by a shower of rain (Josephus, *Ant.* xiv, 15, 2), and in a subsequent passage he describes the cisterns and reservoirs by which that fortress was plentifully supplied with water, as he had previously done in the case of Jerusalem and Macharus (*War*, iv, 4, 4; iv, 6, 2; vii, 8, 8). Burckhardt mentions cisterns belonging to private houses, among other places, at Sermein, near Aleppo (*Syria*, p. 121), El Bara, in the Orontes valley (p. 182), Dhami and Misema in the Lejah (p. 110, 112, 118), Tiberias (p. 881), Kerekain Moab (p. 877), Mount Tabor (p. 384). Of some at Hableh, near Gilgal, the dimensions are given by Robinson (*Later Researches*, p. 187): 1, 7 × 5 × 8 feet deep; 2, nearly the same as 1; 3, 12 × 9 × 8. They have one or two steps to descend into them, as is the case with one near Gaza, now disused, described by Sandys as "a mighty cistern, filled only by the rain-water, and descended into by stairs of stone" (Sandys, p. 160; but see Robinson, ii, 376). Of those at Hableh, some were covered with flat stones, resting on arches, some en-

tirely open, and all evidently ancient (Robinson, new ed. iii, 187). Dr. Olin (*Travels*, ii, 84) describes something of a better sort near Hebron: "Just without the city are some cisterns, which probably belong to a very early age. A large basin, forty-seven paces square, stands outside the gate by which we entered the city. It was nearly full of greenish water, and has been repaired at a period apparently not very remote. It is of very solid workmanship, built of hewn limestone, and may be eighteen or twenty feet deep. The descent is by flights of stairs situated at the four corners, by which the water is brought up in vessels and skins, and poured into troughs for the flocks, or carried away for domestic uses. It was not at this time fit for drinking. Another pool, of smaller dimensions, occupies higher ground on the north side of the city. These reservoirs are filled by the rains, and are unconnected with any perennial fountain." Vitruvius (viii, 7) describes the method in use in his day for constructing water-tanks, but the native rock of Palestine usually superseded the necessity of more art in this work than is sufficient to excavate a basin of the required dimensions. The city of Alexandria is supplied with water contained in arched cisterns supported by pillars, extending under a great part of the old city (Van Egmont, *Travels*, ii, 184). See POOL.

Empty cisterns were sometimes used as prisons and places of confinement. Joseph was cast into a "pit" (בֹּרַי, Gen. xxxvii, 22), and his "dungeon" is called by the same name (xli, 14). Jeremiah was thrown into a miry though empty cistern, whose depth is indicated by the cords used to let him down (Jer. xxxviii, 6). To this prison tradition has assigned a locality near the gate called Herod's gate (Hasselquist, p. 140; Maundrell, Bohn's ed. of *Early Travels*, p. 448). See PRISON. According to Thomson (*Land and Book*, ii, 262-4), dry cisterns are often used in Palestine for granaries, and are very liable to be plundered of their wheat by ants. See GRANARY.

Various allusions by way of figure are made to cisterns in Scripture. The breaking of the wheel at the cistern—the wheel that was used to send down and pull up again the bucket which drew water from the larger cisterns—is used in Eccles. xii, 6, as an image of the breaking up of the animal economy, which perpetually sends, while it is at work, the flow of vital blood from the heart to the extremities. To drink waters out of one's own cistern is a proverbial expression (Prov. v, 15) for confining one's self to the legitimate sources of pleasure which God has associated with our state, as contradistinguished from those which are the property of others. But the merely human and artificial nature of cisterns, which are of man's workmanship, and have no living spring within them, serve as a fit emblem of the insufficiency of creature confidences, and of the folly of preferring these to the infinite and overflowing fulness of God—as in the solemn charge of the prophet, "My people have committed two evils: they have forsaken me, the fountain of living waters, and hewed them out cisterns, broken cisterns that can hold no water" (Jer. ii, 13).—Smith, s. v.; Kitto, s. v.; Fairbairn, s. v. See WATER.

Cistertians. See CISTERCIANS.

Citeaux. See CISTERCIANS.

Cithern (κίθαρα, 1 Macc. iv, 54, i. e. *cithara* or *guitar*), a musical instrument most probably of Greek origin, employed by the Chaldeans at balls and routs, and introduced by the Hebrews into Palestine on their return thither after the Babylonian captivity. The cithern was of the guitar species, and was known at a later period as the *cithern*, under which name it is mentioned by the old dramatists as having constituted part of the furniture of a barber's shop. Of the same species is the *Cithar* or *Zither* of Southern Germany, the Tyrol, and Switzerland.

With respect to the shape of the cithern or cithara mentioned in the Apocrypha, the opinion of the learned is divided: according to some, it resembled in form the Greek delta, Δ; others represent it as a half-moon; and others, again, like the modern guitar. In many Eastern countries it is still in use with strings, varying in number from three to twenty-four. Under the name of *Koothir*, travellers describe it as a wooden plate or dish, with a hole beneath, and a piece of skin stretched above like a drum. Two sticks, joined after the manner of a fan, pass through the skin at the end, and where the two sticks stand apart, they are connected by a transversal piece of wood. From the upper end of this wooden triangle to the point below are fastened five chords, which, at a little distance above their junction, pass over a bridge, like the strings of a violin. The chords are made to vibrate by means of a leather thong fastened to one of the

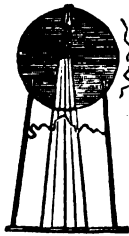

Modern Oriental Cithara.

lateral sticks of the triangle (see Mendelssohn's edition of the *Psalms*, 2d Pref.).

The cithara, if it be not the same with, resembles very closely the instruments mentioned in the book of Psalms, under the denominations of קֶבֶב, קֶבֶב, respectively rendered in the A. V. "harp," "psaltery," "organ." In Chaldee, *cithara* is transferred as קֶרֶיִם, the *Keri* for קֶרֶיִם (Dan. iii, 5), in the A. V. rendered "harp," and the same Engl. word is employed instead of *cithern* (1 Macc. iv, 54) in Robert Barker's edition of the *English Bible* (London, 1615). Gesenius (*Theb. Heb.* p. 215) considers cithara as the same with harp; but Luther translates *κithάρα* by *mit Pfeifen*, "with pipes."—Smith, s. v. See HARP.

Cities. See CITY.

Cit'im (Κιτιμοί v. r. Κιτιμοί, Vulg. *Cetei*, A. V. "Citims"), a nation whose king Perseus is mentioned (1 Macc. viii, 5) as having been defeated by the Romans; evidently the *CHITTIM* (q. v.), or Macedonians.

Citizenship, the rights and privileges of a native or adopted citizen (πολιτης, 2 Macc. iv, 50; v, 6; ix, 16, 19; Luke xv, 15; xix, 14; Acts xxi, 89), in distinction from a foreigner. The following account is in part taken from Kitto and Smith, s. v. See ALIEN.

I. *Hebrew*.—Under the Mosaic constitution, which was framed on a basis of religious rather than of political privileges and distinctions, the idea of the commonwealth (πολιτεια, Eph. ii, 12) was merged in that of the congregation, to which every Hebrew, and even strangers under certain restrictions, were admitted. See CONGREGATION. Strict isolation did by no means, as some suppose, form the leading principle in the system of theocracy as laid down by Moses, since even non-Israelites, under various names [see STRANGER], not only were allowed to reside in Palestine, but had the fullest protection of the law equally with the native Israelites (Exod. xii, 19; Lev. xxiv, 22; Num. xv, 15; xxxv, 15; Deut. i, 16; xxiv, 17: the law of usury, Deut. xxiii, 20, made, however, an exception), and were, besides, recommended in general terms by Moses to humanity and charity (Exod. xxii, 21; xxiii, 9; Lev. xix, 83, 84; Deut. x, 18; comp. Jer. vii, 6; Mal. iii, 5; see Josephus, *Apion*, ii, 28), as well as to a participation in certain prerogatives granted to the poor of the land, such as a share in the tithes and feast-offering, and the harvest in the jubilee-year (Deut. xiv, 29; xvi, 10, 14; xxvi, 11; Lev. xxv, 6). In return, it was required on the part of non-Israelites not to commit acts by which the religious feelings of the people might be hurt (Exod. xx, 10; Lev. xvii, 10; xviii, 26; xx, 2; xxiv, 16; Deut. v, 14). The eating of an animal which had died a natural death, Deut. xiv, 21, seems to have been the sole exception). The advantage the Jew had over the Gentile was thus

strictly spiritual, in his being a citizen, a member of the theocracy (הַקְהָל יְהוָה, *community of Jehovah*, Num. xvi, 8; Deut. xxiii, 2), on whom positive laws were enjoined. But even to this spiritual privilege Gentiles were admitted under certain restrictions (Deut. xxiii, 1-9); thus we find among the Israelites, Doeg, an Edomite (1 Sam. xxi, 8), as also Uriah, a Hittite (a Canaanite). The only nations that were altogether excluded from the citizenship of the theocracy by especial command of the Lord were the Ammonites and Moabites, from a feeling of vengeance against them; and in the same situation were all castrated persons and bastards, from a feeling of disgrace and shame (Deut. xxiii, 1-6). In the time of Solomon no less than 153,600 strangers were resident in Palestine (2 Chron. ii, 17). See GENTILE.

II. *Roman*.—The right of citizenship (πολιτεια, "freedom," Acts xxii, 28, i. e. to be considered as equal to natives of the city of Rome, *ius civitatis, civitas*) was granted in the times of the emperors to whole provinces and cities (Dio Cass. xli, 25; Suet. *Aug.* 47), as also to single individuals (Tacit. *Annal.* i, 58; Sueton. *Nero*, 12; Dio Cass. xliii, 89; Appian, *Civ.* iii, 26), for some service rendered to the state (Cic. *Phil.* 22) or the imperial family (Sueton. *Aug.* 47), sometimes through mere favor (Tacit. *Hist.* iii, 41), or even for a certain sum of money (Acts xxii, 28; Dio Cass. xli, 24; see Heinecc. *Antiq. jur. Rom.* i, 1, 11 sq.). The apostle Paul was a Roman citizen (*civis satus*, Sueton. *Calig.* 38; see Amtenz, *De civitate Rom. apost. Pauli*, Utr. 1725) by family (Acts, l. c.) [see TARSUS], and hence his protesting against corporal or capital punishment (Acts xvi, 87; comp. Cic. *Verr.* v, 57, 65; Raseb. *Hist. Eccles.* v, 1, etc.). It appears from a variety of passages in the classic writers that a Roman citizen could not legally be scourged (*virgis* or *flagellis caedi*); this punishment being deemed to the last degree dishonorable, and the most daring indignity and insult upon the Roman name. Such was the famous "*Pericia Lex*." "A Roman citizen, judges," exclaims Cicero, in his oration against Verres, "was publicly beaten with rods in the forum of Messina; during this public dishonor, no groan, no other expression of the unhappy wretch was heard amid the cruelties he suffered, and the sound of the strokes that were inflicted, but this: 'I am a Roman citizen!'" Neither was it lawful for a Roman citizen to be bound, or to be examined by the question, or torture, to extort a confession from him. These punishments were deemed servile: torture was only inflicted upon slaves; freemen were exempted from this inhumanity and ignominy. The right once obtained descended to a man's children (Acts xxii, 28; see Zimmern, *Gesch. des röm. Privatrechts*, I, ii, 441). The Jews had rendered signal services to Julius Cæsar in the Egyptian war (Josephus, *Ant.* xiv, 8, 1 and 2), and it is not improbable that many obtained the freedom of the city on that ground; certain it is that great numbers of Jews who were Roman citizens were scattered over Greece and Asia Minor (*Ant.* xiv, 10, 18 and 14). Among the privileges attached to citizenship, the most noteworthy was the above, that a man could not be bound or imprisoned without a formal trial (Acts xx, 29), still less be scourged (Acts xvi, 87; Cic. *Verr.* v, 63, 66); the simple assertion of citizenship was sufficient to deter a magistrate from such a step (Acts xxii, 25; Cic. *Verr.* v, 62), as any infringement of the privilege was visited with severe punishment. A Jew could only plead exemption from such treatment before a Roman magistrate; he was still liable to it from Jewish authorities (2 Cor. xi, 24; Selden, *Syn.* ii, 15, § 11). Another privilege attaching to citizenship was the appeal from a provincial tribunal to the emperor at Rome (Acts xxv, 11). See APPEAL. The rights of the Roman citizen included several other important privileges: he had a full right over his property, his children, and

his dependents; he had a voice in the assemblies of the people, and in the election of magistrates; and his testament had full authority after his death. See Smith's *Dict. of Class. Antiq.* s. v. Civitas; Sigon. *De antiquo jure civ. Roman.* (Par. 1572; Hal. 1715; also in Grævii *Theaur.* i); Spanheim, *Orbis Rom.* (London, 1703; Hal. 1728); Cellarii *Dissertatt.* p. 715 sq.; also Büttner, *De civ. Rom. virgideinis exempt.* (Jen. 1672); Lange, *De immunitate civ. Roman.* (Hafn. 1710). See FREEMAN.

Citron (*κίτριον*, the tree is *κίτριά* or *κίτρία*, but was long without a special name among the Greeks, although they were well acquainted with it; see Smith, *Dict. of Class. Antiq.* s. v. Citrus). In his account of Alexander Jannæus, Josephus tells us, "His own people were seditious against him; for at a festival which was then celebrated, when he stood upon the altar and was going to sacrifice, the nation rose upon him, and pelted him with citrons, for the law of the Jews required that at the festival of tabernacles every one should have branches of the palm-tree and citron-tree"



Citron Flower and Fruit.

(*Ant.* xiii, 13, 5). The late Lady Callcott, in her *Scripture Herbal*, mentions that, as the modern Jews still use citrons at the feast of tabernacles, "in London considerable sums of money are expended in importing them of the best kind for the purpose. They must be without blemish, and the stalk must still adhere to them. After the feast is over, the citrons are openly sold, and the money produced by the sale is placed in the common treasury, as part of the provision for the poor of the congregation." Their anxiety to obtain them with the stalk still adhering is no doubt a faint effort to secure the "thick" branches and "boughs of goodly trees" required for that festival (*Lev.* xxxiii, 40). But the chief importance of this fruit is its supposed identity with the תַּפְּוֹס, *tappu'-ach*, or "apple" of the Bible, a conclusion, however, which has been ably disputed. See APPLE. The citron, or *Citrus medica*—so called because it was from Media that the Romans first received it—belongs to the natural order of Aurantiacæ, a delightful group, including the orange, the lime, the lemon, and the shaddock (see the *Penny Cyclopædia*, s. v. Citrus). With its dark, glossy, laurel-looking leaves, its evergreen branches, often bearing simultaneously ripe fruits and newly-opened flowers, and thus vouchsafing to the pilgrim who rests in its deep shadow the twofold refreshment of a delicious banquet and a fragrant breeze, the citron may well claim pre-eminence "among the trees of the wood" (*Can.* ii, 8). Abounding

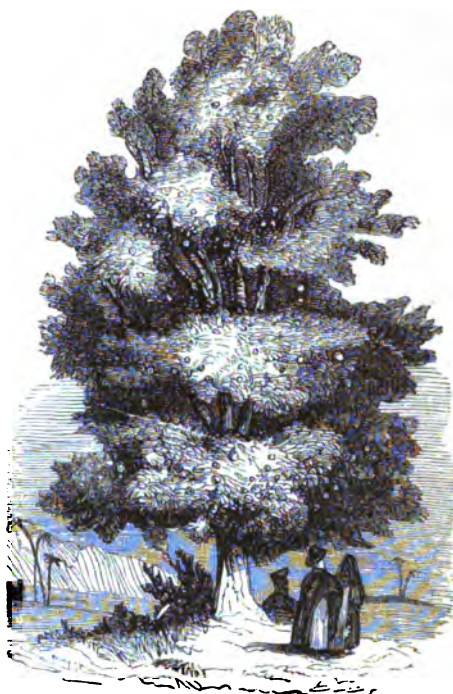

Citron-Tree.

in malic and citric acid, the juice of the orange and its congeners is one of the most agreeable antidotes which the Creator's bounty has provided against the exhausting thirst and incipient fever of sultry climes. A settler in the torrid swamps of the Amazon will devour a dozen oranges before his morning meal (*Voyage up the Amazon*, in the "Home and Colonial Library"), and in tropical regions such acidulous fruits are invaluable on account of their anti-febrile virtues. These were doubtless well known to the Hebrews, and, in common with all antiquity, they greatly prized the pleasant pungent odor emitted by the rind. Macrobius speaks of "citrosa vestis," showing that it was usual to keep citrons in wardrobes for the sake of their perfume; and, like the modern Oriental ladies, whose favorite vinaigrette is a citron, in England two or three centuries ago an orange was so commonly used as a scent-bottle that it may often be seen in old pictures of their queens and peeresses. It was also believed to have a disinfecting potency; and during the plague of London, people walked the streets smelling at oranges. Understood as belonging to this beautiful family, there is a peculiar felicity in the comparison, "A word fitly spoken is like citrons of gold in salvers (or baskets) of silver" (*Prov.* xxv, 11). The famous golden apples which grew in the gardens of the Hesperides were unquestionably either citrons or oranges.—Fairbairn, s. v. Apple. See BOTANY.

City. The Heb. term most frequently thus rendered is עִיר (*ir*, literally something raised up, i. e. having walls reared; or from שָׂרַף, to keep guard [Gesenius, *Thes. Heb.* p. 1004]; Sept. and N. T. πόλις), a word of very extensive signification, embracing not only the idea of an encampment, as a nomade hamlet (*Gen.* iv, 17), but also that of small fortifications, as watch-posts or watch-towers (*comp.* *Numb.* xiii, 19; 2 Kings xvii, 9; *Isa.* i, 8), and thence extended to regular towns. Nearly equivalent to this is הִירָאֵה (*hiryah'*), which, with a few exceptions (*Deut.* ii, 26; 1 Kings i, 41, 45), is found only in the poetic style; and analogous (in sense, as probably also in derivation) to this

last is *קָרַת* (*ke'reth*), found only in Job xxix, 7; Prov. viii, 8; ix, 8, 14; xi, 11. The word rendered "city" in Ruth iii, 11, is *שַׁעַר* (*sha'ar*), properly gate (as it is elsewhere rendered), and there means those assembled in the forum or place of public business at the town gates. The second of these terms (perhaps from *קָרַת*, to approach as an enemy, or rather [Genenius, *Thes. Heb.* p. 1286] to fortify), is often "prefixed to the names of towns on both sides of the Jordan existing before the conquest, as Kirjath-Arba, probably the most ancient name for city, but seldom used in prose as a general name for town (Stanley, *Palest. App.* § 80). The classification of the human race into dwellers in towns and nomade wanderers (Gen. iv, 20, 22) seems to be intimated by the etymological sense of both words, *Ar*, or *Ir*, and *Kirjath*, as places of security against an enemy, distinguished from the un-walled village or hamlet, whose resistance is more easily overcome by the marauding tribes of the desert. See *IR*—; *KIRJATH*. This distinction is found actually existing in countries, as Persia and Arabia, in which the tent-dwellers are found, like the Rechabites, almost side by side with the dwellers in cities, sometimes even sojourning within them, but not amalgamated with the inhabitants, and in general making the desert their home, and, unlike the Rechabites, robbery their undissembled occupation (Judg. v, 7; Jer. xxxv, 9, 11; see Fraser, *Persia*, p. 866, 880; Malcolm, *Sketches of Persia*, p. 147-156; Burckhardt, *Notes on Bedouins*, i, 157; Wellsted, *Travels in Arabia*, i, 886; Porter, *Damascus*, ii, 96, 181, 188; Vaux, *Nineveh and Persepolis*, c. ii, note A; Layard, *Nineveh*, ii, 272; *Nin. and Bab.* p. 141).—Smith, s. v. See *VILLAGE*.

1. Towns are a natural result of the aggregative principle in human nature. Necessity led the early races of men to build their towns on lofty spots, where, with the aid of the natural advantages of the ground, they could easily protect themselves against beasts of prey and human foes. A town, and a stronghold or fort, would thus be originally identical. As population increased and agriculture spread, so some degree of security came, which permitted the inhabitants of the castle to diffuse themselves over the hill-side, and take up their abode in the valley, and by the side of the stream that lay nearest their acropolis; still the inhabitants kept at no great distance from the centre of strength, in order not to be deprived of its protection. The town, however, would thus be enlarged, and as the necessity for self-defence still existed, so would the place soon be surrounded with walls. Thus there would be outer and inner bulwarks, and in some sort two species of community—the townspeople, who filled the ground and carried on trade, and the soldiers, whose business it was to afford protection: these two, however, in the earliest stages of civilization, were one, the peasant and tradesman taking arms when the town was put in danger. How early towns were formed cannot be determined by any general principle: they were obviously a work of time. The primary tendency in population was to diffuse itself. Aggregation on particular spots would take place at a later period. When, then, Cain is said to have built a city (Gen. iv, 17), we have evidence which concurs with other intimations to show that it is only a partial history of the first ages that we possess in the records of the book of Genesis. In the time of the Patriarchs we find towns existing in Palestine which were originally surrounded with fortifications, so as to make them "fenced cities." (See below.) In these dwelt the agricultural population, who, by means of these places of strength, defended themselves and their property from the nomad tribes of the neighboring desert, who then, as they do now, lived by plunder. Nor were works of any great strength necessary. In Palestine at the present day, while walls are in most parts an indispensable protection, and agriculture can be advantageously prosecuted

only so far as sheltered by a fortified town, erections of a very slight nature are found sufficient for the purpose, the rather because the most favorable localities offer themselves on all sides, owing to the natural inequality of the ground. Hence we find that hills or eminences were almost invariably chosen as sites for this purpose, a fact which even grew into a proverb—"a city upon a hill." (See Hackett's *Illustra. of Script.* p. 70.)

Of the ancient method of building in towns and cities we have no accurate knowledge, any farther than we may gather information from the ruins which still lie on the soil of Palestine. But these ruins can afford only general notions, as, though they are numerous, and show that the Land of Promise was thickly peopled and highly flourishing in its better days, the actual remains of ancient towns are to be ascribed to different and very distant periods of history. The Crusades left many strongholds which are now in a state of dilapidation; but the Crusades are of modern days compared with the time of the Saviour, which itself is remote from the proper antiquity of the nation. In the law of sameness, however, which prevails so rigidly in Eastern countries, gives us an assurance that a modern town in Palestine may be roughly taken as a type of its ancient predecessors. (See Olin's *Travels*, ii, 423.) To distinguish cities that bore the same name, the name of the tribe was added. In "the latter days," especially under the Herods, it was the fashion to give to ancient towns new Greek names, as Diospolis, Neapolis, Sebaste, Cæsarea, Tiberias. Jerusalem, at a later period, was denominated *Elia Capitolina*. These innovations indicated the slavish disposition of the age, and were tokens of the bondage in which the nation was held.

Palestine underwent constant changes in regard to its towns from the earliest ages; one consequence of which is, that there are names of towns that belong exclusively to certain eras. The period of the Roman domination gave existence, as to structures of great splendor, so to many towns and fortified places. Galilee was especially rich in towns and villages, which, according to Josephus (*Life*, 45), amounted in all to the number of 204. The names of the Palestinian cities, for the most part, have meaning, reference being made to the nature of the locality or the character of the inhabitants. The population of towns cannot now be ascertained with any degree of accuracy, for the materials are not only scanty and disconnected, but in a measure uncertain.—Kitto, s. v. See *CENSUS*.

2. The earliest notice in Scripture of city-building is of that of the city called Enoch (q. v.) by Cain, in the land of his "exile" (*Nod*, Gen. iv, 17). After the confusion of tongues, the descendants of Nimrod founded Babel, Erech, Accad, and Calneh, in the land of Shinar; and Asshur, a branch from the same stock, built Nineveh, Rehoboth-by-the-river, Calah, and Resen, the last being "a great city." A subsequent passage mentions Sidon, Gaza, Sodom, Gomorrah, Admah, Zeboim, and Lasha, as cities of the Chanaanites, but without implying for them antiquity equal to that of Nineveh and the rest (Gen. x, 10-12, 19; xi, 3, 9; xxxvi, 87). Sir H. Rawlinson supposes, (1.) that the expedition of Chedorlaomer (Gen. xiv) was prior to the building of Babylon or Nineveh, indicating a migration or conquest from Persia or Assyria; (2.) that by Nimrod is to be understood, not an individual, but a name denoting the "settlers" in the Assyrian plain; and (3.) that the names Rehoboth, Calah, etc., when first mentioned, only denoted sites of buildings afterwards erected. He supposes that Nineveh was built about B.C. 1250, and Calah about a century later, while Babylon appears to have existed in the 15th century B.C. If this be correct, we must infer that the places then attacked, Sodom, Gomorrah, etc., were cities of higher antiquity than Nineveh or Babylon, inasmuch as when they were destroyed a few years later

they were cities in every sense of the term. The name Kirjathaim, "double city" (Gesenius, *Theaur. Heb.* p. 1236), indicates an existing city, and not a site only. It may be added that the remains of civic buildings existing in Moab are evidently very ancient, if not, in some cases, the same as those erected by the aboriginal Emim and Rephaim. (Compare also the name Avith, "ruins," Gesenius, *ib.* p. 1000; Gen. xix, 1, 29; xxxv, 85; Isa. xxiii, 13; see Wilkinson, *Anc. Egypt.* i, 308; Layard, *Nin. and Bab.* p. 532; Porter, *Damascus*, i, 309; ii, 196; Rawlinson, *Outlines of Assy. Hist.* p. 4, 5.) But though it appears probable that, whatever dates may be assigned to the building of Babylon or Nineveh in their later condition, they were in fact rebuilt at those epochs, and not founded for the first time, and that towns in some form or other may have occupied the sites of the later Nineveh or Calah; it is quite clear that cities existed in Syria prior to the time of Abraham, who himself came from "Ur," the "city" of the Chaldeans (Gesenius, *ib.* p. 55; Rawlinson, p. 4).

The earliest description of a city, properly so called, is that of Sodom (Gen. xix, 1-22); but it is certain that from very early times cities existed on the sites of Jerusalem, Hebron, and Damascus. The last, said to be the oldest city in the world, must, from its unrivalled situation, have always commanded a congregated population; Hebron is said to have been built seven years before Zoan (Tanis) in Egypt, and is thus the only Syrian town which presents the elements of a date for its foundation (Num. xiii, 22; see Stanley, *Palest.* p. 409; Josephus, *Ant.* i, 6, 4; Conybeare and Howson, *St. Paul*, i, 94, 96). But there can be no doubt that, whatever date may be given to Egyptian civilization, there were inhabited cities in Egypt long before this (Gen. xii, 14, 15; see Martineau, *Eastern Life*, i, 161; Wilkinson, i, 807; Smith, *Dict. of Class. Geog.* s. v. Tanis). The name, however, of Hebron, Kirjath-Arba, indicates its existence at least as early as the time of Abraham, as the city, or fortified place of Arba, an aboriginal province of Southern Palestine (Gen. xxiii, 2; Josh. xiv, 15). The "tower of Edar," near Bethlehem, or "of flocks," indicates a position fortified against marauders (Gen. xxxv, 21). Whether "the city of Shalem" be a site or an existing town cannot be determined; but there can be no doubt that the situation of Shechem is as well identified in the present day, as its importance as a fortified place is plain from the Scripture narrative (Gen. xxxiii, 18; xxiv, 20, 26; see Robinson, iii, 114). On the whole, it seems plain that the Canaanite, who was "in the land" before the coming of Abraham, had already built cities of more or less importance, which had been largely increased by the time of the return from Egypt. Even before the time of Abraham there were cities in Egypt (Gen. xii, 14, 15; Num. xiii, 22; see Wilkinson, i, 4, 5). The Israelites, during their sojourn there, were employed in building or fortifying the "treasure cities" of Pithom (Abbasieh) and Raamses (Exod. i, 11; Herod. ii, 158; see Robinson, i, 79); but their pastoral habits make it unlikely that they should build, still less fortify, cities of their own in Goshen (Gen. xlvi, 84; xlvii, 1-11). Meanwhile the settled inhabitants of Syria on both sides of the Jordan had grown in power, and in number of "fenced cities." In the kingdom of Sihon are many names of cities preserved to the present day; and in the kingdom of Og, in Bashan, were sixty "great cities with walls and brazen bars," besides unwallled villages; and also twenty-three cities in Gilead, which were occupied, and perhaps partly rebuilt or fortified, by the tribes on the east of Jordan (Num. xxi, 21, 32, 33, 35; xxxii, 1-8, 34, 42; Deut. iii, 4, 5, 14; Josh. xi, xiii; 1 Kings iv, 18; 1 Chron. ii, 22; see Burckhardt, *Syria*, p. 311, 457; Porter, *Damascus*, ii, 196, 206, 259, 276). On the west of Jordan, whilst 81 "royal" cities are enumerated (Josh. xii), in the district assigned to Judah 125

"cities" with villages are reckoned (Josh. xv) in Benjamin, 26; to Simeon, 17; Zebulun, 12; Issachar, 16; Asher, 22; Naphtali, 19; Dan, 17 (Josh. xviii, xix). But from some of these the possessors were not expelled till a late period, and Jerusalem itself was not captured till the time of David (2 Sam. v, 6-9). From this time the Hebrews became a city-dwelling and agricultural rather than a pastoral people. David enlarged Jerusalem; and Solomon, besides embellishing his capital, also built or rebuilt Tadmor, Palmryra, Gezer, Beth-horon, Hazor, and Megiddo, besides store-cities (2 Sam. v, 7, 9, 10; 1 Kings ix, 15-18; 2 Chron. viii, 6). To Solomon also is ascribed by Eastern tradition the building of Persepolis (Chardin, *Voyage*, viii, 390; Mandelato, i, 4; Kurân, c. xxxviii). The works of Jeroboam at Shechem (1 Kings xii, 25; Judg. ix, 45), of Rehoboam (2 Chron. xi, 5-10), of Baasha at Rama, interrupted by Asa (1 Kings xv, 17, 22), of Omri at Samaria (xvi, 24), the rebuilding of Jericho in the time of Ahab (xvi, 84), the works of Jehoshaphat (2 Chron. xvii, 12), of Jotham (2 Chron. xxvii, 4), the rebuilding of Jerusalem, and, later still, the works of Herod and his family, belong to their respective articles.

8. Collections of houses in Syria for social habitation may be classed under three heads: (1.) cities; (2.) towns, with citadels or towers for resort and defence; (3.) unwallled villages. The cities may be assumed to have been in almost all cases "fenced cities," i. e. possessing a wall with towers and gates (Lev. xxv, 29; Deut. ix, 1; Josh. ii, 15; vi, 20; 1 Sam. xxiii, 7; 1 Kings iv, 18; 2 Kings vi, 26; vii, 8; xviii, 8, 18; Acts ix, 25); and that, as a mark of conquest was to break down a portion at least of the city wall of the captured place, so the first care of the defenders, as of the Jews after their return from captivity, was to rebuild the fortifications (2 Kings xiv, 13, 22; 2 Chron. xxvi, 2, 6; xxxiii, 14; Neh. iii, iv, vi, vii; 1 Macc. iv, 60, 61; x, 45; Xen. *Hell.* ii, 2, 15). But around the city, especially in peaceable times, lay un-defended suburbs (1 Chron. vi, 57 sq.; Num. xxxv, 1-5; Josh. xxi), to which the privileges of the city extended. (See below.) The city thus became the citadel, while the population overflowed into the suburbs (1 Macc. xi, 61). The absence of walls as indicating security in peaceable times, combined with populousness, as was the case in the flourishing period of Egypt, is illustrated by the prophet Zechariah (ii, 4; 1 Kings iv, 25; see Martineau, *East. Life*, i, 806).

According to Eastern custom, special cities were appointed to furnish special supplies for the service of the state: cities of store, for chariots, for horsemen, for building purposes, for provision for the royal table. Special governors for these and their surrounding districts were appointed by David and Solomon (1 Kings iv, 7; ix, 19; 1 Chron. xxvii, 25; 2 Chron. xvii, 12; xxi, 3; 1 Macc. x, 89; Xen. *Anab.* i, 4, 10). To this practice our Lord alludes in his parable of the pounds, and it agrees with the theory of Hindoo government, which was to be conducted by lords of single townships, of 10, 100, or 1000 towns (Luke xix, 17, 19; see Elphinstone, *India*, ch. ii, 1, 89, and *App.* v, p. 485). To the Levites 48 cities were assigned, distributed throughout the country, together with a certain amount of suburban ground, and out of these 48, 13 were specially reserved for the family of Aaron, 9 in Judah and 4 in Benjamin, and 6 as refuge cities (Josh. xxi, 13, 42), but after the division of the kingdoms the Levites in Israel left their cities and resorted to Judah and Jerusalem (2 Chron. xi, 13, 14). (See below.)

4. The internal government of Jewish cities was vested before the Captivity in a council of elders, with judges, who were required to be priests: Josephus says seven judges, with two Levites as officers, *ἑπτά-ῥα* (Deut. xxi, 5, 19; xvi, 18; xix, 17; Ruth iv, 2; Josephus, *Ant.* iv, 8, 14). Under the kings a president or governor appears to have been appointed (1 Kings

xxii, 26; 2 Chron. xviii, 25); and judges were sent out on circuit, who referred matters of doubt to a council composed of priests, Levites, and elders at Jerusalem (1 Chron. xxiii, 4; xxvi, 29; 2 Chron. xix, 5, 8, 10, 11). After the Captivity, Ezra made similar arrangements for the appointment of judges (Ezra vii, 25). In the time of Josephus there appear to have been councils in the provincial towns, with presidents in each, under the directions of the great council at Jerusalem (Josephus, *Ant.* xiv, 9, 4; *War.* ii, 21, 8; *Life.* 12, 13, 27, 34, 57, 61, 68, 74). See **SANHEDRIM**.

In many Eastern cities much space is occupied by gardens, and thus the size of the cities is much increased (Niebuhr, *Voyage*, ii, 172, 239; Conybeare and Howson, i, 96; *Edthen*, p. 240). The vast extent of Nineveh and of Babylon may thus be in part accounted for (Diod. ii, 70; Quint. Curt. v, i, 26; Jonah iv, 11; see Chardin, *Voy. vii*, 278, 284; Porter, *Damascus*, i, 153; P. della Valle, ii, 83). In most Oriental cities the streets are extremely narrow, seldom allowing more than two loaded camels, or one camel and two foot passengers to pass each other, though it is clear that some of the streets of Nineveh must have been wide enough for chariots to pass each other (Nah. ii, 4; see Olearius, *Trav.* p. 294, 309; Burckhardt, *Trav. in Arabia*, i, 188; Buckingham, *Arab Tribes*, p. 380; Mrs. Poole, *Englishwoman in Egypt*, i, 141). The word for "streets" used by Nahum—*רְחֹבוֹתַי*, from *רָחַב*, *broad*, *πλαταίαι*)—is used also of streets or broad places in Jerusalem (Prov. i, 20; Jer. v, 1; xxii, 4; Cant. iii, 2); and it may be remarked that the thoroughfares (*πλαταίαι*) into which the sick were brought to receive the shadow of Peter (Acts v, 15) were more likely to be the ordinary streets than the special *plazze* of the city. It seems likely that the immense concourse which resorted to Jerusalem at the feasts would induce wider streets than in other cities (see 1 Kings xx, 34). Herod built in Antioch a wide street paved with stone, and having covered ways on each side. Agrippa II paved Jerusalem with white stone (Josephus, *Ant.* xvi, 5, 2 and 8; xx, 9, 7). The streets of most cities of Palestine would not need paving, in consequence of the rocky nature of the foundations on which they lay. The Straight Street of Damascus is still clearly defined and recognisable (Irby and Mangles, v, 86; Robinson, new ed. of *Res.* iii, 454, 455). In building Cæsarea, Josephus says that Herod was careful to carry out the drainage effectually (Josephus, *Ant.* xv, 19, 6). The internal commerce of Jewish cities was probably carried on as now by means of bazaars (q. v.); for we read of the bakers' street (Jer. xxxvii, 21), and Josephus speaks of the wool market, the hardware market, a place of blacksmiths' shops, and the clothes market, at Jerusalem (*War.* v, 8, 1). See **STREET**.

The open spaces (*πλαταίαι*) near the gates of towns were in ancient times, as they are still, used as places of assembly by the elders, of holding courts by kings and judges, and of general resort by citizens (Gen. xxiii, 10; Ruth i, v, 1; 2 Sam. xv, 2; xviii, 24; xxi, 12; 2 Kings vii, 1, 3, 20; 2 Chron. xviii, 9; xxxii, 6; Neh. viii, 1, 13, 16; Job xxix, 7; Jer. xvii, 19; Matt. vi, 5; Luke xiii, 26). They were also used as places of public exposure by way of punishment (Jer. xx, 2; Amos v, 10). See **GATE**. Prisons were, under the kingly government, within the royal precinct (Gen. xxxix, 20; 1 Kings xxii, 27; Jer. xxxii, 2; Neh. iii, 25; Acts xxi, 34; xxiii, 85).

Great pains were taken to supply Jerusalem with water, both by tanks and cisterns for rain-water, and by reservoirs supplied by aqueducts from distant springs. Such was the fountain of Gihon, the aqueduct of Hezekiah (2 Kings xx, 20; 2 Chron. xxxii, 80; Isa. xxii, 9), and of Solomon (Eccl. ii, 6), of which last water is still conveyed from near Bethlehem to Jerusalem (Maundrell, in Bohn's ed. of *Early Trav.* p. 457; Robinson, i, 514 sq.; Olin, ii, 109 sq.). Josephus

also mentions an attempt made by Pilate to bring water to Jerusalem (*Ant.* xviii, 3, 2). See **CONDUIT**. Other cities appear to have been mostly contented with the fountains whose existence had probably led to their formation at the first. See **WATER**.

Burial-places, except in special cases, were outside the city (Num. xix, 11, 16; Matt. viii, 28; Luke vii, 12; John xix, 41; Heb. xiii, 12).—Smith, s. v. See **GRAVE**.

5. A city and its inhabitants are frequently described in the sacred writings under the similitude of a mother and her children; hence the phrase "Children of Zion" (Joel ii, 23). Cities are also characterized as virgins, wives, widows, and harlots, according to their different conditions. Thus Jerusalem is called a virgin (Isa. xxxvii, 22); and the term harlot is used of Jerusalem (Isa. i, 21), also of Tyre (Isa. xxiii, 16), of Nineveh (Nah. iii, 4), and of Samaria (Ezek. xxiii, 5).

FENCED CITY (seldom simply *מְצוּרָה*, *metzura'*, a mound or intrenchment of besiegers; "mount," Isa. xxix, 3; "munition," Nah. ii, 1), a town with walls of fortification (2 Chron. xi, 11; oftener with *מְצוּרָה*, *cities of*, 2 Chron. xiv, 5; or both words in the plur., xi, 10, 11, 28; xii, 4; xxi, 3). From the foregoing remarks, it will be understood how the phrases to *build* a city, and to *fortify* or *fence* it, in the Oriental idiom, mean generally the same thing. See **FORTRESS**. The fencing or fortification was usually with high walls, and watch-towers upon them (Deut. iii, 5). See **FORTIFICATION**. The walls of fortified cities were formed, in part at least, of combustible materials (Amos i, 7, 10, 14), the gates being covered with thick plates of iron or brass (Psa. cvii, 16; Isa. xlv, 2; Acts xii, 10). There was also within the city a citadel or tower, to which the inhabitants fled when the city itself could not be defended (Judg. ix, 46–52). They were often upon elevated ground, and were entered by a flight of steps (2 Kings x, 2; Isa. xxxvi, 1). See **WALL**.

CITY WITH SUBURBS (in the plur. *עָרֵי מְצוּרָה*, *arey' migrahim'*, cities of pastures, 1 Chron. xlii, 2), i. e. a town surrounded by open pasture-grounds or commons. The forty-eight cities which were given to the Levites were thus denominated; the extent of the suburbs appertaining to each city is accurately defined in Num. xxxv, 1–8; Josh. xxi, 41, 42. They were evidently the surrounding districts to which the city gave the means of protection and safety. See **SUBURB**.

CITY OF REFUGE (usually in the plur. *עָרֵי מְצוּרָה*, *arey' ham-miklat'*, from *מִלַּת* contracted, Gesenius, *Theo. Heb.* p. 1216; Sept. πόλις τῶν φυγαδευομένων, *φυγαδευήρια, φυγαδία*; Vulg. *oppida in fugitivorum auxilia, præsidia, separata, or urbes fugitivorum*).

1. Among the Hebrews, six Levitical cities specially chosen for refuge to the involuntary homicide until released from banishment by the death of the high-priest (Num. xxxv, 6, 13, 15; Josh. xx, 2, 7, 9). See **BLOOD-REVENGE**. There were three on each side of Jordan. 1. **KEDESH**, in Naphtali, now *Kedes*, about twenty miles E.S.E. from Tyre, twelve S.S.W. from Banias (1 Chron. vi, 76; see Robinson, iii, 355; Benj. of Tudela, in the *Early Trav.* p. 89). 2. **SHESHKEM**, in Mount Ephraim, *Nabulus* (Josh. xxi, 21; 1 Chron. vi, 67; 2 Chron. x, 1; see Robinson, iii, 113). 3. **HEBROTH**, in Judah, *el-Khûlûl*. The last two were royal cities, and the latter sacerdotal also, inhabited by David, and fortified by Rehoboam (Josh. xxi, 13; 2 Sam. v, 5; 1 Chron. vi, 55; xxix, 27; 2 Chron. xi, 10; see Robinson, i, 814; ii, 454). 4. On the E. side of Jordan—**BEZER**, in the tribe of Reuben, in the plains of Moab, said in the Gemara to be opposite to Hebron, perhaps the later *Bosor*, and the present *Buzais* (Deut. iv, 43; Josh. xii, 8; xxi, 36; 1 Macc. v, 26; Josephus, *Ant.* iv, 7, 4; see Reland, p. 662). 5. **RAMOTH-GILEAD**, in the tribe of Gad, supposed to be on

or near the site of *es-Stalt* (Deut. iv, 48; Josh. xxi, 88; 1 Kings xxii, 8; see Reland, p. 966). 6. GOLAN, in Bashan, in the half-tribe of Manasseh, a town whose site has not been ascertained, but which doubtless gave its name to the district of Gaulonitis, *Jaulan* (Deut. iv, 48; Josh. xxi, 27; 1 Chron. vi, 71; Josephus, *Ant.* iv, 7; see Reland, p. 815; Porter, *Damascus*, ii, 261, 254; Burckhardt, *Syria*, p. 286). The Gemara notices that the cities on each side of the Jordan were nearly opposite each other, in accordance with the direction to divide the land into three parts (Deut. xix, 2; Reland, p. 662). Maimonides says all the forty-eight Levitical cities had the privilege of asylum, but that the six refuge-cities were required to receive and lodge the homicide gratuitously (Calmet *On Num.* xxxv).

The directions respecting the refuge-cities present some difficulties in interpretation. The Levitical cities were to have a space of 1000 cubits (about 583 yards) beyond the city wall for pasture and other purposes. Presently after, 2000 cubits are ordered to be the suburb limit (Num. xxxv, 4, 5). The solution of the difficulty may be, either the 2000 cubits are to be added to the 1000 as "fields of the suburbs" (Lev. xxv, 34), as appears to have been the case in the gift to Caleb, which excluded the city of Hebron, but included the "fields and villages of the city" (Josh. xxi, 11, 12, Patrick), or that the additional 2000 cubits were a special gift to the refuge-cities, while the other Levitical cities had only 1000 cubits for suburb. Calmet supposes the line of 2000 cubits to be measured parallel, and the 1000 perpendicular to the city wall; an explanation, however, which supposes all the cities to be of the same size (Calmet *On Numbers*, xxxv).—Smith, s. v.

2. Places of refuge where, under the cover of religion, the guilty and the unfortunate might find shelter and protection were not unknown among the ancient heathen. The *jus asyli*, or right of shelter and impunity, was enjoyed by certain places reputed sacred, such as groves, temples, and altars. This protective power commonly spread itself over a considerable district round the holy spot, and was watched over and preserved by severe penalties. Among the Greeks and Romans the number of these places of asylum became in time very great, and led, by abuse, to a fresh increase of criminals (Tacitus, *Ann.* iii, 60, 63). Tiberius, in consequence, caused a solemn inquiry into their effects to be made, which resulted in a diminution of their number and a limitation of their privileges (Suetonius, *Tib.* 87, compared with Ernesti, *Excursus ad h. l.*; Osiander, *De Asyliis Gentium*, in Gronov. *Thesaur.* t. vi). In the Apocrypha (2 Macc. iv, 83) mention is made of a city having the *jus asyli*—"Onias withdrew himself into a sanctuary at Daphne that lieth by Antiochia." The temple of Diana at Ephesus (Acts xix, 27) was also a heathen asylum, whose privileges in this respect increased with the progress of time.

This pagan custom passed into Christianity. As early as Constantine the Great, Christian churches were asylums for the unfortunate persons whom an outraged law or powerful enemies pursued (Smith's *Gibbon*, c. xx). Theodosius, in 431, extended this privilege to the houses, gardens, and other places which were under the jurisdiction of the churches, and the synod of Toledo, in 681, widened the right of asylum to thirty paces from each church. Since then this ecclesiastical privilege prevailed in the whole of Catholic Christendom, and was preserved undiminished, at least in Italy, so long as the papal independence remained (Hallam's *Middle Ages*, c. ix, pt. 1). The right acted beneficially in ages when violence and revenge predominated, and fixed habitations were less common than now; but its tendency to transfer power from the magistrate to the priesthood was injurious to the inviolability of law and the steady administration of justice. It has accordingly in recent times been

abrogated by most governments (*Conversations-Lexikon*, s. v.).

8. Among the Jews, the "cities of refuge" bore some resemblance to the asylum of the classic nations, but were happily exempt from the evil consequences to which reference has been made, and afford, even to the present day, no mean proof of the superior wisdom and benignant spirit of the Jewish laws. The institution was framed with a view to abate the evils which ensued from the old-established rights of the blood-avenger [see AVENGER OF BLOOD], and thereby to further the prevalence in the nation of a mild, gentle, and forgiving spirit. An inspection of the map will show how wisely these places were chosen so as to make a city of refuge easy of access from all parts of the land. To any one of these cities a person who had unawares and unintentionally slain any one might flee, and, if he reached it before he was overtaken by the avenger of blood, he was safe within its shelter, provided he did not remove more than a thousand yards from its circuit, nor quit the refuge till the decease of the high-priest under whom the homicide had taken place. If, however, he transgressed these provisions, the avenger might lawfully put him to death. The roads leading to the cities of refuge were to be kept in good repair. Before, however, the fugitive could avail himself of the shelter conceded by the laws, he was to undergo a solemn trial, and make it appear to the satisfaction of the magistrates of the place where the homicide was committed that it was purely accidental. Should he, however, be found to have been guilty of murder, he was delivered "into the hand of the avenger of blood, that he might die." The benefit of the protection afforded was common to strangers and sojourners with native Israelites.

According to the Rabbins, in order to give the fugitive all possible advantage in his flight, it was the business of the Sanhedrim to make the roads that led to the cities of refuge convenient by enlarging them, and removing every obstruction that might hurt his foot or hinder his speed. No hillock was left, no river was allowed over which there was not a bridge, and the road was at least two-and-thirty cubits broad. At every turning there were posts erected bearing the words *Refuge, Refuge*, to guide the unhappy man in his flight; and two students in the law were appointed to accompany him, that, if the avenger should overtake him before he reached the city, they might attempt to pacify him till the legal investigation could take place. When once settled in the city of refuge, the manslayer had a convenient habitation assigned him gratuitously, and the citizens were to teach him some trade whereby he might support himself. To render his confinement more easy, the mothers of the high-priests used to feed and clothe these unfortunate fugitives, that they might not be impatient and pray for the death of their sons, on whose decease they were restored to their liberty and their property. If the slayer died in the city of refuge before he was released, his bones were delivered to his relations, after the death of the high-priest, to be buried in the sepulchre of his fathers (Lewis, *Origines Hebraicae*). If the homicide committed a fresh act of manslaughter, he was to flee to another city; but if he were a Levite, to wander from city to city. An idea prevailed that when the Messiah came three more cities would be added—a misinterpretation, as it seems, of Deut. xix, 8, 9 (Lightfoot, *Cent. Chor.* ciii, 208). Jerusalem, to some extent, possessed the privilege of asylum under similar restrictions—a privilege accorded to Shimei, but forfeited by him (1 Kings ii, 86, 46).

That the right of asylum among the Jews was in later periods of their history so extended as to open the door to great abuses may be inferred from 1 Macc. x, 43, where unqualified impunity and exemption from both liabilities and penalties are promised, under the influence, not of the Mosaic law, but of heathen morals

and ambition, to "whosoever they be that flee unto the Temple at Jerusalem, or be within the liberties thereof." In the words now cited, reference appears to be made to a custom which prevailed from very early times, both among the chosen people and the nations of the world, of fleeing, in case of personal danger, to the altar. With the Jews, it was customary for the fugitive to lay hold of the horns of the altar, whether in the tabernacle or Temple; by which, however, shelter and security were obtained only for those who had committed sins of ignorance or inadvertence (Exod. xxi, 14; 1 Kings i, 50; ii, 28). From the last two passages, it seems that state criminals also sought the protection of the altar, probably more from the force of custom than any express law. Their safety, however, depended on the will of the king; for in the passages referred to it appears that in one case (that of Adonijah) life was spared, but in the other (that of Joab) it was taken away even "by the altar." Compare Matt. xxiii, 35.—Kitto, s. v. A similar instance is found in Grecian history, in the case of Pausanias, who fled from the populace, incensed on account of his public treachery, to the temple of Minerva, where he was starved to death by order of the Ephori, by blocking up the entrance and taking off the roof (compare Smith's *Dict. of Class. Antiq.* s. v. Asylum). See ASYLUM.

CITY OF DAVID, a section in the southern part of Jerusalem, embracing Mount Zion, where a fortress of the Jebusites stood. See JESUS. David reduced the fortress, and built a new palace and city, to which he gave his own name (1 Chron. xi, 5). Bethlehem, the native town of David, is also called, from that circumstance, the city of David (Luke ii, 11).

CITY OF GOD, one of the names of ancient Jerusalem (Psa. xlvj, 4), and its appropriateness is evident from Deut. xii, 5.

HOLY CITY. The sacredness of the Temple extended itself in some measure over the city, and hence Jerusalem itself was called the *Holy City*, and is so distinguished in the East at the present day (Neh. xi, 1; Dan. ix, 24). See JERUSALEM.

LEVITICAL CITY. See LEVITE.

CITY OF PALM-TREES. See IR-HATTEMARIM.

SACERDOTAL CITY. See PRIEST.

CITY OF SALT. See IR-HAMMELAH.

TREASURE-CITY (in the plur. טְּסֵנוֹת, *cities of provisions*, "store-cities," 1 Kings ix, 19). Pithom and Raameses (q. v.) are mentioned in Exod. i, 11, as treasure-cities built by Pharaoh for the unpaid labor of the Hebrews; they were probably magazines or dépôts for the royal revenue (which was doubtless paid in kind), such as are intimated in Gen. xii, 48; see xlviii, 26. The Jewish kings had similar places of public deposit (2 Chron. viii, 4, 6; xvi, 4; xvii, 2). See TREASURE.

Civil Administration of the Hebrews. See GOVERNMENT (OF THE HEBREWS).

Clagett, WILLIAM, D.D., a divine of the Church of England, was born at St. Edmundsbury, Suffolk, 1646; entered Emmanuel College, Cambridge, 1669; and took his degrees there, the final one of D.D. in 1688. After preaching seven years in his native town he became preacher of Gray's Inn, London, and rector of Farnham Royal in 1688. He died March 28, 1688. Among his writings are, *A Discourse concerning the Operations of the Holy Spirit*, against Dr. Owen (Lond. 1680, 2 vols. 8vo); *Sermons* (Lond. 1704-1720, 4 vols. 8vo); and several pamphlets on the Romish controversy.—Kippis, *Biographia Britannica*, iii, 592 sq.; Darling, *Cyclopædia Bibliographica*, i, 686.

Claggett, THOMAS JOHN, D.D., a bishop of the Protestant Episcopal Church, was born in Prince George County, Md., on the 2d of October, 1743, and graduated at Princeton 1764. He went to England for ordination in 1767, and on his return to America

became rector of All Saint's parish, Md. On the breaking out of the Revolution he retired to Prince George's, and in 1779 began to officiate there in St. Paul's parish. In 1792 he was elected to the episcopate, being the first bishop that was consecrated on this side the Atlantic. In 1800 he was chaplain to the Senate of the United States; in 1806 he became rector of Trinity Church, Upper Marlborough, Md. He died on the 2d of August, 1816.—Sprague, *Annals*, v, 252.

Clairvaux (CLARAVALLIS), the name of a celebrated Cistercian abbey, in a valley of the Department Aube, in France. Bernard became its abbot in 1115, and the monastery was the model of monasticism in the 12th and 18th centuries.—Neander, *Ch. History*, iv, 254. See BERNARD; CISTERCIANS.

Clap, THOMAS, a Congregational minister, was born at Scituate, Mass., June 26, 1708, and graduated at Harvard 1722. He was ordained pastor at Windham, Aug. 8, 1726; was elected to the rectorship of Yale College in 1739, and entered upon the duties of the office April 2, 1740. He devoted himself energetically to the work of the college; framed its code of laws (1748, Latin, "the first book ever printed in New Haven"); improved its library, and in various ways strengthened the institution. He was especially noted for his knowledge of mathematics and physics, and constructed the first orrery made in America. His opposition to Whitefield, and other causes, raised up a party against him, and in 1765 he resigned his office; the corporation, however, passing a vote "expressive of their high estimation of his character and services." He died in New Haven, January 7, 1767. President Clap published *An Introduction to the Study of Philosophy, exhibiting a general View of all the Arts and Sciences* (1743); *The Religious Constitution of Colleges, especially of Yale College, New Haven* (1754); *A brief History and Vindication of the Doctrines received and established in the Churches of New England, with a Specimen of the new scheme of Religion beginning to prevail* (1755); *An Essay on the Nature and Foundation of moral Virtue and Obligation* (1765); *Annals or History of Yale College* (1766); *Conjectures upon the Nature and Motions of Meteors which are above the Atmosphere* (post, 1781).—Sprague, *Annals*, i, 843; Allen, *American Biography*, s. v.

Clara, or Clare, a saint of the Roman Catholic Church, was born at Assisi, Italy, 1198, of a noble family. She abandoned her home in 1212, and was received by Francis of Assisi, who cut off her hair, and replaced her fine clothing by a piece of sackcloth tied about her with a cord. Her parents strenuously resisted this step; but, under the guidance of Francis, she disobeyed them, and devoted herself to monastic life. She practised unheard of austerities, mournful to read of as described by Butler (cited below). Clara was the founder of the Clarisses, or nuns of St. Clara (q. v.). See Butler, *Lives of Saints*, August 12; Lewis, *Bible, Missal, and Breviary*, i, 110.

Clara. See ABRAHAM à SANCTA CLARA.

Clare, St., NUNS OF, an order sometimes called Clarisses or Clarissines, from their founder St. Clara (q. v.). The reputation of St. Clara soon gained her a large number of followers, for whom several monasteries were built in various parts of Italy. In the year 1219 the order passed into Spain, and soon after into France. The rules of the order were drawn up by St. Francis of Assisi in 1224: the Clarisses were forbidden to have any possessions, and silence was enjoined upon them from the compline till the tierce of the following day. Their habit was three tunics and a mantle. After the death of the founder the order made still greater progress, and counted for some time 2000 convents, with 54,000 nuns. After the Reformation there remained in Europe 900 convents, with about 25,000 nuns. In Italy there are monasteries of Clarisses, some of which take

the name of "Nuns of the Strict Observance," others that of "Solitaries of the Institution of St. Peter of Alcantara." After Cortez had conquered Mexico, Isabella of Portugal, wife of Charles V, sent thither some nuns of the order of St. Clara, who made several settlements there. Near their monasteries were founded communities of Indian young women, to be instructed by the Clarisses in religion, and such works as were suitable to persons of their sex. When Pope Urban IV mitigated the original rule, those who adopted the mitigated rule were called Urbanists, while the name of Clarisses remained to those who adhered to the original rule. A still stricter rule was observed by the *Congregation of St. Colette*, founded by St. Colette, who died in 1447, which was again surpassed in austerity by the discalceate Congregation of the Strictest Observance, founded in 1631 in Italy, and the Hermitesses of St. Peter of Alcantara (or Alcantarines), founded in 1676. According to the statistics of 1862, convents were found in Italy, France, Austria, Bavaria, Switzerland, Poland, Belgium, Holland, England, Scotland, Spain, Prussia, Ireland, at Macao and Manila in Asia, in Mexico, and in Central and South America. The number of members was about 6000.—Fehr, *Geschichte der Mönchsorden*, i, 456 sq. See FRANCIS OF ASSISI.

Clarenbach. See KLARENBACH.

Clarendon Constitutions, 1164. A struggle between the crown and the hierarchy in England began with the elevation of Thomas à Becket to the archiepiscopal chair (June, 1162). The pomp-loving courtier, brave warrior, and powerful statesman, the favorite and confidant of Henry II, had become a severe ascetic, a zealous hierarch, and the opponent of the king. At the council held by Alexander III in May, 1163, at Tours, Becket, with other English prelates, appeared, and was received with distinction by the pope. As soon as he returned, he attempted to execute the resolutions of the council in his province. He claimed certain possessions, which, as he asserted, had been long alienated from the see of Canterbury, and protested against the levy of a universal tax on real estate which the king demanded for state purposes. This already had occasioned a contest with the king, and a breach was almost effected at the Imperial Diet in Westminster, called by the king to reform the abuses of the ecclesiastical courts, which were made inaccessible to the arm of justice. Cases of this kind had often occurred within a few years, and the archbishop now again opposed the demands of the king and the barons, while almost all the bishops answered in the affirmative to the question of the king if they would further support the "old customs of the kingdom," but with the addition of the dangerous clause, *salvo ordine suo et jure ecclesie*. At the prayers of the bishops and others high in office, perhaps also under admonitions from the pope, Becket also yielded at length.

To ratify the concessions made by the bishops with due solemnity, and in general to settle the points at issue between Church and crown, the king, in January, 1164, summoned an assembly of prelates and barons at Clarendon, a royal summer residence near Salisbury. The attendance was large. Becket appeared, but only to revoke the concessions he had made, and to declare them treason to the inalienable rights of the Church. But at last, overwhelmed by prayers and threats, Becket once more pledged his priestly word to support faithfully the ancient customs. The conferences were soon ended. Their results were the *Clarendon Constitutions*, or, as they were called, *consuetudines recognite*, in sixteen chapters, the contents of which are substantially the following (with the judgment of the pope upon them appended in italics):—1. Disputes concerning the right of patronage between laymen, or between clergymen and laymen, or between clergymen

king. (*Condemned by the pope*.) 2. Churches belonging to the king's fief cannot be given permanently away without his consent. (*Tolerated*.) 3. Clergymen accused of any crime must, upon a summons from a royal judge, appear at the king's court, where it will be decided whether the matter is to be handed over to a civil or ecclesiastical court; in the latter case, a delegate appointed by the king's judge is to be present at the trial. If the accused is found guilty, or confesses, the Church shall not further protect him. (*Condemned*.) 4. Archbishops, bishops, or high officials of the kingdom shall not leave the kingdom without the king's permission; and, even in case of permission, must give security that on their journey they will undertake nothing to the disadvantage of the king or the kingdom. (*Condemned*.) 5. Excommunicated persons need not give bonds to remain where they are, nor to promise by oath to do so, but only to give bonds or a pledge to abide by the decision of the Church, that they may be absolved. (*Condemned*.) 6. Laymen can only be accused by trustworthy and legitimate witnesses in the presence of the bishop, yet so that the archdeacon does not lose his right. In cases where no one appears as the accuser, the sheriff, at the command of the bishop, is to assemble twelve respectable men from the neighborhood, who are to swear before the bishop to tell the truth according to their best understanding. (*Tolerated*.) 7. Vassals of the crown, and the officers of their households, shall not be excommunicated, nor their lands laid under interdict, without previous notice to the king or his judges, that they may decide if the case is to be handed over to a civil or ecclesiastical tribunal. (*Condemned*.) 8. Appeals are to be made from the archdeacon to the bishop, from the bishop to the archbishop, and from him to the king, upon whose command the matter shall then be settled in the archiepiscopal court of justice. No further appeal allowed without the king's leave. (*Condemned*.) 9. In case of any dispute between a layman and clergyman concerning a tenement which the latter declares to be a lay fee, if it prove upon trial before twelve respectable men to be a lay fee, and not an ecclesiastical fee, the cause to be finally tried in the king's court, unless both claim tenure under the same bishop or baron, in which case the plea shall be in his court. (*Condemned*.) 10. If any one belonging to a royal court or demesne is summoned by an archdeacon or a bishop on account of some misdemeanor for which he is amenable to them, and he appear not, he may be put under an interdict, but under the ban only after a previous notification of the royal official of the place, and after the latter has vainly attempted to induce the accused to give the Church satisfaction. (*Condemned*.) 11. Archbishops, bishops, and vassals of the crown must, as holders of royal fiefs, appear before the judges and officers of the king, and preserve all the privileges and customs of the crown-fief, and be present also, like the other barons, at the proceedings of the royal court of justice, except at capital trials. (*Tolerated*.) 12. In case of a vacancy of an archbishopric, bishopric, an abbey, or a priorate, the revenues shall accrue to the king. At the reappointment, the king shall assemble the ecclesiastical dignitaries; the election shall take place in the royal chapel, with the king's consent, and the advice of the grandees of the kingdom assembled by him. In the same place the elect shall, while preserving his ecclesiastical state, take the oath of fealty to the king, his feudal lord, before he is consecrated. (*Condemned*.) 13. If any baron or tenant *in capite* should encroach upon the rights or property of a prelate, the king shall see justice done, and if any one encroach upon the possessions of the king, the prelates shall treat with that person that he may give satisfaction. (*Tolerated*.) 14. Forfeited possessions the Church dare not refuse to make over to the king, as such belong to him, whether they be inside or outside of the Church. (*Tolerated*.) 15. Pleas of debt are to be

made in the king's court, whether due upon contract or not. (*Condemned.*) 18. Sons of peasants cannot be ordained without the consent of their feudal lords. (*Tolerated.*)

The high importance of these decrees of the Diet, for those times, is very obvious. On the one hand, the king intended by them to make the dignitaries of the Church as dependent upon the crown as the barons, and not only to put a limit to their jurisdiction, but also to secure the election and investiture of the prelates, and, by limitations of the appeals to the pope, to preserve his own paramount rights. On the other hand, his aim was to put the exercise of justice upon a sure footing, by subjecting the whole clergy to the common law of the country. The Constitutions contain the germs of the highly important institution of the wandering assizes, founded by him twelve years later at the Diet in Northampton. The barons willingly gave their consent to this improvement of the administration of justice, and still more to the limitation of the powers of the Church, but Becket did everything in his power to destroy the effect of the Constitutions. Above all, the sixteenth article was directed against the lower clergy, who were his principal support. When the Constitutions were submitted to him that he might put his seal to them, as all the other prelates did in token of their consent, he refused. Afterwards, when one of the three copies made of the document was handed to him for his seal and signature, he seems to have yielded, after some resistance, to the command of the king; but he had scarcely left Clarendon when he showed the bitterest repentance. He suspended himself from all his clerical functions for forty days, until he had received from the pope absolution for his oath, and the condemnation of the Constitutions. After twice vainly attempting to fly across the sea, he was accused of the violation of the Constitutions at the Diet in Northampton, in October of the same year, and was commanded to give an account of the expenditure of considerable sums he had been intrusted with during his administration as lord chancellor. The crucifix in his hand, he declared that he would not listen to the sentence, and left the chamber, followed by calumnies, but received outside with enthusiasm by the people. A few days later he had fled to Flanders. After an exile of six years, he returned to England on the 1st of December, 1170, as, apparently at least, a reconciliation had been effected between him and the king. But only four weeks later he was assassinated in his cathedral. The consequences of this murder are well known. In October, 1172, at Avranches, the king had to take an oath of purification before the papal legate, and revoke all which displeased the pope in the Clarendon Constitutions. — Herzog, *Real-Encyclopädie*, Supplement, i, 827 (from which this article is translated); Wilkins, *Concilia Magna Britannia*, i, 435; Landon, *Manual of Councils*, p. 132; Mosheim, *Church History*, cent. xii, bk. iii, pt. ii, ch. ii, § 12; Hume, *Hist. of England* (Harpers' ed.), i, 303-306.

Clarenines, a monastic order founded in the neighborhood of Ancona in 1302 by Angelo di Cordova, after the suppression of the Celestians (q. v.), of which he had been a member. Angelo was cited before pope John XXII as a separatist in 1317, but was acquitted. He died at Naples 1340. After his death the Clarenines submitted themselves to the ordinaries, and made great progress in several dioceses of Italy. In 1472, however, a large number of them joined the Minorites (q. v.). Finally, when pope Julius II reorganized the Franciscans (q. v.), dividing them into Observants and Conventuals, the Clarenines, after inclining for a while toward the latter, at last connected themselves with the Observants. See Wadding, *Anal. Minor*; Henrion; Fehr, *Allg. Gesch. der Mönchsorden*, i, 285; Wetzler u. Welte, *Kirchen-Lexikon*, ii, 567.

Clario, or **Clartus**, ISIDORE, a Benedictine monk,

bishop, and writer, was born at the castle of Clario near Brescia, 1495, and at an early age entered the monastery of Monte Cassino, where he studied especially the original languages of Scripture. Paul III sent him to the Council of Trent, where he greatly distinguished himself, especially in the discussions in the Vulgate. The pope made him bishop of Foligno. He died May 28, 1555. His chief literary labor was a correction of the Vulgate, with annotations (*Vulgata editio V. et N. T.*, Venice, 1542, 1557, 1564, fol.). He asserts that he had corrected 8000 places; and his first edition (1542) was put into the Index Expurgatorius. He borrowed largely, in his notes, from Sebastian Münster (q. v.). — Hoefler, *Nouvelle Biog. Générale*, ix, 662; Hook, *Eccles. Biog.* iv, 77.

Clark, Daniel A., A.M., a Congregational and Presbyterian minister, was born at Rahway, N. J., March 1, 1779, and graduated at Princeton in 1800. While a student at Andover Theological Seminary he was licensed by the Presbytery of New Jersey, and in 1812 he was ordained and installed pastor of the Congregational Union Ch. of Braintree and Weymouth, Mass. Thence he removed in 1815 to Hanover, N. J., and in 1816 to Southbury, Conn., where, in addition to his work as a minister, he taught gratuitously "with a view of elevating the standard of education." In 1820 he was installed pastor of the west parish of Amherst, Mass., where he was involved in certain difficulties, and in 1826 he accepted a call to Bennington, Vt., where he was very active and useful. Leaving Bennington in 1830, he supplied Dr. Beman's pulpit in Troy, labored for a time in Utica, N. Y., and was installed pastor in Adams, Jefferson Co., N. Y., in 1832. In 1833 his health obliged him to withdraw from the ministry. He devoted the remainder of his days to literary pursuits, and died March 3, 1840. "Though practically a Congregationalist while he exercised his ministry in New England, he always retained his preference for the Presbyterian form of Church government, and resumed his relations with the Presbyterian Church as soon as he had the opportunity." Dr. Osgood (in Sprague, cited below) says: "The published sermons of Mr. Clark, I believe it is generally admitted, take rank with the ablest sermons which our country has produced." For his publications, see *His Complete Works, with a Biographical Sketch, etc.*, by Rev. Geo. Shepard, D.D. (1846, 2 vols. 8vo); 5th edit. edited by his son J. H. Clark, M.D. (N. Y. 1855, 2 vols. 8vo). — Sprague, *Annals*, iv, 460.

Clark, John, a Baptist minister, was born near Inverness, Scotland, Nov. 29th, 1758. Having from his early boyhood a strong propensity for a seafaring life, he was for about one year on board of a privateer, afterwards sailed as second mate to the West Indies, and arriving at Barbadoes, was impressed into the British navy. Here he deserted, and the next vessel on which he engaged being captured by the Spaniards, he was for nineteen months a prisoner of war at Havana. Soon after his exchange he was a second time impressed, and, deserting again, reached Charleston, S. C. In 1785 he taught school in the back settlements of Carolina. Revisiting England, he became acquainted with Mr. Wesley, and after his return to this country in 1789 he became an itinerant preacher in Georgia. Finally he became a Baptist, and a member of the so-called "*Baptized Church of Christ*," or "*Friends of Humanity*," on account of their opposition to slavery. Remaining a few months in the "Florida Parishes," Louisiana, where he preached almost daily and with great acceptance, he travelled to Illinois on foot, and in 1811 revisited Louisiana, preaching wherever he had an opportunity, and travelling great distances, always on foot. He died in St. Louis Co., Mo., Oct. 11th, 1833. — Sprague, *Annals*, vi, 490.

Clark, John, a Methodist Episcopal minister, was born in Washington County, N. Y., July 30, 1797; was

converted in 1817, and in 1820 entered the New York Conference of the Methodist Episcopal Church as an itinerant. Having labored within its bounds for sixteen years, he was in 1836 transferred to the Illinois Conference, and in 1841 to Texas. In 1844 he was a delegate to the General Conference of that year, and at its close was at his own request transferred to the Troy Conference. He was again transferred, in 1852, to the Rock River Conference, and stationed in Chicago, where he died of cholera, July 11, 1853. In all parts of the country he was eminently well received, and wherever he was stationed he left behind him the reputation of an able and earnest Christian minister. His frontier labors, full of toil and peril, which he met with abounding courage and energy, are amply described in Hall's *Life of Rev. John Clark* (N. Y. 8vo). See also *Minutes of Conferences*, v, 483; Sprague, *Annals*, vii, 626; *Methodist Quarterly*, Jan. 1857, p. 148.

Clark, John Alonzo, D.D., a Protestant Episcopal minister, was born in Pittsfield, Mass., May 6, 1801, and graduated in Union College, July, 1823. He studied in the General Theological Seminary, New York, and was ordained deacon April 12, 1826, when he took charge of a missionary station at Palmyra, N. Y. In 1829 he became assistant of Christ Church, New York City. In 1832 he accepted the rectorship of Grace Church, Providence, R. I., and in 1835 became rector of St. Andrew's, Philadelphia, where he labored for ten years with great acceptance and usefulness. His health failing, he made a visit to Europe, and on his return published *Glimpses of the Old World* (2 vols. 12mo, 1838). In 1843 he was compelled by the decline of his health to resign his rectorship, and on the 27th of November of that year he died. His publications, besides the *Travels* named above, are the following: *Christian Experience as displayed in the Life and Writings of St. Paul; The Pastor's Testimony* (1835); *The Young Disciple, or a Memoir of Anzetta R. Peters* (12mo, 1836); *Gathered Fragments* (12mo, 1836); *A Walk about Zion* (12mo, 1836); *Gleanings by the Way* (12mo, 1842); a posthumous volume of sermons, entitled *Awake, thou Sleeper* (12mo).—Sprague, *Annals*, v, 674.

Clark, Peter, a Congregational minister, was a native of Watertown, Mass., born 1698, graduated at Harvard 1712, and was ordained pastor in Salem village (now Danvers) June 3, 1717. He published several controversial pamphlets concerning "Original Sin" in opposition to the Rev. Samuel Webster and Dr. Chauncy (1757-1760); *Scripture Grounds of the Baptism of Christian Infants asserted and defended in a Letter*, etc. (1785); also several occasional sermons. He died in June, 1768.—Sprague, *Annals*, i, 291.

Clark, Samuel, a Methodist Episcopal minister, was born about 1800, in Frederick County, Va., of pious parents; entered the Baltimore Conference in 1821, located in 1834; entered the Ohio Conference in 1836, located in 1841, and emigrated to Iowa (then a Territory); entered the Iowa Conference in 1844, and, after various relations to this conference, died at his post, in Van Buren County, Iowa, Feb. 9, 1857. "This venerable man of God . . . had gone up and down for nearly forty years, preaching 'Christ and the resurrection' to thousands, from the Atlantic to the western borders of civilization." He was formidable in debate, and ranked high as a minister and public speaker.—*Minutes of Conferences*, 1859, p. 243.

Clarke, Adam, LL.D., a Wesleyan Methodist minister, distinguished as a divine, an antiquarian, and an Oriental scholar, was born at Moybeg, Londonderry Co., Ireland, in 1760 or 1762 (his own mother could not fix the date). His father, who was a classical teacher, was a member of the Church of England, but his mother, who was of Scottish origin, was a Presbyterian. Adam, when a boy, was remarkable for physical vigor, but seemed rather stupid than other-

wise, until about his eighth year, when the sarcasms of a schoolfellow upon his dulness seemed to rouse him from a lethargy. From that time he made rapid progress in learning, especially in the Latin language. In his 17th year his mind was brought, by the ministry of Mr. Brettell and Mr. Barber (Methodist preachers), under religious impressions, and in 1778 he joined the Methodist society at Mullica Hill, near Coleraine. He soon became a class-leader and home-missionary. Having been recommended to the notice of Wesley, he was sent by him in 1782 to Kingswood School, where he did not remain long. His sufferings there are amusingly detailed in his autobiography. While digging one day in the garden at Kingswood he found a half guinea, with which he bought a Hebrew Bible; and this (he says in his *Autobiography*) "laid the foundation of all his knowledge of the sacred writings of the Old Testament." Towards the end of 1782 he was sent out by Wesley as an itinerant preacher, and he remained in this laborious work with few interruptions until 1815. A more earnest, faithful, and diligent preacher never lived, and few more popular have ever appeared in England. To the last the chapels where he preached were filled to overflowing. Every part of Great Britain and Ireland, as well as Guernsey, Jersey, and the Shetland Islands, shared in his toils as preacher and missionary. In 1795 he was appointed to London, and again in 1805; and he now remained in the metropolis ten years, full of labors in the pastoral work, in the benevolent enterprises of the day, and in literary pursuits. He was thrice elected (1806, 1814, 1822) president of the British Conference.

While a travelling preacher, he found time for much study, especially in Oriental literature. In 1802 he published a *Bibliographical Dictionary* (6 vols. 12mo), which at once gave him a literary reputation. Before this, as early as 1798, he began to gather materials for a *Commentary on the Bible*, the first part of which was published in 1810, and the last in 1825. "In this arduous work," he says, "I have had no assistants, not even a single week's help from an amanuensis; no person to look for commonplaces, or refer to an ancient author, to find out the place and transcribe a passage of Latin, Greek, or any other language (which my memory had generally recalled), or to verify a quotation, the help excepted which I received in the chronological department from my own nephew, Mr. John Edward Clarke. I have labored alone for twenty-five years previously to the work being sent to the press, and fifteen years have been employed in bringing it through the press, so that nearly forty years of life have been so consumed" (*Autobiography*).

His literary labors in London from 1805 to 1815 (during which he "was abundant also in labors as pastor and preacher") were enormous. Soon after his settlement in the city he was called into the committee of the British and Foreign Bible Society, and for years he directed largely its publications in Oriental languages. In 1806 he published *The Bibliographical Miscellany* (2 vols.), a supplement to his *Bibliographical Dictionary*. In 1807 the University of Aberdeen gave him the degree of M.A., and in 1808 that of LL.D. In 1808 also appeared his *Succession of Sacred Literature*, vol. i (vol. ii by his son, J. B. B. Clarke, 1880, 8vo). At the end of that year the Bible Society requested that the rule of the Conference under which Dr. Clarke would be compelled to leave London might be suspended in his case, in order that he might remain in their service longer. The request was granted. In the same year the British government intrusted to him the arrangement, for publication of old state papers, in continuation of Rymer's *Fœdera*. On this laborious and comparatively unprofitable task he spent the best part of ten years, being relieved from it in 1819. After the organization of the Wesleyan Missionary Society in 1814, he preached, spoke, and travelled largely in its service. During all this time he

was working on his *Commentary*, and in studying for it made himself more or less completely master, not only of Greek and Hebrew, but also of the Oriental languages. He had long been acquainted with the languages of modern Europe. These varied and extraordinary labors at length injured his health, and in 1815 he withdrew from London to a small estate at Millbrook, Lancashire. Here he continued to prosecute his literary labors, and especially his *Commentary*, which was now in an advanced state of preparation. In 1828 he returned to the vicinity of London, and fixed his residence at Haydon Hall, where he spent the remainder of his days, engaged in literary labor, and also in the service of the Church in various ways. Among his most important labors of this period was the organization of Methodism in the Shetland Islands, to which he made two missionary journeys (1826 and 1828). During the summer of 1832 he exerted himself too much, and died at Bayswater, Middlesex, August 26 of that year, of cholera.

Dr. Clarke's life was one of almost unparalleled industry as preacher, pastor, student, and author. His literary reputation rests chiefly upon his *Commentary* (last ed. Carlton and Porter, N. Y. 1866, 6 vols. 8vo), which has had a wider circulation than any other in the English language, except, perhaps, Matthew Henry's. It is now superseded by later works, but will always be cited with respect for its multifarious learning, and for the frequent originality and acuteness of its annotations. As a theologian, Dr. Clarke was an Arminian, and held the Wesleyan theology entire, with the exception of the doctrines of the Eternal Sonship of Christ. His error on this point drew out those admirable works, Watson's *Remarks on the Eternal Sonship* (*Works*, Lond. ed. vol. vii), and Treffry's *Inquiry into the Doctrine of the Eternal Sonship* (3d ed. Lond. 1849).

Besides the works mentioned, Dr. Clarke also published *Discourse on the Eucharist* (Lond. 1808, 8vo); *Memoirs of the Wesley Family* (Lond. 8vo, N. Y. 12mo, several editions). He also edited, with numerous additions, Baxter's *Christian Directory*; Fleury's *Manners of the Israelites*; Shuckford's *Sacred and Profane History*; Sturm's *Reflections on the Being and Attributes of God*; and Harmer's *Observations on various Passages of Scripture* (1808, 4 vols. 8vo). His contributions to periodicals, and his minor writings, pamphlets, etc. are too numerous to be mentioned. His *Miscellaneous Works* have been collected since his death (Lond. 18 vols. 8vo). See Clarke, J. B. B., *Life of A. Clarke* (Lond. 3 vols. 8vo); Southey, *Quarterly Rev.* li, 117; Etheridge, *Life of A. Clarke* (Lond. 1858, N. Y. 1859, 12mo); Everett, *Adam Clarke portrayed* (Lond. 1845; 2d ed. 1866, 2 vols.); Stevens, *History of Methodism*, ii, 291, et al. A monument to the memory of Dr. Clarke was erected at Port Rush, Ireland, in 1859, by contributions from both the Old and the New World.

Clarke, Edward Daniel, LL.D., an English divine, of note as a writer of travels, was born at Willington, Sussex, in 1769, and was educated at Jesus College, Cambridge. From 1790 to 1799 he acted as tutor and travelling companion in several families, travelling in France, Italy, Switzerland, and Germany. "In 1799 he set out on an extensive tour with Mr. Cripps, a young man of fortune; they traversed Denmark, Norway, Sweden, Lapland, Finland, Russia, the country of the Don Cossacks, Tartary, Asia Minor, Syria, Egypt, Greece, and did not return to England till 1802." He was ordained in 1805, and received the college living of Harlton; in 1809 he was presented to the living of Yeldham by his father-in-law. His *Travels* appeared between 1810 and 1819 (5 vols.). A sixth volume, edited by Robert Walpole, was brought out after his death, 4to (also in 11 vols. 8vo, 1816). In 1803 he published *Testimonies of different Authors respecting the colossal Statue of Ceres*, and in 1805 *A Dissertation on the Sarcophagus in the British*

Museum. He died at London, March 9th, 1822 (*English Cyclopædia*, s. v.). See Otter, *Life and Remains of Edward Daniel Clarke* (Lond. 1825, 2 vols. 8vo).

Clarke, John, a distinguished Baptist minister, was born in England, Oct. 8, 1609. He practised medicine in London for some time, and came to Boston as a physician (date unknown). Dissatisfied with the management of the colony of Massachusetts, he left it, and with others purchased Aquetneck of the Indians, and called it Rhode Island. The deed dates March 24, 1638. In 1639 he, with eight others, founded Newport, R. I. It is not known when he became a Baptist or a preacher, but in 1644 he became first pastor of the Baptist church in Newport. In 1651 he visited a friend (William Witter) at Lynn, Mass.; held a religious meeting there; was arrested and fined by Judge Endicott twenty pounds, under penalty of public whipping in case the fine was not paid. Some of Mr. Clarke's friends paid his fine, but one of his companions (Mr. Holmes) was severely whipped. In 1651 he went to England to promote the interests of religious freedom in R. Island, and to have Mr. Coddington's commission as governor revoked. He accomplished this object. While in England he published *III News from New England, or a Narrative of New England's Persecution; wherein it is declared, that while Old England is becoming New, New England is becoming Old; also, Four Proposals to Parliament and Four Conclusions, touching the Faith and Order of the Gospel of Christ out of his last Will and Testament*, 4to, p. 76. In 1664 he returned to Newport, where he remained as pastor and physician until his death, April 20, 1676.—Bacchus, *Church History of New England*, vol. iii; Benedict, *History of the Baptists*, vol. i; Allen, *Am. Biog. Dictionary*, s. v.; Sprague, *Annals*, vi, 21.

Clarke, John, dean of Sarum (brother of Dr. Samuel Clarke), was born at Norwich, and bred a weaver, but was afterwards educated at Cambridge, where he received the degree of D.D. He obtained a prebend at Norwich, was appointed chaplain to the king, and, finally, dean of Salisbury. He died in 1759. His principal writings are, *An Inquiry into the Cause and Origin of Evil* (Boyle Lecture, Lond. 1720-21, 2 vols. 8vo); *A Demonstration of Newton's Philosophy* (Lond. 1780, 8vo). His translation of *Grotius de Veritate* is still reprinted. He furnished the notes to Wharton's *Religion of Nature*.—Hook, *Eccles. Biography*, iv, 90.

Clarke, Samuel, a Nonconformist, was born in Warwickshire, 1599; educated at Emmanuel College, Cambridge, and after preaching as an evangelist at Shotwick, and Coventry, and at Warwick (where he was chaplain to the earl), he became minister of Bennet Fink, London. He was ejected in 1662, and lived in studious retirement until his death in 1682. His chief works are *Marrow of Ecclesiastical History* (Lond. 1675, 2 vols. fol.); *A General Martyrology* (Lond. 1677, 3d ed. fol.); *Mirror for Saints and Sinners* (Lond. 1671, 2 vols. fol.); *Medulla Theologia* (1659, fol.).—Hook, *Eccles. Biography*, iv, 79; Calamy, *Nonconformists' Memorial*, i, 88.

Clarke, Samuel, D.D., a celebrated English divine and metaphysician, was born at Norwich, October 11, 1675. He received his first education in the free-school of Norwich, but was entered at 1691 in Caius College, Cambridge. (The following account, so far as the facts of Clarke's life are concerned, is modified from the *English Cyclopædia*, which is based on the *Biographia Britannica*.) At twenty-one, after closely studying and justly appreciating the reasonings of Newton's "Principia," which had then just appeared, he published a new version of the text of Robault's *Physica*, with numerous critical notes, added with the view of bringing the Cartesian system into disrepute by exposing its fallacies. After passing through four editions as the University text-book, it gave place, as Clarke desired, to the adoption of undisguised New-

esian treatises. He now went through a diligent course of Biblical reading in the original languages, in the course of which he carefully studied the early Christian fathers. On his ordination he was introduced to Dr. More, bishop of Norwich, by Whiston, whom he succeeded as domestic chaplain to that bishop for twelve years. In 1699 he published three essays on *Confirmation, Baptism, and Repentance*, together with *Reflections on Toland's Amyntor*, concerning the uncanonical Gospels. Two years afterwards followed his *Paraphrase on the Four Gospels*, which included Bishop More to present him with the living of Drayton, near Norwich. In 1704 he was appointed to preach the Boyle lecture at Oxford, when he chose for his subject *The Being and Attributes of God*. The satisfaction which he gave on this occasion led to his reelection the following year, when he read a series of lectures on the *Evidences of natural and revealed Religion*. These discourses passed through several editions. Clarke's argument for the being of God "rests upon the fact that we have the conceptions of time and space, expressive of certain attributes or qualities—the one eternal, the other illimitable in its nature. But every quality must have a coexistent subject to which it belongs, and therefore, he argues, there must exist a being who possesses these attributes of infinity—that is, there must be a God. The similarity between Clarke's argument and that of Spinoza, in many points, is at once evident. They both started with the idea of necessary existence, showing that if any thing exist now, something must have existed from eternity. The distinction between the two arguments arises from their different determination of the absolute idea from which our reasoning must commence. Clarke affirmed the idea of infinite attributes to be fundamental, and then inferred an infinite substance. Spinoza began with the infinite substance, and inferred the attributes. The result was that the latter rested finally in the notion of substance as identical with God, and reduced the common theism to pantheism; the former, reasoning from the attributes, was open upon other evidence to conceive of them as existing in a divine personality—in the God of Christianity. The clearness, however, with which both grasped the idea of the infinite, as one of the necessary conceptions of the human mind, is in either case abundantly manifest" (Morell, *History of Modern Philosophy*, chap. ii, § 2).

Numerous replies and objections to this *a priori* argument appeared at the time of its first publication. (See a list in Kippis's *Biog. Britannica*, and the correspondence between Butler, afterwards bishop of Durham, and Clarke, printed at the end of Bishop Butler's Works.) One of the principal was 'An Inquiry into the Ideas of Space, Time,' etc., by Bishop Law. The *Evidences* also met with strong opposition. See GOD; NATURAL THEOLOGY. The foundation of morality, according to Clarke, consists in the immutable differences, relations, and eternal fitness of things. The last expression, being of frequent occurrence in this discourse, acquired a fashionable usage in the ethical vocabularies of the day. Regardless of moral sentiment, so fully developed since by Shaftesbury, Hutcheson, and Adam Smith, Clarke insists solely upon the principle that the criterion of moral rectitude is in the conformity to, or deviation from, the natural and eternal fitness of things; in other words, that an immoral act is an irrational act—that is, an act in violation of the actual ratios of existent things. The endeavor to reduce moral philosophy to mathematical certainty was characteristic of that age, and led to the formation of theories remarkable perhaps more for their ingenuity than utility. Dr. Price is an opponent for the moral theory of Clarke, and among its opponents we may instance Sir James Mackintosh, *Progress of Ethical Philosophy*, p. 78 sq.; see also Whewell, *Hist. of Moral Philosophy*, lect. v.

In 1706 Clarke obtained the rectory of St. Bennett's,

in London. He published in the same year an answer to the treatise of Dr. Dodwell "On the Soul," in which that divine contends that it is not immortal until made so by baptism. Several rejoinders followed on each side. His patron, Dr. More, next procured for him the rectorship of St. James's and a chaplaincy to Queen Anne, which induced him to take his degree of D.D. In 1712 appeared his *Scripture Doctrine of the Trinity*, a work which involved him for the remainder of his life in a controversy, in which his principal adversary was Dr. Waterland. A full account of the controversy may be found in Van Mildert's *Life of Waterland* (see also WATERLAND). The Lower House of Convocation, in 1714, complained to the bishops of the heterodox and dangerous tendency of its Arian tenets, and Clarke was prevailed upon to apologize, and to declare his intention not to write any more upon the Trinity. A circumstantial account of this proceeding is given in the *Apology for Dr. Clarke*, 1714.

"Clarke's views were, in reality, a reproduction of the Origenistic and High-Arian doctrine of subordination, as distinguished from the Athanasian. His positions were the following: The supreme and only God is the Father—the sole origin of all being, power, and authority. 'Concerning the Father, it would be the highest blasphemy to affirm that he could possibly have become man, or that he could possibly have suffered in any sense, in any supposition, in any capacity, in any circumstance, in any state, or in any nature whatever.' With the Father there has existed 'from the beginning' a second divine Person, who is called his Word or Son; who derives his being or essence, and all his attributes, from the Father, not by mere necessity of nature, but by an act of the Father's optional will. It is not certain whether the Son existed from all eternity, or only before all worlds; neither is it certain whether the Son was begotten from the same essence with the Father or made out of nothing. 'Both are worthy of censure who, on the one hand, affirm that the Son was made out of nothing, or, on the other, affirm that he is the self-existent substance.' Clarke will not be positive upon these points, because of the danger of presuming to be able to define the particular metaphysical manner of the Son's deriving his essence from the Father. With the Father a third Person has also existed, deriving his essence from him through the Son. This Person has higher titles ascribed to him than to any angel, or other created being whatsoever; but is nowhere called God in Scripture, being subordinate to the Son, both by nature and by the will of the Father. The error of Clarke originated in his failure to discriminate carefully between the essence and the hypostasis. Hence, in quoting from the Scriptures and the fathers, he refers to the essential nature phraseology that implies subordination, and which was intended by those employing it to apply only to the hypostatical character. He even cites such high Trinitarians as Athanasius and Hilary as holding and teaching that the subordination of the Son to the Father relates to the Son's essence. The term 'unbegotten' he also held, as did the Arians, to be a synonym with 'uncreated,' so that the term 'begotten' must necessarily signify 'created.' Thus, misconceiving the Nicene use of these two terms, he endeavors to prove that the Nicene Trinitarians taught that the Father alone possesses necessary existence, while the Son exists contingently. But both of these terms, as we have seen, were limited by the Council of Nice to the Person, and have no relation to the essence. The essence, as such, neither begets nor is begotten. They merely indicate the peculiar manner in which the first and second hypostasis participate in one and the same eternal substance or nature. In this use of the terms, consequently, 'begotten' signifies 'uncreated' as much as does 'unbegotten.' The Begotten Son is as necessarily existent as the Unbegotten Father, because the essence is the seat and

source of necessary existence, and this is possessed alike by both—in the instance of the first Person by paternity, and of the second by filiation" (Shedd, *History of Christian Doctrine*, i, 886-888).

"The point on which Clarke's philosophical fame chiefly rests, and to which he devoted a very considerable portion of his life, was his controversy upon *Liberty and Necessity*—a controversy in which he stood opposed to Leibnitz and Collins, and by which he endeavored to overturn, finally, the fatalistic conclusions of Spinozism. Throughout this contest, the victory in which was claimed on both sides, Clarke maintained most powerfully the doctrine of Free-will, and, accordingly, here also manifested his opposition to the philosophy which tends to merge the idea of self either into that of nature or of God. Of the three fundamental conceptions, therefore, from which all philosophy springs, those of finite self and the infinite held in the writings of Clarke by far the most prominent place, so that we may properly regard him as the chief representative of the idealistic tendency during the age immediately succeeding Locke, as Cudworth was during the age that immediately preceded him" (Morell, *History of Modern Philosophy*, pt. i, ch. ii, § 2).

In 1724 Clarke obtained the mastership of Wigston Hospital, and published a volume of sermons. He died rather suddenly in May, 1729. His *Exposition of the Church Catechism and Sermons* were published after his death (London, 1730, 10 vols. 8vo). In the *Catechism* he teaches that worship should be paid to the Father only, through the Son, and in the Holy Spirit. The moral character of Clarke is praised by all his biographers. His principal works were translated into German by Semler, and prepared the way for German Rationalism. "He was a wary and very skillful disputant, well disciplined in the scholastic logic. Inferior to Locke in comprehensiveness and originality, he was greatly superior to him in acquisitions, being eminent as a divine, a mathematician, a metaphysician, and a philologist" (*English Cyclopædia*). His *Works* were published in 1738, in 4 vols. fol., of which the first contains his *Life* (by Hoadley), and 114 Sermons, published from his MS.; the second contains 76 Sermons and the Boyle Lectures; the third, a paraphrase of the Four Evangelists, with minor pieces; the fourth, the *Scripture Doctrine of the Trinity*, and a number of controversial tracts. Of the separate works numerous editions have been published. See, besides the writers already cited, (especially) Fairbairn's *Appendix to Dornier's Person of Christ* (Edinburgh translation, div. ii, vol. iii, 370 sq.); Hoadley, *Life of Clarke* (prefixed to *Works*, 4 vols.); Hook, *Eccles. Biography*, iv, 88; Watson, *Theological Institutes*, i, 331 (N. Y. ed.); Hagenbach, *History of Doctrines* (ed. by Smith), § 234, § 262.

Claromontanus, CODEX. See CLERMONT MANUSCRIPT.

Clarkson, THOMAS, was born March 26, 1760, at Wibeach, Cambridgeshire, where his father, a clergyman, was master of the free grammar-school. He studied at St. John's College, Cambridge, and became a promoter of the anti-slavery agitation in Great Britain by a Latin prize-essay which he wrote in 1785, on the question, "Is it right to make slaves against their will?" In order to pursue the agitation of the question, he relinquished his chances of advancement in the Church, for which he was intended, and in which he had taken deacon's orders. His essay was translated into English, and had an extensive circulation. Thenceforth his life was devoted to the anti-slavery cause. He labored indefatigably to bring to light the iniquities and cruelties of the slave-trade, travelling some years thousands of miles in furtherance of his benevolent designs, and publishing on the subject almost every year. He lived to see not only the slave-trade abolished (in 1807), but the abolition of slavery

itself in the British West Indies in 1833. He also took an active part in other benevolent schemes, particularly in the establishment of institutions for seamen. He died Sept. 26, 1846. His principal writings are: *History of the Abolition of the Slave-trade* (2 vols. 8vo, 1808; new ed., with Preface by Brougham, 1839); *A Portrait of Quakerism*, 1807; and a *Life of William Penn*, 1818. See Taylor, *Biog. Sketch of T. Clarkson* (Lond. 1847, 12mo).

Class-leader. See CLASS-MEETINGS.

Class-meetings. In the Methodist Episcopal Church, and indeed in all Methodist churches throughout the world, each congregation is divided into smaller companies, called *classes*. One of the more experienced members is appointed by the pastor to be *leader* of the class. "It is his duty," in the Methodist Episcopal Church, "1. To see each person in his class once a week at least; in order (1.) To inquire how their souls prosper. (2.) To advise, reprove, comfort, or exhort, as occasion may require. (3.) To receive what they are willing to give towards the relief of the preachers, church, and poor. II. To meet the ministers and the stewards of the society once a week; in order (1.) To inform the minister of any that are sick, or of any that walk disorderly, and will not be reprov'd. (2.) To pay the stewards what they have received of their several classes in the week preceding" (*Discipline*, pt. i, ch. ii, § 1).

A rudiment of the "class-meeting" may perhaps be found in the *Prophecies* begun at Northampton. These were religious meetings for discussions on the Scriptures, prayer, and mutual instruction, conducted by clergymen under fixed rules. Bishop Grindal, Bishop Parkhurst, and other bishops highly approved them, but Queen Elizabeth prohibited them (May 7, 1577; Wilkins, *Council*, iv, 289); they were, however, kept up in many places until Whitgift (who became archbishop of Canterbury in 1588) succeeded, in his violent way, in putting them down. Marsden (*Churches and Sects*, i, 260) remarks that these meetings gave Wesley "the idea of those social meetings in which the laity were to sustain an important part, though still under the guidance of their pastors, and in which the strength of Methodism consists" (see also Grant, *History of the English Church*, i, 426, London, 1811). A nearer approach to the "class-meeting" is to be found in the "religious societies" so widely diffused in the Church of England toward the close of the 17th century. According to Woodward (*Rise and Progress of the Religious Societies*, etc., Lond. 1744), it was "about 1686 that several young men in London, being brought to serious convictions by the preaching of their clergy, and applying to their ministers for religious counsel, were advised by them to meet together once a week, and apply themselves to good discourse and things wherein they might edify one another." These societies soon multiplied, and in 1678 a digest of rules for their conduct was adopted. Horneck, Beveridge, Stillingfleet, and Tillotson were among the promoters of these societies. By 1691 there were forty of these religious societies in London, and many in other parts of England. For their rules see Woodward (cited above), and also Hook, *Ecclesiastical Biography*, ii, 363; vi, 166. Dr. Clarke (*Memoirs of the Wesley Family*, Lond. 1848, vol. i, p. 144) gives a letter from Samuel Wesley, *Concerning the Religious Societies* (1699), in which they are named as supplying the lack of confraternities, sodalities, etc., in the Church of England, and their objects and methods are highly commended. On the Continent of Europe, the *Collegia Pietatis*, begun by Spener at about the same time, had ends and methods somewhat like those of the later class-meeting (see PIETISM; SPENER). Woodward's book was translated into German by the excellent D. E. Jablonski (q. v.), and similar societies were formed in various parts of Germany (*Christian Remembrancer*, July,

54, 200). The nearest approach to the "class-meeting" in the Roman Church is perhaps to be found in the "Society of St. Vincent de Paul," which is composed of laymen, whose objects are mutual edification; periodical meetings, and the promotion of active charity. See VINCENT DE PAUL, SOCIETY OF.

When Wesley commenced his itinerant labors, the *religious societies* "received Mr. Wesley with open arms" (Coke and Moore, *Life of Wesley*, 1792, p. 6, 7). It is not at all unlikely that Wesley's views as to the "social" life of Christianity received an impulse from these organizations. But, according to his own account, the "class-meeting" arose out of what was at first a merely fiscal plan to pay a church debt in Bristol (1742). "It was agreed (1.) That every member of the society that was able should contribute a penny weekly; (2.) That the whole society should be divided into little companies or classes, about twelve in each class; and (3.) That one person in each should receive that contribution of the rest, and bring it in to the stewards weekly. Thus began that excellent institution, merely upon a temporal account, from which weaped so many spiritual blessings that we soon fixed the same rule in all our societies" (Wesley, *Works*, N. Y. ed., vii, 350). Some time after, complaints being made to Wesley of the conduct of some members of the societies, it struck his mind, "This is the very thing we need. The leaders are the persons who may not only receive the contributions, but also watch over the souls of their brethren" (Wesley, *Works*, vii, 350). All Mr. Wesley's societies were soon divided into these classes, under rules which are still substantially observed (see above).

Much of the energy, unity, and stability of Methodism is due to the class system. The most intelligent and advanced Methodists hold it in high esteem. "Methodism holds that the communion of saints is part of a man's duty before he can claim to be a partaker of the body and blood of Christ, which is the public sign of fellowship with the whole body; and it says to a man that we hold that it is part of God's will that we should exhort one another, edify one another, confess our faults one to another, commune one with another on God's dealings with us and our walk with God. I am prepared to stand before members of the Lutheran Church, members of Presbyterian or Episcopal churches, and say, as I constantly do, You omit from your Church organization a vital part of New Testament Christianity. Your Church provides for the individual life; it provides for the public life of the Church, but it altogether leaves out the social life of the Church; and that is in the New Testament as I hold" (Arthur, *Speech at Wesleyan Conference, Sheffield*, 1863). "Nothing is so little understood amongst Christians as the nature of the 'communion of saints,' and its vitalizing influence in the conservation of religious life, and the enlargement of the kingdom of Christ. The class-meeting amongst the Methodists is nothing but the realization of this idea; it is the concert of souls actuated by religious feeling to carry out the great purpose of their 'high calling.' It has been the true life of every thing in Methodism, in every part of the world, like those agencies of nature which lie out of sight, but, by their penetrating influence, give vitality alike to the flower and the forest tree" (*Lond. Quar. Review*, Oct. 1854, p. 181). "Even if the class-meeting were less inseparably bound up with the entire disciplinary and financial economy of Methodism, still its advantages are so numerous that to sever it from the Methodistic system would be to inflict a paralyzing stroke, if not a death-blow. It affords opportunity for instruction more individual and personal than can be offered from the pulpit, for Christian fellowship more intimate than can be enjoyed in the congregation, for the needful outpourings of a mind burdened either with sorrow or with joy, for watching the progress of young disciples, for prevent-

ing backsliding by timely admonition, and for special oversight of the sick and the poor." See Keys, *Class-leaders' Manual* (N. Y. 1851, 18mo); Miley, *Treatise on Class-meetings* (Cincinnati, 1851, 18mo); Rosser, *On Class-meetings* (Richmond, 1855); Fish, *On Class-meetings* (Lond. 1850, 18mo); Wesley, *Works* (N. Y. edit.), v, 179, and often; Porter, *Compendium of Methodism*, 47, 458; Stevens, *History of Methodism*, ii, 430, 452; *Wesleyan Methodist Magazine*, July, 1863, p. 619; August, 1855, p. 704; Smith, *History of Wesleyan Methodism*, i, 660-672 (Lond. 1857, 8vo); *Meth. Quar. Rev.* 1862, 559, 662; *Life of Father Reeves, the Class-leader* (N. Y. Carlton and Porter).

Clau'da (Κλαυδία), a small island of the S.W. coast of Crete, which Paul passed on his tempestuous voyage to Rome (Acts xii, 16); called also *Gaudos* by Mela (ii, 7) and Pliny (*Hist. Nat.* iv, 42), *Claudus* (Κλαυδός) by Ptolemy (iii, 7), and *Claudia* (Κλαυδία) in the *Stadiasmus Maris Magni*: it is still called *Claudanesa*, or *Gaudones*, by the Greeks, which the Italians have corrupted into *Gozzo* of Candia, to distinguish it from another island of the same name (anciently likewise called *Claudeos*) near Malta. It is said to have been the Calypso's isle of mythic fame (Callin. ap. Strabo, p. 299). According to Pococke, it is now inhabited only by some thirty families (*East*, ii, 847; Prokesch, *Denkwürd.* i, 598). This otherwise insignificant islet is of great geographical importance in reference to the removal of some of the difficulties connected with Paul's shipwreck at Melita. The position of *Clauda* is nearly due W. of Cape Matala, on the S. coast of Crete [see FAIR HAVENS], and nearly due S. of Phoenice (q. v.). (See Ptol. iii, 17, 1; *Stadiasm.* p. 496, ed. Gail.) The ship was seized by the gale a little way after passing Cape Matala, when on her way from Fair Havens to Phoenice (Acts xxvii, 12-17). The storm came down from the island (καρ' αὐρῆς, v, 14), and there was danger lest the ship should be driven into the African Syrtis (v, 17). It is added that she was driven to *Clauda*, and ran under the lee of it (v, 16). We see at once that this is in harmony with, and confirmatory of, the arguments derivable from all the other geographical circumstances of the case (as well as from the etymology of the word Euroclydon, or Euro-Aquilo), which lead us to the conclusion that the gale came from the N.E., or, rather, E.N.E. This island is about seven miles long and three broad. Its W. shore, which trends in a N.W. direction, and is prolonged by "some rocks adjacent," would "afford the advantage of comparatively smooth water for some twelve or fifteen miles" (Adm. Penrose's MS. in Conybeare and Howson's *St. Paul*, ii, 827) to a ship "caught," as Paul's was, with "a tempestuous wind" from the N.E. Accordingly, under the lee shore of *Clauda* were taken those skilful precautions of "hoisting in the boat," "undergirding [or frapping] the ship," and making her snug by "lowering the gear;" which kept the ship (q. v.) from foundering under the pressure of a fortnight's "gale in Adria," and preserved her for the rough remedy of a wreck on the island of Melita (Smith, *Voy. and Shipwreck of St. Paul*, 2d ed. p. 92, 98, 106, 253).—Smith, s. v.; Kitto, s. v. See SHIPWRECK.

Claude, JEAN, one of the most eminent of French Protestant divines, was born at La Sauvetat, near Agen, in the south of France, in 1619. He studied theology at Montauban, was ordained in 1645, and began his pastoral labors at La Trègue in the same year. In 1654 he was called to the church at Nîmes, where he also taught in the theological school. In 1661 he was interdicted from his functions by the government, as a penalty for opposing, in the provincial synod, a project of union between Romanists and Protestants proposed by the governor of Languedoc. He went to Paris to have this penalty revoked, and while there was prevailed upon by Madame Turenne (who wished

to save her husband from Romanism) to write against Arnould on the Eucharist, which led to a controversy of great note. Claude's tractate was circulated in MS.; but in 1664 Arnould published his celebrated *Perpétuité de la Foi*, etc. (see ARNAULD), to which Claude replied in 1667 in his *Réponse au Traité de la Perpétuité de la Foi*, etc. (see an account of the controversy in Bayle, translation of 1786, 10 vols., iv, 866). He had previously been appointed minister at Montauban (1662), and also professor of theology. In 1666 he was interdicted again, and in that year he became pastor of the Reformed church at Charenton, near Paris. Here he remained, popular and useful, regarded as the chief literary defender of French Protestantism, until 1685. The eminent Port-Royalists, Arnould and Nicole, found him a capable and worthy opponent. "In 1673 appeared his *Défense de la Réformation, ou Réponse aux Préjugés légitimes de Nicole* (latest ed. Paris, 1844, 8vo). In 1681 Claude had a controversial conference with Bossuet, after which he published *Réponse à la Conférence de Bossuet* (La Haye, 1683, 8vo). The conference, as usual, led to no approximation between the contending parties." In 1685 the revocation of the edict of Nantes by Louis XIV obliged Claude to seek refuge in Holland, where he was well received, on account both of his talents and his personal character, and the prince of Orange granted him a pension. He died Jan. 18, 1687. His *Plaintes des Protestans cruellement opprimés dans le Royaume de France* was published after his death (best ed. by Basnage, Cologne, 1763, 8vo). His style, though simple, was vigorous, being sustained by logical skill and erudition. La Devèze wrote a biography of Claude (Amsterdam, 1687) (*Eng. Cyclopædia*). Several of his works are translated, viz. Townsend, *Claude's Historical Defence of the Reformation, with Life of Claude* (Lond. 1815, 2 vols. 8vo);—*Essay on the Composition of a Sermon* (latest ed. N. Y. 1853, 12mo);—*Account of the Complaints of the Protestants* (London, 1707, 12mo).—Haag, *La France Protestante*, iii, 473; Mosheim, *Ch. Hist.* cent. xvii, sec. ii, pt. 1, ch. i, § 12, note; Bayle, l. c. On Claude's qualities as a preacher, and his homiletical services, see Vinet, *Histoire de la Prédication*, p. 803 sq. (Paris, 1860, 8vo).

Claude of Turin. See CLAUDIUS, CLEMENS.

Clau'dia (Κλαυδία, fem. of *Claudius*), a Christian female mentioned in 2 Tim. iv, 21, as saluting Timotheus, A. D. 64. She is thought to have become the wife of Pudens, who is mentioned in the same verse (although Linus is named between). It has been supposed that this Claudia was a British maiden, daughter of king Cogidunus, an ally of Rome (Tacitus, *Agricol.* 14), who took the name of his imperial patron, Tiberius Claudius. Pudens, we gather from an inscription at Chichester, and now in the gardens at Goodwood, was at one time in close connection with king Cogidunus, and gave an area for a temple of Neptune and Minerva, which was built by that king's authority. Claudia is said in Martial (xi, 53) to have been of British extraction (*cæruleis Britannis edita*). Moreover, she is there also called *Rufina*. Now Pomponia, wife of the late commander in Britain, Aulus Plautius, under whom Claudia's father was received into alliance, belonged to a house of which the Rufi were one of the chief branches. If she herself were a Rufa, and Claudia her protégée, the latter might well be called Rufina; and we know that Pomponia was tried for having embraced a foreign religion (*superstitionis eæternæ reæ*) in the year 57 (Tacitus, *Ann.* xii, 82), so that there are many circumstances concurrent tending to give verisimilitude to the conjecture. On the other hand, it may be said that the attempt to identify this Claudia with the British lady Claudia, whose marriage to Pudens is celebrated by Martial (*Epig.* iv, 13), rests on no foundation beyond the identity of the names of the parties, and the fact that Martial calls Pudens

"sanctus," and says he was a corrector of his verse. But the identity of names so common as Pudens and Claudia may be nothing more than a mere accidental coincidence; as for the term "sanctus," it is precisely one which a heathen would not have applied to a Christian, whom he would have regarded as the adherent of a "prava superstitio" (Pliny, *Ep. ad Traj.*); and as respects Pudens's correction of Martial's verses, until we know whether that was a correction of their style or a correction of their moral (in which case Pudens really must have done his wit very badly), we can build nothing on it. On the other hand, the immoral character of Martial himself renders it improbable that he should have had a Christian and a friend of Paul among his friends. Further, Paul's Pudens and Claudia, if husband and wife, must have been married before A. D. 67, the latest date that can be assigned to Paul's writing. But Martial's epigram must have been written after this, perhaps several years after, for he came to Rome only in A. D. 66; so that, if they were married persons in 67, it is unlikely Martial would celebrate their nuptials years after this. In fine, if Paul's Pudens and Claudia were unmarried at the time of his writing, they must at least have been persons of standing and reputation among the Christians; and, in this case, can it be supposed that a poet meaning to gratify them would invoke on them the favor of heathen deities, whom they had renounced with abhorrence? See Archdeacon Williams's pamphlet, *On Pudens and Claudia* (Lond. 1848); an article in the *Quart. Rev.* for July, 1858, entitled "The Romans at Colchester;" and an Excursus in Alford's *Greek Testament* (vol. iii, prolegg. p. 104) in which the contents of the two works first mentioned are embodied in a summary form. See also Corbœare and Howson's *St. Paul*, ii, 484, s. v.; Kitto, s. v.

Claudîanus Mamertus, a presbyter of Vienne, 5th century (died about 470), was a man of speculative talent, and well acquainted with the theology of Augustine. He wrote a treatise, *De statu Animæ* (*Bib. Max. Patr.* vi; *Bib. Patr. Galland.* x) against the anthropomorphism of Faustus of Rhegium (q. v.). He shows that "thought is inseparable from the essence of the soul, and that its spiritual activity is indestructible" (Neander, *History of Dogmas*, ed. Ryland, i, 340). For an analysis of the tract, see Dupin, *Eccles. Writers*, ii, 150 (Lond. 1698), and Clarke, *Succession of Sacred Literature*, ii, 249. Certain Latin hymns are attributed to Claudius, viz., *Contra Poetas vanos* (in the *De Statu* above), and *Pange lingua gloriosi*, which last, however, is more properly ascribed to Venantius Fortunatus. Sidonius Apollinaris, to whom the *De Anima* is dedicated, gives a glowing panegyric upon the talents of Claudianus.—Dupin, l. c.

Clau'dius (Κλαυδιος, for Lat. *Claudius*, perh. from *claudus*, lame), the name of two Romans mentioned in the N. T. See also FELIX.

1. The fourth Roman emperor (excluding J. Cæsar) who succeeded Caligula Jan. 25, A. D. 41. His full name was TIBERIUS CLAUDIUS DRUSUS NERO CÆSAR AUGUSTUS GERMANICUS. He was the son of Drusus and Antonia, and was born Aug. 1, B. C. 10, at Lyons, in Gaul. Losing his father in infancy, he was abandoned to the care and society of domestics, and despised by his imperial relatives (Tacitus, *Ann.* vi, 44, 1; Suetonius, *Claud.* 2). Notwithstanding the weakness of intellect resulting from this neglect, he devoted himself to literary pursuits, and was the author of several treatises. On the murder of Caligula, he hid himself through fear of sharing his relative's fate, but was found by a soldier, at whose feet he fell a suppliant, but who saluted him emperor; and he was thus unexpectedly, and almost by force, hurried into the popular assembly, and constituted emperor chiefly by the Prætorian Guards, under promise of a largest to

ch soldier (Suetonius, *Claud.* 10). According to Josephus (*Ant.* xix, 2, 1, 8 and 4), the throne was in a great measure finally secured to him through the address and solicitations of Herod Agrippa I (q. v.). His obligation he returned by great and peculiar favors to that personage, for he enlarged the territory of Agrippa by adding to it Judæa, Samaria, and some districts of Lebanon, and appointed his brother Herod the kingdom of Chalcis (Josephus, *Ant.* xix, 5, 6; Dion Cassius, lx, 8), giving to this latter also, after his brother's death, the presidency over the Temple at Jerusalem (Josephus, *Ant.* xx, 1, 88). Indeed, the Jews were generally treated by him with indulgence, especially those in Asia and Egypt (*Ant.* xix, 5, 2, 3; cx, 1, 2), although those in Palestine seem to have at times suffered much oppression at the hands of his governors (Tacitus, *Hist.* v, 9, etc.); but about the middle of his reign those who abode at Rome were all banished thence (Acts xviii, 2; see Hebenstreit, *De Judæo Roma exule*, Lips. 1714). From the language of Suetonius in relating this event (*Claud.* 25), it is evident that the Christians were also indiscriminately included in the execution of the edict as a sect of the Jews, if, indeed, they were not the more numerous part of that portion of the inhabitants: "Judæos, impulsore Chresto [i. e. *Christo*, see Rossal, *De Christo, in Christum commutato*, Grön. 1717] assidue tumultuantes, Româ expulit" ("He banished the Jews from Rome on account of the continual disturbances which they made at the instigation of one Chrestus"). See **CHRESTUS**. The historian has evidently, in his ignorance of the merits of the case, attributed the proverbial insurrectionary spirit of the Jews to the influence of Christianity, a confusion which the disputes between the Jews and Christians on the subject of the Messiah may have contributed to increase. Suetonius does not give the exact year of this event, nor can it be made out from any other classical authority; he mentions it, however, in connection with other events which are known to have taken place at different dates between A.D. 44 and 53: a comparison of the associated events in the Acts appears to fix it in the year A.D. 49. Orosius (*Hist.* vii, 6) fixes it in the ninth year of Claudius, A.D. 49 or 50, referring to Josephus, who, however, says nothing about it. Pearson (*Annal. Paul.* p. 22) thinks the twelfth year more probable (A.D. 52 or 53). Anger remarks (*De ratione temporum in Actis App.* p. 117) that the edict of expulsion would hardly be published as long as Herod Agrippa was at Rome, i. e. before the year 49. The Jews, however, soon returned to Rome. Several famines occurred under Claudius from unfavorable harvests (Dion Cass. lx, 11; Euseb. *Chron. Armen.* i, 269, 271; Tacit. *Ann.* xii, 48), one of which, in the fourth year of his reign, under the procurators Cuspius Fadus and Tiberius Alexander (Joseph. *Ant.* xx, 2, 6; 5, 2), extended to Palestine and Syria, and appears to be that which was foretold by Agabus (Acts xi, 28; see Biscoe, *On Acts*, p. 60, 66; Lardner, *Credibility*, i, 11; Kitto, *Daily Bible Illustr.*, last vol., p. 229-232; compare Kuinöl, in loc.; also Krebs, *Obs. in N. T.* p. 210). The conduct of Clau-

enactments (see Merivale, *Romans under the Empire*, v, 474 sq.). He also erected numerous public buildings, and carried out several important public works. Having married his niece Agrippina, she prevailed upon him to set aside his own son Britannicus in favor of her own son Nero by a former marriage; but, discovering that he regretted this step, she poisoned him on the 18th of October, A.D. 54. (See Smith's *Dictionary of Classical Biography*, s. v.) During the reign of Claudius several persecutions of Christians by Jews took place in the dominions of Herod Agrippa, and in one of them the apostle James was executed. These dominions embraced by far the largest number of Christian congregations which were established up to the time of his death (A.D. 44). After his death, most of the territory over which he had ruled was reincorporated with the Roman empire, his son, Agrippa II, receiving only Trachonitis and Gaulonitis. Thus the Christian congregations began to attract to a larger degree the attention of the Roman authorities. At the same time, the apostle Paul began to establish congregations in many of the larger cities of the empire, while those of earlier origin assumed much larger dimensions. Nevertheless, the difference between Jews and Christians was not generally understood by the Roman authorities, and this circumstance had some beneficial, but also some injurious consequences as regarded the Christians. On the one hand, the missionary activity of the apostles and their helpers met with no opposition on the part of the Roman state (see Kraft, *Prolog. II de nascendi Christi ecclesia secta Judaica nomine tuta* [Erlang. 1771], and J. H. Ph. Seidenstücher, *Diss. de Christianis ad Trajanum usque a Caesaribus et Senatu Romano pro cultoribus religionis Mosaicae semper habitis* [Helmstädt, 1790]); on the other hand, many who might have been willing to join the Christian Church were deterred from doing so by the fear that the yoke of all the Jewish law would be placed upon them. (See Wetzler und Welte, *Kirchen-Lexikon*, s. v.)

2. **CLAUDIUS LYSIAS** (Acts xxiii, 26). See **LYSIAS**.

Claudius, Clemens, bishop of Turin, sometimes called the "first Protestant Reformer," was born in Spain about the close of the eighth century, and educated under Felix of Urgel, whom he accompanied to France, Germany, and Italy, but whose errors there is no evidence that he adopted (Neander, *Church History*, iii, 480, Torrey's). Called to the court of Louis le Débonnaire to expound the Scriptures, he was sent by that monarch, when emperor, to the see of Turin (an event variously dated from 814 to 828) in order to oppose the prevailing tendency to image-worship. Not only against this form of idolatry, but against the worship of saints, of relics, and of the cross, against the abuse of pilgrimage, against the rising claims of tradition, prelacy, and the Romish see, he maintained a vigorous and able opposition till his death in 840, with such success and such results as usually attend those whose errors fall on the side of boldness rather than of timidity. Pope Paschal I reproved Claudius; he replied that so long as "the pope did the works of an apostle, he recognised his apostolical character, but otherwise, then Matt. xxiii, 2, 3, applied to him." His writings are chiefly commentaries on several books of Scripture, composed principally of extracts from the fathers, and especially from Augustine. Many remain in MS. in various French libraries. His *Comm. in Galatas*, and excerpts from his *Apologeticum*, are given in Bibl. Max. Patr. xiv. See Neander, *Ch. Hist.* iii, 429 sq.; Gieseler, *Ch. Hist.* per. iii, div. i, § 12; Hagenbach, *Hist. of Doctrines*, ii, 422; Murdoch's Mosheim, *Ch. Hist.* i, 218, 225; Rudelbach, *Claud. Taur. Episcop. inedit. opp. specimina* (Copenhagen, 1824, 8vo); Schmidt, in *Zeitschrift für die hist. Theol.* 1848.

Claudius, Matthias, better known under the

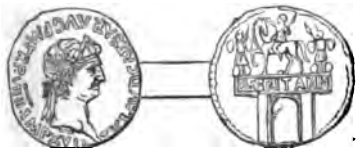

Coin of Claudius.

Obverse: TI. CLAVD. CAESAR. AVG. P. M. TRP. VIII. IMP. XVI (Tiberius Claudius Caesar Augustus Pontifex Maximus, Tribunicia Potestate VIII. Imperator XVI.); head, laureate, right. *Reverse:* Triumphal arch, on which equestrian figure and two trophies, inscribed DE BRITANN (De Britannia).

dus during his government, in so far as it was not under the influence of his wives and freedmen, was mild and popular, and he made several beneficial

nom de plume of *Assmus*, or *Der Wandbecker Bote* (the Wandbeck Messenger), a German writer, was born at Rheinfeld, in Holstein, Jan. 2, 1740. He studied law at Jena, and, after having held for a short time an office at Darmstadt, became, in 1778, "revisor" at the Schleswig-Holstein Bank in Altona. He resided at the village of Wandbeck, near Altona (hence his *nom de plume*), where he spent the greater part of his life. He died on the 21st of January, 1815, at Hamburg, in the house of his son-in-law, the publisher, Frederick Perthes. Claudius is still regarded as one of the most gifted popular writers of Germany, and his books had a very large circulation during his lifetime. He was on terms of intimacy with Voss, Herder, Jacobi, Hamann, Lavater, Stollberg, and many other prominent literary men of his times. In the Church history of Germany he bears an honorable name as one of the most effective opponents of the vulgar rationalism which at that time threatened to obtain absolute sway over the whole of Protestant Germany. In his earlier writings, he, on the whole, confined himself to ridiculing the arrogance and intolerance of the Rationalists; but he steadily grew warmer and more emphatic in his opposition to rationalism, and in his attachment to a strict Lutheranism, and on that account fell out with some of his former friends, as Voss and Jacobi. Claudius began in 1765 a complete edition of his works, under the title *Assmus omnia sua secum portans*, 8 vols., to which some addition was made in 1812 (latest edition, 1844). A biography of Claudius has been written by Herbst (Gotha, 1867).—*Herzog, Real-Encyclop.* ii, 712; *Brockhaus, Conversations-Lexikon*, iv, 647.

CLAUDIUS OF SAVOY, a Unitarian of the sixteenth century, who, in a disputation at Berne, 1684, maintained that Christ was a man, who "was called God inasmuch as he had received the fullness of the divine Spirit beyond all other beings. The Father dwelt in him through the divine Spirit, and all through him might be animated by the Father" (Neander, *History of Dogmas*, Ryland's transl., ii, 647). He was expelled from Berne, imprisoned at Strasburgh, returned to Switzerland, and recanted at Lausanne, 1587. See Schelhorn, *De Mino Celso et Claudio Allobroge* (Ulm, 1748, 8vo); Mosheim, *Ch. Hist.* iii, 228; Trechsel, *die protest. Antitrinitarier*, i, 55.

CLAUSTRUM. See CLOISTER.

CLAUSTRA (Lat.), the enclosure of a monastic establishment, usually square, and surrounded by a wall. Ordinarily monks or nuns are not allowed to go beyond this space, or to receive a visit within it, without the especial permission of the head of the establishment.

Claw (פֶּרָסָה, *parsah'*, *clef*, i. e. cloven foot), prop. a hoof (as usually rendered) of a bifurcated animal (Exod. x, 26; Mic. iv, 13; Ezek. xxxii, 11), or of a solid-footed quadruped (e. g. a horse, Isa. v, 28; Jer. xlvii, 8); hence for the distinctive mark of a clean (q. v.) creature ("claw;" Deut. xiv, 16), or the sharp weapons of a beast of prey ("claw;" Zech. xi, 16), or the talons of a predatory bird ("claw;" Dan. iv, 33). In one passage (Psa. x, 10) the powerful, clawed paw of a lion (q. v.) is poetically denoted by the term פְּרָסָה, "strong ones."

Clay is the rendering of several words, more or less accurately, in certain passages in the English Bible: טֵיט, *tit*, prop. *mud* (Psa. xl, 2), i. e. mire (as often rendered), hence potter's *clay*, as being trodden fine (Isa. xli, 25; Nah. iii, 14); corresponding to the Gr. πηλός (John ix, 6, 11, 14, 15; Rom. ix, 21; Wisd. vii, 9; xv, 7, 8; Ecclus. xxxiii, 18; xxxviii, 30; Bel 7), as soiling or plastic; and חֹמֶר, *cho'mer*, reddish loam (Job iv, 19; xiii, 12; xxvii, 16; xxxiii, 67), e. g. potter's clay (Isa. xxix, 16; xlv, 9; Jer. xviii, 4, 6), as used for sealing (Job xxxviii, 14), or for cement of

building ("mortar," Gen. xi, 3), so for making brick (Exod. i, 14; "mortar," Isa. xli, 25; Nah. iii, 14); also common street "mire" (Isa. x, 6; Job xxx, 18; "clay," Job x, 9). Other terms so rendered less correctly are: מִלְּטָה, *me'let*, mortar for plastering (Jer. xliii, 9); and the Chald. חֲסָפִי, *chashaph'*, sherd, of burnt clay-ware (Dan. ii, 23). The word טֵיט, *tit* ("clay," 2 Chron. iv, 17), or חֲבֵבֶת, *maabek'* ("clay," 1 Kings vii, 47), denotes *darkness* or *density* of soil, i. e. perh. depth of earth; and the merely apparent compound חֲבֵבֶת אֲבִיט', *abiti'* ("thick clay"), in Hab. ii, 6, signifies rather a *pledging* of goods to an extortioner. See MINERALOGY.

"Clay is a sedimentary earth, tough and plastic, arising from the disintegration of felspar and similar minerals, and always containing silica and alumina combined in variable proportions. As the sediment of water remaining in pits or in streets, the word is used frequently in the O. T. (e. g. Isa. lvii, 20; Jer. xxxviii, 6; Psa. xviii, 42), and in the N. T. (John ix, 6), a mixture of sand or dust with spittle. It is also found in the sense of potter's clay (Isa. xli, 25), the elegant and useful forms assumed by the rude material under his hands supplying a significant emblem of the Divine power over the destinies of man (Isa. lxiv, 8; Jer. xviii, 1-6; Rom. ix, 21). The alluvial soils of Palestine would no doubt supply material for pottery, a manufacture which we know was, as it still is, carried on in the country (Jer. xviii, 2, 6); but our knowledge on the subject is so small as to afford little or no means of determining, and the clay of Palestine, like that of Egypt, is probably more loam than clay (Birch, *Hist. of Pottery*, i, 55, 152). See POTTERY. Bituminous shale, convertible into clay, is said to exist largely at the source of the Jordan, and near the Dead Sea, also near Bethshan (Burckhardt, ii, 53; Russegger, iii, 278, 258, 254). The great seat of the pottery of the present day in Palestine is Gaza, where are made the vessels in dark blue clay so frequently met with. The Talmud (*Aboda Sara*, ii, 3) mentions a peculiar kind of luteous material called 'Hadrian's clay' (חֶרֶס הַדְרִיָּיִן). The use of clay in brick-making was also common. See BRICK. Another use of clay was in sealing (Job xxxviii, 14). The bricks of Assyria and Egypt are most commonly found stamped either with a die or with marks made by the fingers of the maker. Wine-jars in Egypt were sometimes sealed with clay; mummy-pits were sealed with the same substance, and remains of clay are still found adhering to the stone door-jambs. Our Lord's tomb may have been thus sealed (Matt. xxvii, 66), as also the earthen vessel containing the evidences of Jeremiah's purchase (Jer. xxxii, 14). So also in Assyria, at Kouyunjik, pieces of fine clay have been found bearing impressions of seals with Assyrian, Egyptian, and Phœnician devices. The seal used for public documents was rolled on the moist clay, and the tablet was then placed in the fire and baked. The practice of sealing doors with clay to facilitate detection in case of malpractice is still common in the East (Wilkinson, *Anc. Egypt.* i, 15, 48; ii, 364; Layard, *Nis. and Bab.* p. 153, 158, 608; *Herod.* ii, 38; Harmer, *Obs.* iv, 376)" (Smith, s. v.). Norden and Pococke observe that the inspectors of the granaries in Egypt, after closing the door, put their seal upon a handful of clay, with which they cover the lock. See SEAL. Clay was also used, no doubt, in primitive times for mortar, for the same term is employed for both (Gen. xi, 3). Houses are built of clay mixed with sand in countries where stones are not to be found. See MORTAR. In Job iv, 19, it is said of mankind that they dwell in huts of clay, either alluding to such dwellings, or to the "clay tenements" of the body (compare 2 Cor. v, 1). Our Saviour anointed the eyes of the blind man with a salve made of clay and spittle (John ix, 6), a simple

sparation, which, it would be manifest to all, could ve in itself no curative virtue. The "clay ground" terally *thickness of soil*) in which Solomon caused e large vessels of the Temple to be cast (1 Kings vii, ; 2 Chron. iv, 17) was a compact loam, of a quality rather extent (depth some 28 feet; see JACHIN) not be found elsewhere in Palestine, which is generally cky or sandy. See METALLURGY.

CLAYTON, ROBERT, born in Dublin in 1695, was a sciple of Dr. S. Clarke, became bishop of Killala, of rk, and finally of Clogher, and published several orks, none of which have gained lasting celebrity it his *Essay on Spirit* (1751), a treatise maintaining rian views, of which, though not actually his com- sition, he bore the expense and assumed the responsi- lity. A powerful reply from Jones of Nayland did t hinder his proposing in the Irish House of Lords d Feb. 1766) the omission of the Nicene and Athana- an Creeds from the liturgy of the Church of Ireland; d at last, the third part of his *Vindication of the His- ries of the Old and New Testament* gave occasion to gal proceedings, arrested only by his death on Feb. 8th, 1768. Among his other publications are *The Aronology of the Hebrew Bible Vindicated* (Lond. 1747, to); *A Dissertation on Prophecy* (Lond. 1749, 8vo).—ippis, *Biographia Britannica*, iii, 620.

Clean (טָהוֹרִים, *tahor*'s, καθαρός) and UNCLEAN טָמֵא, *tamé*'s, ἀκάθαρτος). These words are of frequent currence and obvious meaning in the sacred writ- gs; but it is in their peculiar application, by the Mo- ic law, to persons, animals, and things, that they are ow to be considered. In order to partake of the priv- leges of the Jewish Church, and to engage acceptably n its outward worship, the individual must not only e circumcised, but he must be ceremonially pure or lean; that is, he must be free from uncleanness. How the various kinds of uncleanness were contract- d, what time it continued, and what was the process f purification, we find particularly described in Lev. ti-xv; Num. xix. See PURIFICATION.

The division of animals into clean and unclean ex- sted before the Flood (Gen. vii, 2), and was probably ounded upon the practice of animal sacrifice. The regulations concerning clean and unclean animals are chiefly recorded in Leviticus, ch. xi, and Deuteronomy, ch. xvi, where the following animals are pronounced unclean, and are consequently interdicted to be used as food: (1.) Quadrupeds which do not ruminates, or which have uncloven feet. (2.) Serpents and creeping nsects; also certain insects which sometimes fly and sometimes advance upon their feet; but locusts, in all their four stages of existence, are accounted clean. (3.) Certain species of birds; but no particular characters are given for dividing them into classes, as "clean" or "unclean." Judging from those that are specified, as far as the obscure character of the Hebrew names will admit, it will be found that birds of prey gener- ally are rejected, whether they prey on lesser fowls, or on animals, or on fish; while those which eat vegeta- bles are admitted as lawful; so that the same princi- ple is observed, in a certain degree, as in distinguishing quadrupeds. (4.) Fish without scales, and also those without fins. (5.) Animals of any kind which had either died of disease, or had been torn by wild beasts (Exod. xxii, 31). See ANIMAL.

The animal substances interdicted to the Hebrews were: (1.) Blood (Levit. xvii, 10; xix, 26; Deut. xii, 16, 23; xv, 23). (2.) The fat covering of the intes- tines, termed the net or caul. (3.) The fat upon the intestines, called the mesentery, etc. (4.) The fat of the kidney. (5.) The fat tail or rump of certain sheep (Exod. xxix, 13, 22; Levit. iii, 4-9; ix, 19). See Food.

What was the design of these distinctions, and how they were abolished, may be learned with sufficient ac- curacy from a comparison of various passages of Scrip-

ture (Lev. xx, 24-26; Acts x, 9-16; xi, 1-28; Heb. ix, 9-14). See DECREE (of the Apostles). It has been observed that one object of these appointments may have been to make the Jews suspicious of Gentile customs and entertainments, and so induce them to abstain from all intercourse with them. We find in the New Testament that *eating* with Gentiles was regarded as a peculiar aggravation of the offence of associating with them (Matt. ix, 11; Acts xi, 3). It may be remarked, also, that the flesh of many of the animals interdicted was unwholesome, and others were objects of idolatrous worship among the heathen. The chief design of the regulation, however, appears to have been, to establish a system of regimen which should distinguish the chosen people from all other nations. See the treatises *De animalibus esu interdictis*, by Danz (Jen. 1687) and Münster (in *Menthenii The- sis*, ii, 477 sq.); also Neumann, *Ueb. d. Kasten Noah* (Witteimb. 1741). See UNCLEANNESS.

Cleanse. See PURIFICATION.

Clear-story (or CLEER-STORY), the upper part of the central aisle of a church, raised above the roofs of the adjoining side aisles, with windows to light the nave below. In many cases the clear-story is evidently a subsequent addition to the original design, especially when the high-pitched roof, which included the body and aisles in its span, gave way to a flat roof covering the nave only. The walls were then raised over the arches of the nave to receive the clear-story windows.—Parker, *Concise Gloss. of Architecture*, s. v.

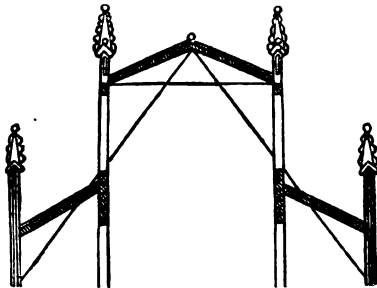

Clear-story. (Parker's Glossary.)

Cleaveland, JOHN, a Congregational minister, was born in Canterbury, Conn., April 11, 1722. He was expelled from Yale College for attending a Separatists' meeting, but his degree was afterwards given to him, and his name appears as a graduate of 1745. He was installed pastor over a newly-organized church in Chebacco, Feb. 25, 1747; acted as chaplain at Ticonderoga in 1758; served in the same capacity at Cambridge in 1782, and in New York in 1776. He died April 22, 1799. His church at Chebacco was formed by a secession from Mr. Pickering's, who refused to allow Whitefield to preach in his pulpit. Mr. Pickering issued a pamphlet soon after Mr. Cleaveland's organization, to which he replied in *A plain Narrative of the new Church*. He also published *Chebacco Narrative rescued from the Charge of Falsehood and Partiality* (1748); an *Essay to defend some of the most important Principles in the Protestant Reformed System of Christianity, more especially Christ's Sacrifice and Atonement, against the injurious Aspersions cast on the same by Dr. Mayhew, in a Thanksgiving Sermon* (1763), which elicited from Mayhew a sharp rejoinder in *A Letter of Reproof to John Cleaveland; Justification of his Church from the Strictures of the Rev. S. Wigglesworth, of the Hamlet, and the Rev. Richard Jaques, of Gloucester* (1765); with several other controversial pamphlets and a few sermons.—Sprague, *Annals*, i, 458; Allen, *Am. Biog. Dictionary*, s. v.

Cleft (צֵדִים, *beti'a*, a gap in a building, Amos vi, 11; "breach," Isa. xxii, 9; שֵׁשֶׁת, *she'sa*, a split in the hoof of an animal, Deut. xiv, 6; also נִקְרָח, *neka-*

rah', a fissure in a rock, Isa. ii, 21; חַגְוִימ', *chagovim'*, refuges in the crags, Cant. ii, 14; Jer. xlix, 16; Oba. 8), or CLIFT (קַרְרָה, *nekarah'*, crevices in a rock, Exod. xxxiii, 22; סִפְסִף, *seiph'*, a rock fissure, Isa. lvii, 5; "top" of the rock, Judg. xv, 8, 11; Isa. ii, 21). See CAVE; ROCK.

Cleland, THOMAS, D.D., an eminent Presbyterian divine, was born in Fairfax County, Va., May 22, 1778, and removed to Marion County, Ky., in 1789. Having developed extraordinary gifts as an exhorter in the great revival of 1801, he was urged by the Presbytery of Transylvania to become a preacher, and was licensed April 14, 1803. His first charge was Union Church, in Washington County. In 1818 he was settled over New Providence and Cane Run (now Harrodsburg) churches, where he labored during the rest of his life with remarkable success, being blessed with numerous revivals. He was one of the most popular and useful preachers in Kentucky. Sixteen young men studied divinity under him. He was appointed one of the synodical commission in the Cumberland Presbyterian difficulties. Dr. Cleland was with a diligent student, and wielded his pen with signal ability against the Newlights and Campbellites. His principal printed works, besides *Occasional Sermons*, were, *A brief History of the Action of the Synod in the Case of the Cumberland Presbyterians* (1823, p. 29, 8vo):—*The Socini-Arian Detected* (1815, p. 101, 12mo):—*Unitarianism Unmasked* (1825, p. 184, 12mo):—*Narrative of the Bodily Exercises, in Bibl. Repertory* for July, 1834:—*Letters on Campbellism*:—*A Hymn-book*, for prayer-meetings and revivals, extensively used in the West. Dr. Cleland died Jan. 31, 1858, in the eightieth year of his age.—Davidson's *Hist. Presb. Ch. in Kentucky*, p. 854; *Memoirs, compiled from private Papers*, by Prof. Humphrey and Rev. Thos. H. Cleland.

Clemanges (*Clamengis* or *Clemangis*), NICOLAS DE, one of the ablest writers of the Roman Catholic Church during the Middle Ages. He was born about 1360 in the village of Clémanges, in the province of Champagne, and educated in the College of Navarre at Paris. As early as 1381 he gave public lectures as *Magister Artium*. In 1386 he began, in the same institution, to study theology under Pierre d'Ailly, who exercised a great influence upon him, and always remained his friend. In 1391 he became bachelor of theology, and began to give theological lectures. Being possessed of rare talents, and thoroughly familiar with the works of the ancient writers, he was soon regarded as the most eloquent member of the University of Paris, which in 1398 elected him rector. Henceforth Clémanges took the most active part in the efforts of the University in behalf of a thorough reformation, which constitute so important a part of mediæval Church history. Most of the letters addressed by the University to the popes and kings of this time emanated from his pen. In the same year in which he was elected rector (1398) he addressed, in the name of the University, an energetic memoir to Charles VI of France, in order to induce him to put an end to the schism in the Church. In 1394 he compiled a second memorial on the basis of the opinions of all the prominent members of the French clergy, which had been solicited by the Sorbonne. In accordance with these opinions, he proposed, in a letter to Clement VII, three measures for the reorganization of the Church: first, the abdication of both the popes; secondly, the election of arbiters; thirdly, the convocation of a general council. Another letter to the pope, much more severe in its language, was not sent off because Clement VII died (September, 1394). Charles VI, following the advice of the University, requested the cardinals of Avignon not to proceed to the election of a new pope until they had come to an understanding with the cardinals of Rome, and with Boniface IX;

and Clémanges sent a letter of the same character to Avignon. But the cardinals of Avignon nevertheless hastened to elect Petrus de Luna, who assumed the name Benedict XIII. After being elected, Benedict secured recognition by Charles VI and the Paris University, but Clémanges was instructed to request him to do all that might be in his power to end the schism. To the same end he had to write to the king of Aragon. In his own name Clémanges sent to Benedict an eloquent epistle on the duties of the head of the Church, and recommended to him his friend Pierre d'Ailly as chief adviser. Benedict appreciated the learning of Clémanges, and prevailed upon him to accept the office of secret secretary of the pope. As the king of France and the Sorbonne, supported, in 1356, by the resolution of a national council, declared in favor of an abdication of both the popes, Clémanges, who was now a decided champion of the claims of Benedict, fell out with many of his former friends. In 1407 the French government withdrew its recognition of Benedict, whereupon the latter laid the law upon king and country. Clémanges was charged with being the author of the bull of excommunication, but denied the charge, left his position at the papal court, and withdrew to Langres, where he had been appointed canon a short time before. His opponents persisted in calling him the author of the bull of excommunication; he was accused of high treason, and threatened with imprisonment. In order to escape this danger, he concealed himself in a Carthusian convent at Valprofonds, and subsequently in a convent of the same order at Fontaine-du-Bosc. In this retirement he devoted his attention to the Bible, which, as he states, had until then been neglected by him, and which now became his favorite study. Besides a number of letters to his friends D'Ailly, Gerson, and others, he wrote at Fontaine-du-Bosc several works full of reformatory ideas as regarded both the prevailing corruptions of his Church and some of the doctrines. The most important of these are *De fructu cremiti* (on the value of retired life); *De fructu rerum adversarum* (on the spiritual profit to be derived from adversity); *De novis festivitatis non institutis* (complainings of the excessive number of holidays, which promote dissipation instead of edification, and cause the Bible to be forgotten over the stories of saints). In all these works Clémanges recommended the Bible as the purest and richest source of Christian knowledge and Christian life. The decay of the Church is attributed to the neglect of the Bible; the council, in his opinion, could claim regard for their decisions only if the members were really believers, and if they were more concerned for the salvation of souls than for secular interests. His views on general councils were fully set forth in a little work, entitled *Disputatio de concilio generali*, which consists of three letters, addressed, in 1415 or 1416, to a professor at the Paris University (printed apparently at Vienna in 1482). He not only places the authority of general councils over the authority of the popes, but the authority of the Bible over the authority of the councils. He doubts whether at all the former œcumenical councils the Holy Spirit really presided, as the Holy Spirit would not assist men pursuing secular aims. He denies that a council composed of such men represents the Church, and asserts that God alone knows who are his people and where the Holy Ghost dwells, and that there may be times when the Church can only be found in one single woman (*in sola potest muliercula per gratiam manere ecclesiam*). Other works, in which he expressed himself even more freely, have been lost, and perhaps suppressed. Chiefly against the immoral life of the higher clergy he wrote, about 1411, his treatise *De presulibus Simoniacis*. He also urgently recommended to the secular authorities of his country the teaching of the Bible as the only safe remedy against the continual civil wars and disturb-

see, and he counseled duke Philip of Burgundy to revoke the General Estates for the restoration of law and justice. He also wrote, while at Fontaine-du-roc, several poetical pieces, which are distinguished by the brilliancy of their Latinity.

Of the latter years of his life but little is known. He canonry at Langres he exchanged for one at Baucourt. Other ecclesiastical dignities which were offered to him he refused, as his conscience did not allow him to accept more benefices than one. In 1421 he defended at Chartres the liberties of the Gallican Church. In 1425 he again began to give theological lectures in the college at Navarre, and his connection with this school continued until his death. The year of his death is not known. Even his epitaph (which was destroyed in 1798) did not state it.

A work entitled *De ruina Ecclesie, or De corrupta Ecclesie statu*, which, since Trithemius (*Catal. Script. Eccles.*), is usually classed among the writings of Clément, cannot be from him. Its language is more violent than Clément's ever indulged in. It abounds in attacks upon Benedict XIII at a time when Clément was his secretary and eloquent champion. It was undoubtedly the work of some member of the Paris University. Equally certain is the spuriousness of the work *Apostoli* (i. e. *littera dimissoria*) et *responsio per nationem gallicanam dominis cardinalibus*, etc., which was written at Constance during the session of the council. Most of his works were published by Lydinus (Leyden, 1618, 2 vols. 4to), but some of them still lie as unedited MSS. in libraries. See Herzog, *Real-Encyclop.* ii, 717 sq.; Wetzer u. Welte, *Kirchen-Lexikon*, ii, 574 sq.; Neander, *Ch. Hist.* v, 58 sq.; Mosheim, *Ch. Hist.* i, 422, and a monograph of Müntz, *Nicolas Clément, sa vie et ses écrits* (Strasb. 1846, 8vo); Gieseler, *Ch. Hist.* per. iii, div. iv, § 118; Hase, *Ch. History*, p. 825, 844; *Presbyterian Quart. Review*, March, 1857.

CLEMENS, TITUS FLAVIUS, surnamed ALEXANDRINUS, was a native of either Athens or Alexandria, and flourished in the reigns of Severus and Caracalla (the date of his birth being placed about A.D. 160, and that of his death from A.D. 215 to 220). He was in early life an ardent student of literature and philosophy, especially of the Stoic and Platonic schools, and was led by his studies to Christianity. To master its history and doctrines he visited different countries, and received instruction from various masters, of whom he himself speaks thus: "Those vigorous and animated discourses which I was privileged to hear, and of blessed and truly remarkable men. Of these, the one in Greece, an Ionic; the other in Magna Græcia; the first of them from Cœle-Syria, the second from Egypt, and others in the East. The one was born in the land of Assyria, and the other a Hebrew in Palestine. When I came upon the last (he was the first in power), having tracked him out concealed in Egypt, I found rest. He, the true, the Sicilian bee, gathering the spoil of the flowers of the prophetic and apostolic meadow, engendered in the souls of his hearers a deathless element of knowledge" (*Strom.* lib. i, ch. i, p. 855, vol. i, of translation in "Anti-Nicene Christian Library").

This last teacher was (according to Eusebius) Pantæus, head of the catechetical school at Alexandria, by whose influence some suppose Clemens, as yet only a sincere inquirer, was led fully to embrace the Christian faith. He is called a presbyter by early Christian writers, having probably been appointed to that office by the Church at Alexandria, and about 190 became, according to some the assistant, according to others the successor to Pantæus, when the latter set out on his missionary tour to the East. He continued in that office until the persecution under Severus, A.D. 202, compelled him to leave Alexandria. The writers of the articles in Smith's *Dict. of Greek and Rom. Biog. and Mythol.* and the *New Amer. Cyclopædia* state that

Clemens returned to Alexandria before A.D. 211, and then became the master of the school as successor of Pantæus; but the weight of authority favors the earlier date, and his return to that place is doubtful. We know scarcely anything of the closing years of his life. He appears to have been about 210 or 211 in Jerusalem, for he is mentioned by Eusebius (lib. vii, ch. ii) as the bearer of a letter from Alexander, bishop of Jerusalem, then himself a prisoner for the Gospel's sake, to the Church at Antioch. This Alexander and the more famous Origen are reckoned among his pupils.

Of the early Christian writers, Clemens was the most learned in the history, philosophy, and science of the nations of his day, and the influence of his studies is apparent in his writings, which display rather the speculative philosopher than the accurate theologian—more the fanciful interpreter than the careful expounder of the Scriptures on true exegetical principles. Many of his works have been lost, but those extant are the largest belonging to that early period, and very valuable for the light they throw on the social condition of the Roman Empire in his day, and for the information which they contain in regard to the systems of ancient philosophy, the heresies and schisms in the primitive Church, as well as for the numerous extracts from non-extant authors. His three chief writings form a series, and were written apparently with a common object, viz. to convert the heathen and educate them in the principles and practice of the Christian life. They are, 1. *Λόγος προτροπικός πρὸς Ἕλληνας*, *Cohortatio ad Hellenes* (Appeal to the Greeks), an apologetic work, in which the absurdity, obsecrancy, cruelty, impostures, and sordidness of heathen worship are clearly set forth in contrast with the simplicity and purity of Christian faith and practice. 2. *Παιδαγωγός*, *Pædagogus* (Instructor), a treatise on Christian education, in three books, addressed to those who had been converted from heathenism. In Book I we have set forth the function, the means, methods, and ends of the "Instructor," who is Christ, leading the believers "through paths of virtue and truth" to salvation, not through fear as he did the Israelites, but by love, the guiding principle of the new and better covenant. Book II contains rules for the regulation of life, embracing minute details as to food, drink, behavior, etc., recommending temperance, purity, modesty, and frugality. Book III begins with an examination of the grounds of true beauty, showing it to be intellectual, and founded on reason and love; then, in considering the various modes in which men have sought to add to beauty, strongly reprobates luxurious dress and living, etc. Its satire of the follies and vices of the times is caustic and humorous. 3. *Ἐρωματικὴ ἢ Στρώματα*, in eight books, of which the eighth is lost (the imperfect treatise on logic, standing at present as such, belonging to some other work). The word *stromateia*, meaning patch-work (*opus varis contextum*), is significant of the miscellaneous character of the work, which is discursive and unmethodical, and not unaptly likened by its author to "a thickly-planted mountain, where fruit and other trees are confusedly grouped together, so as to baffle the plunderer, while the careful husbandman may find and transplant in fitting order such as were desirable for fruit or ornament; so the mysteries of Christian faith, veiled herein from impatient or ignorant curiosity, will discover their rich treasures to the honest and intelligent seeker of the truth" (*Strom.* lib. vii, p. 766, Potter's ed.). The object of the work is "to furnish materials for the construction of a true gnosis," or "Christian philosophy, on the basis of faith," for those who had been trained for it by the preceding works. Book I, of which the beginning is lost, descants on the utility of philosophy, as preparing the heathen for the reception of the Gospel, and Christians for the defence of their faith, maintaining that the good in heathen philosophy was derived from the Hebrews. Book II treats first of faith

and repentance, combating the errors of the Basilidians and Valentinians; asserts the freedom of man's will, and presents the views of different philosophers in regard to marriage, which Clemens defends on the grounds of the natural conformation of the sexes, the command of God (Gen. i, 28), and the mutual aid in sickness and age rendered by husband and wife, and parents and children. In Book III, continuing the same subject, he condemns the opinions of the Marcionites, Carpocratians, and other heretics who opposed marriage for different and contradictory reasons, alleging in support of it the words of St Paul (1 Tim. iv, 1-8), and the examples of the apostles Peter and Philip, who were married and had children. Book IV discourses of Christian perfection as exemplified in the Christian martyr, who is led to martyrdom not through fear of punishment or hope of reward hereafter, but from love to Christ, and who does not needlessly provoke his fate, but only accepts it cheerfully when called upon to be in that way a witness for the truth. The chief aim of Book V is to prove that the Greeks derived most of their wisdom from those called by them barbarians, and especially from Moses and the Hebrew prophets; but it also enters upon a long and interesting digression on the origin and use of symbols, and makes many valuable statements in regard to the Egyptian hieroglyphics, and the dress and ceremonial services of the Hebrew priests. This episode is one of the most curious relics of antiquity, and the book abounds in quotations from ancient authors. Books VI and VII portray the true Gnostic, the perfect Christian, who is presented as a "complete model of moral conduct," not so much desirous of living as of living rightly, controlling his passions and regulating his desires in conformity with the laws of Christ.

A small work, *Τις ὁ σωζόμενος πλούσιος;* (*What rich man may be saved?*) is also attributed to Clemens. This treatise is an examination of the words of Christ (Matt. xix, 24; Luke xviii, 25), and aims to show that these words do not require the renunciation of worldly goods as a condition of salvation; that the disposition of the soul is the essential thing, and that riches may be the materials and instruments of good works for those who rightly use them.

The following works of Clemens are not extant (the fragments which have been collected are found in the edition of Potter, vol. ii; in Fabricius's *Hippolytus* at the end of vol. ii; and in Galland's *Biblioth. Patr.* and Migne's *Patrologia*): *Ἐπιτομή αἰσίου; Περὶ τοῦ πάσχα; Περὶ Νηστείας; Περὶ καταλαλιᾶς; Προπρεπτικὸς εἰς Ἐπιτομῶν; Καθὼν Ἐκκλησιαστικὸς; εἰς τὸν Προφήτην Ἀμώς; Περὶ προνοίας; Ὅροι διαφόροι.* Clemens refers to some other treatises as either written or intended to be written by him, but we have no mention of them elsewhere.

The first edition of the three principal works of Clemens was made by Petrus Victorius (Florence, 1560, fol.; a Latin translation in 1551). It was followed by an edition by Fr. Sylburg (Heidelberg, 1592, fol.). A Greek-Latin edition was published by D. Heinsius (Leyden, 1616, fol.; reprinted Paris, 1629, Paris, 1641, Cologne, 1688). The best edition of all the works of Clemens, genuine and doubtful, is that by the Anglican Bishop Potter (2 vols. fol. Oxford, 1715, with valuable notes and a commentary to Clemens by Gentianus Hervetus; reprinted at Venice, 1757, 2 vols. fol., and [without the notes and the commentary] by Oberholzer, at Wurzburg, 1778-79, 8 vols. 8vo). New editions are by Klotz (Leips. 1831-34, 4 vols. 8vo) and by Abbé Migne (in his *Patrologia*). An excellent translation in English of the *Appeal*, the *Pedagogue*, and the first book of the *Stromateis* (the remainder of the work to follow in a subsequent volume), is found in vol. iv of the *Ante-Nicene Christian Library* (Edinb. 1867).—Schaff, *Ch. Hist.* i, 205 et al.; Neander, *Ch. Hist.* i, 691 sq., and *Hist. Dogmas*, i, 68 et al.; Gieseler, *Ch. Hist.* per. i, div. ii, chap. iii, § 62; Lardner,

Works, vol. ii (Lond. 1838, p. 220-259; Clarke, *Sec. Literature* (N. Y. 1839), p. 109-118; Eusebius, *Hist. Eccles.* lib. v et vi; *Journal of Sacred Lit.* Oct. 1852, p. 129; Reinkens, *De Clemente Presbytero Alexandrino, Homane, Scriptore, Philosopho, Theologo* (Vratislav. 1851, 8vo); Hoefer, *Nouv. Biog. Gén.* s. v.; Freppel, *Clement d'Alexandrie* (Paris, 1866); Kaye, *Writings and Opinions of Clemens of Alexandria* (Lond. 1835, 8vo).

Clement (Κλημῆς for Lat. *clemens*, merciful), a person (apparently a Christian of Philippi) mentioned by Paul (Phil. iv, 8) as one whose name was in the book of life (q. v.), A. D. 57. This Clement was by the ancient Church, identified with the bishop of Rome of the same name (Euseb. *Hist. Eccles.* iii, 4; *Constat. Apost.* vii, 46; Origen, vol. i, p. 262, ed. Lommatsch; and Jerome, *Scriptor. Eccl.* p. 176, a); and that opinion has naturally been followed by Roman Catholic expositors. It cannot now be proved incorrect; and in fact, it is not improbable in itself. There are essays on his life, identity, and character as a teacher, by Feuerlein (Altorf, 1728), Freudenberger (Lips. 1755), Frommann (Cobl. 1768), Roudinini (Rom. 1606). See CLEMENT OF ROME.

Clement of Rome (CLEMENTS ROMANUS). One of the early presbyters of the Church in Rome; probably a presiding presbyter, *primus inter pares*, afterwards called bishop. Irenæus, in his *adv. Hæc.* (iii, 3, 8), written between 182-188 A. D., makes him the third in order after the apostles Peter and Paul, Linus being the first, and Cletus or Anacletus the second. The *Clementines* give a different order, which was followed by Tertullian. But Eusebius, who appears to have taken great pains to be accurate, and had access to authorities no longer extant, preferred the order of Irenæus. He also adds the dates. Clement, he says (*Hist.* iii, 84), died in the third year of Trajan, "having for nine years superintended the preaching of the Divine Word." As Trajan became emperor on the death of Nerva, Jan. 23, 98 A. D., the so-called episcopate of Clement will have for its termini 91 or 92-100 or 101 A. D. Irenæus speaks of him as "having seen and conversed with the blessed apostles" who "founded the Church in Rome," i. e. Peter and Paul. Origen (*Comment. in Joan.* vi, 36) identifies him with the Clement of Philippians iv, 8. This may have been only a conjecture, or it may have been a tradition. It was, at any rate, the opinion of Eusebius and the early writers, and is in itself not at all improbable. Thirty years would certainly be time enough for a prominent Philippian to become a prominent Roman. Modern attempts to make out his origin from the epistle which bears his name have failed. Judging from the epistle, he may have been either a Jew, as Tillemont argues, or a Roman, as Lipsius argues, and the one about as probably as the other. Rufinus, who died 410 A. D., was the first to call him a martyr. The language of Eusebius implies that he died a natural death, which is altogether likely to have been the case if his dates have been correctly given. *The Martyrdom of St. Clement*, in the first volume of the *Patres Apostolici* of Cotelierius, is a puerile fabrication of no great antiquity. Its story is that Clement was first banished by Trajan to Chersonesus, and afterwards drowned in the Black Sea. On reaching his place of exile, he found two thousand Christians condemned to work in a marble quarry. As the water they used had to be fetched six miles, Clement caused a spring to break forth close to the quarry. This led to the conversion of a great multitude in the province, and the building in one year of seventy-five churches. And this, in its turn, led to Clement's martyrdom. An anchor was fastened to his neck, and he was cast into the sea. The people, bewailing him, prayed God to discover to them his remains. In answer to their prayer, the sea receded, and the people, going in on dry ground, found the body of the holy martyr buried with the anchor in a marble tomb, but were not permitted to remove it. Every

year, on the anniversary of the martyrdom, the sea repeats this miracle of receding for seven days. Another fable confounds Clement the presbyter with *T. Flavius Clemens*, the consul, and cousin to the emperor Domitian, by whom he was put to death on a charge of "atheism," one of the charges then current against Christians. Such fables, in the absence of authentic memorials, are not to be wondered at. The wonder is that the authentic memorials are so meagre; that of the real Clement—a man so conspicuous, able, and influential—there is so little known.

Of the writings falsely ascribed to Clement of Rome notice is taken in another article. See CLEMENTINES. The only genuine document is his *Epistle to the Corinthians*, commonly called the *First*, but improperly, since the so-called *Second Epistle* is not his, and is not an epistle, but only the fragment of a homily, later, perhaps, by nearly a hundred years. The only known manuscript of this epistle is the one appended to the Alexandrian Codex of the Scriptures sent by Cyril Lucar to Charles I in 1628, and now the property of the British Museum. Throughout the manuscript are many *lacunæ*, generally, however, of only single words or syllables. The only considerable gap, occasioned apparently by the loss of a leaf, is near the end of the epistle, between chapters 57 and 58. Here may have belonged certain ancient citations from Clement which cannot now be verified. Some expressions, like *λαϊκός* in the 40th chapter, have a suspicious look; but of the substantial integrity of the epistle there is no good reason for serious doubt. That it came from the pen of Clement, though his name is not in the epistle, is now generally conceded. It appears to have been in the hands of Polycarp of Smyrna when writing to the Philippians as early, perhaps, as 115, certainly not much later than 150 A.D. It is referred to as the work of Clement by Dionysius of Corinth in a letter to Soter of Rome, which must have been written between 170–176 A.D. Irenæus, in the section already cited (*adv. Hæc.* iii, 8, 3), speaks of it as a very able epistle, sent to the Church in Corinth by the Church in Rome under the episcopate of Clement. Origen, who died 254 A.D., speaks of it as written by Clement. So also Clement of Alexandria [† 220], who frequently and freely quotes from it, and even calls the author of it "the apostle Clement." Eusebius, whose History was written about 325 A.D., ascribes it to Clement, and speaks of it as having been "publicly read in very many churches both in former times and in our own" (*Hist.* iii, 16). Jerome († 420), in his *De Viris Illustribus*, § 16, reports it as still "publicly read in some places." But no one of these writers anywhere speaks of it as an inspired book. Though highly prized, neither this, nor the Epistle of Barnabas, nor the Shepherd of Hermas, was ever included in any ancient list of authoritative books. (See Westcott, *Canon of the New Testament*, Appendix B.)

This epistle, as we now have it, consists of fifty-nine short chapters—some of them very short—whose total bulk is about one third greater than that of the sixteen chapters of St. Paul's First Epistle to the Corinthians. Presbyters of the Church in Corinth had been unjustly deposed from office; a bitter dissension had broken out, and this epistle was written by Clement in the name of the Church in Rome, in order, if possible, to end the strife. It was sent by the hands of three messengers, Claudius Ephesus, Valerius Biton, and Fortunatus, who, it was hoped (chap. lix), might bring back the good news of peace and harmony restored. In form it resembles the Canonical Epistles, beginning with a salutation and concluding with a benediction. In the first three chapters, the Corinthians are first praised for their former virtues, and then sharply rebuked for the scandals which had occurred. The next nineteen chapters are devoted to historical illustrations, drawn from the Old and New Testaments, of the evils flowing from jealousy and

envy; followed by exhortations to repentance, humility, and meekness. In the next fourteen chapters, the exhortations are continued in view of the promised coming of Christ and their own resurrection; salvation by grace through faith is taught; and good works, in their proper relation to faith, are strongly insisted upon. Twenty-one chapters are then devoted to the special purpose of the epistle, discussing the general subject of ecclesiastical organization and order, and urging the Corinthians to put an end to their grievous sedition. The last two chapters contain a prayer for helping grace, with a benediction.

As to the date of this epistle, Hefele, who agrees with Cave, Dodwell, Fleury, and others in assigning the episcopate of Clement to the years 68–77 A.D., refers it to the time of Nero. But the mention made in the first chapter of "sudden and successive trials" which had befallen the Roman Church seems to require a later date. The Tübingen school put it into the second century. But recent critical authority preponderates decidedly in favor of 95–98 A.D. Failing thus within the apostolic age, and yet of considerably later date than the great bulk of the New Testament, special interest attaches to this epistle. It may be considered:

1. In comparison with the canonical books. It is evidently modelled after the canonical epistles, and yet is decidedly inferior to them. In regard to language, three words used by Clement are found only in the First Epistle of Peter; eleven only in the epistles of Peter and Paul; and twelve only in the epistles of Paul. (See Westcott, p. 80.) The book of which it most reminds us is the Epistle to the Hebrews. Hence an ancient tradition, reported by Eusebius (*Hist.* vi, 25) on the authority of Origen, that Clement was the author also of that epistle. But besides the many points of dissimilarity which discredit this particular tradition, there is a marked inferiority pervading the epistle of Clement as compared not only with the Epistle to the Hebrews, but with all the rest of the New Testament, which reacts powerfully as an argument for the inspiration of the canonical books. The Old Testament quotations are more extended; fanciful interpretations are given, as of the scarlet cord let down by Rahab typifying the blood of Christ; fables are introduced, as of the phoenix in treating of the resurrection; attempts are made at fine writing, as in the twentieth chapter, devoted to a description of the order and harmony of nature; with a tendency throughout to expatiation, which stands in strong contrast with the soberness, simplicity, terseness, and vigor of the apostolic epistles. A line has thus been deeply drawn between the inspired and uninspired documents of the early Church.

2. With respect to the canon itself. Of the Old Testament but little needs to be said. In the way either of express citation or of marked resemblance, nearly every book is recognized. Two at least of the apocryphal books are quoted. Clement made use of the Septuagint, and quotes more accurately than some of the fathers, indicating that he either referred to a manuscript or had a better memory than common. The text employed by him, Hilgenfeld says, accords neither with the Alexandrian nor the Vatican Codex, but, where these are at variance, steers between them, agreeing sometimes with the one, sometimes with the other. In quoting from the New Testament, Clement never calls it "Scripture" or "Scriptures," as he does the Old Testament; but individual writers are either quoted or referred to, and in a way which implies his belief that they had an authority above his own. Apologizing for the attitude he assumes, he exhorts the Corinthians, as though that must end all controversy, to "take in their hands the epistle of the blessed apostle Paul." Besides the Gospels of Matthew and Luke, the books indicated are Romans, 1 Corinthians, Ephesians, Hebrews, and James; perhaps also

I Timothy and Titus. In short, the usage is precisely what we should expect while the canon was not yet formed, but only silently forming.

8. With respect to the polity of the early Church. The object aimed at in the epistle called for certain definite statements on this point. And these are in complete accordance with the representations of the inspired books. In Clement, as in the Acts and Epistles of the New Testament, several features are palpable. No distinction is made between bishops and presbyters. For the local Church only two orders are recognised: presbyter-bishops and deacons. And they were appointed at first by the apostles, afterwards by these rulers themselves, though not to the exclusion of the brotherhood. The *initiative* was not with the congregation, but with its elders, "the whole Church consenting." Such is the representation in the forty-fourth chapter; and it accords with what is related of Paul and Barnabas, who, instead of merely *ordaining*, as our version appears to teach, "had appointed them elders in every church" (Acts xiv, 23). The New Testament representations are thus not only corroborated, but also elucidated.

4. In relation to doctrine. The orthodoxy of Clement, as of the earlier fathers in general, has been repeatedly called in question, but without good reason. Doctrinal discussion, in the style of the Epistle to the Romans, is certainly not attempted. But the leading features of the Gospel economy come clearly out. The divinity of Christ is taught quite as distinctly as in the Epistles to the Colossians and Hebrews. And so likewise are the atonement and justification by faith. If good works are strongly emphasized, so also are they strongly emphasized not only by James in his epistle, but by Paul himself. And as there is no contradiction between Paul and James, there is none between Paul and Clement.

The *Literature* of the subject is abundant. Of the text there have been three recensions. The epistle was first published by Junius, at Oxford, in 1633; again, more accurately, by Wotton, at Cambridge, in 1718; and, lastly, by Jacobson, at Oxford, in four successive editions, 1838, 1840, 1847, and 1866. Jacobson's text is now the standard, and is as nearly perfect as critical acumen and diligence could make it. Of earlier editions, embracing all the apostolical fathers, the best are those of Cotelerius, Paris, 1672, as improved by Clericus (Antwerp, 1698), and again improved (Amsterdam, 1724), and of Ittigius, with a valuable dissertation (Leipsic, 1699). Of later editions, the best are those of Jacobson, already named; of Hefele (Tübingen, 1839, 1842, 1847, 1855); and of Dressel (Leipsic, 1856, 1868). Of treatises, the most valuable are those of Lechler, *Das apostolische und das nachapostolische Zeitalter* (Haarlem, 1851; Stuttgart, 1857); Hilgenfeld, *Apostolische Väter* (Halle, 1853); Lipsius, *De Clementis Romani Epistola ad Corinthios Priore Disquinio* (Leipsic, 1855); and Donaldson, *Critical History of Christian Literature and Doctrine from the Death of the Apostles to the Nicene Council* (vol. i, London, 1864). Of English translations, the earliest was by Burton (London, 1647); the next was that of Archbishop Wake (London, 1693, frequently republished; admirably though inaccurately done); the next was anonymous (Aberdeen, 1768); then Chevalier (London, 1833, 1851, on the basis of Wake); and, lastly, Roberts and Donaldson (Edinburgh, 1867, vol. i of the "Ante-Nicene Library"). This last has not the scriptural tone of Wake, but is greatly superior to it in accuracy of rendering.

Clement I. See CLEMENT OF ROME.

II, Pope (*Swidger*, bishop of Bamberg), was placed in the papal see Dec. 21, 1046, after the Synod of Sutri, by the Emperor Henry III, in the room of Gregory VI, who abdicated. He crowned this emperor, and died in Jan. 1047, a synod at Rome for the suppression

of simony. He died, as some think, by poison, Oct. 9, 1047. He was the first of the German popes, and retained the diocese of Bamberg even during his pontificate. He put the city of Benevento under the interdict because it had refused to receive the Emperor Henry.—Neander, *Ch. Hist.* iii, 878; Gieseler, *Ch. Hist.* per. iii, div. ii, § 22; Hoefler, *Teutsche Päpste, 1 Abtheil* 283-288; Wetzler u. Welte, *Kirchen-Lex.* ii, 590.

III, Anti-Pope (*Guibert*, archbishop of Ravenna), was chosen pope at the Synod of Brixen in 1080, by the party of the Emperor Henry IV, with the view of supplanting Gregory VII. After being repeatedly placed in the Roman see by violence, and expelled from it by the same means, he submitted to Paschal II in 1099, and died in the following year.—Neander, *Ch. Hist.* iv, 118 sq.; Gieseler, *Ch. Hist.* per. iii, div. iii, chap. i, § 47, 48.

III, Pope (*Paolo*, cardinal bishop of Rome), was a native of Rome. He was chosen pope at Pisa on the 19th of Dec. 1187, in the place of Gregory VIII, who had died in the same city two days before. The chief concern of the new pope was the speedy organization of a third crusade, as the news of the conquest of Jerusalem by Saladin (Oct. 3d, 1187) had just been received. He wrote at once to all the Christian princes, and succeeded in calling forth an unprecedented enthusiasm. The aged emperor Frederick Barbarossa (67 years old), who had had a violent conflict with the predecessor of Clement on account of the possessions of the Countess Matilda, made peace with the pope and took the cross. Peace was also restored between Venice and the king of Hungary, and between the king of France and the king of England, and all these states, joined by Leopold of Austria and others, were induced to take part in the crusade. The pope had the grief of learning the death of Frederick in the River Kalicadnus, and the dissensions between the princes besieging Acco, but he did not live to see the unfortunate end of the crusade.

Clement again secured for the popes the secular rule over the city of Rome, which during forty-nine years had been left by the popes. Tired of their civil wars, the Romans conceded to Clement the right of sovereignty. A conflict with the king of Scotland, who had appointed of his own accord a bishop for St. Andrew's, terminated favorably to the pope. The king yielded when the pope threatened with the interdict. In reward for this concession, the pope (by a bull of March 13, 1189) exempted all Scotland from the jurisdiction of the archbishop of York, made it an immediate dependency of the papal see, and provided that henceforth no one should be a papal legate in Scotland who was not either a Scotchman or an officer of the Church in Rome. On the death of King William II of Sicily (Nov. 1, 1189), a dangerous conflict arose between the son of Frederick Barbarossa, Henry (subsequently emperor Henry VI), whose wife was the nearest relation to the late king, and the pope, who claimed feudal rights over Sicily, and hastened to invest with its government Tancred, an illegitimate son of duke Roger of Sicily. Henry, after the death of his father, was marching upon Rome, when Clement died, on March 25, 1191. The personal life of this pope is said to have been blameless. Seven letters and many decrees issued by Clement are given by Mansi (xxii, 543-574).—Herzog, *Real-Encyklop.* ii, 780; Wetzler u. Welte, *Kirchen-Lexicon*, ii, 591; Neander, *Ch. Hist.* iv, 417; Gieseler, *Ch. Hist.* per. iii, div. iii, chap. i, § 53.

IV, Pope (*Guis Fulcodi*, according to others, *Guido Fouquois le Gros*), was a native of France, first a soldier, then a lawyer, married, and on his wife's death entered the Church, and became in succession bishop of Puy, archbishop of Narbonne, and (1261) cardinal bishop of Sabina. He was chosen pope at the beginning of 1265, while he was absent from Italy as papal legate, and solemnly crowned on the 22d of February,

at Viterbo, where he took up his residence on account of the disturbances prevailing in Rome. During the whole time of his pontificate he was occupied with the contest concerning the government of Sicily. His predecessor, Urban IV, has invited Charles of Anjou to take possession of Sicily, which was then ruled by Manfred, an illegitimate son of Emperor Frederick II. When Charles appeared in Rome (May 21, 1265), five cardinals, in the name of the pope, concluded between him and the papal see a treaty which gave to Charles the whole of the Apulian Empire, while Charles, on the other hand, pledged himself to pay a certain tribute, and to abolish the ecclesiastical decrees of Frederick II. The arrogance of Charles, his want of money, and the outrages committed by French soldiers, disposed the pope favorably toward Manfred, but the latter died before the reconciliation had taken place. The cruelty of Charles against the family and the adherents of Manfred, and his violation of the treaty, filled the pope with indignation. Nevertheless, when young Conradin, the grandson of Frederick II, appeared in Italy, the traditional hostilities of the popes toward the Hohenstaufens induced the pope to excommunicate him. Conradin was received with enthusiasm by the Ghibelline opponents of the pope, and, in particular, by the people of Rome, and the pope naturally rejoiced at his defeat and capture. It cannot, however, be proved that he knew of, and much less that he approved of his execution. Clement survived exactly one month after the last scion of the Hohenstaufens Conradin was beheaded, dying at Viterbo Nov. 29, 1268. He was an able ruler, and resolutely hostile to nepotism. Many of his letters have been published by Martene and Durand in their *Theaurus Novus Artistorum* (Paris, 1717, 5 vols. fol.), and by D'Achery in his *Spicilegium*. He wrote several works, among which was a life of St. Hedwig, duchess of Poland, who was canonized by him in 1267. On works falsely attributed to Clement, see Cave, *Hist. Lit. ad annum* 1265. A special work on the life and writings of Clement was published in 1628 at Lyons by the Jesuit Claudius Clemens. See Herzog, *Real-Encyclop.* ii, 782; Wetzler u. Welte, *Kirchen-Lexicon*, ii, 594; Neander, *Church Hist.* iv, 289, 424; Gieseler, *Church Hist.* per. iii, div. iii, chap. i, § 57.

V, Pope (*Bertrand d'Agout*), was born at Uzeste about 1264. He was appointed bishop of Comminges by Boniface VIII in 1295, and was one of the few French bishops who obeyed the summons of the pope to visit Rome, notwithstanding the prohibition of Philip the Fair. In 1299 he was appointed archbishop of Bordeaux. During the conclave following the death of Boniface VIII in 1305 he was gained over by Philip the Fair, and when a compromise had been adopted between the party of Boniface and the French party, in virtue of which the French cardinals had to choose the pope among three candidates proposed by the party of Boniface, he was elected, being still regarded as a friend of Boniface. At a secret interview which he had had with Philip before the election he had promised to reconcile the king with the Church, to leave to him during five years the tithe for military wants, to condemn the memory of Boniface, and to create a number of new French cardinals. All these conditions were promptly fulfilled except the one relating to Boniface, which the pope tried to escape. He instituted a committee to investigate the charges brought against Boniface, but ultimately (1311) declared him free from the stain of heresy. On the other hand, he yielded to the demand of Philip for the abolition of the order of the Templars. He summoned the grand master of the order, under false pretéxts, to his court; issued in 1308 a bull against the order, in which he brought against it the most unfounded and absurd charges; and finally, at the General Council of Vienne (in 1312), pronounced its abolition. The pope raised no objection to the appropriation of most of the

possessions of the order by Philip, and to the burning of the grand master and of many leading members. Clement was the first pope who fixed his residence at Avignon, thus beginning what has been styled the Babylonian Captivity of the popes. He published a large number of constitutions based upon the decrees of the Council of Vienna, which still form, under the name of "Clementines" (q. v.), the seventh book of the Decretals. He died on Nov. 29, 1314. The contemporaneous writers accuse him of licentiousness, nepotism, simony, and avarice. See Wetzler u. Welte, *Kirchen-Lex.* ii, 594 sq.; Herzog, *Real-Encyclop.* ii, 782; Neander, *Ch. Hist.* iv, 70, 841; Gieseler, *Ch. Hist.* per. iii, div. iii, ch. i, § 59, and div. iv, ch. i, § 95; Landon, *Manual of Councils*, s. v. Vienne.

VI, Pope (*Pierre Roger*), was a native of Limonsin, in France. After having been a Benedictine monk in Chaise-Dieu, professor at Paris, bishop of Arras, archbishop of Sens and Rouen, and (1338) cardinal, he was elected pope on the 7th of May, 1342. He had a protracted quarrel with Edward III, king of England, on the subject of ecclesiastical benefices, over which Clement claimed an absolute right. He issued a frightful bull of excommunication against Louis IV of Germany (see Raynald, *ad annum* 1346), when the latter and the German Diet refused to promise that the king should do nothing without the consent of the pope, and induced five of the German electors to elect Charles, the son of the king of Bohemia, as German emperor. By a contract of June 9, 1348, he purchased from Joanna, queen of Naples, the city of Avignon and some adjoining territory for 80,000 gold florins, which, however, were never paid. Previously the queen, who personally appeared before him, had been acquitted of the charge of having murdered her husband. An urgent invitation from the Romans (among whose ambassadors was Petrarch) to return to Rome was sent to the pope, but he continued at Avignon. By a bull of April 10, 1349, he reduced the interval between the years of jubilee [see JUBILEE] from 100 to 50 years, and celebrated the jubilee in 1350 with extraordinary pomp. In the bull of Clement the angels are commanded to introduce into Paradise without delay any one who should die during his stay at Rome. His efforts to bring about a union of the Greek Church with the Roman were fruitless, although the emperor Johannes Cantacuzenus declared in favor of the union. More successful were similar efforts with regard to the Armenians, who, at a council held in 1342, condemned those heresies with which they were charged. In 1345 Clement brought about a new crusade against the Turks, in which the king of Cyprus, the grand master of Rhodes, and the republics Venice and Genoa took part, which, however, led to no result. He showed a great severity against the Flagellants. See FLAGELLANTS. Most of the new cardinals created by this pope were Frenchmen, and among them were a considerable number of his own relatives, who scandalized the Church by their licentious lives. Clement died in 1362. Petrarch praises the generosity and eloquence of this pope; but he gave, on the other hand, great offence by his extravagance and by his private life. Of his writings there are still extant several sermons, a treatise on the poverty of Christ and the apostles, a volume of letters, etc. See Wetzler u. Welte, *Kirchen-Lex.* ii, 596-600; Herzog, *Real-Encyclop.* ii, 783, 784; Hoefler, *Biog. Générale*, x, 765; Neander, *Church Hist.* x, 41, 43, 412; Gieseler, *Ch. Hist.* per. iii, div. iv, ch. i, § 97, 100.

VII, Anti-pope at Avignon (*Robert of Geneva*), with whom the great papal schism commenced, took this title on his election in 1378. He resided at Avignon, was acknowledged at once in Naples and France, and at a later period by Scotland, Savoy, and Lorraine, as well as by Castile, Aragon, and Navarre. He died without reputation in 1394.—Neander, *Church Hist.* v, 475, 565, 164, 262; Gieseler, *Ch. Hist.* per. iii,

div. vi, ch. i, § 101; Hase, p. 275. See AVIGNON; URBAN VI.

VII, Pope (Giulio, illegitimate son of Giuliano de Medicis), became pope in 1523; one of the weak and wavering men whose selfish policy in critical times makes their prominence in history a prominence of disgrace. He entered the Maltese order, and became grand prior of Capra. When his cousin Leo X ascended the papal throne he was at once appointed archbishop and cardinal. Subsequently he acted as cardinal legate of Tuscany. He was elected pope on the 19th of Nov. 1523. On May 2, 1524, he issued a bull for the reformation of abuses prevailing in Italy. In the same year he sent a legate, Campeggio, to the Diet of Nuremberg, in order to bring about a suppression of the Reformation in Germany. The pope and his legate greatly offended the German princes by their arrogance, but succeeded, nevertheless, in effecting an alliance against the Protestants between Austria, Bavaria, and twelve princes of South Germany. Notwithstanding the zeal of the emperor for the defence of the Church of Rome, the pope was prevailed upon by the king of France to join the alliance of France, England, Venetia, and other Italian states against Charles. After the siege and capture of Rome by the imperial army, the pope was compelled to capitulate (Jan. 5, 1527); but, being unable to fulfil the conditions of the capitulation, he escaped, disguised as a merchant, on Dec. 9, 1527, and fled to Orvieto. Soon after he concluded a peace with Charles (1529), and crowned him emperor at Bologna (1530); while, on the other hand, Charles restored the papal possessions, and made Alessandro di Medicis (a reputed son of the pope) sovereign of Florence. The demand of Charles and the German princes for the convocation of an oecumenical council, which was to reform abuses in the Church and restore its unity, he did not fulfil, making his consent contingent upon conditions which he knew to be unacceptable to Charles. In the suit of Henry VIII of England for divorces from his wife, Catharine of Aragon, the pope, after long hesitation, decided against the king, and thereby precipitated the separation of the Anglican Church from the Church of Rome. He sanctioned the new monastic orders of the Capuchins, Theatines, Somaskians, and Recollects, enlarged the library of the Vatican, and was in general a patron of literature. He died Sept. 25, 1534. The *Bullarium Romanum* (ed. Lugd. 1692, i, 636-694) contains 41 constitutions and decrees of this pope. The life of Clement has been written by Onufrio Panvini and Jacob Ziegler (in Schelhorn, *Amoen. hist. eccl.* tom. ii). See Wetzler u. Welte, *Kirchen-Lex.* ii, 600-602; Herzog, *Real-Encykl.* ii, 784-786; Hoefler, *Biog. Générale*, x, 766; Ranke, *Hist. Papacy*, bk. i, ch. iii; Hase, *Ch. History*, p. 376, 380, 421, 450.

VIII, Anti-pope (Egidius Muñoz), took this title in 1421 on being elected by three cardinals at Peniscola, after the death of Benedict XIII. He resigned to Martin V in 1429, and thus terminated the great Western schism.—Migne, *Dict. Biog.* s. v. Mugnoz; Gieseler, *Ch. Hist.* per. iii, div. v, ch. i, § 180.

VIII, Pope (Ippolito Aldobrandini), was born in 1586, at Fano; became first a lawyer, subsequently consistorial advocate, auditor of the Rota (see ROTA), datarius (q. v.), and, in 1685, cardinal, and legate in Poland. He was elected pope Jan. 30, 1692. He was a cautious and politic ruler. He mediated the peace of Vervins between France and Spain. In the civil war of France he sided, like his predecessors, with the league against Henry IV. Even after the latter had joined the Church of Rome the pope hesitated to recognise him, and it was not until nearly the whole of France had recognised him that the pope consented to a solemn absolution of Henry (Dec. 17, 1697). Henry supported the annexation of Ferrara to the papal states, and reintroduced the Jesuits into France, while,

on the other hand, the pope abstained from openly opposing Henry's edict of toleration. During his pontificate the king of Poland prevailed upon the metropolitan of Kiev and seven of the Ruthenian bishops to unite with the Church of Rome, and ambassadors arrived at Rome from the Coptic patriarch of Alexandria to negotiate a union of the Copts with the Church of Rome. He issued new editions of the Vulgate, the Roman Breviary, Missal, and of the Index. In order to settle the dogmatical controversy between Jesuits and Dominicans on divine grace, he instituted in 1597 the *Congregatio de auxiliis divine gratiæ*. A dispute with the republic of Venice was amicably settled. He died on March 5, 1605. Baronius and Bellarmine were among the cardinals appointed by him. One hundred and twenty-three constitutions and decrees of this pope are contained in *Bullar. Rom. Magnæ*, tom. iii, 1-170. His life was written by Cicarella.—Ranke, *Hist. Pap.* b. vi; Hase, *Ch. Hist.* p. 456, 466 sq.; Wetzler u. Welte, *Kirchen-Lex.* ii, 603-640; Herzog, *Real-Encykl.* ii, 186.

IX, Pope (Giulio Rospigliosi), was born in 1600 at Pistoja. He was in succession auditor of the Rota, secretary of Sixtus IV, and cardinal, and was elected pope in 1667. He mediated a peace between Louis XIV and Spain, at Aix-la-Chapelle, in 1668. He was upright in his intentions, but easy in disposition. He left his name to the *Clementine Peace*, a brief pause in the struggle between the Jansenists and Jesuits. He is said to have died of grief at the taking of Candia by the Turks, 1669.—Ranke, *Hist. Pap.* b. viii; Hase, *Ch. Hist.* p. 512, 518; Wetzler u. Welte, *Kirchen-Lexikon*, ii, 605.

X, Pope (Emilio Altieri), was born at Rome on the 18th of July, 1690, and held the papal chair from 1669 to 1676. Eighty years old at his accession, he was completely governed by his relations, one of whom, Cardinal Paluzzi, was called by the Romans pope *de facto*. He was always eager to mediate peace between the Roman Catholic states, and supported the Poles with money against the Turks. In his reign commenced the dispute with Louis XIV of France concerning the rights claimed by the French kings, during the vacancies of episcopal sees, to dispose of the ecclesiastical benefices, and to receive the revenue.—Ranke, *Hist. Pap.* b. viii; Hase, *Ch. History*, p. 512; Wetzler u. Welte, *Kirchen-Lexikon*, ii, 608.

XI, Pope (Giovanni Francesco, count of Albani), was born at Pesaro July 22, 1649. He was secretary of the secret briefs under Innocent XI, Alexander VIII, and Innocent XII, and, as such, wrote, among others, the celebrated bull of Alexander VIII (1691) against the Gallican liberties adopted by a national convention of the French bishops in 1682. He became cardinal deacon in 1690, and cardinal priest in 1700. He was raised to the popedom in 1700 on account of his energy and ability, and displayed abundance of the former quality, but with singular want of success. He opposed the elevation of Prussia to a kingdom, and thus made himself ridiculous in Germany. In the war of the Spanish succession he voluntarily acknowledged Philip V, the grandson of Louis XIV of France, but was compelled by the imperial forces threatening Rome to recognise Charles III, the brother of Joseph I of Austria, as king of Spain. He lost Parma and Placentia, and was totally disregarded at the peace of Utrecht (1713). By this peace Sicily was given to Duke Victor Amadeus of Savoy, who denied the papal claim to Sicily, and when the pope had recourse to ban and interdict, expelled nearly all the priests from Sicily, and transported them to the papal states. The pope did not repeal ban and interdict until 1719, when Sicily fell to the power of the emperor of Austria. In the long controversy between the Dominicans and Jesuits concerning the observance of the pagan customs of China by converts, in

which Innocent X had decided in favor of the Dominicans, and Alexander VII in favor of the Jesuits, Clement again declared against the Jesuits, who apparently submitted, but continued the controversy. In the Jansenistic controversy this pope took very decisive action by the bull *Vineam Domini* (July 16, 1705), which demanded a strict adherence to the decrees of Innocent X and Alexander VIII against the book of Jansenius. Of still greater importance was the celebrated bull *Unigenitus* (Sept. 8, 1713) against Quesnel's (q. v.) work on the New Testament, which produced an extraordinary union in the Gallican Church. The *Bullar. Rom. Contin. P. II* (1727), contains 123 bulls, constitutions, letters, and briefs of Clement; and *Contin. P. VI* (1739), 188 constitutions. The life of Clement XI was written by Polidoro (Urbino, 1727), Lafiteau (Pad. 1752, 2 vols.), Reboulet (Avignon, 1752, 2 vols.), and by the Protestant Buder, *Leben u. Thaten des klugen Papstes Clementis XI* (3 vols. Frankf. 1720). He died 1721. His works (Homilies) were published (2 vols. fol.) in Rome, 1729.—*Ranke, Hist. Pap. b. viii*; *Hase, Ch. Hist.* p. 513, 518; *Wetzer u. Welte, Kirchen-Lex.* ii, 609, 612; *Herzog, Real-Encyklop.* ii, 787.

XII, Pope (*Lorenzo Corsini*), was born at Florence in 1652. He was appointed cardinal May 17, 1706, cardinal bishop of Frascati in 1725, and became pope July 12, 1730, when 78 years old. Immediately upon his accession to the papal chair, he instituted a trial against Coscia, the favorite of his predecessor, Benedict XIII, for extortion. Coscia was sentenced to eight years' imprisonment, and a fine of 40,000 ducats. In 1732 he issued a papal "constitution" for a better regulation of the conclave; by a brief of 1736 he suppressed the sect of the Cocchiar, and in 1738 he condemned the Free-masons. He took a special interest in the union of the Greek Church with the Roman, and in 1734 founded the "Corsinian" ecclesiastical seminary for young Greeks at Bissignano, in Calabria; but the endeavors of the Jesuits to gain over the patriarch of Constantinople were fruitless. Equally inefficient were special efforts made for winning over the Protestants of Saxony and Silesia. His relations to the Roman Catholic states were, in general, not friendly. Parma, which he claimed after the death of the last Farnese (1731), was occupied by Austria. Spain, against the consent of the pope, made enlistments in the papal states, and placed garrisons in several towns. Portugal claimed the cardinal's hat for a favorite of the king (Bicchi), and the pope, in 1731, yielded. Charles Emanuel of Sardinia was threatened with the ban for occupying several places in Piedmont which the pope claimed as fief. The little republic of San Marino, which Cardinal Alberoni, in 1739, had rashly annexed to the papal states, soon recovered its independence. He supported the emperor of Austria with money in his war against the Turks. He promoted the study of Oriental languages, especially the Syriac, and sent Assemani on his second journey to the East, to collect Oriental manuscripts for the library of the Vatican. His private life was austere, and he was rigid in the enforcement of ecclesiastical discipline. He died Feb. 6, 1740. The *Bullarium Rom. Cont. P. VIII* (Luxemb. 1740), contains 277 constitutions of this pope.—*Hase, Ch. History*, p. 514; *Ranke, Hist. Pap. b. viii*; *Wetzer u. Welte, Kirchen-Lex.* ii, 611; *Hoefler, Biogr. Générale*, x, 769.

XIII, Pope (*Carlo della Torre di Rezzonico*), was born at Venice March 7, 1698; became governor of Fano in 1721, auditor of the Rota in 1729, cardinal-deacon in 1737, bishop of Padua in 1743, cardinal-priest in 1747. He ascended the papal chair July 6, 1758. He owed his elevation to the Jesuits, whom he supported with an earnestness and perseverance that fully displayed the feebleness of the popedom. By autograph letters to the kings of France, Portugal, and Spain, he endeavored to avert the destruction of the

order in those three states. But in vain. The Portuguese government suppressed all the convents in 1759 and 1760, imprisoning a number of members under the charge of being accomplices of a plot against the life of the king, and transporting most of them into the papal states "as a present to St. Peter." In 1764 the Jesuits were exiled from France. In reply, Clement issued the bull "*Apostolicum pascendi*," in which he again confirmed the order; but the French Parliament forbade the publication of the bull. In April, 1767, the Spanish government embarked all the members of the order in Spain in order to transport them to the papal states. On the 30th of January, 1768, the pope issued a brief, in which he annulled, as head of the Church and as feudal sovereign of Parma, a number of reformatory measures which the duke of Parma had issued in 1765 and 1766, pronouncing the severest censures of the Church against all who had aided in the drawing up, publication, and execution of these decrees, and releasing the subjects of the duke from the duty of obeying them. This bull produced the greatest indignation at all the Bourbon courts. Parma expelled the Jesuits (in 1768), France occupied Avignon and Venaissin, and Naples took possession of Benevento and Pontecorvo. In addition to these troubles, a conflict arose with the republic of Venice, which had issued some laws restricting the privileges of the clergy, and in particular that of accumulating property. The republic of Genoa offered a reward of 6000 scudi for the capture of a papal delegate to the island of Corsica, which had risen in insurrection against the Genoese. In January, 1768, the pope protested against the resolution of the Polish Diet, which, although recognising the Church of Rome as the state Church, made some concessions to the dissidents. Besides these conflicts with the state governments, Clement had a hard struggle against an Episcopal movement in the Church of Rome, which demanded a restriction of the papal prerogatives and an enlargement of the powers of the metropolitans, and the chief representative of which was the German bishop Febronius (q. v.). The *Congregation of the Index* forbade the possession and circulation of the book under penalty of the galleys; but this rigorous measure, as well as letters to the bishops of Germany to use the utmost efforts for the suppression of the dangerous book, remained useless. Some of the bulls issued by Clement (as *Animum Salutis* and *Alid ad Apostolatus*), in vindication of the claims of the papacy, offended even the most zealous partisans of the pope. Even the cardinals became dissatisfied, and a change of policy was seriously contemplated when the pope died on February 2, 1769. Clement restricted the right of asylum, forbade the clergy from engaging in mercantile pursuits, and conferred upon Maria Theresa the title of apostolic majesty.—*Ranke, Hist. Pap. bk. viii*; *Hase, Church Hist.* p. 524 sq.; *Wetzer u. Welte, Kirchen-Lexikon*, ii, 613-618; *Herzog, Real-Encyklop.* ii, 788-740.

XIV, Pope (*Giovanni Vincenzo Antonio Ganganelli*), was born at San Arcangelo, near Rimini, October 31, 1705. After receiving an education in the institutions of the Jesuits at Rimini and the Piarists at Urbino, he entered, on May 17, 1723, the order of the Minorites, exchanging his baptismal Christian name for that of Lorenzo. He soon distinguished himself both as a pulpit orator and as a theologian, and taught theology in several of the institutions of his order. When, on May 20, 1741, Pope Benedict XIV presided at the general chapter of the Minorites, which was to elect a new general of the order, Ganganelli, in the name of the chapter, addressed the pope in a speech which gained to him the full confidence of Benedict. He was in 1745 appointed assistant, and in 1746 consultant at the Sant' Uffizio (the Congregation of the Inquisition), and in this office won general respect by his moderation, amiable character, and scholarship.

On September 24, 1759, he was appointed cardinal-priest by Clement XIII upon the recommendation of the general of the Jesuits. The pope intrusted to him several important missions; but when it was found that he disapproved the uncompromising opposition of the pope to the Bourbon courts, he fell into disfavor, and was deprived of all influence. The conclave, after the death of Clement XIII, lasted over three months. The ambassadors of the Bourbon courts, aided by the youthful Archduke Joseph of Austria (subsequently Joseph II), made the utmost exertions to secure the election of a liberal pope. Ganganelli finally was agreed upon by a compromise of the two parties. The one regarded him as sufficiently flexible and liberal, while the Jesuits' party held that, though opposed to the late pope's policy, he was not hostile to the order of the Jesuits. Thus he was elected by both parties on May 19, 1769. As he was not yet a bishop, he received the episcopal consecration on the 28th of May, and was crowned pope on the 4th of June. He opened his pontificate by making reforms in the administration of the papal states, showed himself a patron of science and art, and endeavored to gain the confidence of the Roman people. But his chief care was to restore the good relations between the papal and the Bourbon courts. He opened a personal correspondence with the Bourbon princes, and carefully avoided everything that could give offence. He abandoned the papal claims to the duchy of Parma; offered himself to the court of Madrid as godfather for the new-born son of the princess of Asturias; conciliated the king of Portugal and his prime minister Pombal (who threatened a complete separation of Portugal from the Church of Rome) by appointing Pombal's brother a cardinal, and confirming the episcopal nominations which had been made by the king. This conciliatory policy secured the restoration to the papal government of Avignon, Venaissin, Benevento, and Pontecorvo. But the chief demand of the Bourbon courts, the suppression of the order of the Jesuits, he tried to escape as long as possible. He had held himself aloof from the Jesuits from the first day of his pontificate, and had forbidden the admission of the General of the order to the Vatican. He appointed a committee of jurists to examine the subject; acquainted himself personally with all that had been written for or against the order; and took great care to prepare public opinion gradually for its suppression. In a letter to the king of Spain he publicly admitted the necessity of suppressing the order, as the members had deserved this fate by their intrigues. The bishops of the papal states were authorized to examine the houses of the Jesuits, and to secularize those members who desired it. On June 25, 1773, the seals were put on the archives of the novitiate of the order at Rome, and the cardinal of Aragon was directed to possess himself of all their possessions within his legation. A similar order was given to the bishop of Montalto. Finally, on July 21, 1773, the famous brief "*Dominus ac Redemptor Noster*," by which the whole order was suppressed, was signed. It was published on the 16th of August. On the whole, the decree was carried out with great regard to the individual members, but the general, father Ricci, was arrested. The brief states, as a reason for the suppression, that the Church no longer derived from the order the advantages which were expected from it at the time of its foundation; it refers to the suppression of other monastic orders by former popes; claims for the pope the right of suppressing an order without previous trial, and explains his long hesitation to take this step from his earnest desire of thoroughly considering the matter. The measure naturally produced an extraordinary excitement; the Jesuits everywhere submitted, but some violent books against the acts of the pope were published by the members or friends of

the order, and prophecies from a Dominican nun, Anna Theresa Poli, and from a certain Bernardina Renzi, announcing the imminent death of the pope, were widely circulated. Some months after the suppression of the order the health of the pope began to fail, and he died September 19, 1774. An opinion that he had been poisoned found many believers, and is still defended by a number of writers, but a majority of the best historians have declared it not sufficiently supported. Special works on Clement are, Caraccioli, *Vie de Clement XIV* (1775; German translation, Frankfurt, 1776); *Leben des P. Clemens XIV* (Berlin, 1774-75, 8 vols.); Cretineau-Joly, *Clement XIV et les Jesuites* (Paris, 1847, on the side of the Jesuits); *Ganganelli. Pape Clement XIV; seine Briefe und seine Zeit* (Berlin, 1847); Theiner, *Histoire du Pontificat de Clement XIV* (Paris, 1853, 8 vols.; German edit. Leipzig). Father Theiner, who was a prefect-coadjutor of the archives of the Vatican, consulor of the Congregation of the Index and other congregations, a member of the special Congregation on the Immaculate Conception, etc., at Rome, made use of many unprinted documents in the archives of the Vatican. He tried to exalt Clement as one of the greatest popes, and, in order to achieve this, came out very severely against the Jesuits of that time. His work led to a lively controversy. The French historian of the order, Cretineau-Joly, undertook the defence of the Jesuits, but his book was put on the Index. The general of the order, P. Roothan, fearing that the controversy might turn out badly for the order, declined all responsibility for Cretineau-Joly's work, but at the same time induced P. de Ravignan, the celebrated Jesuit preacher at Paris, to take up the defence of the order. Ravignan accordingly wrote and published *Clement XIII et Clement XIV* (Paris, 1854, 2 vols., p. 574 and 502), in which he tries to justify both the Jesuits and the pope who suppressed them. See Herzog, *Real-Encyclop.* ii, 740-742; Wetzler u. Welte, ii, 618-622; Hoefler, *Biog. Generale*, x, 770-776; Ranke, *Hist. Pap.* bk. viii; Hase, *Church Hist.* § 525; Hook, *Eccles. Dict.* s. v. Ganganelli.

Clementines, I. (Κλημέντια, Κλημέντινα, or pseudo-Clementines), are the several writings, partly orthodox, partly heretical, falsely ascribed to Clement, one of the apostolic fathers, and bishop of Rome from A. D. 92-102, for the purpose of giving them greater weight and currency. These works are:

1. A SECOND EPISTLE TO THE CORINTHIANS, extant only in fragments. These fragments are found, together with Clement's genuine or first Epistle to the Corinthians [see CLEMENT OF ROME], at the close of the Alexandrian Codex of the Bible (called Cod. A), dating from the fifth century, and preserved in the British Museum. The earliest mention of such an epistle we meet in Eusebius, who says (*Hist. Eccl.* iii, 38), "We must know that there is also a second Epistle of Clement; but we do not regard it as being equally notable with the former, since we know of none of the ancients that have made use of it."

The catalogue of writings contained in the Alexandrian MS. ascribes it to Clement; but this, in the absence of other evidence, external and internal, is not of great weight, since Codex A cannot be traced beyond the fifth century. A closer examination of the fragments shows that they are not an epistle, but a homily, containing general exhortations to active Christianity, and to fidelity in persecution, with polemical references to the Gnostic denial of the resurrection. The document differs so much in style and doctrinal importance from the genuine epistle of Clement that it has been generally assigned by critics to a later date. It is orthodox in sentiment. The very beginning contains a distinct confession of the divinity of Christ, who is called "God, and the Judge of the living and the dead." Otherwise it is of no special account.

2. Two encyclical LETTERS TO VIRGINS, first discovered by Wetstein in 1752, in a Syriac translation, and appended to his edition of the Greek Testament. They commend celibacy, and contain exhortations and rules of discipline for monks and nuns.

3. Five DECRETAL LETTERS, which pseudo-Isidore has placed at the head of his collection of decretals of Roman popes. Two of them are addressed to James, bishop of Jerusalem, and are older than the pseudo-Isidore of the eighth or ninth century; the three others were fabricated by him.

4. The APOSTOLICAL CONSTITUTIONS and CANONS, including the LITURGY of St. Clement, which is a part of the eighth book of the Constitutions. This is a collection of ecclesiastical laws and usages which grew up gradually during the first four centuries, and is valuable chiefly as a rich source of information concerning ancient Church government, worship, and practice. The work professes to be a bequest of all the apostles handed down through the Roman bishop Clement, or dictated to him. It begins with the words, "The apostles and elders to all who among the nations have believed in the Lord Jesus Christ. Grace be to you and peace," etc. It contains, in eight books, a collection of moral exhortations, ecclesiastical laws, and liturgical formularies. The object of the compiler was to establish the episcopal hierarchy, and to furnish the clergy with a convenient guide in worship and discipline. The first six books were written at the end of the third century, the remaining two at the beginning of the fourth; at all events, before the Council of Nicæa (325). The APOSTOLICAL CANONS are appended to the eighth book of the Constitutions, and pretend to be likewise of apostolical origin. They consist of 85, or, in other copies, 50 brief rules for the conduct of the clergy and laity, borrowed in part from the Pastoral Epistles, partly from decrees of early councils, and partly from oral tradition. They are also found separately in Greek, Syriac, Ethiopic, and Arabic manuscripts. They were collected by some unknown hand about the middle of the fourth century. The Greek Church in 692 adopted the whole collection of 85 canons; the Latin retained only 50, which Dionysius Exiguus translated into Latin about A.D. 500.

The Apostolical Constitutions and Canons are found in the larger editions of the works of the apostolic fathers, by Cotelier and Clericus (1672, 1698, 1700, 1724), in the first volume of Mansi's, and also of Harduin's *Collection of Councils*, and have been separately edited by Guil. Ueltzen, *Constitutiones apostolicæ* (Rostochii, 1858), and by P. A. de Lagarde, *Constitutiones apostolorum* (Lips. 1862). Among the many treatises on the Apost. Const. we mention Krabbe, *Ueber den Ursprung und Inhalt der apost. Constitutionen* (1829); S. von Drey, *Neue Untersuchungen*, etc. (1832); Chase, *Constitutions of the Holy Apostles, including the Canons* (1848); comp. Hefele, *Conciliengeschichte*, i, 767 sq.; Schaff, *Church History*, i, 440 sq.; Bunsen, *Hippol.* i, 319 sq.

5. The pseudo-Clementine HOMILIES, to which the title *Clementines* (ῥὰ Κλημεντῖνα, *Clementina*) is more particularly applied, and the RECOGNITIONS (*Ἀναγνωσμοί*, *Recognitiones Clementis Rom.*), which resemble the former in form and contents. To these must be added the EPITOME DE GESTIS PETRI, which is a summary of the Homilies. The HOMILIES are twenty in number, but the last has only recently been discovered. They figure very prominently in the history of the ancient heresies. They are a most curious philoosophico-religious romance. Clement, an educated Roman, and kinsman of the emperor Domitian, dissatisfied with heathenism and thirsting after truth, travels to Judæa, meets the apostle Peter, and is converted by him to the Christian faith. He accompanies him on his missionary journeys, and takes down in writing the substance of the sermons and disputations with Simon Magus. Simon Peter is thus the proper hero of the romance, and appears as the

champion of pure, primitive Christianity, in contrast with Simon Magus, the great deceiver and arch-heretic. The apostle Paul is not mentioned, but is perhaps attacked under the name of Simon. The doctrinal system which is skilfully interwoven with this narrative stands by itself as a peculiar and confused mixture of Ebionistic and Gnostic ideas and fancies. It is a speculative form of Ebionism, rather than (as Baur treats it) a school of Gnosticism. It is essentially Judaizing in spirit and aim, though influenced by heathen philosophy. It is bitterly hostile to the theology of Paul, and forms in this respect the opposite extreme to the Gnosticism of Marcion and his school. It presents Christianity as the restoration simply of the primitive religion of Adam, Enoch, Noah, Abraham, and Moses, which was corrupted by dæmons, until Christ purged it of all false additions. The apostle Peter defended it against the new corruptions of Simon Magus. James, the brother of Christ, is made the general vicar of Christ, the pope to whom even Peter is amenable, and Jerusalem is the centre of Christendom. The *Epitome* is only a poor abridgment of the Homilies. The *Recognitiones* of Clement, in 10 books, are an orthodox recension of the Homilies, and were probably written in Rome. They exist only in a Latin translation.

The *Homilies* and *Recognitiones* are incorporated in the large editions of the apostolic fathers by Cotelier and Clericus. The former were separately edited by Schwieger, 1847 (incomplete); better by Alb. Dressel, who first discovered the 20th homily in the Vatican library (Gött. 1853); and by P. de Lagarde (Leipzig, 1865). On the system of the pseudo-Clementine Homilies, compare the works of Neander and Baur on Gnosticism, the learned monograph of Schliemann (*Die Clementinen nebst den verwandten Schriften*, Hamb. 1844), Hilgenfeld (*Die Clementinischen Recognitionen und Homilien*, Jena, 1848, and also his work on the apostolic fathers, 1858, p. 289-306), Uhlhorn (*Die Homilien und Recognitionen des Clemens Rom.*, Göttingen, 1864, and an article by the same in Herzog's *Encykl.* ii, 744), Schaff (*Church History*, i, 215 sq.), and an article of Steitz in the *Studien und Kritiken* for 1867, No. III, p. 545 sq. Dr. Steitz derives the German story of Faust from the pseudo-Clementine fiction of Simon Magus. There are some points of resemblance, but not sufficient to establish such a connection. A translation of the *Recognitiones* (by the Rev. T. Smith) is given, with an introduction on the literature, in the *Ante-Nicene Library*, vol. iii (Edinburgh, 1867).

II. A part of the canon law prepared by pope Clement V (1305-1314), and consisting of the decrees issued by the Council of Vienna (1311-1312), as well as his own constitutions. This collection was to follow the five books of decretals collected by Gregory IX in 1234, and the *liber sextus* prepared in 1298 by Boniface VIII, under the name of *Liber septimus*; it is, however, more commonly known under the name of Clementines. Like the two previous collections, it is divided into five books—*Judex*, *Judicium*, *Clerus*, *Consuetudo*, *Crimen*; and even the series of titles and the headings fully correspond with those of the collection of Gregory IX. Clement made his collection known to the consistory of cardinals in 1318, and in the following year sent it to the University of Orleans. His successor, John XXII, sent it also to the universities of Paris and Bologna. The first *glossa* (commentary) to it was written about 1326 by Joannes Andrea, and it soon obtained the authority of a *glossa ordinaria*. It was revised by cardinal Zabarella († 1417). The first editions of the Clementines were published at Mainz in 1460, 1467, and 1471. See Wetzler u. Welte, *Kirchen-Lex.* ii, 628; Hase, *Ch. Hist.* § 286. See also CANON LAW.

III. A sect whose members reject most of the forms and ceremonies of the Romish Church, but adhere to its distinguishing doctrines, such as the sacrifice of the

mass, the necessity of confession, etc. Their name is said to be derived from that of a priest, their first leader. The sect has never been numerous; but a few members, it is thought, may still (1867) be found in the Pyrenæan provinces of France. See Brown, *Encycl. Rel. Knowl.* s. v.; Eden, s. v.

Cleobians, a branch of the Simonians (q. v.), in the first century, extinguished almost at its rise.

Cle'opas (Κλεόπας, contr. for Κλεόπατρος, of a renowned father), one of the two disciples who were going to Emmaus on the day of the resurrection, when Jesus himself drew near and talked with them (Luke xxiv, 18), A. D. 29. Eusebius and Jerome (*Onomast.* s. v. Ἐμμαούς, Emmaus) make him (Κλεώπας, Cleophas) a native of Emmaus. It is a question whether this Cleopas is to be considered as identical with the CLEOPHAS (q. v.), or rather *Clopas* of John xix, 25, or the ALPHÆUS (q. v.) of Matt. x, 3, etc. Their identity was assumed by the later fathers and Church historians (Thiess, *Comment.* ii, 280 sq.). But Eusebius (*H. E.* iii, 11) writes the name of Alphæus, Joseph's brother, Clopas, not Cleopas; and Chrysostom and Theodoret, on the Epistle to the Galatians, call James the Just the son of Clopas. Besides this, Clopas, or Alphæus, is an Aramaic name, whereas Cleopas is apparently Greek. Again, as we find the wife and children of Clopas constantly with the family of Joseph at the time of our Lord's ministry, it is probable that he himself was dead before that time. On the whole, then, it seems safer to doubt the identity of Cleopas with Clopas, notwithstanding the similarity of names. (See Rus, *Harmon. evang.* III, ii, 1272 sq.; Wieseler, *Chronol. Synopsis*, p. 481; Clemens, in the *Zeitschr. f. wis. Theol.* iii, 356 sq.)

Cleop'a'tra (strictly *Cleop'atra*, Κλεοπάτρα, of a renowned father), a Greek female name occurring as early as Homer (*Il.* ix, 556), and borne especially by the Egyptian princesses after the times of Alexander (see Smith's *Dict. of Class. Biog.* s. v.). The following, being members of the line of the Ptolemies, who frequently intermarried with the Seleucids of Syria, are mentioned in the Apocrypha and Josephus, or alluded to in the Scriptures.

1. A daughter of Antiochus III (the Great), who was married to Ptolemy V (Epiphanes), B. C. 193 (see Dan. xi, 18, 16), Cæle-Syria being given as her dower (Josephus, *Ant.* xii, 4, 1; Appian, *Syr.* 5; Livy, xxxvii, 8), though Antiochus afterwards repudiated this arrangement (Polyb. xxviii, 17). See ANTIOCHUS, 2.

2. A daughter by the preceding match, who became "the wife of Ptolemy" (*Esth.* xi, 1) VI (Philometor), her own brother, on whose death (B. C. 146) she was violently persecuted by his successor (her own brother likewise, and for a time husband) Physcon, or Ptolemy VII, or Euergetes II (Justin. xxxviii, 8, 9; xxxix, 1, 2; Livy, *Ep.* 59; Diod. Sic. ii, 602, ed. Wess.). She is mentioned by Josephus as having joined her first husband in the letter addressed to Onias (q. v.) in favor of reconstructing the Jewish temple at Leontopolis (*Ant.* xiii, 3, 2), and as befriending in her distress by Onias (*Apion*, ii, 5). See PROLEMY PHILOMETOR.

3. A daughter of the preceding by her first husband; married first (B. C. 150) to Alexander (q. v.) Balas, the Syrian usurper (1 Macc. x, 58; Josephus, *Ant.* xiii, 4, 1 and 5), and on his death (B. C. 146) to Demetrius (q. v.) Nicator (1 Macc. xi, 12; Josephus, *Ant.* xiii, 4, 7). During the captivity of the latter in Parthia, B. C. 141 (1 Macc. xiv, 1 sq.), she married his brother Antiochus (Josephus, *Ant.* xiii, 7, 1) VII (Sidetes), out of jealousy on account of Demetrius's connection with the Parthian princess Rhodogune, and also murdered Demetrius on his return (Appian, *Syr.* 68; Livy, *Ep.* 60), although Josephus (*Ant.* xiii, 9, 8) and Justin

(cxxxix, 1) represent her as only refusing to receive him. She also murdered Seleucus, her son by Nicator, who on his father's death assumed the government without her consent (Appian, *Syr.* 69). Her other son by Nicator, Antiochus VIII (Grypus), succeeded to the



Coin of Cleopatra and her son Antiochus Grypus.

throne (B. C. 125) through her influence; but afterwards, finding him not disposed to yield her all the power she desired, she attempted to poison him, but was anticipated by him, and compelled to drink the poison herself (Justin, xxxix, 2), B. C. 120. See ANTIOCHUS, 6 and 7.

4. A sister of the preceding, and the rival of her own mother (No. 2) in the affections of Ptolemy Physcon, by whose will she was left in supreme power, in connection with whichever of her own sons she might choose. She was compelled by her people to set up the eldest, Ptolemy VIII (Lathyrus); but she soon prevailed upon them to expel him, and make room for her younger and favorite son Alexander (Pausan. viii, 7), and she even sent an army against Lathyrus to Cyprus, an effort in which the Jews became involved (Josephus, *Ant.* xiii, 12, 2 sq.; 13, 1) through the intervention of Alexander Jannæus (q. v.). Her son Alexander retired through fear of her cruelty, but was recalled by his mother, who attempted to assassinate him, but was herself put to death (B. C. 89) before she could effect her object (Justin, xxxix, 4). See PROLEMY LATHYRUS.

5. The second daughter of the name by the preceding marriage, and married to her own brother Lathyrus after her sister's divorce, from whom she is usually distinguished by the surname of *Selenè* (Σελήνη, the moon). After his exile she married Antiochus XI (Epiphanes), and on his death Antiochus X (Eusebes). She was besieged by Tigranes in Syria or Mesopotamia, and either taken and killed by him (Strabo, xxi, p. 749), or, according to Josephus (*Ant.* xiii, 16, 4; comp. *War.* i, 5, 8), relieved by Lucullus's invasion of Armenia. See ANTIOCHUS, 9 and 10.

6. The last queen of Egypt, was the daughter of Ptolemy Auletes, born B. C. 69, and celebrated for her beauty and accomplishments, as also for her voluptuousness and ambition. She had various amorous and political intrigues, first with Julius Cæsar (Dion Cass. xliii, 27; Sueton. *Cæs.* 85), whom she even accompanied to Rome; and finally with Marc Antony (q. v.), who became so completely enamored of her as to commit suicide when falsely informed of her death, which she presently actually accomplished, it is said by causing herself to be bitten by an asp, on the capture of Alexandria by Octavianus, afterwards called Augustus, B. C. 30 (see Liddell's *Hist. of Rome*, chap. lxx).

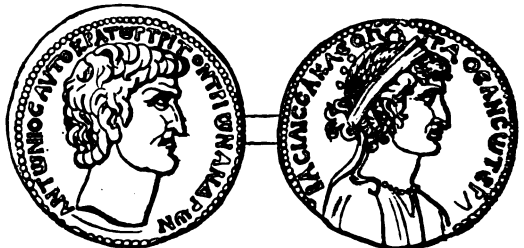

Coin of Antony and Cleopatra.

Josephus often refers to her profligate conduct (see *Ant.* xiv, 18, 1) as well as her artful cruelty (*Ant.* xv, 3, 5 and 8; *War.* i, 19, 1), and narrates her unsuccessful attempt to draw even Herod into an amour (*Ant.* xv, 4).

7. One of Herod's wives, a native of Jerusalem, and mother of his sons Herod and Philip (Josephus, *Ant.* xvii, 1, 8; *War.* i, 28, 4).

8. The wife of Gessius Florus, procurator of Judæa; she was a favorite with Nero's wife (Josephus, *Ant.* xx, 11, 1).

Cle'ôphas, or rather **CLOPAS** (Κλωπάς), the husband of Mary (q. v.), the sister of Christ's mother (John xix, 25); probably a Grecized form of the name elsewhere (Matt. x, 3; Mark iii, 18; Luke vi, 16; Acts i, 13; comp. Mark xv, 40) called ALPHÆUS (q. v.), perhaps in imitation of the name *Cleopas* (q. v.). See the *Theol. Stud. u. Krit.* 1840, iii, 648.

Clerc, Le (CLERICUS), **JEAN**, a learned critic and theologian, was born at Geneva March 19, 1657. He studied theology at his native town, and in 1679 passed a brilliant examination for admission into the ministry of Geneva, but had before this fallen out with strict Calvinism, chiefly under the influence of the Saumur theses (*Synagma thesium theol. Salmurii*, 1656), and the writings of his grand-uncle Curcellæus and of Episcopius. As early as 1679 he published a pseudonymous work on the difference between strict Calvinists and Remonstrants, in favor of the latter (*Liberii de sancto amore epistola theologica*, Saumur, 1679). In 1682 he openly joined the Remonstrants, and in 1684 the Rotterdam Synod gave to him the professorship of philosophy and ancient languages at the Arminian college of Amsterdam. Here he at once began to exhibit his marvellous literary activity. After publishing some exegetical treatises of his uncle David le Clerc, and his father Stephen le Clerc, and a dogmatical treatise on predestination, and the nature and limits of human knowledge (*Entretiens sur diverses matières de théologie*, Amsterdam, 1685), he attracted general attention by his literary controversy with the learned oratorian Richard Simon (*Origines Adamantino Critobulus Hieropolitanus*, 1684, pseudonym.; *Sentimens sur l'hist. critique du V. T. composée par le P. R. Simon*, Amsterdam, 1685, and *Défence des Sentimens*, etc. Amsterdam, 1685). In the same year he established with F. Cornand de la Croze a literary journal, under the title *Bibliothèque universelle et historique*, which, besides reviews and extracts from new books, contains many essays by Le Clerc (25 vols. 1686-1693). He also took an active part in the publication of the four editions of Moreri's *Dictionnaire* (4 vols. fol. 1691-1702). He defended Episcopius against the charge of Socinianism (*Lettre à M. Jurieu sur la manière dont il a traité Episcopius*, 1690), and translated three works of Burnet into French, and part of the history of ancient philosophy by Th. Stanley into Latin. From 1692-1695 he wrote several compends of philosophy (*Opera philosophica*, 4 vols. 1698; later editions contain a 5th volume, with a life of the author). In 1698 he began the publication of his Latin translation of and commentary on the Old Testament (Genesis, 1693; the four last books of the Pentateuch, 1696; the other historical books, 1708; the remainder, 1781), in which he developed some latitudinarian views on Biblical miracles and scriptural interpretation. In 1696 he published his *Ara Critica* (2 vols. Amsterd.), one of his most important works, of which the *Epistole Criticæ et Ecclesiasticæ* (1700, against Cave) are a continuation. He translated into Latin and added valuable notes to Hammond's New Testament (1698, 2 vols. fol.; 2d edit. Frankfort, 1714), and in the same year published a new edition of the *Patres Apostolici* by Cotelier, with notes and additions (Amsterd. 1698; 2d ed. 1724). A work against some anti-Christian views in Bayle's *Dictionary* (*Parrhasiana*, Amsterd. 1699) in-

volved him in a controversy with Bayle which lasted until the death of the latter. He prepared an appendix to the Amsterdam reprint of the Maurine edition of the works of St. Augustine (*Appendix Augustiniana*, Amsterd. 1708); published a French translation of the New Test. (Amsterd. 1708, 2 vols.), with notes, which again brought him into the suspicion of Socinianism, and published new editions, with notes, of Petavius, *De theologicis dogmatibus* (6 vols. fol. Amsterd. 1700), and *doctrina temporum* (Amsterd. 1708, 3 vols. fol.), of the complete works of Erasmus of Rotterdam (Lugd. Bat. 10 vols. fol. 1703-6), of Hugo Grotius, *De Veritate Religionis Christianæ* (Amsterd. 1709), and of many others. He also continued his literary journal under the title *Bibliothèque choisie* (1708-18, 27 vols.). In 1712, on the death of Limborch, he was appointed his successor as professor of Church History at the college of Amsterdam. His new office induced him to write a Church History of the first two centuries (*Hist. Eccles. duorum prim. sæc.*, Amsterd. 1716). He also prepared several editions of Latin and Greek classics, a history of the Netherlands, and carried on a very extensive correspondence with scholars in various countries. In 1728 he suddenly lost, in consequence of a paralytic stroke, the use of language, and, to a large extent, his memory, and his condition became still worse after a new attack in 1782. He died January 8, 1786. Le Clerc was one of the most prolific writers of modern times, but more critical than productive. Though always in ecclesiastical communion with the Remonstrants, he undoubtedly leaned towards Socinianism.—See Wetzter u. Welte, *Kirchen-Lex.* ii, 680 sq.; Herzog, *Real-Encyclop.* ii, 756; Ersch u. Gruber, *Encyclop.* vol. xviii, s. v.

Clerestory. See CLEAR-STORY.

Clergy, the general name given to those who are set apart by ordination (q. v.) for the performance of Christian worship and teaching, and who are therefore said to be in orders (q. v.).

1. *Origin and Meaning of the Word.*—The word is by some supposed to be derived from κληρος (*lot*), as if the minister were, in a special sense, κληρος του Θεου, specially consecrated to God. Others (Augustine, *Expos. in Ps.* 67; Isidor, *De Off. Eccles.* ii, c. i) maintain that it indicates that the lot by which Matthias was chosen apostle gave the first general name for the chiefs of the Church as a class. Jerome says they were called clergy, either because they were chosen by lot to be the Lord's, or because the Lord is their lot or heritage (Deut. xviii, 2). More recently both these derivations have been abandoned, and one proposed by Baur (*Ursprung des Episcopatu*, p. 98 sq.; *D. Christenthum u. die christl. Kirche der drei ersten Jahrhund.* p. 245) and by Ritschl (*Entsteh. der altkath. Kirche*, p. 245) has met with general favor. According to it, the word κληρος is in the N. T. (Acts i, 17, 25; 1 Pet. v, 3), as well as in the language of the ancient Church, commonly used in the signification of "rank," "degree." The "faithful" (*fideles*) and catechumens were called κληροι (ordines, ranks), just as well as bishops, presbyters, deacons. Gradually—the exact point of time cannot be fixed—the ecclesiastical officers were exclusively called "the rank," κληρος, a transition which was very natural in the difference between the officers of the Church and the bulk of the people was emphasized. The earliest writer in which the name "clergy" (κληρος) in the restricted sense occurs is Clement of Alexandria. "It is clear from the N. T. that there were men separated to the work of the Christian ministry. Some of these appear to have been extraordinary, such as apostles, who had been selected by Christ himself without any intermediate authority; evangelists, such as Timothy and Titus; prophets. See 1 Cor. xiv, 3, 22-24. These probably continued only during the lifetime of the apostles and those on whom they laid hands. Others were ordinary ministers, denominated elders or

presbyters, pastors, bishops, and teachers. See 1 Pet. v, 1-4; Acts xiv, 28; xv, 6; Titus i, 5. These were divinely called and appointed to their work (Acts xx, 28); they were solemnly set apart; they were entitled to be supported by the churches to whom they ministered; their duties were to feed the flock, to take care of and govern the Church of God, and to watch for souls (1 Thes. v, 12, 13; Heb. xiii, 7, 17)" (Coleman, *Christian Antiquities*, ch. iii).

2. *Distinction of Clergy and Laity.*—In the apostolical Church no abstract distinction of clergy and laity, as to privilege or sanctity, was known; and all believers were called to the prophetic, priestly, and kingly offices in Christ (1 Pet. v, 3). The Jewish antithesis of clergy and laity was at first unknown among Christians; and it was "only as men fell back from the evangelical to the Jewish point of view" that the idea of the general Christian priesthood of all believers gave place, more or less completely, to that of the special priesthood or clergy (Neander, *Church History*, Torrey's ed., i, 194 sq.; Schaff, *History of the Christian Church*, i, ch. v; Gieseler, *Church History*, i, § 52). So Tertullian, even (*De Baptismo*, c. 17, before he became a Montanist): "The laity have also the right to administer the sacraments and to teach in the community. The Word of God and the sacraments were by the grace of God communicated to all, and may therefore be communicated by all Christians as instruments of the divine grace. But the question here relates not barely to what is permitted in general, but also to what is expedient under existing circumstances. We may here use the words of St. Paul, 'All things are lawful for men, but all things are not expedient.' If we look at the order necessary to be maintained in the Church, the laity are therefore to exercise their priestly right of administering the sacraments only when the time and circumstances require it." From the time of Cyprian († 258), the father of the hierarchical system, the distinction of clergy and laity became prominent, and very soon was universally admitted. Indeed, from the third century onward, the term *clerus* (κληρος, *ordo*) was almost exclusively applied to the ministry to distinguish it from the laity. As the Roman hierarchy was developed, the clergy came to be not merely a distinct order (which might consist with all the apostolical regulations and doctrines), but also to be recognised as the only priesthood, and the essential means of communication between man and God (Vinet, *Past. Theol.* Introd.).

3. *Classification.*—Simultaneously with the introduction into the Church of a distinction between clergy and laity, a division of the clergy into classes of different rank was gradually developed. The earliest and most important of those distinctions was that between bishop and presbyter (see BISHOP). To these were added, in the course of time, deacon, subdeacon, archbishop, primate, patriarch, pope, and a number of officers preceding the subdiaconate. Each class was initiated into office by a special ordination (see ORDERS). In general, the various classes, according to the higher and lower dignity of the orders, were divided into the *higher* and *lower* clergy, the latter embracing the *ostiarii*, *lectores*, *exorcista*, and *acolythi*, the former the subdeacons, deacons, priests, bishops. Up to the 13th century the subdeacons were counted among the lower clergy. The canon law very frequently applies the name *clerici* exclusively to the lower classes of the clergy, designating each higher class (subdeacons, deacons, priests, bishops) by its special name. *Higher* (or *high*) clergy is commonly understood to mean bishops or prelates (q. v.), and *lower* (or *low*) clergy the others.

In those churches which have monastic institutions, the clergy are also divided into *regular* and *secular* clergy, regular being members of orders and congregations who bind themselves to common rules, and secular those who have charge of parishes. In the Church

of Russia the common name of the regular clergy is the *black* clergy, out of which the higher ecclesiastical dignitaries are chosen, while the secular clergy (priests, deacons, readers, and sacristans) are called *white* clergy.

4. *Exemptions and Privileges.*—"By laws made by Constantine, and confirmed by Valentinian IV, Gratian, and Theodosius the Great, the clergy were exempted, (1.) From all civil and municipal offices, that they might give themselves to their religious duties. (2.) From contributions to public works. (3.) From a variety of taxes and imposts. (4.) From military service, though this is not stated in so many words. (5.) From appearance in civil courts. A bishop could not be forced to give public testimony; but it might be taken in private, though the bishop was not obliged to take formal oath, but only had the Gospels before him. Scourging and torture, which might be applied to other witnesses, could not be inflicted on the clergy. Nor could the civil courts take cognizance of purely ecclesiastical causes (Theodos. *Cod.*, lib. xvi, tit. 2, leg. 23; Justinian, *Novel.* 88), though they could interfere in criminal matters, and in cases between a clergyman and a layman; for the layman was not bound to obey an ecclesiastical tribunal. Bishops were often arbiters in disputes, but only when both parties agreed to lay the matter before them, and then the episcopal sentence could be put in force by the civil power. In cases of life and death, clerical intervention was strictly prohibited."

The privileges which the clergy enjoyed under the ancient municipal laws of England were numerous: but being much abused by the popish clergy, they were greatly curtailed at the Reformation. "Those which now remain are personal, such as clergymen not being compelled to serve on juries, or to appear at the sheriff's, or consequently at the court-leet, or view of frankpledge. Clergymen are exempt also from temporal offices, in regard to their continual attendance on their sacred functions. While attending divine service they are privileged from arrest in civil suit stat. 50 Edward III, chap. v, and 1 Richard II, ch. xv. It has been adjudged that this extends to the going to, continuing at, and returning from celebrating divine service. The ecclesiastical goods of a clergyman cannot be levied by the sheriff; but on his making his return to the writ of *ferri facias*, that the party is a clergyman *beneficed*, having no lay-fee, then the subsequent process must be directed to the bishop of the diocese, who, by virtue thereof, sequesters the same. So in an action against a person in holy orders, where in a *capias* lies to take his person, on the sheriff's making the same return, further process must issue to the bishop, to compel him to appear; it is otherwise, however, unless the clergyman is *beneficed*. In cases of felony, benefit of clergy is extended to them without being branded, and they are entitled to it more than once. Clergymen labor also under certain disabilities, such as not being capable of sitting as members in the House of Commons. This, however, though a received opinion, was not restricted by law till so late as the 41 George III, chap. lxi, which was passed in consequence of John Horne Tooke, then in deacon's orders, being returned, and sitting in Parliament for Old Sarum. It was then enacted that no priest, nor deacon, nor minister of the Scotch Church, shall be capable of serving in Parliament; that their election shall be void, and themselves liable to a penalty of £500 a day in the event of their either sitting or voting. It would seem, therefore, as in the case of the bishop of Exeter against Shore, that no one can denude himself of holy orders. Various acts of Parliament have also, from the time of Henry VIII, been passed to prevent clergymen from engaging in trade, holding farms, keeping tan or brew houses, all of which are stated, explained, and consolidated by the 57 George III, ch. xcix" (Radie, *Eccles. Dict.* s. v.). For a peculiar privilege, see CLERGY, BENEFIT OF.

In the 4th century it became a law that clergymen were to bring suits only in ecclesiastical courts (i. e. before bishops or synods). Justinian ordained that even laymen should bring suit against clergymen, monks, and nuns only before the bishop of the diocese, and against a bishop only before his metropolitan. Thus the privileged jurisdiction of the clergy came to be a general law, which was sanctioned and more fully defined by many imperial and canonical decrees, and which no individual member had a right to renounce. The privileged jurisdiction referred, however, to personal suits only, not to real and feudal (see Wetzer u. Welte, *Kirchen-Lexikon*, iv, 460, s. v. Gerichtsbarkeit, Geistliche).

A peculiar privilege of the clergy of the Roman Church is the one called *privilegium canonis*. It consists in a canonical provision that every one who inflicts upon a clergyman (including monks and nuns) a bodily injury (embracing spitting, kicking, etc.), incurs by the fact itself excommunication. It was first enacted by the Council of Rheims in 1181 (in the canon which begins *Siquis suadente diabolo clericum percusserit*; "if any one, at the instigation of the devil, shall strike a clergyman"), and was made a general Church law in 1189 by Innocent II. It provided that absolution from the excommunication thus incurred should only be given in the hour of death, or if the culprit shall personally go to Rome. The law still exists, but if the injury be a small one, the bishop may dispense from the Roman journey (see Wetzer u. Welte, *Kirchen-Lex.* viii, 782, s. v. *Privilegium Canonis*).

5. *Special Discipline, Duties, Disabilities.*—“In the early Church the clergy were placed under strict discipline. The crimes leading to punishment were simony, heresy, apostasy, neglect of duty, immorality, and violation of clerical etiquette. Punishments were various: (1.) *Corporeal castigation*, which Augustine speaks of as not unfrequent, the delinquent being first deprived of his clerical rank, and then scourged as a layman. *Deconica*, or prisons, were attached to many churches. (2.) *Degradation*—that is, the offender was put down to a lower rank or grade of office, and that to all appearance permanently. (3.) *Suspension*—either a *beneficio*, from his income, or *ab officio*, from his office. (4.) *Deprivation*—either forbidden from the Lord's Supper altogether, and treated as a stranger (*communio peregrina*), or allowed to communicate only with the laity (*communio laica*). (5.) *Excommunication*—the final cutting off of the offender from clerical office, and the denial of all hope of restoration to it, even though he should be restored to the fellowship of the Church. We subjoin a few of the more characteristic of the ancient canons concerning the clergy, as showing the spirit of the age, and revealing some of its tendencies and usages: Thus, in the Apostolical Canons, '5. Let not a bishop, presbyter, or deacon turn away his wife, under pretence of religion; if he do, let him be suspended from the communion (*ἀφορίζεσθω*), and deposed (*καταργεσθω*) if he persist. 6. Let not a bishop, presbyter, or deacon undertake any secular employ, upon pain of deposition. 17. He who, after his being baptized, has been involved in two marriages, or has kept a concubine, cannot be a bishop, or a presbyter, or a deacon, or at all belong to the sacerdotal catalogue. 18. He that marries a widow, or one that is divorced, or a harlot, or a servant, or an actress, cannot be a bishop, or a presbyter, or a deacon, or at all belong to the sacerdotal catalogue. 19. He that marries two sisters, or his niece, cannot be a clergyman. 20. Let the clergyman who gives security for any one be deposed. 51. If any bishop, presbyter, deacon, or any of the sacerdotal catalogue, do abstain from marriage, and flesh, and wine, not for mortification, but out of abhorrence, as having forgotten that all things are very good, and that God made man male and female, and blasphemously reproaching the workmanship of

God, let him amend, or else be deposed, and cast out of the Church; and so also shall a layman.' In the Canons of Laodicea, '54. That they of the priesthood and clergy ought not to gaze on fine shows at weddings or other feasts; but before the masquerades enter, to rise up and retreat. 55. That they of the priesthood and clergy, or even laity, ought not to club together for great eating and drinking bouts.' The duties of the various ranks of the clergy were strictly defined, and firm laws laid down for their guidance. They were not allowed to leave their station without permission, but were to reside in their cure, deserters being condemned by a law of Justinian to forfeit their estates; but they could resign in certain circumstances, and a retiring or canonical pension was sometimes granted. They could not remove from one diocese to another without letters dimissory, nor could they possess pluralities, or hold office in two dioceses. It was forbidden them to engage in secular employments, or attend fairs and markets, nor could they become pleaders in courts of law. They were expected to lead a studious life, their principal book being the Scriptures, while heathen and heretical treatises were only allowed them as occasion served. Bishops could not be 'tutors and governors,' but the inferior clergy might, under certain limitations. After the example of Paul, some of the lower clergy might support themselves, or fill up their leisure by some secular occupation. Severe laws were passed against what are called wandering clergy—*vacantini*, who appear to have been often fugitives from discipline, without character or certificate. If a clergyman died without heirs, his estates fell to the Church, so the Council of Agde in 500 ruled. By a law of Theodosius and Valentinian III, the goods of any of the clergy dying intestate went in the same way" (Eadie, s. v.).

6. *Election of the Clergy.*—"Some assume that in the early Church the people had no other power than to give their testimonials to the persons elected, or to make exceptions, if they had any just and reasonable objections to urge; others say that the people were absolute and proper electors, and this from apostolical right, and that they enjoyed this for a succession of ages. That the people had a voice in the elections is evident from several circumstances. No bishop could be intruded upon a Church against the consent of the members: in case the majority of a Church consisted of heretics or schismatics, the practice differed. In many instances recorded in ecclesiastical history the voices of the people prevailed against the bishops themselves. In addition, we have the words used by the people in the decision, such as *ἀξιός* or *ἀνάξιός*, *ἀγνός* or *ἀδύστος*; and instances in which persons were brought by force to the bishop to be ordained, or were elected to the office by acclamation. It was decided by the fourth Council of Carthage that as the bishop might not elect clerks without the advice of his clergy, so likewise he should secure the consent, co-operation, and testimony of the people. The popular elections, however, became scenes of great disorder and abuse. A remarkable passage from Chrysostom (*De Sacerd.*) has been frequently quoted, and applies more or less to such elections, not only in Constantinople, but also in Rome, Alexandria, Antioch, and other large cities. He says: 'Go and witness the proceedings at our public festivals, in which, more especially, according to established rule, the elections of ecclesiastical officers take place. You will find there complaints raised against the minister as numerous and as various in their character as the multitude of those who are the subject of church-government. For all those in whom the right of election is vested split into factions. It is evident that there is no good understanding, either among themselves, or with the appointed president, or with the presbytery. One supports one man, and one another. And the reason of this is, that they all neglect to look at that point which

they ought to consider, namely, the intellectual and moral qualifications of the person to be elected. There are other points by which their choice is determined. One, for instance, says, "It is necessary to elect a person who is of a good family." Another would choose a wealthy person, because he would not require to be supported out of the revenues of the Church. A third votes for a person who has come over from some opposite party. A fourth uses his influence in favor of a relative or friend. While another lends his influence to one who has won upon him by fair speeches and plausible pretensions.' In order to set aside these abuses, some bishops claimed an exclusive right of appointing to spiritual offices. In this way they gave offence to the people. In the Latin and African churches an attempt was made to secure greater simplicity in elections by introducing *visitors*. This did not, however, long continue. Another plan was to vest the election in members of the lay aristocracy. But the determining who these should be was left to caprice or accident; and the result was that the right of election was taken out of the hands of the people, and vested partly in the hands of the ruling powers and partly with the clergy, who exercised their right either by the bishops, their suffragans and vicars, or by collegiate meetings, and this very often without paying any regard to the Church or diocese immediately concerned. Sometimes the extraordinary mode of a bishop's designating his successor was adopted; or some one unconnected with the diocese, to whom a doubtful case had been referred for decision, was allowed to nominate. But in these cases the consent of the people was presupposed. Patronage has prevailed since the fifth century; but the complete development of this system was a work of the eighth and ninth centuries" (see PATRONAGE).—Coleman, *Christian Antiquities*, ch. iii.; Farrar, *Eccles. Dictionary*, s. v. Election; Bingham, *Orig. Eccles.* bk. iv, chap. ii.; Henry, *Ch. Antig.* bk. ii, ch. i.; Wetzer u. Welte, *Kirchen-Lex.* i, 630; Herzog, *Real-Encyclop.* s. v. Geistliche. See ECCLESIASTICAL POLITY.

CLERGY, BENEFIT OF, an ancient privilege whereby the persons of clergymen were exempted from criminal process before the secular judges in particular cases, and consecrated places were exempted from criminal arrests. See SANCTUARY. "This privilege was originally confined to those who had the *habitus et tonsuram clericalem*, but in time every one was accounted a clerk who could read; so that after the dissemination of learning by the invention of printing, it was found that as many laymen as divines were admitted to this privilege, and therefore the stat. 4 Henry VII, ch. xiii, distinguishes between lay scholars and clerks in holy orders, and directs that the former should not claim this privilege more than once, and, in order to their being afterwards known, they should be marked with a letter, according to their offence, on the brawn of the left thumb. After this burning, the laity, and before it the real clergy, were discharged from the sentence of the law in the king's court, and delivered over to the ordinary for canonical purgation. This purgation, having given rise to various abuses and prostitution of oaths, was abolished at the Reformation; and accordingly by the stat. 18 Elizabeth, ch. vii, it was enacted that every person having benefit of clergy should not be delivered over to the ordinary, but after burning in the hand should be delivered out of prison, unless the judge thought it expedient to detain him there for a limited period. It will be collected from the above statement that the parties entitled to this privilege are clerks in holy orders, without branding, or any of the punishments subsequently introduced in its place; lords of Parliament, peers, and peeresses for the first offence; commoners not in orders, whether male or female, for clergyable felonies, upon being burnt in the hand, whipped, fined, imprisoned, or transported. It is a privilege peculiar

to the clergy that sentence of death cannot be passed upon them for any number of clergyable offences committed by them (Blackstone, *Comm.* iv, 374).—Radie, *Eccles. Dict.* s. v.

Clerici REGULARES et SECULARES. See CANONS and REGULARS.

Clericus. See CLERIC, LE.

Clerk (Acts xix, 35). See TOWN-CLERK.

CLERK, originally and properly the name for one of the clergy (q. v.), and still the common appellation by which clergymen of the Church of England distinguish themselves in signing any legal instrument. It came afterwards, by an obvious transition, to signify a "learned man." Its most usual application in England is to that officer, now a layman, but once, in all probability, an ordained functionary, who leads the responses of the congregation. Properly speaking, in the Church of England, the clerk is not an original functionary of the congregation in the eye of the Church, which, in her rubrics, speaks mostly, if not always, of "clerks" (ordained persons); and it is certain that several duties are by custom yielded to the clerk which properly belong to the clergyman, such as the giving out of the Psalms to be sung, and the publication of notices. (See Rubric after Nicene Creed.) The appointment of parish clerks properly belongs to the incumbent. They should be licensed by the ordinary, and take an oath to obey the minister, with whom properly rests the power of removing the clerk from his office, though if he be displaced without sufficient cause a "mandamus" may restore him. By the Church Temporalities' Act for Ireland, the parish clerk is removable for any misconduct, by the minister with the consent of the bishop.—Hook, *Church Dictionary*, s. v.

CLERKS, APOSTOLICAL. See JESUITS.

CLERKS, MINOR. See FRANCISCANS.

CLERKS OF ST. MAJOLUS, a religious order of the sixteenth century in Italy, founded by Jerome Emilianus, and approved by Paul IV. They gave themselves to the religious instruction of the young and the ignorant.

CLERKS OF ST. PAUL. See BARNABITES.

CLERKS, REGULAR. See CANONS and REGULARS.

CLERKS, THEATRINE. See THEATRINES.

Clermont, a city of Auvergne, France, where a council was held in 1095 and 1096, confirming the councils of Pope Urban. A crusade was also recommended, and King Philip excommunicated. The council was attended by 4 archbishops, 225 bishops, and an immense number of lower clergy and laity.

CLERMONT MANUSCRIPT (CODEX CLERMONTANUS, known as Cod. D of the Pauline Epistles, No. 107 of the Imperial Library at Paris), an uncial MS., with the Greek and Latin on opposite pages, containing Paul's fourteen epistles, with a few histas, most of which have been supplied at various dates. The Epistle to the Colossians stands before that to the Philippians, and Hebrews after the Pastoral Epistles. The MS. is stichometrically arranged, with twenty-one lines on almost every page. The citations from the O. T. are written in red, except in Hebrews. It seems to belong to the sixth century. It probably came from a Latin scribe, with a Greek copy. The original writer made several alterations, then the whole of the Greek text was corrected (apparently in the seventh century) by the first reviser. Two others (in different handwriting) made a few changes, one of them only in the Greek text. But the fourth corrector went over the whole text, adding the breathings and accents, and erasing whatever displeased him. Besides these there are occasional alterations and restorations by later hands.

Beza says that he procured this MS. from Clermont, in the diocese of Beauvais (whence its name), a state-

ΜΗ ΑΙΧΡΟΚΕΡΑΗ ΜΟΝΤΥΡΙΟΥΡΟΝ
 ΑΛΛΑ ΦΙΛΟΣΕΝΟΝ ΣΕΔΗΟΣΠΙΤΑΙΕΜ
 ΦΙΛΑΓΛΘΟΝΣΩΦΡΟΝΑ ΒΕΝΙΣΗΜΟΣΟΒΡΙΟΝ
 ΔΙΚΑΙΟΝΟΪΟΝ ΙΟΥΣΤΩΜΣΑΝΚΤΟΝ
 ΕΗΚΡΑΘΗ ΚΟΝΤΙΝΕΝΤΕΜ
 ΑΝΤΕΧΟΜΕΝΟΝ ΑΔΡΕΚΤΕΝΤΕΜ

Specimen of the Codex Clermontanus (Tit. i, 8, 9: μὴ αἰχροκεραὶ | ἀλλὰ φιλόσενον | φιλαγθόνσωφρονα | δίκαιονόιον | ἐηκραθῆ | ἀντεχόμενον || non turpiterum | sed hospitalem | benignum sobrium | iustum sanctum | continentem | adrectentem).

ment which Wetstein unnecessarily impugns. After Beza's death, it passed into the library of the brothers Jacques and Pierre du Puy, the former of whom being librarian to the king of France, and dying in 1656, it was purchased and deposited in the Royal Library at Paris. In the early part of the eighteenth century, 35 leaves were cut out of this MS. by John Aymon, an apostate priest, who sold one of them to Stoech in Holland, and the others fell into the hands of the bibliographical Earl of Oxford. Both these purchasers, on learning the theft, restored the leaves to their proper place.

Beza made some use of this document; Walton's

Polyglott inserted 2245 readings sent by the Du Puy to Usher (Mill, *N. T. proleg.* § 1284); Wetstein collated it twice (1715-16); Tregelles examined it in 1849; and Tischendorf published the text entire in 1852. It is one of the most valuable in sacred criticism.—Scrivener, *Introd. to N. T.* p. 180 sq. See **MANUSCRIPTS, BIBLICAL.**

Cletus, the name of one said to have been a bishop of Rome in the first century, but whether the same with Anacletus or not, and what his position in the order of succession, are points wholly unsettled.—Migne, s. v. Anaclet.; Wetzer u. Welte, *Kirchen-Lex.* ii, 625; Herzog, *Real-Encyk.* ii, 157; Gieseler, *Ch. Hist.* per. i, div. i, ch. iii, § 84, n. 10. See **ANACLETUS.**

Clift. See **CLEFT.**

Climacus, JOHN. See **JOHN CLIMACUS.**

Climate. See **PALESTINE.**

Clinic BAPTISM. Baptism on a sick-bed was so called, from κλίνη, a bed, and was allowed in the case of one already a candidate for baptism whose life was endangered; but if he recovered, he was not held eligible to orders. The first instance of clinic baptism is found in a letter from the Roman bishop Cornelius (about 250) to Bishop Fabius at Antioch, in which it is stated that "when Novatian, who had only received the *baptismus clinicorum*, and without a subsequent imposition of hands by the bishop, had been ordained priest by a predecessor of Cornelius, the whole clergy and the people had protested on the ground that it was not permitted to ordain any one a clergyman who, like him (Novatian), had received baptism only upon the sick-bed; that, however, the bishop had asked to allow an exception in this case" (Euseb. *Hist. Eccl.* i, 648). The same principle was expressed in 814 by the Synod of Neocaesarea, and reasserted by a Paris synod in 829. Bishop Cornelius, in the letter above referred to, even hesitated to consider a clinic baptism as valid and efficient; "if," he says, "of such a one (*climicus*), it can be said at all that he has received baptism." Similar doubts were expressed by others; but, on the other hand, Cyprian strongly insisted that a clinic baptism was just as valid and efficient as any other (*Epist.* 76). Wetzer u. Welte, *Kirch.-Lex.* ii, 686; Herzog, *Suppl.* ii, 595; Bergier, s. v. Cliniques; Bingham, *Orig. Eccl.* b. xi, ch. ii, § 5; Moehm, *Commentaries*, cent. iii, § 15.

Clitus (Κλίτρος), a rash young man, who was compelled by Josephus, when commander in Galilee, to cut off one of his own hands, as a punishment for exciting a revolt in Tiberias (Joseph. *Life*, § 84; *War*, ii, 21, 10).

Cloak (כַּיִת, *meit'*, Isa. lix, 17, elsewhere rendered in our version "robe," or "mantle") was an upper garment or robe (of cotton?), which extended below the knees, open at the top, so as to be drawn over the head, and having arm-holes. It was worn by the high-priest under the ephod (Exod. xxviii, 81); also by kings and persons of distinction (1 Sam. xv, 27; Job i, 20; ii, 12), and by women (2 Sam. xiii, 18). See **APPAREL.**

So, in the New Testament, the word *himation*, rendered "cloak" in Matt. v, 40, is in its plural form taken for garments in general in other places (Matt. xvii, 2; xxvi, 65; Acts vii, 58; ix, 89). The cloak, or *palium* (Acts ix, 89), was the outer garment (different from the "coat" or *tunic*, χιτών), and it seems to have been a large piece of woollen cloth nearly square, which was wrapped round the body, or fastened about the shoulders, and served also to wrap the wearer in at night. It might not be taken by a creditor (Exod. xxii, 26, 27), though the tunic could (Matt. v, 40), which fact gives peculiar force to the injunction of our Lord. See **CLOTHING.**

The *φελώνης*, rendered "cloak" in 2 Tim. iv, 18, was the Roman *pænula*, a thick upper garment, used chief-

ly in travelling, instead of the toga, as a protection from the weather. It seems to have been a long cloak without sleeves, with only an opening for the head. Others suppose it to have been a travelling-bag or portmanteau for books, etc. Discussions de *palo Pauli* have been written by Brenner (Gloss. 1784), Heinse (Viteb. 1697), Lakemacher (Helmst. 1722), Rusmeier (Gryph. 1781), Vechner (s. l. 1678). See DRESS, etc.

Clod, אִשָּׁה, *gush*, or אִשָּׁה, *gish*, Job vii, 5, a lump of earth; מִגְרָפָה, *megraphah*, Joel i, 17, a spadeful of earth; מַגָּב, *re'gab*, Job xxi, 38; xxxviii, 38, a mass of earth; מַדָּד, *sadad*, "to break clods," Isa. xxviii, 24; Hos. x, 11; to "harrow," Job xxxix, 10, prop. to level the ploughed field. See AGRICULTURE.

Cloister (Lat. *claustrum*, an enclosure). This term is often applied to a *monastery* (q. v.). It was originally applied to the porch of the *atrium* or *paradise* (q. v.) of a church [see plan of ancient church under CHURCH EDIFICES], in which interments were made before it became usual to bury in the church itself. The term *cloister* is now more usually used in English to indicate the arcade surrounding the court enclosed by the buildings of a monastic establishment. This enclosed space was generally a garden, ornamented with a fountain and shrubbery, but it often served also as a burial-place for leading members of the brotherhood. The arcade (or cloister), in the first, or first and second stories of the buildings facing the court, served, especially during bad weather, for processions, and as a promenade for the monks while saying prayers, meditating, or studying, and for health, recreation, and conversation. In the Benedictine monasteries there was read in the cloisters each day a portion of the regulations of the order, and the entire body of the regulations before the assembled brotherhood four times a year. Stone seats were usually placed before the windows, and cells or stalls for study set into the wall of the building, off from the cloister. Relics and other objects of worship were sometimes placed in the cloister or the court. The cloisters had often great architectural beauty, and some of them are very important in their bearing on the history of architecture. Large monasteries often had several cloisters. The term *claustrum* was in them applied also to the covered passage-way leading from one part of a monastic establishment to another.—Wetzer u. Welte, *Kirchen-Lex.* vi, 228.

CLOISTER-GARTH, the court or open space enclosed by a cloister (q. v.).

Cloke. See CLOAK.

Clonites. See METHODISTS, PRIMITIVE WESTERN, OF IRELAND.

Close Communion. See COMMUNION.

Closet (חֹפֶה, *chuppah*, a covering, Joel ii, 16), a bridal couch, with curtains, rendered by our translators "chamber" in Psa. xix, 5. See BED. The Jews still employ the same word to designate the canopy under which, among them, the nuptial ceremony is performed. See MARRIAGE.

The word in the N. T. rendered "closet" is *ταμιειον*, signifying properly a *store-house* (as in Luke xii, 24); hence any place of privacy and retirement (Matt. vi, 6; Luke xii, 8). See PRAYER.

Clothing (garment, לְבוּשׁ, *lebusah*, ἐνδυμα). Immediately after the Fall, our first parents clothed themselves with the leaves of the fig-tree; afterwards with the skins of animals. Subsequently some method, we may suppose, was discovered for matting together the hair of animals and making a sort of felt-cloth. Later still the art of weaving was introduced, and a web was formed combining the hair of animals with threads drawn from wool, cotton, or flax. The art of manufacturing cloths by spinning and weaving is of very great antiquity (Gen. xiv, 23; xli, 42; Job vii, 6).

The Egyptians were celebrated for such manufactures. The Hebrews, while dwelling among them, learned the art, and even excelled their teachers (1 Chron. iv, 21). See WEAVING. While wandering in the Arabian wilderness, they prepared the materials for covering the tabernacle, and wrought some of them with embroidery. Cotton (?) cloth was esteemed most valuable, next to that of woolen and linen. That which was manufactured from the hair of animals was considered of least value. Silk is not mentioned at a very early period, unless it be so in Ezek. xvi, 10, 13. This, however, is clear, that Alexander found silks in Persia, and it is more than probable that the Median dress adopted by the Persians under Cyrus was silk. It was not introduced among the nations of Europe until a late period. (See these various materials in their alphabetical order.) Garments woven or dyed of various colors were much esteemed in the East. They were generally made by women, and were occasionally tastefully embroidered (Gen. xxvii, 3; Exod. xxviii, 4-8; xxxix, 8; Judg. v, 30; Prov. xxxi, 21-24). The Asiatic modes of dress are nearly the same from age to age, and hence much light is thrown by modern observation on the subject of the clothing of the Hebrews. See COSTUME. The principal articles of dress, with men, were the "cloak," "robe," or "mantle," constituting the ordinary outer garment; the "shirt," or *tunic*, forming the inner dress; the "turban" for the head; the "girdle" for confining the garments at the waist; and the "*sandals*" for the feet. To these were added, in the case of females, the "*veil*" for concealing the face, and, as a matter of ornament, the showy "head-dress," the "necklaces," "bracelets," and "anklets," the jewelled rings for the ears and nose, with other occasional articles of effeminacy, as in Isa. iii. (See each of these words in its place.) See ATTIRE.

CHANGE OF CLOTHING. See GARMENT.

RENDING OF CLOTHES. To rend or tear the garments was from the earliest period an action expressive of the highest grief (Gen. xxxvii, 29). Jacob and David did it on various occasions; and so did Joshua, Hezekiah, and Ezra (2 Sam. xiii, 81; Josh. vii, 6; 2 Kings xix, 1; Ezra ix, 3). The high-priest was forbidden to rend his clothes (Lev. x, 6; xxi, 10), probably meaning his sacred garments: perhaps those referred to in Matt. xxvi, 65, were such as were ordinarily worn, or merely judicial, and not pontifical garments. Sometimes it denoted anger, or indignation mingled with sorrow (Isa. xxxvi, 22; xxxvii, 1; Acts xiv, 14). See RENDING.

Cloud (properly עָנָן, *anan*, as covering the sky, νεφέλη). The allusions to clouds in Scripture, as well as their use in symbolical language, must be understood with reference to the nature of the climate, where the sky scarcely exhibits the trace of a cloud from the beginning of May to the end of September, during which period clouds so rarely appear, and rains so seldom fall, as to be considered phenomena—as was the case with the harvest-rain which Samuel invoked (1 Sam. xii, 17, 18), and with the little cloud, not larger than a man's hand, the appearance of which in the west was immediately noticed as something remarkable not only in itself, but as a sure harbinger of rain (1 Kings xviii, 44). As in such climates clouds refreshingly veil the oppressive glories of the sun, clouds often symbolize the Divine presence, as indicating the splendor, insupportable to man, of that glory which they wholly or partially conceal (Exod. xvi, 10; xxxiii, 9; Num. xi, 25; xxi, 5; Job xxii, 14; Psa. xviii, 11, 12; Isa. xix, 1). The shelter given, and refreshment of rain promised by clouds, give them their peculiar prominence in Oriental imagery, and the individual cloud in that ordinarily cloudless region becomes well defined, and is dwelt upon like the individual tree in the bare landscape (Stanley, *Syria and Palestine*, p. 140). Similarly, when a cloud appears, rain is ordi-

narily apprehended, and thus the "cloud without rain" becomes a proverb for the man of promise without performance (Prov. xvi, 15; Isa. xviii, 4; xxv, 5; Jude 12; comp. Prov. xxv, 14). The cloud is, of course, a figure of transitoriness (Job xxx, 15; Hos. vi, 4), and of whatever intercepts divine favor or human supplication (Lam. ii, 1; iii, 44). Being the least substantial of visible forms, undefined in shape, and unrestrained in position, it is the one among material things which most easily suggests spiritual being. Hence it is, so to speak, the recognised machinery by which supernatural appearances are introduced (Isa. xix, 1; Ezek. i, 4; Rev. i, 7, et passim), or the veil between things visible and invisible; but, more especially, a mysterious or supernatural cloud is the symbolical seat of the Divine presence itself—the phenomenon of deity vouchsafed by Jehovah to the prophet, the priest, the king, or the people (Psa. lxxviii, 84; lxxxix, 6; civ, 3; Nah. i, 8). Sometimes thick darkness, sometimes intense luminousness, often, apparently, and especially by night, an actual fire is attributed to this glory-cloud (Deut. iv, 11; Exod. xl, 85; xxxiii, 22, 23; 2 Sam. xxii, 12, 13). Such a bright cloud, at any rate at times, visited and rested on the Mercy-seat (Exod. xxix, 42, 43; 1 Kings viii, 14; 2 Chron. v, 14; Ezek. xliii, 4), and was named Shekinah (q. v.) by late writers (see Tholemann, *De nube supra arca*, Lips. 1771–1752; Stiebritz, *De arca fœderis*, Hal. 1753). Thus Jehovah appeared at Sinai in the midst of a cloud (Exod. xix, 9; xxxiv, 5); and when Moses had built and consecrated the tabernacle, the cloud filled the court around it, so that Moses could not enter (Exod. xl, 84, 85). The same happened at the dedication of the Temple by Solomon (2 Chron. v, 13; 1 Kings viii, 10). So Christ, at his second advent, is described as descending upon clouds (Matt. xxiv, 5; xxiv, 30, etc.; Acts i, 9; Rev. i, 7; xiv, 14, 16). To come in the clouds, or with the clouds of heaven, was among the Jews a known symbol of Divine power and majesty; and Grotius observes that a similar notion obtained among the heathen, who represented their deities covered with a cloud. (See the treatises on the symbolical nimbus or halo by Nicolai [Jen. 1699], Reiske [*Dissert.* ii, No. 4].) Hence "clouds and darkness" appear to be put as representing the mysterious nature of the Divine operations in the government of the world (Psa. cxvii, 2). Clouds are also the symbol of armies and multitudes of people (Jer. iv, 13; Isa. lx, 8; Heb. xii, 1); a figure referring to the effects of a large and compact body of men, moving upon the surface of an extensive plain, like a cloud in the clear sky. A day of clouds is taken for a season of calamity (Ezek. xxx, 3; xxxiv, 12). Peter compares false teachers to clouds carried about with a tempest (2 Pet. ii, 17). Solomon compares the infirmities of old age, which arise successively one after another, to "clouds returning after rain" (Eccles. xii, 2). The favor of a king is compared to "a cloud of the latter rain," refreshing and fertilizing the earth (Prov. xvi, 15). The sudden disappearance of threatening clouds from the sky is employed by Isaiah as a figure for the blotting out of transgressions (xliv, 22). See Wemys's *Clavis Symbolica*, s. v.

PILLAR OF CLOUD (עַמּוּד עָנָן, *column of the cloud*, Exod. xxxiii, 9, 10), otherwise called *Pillar of Fire* (עַמּוּד אֵשׁ, Exod. xiii, 22), was the active form of the symbolical glory-cloud, betokening God's presence to lead his chosen host, or to inquire and visit offences, as the luminous cloud of the sanctuary exhibited the same under an aspect of repose. The cloud, which became a pillar when the host moved, seems to have rested at other times on the tabernacle, whence God is said to have "come down *in* the pillar" (Num. xii, 5; so Exod. xxxiii, 9, 10). See PILLAR. It preceded the host, apparently resting on the ark, which led the way (Exod. xiii, 21; xl, 86, etc.; Num. ix, 15–28; x,

84). So by night the cloud on the tabernacle became fire, and the guiding pillar a pillar of fire. See BROOM. Modern Germans explain it of a natural appearance, or of the holy fire carried before the host from off the altar; but it is clearly spoken of as miraculous, and gratefully remembered in after ages by pious Israelites (Psa. cv, 39; lxxxviii, 14; Wisd. x, 17) as a token of God's special care of their fathers. Isaiah has a remarkable allusion to it (iv, 5), as also Paul (1 Cor. x, 4, 2; see Pfau, *De nube Israeliticæ baptisante*, Viteb. s. a.). A remarkable passage in Curtius (v, 2, § 7), descriptive of Alexander's army on the march, mentions a beacon hoisted on a pole from headquarters as the signal for marching ("a fire was observed by night, a smoke in the day-time"). This was probably an adoption of an Eastern custom. See also an account of an appearance of fire by night in the expedition of Timoleon to Italy (Diod. Sic. xvi, 66). Similarly the Persians used, as a conspicuous signal, an image of the sun enclosed in crystal (Curtius, iii, 8, § 9). Caravans are still known to use such beacons of fire and smoke, the cloudiness and often stillness of the sky giving the smoke great density of volume and boldness of outline. — Smith, s. v.; Kitto, s. v. See EXODE.

Clough, BENJAMIN, a Wesleyan Methodist missionary, was born at Bradford, England, 1791, and united with the Wesleyan Church in 1808. In a few years he was licensed as a local preacher, and in 1818 was sent with Dr. Coke, as one of his helpers, in his mission to India. In Ceylon he was soon regarded as one of the most successful students and teachers. He compiled two dictionaries—English and Singalese, and Singalese and English—which were published at the expense of the colonial government, and have been of incalculable value to his successors in the mission. He was one of the translators of the Holy Scriptures of the Old and New Testaments into the Singalese language; and he assisted in preparing for the press a translation of the New Testament into the Pali, the sacred language of the Buddhists. As a preacher to the natives he was most zealous and successful. "During the first year of his labors, he won the confidence and convinced the judgment of many distinguished men among the heathen, and assisted to form that system of evangelization which has blessed many thousands of persons in the island of Ceylon." In 1833, failing health compelled him to return to England. He died in London, April 31, 1853.—*Wesleyan Minutes*, 1853, p. 18.

Clout is given in Josh. ix, 5 as the rendering of the Heb. verb עָלָה (*alal*), elsewhere rendered "spotted"), which properly means to *patch*, and denotes that the sandals of the Gibeonites were mended, as if old and worn by a long journey. The "cast clouts" (עֲרִיבֵי, *sechabah'*, literally a *tearing* in pieces) put under Jeremiah's arms to prevent the cords by which he was drawn out of the dungeon from cutting into the flesh (Jer. xxxviii, 11, 12) were old torn clothes or rags.

Clovis (old Ger. *Chlodwig*, i. e. "famous warrior;" modern Ger. *Ludwig*, Fr. *Louis*), the first Christian king of the Franks, was born A.D. 465, and by the death of his father, Childeric, became king of the Salian Franks, whose capital was Tournay. After having overthrown the Gallo-Romans under Syagrius, near Soissons, he took possession of the whole country between the Somme and the Loire, and established himself in Soissons. In 493 he married Clotilda, daughter of a Burgundian prince. His wife was a Christian, and earnestly desired the conversion of her husband, who, like most of the Franks, was still a heathen. In a great battle with the Alemanni at Tolbiac [Zülpich], near Cologne, Clovis was hard pressed, and, as a last resource, invoked the God of Clotilda, offering to become a Christian on condition of obtaining

the victory. The Alemanni were routed, and on Christmas day of the same year Clovis and several thousands of his army were christened by Remigius, bishop of Rheims. The reception of Clovis into the Church by a bishop in connection with Rome tended greatly to secure the supremacy of orthodoxy over Arianism, to which, at that time, most of the Western Christian princes belonged. Pope Anastasius, who fully appreciated the importance of this gain, saluted Clovis as the "most Christian king." In 507, love of conquest concurring with zeal for the orthodox faith, Clovis marched to the south-west of Gaul against the heretic Visigoth, Alaric II, whom he defeated and slew at Vouglé, near Poitiers, taking possession of the whole country as far as Bordeaux and Toulouse; but he was checked at Arles, in 507, by Theodoric, king of the Ostrogoths. Clovis now took up his residence in Paris, where he died in 511. Clovis, in several instances, used the Arianism of other Christian princes as a pretext for war and conquest, and he stained his name by cruelly murdering a number of his relations whom he looked upon as dangerous rivals; but the writers of the Romish Church assert that he was chaste, and just toward his subjects.—See Chambers, *Encycl. s. v.*; Wetzer u. Welte, *Kirchen-Lex.* ii, 490.

Cloyne, an ancient episcopal town in the south-east of Cork county, fifteen miles east by south of Cork. The bishopric was founded in the 6th century by St. Colman, the abbey in 707, and the cathedral in the 13th century. Near the cathedral is a round tower 92 feet high. About 1490 the episcopate was united to that of Cork, separated in 1678, and reunited in 1835. See **CORK**. Berkeley, the celebrated philosopher, was born here, and was bishop of Cloyne in 1678. Brinkley, the astronomer, who died in 1835, was also bishop of Cloyne. Population 1718. Cloyne is also the seat of a Roman Catholic bishop, who belongs to the ecclesiastical province of Cashel.—Chambers, *Encyclopædia*.

Club (only once in the plur., and that in the Apocrypha, 2 Macc. iv, 41, ξίλων πάχη, *thicknesses of sticks*, i. e. stout pieces of wood).

Clugny, Congregation of, a congregation of Reformed Benedictine monks, established in 909 at Clugny (now Cluni, a town of France, Department of Saône and Loire, eleven miles north-west of Mâcon) by Duke William of Aquitania and Berno, abbot of the Benedictine monasteries of Gigny and Baume. William gave to the new convents all the lands, forests, vineyards, mills, slaves, etc., of the domain of Clugny. The convent was to be always open for the poor, needy, and travellers, and to pay a small annual tribute to Rome; it was to be exempt from ducal and episcopal jurisdiction, being subject to the pope and the abbot only. William himself went to Rome to obtain the papal sanction. The convent began with twelve monks, under Berno as its first abbot. Under his successor Odo (q. v.), one of the most influential men of his time, numerous French convents subordinated themselves to Clugny, thus forming the "Congregation of Clugny," which soon extended from Benvenuto to the Atlantic Ocean, and embraced the most important convents of Gaul and Italy. Under the administration of his successors Aymard, Maleul (Majolus), and St. Odilo, the congregation steadily extended, many bishops and princes placing their convents under Clugny. A large synod of French bishops at Anse, during the time of Odilo, declared the exemption of Clugny invalid; but under Odilo's successor, St. Hugo (died 1109), the old privilege was recovered. The reputation of Clugny at this time greatly increased in consequence of three monks of the congregation ascending, within a brief space of time, to the papal chair—Gregory VII, Urban II, and Pascal II. Hugo, in 1089, began the construction of the basilica of Clugny, which at that time was the largest in the world, and subsequently only a little surpassed by St.

Peter's Church at Rome. Under Hugo the congregation numbered about 10,000 monks. His successor, Pontius de Melguell, received the right of exercising the functions of a cardinal, and assumed the title of Archiabbas. His ambition having involved him in great difficulties, he resigned, and undertook a pilgrimage to Jerusalem; but a few years after he returned, took forcible possession of Clugny, of which at that time Peter Maurice, of Montboisier, generally called Peter the Venerable, was abbot, and squandered the treasures of the Church. He was arrested and imprisoned at Rome, where he died excommunicated. Under Peter the Venerable, Clugny reached the most brilliant point in its history, more than 2000 convents belonging to the congregation. Soon after it began to decline, especially in consequence of the rise of the mendicant orders and of the immense riches of the congregation. Several abbots endeavored to restore a strict discipline, and abbot Ivo of Vergy, in 1269, established the College of Clugny in Paris, in order to inspire the monks with greater interest in literary pursuits; but all these efforts led to no permanent improvement. Gradually the abbey fell under the rule of the French kings, and in the 16th century it became a "commend" (q. v.) of the cardinals and prelates of the family of Guise, and was on that account several times devastated during the civil wars in France. Clugny lost many of its convents in consequence of the Reformation, and because foreign governments objected to the continuance of a connection of convents in their countries with a French abbey. In 1627, Cardinal Richelieu made himself abbot of Clugny, and united it with the Congregation of the Maurines. This led to violent dissensions among the monks of Clugny, and the union had after a time to be repealed. The corruption after this time steadily increased, and Clugny, as a monastic institution, was only a wreck, when the French Constituent Assembly, on February 13, 1790, suppressed all the convents. The last abbot of Clugny, Cardinal Dominique de la Rochefoucauld, died in 1800. The property of the convent was confiscated, and the church sold for 100,000 francs to the town, which broke it down. Only a few ruins are left. See Lorain, *L'abbaye de Clugny* (Dijon, 1839); Wetzer u. Welte, *Kirchen-Lex.* ii, 641; Herzog, *Real-Encyclop.* ii, 769; Hase, *Church Hist.* p. 226; Neander, *Church Hist.* iii, 417; iv, 249, 263. See **BENEDICTINES**.

Cluster. See **BITTER**; **ESHOOL**; **GRAPE**.

Clyma (Κλύσμα), the name given by Eusebius (*Onomast. s. v. Βεελσεφών*) to the head of the Heroopolitan or western gulf of the Red Sea, through which the Israelites passed on dry land; according to Philostorgius (*Hist. Eccl.* iii, 5), from a town of that name (comp. Epiphanius, *adv. Haer.* ii, p. 618), apparently corresponding nearly to the modern site of Suez (Reiland, *Palæst.* p. 471), a little to the north of which are some mounds still known by the Arabs as *Tell Kolum* (Wilson, *Lands of Bible*, i, 137). See **EXODE**.

Cnidus (Κνίδος, of unknown etymol.; by the Romans often called *Cnidus*) is mentioned in 1 Macc. xv, 23, as one of the Greek cities which contained Jewish residents in the second century before the Christian era, and in Acts xxvii, 7, as a harbor which was passed by Paul after leaving Myra, and before running under the lee of Crete. It was a city of great consequence, situated at the extreme southwest of the peninsula (Mela, i, 16, 2) of Doris (Ptolemy, x, 2, 10), in Asia Minor [see **CARIA**], on a promontory which projects between the islands of Cos and Rhodes (Pliny, v, 29; see Acts xxi, 1); in fact, an island, so joined by an artificial causeway to the main land as to form two harbors, one on the north, the other on the south (see Smith's *Dict. of Class. Geogr.* s. v.). All the remains of Cnidus show that it must have been a city of great magnificence (see Mannert, VI, iii, 284 sq.). Its inhabitants were originally Lacedæmonian colonists (Herod. i, 174). It



Plan of Cnidus and Chart of the adjoining Coast.

was celebrated for the worship of Venus, whose famous statue, executed by Praxiteles, stood in one of her three temples there (Strabo, xiv, p. 965; Plin. *Hist. Nat.* xxxvi, 15; Hom. *Odyss.* i, 80), and was the birth-place of Etesias and other noted ancients (Pausanias, i, 1, 3). It is now a mere heap of ruins, and the modern name of the promontory is Cape *Krio* (Clarke's *Travels*, iii, 261). The place has been fully illustrated by Beaufort (*Karamania*, p. 81), Hamilton (*Researches*, ii, 39), and Texier (*Asie Mineure*); see also Leake (*Northern Greece*, ii, 177; *Asia Minor*, p. 226), with the Drawings in the *Ionian Antiquities*, published by the Dilettanti Society, and the English *Admiralty Charts*, Nos. 1533, 1604.



Coin of Cnidus.

Coadjutor, in the churches of Rome and England, an assistant, appointed by competent authority, to any bishop, dignitary of a cathedral, or incumbent who is disabled by age or infirmity from the personal discharge of his duties. Such coadjutor may be either permanent or temporary, and in the former case may be appointed either with or without the right of succession. In the 8d century Bishop Narcissus, of Jerusalem, received as coadjutor Alexander of Cappadocia, and in the 4th century St. Augustine was appointed coadjutor of Valerius of Hippo. The first instance of the bishops of Rome having claimed any influence upon the appointment of coadjutors is found in a letter from Pope Zacharias to St. Boniface, in which permission is given to the latter to consecrate a coadjutor. The provincial councils, however, continued to claim this right, until in 1298 Boniface VIII reserved it as a *causa major* for the papal chair. The laws of the Church of Rome strictly forbade the appointment of coadjutors with the right of succession. The Council of Trent forbade it absolutely, with regard to lower benefices, but in the case of bishops and superiors of monasteries provided that, from important reasons, the popes might make an exception. The popes, however, disregarded this law, as well as so many others given by the councils, and appointed coadjutors for lower offices no less than for episcopal sees. See Wetzer u. Welte, *Kirchen-Lex.* ii, 646; Herzog, *Real-*

Encyclopædie, ii, 789; Eden, *Theol. Dictionary*, s. v.

Coal (Sept. and N. T. *ἀνθραξ*) is a translation usually of one or the other of two Heb. words, viz., *חֶבֶל* (*gache'leth*, literally a *kindling, prusina*), which signifies an ignited or *live coal*, and is of frequent occurrence (2 Sam. xiv, 7; xxii, 9; Job xl, 21; Psa. xviii, 8; cxv, 4; Isa. xlv, 19; xlvii, 14; Ezek. xxiv, 11), often with the emphatic addition of "burning" or of "fire" (Lev. xvi, 12; 2 Sam. xxii, 18; Psa. xviii, 12, 18; cxl, 10; Prov. vi, 28; xxv, 22; xxvi, 21; Ezek. ii, 18; x, 2), and *פֶּחַם* (*pecham*, literally *black, carbo*), which properly signifies a coal quenched and not rekindled, or *charcoal* (Prov. xxvi, 21, where the distinction between this and the former term is clearly made, "as coals [*pecham*] are to burning coals [*gacheleth*]"), and hence an ignited coal (Isa. xlv, 12; liv, 16). See FURL. Two other Heb. terms (erroneously) rendered "coal" are *רִצְפָק* (*rispak*, "live coal," Isa. vi, 6, literally a *pavement*, as elsewhere rendered),

which appears to have been a *hot stone* used for baking upon; *רֶשֶׁפֶת* (*re'sheph*), properly *flames* (to which jealousy is compared, Cant. viii, 6), and hence pestilential *fever* (Hab. iii, 5; "burning heat," Deut. xxii, 24; elsewhere a "spark," Job v, 7; "thunderbolt," Psa. lxxviii, 48); and *רֶשֶׁפֶת* (*re'sheph*, spoken of a cake "baked on the coals"), which appears to be cognate to both the preceding words and to combine their meaning, and may thus designate (as explained by the Rabbins a *coal*, Sept. *ἰγκυρπία*, Vulg. *subcinericus*) a loaf baked among the embers. See BREAD. In Lam. iv, 8, "their visage is blacker than a coal," the word is *שְׁחֹרֹת* (*shechor'*), which simply means *blackness*, as in the margin. In the New Testament, the "fire of coals" (*ἀνθρακία*, John xviii, 18) evidently means a mass of live charcoal, used in a chafing-dish for warming in the East, and so explained by Suidas and parallel instances in the Apocrypha (Ecclus. viii, 10; xi, 32). The substance indicated in all the foregoing passages is doubtless *charcoal*, although anthracite or bituminous coal has been found in Palestine in modern times (see Browning's *Report*; also Elliot, ii, 257). See MINERAL.

"In 2 Sam. xxii, 9, 18, 'coals of fire' are put metaphorically for the lightning's proceeding from God (Psa. xviii, 8, 12, 18; cxl, 10). In Prov. xxv, 22, we have the proverbial expression 'Thou shalt heap coals of fire upon his head,' which has been adopted by Paul in Rom. xii, 20, and by which is metaphorically expressed the burning shame and confusion which men must feel when their evil is required by good. (See the essays on this text by Heinrich [Lugd. B. 1716], Wähner [Gott. 1740].) In like manner, the Arabs speak of *coals of the heart, fire of the liver*, to denote burning care, anxiety, remorse, and shame (Gesen. *Thesaur. Heb.* p. 280). In Psa. cxv, 4, 'coals' = burning brands of wood (not 'juniper,' but broom), to which the false tongue is compared (James iii, 6). In 2 Sam. xiv, 7, the quenching of the live coal is used to indicate the threatened destruction of the single remaining branch of the family of the widow of Tekoah suborned by Joab; just as Lucian (*Tim.* § 8) uses the word *ζῶπυρον* in the same connection" (Smith, s. v.). See FIRE.

Coast, an inaccurate rendering in the A. V. of various terms (usually *גְּבול*, *חֶבֶל*, etc., Gr. *ὄριον*) signifying *border* (q. v.), boundary, or extremity, except in the expression "sea-coast" (*חֹפֶה*, *choph*, Ezek. xxv, 16; *παράλιος*, Luke vi, 17; *παραθαλάσσιος*, Matt. ix, 18). See SEA.

Coat (*כֵּיתָבֶת*, *keitho' meth*, or *כִּטְוֹת*, *kitto' meth*, prob-

ably meaning *covering*; hence Greek χιτών) is the word employed by our translators for the ancient *tunic* (q. v.), which was in modern phrase a *shirt* worn next to the skin (Lev. xvi, 4), by females as well as males (Cant. v, 3; 2 Sam. xiii, 18), and especially by the priests and Levites (Exod. xxviii, 4; xxix, 5; Neh. vii, 70, 72). The same term is used of the "coats of skins" prepared by the Almighty for the first human pair (Gen. iii, 21), which were probably nothing more than aprons, or a short skirt bound at the waist. The tunic was commonly (at least with males) without sleeves, and usually reached to the knees. It was generally made of linen, but for the winter was frequently made of wool; and the rich no doubt wore tunics of *byssus* ("fine linen," i. e. [?] *cotton*, then very rare). It was sometimes woven entire without a seam, like the modern hose (John xix, 23). It was also occasionally of a gay pattern; such was "Joseph's coat of many colors" (Gen. xxxviii), that is, of different colored threads in stripes or plaided. Sometimes two tunics seem to have been worn at once, either for ornament or luxury, for the term is frequently used in the plural of an individual (Matt. x, 10; Mark, vi, 9; Luke iii, 11). In that case the outer one probably supplied the place of the "cloak" or pallium. See CLOTHING; DRESS, etc. The "fisher's coat" (ἰκευτήριος) mentioned in John xxi, 7, was evidently an outer garment or cloak, and Peter is said to be "naked" before throwing it about him, as having on only the tunic, or perhaps no more than a strip of cloth about the loins, like the modern Arabs. The little "coat" made by Hannah for the young Samuel (1 Sam. ii, 19) was the כִּיְרֵם (meil'), or outer dress, elsewhere rendered "robe," "mantle," or "cloak" [q. v.]. The "coats" of the three Hebrew children in the furnace (Dan. iii, 21, 27) are called in the original Chaldee כִּיְרֵם (sarbalin', Sept. σαράβαλα), thought by some to be the Persian name for long and wide *trousers*, whence Greek σαράβαλλα, Lat. *sarabala*, etc., but by others, with greater probability, to be kindred with the Arabic name for a long shirt or *cloak*, which is corroborated by the Talmudic interpretation of *mantles*, i. e. the *pallium* or outer dress. (See Smith's *Dict. of Class. Antig.* s. v. *Tunica*, etc.) See ATTIRE.

COAT OF MAIL (שִׁירֵון, *shiryon'*, *glittering*) occurs in the description of Goliath's armor (1 Sam. xvii, 5), and also of Saul's (ver. 88). See ARMOR. The plural forms are found in Neh. iv, 16; 2 Chron. xxvi, 14; where they are translated "habergeons" (q. v.). The kindred terms שִׁירֵיחַ (*shiryah'*, "habergeon," Job xli, 26), שִׁרְיָן (*shiryon'*, "harness," 1 Kings xxii, 84; 2 Chron. xviii, 83; "breast-plate," Isa. lix, 17), and שִׁרְיָן (*shiryon'*, "brigandines," Jer. xli, 4; li, 8), were probably less complete kinds of the same, i. e. *corselets*. See also MAIL.

Cobb, SYLVANUS, D.D., a Universalist minister and writer, was born at Norway, Maine, July, 1788. His first education was under orthodox influences, but early in life he became a Universalist. He preached his first sermon at the age of twenty-one, but was not ordained until 1821. He was settled as minister in succession at Waterville, Maine, at Malden, Waltham, and (since 1849) at East Boston. While at Waltham he established the *Christian Freeman*, which in 1862 was united with the *Trumpet*. In 1864 he retired from editorial life, after a service of about thirty years. In the same year he received from Tufts College the honorary degree of doctor of divinity. He died October 31, 1866. Dr. Cobb was a voluminous writer. Many of his earlier controversial sermons were published and widely circulated in Maine and elsewhere. His *Discussions* with Dr. Adams and Mr. Hudson, involving the subjects of everlasting punishment and the annihilation of the wicked, were also put into book form, after appearing in the columns of the *Freeman*.

His *Compend of Divinity* is recognised as a standard in the denomination. He also wrote a *Commentary on the New Testament*.—*Universalist Register for 1867*, p. 81 sq.

Cobbet, THOMAS, a Congregational minister, was born at Newbury, Berkshire, Eng., in 1608, and served in the ministry of the Church of England for a short time. Ejected for nonconformity, he came to New England, arriving June 26, 1637. He served for twenty years as collegiate pastor in Lynn, and removed to Ipswich, where he died Nov. 5, 1685. He published *A Vindication of the Covenant of the Children of Church Members* (1643):—*A Defence of Infant Baptism* (1645):—*The civil Magistrate's Power in Matters of Religion modestly debated*, etc. (1658):—*A practical Discourse on Prayer* (1664):—*A Treatise on the Honor due from Children to their Parents* (1656).—Sprague, *Annals*, i, 102.

Cobbs, NICHOLAS HANMER, D.D., a bishop of the Protestant Episcopal Church of the United States, was born February 5, 1795. He was the first bishop of the diocese of Alabama, being consecrated October 20, 1844. He died January 11, 1861.

Cobham, Lord (Sir John Oldcastle), a Lollard martyr of the fifteenth century. Of his early life little is known. He was born in the reign of Edward III; married the niece of Henry, lord Cobham, and obtained his title. He entered the military life, and gained great distinction. According to Bayle, "in all adventurous acts of worldly manhood he was ever fortunate, doughty, noble, and valiant." By his military talents he acquired the esteem both of Henry IV and Henry V. In conjunction with Sir Richard Story, Sir Thomas Latimer, and others, he drew up a number of articles, which, in the form of a remonstrance against the corruptions of the clergy, they presented to the House of Commons. He put himself to great expense in collecting, transcribing, and dispersing the works of Wycliffe. He also furnished Lollard itinerant preachers with shelter at his mansion at Cowling Castle, in Kent. These proceedings made him very obnoxious to the clergy. During the first year of the reign of Henry V, the principal subject of debate was the growth of heresy. Thomas Arundel (q. v.), archbishop of Canterbury, requested the king to send commissioners to Oxford to inquire into the growth of heresy. The commissioners reported to the archbishop, who informed the Convocation that the increase of heresy was especially owing to lord Cobham, who encouraged scholars from Oxford and other places to propagate heretical opinions throughout the country. The archbishop, accompanied by a large body of the clergy, waited upon Henry, and, having laid before him the offence of lord Cobham, begged, in all *humility and charity*, that his majesty would *suffer them, for Christ's sake, to put him to death*. To this humane request the king replied that he thought such violence more destructive of truth than of error; that he himself would reason with lord Cobham; and, if that should prove ineffectual, he would leave him to the censure of the Church. Henry endeavored to persuade lord Cobham to retract, but he returned the following answer: "I ever was a dutiful subject to your majesty, and I hope ever shall be. Next to God, I profess obedience to my king. But as for the spiritual dominion of the pope, I never could see on what foundation it is claimed, nor can I pay him any obedience. As sure as God's word is true, to me it is fully evident that he is the great Antichrist foretold in holy writ." This answer so displeased the king that he gave the archbishop leave to proceed against lord Cobham "according to the devilish decrees which they call the laws of the holy Church" (Bayle). On the 11th of September, the day fixed for his appearance, the primate and his associates sat in consistory; when, lord Cobham not appearing, the archbishop excommunicated him. Cobham now drew up a confession of

faith, which he presented to the king. Being again cited to appear before the archbishop, and refusing compliance, he was committed to the Tower by the king's order. "Upon the 26th of September, 1413, he was brought again by the lieutenant of the Tower before the archbishop, the bishops of London, Winchester, and Bangor sitting upon the bench with him. The archbishop desired Sir John to move for the absolution of the Church in the customary form. He replied he would beg absolution of none but God Almighty. After this, the archbishop desired him to make an express declaration concerning the sacrament of the altar. To which he gave this answer: that as Christ, when upon earth, consisted of the divine and human nature, his divinity being concealed under his humanity, so in the sacrament of the altar there is both a real body and real bread; that the bread is the object of our sight, but that the body of Christ, contained or shrouded under it, is imperceptible to our senses. When he was pressed closer to the point of transubstantiation, he declared expressly against it, adding withal that the common belief in this article was a contradiction to the holy Scriptures; that the decision was modern, and that the Church did not vary thus from the old standard till she was poisoned by being endowed. And as to penance and confession, he affirmed that if any person happened to be under the misfortune of any great crime, and was not in a condition to disentangle himself, he conceived it would be advisable to make use of the direction of some holy and discreet priest. But then he did not think there was any necessity of confessing to the parish curate, or any other of that character; for that in this case there was needed no more than contrition to cancel the fault and restore the penitent. Touching the worshipping the cross, he maintained that only the body of Christ, which hung upon the cross, ought to be adored. And being further interrogated what regard was to be paid to the resemblance of that cross, to this he replied directly that all the reverence he could pay was only to clean it and keep it handsomely. Being interrogated further about the power of the keys, and what his opinion was of the character and authority of the pope, of the archbishops, and bishops, he made no scruple to declare that the pope was downright Antichrist, and the head of that party; that the bishops were the members, and the friars the hinder parts of this anti-Christian society; that we ought to obey neither pope nor prelates any further than their virtue and probity could command; and that unless they imitated our Saviour and St. Peter in the sanctity of their lives, the pretence of their commission was not to be regarded; that he who was most unblemished in his conduct, most remarkable for his sanctity, was St. Peter's successor, and that all other titles to Church authority signified nothing" (Hook, *Eccl. Biography*, i, 317). Having remained six months in the Tower, he escaped into Wales. In 1414 the king set a price of a thousand marks upon the head of Cobham; and for four years he continued in exile in Wales; but at length his enemies engaged the lord Powis in their interest, who, by means of his tenants, secured and delivered him up. He received sentence of death both as a heretic and a traitor. On the day appointed for his execution (Christmas, 1417) he was brought out of the Tower with his arms bound behind him, but with a cheerful countenance. Arrived at the place of execution, he devoutly fell upon his knees, and implored of God the forgiveness of his enemies. He was hung up alive by the middle, with iron chains, on the gallows which had been prepared, under which, a fire being made, he was burned to death.—Jones, *Christian Biography*, s. v.; Middleton, *Memoirs of the Reformers* (3 vols. Lond. 1829), i, 98 sq.; *England and France under the House of Lancaster* (London, 1852) p. 60–87; *Eclectic Review*, 4th series, xvi, 249; Milner, *Church History* (Lond. 1829, 4 vols.), iii, 807–829.

Cocceius, JOHN, one of the most distinguished theologians and Biblical interpreters of the 17th century, was born in Bremen July 30 (or August 9, N. S.), 1603. The family name was *Cock* (according to others *Kock*), but he and his brother Gerhard having been in their youth called *Cocceii*, ever afterwards retained that appellation. The family was an ancient and honorable one in Bremen, many members of it having filled high offices in Church and State. He was brought up with great moral and religious strictness, for he relates in a short autobiography, which he left unfinished, that having been chastised at school for some boyish falsehood, he ever from that time despised lying, and had such a reputation for truthfulness as never to be compelled to take an oath; and that, having once been struck on the mouth by his father with a spoon for the irreverent use of God's name at the table, he never again took it in vain. He was put to the best schools in his native city, and became, while still a boy, so great a proficient in Greek as to read with delight its historians and poets. He learned from his brother the rudiments of Hebrew, and afterwards obtained the Lexicons of Munster and Pagninus, and studied them with great industry of his own accord for the investigation of the themes of the language. To the Hebrew he added Chaldean and Arabic, and gave his attention also to Rabbinical literature. Although most strongly drawn to philological studies, because, as he says, he was persuaded that the Scriptures could not be rightly understood without a knowledge of the original languages, he did not neglect other branches of learning, but studied physics and metaphysics with Gerhard Neufville, and theology with Martinus and Crocius. While still a student he wrote a Greek oration on the religion of the Turks, reading the Koran for that purpose. At the age of 22 he went to Hamburg, at the suggestion of Martinus, to prosecute his Rabbinical studies with the Jews of that city. On his return he went to Franeker, in Friesland, preferring the Belgic schools to those of Germany, which, he says, were in bad repute (*quod de his non domus rumor esset*). There he formed the acquaintance of an eminent Rabbinical scholar, Sixtinus Amama, and with him studied the Talmud. At his request he published a treatise *De Synedrjo*, which was highly commended by such scholars as Heinsius, Rivetus, Grotius, Selden, and Salmasius. While at Franeker he also became intimately acquainted with Maccovius and the celebrated Puritan divine William Ames. On his return to Bremen he was made, at the age of 27, professor of sacred philosophy, and began to lecture on the books of the Old Testament. In the following year he published a Commentary on Ecclesiastes. In 1636 he removed to Franeker, to be professor of Hebrew in the newly-revived academy in that city; and in 1643 he was also appointed to the theological chair. He remained at Franeker until 1650, giving himself with great diligence to the study and public exposition of the Scriptures. Amongst the fruits of these labors were a Commentary on Job, Lectures on the Minor Prophets, and on the Epistles to the Hebrews and the Colossians, an *Exercitatio de Principio Epistolæ ad Ephesios*, and a theological treatise, *De Fœdere et Testamento Dei*, to which he added a brief *Analysis Temporum Novi Testamenti*. After fourteen years of laborious and successful teaching at Franeker, he was invited to Leyden, to succeed the celebrated Frederick Spanheim as professor of theology; and at his inauguration in October, 1650, he delivered an oration *De causis Incredulitatis Judæorum*. He soon began to lecture on Isaiah; but the death of one of his colleagues (Triglandius) made a new division of labors necessary, and he afterwards devoted himself to the exposition of the New Testament. In 1652 his Commentary on the Minor Prophets was printed by the famous Elzevir, and in 1654 he published his *Consideratio Principii*

Evangelii S. Johannis, an elaborate examination of the first 18 verses of that Gospel, with especial reference to the misinterpretations of Socinus, Schlichtingius, and others of that school. The writings of the Socinians having been disseminated through Holland and other provinces, the Synods of North and South Holland presented to the States a petition that they might be restrained of this liberty, and an edict was accordingly issued in 1658 forbidding the printing and publishing of Socinian books, and the preaching of their doctrines. This was done in accordance with the opinion of the theological faculty of Leyden, which the States had asked for; and when an Apology against the edict was written by *Egnes Polonus* (believed to be the Socinian Jonas Schlichtingius), the task of answering it was committed to Cocceius, who fulfilled the duty so ably as to receive the thanks of the Synods of Dort and of North Holland. In 1656 he was drawn into a controversy with his colleague Hoornbeek on the divine authority of the Sabbath, which became so warm that the States interposed and put an end to it. Cocceius, recoiling from the rigid Judaizing view, went to the opposite extreme, and maintained that the Sabbath was a Jewish institution, not binding upon the Christian Church, although he was in favor, on grounds of expediency, of observing the Lord's day by public services of worship and preaching. The following year he began to write his *Hebrew Lexicon*, at the request of her highness the princess Maria Eleonora of Brandenburg; but, owing to his many other labors and cares, he did not finish it till a little before his death in 1669. He never intermitted his work as an interpreter of the Scriptures, but sent forth one commentary after another till he had almost gone through with the sacred books. The most elaborate of these are on the Psalms, Job, the Song of Solomon, and the prophetic books of the Old Testament, and on the Epistles of the New Testament, particularly those of Paul, and on the Apocalypse; but there are many valuable notes on the Pentateuch. He was also much occupied with the controversies of his time, and wrote with great learning and ability against Jews, Socinians, and Papists. He defended the integrity of the Jewish Scriptures against Isaac Vossius, who maintained that they had been corrupted, and that the translation of the Seventy had divine authority. In addition to his treatise *De Fœdere*, he wrote a much larger work with the title *Summa Theologiae ex Scripturis repetita*, the form of which was more in harmony with the systematic theology of his time. But while thus laboriously occupied, and in the full maturity of his powers, he was suddenly seized with a fever, and, after a sickness of nineteen days, died on the 5th of November, 1669, at the age of 66.

As an interpreter of Scripture, Cocceius had many of the highest qualifications. He was a man of great learning, the worthy compeer of the mighty scholars of which Holland could boast in the 17th century. In the range and thoroughness of his acquirements he was not inferior to such men as Grotius, Heinsius, Buxtorf, and Vossius. But it was in his *principles of interpretation* that his unrivalled gift was chiefly seen. He held that the Scriptures are the source of all sound doctrine; that they have not been exhausted by previous interpreters; that they are to be regarded as one organic whole, the Old Testament containing every where the hidden, and the New the unfolded Gospel; that they are to be interpreted according to the analogy of the faith or the scope of the one great revelation; that their meaning is to be determined by a careful examination of each passage as to the force of its words and phrases, and its relations to the context, or that which is derived *ex tota compagne sermonis*; that the interpreter is not to force his own opinions into the Scriptures, but to submit his mind to their teachings; and that Christ is the great subject of divine revelation, as well in the Old Testament as in the New. It

was his holding up of the Scriptures as the living fountain of theology which drew on him the bitter opposition of the scholastic theologians of his day, who would not go beyond what the Reformers had attained to, and used the Bible only as a storehouse of proof texts for doctrines which they had learned from the symbolic writings of the Reformation. Against that dry and hard scholasticism Cocceius set himself with uncompromising boldness; and he did as much as any man of his time to reinstate the Scriptures in their true place of authority, and to make interpretation to be the drawing of fresh streams from the inexhaustible well-spring of divine truth.

He has been accused of being *fanciful* as an interpreter, but, in the sense in which it is commonly understood, no charge could be more groundless. His fundamental principle was that "of those things which Christ and the apostles spake, the foundation, cause, and prescribed formula existed in the writings of Moses and the prophets, and, in truth, that Christ and the apostles accomplished that preaching concerning the kingdom of God which had been promised to Israel," and therefore that "what is to be believed concerning Christ and his righteousness, what in the New Testament is explained more succinctly and clearly, that ought to be demonstrated from the Old Testament, since both the apostles appealed to its testimony, and the Saviour himself charged the Jews to search it as testifying concerning himself." He would bring men to "the examination of all Scripture, to the perpetual analogy of promise, prophecy, and Gospel, and so of all the revelations of God's Testament."

In the application of this principle he often erred by going beyond the bounds of clear and definite knowledge, by forcing events into the mould of prophecy, and also by too great subtlety in tracing out analogies; but his errors were those of a man of penetrating insight and robust judgment, and not of weak and childish fancies. No one has seen more clearly or more sharply defined the true province and methods of the interpreter, "adding nothing to, and taking away nothing from the words of God; leaving those things which are said in a general way to be interpreted generally; giving force to the propriety and emphasis of phrases, and the analogy of sacred speech."

No one now will doubt that the one great object of divine revelation, both in the Old and New Testaments, is to unfold "the mystery of godliness, God manifest in the flesh." In all his interpretations of Scripture he was struggling towards this end; and, notwithstanding his many failures, which were inevitable at the time and under the circumstances in which he lived, his writings are full not only of grand and far-reaching principles, but of striking examples of prophetic insight in the application of them. He gave a great impulse and a right direction to Biblical studies in Holland. Amongst his pupils the famous Vitringa is to be numbered.

As a theologian, Cocceius, while conscientiously adhering to the doctrines of the Reformed (Calvinistic) Church, gave to them a more scriptural and less scholastic form, in consequence of his free and profound study of the Bible. His favorite method of setting forth theology was the *historical*, as the unfolding of the successive stages of the covenant entered into before all worlds by the Father and the Son. After the Fall, by which the covenant of works, under which Adam in his state of innocence had been placed, was abrogated, the way was opened for the establishing of the covenant of grace, which was the manifestation of that which had existed in the eternal councils of the Godhead, of which the second Person was the mediator and surety. Of these there are three dispensations—that of the Promise during the time of the patriarchs, that of the Law given from Sinai, and that of the Gospel; although the two former are also class-

and as one, as preceding the advent of the Redeemer. The fall of man was self caused, and not necessitated by any act of God (*Bona enim operatur in nobis Deus non mala*), but all his posterity were involved with Adam in the guilt and curse of his sin. This required a Mediator who could not be of the number needing redemption, and yet must be a partaker of their nature; a problem that was solved by the Son of God being made man. He, standing as the sponsor of the eternal covenant, gave unto the Father the obedience that was due from men, and also endured the penalty of death, the curse for sin, thereby making a true expiation and atonement.

Cocceius limits the death of Christ in its full force to the elect, but he asserts that Christ was "a victim of so great preciousness and sufficiency that the whole world, and all men without exception coming to him, can find sure and perfect salvation in him."

In respect to most doctrines he does not depart from the Reformed Church; but there is a spiritual life and power in his handling of them which takes them out of the sphere of a cold and lifeless orthodoxy. He was a man mighty in the Spirit, and far in advance of most men of his time in his apprehension of the work of God in Christ. Where he fails in clear sight, we still feel that noble instincts are working in him. His errors, as in regard to the Lord's day, were partly the fruit of his desire to vindicate for the Church her Christian liberty of walking always in the Spirit. He saw clearly the bondage under which the Law brought men, and he looked upon the Sabbath given from Sinai as a yoke to which those whom Christ has made free should not be in subjection. In this, as in many things, he held but half the truth, not discerning the freedom of divine ordinances; but he is not to be ranked with the lawless spirits who would break down all restraints upon the licentiousness of the flesh. He was among the first in modern times to teach the doctrine of a spiritual dispensation of glory, in distinction from a visible kingdom of Christ, and so far did he carry it as to find nothing of the resurrection in the last chapters of the Apocalypse. But he firmly held the faith of the Church as to the final resurrection of the body and the awards of the judgment.

The views of Cocceius were adopted and further developed by a number of prominent theologians of the Reformed Church of Holland and other countries. His followers were commonly designated by the name Coccejans. The foremost among the writers of this school in the provinces of systematic theology are Momma, Witsius, Burmann, and Van Til (see these articles); in exegetical literature, the greatest and most celebrated member of the school was Vitringa (q. v.), while the pious hymnologist Jodokus von Todenstein and Dr. F. A. Lampe exercised a considerable influence upon the practical life of the Church of their times. His *Opera Theologica*, including his *Summa doct. de fœdere et testamento* (Leyd. 1648), his *Lex. Hebr. et Chald. V. T.*, and other writings, were published at Amsterdam (1676-78, 8 vols. fol.; 2d ed. 10 vols. fol., 2 vols. *Opera avêrdora*, 1701). His *Life* by his son, J. H., is given in vol. viii. See Herzog, *Real-Encyclop.* ii, 765; Wetzer u. Welte, *Kirchen-Lex.* ii, 646; Mosheim, *Church Hist.* cent. xvii. pt. ii, ch. ii; Gass, *Prot. Theologie*, ii, 258; Hagenbach, *Hist. of Doctrines*, vol. ii; Dorner, *Geschichte der Protestant. Theologie*, p. 452 sq.; Fairbairn, *Typology*; Fairbairn, *Hermeneutical Manual*.

Cochin-China. See ANAM.

Cochlæus, JOHANNES (proper name *Döbneck*), was born in 1479 at Wendelstein, near Nürnberg; became rector in Nürnberg, 1511; in 1527, dean at Frankfurt; finally, canon of Breslau, in which office he died, 1562. He was one of the most violent opponents of the Reformation. He attended the Diet of Worms (1522), where he became a sort of volunteer aid to Al-

exander, the papal nuncio. He is charged with having sought to induce Luther to give up his safe-conduct, in order to put him in the power of the legate; but Cochlæus afterwards denied that this was his purpose. He was also present at the Diets of Ratisbon, 1526, and of Augsburg, 1530. At the latter, with Eck, Faber, and Wimpina, he undertook to refute the Augsburg Confession. His "refutation" was read before the Diet August 8. On the death of Eck (1548), Cochlæus took his place as the leading champion of the anti-Reformers. He wrote a tirade against Melancthon, entitled *Philippica*, addressed to the emperor. In 1546 he was active at the colloquy of Ratisbon, against Bucer and Major. His numerous pamphlets are full of violence and personalities. Among them are *Bockspiel Martini Luthers* (Mainz, 1531); *Lutherus Septiceps* (Mainz, 1529); *Historia Hussitarum* (Mainz, 1549); *De actis ac scriptis Lutheri* (1549, fol.); *Speculum circa Misam; De emendanda Ecclesia*, 1539, 8vo.—Dupin, *Eccles. Hist.* cent. xvi, p. 456; Wetzer u. Welte, *Kirchen-Lex.* ii, 647; Pierer, *Universal-Lexikon*, iv, 270; Ranke, *History of the Reformation*, iii, 306; Hofer, *Nov. Biog. Générale*, x, 955.

Cook (*ἀίσις*, literally *wakeful*). It is somewhat singular that this bird (and poultry in general) should not be distinctly noticed in the Hebrew Scriptures, especially as rearing gallinaceous fowls was an object of considerable economical importance in Egypt, and their flesh one of the principal resources for the table in every part of Southern and Western Asia. It is true, the date when the practice of obtaining them by artificial heat commenced in Egypt is sufficiently disputable, and birds of the genus *Gallus*, properly so called, are not indigenous in Western Asia, but belong in their original condition to lower India, Indo-China, and the great islands of Austral-Asia. Several species, apparently distinct, are still found wild in the forests and jungles of India, and two at least, *Gallus Sonneratii* and *G. Stanleyi*, are abundant in the woods of the Western Ghats, to which our familiar fowl bear so close a resemblance that naturalists consider the former to be their original. Domestic poultry have existed in Hindoostan from the remotest antiquity; probably much earlier than the twelfth century B. C.; for in the *Institutes of Menu*, which Sir William Jones assigns to that age, we read of "the breed of the town-cock," and of the practice of cock-fighting (v, 12; ix, 222). When the cock found its way to Western Asia and Europe we have no record. Fowl of plumage so gorgeous, of size so noble, of flesh so sapid, of habits so domestic, of increase so prolific, would doubtless early be carried along the various tracks of Oriental commerce. There is no trace of it, so far as we are aware, on the monuments of Pharaonic Egypt, but we find the cock figured in those of Assyria. In a hunting



Ancient Assyrian Game-cock.

and shooting scene depicted at Khorsabad (Botta, pl. cviii-cxiv), the scene is laid in a forest whose characteristics seem to indicate a mountain region, such as Media or Armenia. Much game is represented, including many kinds of birds, one of which seems to be the pheasant. But the most interesting is a large bird, which appears from its form, gait, and arching tail to be our common cock; it is walking on the ground amidst the trees. So far as this is evidence,

it would go to prove that the fowl, in a wild state, existed at that period in Western Asia, though now unknown on this side the Indus. The cock and hen are distinctly represented in the Xanthian sculptures, of an era probably contemporaneous with the Khorsabad palace of Nineveh. They appear also on Etruscan paintings, having probably a much higher antiquity (Mrs. Gray's *Etruria*, p. 28, 45). The early Greeks and Romans figure them on their coins and gems, and speak of them as perfectly familiar objects, with no allusion to their introduction. They had even found their way into Britain at some unknown period long anterior to the Roman invasion, for Cæsar tells us with surprise that the Britons did not think it right to eat the goose or the hen, though they bred both for the pleasure of keeping them (*Bell. Gall.* lib. v). This is a very interesting allusion, since we are compelled to refer their introduction into that island to the agency of the Phœnicians, who traded to Cornwall for tin centuries before Rome was built. Under these circumstances, their absence from Egypt, where in modern times they have been artificially bred to so immense an extent, becomes a remarkable and unaccountable fact. They were, indeed, it may be surmised, unknown in Egypt when the Mosaic law was promulgated, and, though imported soon after, they always remained in an undetermined condition, neither clean nor unclean, but liable to be declared either by decisions swayed by prejudice, or by fanciful analogies; perhaps chiefly the latter; because poultry are devourers of unclean animals, scorpions, scolopendra, small lizards, and young serpents of every kind. But, although the rearing of common fowls was not encouraged by the Hebrew population, it is evidently drawing inferences beyond their proper bounds when it is asserted (see COCK-CROWING) that they were unknown in Jerusalem, where civil wars and Greek and Roman dominion had greatly affected the national manners.

See FOWL.

In the denials of Peter, described in the four Gospels, where the cock-crowing (see below) is mentioned by our Lord, the words are plain and direct; not, we think, admitting of cavil, or of being taken to signify anything but the real voice of the bird, the ἀλεκτοροφωνία, as it is expressed in Mark xiii, 35, in its literal acceptance, and not as denoting the sound of a trumpet, so called because it proclaimed a watch in the night; for to what else than a real hen and her brood does our Saviour allude in Luke xiii, 34, where the text is proof that the image of poultry was familiar to the disciples, and consequently that they were not rare in Judæa? To the present time in the East, and on the Continent of Europe, this bird is still often kept, as amongst the Celtæ (Cæsar, *Bell. Gall.* iv, 12), not so much for food as for the purpose of announcing the approach and dawn of day (Kitto, s. v.; Fairbairn, s. v.).

See HEN.

COCK-CROWING (ἀλεκτοροφωνία). "The cock usually crows several times about midnight, and again about break of day. The latter time, because he then crows loudest, and his 'shrill clarion' is most useful by summoning man to his labors, obtained the appellation of the cock-crowing emphatically, and by way of eminence, though sometimes the distinctions of the *first* and *second* cock-crowing are met with in Jewish and heathen writers (Bochart, iii, 119). These times, and these names for them, were, no doubt, some of the most ancient divisions of the night adopted in the East, where 'the bird of dawning' is most probably indigenous. The latter 'cock-crow' was retained even when artificial divisions of time were invented. In our Lord's time the Jews had evidently adopted the Greek and Roman division of the night into four periods or watches, each consisting of three hours, the first beginning at six in the evening (Luke xii, 93; Matt. xiv, 25; Mark vi, 48)" (Kitto, s. v.). This watch (the third of these divisions, comprehending the space be-

tween the two cock-crowings) seems to have been about three in the morning, and was known to the Hebrews as כִּרְיָאֵן הַבֵּרֶךְ (*keriah hag-ge'ber*), and was termed by the Romans *galliciniam*; and it has been supposed that Jerusalem being a military station of the Romans, the custom of that nation concerning the placing and relieving of the guard was in force there. These watches, or guards, were declared by the sound of a trumpet; and whenever one guard relieved another, it was always done by the military signal. The whole four watches were closed by the blowing of a shrill horn. Drakenborch says, the last trumpet, which blew at three in the morning, was sounded three times, to imitate the crowing of a cock. See WATCH.

"It has been considered a contradiction that Matthew (xxvi, 84) records our Lord to have said to Peter, 'Before the cock crow, thou shalt deny me thrice,' whereas Mark (xiv, 30) says, 'before the cock crow twice.' But Matthew, giving only the *general* *sens* of the admonition (as also Luke xxii, 84; John xiii, 38), evidently alludes to that only which was *customarily* called the cock-crowing; but Mark, who wrote under Peter's inspection, more accurately recording *the very words*, mentions the two cock-crowings (Wetstein on Mark xiv, 30; Scheuchzer, *Phys. Sacr.* on Mark xiii, 35; Whitty's *Note* on Matt. xxvi, 84). Another objection to this part of the Evangelical history has been founded upon an assertion of the Mishna (*Baba Kama*, vii, 7), 'They do not breed cocks at Jerusalem because of the holy things,' i. e., as it is interpreted, cocks turn up the dung-hills, and set free the reptiles by which the sacrifices might be polluted which were eaten as food; and that, consequently, Peter could not hear one crow. But this is sufficiently answered above. Even the traditions themselves on this subject are not uniform; witness the story (in *Eruubin*, p. 26, 1) of a cock which killed a child, and was stoned by order of the council. Other instances are given by Reland, which show that the cock might crow, though *not in the city*, and yet be heard by Peter in the stillness of the night, especially as the palace of Caiaphas (according to the modern tradition) stood on an elevated situation, at the distance of scarcely 400 yards from the city walls" (Kitto). In the modern East the barn-door fowl is a common appendage to every household, and the cock-crowing is a universal signal of morning in Palestine (Thomson, *Land and Book*, ii, 552).

COCK, the, as a Christian symbol. (1.) On tombs the cock is a symbol of the resurrection—the *præco diei*, or herald of the light, after the night of death. (2.) The cock is also a symbol of vigilance.—Martigny, *Dict. des Antiquités Chrétiennes*, s. v. Coq.

Cockatrice, properly a fabulous serpent supposed to be hatched from a cock's egg, is the rather fanciful translation in our version of שֵׁפֶן (*se'pha*, hissing, Isa. xiv, 29) and טִיפּוֹן (*tiphon*), Isa. xi, 8; lix, 5; Jer. viii, 17). The latter word also occurs in Prov. xxiii, 32, where it is translated "adder." Aquila and the Vulg. understand the *basilik*, a fabulous serpent of antiquity, identified by many moderns with the *basiliscus regillus*, a small and exceedingly venomous viper of Africa. By others, however, the *cerastes*, or "horned viper" (*coluber cerastes* of Linn., *coluber cornutus* of Hasselquist), has been more definitely fixed upon as the animal intended, a very poisonous serpent of Egypt and Palestine, about a foot long, brown on the back and sides, with a white belly, about as thick as the finger, and having two knob-like projections upon the head (comp. Pliny, xi, 45), which were anciently compared to horns (*Ælian*, *Anim.* i, 57; Pliny, viii, 25; comp. Herod. ii, 74). It buries itself in the sand, from which it is scarcely distinguishable in color, with the horns projecting out like feelers, whence it suddenly darts forth and seizes its prey (Diod. Sic. iii, 50). (See Bochart, *Hieros.* iii, 205 sq.; Hasselquist, *Trés.* p. 365

sq.; Belon, in Paulus's *Samml.* i, 206; ii, 258; Bruce, *Trav.* vii, pl. 40; Wilkinson, 2d ser. ii, 245 sq.; Prop. Alp. *Res. Egypt.* iv, 4, p. 210, pl. 5, 6.) Others, again, refer this last to the "adder," i. e. viper (q. v.), of Gen. xlix, 17.—Winer, i, 216. See SERPENT.

Cocker, an old English term, used but once in the A. V. of the Apocrypha (Ecclus. xxx, 9, *οὐκ ἔσθηται, tend* as a nurse), in the sense of *fondle*, or treat gently.

Cockle (κωνία, *boshak'*, an offensive plant, q. d. stink-weed; Sept. βάρος, i. e. bramble) occurs only in Job xxxi, 40: "Let thistles grow instead of wheat, and cockle instead of barley." It is probably a mere general term signifying weed, perhaps like the *darnel* (*ζιζάνια*, "tares") of Matt. xiii, 30. Celsius (*Hierobot.* ii, 199) would identify it with the *aconite*, but Gesenius questions this (*Jesaja*, i, 230; ii, 364), as the word must not be confounded with the plur. form (κωνίαι, *Beh-shim*), "wild grapes" (q. v.), in Isa. v, 2, 4. See BOTANY.

Codex Alexandrinus, etc. See ALEXANDRIAN MANUSCRIPT, etc.

Codex Canonum Ecclesiæ Universæ is the name of a work published at Paris in 1610 by Christ. Justeau (Justellus), which undertook to give the canons of the first councils in a shape as conformable as possible to the collection of canons which the Council of Chalcedon (451) was supposed to have made. This *codex canonum*, etc., was reprinted in the *Bibl. jur. can. vet.* (tom. i, p. 29), published by Justellus and Voëllus. The supposition which led to the compilation of this work, that the Council of Chalcedon had made or ordered to be made such a collection of canons, is erroneous. It is true that the resolutions of the ancient Church councils were early collected and circulated among the bishops, and that at the Council of Chalcedon many of the bishops had with them collections containing the canons of the five synods of Nice, Ancyra, Neo-Cæsarea, Gangra, and Antiochia, from which many passages were read. But it appeared that in the arrangement of the canons the collections widely differed, and it is not known that the council took any action with regard to the matter.—Wetzer u. Welte, *Kirchen-Lex.* ii, 649.

Codex Justinianus, a code composed by order of the Emperor Justinian, and intended to embrace all that was still available of former collections of imperial manuscripts and edicts, as well as of edicts then recent. The previous collections were, 1. The *Codex Gregorianus*, compiled by Gregorianus, who lived about the middle of the fourth century. It contained the "Constitutions" (the collective name for the "Rescripts," or replies to particular inquiries and requests, and the "Edicts," or orders on general questions) of the emperors up to the time of Constantine; 2. The *Codex Hermogenianus*, compiled by Hermogenes, likewise about the middle of the fourth century, and containing the "Constitutions" of Diocletian and Maximian; 3. The *Codex Theodosianus*, compiled in the first half of the fifth century by order of the Emperor Theodosius II, by a committee of sixteen jurists, and containing the Constitutions of the emperors from Constantine to Theodosius. It was promulgated by Theodosius in 438 in the Eastern empire, and in the same year by Valentinian in the Western. It was divided into sixteen books, of which the first five and the former part of the sixth are lost. All these three codes are found in the *Corpus Juris Ane Justinianæ*, published by Hänel. In Feb. 528 the Emperor Justinian ordered the preparation of a new code, which was to embrace all that was still of practical value of the three previous collections, and, in addition, all the constitutions issued since the publication of the Theodosian Code. This new collection was published in April, 529. After the publication of the *Pandects* (a compilation of the writings of former Roman

jurists) and the *Institutiones* (an introduction to the study of the Roman law), another revision was made in 534 by Tribonianus. This new revision (*Codex repetita prælectionis*) still forms an important portion of the *Corpus Juris Civilis*, while the first revision (*Codex vetus*) is lost. In its last revision, the *Codex Justinianus* consists of twelve books, each book containing a number of titles in chronological order. Up to the time of Constantine nearly all the constitutions are *rescripts* (rescripts); after that we meet with numerous *edicts* (edicts). The code of Justinian is of great importance for Church history and Church law, as a great many edicts of the Christian emperors concerned religious questions. In quoting the code of Justinian, first the number of the constitution is given, next the special code (Greg., Herm., Th., Just.) from which it is taken; and finally the title; thus, c. 45. C. Just. i, 3, *de episc. et cler.*, which means constitution 45 of the Justinianean code (that is, the entirely new portion of it), book i, title 3, which treats of *episcopis et clericis*.—Wetzer u. Welte, *Kirchen-Lexikon*, ii, 650.

Codman, JOHN, D.D., a Congregational minister, was born in Boston Aug. 8, 1782; graduated at Harvard 1802, and studied law until the death of his father, when he commenced theology, and completed his studies at Edinburgh. After preaching a year in Great Britain, he came back to America, and was ordained pastor in Dorchester, December 7, 1808. In 1834 he went to England as delegate to the Congregational Union of England and Wales. He died Dec. 23, 1847. He was made D.D. by the college of New Jersey, 1822, and by Harvard, 1840. Dr. Codman published a *Visit to England* (1835); *Sermons* (1834, 8vo); and a number of occasional discourses.—Sprague, *Annals*, ii, 492.

Cœlestine (Pope). See CELESTINE.

Cœlestins. See CELESTINS.

Cœlestius, a native of Ireland (or of Bretagne?) of noble birth. According to Marius Mercator (*Commentarium*, 2), he was a law student at Rome when Pelagius arrived there. Embracing the views of Pelagius, he accompanied him in 408 (or 409) to Sicily, and in 411 to Africa. By his character and talents he succeeded, even better than Pelagius, in diffusing the views which they held in common. He was accused of heresy before the bishop of Carthage, A.D. 412, and condemned. He appealed to Rome; and on his way stopped at Sicily, and there spread his opinions very successfully. Thence it is supposed that he went to Ephesus, where he was ordained presbyter. In 417 Pope Zozimus, at Rome, was so far satisfied by the explanations of Cœlestius that he recommended the African bishops to restore him. In 418 he was condemned by a synod at Rome, and went to the East for safety; but about 429 he was banished from Constantinople by order of the emperor. The Council of Ephesus condemned him A.D. 431. His later years are involved in obscurity. "He wrote a *Confessio Fidei Zozimo Pape oblata*, and various epistles and appeals, the substance of most of which can be gathered from the excerpts given by Augustine and Jerome; but none of his writings have come down to us entire. Cœlestius was a man of pure morality, and more zealous and active (perhaps more honest) than Pelagius as a controversialist. Jerome says of him (in an epistle to Ctesiphon, A.D. 415), 'Although a scholar of Pelagius, he is yet leader and master of the whole host.'—Cave, *Hist. Lit.* Anno 407, i, 246; Murdoch's *Mosheim, Church History*, N. Y., 3 vols., i, 870; Wiggers, *Augustinism and Pelagianism*, Emerson's transl., p. 40 sq.; Schaff, *History of the Christian Church*, iii, § 147. See PELAGIUS.

Cœlè-Syria (ἡ κοιλὴ Συρία; Vulg. *Cœlesyria*), "the hollow Syria," was (strictly speaking) the name given by the Greeks, in the times of the Seleucids, to the remarkable valley or hollow (*κοιλία*) which inter-

venes between Libanus and Anti-Libanus, stretching from lat. $33^{\circ} 20'$ to $34^{\circ} 40'$, a distance of nearly a hundred miles. As applied to this region the word is strikingly descriptive (see Dionysius, *Perieg.* 899-900). Thus a modern traveller observes: "We finally looked down on the vast green and red valley—green from its yet unripe corn, red from its vineyards not yet verdant—which divides the range of Lebanon and Anti-Lebanon; the former reaching its highest point in the snowy crest to the north, behind which lie the Cedars; the latter in the still more snowy crest of Hermon—the culmination of the range being thus in the one at the northern, in the other at the southern extremity of the valley which they bound. The view of this great valley is chiefly remarkable as being *exactly to the eye what it is on maps*—the 'hollow' between the two mountain ranges of Syria. A screen through which the Leontes (Litany) breaks out closes the south end of the plain. There is a similar screen at the north end, but too remote to be visible" (Stanley's *Palestine*, p. 899). The plain gradually rises towards its centre, near which, but a little on the southern declivity, stand the ruins of Baalbek or Heliopolis. In the immediate neighborhood of Baalbek rise the two streams of the Orontes (Nahr-el-Asy) and the Litany, which, flowing in opposite directions to the north-west and the south-east, give freshness and fertility to the tract enclosed between the mountain ranges. *Amyce*, the name of the plain through which the Orontes flowed (ὁ Ἀμύκης πεδίων, Polyb. v, 59), is derived by Bochart from the Syriac אַמְיָא, *Amia*, which means *deep*, and is nearly synonymous with the Greek *Cale* (*Geogr. Sac.* i, l, 1).

The term *Cœle-Syria* was also used in a much wider sense. In the first place it was extended so as to include the inhabited tract to the east of the Anti-Libanus range, between it and the desert, in which stood the great city of Damascus; and then it was further carried on upon that side of Jordan, through Trachonitis and Peræa, to Idumæa and the borders of Egypt (*Strab.* xvi, § 21; Polyb. v, 80, § 8; Josephus, *Ant.* i, 11, 5). Ptolemy (v. 15) and Josephus (*Ant.* xiii, 13, 2) even place Scythopolis in *Cœle-Syria*, though it was upon the west side of Jordan; but they seem to limit its extent southwards to about lat. $31^{\circ} 30'$, or the country of the Ammonites (*Ptol.* v, 15; Josephus, *Ant.* i, 11, 5). Ptolemy distinctly includes in it the Damascus country. In the time of David, *Cœle-Syria* was probably included in "Syria of Damascus," which was conquered by that monarch (2 Sam. viii, 6), but recovered from Solomon by Rezon, the son of Eliadah (1 Kings xi, 24). The possession of it was an object of many struggles between the Seleucids and the kings of Egypt (Polyb. i, 8; ii, 71; iii, 1; v, 40; xvi, 39; xxvii, 17).

There can be little doubt that a part at least of *Cœle-Syria* was included in that "Valley of Lebanon" (בְּקֵצֵר הַלְּבָנוֹן) mentioned by Joshua (xi, 17; xii, 7), the extent of which has been too much restricted by recent geographers. The name "Valley of Lebanon" could scarcely be applied with propriety *exclusively* to that section of the great valley which lies at the base of Hermon, at a considerable distance from the range of Lebanon. Doubtless Baal-Gad was situated "under Mount Hermon;" but we have reason to believe that the "Valley of Lebanon" includes the whole of that valley which separates the ridge of Hermon from that of Lebanon. It seems that at a subsequent period this valley was called by Amos, apparently in contempt, "the valley of idols" (בְּקֵצֵר הָאִדֹלִים, chap. i, 5). See *AVEN*. The name was most appropriate. The whole sides of the valley are thickly studded with old heathen temples. Mr. Porter visited no less than fourteen of them, and he heard of several others. Some of them were of great size and splendor, as those of Baalbek, Mejdol, Nîha, and Hibbari-

yeh. This appears, in fact, to have been the chosen house of idolatry (Porter's *Damascus*, i, 12; ii, 320; *Hand-book of S. and P.* p. 568, 570; Robinson, *Liter. Bib. Res.* p. 488, 492, 520). The modern name of the valley confirms the above view. It is called *el-Bekaa*, which is strictly the same as the Heb. *Bikāh* (בִּיקָה).

In the apocryphal books there is frequent mention of *Cœle-Syria* in a somewhat vague sense, nearly as an equivalent for Syria (1 Eedr. ii, 17, 24, 27; iv, 48; vi, 29; vii, 1; viii, 67; 1 Macc. x, 69; 2 Macc. iii, 8; iv, 4; viii, 8; x, 11). In all these cases the word is given in the A. V. as "Celo-Syria," i. e. *Cœlo-Syria*. In Eedr. vi, 8, it is called simply "Syria." Under the emperor Diocletian, Phœnicæ and *Cœle-Syria* formed one province, called Phœnicia Libanica. Under the present Turkish government the western part of *Cœle-Syria* is in the pashalik of Saïde, and the eastern in the pashalik of Damascus.—Kitto, s. v.; Smith, s. v. See *SYRIA*.

Cœliōōlēs ("worshippers of heaven"), the name of an African sect in the 4th century, who appear to have blended together some parts of Judaism and Paganism with Christianity. An edict of Honorius (A. D. 408) forbids their assemblages and demands their disbandment. As they are counted in this edict among the heretics, and as they were not subject to the jurisdiction of the Jewish patriarch, but had their own chiefs, called majores, and as they had a kind of baptism, they are by some regarded as a Christian sect. By others they are regarded as an offshoot of the Esenes. See Schmid, *Historia Cœlicolæarum* (Helms 1704).—Gieseler, *Church History*, i, § 73; Bingham, *Orig. Eccl.* xvi, 6, 2.

Cœlln. See *CÖLLN*.

Cœmeteria. See *CEMETERIES*.

Cœna Domini, the Lord's Supper. See *LORD'S SUPPER*.

CœNA DOMINI, BULL OF. See *BULL*; and *IN CœNA DOMINI*.

Cœnobites, monks who formed a community living in a fixed habitation (*cœnobia*) under a chief (abbot or father). Their name is derived from *cœnōc*, *common*, and *biōc*, *life*; and they are opposed to hermits, who live in solitude. Pachomius is admitted to be the instigator of the *cœnōbic* life, as being the first that gave a rule to any community.—Bingham, *Orig. Eccl.* vii, 2; Coleman, *Ancient Christianity*, ch. vii, § 5. See *MONACHISM*.

Coffee (drink in the East). See *CUP*.

Coffer (צִפְרָן, *argas*; Sept. *θησαυρος*, Vulg. *capsella*), the receptacle (apparently a customary appendage to a cart, from the use of the *article* in every occurrence) which the Philistines placed beside the ark when they sent it home, and in which they deposited the golden mice and emeralds that formed their trespass-offering (1 Sam. vi, 8, 11, 15). The root seems to signify to be *shaken* about; and Gesenius and Lee agree in regarding it as the same, or nearly the same thing, as the Arabian *rijasa*, which Jahuri describes as "a kind of wallet, into which stones are put: it is hung to one of the two sides of the *haujā* [a litter borne by a camel or mule] when it inclines towards the other." Dr. Lee, however, thinks that the Hebrew word denotes the wallet itself; whereas Gesenius is of opinion that it means a *coffer* or small box, to which, from its analogous use, the same name was applied.—Kitto, s. v. See *ARK*.

Coffin (אָרוֹן, *aron*), a box for gathering articles: Sept. *σοφός*) is used with reference to the burial of Joseph (Gen. i, 26): "They embalmed him, and he was put in a *coffin* in Egypt." This was undoubtedly a *mummy-chest*, such as are now found in the tombs of the same country, and frequently exhibited in modern museums [see *MUMMY*].—a mode of burial peculiarly favorable to the removal of that patriarch's remains to

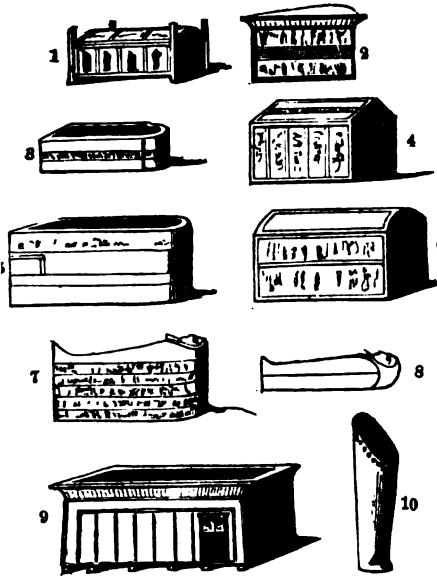

Different Forms of Mummy-cases.

1, 2, 4, of wood; 3, 5, 6, 7, 8, of stone; 9, of wood, and of early time—before the 18th dynasty; 10, of burnt earthenware.

Ægyptine (ver. 25, where the term "bones" is evidently used in this general sense). See BURIAL; PULCHRE.

The same word is spoken in the original of a "mon-y-chest" (2 Kings xii, 10, 11) [see TREASURY], but most frequently of the sacred "ark," in which were deposited the tables of the law. See ARK. It has been thought by some that the iron "bedstead" of Og Deut. iii, 11) was rather his coffin. See GIANT.

Numerous coffins of earthenware were disinterred by Loftus at Wurka and by Layard at Niffer, varying in length from three to six feet, and closed by an oval lid; the corpse having been swathed in linen and then smeared with bitumen, except the features (Layard, *Vin. and Bab.* p. 474 sq.).

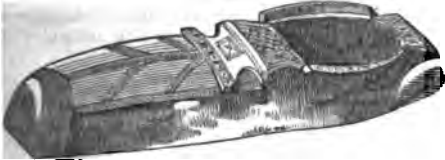

Ancient Babylonian Coffin.

COFFIN (prob. from Saxon *Cofa* = a cave). "The light wooden case in which bodies are now interred appears to be of comparatively recent origin; in earlier ages the graves were sometimes lined with slabs of stone, but usually a stone coffin formed of a single block was used, and the body placed in it, either en-

and they are usually rather wider at this end than at the other; there are generally one or more small holes in the bottom to drain off moisture: these coffins were never buried deeply in the ground; very frequently they were placed close to the surface, so that the lid was visible, and when within a church formed part of the paving; sometimes, in churches, they were placed entirely above the ground."—Parker, *Concise Glossary of Architecture*, s. v.

COFFIN, CHARLES, D.D., a Presbyterian minister, was born at Newburyport, Mass., Aug. 15, 1775, and graduated with distinction at Harvard in 1793. Having completed his theological studies, and taught for some time in Phillips Academy, he was licensed in 1799. He now visited the Southern states for his health, and, after spending some time in Virginia, was appointed vice-president of Greenville College, Tenn., in 1803. Returning to New England in 1804, he was ordained as an evangelist, and removed with his family to Greenville in 1805. In connection with his college duties, he had charge of the Harmony Church, and supplied for many years the churches in Hawkins County, at Rogersville, and at Jonesborough. In 1810 he was elected president of Greenville College, and served till 1827, when he was called to the presidency of the East Tennessee University, Knoxville. He resigned in 1833, and returned to Greenville, where he died June 8, 1853.—Sprague, *Annals*, iv, 246.

COGAN, THOMAS, M.D., an English Unitarian writer, was born at Rowell, Northamptonshire, in 1786. He officiated for some time as a Presbyterian minister at Amsterdam, but finally studied medicine, and practised in London. He died in 1818. He published (1) *A Treatise on the Passions* (Bath, 1802, 8vo); and 2d part, Bath, 1807-10);—(2) *Theological Disquisitions on Natural Religion and Jewish Morals* (Lond. 1812, 8vo);—(3) *Characteristic Excellencies of Christianity* (Lond. 1813, 8vo);—(4) *Letters to Wilberforce, on the Doctrine of Hereditary Depravity* (Lond. 1815, 8vo);—(5) *Ethical Questions* (Lond. 1817, 8vo).—Darling, *Cyclopædia Bibliographica*, i, 714.

COGITATION (Chald. *רַיָּוָן*, *rayon'*, thought, Dan. vii, 28), an earnest action of the mind, elsewhere translated simply "thought."

COGSWELL, WILLIAM, D.D., a Congregational minister, was born in Atkinson, N. H., June 5, 1787, and graduated at Dartmouth in 1811. He was ordained pastor in Dedham April 20, 1815, and resigned in 1829 to accept the situation of general agent of the American Education Society, of which, in 1832, he was chosen secretary and director. In April, 1841, he resigned, and was elected professor of history and national education in Dartmouth. In January, 1844, he went to Gilmanton as president of the theological seminary. He died April, 1850. Dr. Cogswell published *A Catechism on the Doctrines and Duties of Religion* (1818);—*Assistant to Family Religion* (1826);—*Theological Class-book* (1831);—*Harbinger of the Millennium* (1833);—*Letters to Young Men preparing for the Ministry* (1837); and several occasional sermons. He was editor of the *Amer. Quart. Register*, of the *N. H. Repository*, of the 1st vol. of the *New England Hist. and Genealog. Register*, and some other works.—Sprague, *Annals*, ii, 605.

COHABITATION. The delicacy of this subject did not prevent its being a subject of Mosaic legislation. See CHILDBIRTH. The following are some of the most important Scriptural notices respecting it. See MARRIAGE; CONCUBINE.

1. Every *concupiscitio*, even conjugal and legitimate, subjected both parties to a state of ceremonial impurity until evening (Lev. xv, 18; Joseph. *Apion.* ii, 24; comp. Strabo, xvi, 745), a regulation which certainly served not merely to restrain polygamy, but was also useful in a sanitary point of view. A similar statute originally prevailed among the Babylonians (Herod. i, 198; see Wesseling, in loc.). See UNCLEANNES.

2. Whoever corrupted a maiden, either by deceit or force, was compelled to marry her, and pay her father a fine (properly 50 shekels, Deut. xxii, 28 sq.); the latter must still be paid even when the father refused to permit the marriage (Exod. xxii, 17; comp. Philo, *Opp.* ii, 811; Mishna, *Chetub.* iii). If the man used violence he forfeited the right of divorcing the woman ever after (the Egyptian law was still more severe on this point, Diod. Sic. i, 78). See **TRISPASS**.

3. In the case of seduction or rape occurring to a betrothed female in an inhabited spot, she must cry for help, or be considered as assenting to the debauchment, and thus subjected to the same punishment of stoning as the male party; but if she was in a lonely field, where her screams for assistance could be of no avail, she was presumed to have been forced, and the ravisher alone was stoned (Deut. xxii, 28 sq.; comp. Joseph. *Ant.* iv, 8, 23; Philo, ii, 812); yet even in these cases the later interpreters of the law understood a repudiation by a bill of divorce as allowable (comp. Matt. i, 19; see Paulus, *Comment.* i, 123). A priest's daughter thus playing the courtesan was (stoned and) burnt (Lev. xxi, 9). (See generally Michaelis, *Mos. Recht.* ii, 815 sq.; iv, 298 sq.; v, 308 sq.) See **FORNICATION**.

Cohort (cohors), a military term used by the Romans to denote a company generally composed of 600 foot soldiers; a legion consisted of ten cohorts, every cohort being composed of three maniples, and every manipule of 200 men; a legion, consequently, contained in all 6000 men. Others allow but 500 men to a cohort, which would make 5000 in a legion. It is probable that cohorts among the Romans, as companies among the moderns, often varied as to their number. See **ARMY**. Besides the regular legionary cohorts, there were certain others separate and distinct from any legion, as the *Cohortes Urbane* and *Prætorie*. Such appears to have been the "Italian band" mentioned in Acts x, 1, which was in attendance on the Roman governor, who at that time was residing at Caesarea. Of the same description also was the "Augustan band" or cohort (Acts xxvi, 1), which most probably derived its name from Sebaste, the capital of Samaria. The commanding officer of an ordinary cohort was called *Tribunus Cohortis* if it was composed of Roman citizens, or *Prefectus Cohortis* if composed of auxiliary troops. See **BAND**.

Coin. Before the Babylonian exile (see Deyling, *Observ.* iii, 222 sq., also in Ugolini *Theaur.* xxviii) the Hebrews had and knew no regularly stamped money, but generally made use of a currency in traffic consisting of uncoined shekels (or talents) of silver, which they weighed out to one another (Gen. xxiii, 16; Exod. xxii, 17; 2 Sam. xviii, 12; 1 Kings xx, 89; Jer. xxxii, 9 sq.; comp. Pliny, xxxiii, 18), just as among other nations in most ancient times uncoined metal served for money (*Ælian, Var. Hist.* xii, 10; Strabo, iii, 155), and even to this day the Chinese make their commercial transactions by means of silver bars (Rosenmüller, *Morgenl.* i, 98; see Sperling, *De nummis non cæsis*, in Ugolini *Theaur.* xxviii). Among the earliest Hebrews, but not afterwards (Crusius, *De originib. pecunie a pecore ante nummum sign.* Petropol. 1748), an ox or other animal (comp. Pliny, xxxiii, 8) was traded instead of cash (see Michaelis, *De siclo ante exil. Babyl.* in the *Comment. Soc. Gott.* ii, 1752, § 1). Yet already in the time of Abraham there circulated in hither Asia, as it seems, silver ingots (קֶשֶׁטִים, Gen. xxxiii, 19; Josh. xxiv, 82; see Gesenius, *Theas. Heb.* p. 1241; Bertheau, p. 24; Tuch, *Gen.* p. 899, 472) of a determined weight, which was probably indicated by marks (Gen. xxiii, 16; xliii, 21) stamped upon them (so the Targum of Jonathan explains the former passage by שֵׁטֶרֶטִים אֲבִירָא, i. e. *paragmaria*). See **KEBITAH**. Even under the regularly organized Hebrew state all silver pieces (comp. *aprypta, silverling*) may have

passed in exchange (as among their Phœnician neighbors; but see Herod. i, 94; Philostr. *Her.* x, 1), although destitute of national authority (see 1 Sam. ix, 8; comp. Exod. xxx, 13; Lev. xxvii, 3 sq.; Deut. xiv, 26), the bars being weighed only in payment of large sums (comp. 2 Kings xii, 4), although modern Oriental merchants weigh out even regularly coined money (Volney, *Voyage*, ii, 315). See **MERCANT.** For transportation and preservation, money, as at this day in the East, was deposited in bags (2 Kings v, 2; xii, 10; see Harmor, *Observ.* iii, 262). See generally, Bertheau, *Gesch. d. Isr.* p. 14 sq.) See **BAG**.

After the exile Persian money was most current, especially the *daric* (q. v.), then Græco-Syrian of the Seleucidæ (q. v.), till the time (B. C. 143) of prince Simon (q. v.) the Maccabee, who secured from the Syrian monarchs the right of a native coinage (1 Mac. xv, 6), and issued shekels (q. v.), both whole and half, of which several (some eight) are still extant. The following coin has on one side, in Samaritan, the name of Simon, and some emblems, upon which it is very difficult to pronounce, and on the other "The Deliverance of Jerusalem," with the palm-tree and two vases. There are other coins, bearing on one side the



Coin of Simon Maccabæus.

inscription, in Samaritan, "Simon," on the other, "The Deliverance of Jerusalem," which are supposed to have

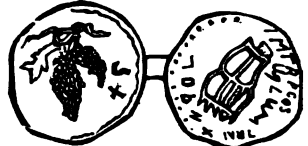

Probable Coin of Simon Bar-cochab.

been struck by Simon Bar-cochab, not by Simon Maccabæus. There are marks on these coins of their having been struck twice, once by the Roman authorities, and again by the Jews; there are also examples of

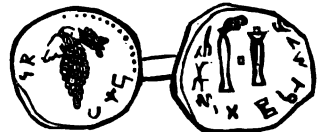

Early Jewish Coin of uncertain Date.

Greek and Roman coins of these double types applied one upon the other. A leaf and vase appear to be the general symbols of the coins struck in Judæa during the dominion of the high-priests, and the coins themselves are for the most part indifferently executed. Those of Alexander Jannæus are all of bronze, as are also the coins of Antigonus; these last bear the symbol of a cornucopia, the type invariably found upon the coins of this prince. From the inscriptions on the



Coins of Antigonus.

above coins, it is supposed that Antigonus wished to declare that it was in the capacity of descendant of Mattathias that he was high-priest. The coins of the

udean kings, from Herod the First, are all of bronze, with the exception of a silver one assigned to Herod the Third, which is supposed to be unique. Of Agrippa the Second there are many coins, struck after the destruction of Jerusalem, which present on their reverses portraits of the reigning emperors. The dates on these coins denote the year of the prince's reign. See each of the kings in their order.) Eventually, however, these Maccabean shekels passed out of circulation on account of foreign traffic (being especially upplanted by Tyrian mintage, according to Bertheau, p. 45 sq.). See MONEY-CHANGERS. In the time of Christ Greek currency had mostly prevailed (computed, probably, at a depreciated rate), of which the following pieces are mentioned: the *drachma* (q. v.), which was the unit of value; the *didrachma* (q. v.), or double drachm (*διδραχμον*, Matt. xvii, 24); and the *stater* (q. v.), or tetradrachm. The smallest coin was the *lepton* (*λεπτόν*, scale, "mite," Mark xii, 42; Luke xii, 59), which was the seventh part of a gold piece (*χαλκούς*), or half the Roman quadrans or "farthing." See MITE. Under the Roman rule the imperial currency naturally obtained in Palestine (see Matt. xxii, 17-21), so that thenceforth the Roman became the standard (so in the Mishna, *Baba Me'ia*, iv) of Jewish valuation (see Strong's *Harm. and Expos. of the Gospels*, Append. J). Single coins of this currency named in the N. T. are the following: (a) The *denarius* (q. v.), in Greek *denarius* (*δηνάριον*, Talm. דנרין, A. V. incorrectly "penny"), the usual unit of popular estimation, corresponding about to the modern *skilling*; (b) The *assarus* (from *as* [i. e. *aes*, brass], which was strictly the basis of the Roman monetary system, like the modern *penny*), in Greek *assarium* (*ασσάριον*, Talmudic *אסרין*), of copper (Matt. x, 29; Luke xii, 6), originally $\frac{1}{2}$, then $\frac{1}{4}$ the denarius; it bore the effigy of the emperor, during whose reign it was struck. See PENNY. (Comp. Kyppe, *Observ.* i, 57 sq.; Barth, *Das röm. As und seine Theile*, Lips. 1834.) (c) The *quadrans* (or quarter), in Greek *hodranes* (*κοδράνης*, Matt. v, 26; Mark xii, 42), which was $\frac{1}{4}$ the as, a copper coin. See FARTHING. The Attic drachma passed as equivalent to the Roman denarius. There are also occasional references to other and smaller coins (see the Mishna, *Maaser Sheni*, ii, 9; iv, 8; *Kiddushin*, i, 1; ii, 1), e. g. the *obolus* (*אבול*, *me'á*) = 4 assaria; the *pondium* (*פונדיון*) = 2 assaria; besides certain antique values, e. g. the *sz* (*סז*) = $\frac{1}{2}$ shekel, or $\frac{1}{4}$ the *stater*; the *perstah'* (*פרסתה*) = piece of money in general, etc. (see Buxtorf, *Lex. Talm.* col. 175, 1235, 1754, 1812; Waserus, *De nummis Hebraeor.* l. ii, c. 28). Coins were punctured and hung as nowadays around children's necks for ornament (Mishna, *Chelim*, xii, 7). (See Otho, *Lex. Rab.* p. 431 sq.; Klemm, *De nummis Hebraeor.* Tübing. 1730; Eisenschmidt, *De ponderib. et mensuris vet. Rom. Græc. et Heb.* ed. 2, Argent. 1787; Wurm, *De ponderum, numerorum et mensura. rationib. ap. Rom. et Græc.* Stuttgart. 1821.) See MONEY.

The intrinsic worth of money in the various periods of the Hebræo-Jewish antiquity is very difficult to estimate from the occasional intimations of mercantile value (see Michaelis, *De pretiis rer. ap. Hebr. ante exil.* in the *Comment. Soc. Gott.* iii, 145 sq.), especially as the measure and quality of articles thus estimated is also uncertain (see Böckh, *Metrolog. Untersuch.* p. 420 sq.). See METROLOGY. Examples somewhat indicative of this point, however, are the following: in times of plenty, 1 ephah of wheat sold for 1 shekel, and 2 ephahs of barley for 1 shekel (2 Kings vii, 8; comp. Polyb. i, 15); an Egyptian horse in Solomon's time was worth 150 shekels (1 Kings x, 29); 80 shekels were generally given for a slave (Exod. xxi, 32; comp. Gen. xxxvii, 28); for 10 shekels a chaplain could be hired in the times of the Judges (Judg. xvii, 10).

But in flush times prices were often much higher, e. g. a choice vine-stock was held at 1 shekel (Isa. vii, 23); a threshing-floor, with the oxen, cost David 50 shekels (2 Sam. xxiv, 24); a single vineyard brought Solomon in 1000 shekels yearly (Cant. viii, 11). Other less definite values may be collected as to fancy matters (Judg. xvii, 4; 1 Sam. ix, 8; Neh. v, 15). In later times a learned slave might be bought (according to Greek and Roman money) for 1 (Alexandrian) talent (Joseph. *Ant.* xii, 4, 9); a farm-laborer's daily wages was 1 denarius (Matt. xx, 2); and the charge for more than a single day's tending of an invalid in a caravanserai was 2 denarii (Luke x, 35). (For other instances of expense, see Josephus, *Ant.* xiv, 2, 2; *War.* i, 83, 5; *Life*, xiii, 44.) The comparative cheapness of living among the Israelites (as among the ancients generally, see Böckh, *Staatskaut.* i, 65) is evident, owing, however, rather to the greater rarity of the precious metals as a circulating medium than to anything else.—Winer, i, 408. See NUMISMATICS.

Coinlin Manuscript (so called from the library of Coinlin, bishop of Metz, which originally contained most of the leaves), a name applied to two very different Greek uncial MSS.

1. **CODEx COIBLINIANUS**, the great copy of the Sept. Octateuch, first made known by Montfaucon (*Biblioth. Coislin.* 1715), and illustrated by a *fac-simile* in Silvestre's *Palæogr. Unse.* No. 65. It contains 227 leaves in two columns, 18 inches by 9: the fine massive letters of the sixth or seventh century are much like those of the Alexandrian MS. In the margin, *primæ manus*, Wetstein found Acts ix, 24, 25, and so inserted this as Cod. F in his list of MSS. of the Acts. In 1842 Tischendorf observed nineteen other passages of the N. T., which he published in his *Monumenta Sacra Inedita* (p. 400 sq.), with a *fac-simile*. These texts are Matt. v, 48; xii, 48; xxvii, 25; Luke i, 42; ii, 24; xxiii, 21; John v, 35; vi, 53, 55; Acts iv, 33, 34; x, 18, 15; xxii, 22; 1 Cor. vii, 89; xi, 29; 2 Cor. iii, 18; ix, 7; xi, 33; Gal. iv, 21, 22; Col. ii, 16, 17; Heb. x, 26. These portions of the MS. are designated as F^a of the Gospels, etc.—Scrivener, *Introd. to N. T.* p. 105.

2. **FRAGMENTA COIBLINIANA**, a relic of only fifteen leaves, written stichometrically, with a subscription referring to a comparison with the copy at Cæsarea, which had been written by Pamphilus himself. The letters are large and square. When somewhat faded, the whole (except the subscriptions, which were written in vermilion) was gone over again, most coarsely, by a corrector, who added the accents and breathings, but reblacked the letters in such a manner as thoroughly to destroy their elegance. Fourteen of these leaves were published by Montfaucon (*ut sup.*), who ascribed the MS. to the fifth or sixth century. These sheets were used at Mt. Athos in 1218 as part of the covers of another book, which at length fell into European hands, and was saved; the rest of the MS. had probably perished previously, or been destroyed in a similar manner. After the fire of St. Germain des Prex, where the fragments were preserved, twelve leaves only were found, which are now in the Imperial Library at Paris, and contain 1 Cor. x, 22-29; xi, 9-16; 1 Tim. iii, 7-18; Tit. i, 1-3; i, 15-ii, 5; iii, 18-15; Heb. ii, 11-16; iii, 18-18; iv, 12-15. Two other leaves, however, were transferred to the Imperial Library at St. Petersburg, and contain Gal. i, 4-10; ii, 9-14. Tischendorf has lately recovered another sheet from Mt. Athos, containing Col. iii, 4-11. These fragments are known as H of the Pauline Epistles.—Tregelles, in Horne's *Introd.* new ed. iv, 194. See MANUSCRIPTS, BIBLICAL.

Coke, THOMAS, LL.D., first bishop of the Methodist Episcopal Church, was born at Brecon, Wales, Sept. 9, 1747; became a gentleman commoner of Jesus College, Oxford, in his 17th year, and after his graduation had charge of South Petherton parish, Somerset-

shire. While there he came under the influence of Methodism, and the increased fidelity and earnestness of his ministry excited so much opposition that he abandoned the place and joined Wesley, whom he equalled, if he did not surpass, in itinerant ministerial labors. In 1784 Wesley consecrated him a bishop for the Methodists in America, and in the same year he presided at the organization of the Methodist Episcopal Church at Baltimore, Md., and consecrated Francis Asbury a bishop. If we except some local consecrations in the Moravian settlements, Coke was the first Protestant bishop of the Western hemisphere. For many years he visited Ireland annually, and presided in its Conferences; he was repeatedly president of the English Conference; he traversed England, Scotland, Wales, and America throughout his long life. He was especially the "foreign minister" of Methodism. His stature was small, his voice feminine, but his soul was as vast as ever dwelt in a human frame. Though he became the first bishop of Methodism in the United States, he found not in a diocese coextensive with the new republic room for his energies. He was continually contriving new measures for the extension of the Gospel. His plans, had he been a man of ordinary abilities, would have entitled him to the name of fanatic; but he was one of those rare spirits whose greatest conceptions and schemes are the legitimate products of their energies. He crossed the Atlantic eighteen times at his own expense. To the end of his life he had charge of the Methodist missions throughout the world. He founded the negro missions of the West Indies, which have exerted an important influence on the history of those islands. They included 17,000 members at the time of his death. He not only visited his missions, but spent almost the whole of his patrimonial fortune in their support, preached for them, and begged for them from door to door. The missionary spirit was with him "as a burning fire shut up in his bones;" and during his life it was not deemed necessary to organize a missionary society among the Wesleyans, for he embodied that great interest in his own person. When a veteran of almost seventy years, he presented himself before the Wesleyan Conference as a missionary for the East Indies. The Conference objected on account of the expense, but Coke offered to pay the charges of the outfit himself to the amount of \$80,000, and so prevailed over all objections, and embarked with a small band of laborers. He died on the voyage in 1814, and was buried in the sea; but the undertaking succeeded, and the Wesleyan East India missions are the result. It has been justly asserted that, except Wesley, no man was ever connected with the Methodist body who contributed more to extend the blessings of Christianity. His colleague in the episcopacy of the American Church would not allow of even this exception; "a minister of Christ," said Asbury, when the news of his death arrived—"a minister of Christ, in zeal, in labors, and in services, the greatest man of the last century." Wesley used to say that Coke was a right hand to him. Withal he was a voluminous writer, publishing *A Sermon on Education*, 1778; *An Address to the Inhabitants of Bristol*, 1782; his ordination sermon at Baltimore, 1784; and many other sermons on the *Divinity of Christ*, *The Witness of the Spirit*, and three funeral discourses on the deaths of Wesley, Rev. Mr. Richardson, and Hester Ann Rogers; four sermons on the *Christian Ministry*; *A Discourse on the Seventh Chapter of the Epistle to the Hebrews*. He also issued *An Address to the Societies in England on the Settlement of the Chapels*, 1795; *An Address to the Weepers*, on a pamphlet of William Hammet, of South Carolina; *Letters to the Societies*, in reply to Rev. Melville Horne, 1810; *Life of Wesley*, prepared jointly with Henry Moore; *History of the West Indies*, in 3 vols. 1808; numerous reports and addresses on the missionary cause; *Commentary on the Scriptures*, 6 vols. 4to, completed in 1807; and,

subsequently, *Recent Occurrences of Europe considered in Relation to such Prophecies as are now fulfilling or remain yet to be fulfilled*; and the *Cottagers' Bible*, with reflections at the end of the chapters for family reading. See *London Review*, Oct. 1860, art. iii; Drev, *Life of Coke* (New York, 1837); Etheridge, *Life of Coke* (Lond. 1860); Sprague, *Annals*, vii, 130; Benson, *Life of Coke* (N. Y. 8vo); Stevens, *History of Methodist*, vols. ii and iii passim, and *Hist. of the Methodist Episcopal Church*, 4 vols. passim.

Co'la (Χωλά, v. r. Κωλά and Κελλά), a place named only in the Apocrypha (Judith xv, 4) in connection with Chobai (q. v.), as one of the cities to which Ozias sent orders to expel the enemies of the Jews after the death of Holofernes. Simonis (*Onom. N. T.* p. 170) suggests Abel-mecholah. Reland, however (*Palæst.* p. 729), thinks it may be the CULOA (q. v.) inserted by the Sept. among the cities of Judah (Josh. xv, 60).

Colarbasians. See COLARBASUS.

Colarbasus, the name of a Gnostic mentioned by Hippolytus (*Elenchos*, iv, 13; vi, 5, 55), Epiphanius (*Hæret.* 85), Theodoretus (*Hæret. Fabul.* i, 12), Tertullian (*adv. Valentin.* 4, and in the appendix to the *Præscriptæ*, c. 50), and Augustine (*de Hæret.* c. 15), and whose system, according to these writers, was akin to that of Valentinus, and still more to that of Marcus, representing likewise the emanation of sons according to the order of the letters of the alphabet and of numbers. According to these writers, in the system of Colarbasus, the first emanation (the "Ogdoad" of Valentinus) did not signify eight different substances, but only eight different relations and effects of the one God, which, according to their different signification, received different names. In the system ascribed to Colarbasus, the sons were not successively begotten, but all simultaneously brought into existence. To the λόγος and the ζωή a place was assigned in this system after the ἀνδρωπος and the ισαλησια, an order differing from that in the system of Valentinus. Dr. Volkmar, in an essay entitled *Die Colarbasus-Gnosis* (in *Niedner's Zeitschrift für hist. Theol.* 1856), undertakes to show that all the accounts of Colarbasus in the writers above mentioned can be traced to the description by Irenæus (i, 12, 8 sq.) of the system of the Gnostic Marcus and some modified systems; that the word Colarbasus with Irenæus (i, 14, 1) is nothing but the mystical designation of the personified number Four (ϛϛϛϛ) of the highest sons, the holy τετρακτύς; and that all the subsequent accounts arose from an erroneous confusion of the two statements. This view of Volkmar has been adopted by most of the recent writers on Gnosticism.—Herzog, *Real-Encyclop.* viii, 19 (of which our article is a free translation); Wetzer u. Welte, *Kirchen-Lex.* ii, 691.

Colbert, Charles-Joachim, a relative of the great Colbert, was born at Paris, June 11, 1667, became vicar of Rouen, and general-agent of the French clergy. In 1797 he was made bishop of Montpellier, and devoted himself a great deal to induce the Reformed to apostatize. It was under his episcopate that the noted catechism called *Catechisme de Montpellier* was drawn up by father Poujet. Colbert, in several pastorals and mandements, opposed the bull *Unigenitus* (q. v.). Some of his writings (8 vols. 4to, 1740) were condemned at Rome. He died April 8, 1738.—Hofer, *Nouvelle Biog. Générale*, xi, 114.

Colbert, Jacques Nicolas, Roman Catholic archbishop of Rouen, of the same family, was born at Paris in 1654, was made archbishop at an early age, and was noted in his administration for his tolerance of the Reformed. He was one of the first members of the Academy of Inscriptions and Belles-Lettres. He died Dec. 10, 1707.—Hofer, *Nouvelle Biographie Générale*, xi, 112.

ἡ ἀποστολικὴ ἐπιστολὴ πρὸς τὸν ῥωμαιοὺς ἀποστόλου Παύλου
 τὸ κεφάλαιον τοῦ πρώτου ἐπιγράμματος καὶ τὸ κεφάλαιον τοῦ
 δευτέρου ἐπιγράμματος καὶ τὸ κεφάλαιον τοῦ τρίτου ἐπιγράμματος
 καὶ τὸ κεφάλαιον τοῦ τέταρτου ἐπιγράμματος καὶ τὸ κεφάλαιον τοῦ
 πέμπτου ἐπιγράμματος καὶ τὸ κεφάλαιον τοῦ ἕκτου ἐπιγράμματος
 καὶ τὸ κεφάλαιον τοῦ ἑβδόμου ἐπιγράμματος καὶ τὸ κεφάλαιον τοῦ
 ὀγδόου ἐπιγράμματος καὶ τὸ κεφάλαιον τοῦ ἐνάτου ἐπιγράμματος
 καὶ τὸ κεφάλαιον τοῦ δέκατου ἐπιγράμματος καὶ τὸ κεφάλαιον τοῦ
 ἑξήκτου ἐπιγράμματος καὶ τὸ κεφάλαιον τοῦ ἑβδομήκτου ἐπιγράμματος
 καὶ τὸ κεφάλαιον τοῦ ὀγδοήκτου ἐπιγράμματος καὶ τὸ κεφάλαιον τοῦ
 ἐξήκοντος ἐπιγράμματος καὶ τὸ κεφάλαιον τοῦ ἑξήκοντος ἐπιγράμματος
 καὶ τὸ κεφάλαιον τοῦ ἑξήκοντος ἐπιγράμματος καὶ τὸ κεφάλαιον τοῦ
 ἑξήκοντος ἐπιγράμματος καὶ τὸ κεφάλαιον τοῦ ἑξήκοντος ἐπιγράμματος

Colbert Manuscript (Codex Colbertinus), the latest critical designation of a beautiful cursive Greek MS. of the N. T., now deposited in the Royal or Imperial Library at Paris, of which it is No. 14 (Colbert. 2944); usually designated as 88 of the Gospels, 18 of the Acts and catholic Epistles, and 17 of the Pauline Epistles. It is very important in Biblical criticism, being styled by Eichhorn "the queen among the MSS. in cursive letters" (*Eimlei. ms N. T. v, 217*). It contains all the Greek Test. except the Apocalypse, and includes a portion of the Sept. version of the Prophets. The order of the books is now much confused, but from the writing they appear once to have been arranged as usual. The edges of nearly all the leaves are torn, or cut away, or have otherwise decayed. The MS. has been much injured by exposure to dampness, and the ink has set off on the opposite page, especially in the Acts, so that it is very difficult to read (Tregelles, *Account of the Printed Text of the Greek N. T.*, p. 162). In this way, however, by reading backward the parts thus transferred, many passages have been recovered of which the original writing has become totally effaced, or even the material containing it has perished. It is written on vellum, in folio form, with 42 long lines in each page, in a fine round hand (which undergoes a gradual change in the course of the work), the accents sometimes neglected. Larroque first collated it, but very negligently, and his readings, as communicated by Allix, were inserted in Mill's edition of the New Testament, whence they were transferred to Wetstein's. Griesbach re-examined it in part; then Begtrup to some extent; and Scholz fully, but it would seem cursorily; Tregelles carefully collated it in 1850. "Its text was published by Sabatier" (Davidson, *Treatise on Biblical Criticism*, ii, 246). It evidently belongs to the eleventh century, and remarkably confirms the readings of the oldest codices, especially those known as B, D, and L, leaning chiefly to the Alexandrian recension.—Scribner, *Introduction to the Criticism of the N. Test.*, p. 145; Tregelles, in *Horne's Introduction*, new ed. iv, 209. See MANUSCRIPTS, BIBLICAL.

Colbert, William, a pioneer of the Methodist Episcopal Church in Western New York, was a native of Maryland. He was admitted on trial into the Philadelphia Annual Conference in 1790. In 1792 we find him at the General Conference in the city of Baltimore; he then became connected with the circuits of Tioga and the lake country (a perfect wilderness at the time), and here he labored faithfully and uncomplainingly, notwithstanding the difficulties of all kinds which he had to encounter, until 1811, when he located. In 1826 he was readmitted as a supernumerary, which

relation he retained until his death in 1838.—*Minutes of Conferences*, ii, 281; Peck, *Early Methodism*, p. 89, 121, 272.

Cole, Henry, D.D., an English Romanist divine, and opponent of the Reformation, was born at Godshill, Isle of Wight, and was educated at Winchester School and New College, Oxford, where he became fellow in 1528. In 1540 he became rector of Chelmsford; in 1542, warden of New College. On the accession of Edward VI, Dr. Cole inclined to the Reformation, but afterwards returned to his original views, and after Queen Mary's accession he became a zealous Romanist. When Cranmer was burnt, Cole preached a violent sermon at the execution. In 1557 he was made "vicar-general of spiritualities" under Cardinal Pole. He was prominent in "all the proceedings against Protestants in those dreadful times." In the first year of Elizabeth he was fined 1000 marks "for contempt of the queen's majesty," and in May, 1560, he was sent to the Tower, where he did not remain long. He died in London in 1579. Among his writings are, *Disputation with Cranmer and Ridley*, 1554; *Funeral Sermon at the burning of Cranmer* (both in Fox's *Acts and Monuments*); *Letters to Bishop Jewell*, Lond. 1560, 8vo.—*Strype, Annals*; Burnet, *History of the Reformation*; Hook, *Eccles. Biography*, iv, 126.

Cole, Thomas, an English Nonconformist, was educated at Westminster School, and at Christ Church, Oxford. In 1656 he became principal of St. Mary's Hall, where he was tutor to John Locke. In 1680 he was ejected from Oxford by the king's commissioners for nonconformity, and opened an academy at Nettlehead, Oxfordshire. Thence he removed to London, where he became pastor of a large congregation, and one of the lecturers at Pinners' Hall. He was a strong opponent of the Neonomian (q. v.) doctrine. He died in September, 1697. Among his writings are, *A Discourse on Regeneration, Faith, and Repentance*, Lond. 1689, 8vo; *A Discourse of the Christian Religion; Imputed Righteousness for Justification incomprehensible by Human Reason*.—Calamy, *Nonconformist's Memorial*, i, 196.

Coleridge, SAMUEL TAYLOR, was born at Ottery St. Mary, in Devonshire, of which parish his father was the vicar, on the 21st of October, 1772. An orphan at the age of nine, he was sent to Christ's Hospital, where Charles Lamb was among his contemporaries. Here he made very great progress in classical knowledge, and at an early age plunged deeply into metaphysics. Speaking of himself in the *Biographia Literaria* (vol. i, p. 15), he says: "At a very premature age, even before my fifteenth year, I had bewildered myself in metaphysics and in theological controversy. Nothing else pleased me. History and particular facts lost all interest in my mind. Poetry itself, yea, novels and romances, became insipid to me." In 1791 he entered Jesus College, Cambridge, but in the second year of his residence he suddenly left the University in a fit of despondency, occasioned, it is said, by unrequited love; and after wandering for a while about the streets of London in extreme pecuniary distress, terminated this adventure by enlisting in the 16th Dragoons, under the assumed name of Comberbatch. One of the officers, questioning him in a friendly manner, and eliciting his real history, communicated Coleridge's situation to his friends, who forthwith effected his discharge. Coleridge now betook himself to Bristol, where he joined with three other young and clever men, like himself of ardent poetic temperaments, and imbued with strong but vague ideas of universal brotherhood—Southey, George Burnet from Oxford, and Lovell, a young Quaker. They formed a scheme for emigrating to the banks of the Susquehanna in North America, to form a social colony, where selfishness was to be proscribed. But money was needed to establish this "pantisocracy," as they

termed it, and Coleridge had not enough to furnish him with daily subsistence. Joseph Cottle, a benevolent bookseller at Bristol, finding that he had written enough poems to make up a small volume, offered him thirty guineas for them. The volume was published in 1794, and other literary schemes were projected. In 1795 Coleridge married Miss Sarah Fricker, of Bristol, a sister of the wife of his friend Charles Lloyd. In 1796 he published a volume of poems, the greater number of which had been written at earlier periods, interspersed with some by Charles Lamb; and in 1797 a second edition appeared, with the addition of some poems by Charles Lloyd.

Coleridge was at this period of his life a Unitarian. He says of himself, "I was at that time, and long after, though a Trinitarian (i. e. *ad normam Platonis*) in philosophy, yet a zealous Unitarian in religion; more accurately, I was a *panentheist*, one of those who believe our Lord to have been the real son of Joseph, and who lay the main stress on the resurrection rather than the crucifixion" (*Biog. Lit.* i, 168). In 1798 Coleridge visited Germany, and went through a course of German literature. On his return to England he went to live at the Lakes, where Southey and Wordsworth had then settled, the one at Keswick, and the other at Grasmere. The appellation of "Lake-poets" was given to these three writers after the publication of the *Lyrical Ballads*. Coleridge now became connected with the *Morning Post*, and wrote both on politics and literature. From about 1808 to about 1814 he contributed to the *Courier*. In 1809 he edited the *Friend*, first published as a periodical at the Lakes. He left the Lakes in 1810, and did not afterwards return to them; his wife and children remained in the house of Southey, and wholly dependent on him. On Coleridge's first arrival in London he resided with Mr. Basil Montagu, and in 1816 he became the guest of Mr. Gillman at Highgate, in whose house he died. The many friendships which Coleridge attracted to himself through life, the sincerity and constancy of which were abundantly shown, place in a striking light the amiability of his character; his neglect of his family and extreme carelessness respecting the obligations, both personal and pecuniary, which devolved upon him, as strikingly illustrate its weakness. It was not before the commencement of his residence in London that he formed any very extensive acquaintance with the writings of the later German metaphysicians, by the adoption of whose method and terminology, rather than by any development of a system, in his subsequent publications, he came to be accounted the representative of German metaphysics in England. He published successively, between the years 1817 and 1825, the *Lay Sermons*, the *Biographia Literaria*, the bound volume of the *Friend*, the *Constitution of the Church and State according to the Idea of each*, and the *Aids to Reflection*. During most of his life Coleridge was poor and dependent, from careless improvidence. He suffered also from chronic ill health, combined with, and to a certain extent caused by, a habit of using opium. He died July 25, 1834.—*English Cyclopædia*.

Of Coleridge as a poet we do not here speak. As a metaphysical theologian, his influence upon his own age, and especially upon its younger men of genius, was greater than that of any other Englishman. His mental attributes were of a high order, strangely blended, and thoroughly cultivated. To a subtlety which would have distinguished him in the age of scholasticism, he added a great compass of thought. The devotional and expository writings of the best English divines, such as Hooker, Taylor, Baxter, Leighton, and Wesley, were congenial food for his mystical and religious nature. With his enlarged knowledge he abandoned Unitarianism, and formed for himself a half-complete theology, partly orthodox, partly mystical, and partly (though unconsciously) pantheistic.

"It was one of his most cherished schemes—his favorite vision in cloudland—to compose a work of colossal proportions which should embrace the whole range of mental philosophy taken in its widest meaning, including, of course, theology and religion. He really only wrote a few disconnected fragments of his mighty task. But these fragments have proved of immense suggestiveness to younger intellects," and *Coleridgean* may be found now among every class of English divines, from the Broad Church to the highest Puseyites. The condition of the English mind at the time of Coleridge's appearance is to be noted, as accounting for the wonderful influence he gained. "The received philosophy was sensationalism in intelligence and thought, and utilitarianism in morals; and the received theology contented itself with dealing forth, when didactic, the dry husks of a powerless moralism, and, when argumentative, with insisting upon the external evidences of Christianity. Grotius and Paley (whose *Moral Philosophy* was a text-book at Cambridge) were the oracles on the subject of the Christian evidences. Arianism and Unitarianism, always found alongside of sensationalism and materialism, had crept like a fog-blight over half the face of British Christianity. In such a state of things, it is easy to understand how the appearance of a teacher like Coleridge would be welcomed. He was the declared enemy of the sensational and utilitarian philosophers. He was reputed to have mastered the German philosophy, to have abstracted from it what was sound and true, and to have attained to a clear vision, from the utmost height of human thought, of the ultimate unity, the perfect and vital harmony, of philosophy and theology, of the revelation of reason and the revelation of God. He professed himself a devout and orthodox Christian believer. Most of all, he impressed and attracted the young men of his time by his noble ideal of thought and purpose, his reverent spirit, his far-seeing, practical wisdom, his critical and intuitive sagacity, his union of deep learning, fine taste, and recluse habits, with philosophic breadth of view and wide human sympathies.

"One main point, perhaps the main point, of Coleridge's *Philosophy* was the Kantian distinction between the reason and the understanding. Upon this distinction Coleridge grafted his peculiar, and, as we think, unchristian doctrine of the Logos. Many who have not followed Coleridge in the theological doctrine have agreed with him in reference to the metaphysical distinction, according to which the understanding is the logical faculty in man, the reason is the intuitive faculty, which stands face to face with spiritual and essential truth; and the immediate object of which is, as Mr. Morell says, 'the good, the beautiful, and the true.' The intuitive faculty in man has thus assigned to it an entirely separate sphere, and that the very highest. It dwells in a region apart, elevated above that of the logical understanding, and is quite independent of it. Being thus independent of the understanding, it is independent, so far as the morally good and right is concerned, of revelation also (which must be presented to it through the understanding), except in so far as it may, by its own light and authority, approve and warrant that which revelation brings before it. For reason, understood as above defined, must, whether in matters of taste, criticism, or morals, be the supreme judge, and be a law unto itself. Thus the scintillations of genius and the light of piety are but different manifestations of the same faculty. How well this accords with Coleridge's supplementary doctrine, that reason is the light in man of the divine Logos, and how naturally it is developed into Maurice's doctrine of the identification of the Word or Son of God, with all men, will be readily seen. How nearly related it is to the modern Pantheism is no less obvious. Coleridge, in a passage of his *Table Talk*, with which many passages in his writings fully accord, speaks of 'that higher state, to which Aristotle could

never raise himself, but which was natural to Plato, and has been to others' [himself, for instance], 'in which the understanding is distinctly contemplated, and, as it were, looked down upon from the throne of actual ideas, or living, inborn, essential truths.' He speaks of the spirit's ascending into 'the empyrean of ideas.' He identifies the reason with the divine Logos, making him, in this sense, to be the 'light which lighteth every man that cometh into the world.' He denies, as many have learned from him to deny, the possibility of a revelation *ab extra*. He speaks of the Trinity as an 'idea,' and analyzes this 'idea' in such a way as to resolve the Tri-unity into what is really no better than a refined, Platonized Sabellianism—only not Sabellianism, because not allowed to be conceived under any conditions of time and space. Such are some of the results of Coleridge's peculiar philosophy as applied to solve, or as used to measure and define, the mysteries of being, human and divine" (see Curry, in *Methodist Quarterly*, Jan. 1864, art. ii; and Rigg, in *Meth. Quarterly*, April, 1866, art. i; July, 1866, art. i). His views of *Inspiration*, as given in the *Confessions of an Inquiring Spirit*, are almost as low as those of the Rationalists. His theory of the *atonement* seems to exclude almost entirely the idea of substitution, in order to avoid what he calls the "commercial" theory.

The only uniform edition of Coleridge's works is that of Professor Shedd (N. Y. Harpers, 1858, 7 vols. 12mo). Prefixed to it will be found Marsh's admirable Preliminary Essay to the *Aids to Reflection*, and also an able and genial Introductory Essay by Professor Shedd. The work needs nothing but an Index to be complete. Of Gillman's *Life of Coleridge* (London, 1838), two volumes were promised, but only one has appeared. In 1866 appeared Dr. J. H. Green's *Spiritual Philosophy, founded on the Teaching of S. T. Coleridge*, edited by J. Simon (London, 2 vols. 8vo). Critical essays on Coleridge abound in the leading reviews: among those that examine his philosophical theology and its results are papers in the *Christian Spectator*, vi, 617; *Princeton Review*, xx, 144; *Bibliotheca Sacra*, iv, 117; *Theological Journal* (Lord's), i, 681; *Am. Biblical Repository*, July, 1849, art. i; *British Quarterly*, Jan. 1854, art. iv.

Coles, Elisha, a native of Northamptonshire, was made steward of Magdalen College, Oxford, during the Commonwealth, when the famous Independent, Dr. Goodwin, was head of that college. After the Restoration he obtained a clerkship in the East India House, which he is supposed to have held until his death in 1688. His name is preserved by his well-known treatise entitled *A practical Treatise on God's Sovereignty*, originally published in 1678, 4to, and many times reprinted. It is thoroughly Calvinistic.

Coles, George, a minister of the Methodist Episcopal Church, and for many years a journalist. He was born in England, June 2, 1792; converted at twelve; became a local preacher in 1814; emigrated to America in 1818, and immediately entered the itinerant ministry in the New York Conference. He was an "effective preacher" for thirty-three years, and on the 1st of May, 1858, he died in New York. He was an invalid more than half of his life, yet eminently cheerful and useful. Though his advantages of education while young were limited, he was nevertheless a very well-read man, and for twelve years was eminently successful as assistant editor of the *Christian Advocate and Journal*, and three years sole editor of the *Sunday-school Advocate* and Sunday-school books. Among his published works are *The Antidote* (18mo), *Lectures to Children* (18mo), *Scripture Concordance* (18mo), *My youthful Days* (18mo), *My first seven Years in America* (18mo), and *Heroines of Methodism* (12mo). Mr. Coles was a sincere and simple-hearted Christian gentleman, loving all, by all beloved. As a preacher, although not powerful, he was clear, instructive, persuasive,

and eminently consolatory. "His journal, which was carefully kept for nearly fifty years, shows how he longed to live and labor for God." His death was peaceful and beautiful.—*Minutes of Conferences*, 1858, p. 148.

Colet, Dr. JOHN, was born in London in 1466; was educated at Oxford, and travelled on the Continent for seven years, where he made the acquaintance of many eminent scholars, especially of Erasmus, Budæus, and Linacer, and where he also learned Greek. He obtained Church preferment when very young. In 1497 he commenced lecturing at Oxford on St. Paul's Epistles, and drew crowds of students. In 1505 he was made dean of St. Paul's, in which capacity his endeavors to restore discipline brought on him, though happily without effect, a charge of heresy. He introduced divinity lectures at St. Paul's, delivered by himself and others. "These lectures raised in the nation a spirit of inquiry after the Holy Scriptures, which had then long been laid aside for the school divinity, and so might be said to prepare a way for the reformation which soon after ensued. We cannot but think that Colet was in some measure instrumental towards it, though he did not live to see it effected, for he expressed a great contempt for religious houses, exposed the abuses that prevailed in them, and the mischiefs attending the imposing celibacy on the clergy. This way of thinking, together with his free and public manner of communicating his thoughts, which were then regarded as impious and heretical, rendered him very obnoxious to the clergy, and exposed him to a persecution from the bishop of London. Latimer tells us in his sermons, not only was Colet brought into trouble, but he would certainly have gone to the stake had not God turned the king's heart." In 1512 he founded and endowed the noble institution of St. Paul's School for 158 scholars. He died in 1519. He wrote a Latin Grammar for St. Paul's School, which was long in use. Among his religious writings were, *Daily Devotions, or the Christian's morning and evening Sacrifice* (London, 1698, 12mo); *Motion to a godly Life* (London, 1684); *Epistola ad Erasmus*, etc. See Knight's *Life of Dean Colet* (London, 1724, 8vo); Jones, *Christ. Biog.*; Seebohm, *Oxford Reformers* (London, 1867).

Col-oh'zeh (Heb. *Kol-chozeh*, כּוֹלֹחַזַּי, every seer; Sept. *Χολοζή, Χολοζά*), a descendant of Judah, being the son of Hazaiah, and father of one Baruch (Neh. xi, 5), B. C. ante 586. He had also a son named Shallun, who repaired part of the walls of Jerusalem after the Captivity (Neh. iii, 15).

Coligni, GASPARD DE, admiral of France, was born February 16, 1517, at his ancestral castle, Châtillon-sur-Loing. His father, Gaspard de Coligni, marshal of France, died early (1522), and bequeathed to his widow the task of educating three sons. In this she was assisted by two masters, one of whom instructed the boys in languages and philosophy, and the other in bodily exercises. Gaspard early distinguished himself for a firmness of character and purity of private life very rare in those days. His only friend was the young duke Francis of Guise, afterwards among his bitterest enemies. He entered upon the career of arms, and early won high celebrity in the wars against Italy and Spain. In 1547, at thirty, Coligni was made commander of the French infantry. The very severe discipline introduced by him changed the wild bands of lawless soldiery into an organized army. In 1547, the year in which his mother died, he was married to Charlotte de Laval. But the troubles of his times called him soon again and again to the front of battle; the happy issue of the campaign of 1562-55 is to be ascribed to him. He became governor of Champagne, later of Picardy and Isle de France. In 1552 he was made admiral of France. When King Henry II violated the truce, and the war with Spain broke out anew, Coligni was commissioned to defend St. Quentin

against the Spaniards. In spite of a heroic defence, on the 27th of August St. Quentin fell. Coligni was taken prisoner and brought to the Netherlands, where he remained two years. Here he became a Protestant. At the peace of Chateau-Cambresis in 1559, he regained his liberty for a ransom of 50,000 florins. Through the sudden death of Henry II (1559), and the ascension of his throne by Francis II, the Guises became temporarily all powerful, and Coligni lost many of his honors. He left the court with a light heart. He had been suspected of "heresy," but had not yet publicly confessed himself a Protestant. Aware that this step might be fatal to his family, it was only after his wife had gladly confessed to the "Church of Christ" that he partook of the Lord's Supper in presence of the whole village. The news was received with rejoicing among all Protestants. While Coligni lived a peaceful, secluded life with his family, the public discontent at the usurpations of the Guises had reached a climax. The conspiracy of Amboise in 1560 amply shows the state of popular opinion in France. Coligni did not participate in, though he seems to have known of the plot. But at the Convention of the Notables he made brave but ineffectual attempts to gain more freedom of worship for the Protestants.

The death of Francis II, in 1560, however, changed the whole aspect of affairs. Coligni and his brother Andelot were reinstated in their honors, and now more than ever Protestantism found a powerful protector in him. He took part in the terrible religious wars which lasted for thirty years. At the head of the Roman Catholic party stood the Guises, while Condé and Coligni led the Protestants. But the latter suffered severe reverses, and only after the assassination of Francis of Guise, 1563, by Jean Poltrot, fortune began to be once more favorable to them. Coligni was not implicated in this murder, as has sometimes been asserted. After the peace of Amboise, concluded March 19, in which freedom of conscience and of worship was granted the Protestant nobility, the admiral again retired to his estates in Châtillon. Four years later the war broke out anew, and was on both sides waged with the old spirit and bitterness. For a time the prospects of the Reformed party looked very dark. In 1569 Condé fell, and only a few weeks later Coligni's brother Andelot. The admiral's siege of Poitiers was a failure; and, while he withdrew his troops, the Parliament in Paris had condemned him to death, hung him in effigy, broke his escutcheon, and offered a price of 50,000 florins for his head. Coligni's life, indeed, was endangered by several attempts to assassinate him. But no reverses could break Coligni's spirit or daunt his energy. In 1570, at Arnay le Duc, the Protestants gained a complete victory; and shortly after all further movements were ended by a truce, which resulted in the peace of St. Germain.

Coligni's wife had died three years before, and in 1571 the admiral, although already at an advanced age, married Jacqueline, countess of Montlul and Entremont, a young, beautiful, intelligent, and pious lady of Savoy. Meanwhile the current of opinion at court seemed to be gradually settling in favor of the Protestants. The union of the two parties was to be completed by the marriage of Henry of Navarre (later Henry IV) to Margaret of Valois. Charles IX needed a man who would be equally respected by all parties, and Coligni was summoned to court. He went full of confidence in the king's good-will; and, indeed, it does not appear that Charles and his mother, Catharine de Medicis, had at that time any hostile intentions towards him. The admiral wept tears of joy at his reception in Blois (Sept. 18, 1571). The king embraced him, and both Charles and his mother showed him every honor. Gradually Coligni gained a decided influence over the king, and made good use of it in favor of

the Huguenots. Catharine became alarmed, and her jealousy of Coligni changed into hatred, although it appears that as yet Charles was not ill disposed towards the admiral. On the 18th of August, 1572, the marriage of Henry and Margaret took place. On the same day Coligni wrote to his wife that he hoped to see her soon as he was weary of court life. These were the last lines she ever received from his hand. Four days later, as he was walking in the street, a shot was fired at him from a house in the present Rue de Rivoli; a finger of his right hand was destroyed, and his left arm wounded. The assassination of the admiral was ascribed to the Guises, and filled all Paris with alarm and horror. The king visited Coligni, professed the greatest sympathy, and swore to the Protestants he would be revenged for the bloody deed. But Catharine de Medicis had resolved on Coligni's death. On the evening of the 23d, everything was prepared for the terrible massacre that was to take place on the following night. On the 23d, after midnight, a guard of only five men and a few servants remained with the admiral. In the morning, between one and two (Sunday, August 24), a murderous band approached the house. It had been resolved to kill the admiral first, and then give the signal for the general massacre. The young Duke of Guise had undertaken to destroy his great enemy. The doors were burst open and the guards killed. At the first noise Coligni requested to be lifted from his bed, and said to his minister, "Say a prayer, sir; I put my soul into the Saviour's hand." A servant burst into the room, and on being questioned, replied, "God calls us." "I have long been ready to die," Coligni replied; "but you others save yourselves." The murderers entered the room, and found the admiral standing upright. One called to him, "Are you not the admiral?" "Yes," Coligni answered with dignity; "and you, young man, should respect my gray hairs, and not take my life." With an oath the soldier thrust his sword into Coligni's breast. His body, in which life was still not entirely extinct, was thrown out of the window. Guise, who had been waiting below, wiped the blood from the face of the corpse to recognise it, and kicked the body with his foot. An Italian, Petrucci, cut off the head and brought it to the Louvre. The body was mutilated, dragged through the streets of Paris, and at last hung upon the gallows by the feet. When Charles IX came to see it a few days later, he is said to have repeated the words of Vitellius, "The body of an enemy always smells well." In Parliament, on the 26th of August, he stated that the massacre of St. Bartholomew had been necessary to prevent the execution of a plot in which the king was to be assassinated, and accused Coligni of ingratitude and treason. The servile Parliament accepted these statements, declared Coligni a traitor, and decreed the forfeiture of all his rights and honors, which resolution was, however, afterwards completely revoked.—Herzog, *Real-Encyclop.* xix, 331 sq.; Hofer, *Nov. Biog. Générale*, xi, 187; Haag, *La France Protestante*, vol. iii.

Colinus (Κόλιος v. κ. Κώλιος, Vulg. Colis), a Levite "also called Calitas" (1 Esdr. ix, 23), for which the Heb. text (Esra x, 23) has "ΚΕΛΙΑΗ (q. v.), the same as Kelita."

Collar, the rendering of one Gr. and two Heb. words in the Auth. Vers. 1. פֶּה (peh, Job xxx, 18; where, however, some merely read פֶּה, as), properly signifies a *mouth*, in which sense it often occurs, and is hence applied to any aperture or orifice. See מוּתָן. It is frequently applied elsewhere (as in the passage cited) to the opening of a garment that closes around the neck, such as the tunic (Exod. xxxix, 23; Psa. cxxiii, 2). See עֲפֹתָי (2. אֲפֹתָי, *actiphoté*, *drops*, Judg. viii, 26), "collars," mentioned among the spoils of the Midianites, were a peculiar kind of *pe-*

domi, or ear-drop, probably of pearls, and hence different from the ordinary ear-ring (q. v.). The same term occurs in the list of female attire in Isa. iii, 19, where it is translated "chains" (q. v.). 3. "ἵμας" (Eclus. xxxiii, 26), a *thong*, i. e. strap for harnessing a beast of burden to the yoke (q. v.).

Collation (Lat. *collatio*). When a bishop gives a benefice, which either he had as patron, or which came to him by lapse, he is said to "collate" to that benefice the clergyman on whom he bestows it. Where the living is not in the gift of the bishop, he is said to "institute" the clergyman to it. The word collation is also used among ecclesiastical writers to denote the spare meal on days of abstinence, consisting of bread or other fruits, but without meat.—Hook; Eden.

Collect (Lat. *Collecta*, from *colligere*, to collect), a short form of prayer in the liturgies of the Roman Catholic and the Anglican churches. In a wider sense, the word *collecta* was used by ancient writers of the Latin Church, like the Greek *συναξίς*, to designate a meeting of Christians for public worship. But soon it came to be restricted to several portions of the liturgy. The origin of this signification of the word is doubtful. According to some ritualists, the name indicates the comprehensive brevity of such prayers, the matter of the epistle and gospel, e. g. being gathered up, or *collected*, into the collect for the day. Others derive the name from an ancient practice of the chief minister collecting into a single brief and public prayer at the end of some part of the service the previous (private) devotions of the people; accordingly, one of the service-books of the ancient Catholic Church was called *Collectarium*, as containing such prayers. Liturgical writers trace some of the collects to the Leonian Sacramentary used in the Roman Church about 483 A. D.; others to the Sacramentary of Bishop Gelasius of Rome (494); and the majority to the Sacramentary of Gregory I (590).

The collects in the Roman Missal begin with *Oremus* (Let us pray), and conclude with the invocation, "*Per Dominum nostrum Jesum Christum, filium tuum, qui tecum vivis et regnas in unitate Spiritus Sancti Deus per omnia secula seculorum. Amen.*" They occur before the Epistle, before the Preface and after the Commu-

ion, and consist sometimes of one, sometimes of several petitions; but if consisting of more than two, the introductory *Oremus* and the concluding "*Per Dominum*," etc., are used only twice, all the intermediate petitions being joined to the last. In solemn masses, the collects before the epistle and after the communion are sung. Similar collects as in the Missal occur in the Breviary.

On the collects retained in the Anglican Prayer-book, Dr. Comber remarks: "Our reformers observed, first, that some of those collects were corrupted by superstitious alterations and additions, made by some later hand. Secondly, that the modern Roman Missals had left some of the primitive collects quite out, and put in their stead collects containing some of their false opinions, or relating to their innovations in practice. When the mass had struck out an old and put in a new collect, agreeable to their new and false doctrines or practices, there the Reformers restored the old collect, being pure and orthodox. At the restoration of king Charles II, even those collects made or allowed at the Reformation were strictly reviewed, and what was deficient was supplied, and all that was but incongruously expressed was rectified, so that now they are complete and unexceptionable, and may be ranked into three several classes. First, the ancient primitive collects, containing nothing but true doctrine, void of all modern corruptions, and having a strain of the primitive devotion, being short but regular, and very expressive. The second order of collects are also ancient as to the main; but where there were any passages that had been corrupted, they were struck out, and the old form restored, or that passage rectified; and where there was any defect it was supplied. The third order are such as had been corrupted in the Roman Missals and Breviaries, and contained something of false doctrine, or at least of superstition, in them; and new collects were made instead of these at the Reformation, under king Edward VI; and some few which were added anno 1662."

The following tables of the Collects for Sundays and other holidays used in the English Liturgy were partly formed by bishop Cosins, and were published by Comber:

I. Collects retained from ancient Liturgies at the Reformation.

COLLECTS FOR	WHENCE TAKEN.
4th Sunday in Advent.	In some old offices for the first Sunday in Advent.
St. John's Day.	St. Greg. Sacr. and Gothic Liturgy.
The Epiphany.	St. Greg. Sacr.
1st, 2d, and 8d Sunday after Epiphany.	The same, and St. Ambros. Liturgy.
5th Sunday after Epiphany.	St. Greg. Sacr.
Septagesima.	The same.
Sexagesima.	The same.
2d, 3d, 4th, and 5th Sunday in Lent.	The same.
6th Sunday in Lent.	The same; but in St. Ambros. Liturgy for Good Friday.
Good Friday, the three Collects.	They are in all offices with little variation; but are left out of the Breviaries of Pius V. and Clement VIII.
Easter Day.	St. Greg. Sacr. and a Collect almost the same in the Gallic. Liturgy.
3d Sunday after Easter.	St. Greg. Sacr., St. Ambros. Liturgy.
5th Sunday after Easter.	St. Greg. Sacr.
Ascension Day.	The same.
Whit-Sunday.	The same.
1st Sunday after Trinity.	The same. This in some old offices is called the second after Pentecost; in others, the first after the Octaves of Pentecost.
The 8d, 4th, 5th, 6th, 7th, 8th, 9th, 10th, 12th, 13th, 14th, 15th, 16th, 17th, 30th, 31st, 22d, 23d, 24th, and 25th after Trinity.	Are all in St. Greg. Sacr.
The Purification.	The same.
St. Michael's Day.	The same.

II. Collects taken from ancient Models, but considerably altered and improved by our Reformers and the Reviewers of the Liturgy.

COLLECTS FOR	TIME OF IMPROVEMENT.	HOW IT STOOD BEFORE.
St. Stephen's Day.	Beginning added 1662.	Grant us, O Lord, to learn to love our enemies, etc.
4th Sunday after Epiphany.	End improved 1662.	Grant to us the health of body and soul, that all those things which we suffer for sin, etc.
4th Sunday after Easter.	Improved 1662.	Who maketh the minds of all faithful people to be of one will, etc.
Sunday after Ascension.	A little varied 1549.	This had been of old the Collect for Ascension Day, on which our venerable Bede repeated it as he was dying.
2d Sunday after Trinity.	The order inverted 1662.	Lord, make us to have a perpetual fear and love of thy holy name; for thou never failest, etc.
8th Sunday after Trinity.	Beginning improved 1662.	Whose providence is never deceived, etc.
11th Sunday after Trinity.	Improved 1662.	That we, running to thy promises, may be made partakers of thy heavenly treasure, etc.
18th Sunday after Trinity.	Improved 1662.	To avoid the infections of the devil, etc.
19th Sunday after Trinity.	Improved 1662.	That the workings of thy mercy may be in all things, etc.

COLLECTS FOR	TIME OF IMPROVEMENT.
St. Paul's Day.	Improved 1549 and 1662.
The Annunciation.	Improved 1549.
St. Philip and St. James.	Improved 1662.
St. Bartholomew.	Improved 1662.
Trinity Sunday.	

HOW IT STOOD BEFORE.
 In the Breviaries (Miscels) a new prayer was added, mentioning St. Paul's intercession; in the year 1549 the old prayer alone out of Greg. Sacr. was restored, which had our walking after his example only, which was a little varied in the year 1662. The Breviaries had put in a new prayer about the blessed Virgin's intercession, which was cast out in 1549, and the form being in St. Greg. Sacr. restored. As thou hast taught St. Philip and the other apostles, etc. To preach that which he taught, etc., was altered, because there is no writing of his extant. This Collect is no older than the Sacramentary ascribed to Alouina. The old offices have another Collect for it, and call it the Octave of Pentecost.

III. Collects composed anew, and substituted in the Place of those which, containing either false or superstitious Doctrines, were on this Account rejected.

COLLECTS FOR
1st Sunday in Advent.
2d Sunday in Advent.
3d Sunday in Advent.
Christmas Day.
Circumcision.
6th Sunday after Epiphany.
Quinquagesima.
Ash Wednesday.
1st Sunday in Lent.
Easter Even.
Easter Sunday.
1st Sunday after Easter.
2d Sunday after Easter.
St. Andrew's Day.
St. Thomas's Day.
St. Matthias,
St. Mark,
St. Barnabas,
St. John Baptist,
St. Peter,
St. James,
St. Matthew,
St. Luke,
St. Simon and St. Jude,
All Saints.

COMPOSED IN
 First Book of Edward VI, 1549.
 The same time.
 1662.
 1649.
 The same time.
 1662. Before this time they repeated the Collect for the fifth Sunday.
 1649.
 The same time.
 The same time.
 1662. No Collect for it ever before then.
 The first sentence (1 Cor. v, 7) was added 1662.
 1649. Then it was used on Easter Tuesday; and in 1662 was fixed for this Sunday.
 1649.
 1652. Second Book of Edward VI.

All composed anew in 1549.

See Wetzler u. Welte, *Kirchen-Lex.* ii, 665; Eadie, *Ecol. Dict.* 157; Hook, *Church Dictionary*, s. v.; Bingham, *Orig. Ecol.* bk. xv, ch. i; Palmer, *Orig. Liturg.* i, 819 sq.; Comber, *Companion to the Temple* (London, 1841, 7 vols.); Despensé, *Traité des Collectes*; Lebrun, *Explication des Cérémonies*, i, 192. See LITURGY.

Collection, (1.) תְּרִבּוּת, *maseth'*, something taken up, e. g. *tribute* (2 Chron. xxiv, 8, 9; elsewhere "gift," "mess," etc.); (2.) for συνάγωα, to *contribute* (Baruch i, 6); (3.) λογία, a pecuniary *collection* (1 Cor. xvi, 1; "gathering," ver. 2). See ASSESSMENT.

In the apostolic age the Christians of Palestine were more straitened than other churches, and this might be from their being assailed with every sort of oppression by the Jews. The activity of Paul in taking up collections on their behalf is evident from what is said in Acts xxiv, 17; Rom. xv, 25, 26; 2 Cor. viii and ix, and Gal. ii, 10. For this purpose the apostle, in 1 Cor. xvi, 2, says, "Upon the first day of the week let every one of you lay by him in store as God hath prospered him." The reason why this day was appointed for this purpose seems to be that, by the early Christians, the first day of the week was observed as the Sabbath of the Lord; and consequently, as on that day they commemorated that which formed the great bond of union between them and other Christians, it was the most suitable occasion for their displaying their love in the way prescribed, and also the time when they would be most liberal (1 Cor. xvi, 1-8). See ALMS.

Collector (ἀρχων φορολογίας, *chief of the tribute-levy*), a tax-gatherer (1 Macc. i, 29). See PUBLICAN.

College occurs (2 Kings xxii, 14; 2 Chron. xxxiv, 22) as the translation of מִשְׁנֵה (*mišneh'*, *second rank*), the residence of the prophetess Huldah (q. v.). The same term is used in Zeph. i, 10 (translated "second"), where the different quarters of Jerusalem are spoken of, and is found more fully in Neh. xi, 9 (where, instead of "the second over the city," the original has מִשְׁנֵה עַל הָעִיר הַשֵּׁנִי, "upon the city second," i. e. over the second part of the city). From all these notices we can only gather that there was anciently a quarter

or district that went by this appellation, but there is no definite intimation of its position. It may have been only another name for ACBA (q. v.), or the Lower City, which was built subsequently to the more fashionable portion of the city on Mt. Zion. The word occurs frequently elsewhere in its ordinary signification of persons or things that occupy a second place in order, dignity, honor, etc. See JERUSALEM.

COLLEGE (Lat. *collegium*, a collection or assemblage). (1.) "In its Roman signification, a college signified any association of persons for a specific purpose. In many respects it was synonymous with *corpus*, a body or collection of members, a corporation—with *universitas*, a whole as contrasted with its parts—and with *societas*, a company or partnership, as opposed to all the members of which it was composed. A Roman college had a common chest, and it could sue and be sued in the name of its manager (actor or syndicus), just like an incorporation with us. It required, also, to be incorporated by some sort of public authority, springing either from the Senate or the emperor. A college could not consist of fewer than three persons" (Chambers, *Encyclopædia*, s. v.). (2.) The term is applied to any company of persons associated upon some common principle; so we speak of the college of the apostles; the college of cardinals; a college or synod of bishops; and as "three" are required for a college, it has come to be usage that three bishops unite in the act of ordination of bishops. (3.) The word "college" is used also, in England, to designate "an endowed institution connected with a university, having for its object the promotion of learning. In this relation a college is a sub-corporation, i. e. a member of the body known as the University. The constitution of a college in this sense depends wholly on the will of the founder, and on the regulations which may be imposed by the visitors whom he has appointed. In Scotland and in America, the distinction between the college as the member and the university as the body has been lost sight of, and we consequently hear of the one and the other indiscriminately granting degrees, a function which in the English and in the original European view of the matter belonged

exclusively to the university. Where there is but one college in a university, as is the case in the universities of Scotland and most of those in America, the two bodies are of course identical, though the functions which they perform are different. In Germany there are no colleges in the English sense; and though the universities in that country perform precisely the same functions as in Scotland, the verbal confusion between the college and the university is avoided by the latter performing the functions of both in its own name, as two separate parts of its proper duties. In France the title 'college' has a meaning totally different from that which we attach to it: it is a school, corresponding, however, more to the gymnasium of Germany than to the grammar-school of this country. All the colleges are placed under the University of France, to which the centralizing tendencies of that country have given a meaning which also differs widely from that which the term university bears in England" (Chambers, *Encyclop. s. v.*). See UNIVERSITY.

Collegia PONTIFICIA (*papal colleges*), institutions for training Roman missionaries for service among "heretical" and pagan nations. The first was the German college at Rome, founded by Loyola in 1562. Greek, English, Hungarian, Maronite, and Thraco-Illyrian colleges were established by Gregory XIII. Scottish and Irish colleges followed; and the institution of the Congregation *de propaganda fide* was succeeded by the erection of the college which bears the same title. More recently, an "American college" (1854) and a South American college have been established.

Collegial or Collegiate Church: (1.) In the Roman Church, a church served by canons regular or secular. They originated in a desire to have mass conducted in towns which had no cathedral (q. v.), with greater pomp than could be had with one priest. Originally the canons dwelt in common in one college, but this was afterwards abandoned. See CANONS. (2.) In England there are several *collegiate* churches, which are served by a dean and a body of canons. They differ from cathedrals in that the see of the bishop is at the latter. The service is or should be the same in both. They are under the jurisdiction of the bishop of the diocese in which they are situated, and he exercises visitatorial powers over them. (3.) Several churches connected in one corporation are called "collegiate" churches: e. g. a combination of several Reformed Protestant Dutch churches in New York is so styled.

Collegial or Collegiate System, a mode of exhibiting the relation of Church and State employed by Puffendorf and Pfaff in Protestant Germany. The churches were regarded as being, after Constantine's time, legal corporations (*collegia facta*), with rights to form their creeds, conduct their worship, choose their presiding officer, admit and expel members; to make and administer by-laws, correct such abuses as might creep in among them, call in the aid of the civil power if necessary, or in certain cases to leave the exercise of these rights to others. It was assumed that the rights originally belonging to the congregations, which had been in course of time usurped by the hierarchy, were restored to the congregations by the Reformation, and were left by the Reformed congregations to the civil authorities. According to this view, the civil authority would have a double power with regard to the Church, the *ius circa sacra*, the right of superintendence and of patronage, which inheres in the secular authority, and the *ius in sacris*, the sum of the collegial rights in internal affairs of the Church, transferred to it (the secular government) as the representative of the congregations of the country. For some time this view was eagerly made use of by most of the Protestant state governments, but in modern times it has more or less given way in every country to a sounder concep-

tion of the relation between Church and State.—Wetzer u. Welte, *Kirchen-Lex.* ii, 667. See CHURCH AND STATE.

Collegiants, a party of the Remonstrants of Holland. It derived its name from the members calling their assemblies *colleges*. They rejected all creeds, all regular ministers, and all tests of communion and forms of ecclesiastical government. They are sometimes called *Rhinsbergers*, because they met twice a year at Rhinsberg, a village near Leyden. The Collegiants were confined to Holland; but some of their practices are followed by other religious bodies in other countries, as by the Plymouth Brethren (q. v.) in England.—Moeheim, *Church History*, cent. xvii, pt. ii, ch. vii.

Collegiate Church. See COLLEGIAL or COLLEGIATE CHURCH.

Collier, Jeremy, an English non-juror, was born in 1650 at Stow-with-Quy, Cambridgeshire. He passed M. A. at Caius College, Cambridge, in 1676, and obtained the living of Ampton, Sussex, which he resigned for the lectureship of Gray's Inn, 1685. At the Revolution of 1688 he not only refused the oaths, but was active in behalf of the dethroned monarch. In 1696 he was outlawed. At last he turned his talents to better ends, and made war on the licentiousness of the theatre. His first work on this subject was, *A Short View of the Immorality and Profaneness of the Stage* (Lond. 1738, 8d ed. 8vo). The wits in vain opposed him, and after a ten years' struggle, in which he wrote other books and pamphlets on the subject, he accomplished his object. The rest of his life was spent in various literary labors. He was consecrated a non-juring bishop by Dr. Hicks in 1718, and died in 1726. Collier was a man of eminent abilities, but of small reasoning faculty. Besides the books above named, he wrote *Ecclesiastical History of Great Britain* (new edition, with Life of Collier, Lond. 1840, 9 vols. 8vo); *Essays on Moral Subjects* (Lond. 3 vols. 8vo); *Historical, Geographical, and Poetical Dictionary*, from Moreri, with additions (Lond. 1701-27, 4 vols. fol.), besides numerous controversial tracts.—Macaulay, *Hist. of England*, iii, 863; *Life of Collier* (prefixed to his *History of England*); Hook, *Eccles. Biography*, iv, 187; *Biographia Britannica*, iv, 12.

Collier, Joseph Avery, a minister of the Reformed Protestant Dutch Church, was born at Plymouth, Mass., Oct. 26, 1828, graduated at Rutgers College, New Brunswick, N. J., July, 1849, and at the theological seminary of the Reformed Dutch Church in that city, July, 1852. Died at Kingston, N. Y., August, 1864. He was a clear, methodical, persuasive, and eloquent preacher. His literary attainments were unusually large, and entirely consecrated to his ministry. As a preacher to children and the young men he is entitled to the first rank. His publications were the following: *The right Way, or the Gospel applied to the Intercourse of Individuals and Nations* (a prize essay on Peace, Am. Tract Society, N. Y. 1854, of which over ten thousand copies have been circulated);—*The Christian Home, or Religion in the Family* (prize essay, Presbyterian Board, Phila. 1859);—*The Young Man of the Bible* (Am. Tract Soc. N. Y. 1861);—*Little Crowns, and how to Coin them* (N. Y. 1864; republished in England);—*Pleasant Paths for little Feet* (Am. Tract Soc. N. Y. 1864);—*The Dawn of Heaven, or the Principles of the heavenly Life applied to the earthly*, a posthumous work, to which is prefixed a brief and just biographical sketch by his brother, Rev. Ezra W. Collier (N. Y. 1865).

Collier, William, a Baptist minister, was born in Scituate, Mass., Oct. 11, 1771. He graduated at Brown University in 1797, studied theology under president Maxcy, and was licensed to preach in 1798. In 1799 he was ordained at Boston as minister at large,

but soon went as pastor to Newport, spent one year there, and four as pastor of the First Baptist Church, New York. In 1804 he became pastor of the Baptist church in Charlestown, Mass., where he remained sixteen years, a faithful and successful minister. In 1820, his health failing, he resigned his charge, and removed to Boston, where he remained during the rest of his life, doing service as minister at large. He was a pioneer of the temperance reform, and from 1826 to 1828 edited the *National Philanthropist*, the first temperance paper. He died March 29, 1848. Among his literary labors were a *Hymn-book*, a series of *Sermons from living Ministers* (begun in 1827), editions of Saurin and of Andrew Fuller, and several occasional Sermons.—Sprague, *Annals*, vi, 376.

Collins, Anthony, an English Deist, was born at Heston, near Hounslow, in 1676, and was educated at Eton and King's College, Cambridge. Being a man of property, he spent his life chiefly in literary pursuits. He died in 1729. His infidel principles brought him into collision with Bentley, Chandler, and many others. His chief works are: *Discourse on the Grounds and Reasons of the Christian Religion* (Lond. 1737, 8vo):—*Priestcraft in Perfection* (London, 1710, 8vo):—*Discourse on Free-thinking* (1713):—*Essay on the Thirty-nine Articles*, in reply to Bennet (Lond. 1724, 8vo), besides various pamphlets. In 1715 he published his *Philosophical Inquiry concerning Liberty and Necessity*, which was reprinted in 1717 in 8vo, with corrections, and was translated into French by Des Maizeaux (1720). Dr. Samuel Clarke replied to the necessarian doctrine of Collins chiefly by insisting on its inexpediency, considered as destructive of moral responsibility. Bentley's *Remarks upon a late Discourse of Free-thinking* (given in Randolph's *Enchiridion Theologicum*, vol. v) is a sharp and sarcastic, but fully adequate reply to the skeptical arguments of Collins. See Leland, *Deistical Writers*, ch. vi; Farrar, *Critical History of Free Thought*.

Collins, John, a Methodist Episcopal minister, was born in New Jersey in 1769. In 1803 he removed to Ohio, and entered the itinerant ministry in 1807. He was one of the pioneers of Methodism in the West. In 1804, while yet a local preacher, he preached the first Methodist sermon in Cincinnati to a dozen persons, in an upper room. With a brief interval, he labored as an itinerant until 1836, when he became superannuated. He died 1845. He was an able and faithful preacher, often impressively eloquent, and eminently successful as an evangelist. Revivals of religion followed his footsteps everywhere. An instructive sketch of his life, from the pen of Justice M'Lean, was published in 1850 (Cincinnati, 18mo).—*Minutes of Conferences*, iii, 650; *Meth. Quart. Review*, 1850, p. 324.

Collins, John A., a distinguished Methodist Episcopal minister, was born near Seaford, Del., 1801. His parents removed to Ohio in 1805, and to Georgetown, D. C., in 1812, and his academical education was obtained at the latter place. Giving early promise of talent, he was placed as a law student in the office of William Wirt; but the plan of his life was changed by his conversion at a camp-meeting in Loudoun Co., Va., in 1820. He joined the Methodist Episcopal Church, and in 1826 was licensed as a local preacher. In 1830 he entered the itinerant ministry in the Baltimore Conference, and his great talent as a preacher soon gained him a commanding reputation. He filled all the prominent appointments in his Conference as pastor, and served several terms as presiding elder. In 1836 he was elected assistant editor of the *Christian Advocate* at New York. This office he soon resigned, partly on account of the effect of the climate upon the health of his family, but mainly because he believed he could better serve the Church in the more regular duties of the ministry. Few men in any period of the history of the Methodist Episcopal Church have more success-

fully preached her doctrines, or more faithfully defended her discipline. He was elected to the General Conference as soon as he was eligible, and to every subsequent one down to the last, when he led the delegation. He had pre-eminent pulpit power. His sermons were marked with great clearness of thought, apt and scriptural illustrations, and were delivered with elegance of speech, and often with an eloquence, earnestness, and power that were overwhelming. As a debater on the floor of the General or Annual Conference he had few equals, certainly no superior. He died of pneumonia, after a short illness, May 7, 1857.—*Minutes of Conferences*, 1858, p. 16.

Collins, Judson Dwight, superintendent of the Methodist Episcopal missions in China, was born in Wayne County, N. Y., Feb. 12, 1822. He removed with his parents to Michigan in 1831, was converted in 1838, graduated in Michigan University 1845, entered the itinerant ministry in the Michigan Conference, and was appointed teacher in the Wealeyan Seminary at Albion in the same year. He was sent as missionary to China and superintendent in 1847, returned with impaired health in 1851, and died May 12, 1852, in Washtenaw County, Michigan. His mind was clear and vigorous, more solid than brilliant, and more logical than eloquent. "Years before the Church established the China mission, and while prosecuting his collegiate studies, he pursued a course of reading on China, preparatory to a whole life of missionary labor among its benighted millions, and his mind had no rest until it was actually surrounded by their darkness and misery. No temporary impulse led him thither, no transient fervent feelings urged him to a life of toil in that distant land; but a permanent conviction of duty possessed his mind, one great idea of supreme service to Christ controlled his whole existence, and carried all his thoughts, all his affections, all his impulses, to that extensive territory of heathenism, and his martyr-like attachments to his work were only loosened by death."—*Minutes of Conferences*, 1852, p. 118; Sprague, *Annals*, vii, 831.

Collins, Wellington H., a Methodist Episcopal minister, was born May, 1816, in Wolcott, Wayne County, N. Y.; removed with his parents to Michigan in 1830, was converted in 1835, began preaching in 1837 under the presiding elder, and entered the Michigan Conference in 1838. The Conference then included all of Michigan and North-western Ohio. After twenty years' service as a stationed minister and seven years as presiding elder, he died at Detroit, Aug. 11, 1858. He was delegate to the General Conference at Boston 1852, and also to that at Indianapolis in 1856. Mr. Collins was a man of great force of character. He was a masterly preacher, and was remarkably able in debate; but perhaps his highest excellence was in his safe judgment as a counsellor, by which he was always influential among his brethren.—*Minutes of Conferences*, 1858, p. 334; *Ladies' Repository*, xix, 449.

Collin, Daniel Georg Conrad von, was born Dec. 21, 1788, at Oerlinghausen, in the principality of Lippe-Deinold, where his father was minister. His family were of Moravian origin. He studied at Detmold, Marburg, Tübingen (under Platt and Schurrer), and finally in Göttingen. In 1816 he became professor *extraordinarius* of theology at Marburg, and in 1817, at the Reformation Jubilee, he became doctor of theology. In 1818 he received a double call, one from Heidelberg to the philosophical, the other from Breslau to the theological faculty. He accepted the latter. His academic discourses, embracing exegetic and historical theology, attracted the more gifted among the students. Besides his occasional academical writings (*De Joëlis propheta etate* [Marb. 1811], *Spicilegium observationum exegetico-criticarum ad Zephaniam vaticum* [Vratisl. 1818], *Memoria professorum theol. Marburg. Philippo Magnanimo regnante* [Vratisl. 1827], *Confessi-*

omnes Melanchthonis et Zwinglei Augustanorum capita graviora inter se conferuntur [Vratal. 1880]), and many valuable articles in journals, two books particularly have made his name universally known. First, his revision of the first volume, and the first part of the second volume, of the third edition of Münscher's *Christliche Dogmengeschichte* (Cassel, 1832 and 1834). This edition formed an epoch in the History of Dogmas. But his principal book is the *Bibliche Theologie* (2 vols. Leips. 1836, edit. by Schulz), which for a long time, especially in its Old-Testament part, was considered as the most excellent work on this science. He died on the 17th of February, 1838. In theology he was a moderate Rationalist. See a sketch of him by Schulz in the above-mentioned *Bibl. Theologie*, vol. i.—*Herzog, Real-Encyclop.* xix, 380.

COLLOPS OF FAT (פִּימָה, *pimah', fatness*), spoken of the thick flakes of fat flesh upon the haunches of a stall-fed ox, put as the symbol of irreligious prosperity (Job xv, 27). See **FAT**.

Collyridians, a sect of heretics which arose towards the close of the fourth century, so named from a small cake of a cylindrical form (κολυρίδες, *collyridæ*) which they offered to the Virgin Mary with libations and sacrifices. They were chiefly Arabian women, who rendered divine honors to the Virgin Mary as a goddess. It is conjectured by Neander that the cake-offering was a transfer of the oblations of the Lord's Supper to the worship of the Virgin, the whole taking the shape of a pagan ceremony; the truth probably being that the corruption was introduced from the pagan worship of Ceres, and that the customary bread-offerings at the heathen feast of the harvest, in honor of Ceres, had been changed for such offerings in honor of Mary.—See Epiphanius, *Hær.* 78; Mosheim, *Church History*, i, 811; Neander, *Church History* (Torrey's transl.), ii, 839.

Colman, an Irish missionary of the 7th century. Colman was the third ecclesiastic who by royal authority had been called from Ireland to preside over the see of Lindisfarne, in North Britain. During his and his predecessors' superintendency, the churches in that country which had been devastated by Penda, the last Pagan king, were restored, and were enjoying great temporal and spiritual prosperity. But about A. D. 662, the Anglo-Saxon clergy, who had deserted these churches in the hour of danger, wished to return and to share them at least with the Irish and Ionian missionaries. But here a difficulty arose. The English Catholic Church, as recently reconstructed by Augustine, and that of the Scots-Irish, were found to be so dissimilar in doctrine and usage that they could not conduct worship in the same edifices. The differences were numerous; among them were the question of the Three Chapters (q. v.), the tonsure, and the time of keeping Easter. An appeal to the pope was useless, for long before he had put forth his decision; but the Irish Church and those of Iona had not complied with it. Oswy, the king, required the whole to be presented to him for adjustment. The discussion was in Irish and Anglo-Saxon, by Colman and Wilfred, the venerable Ceada, bishop of the East Angles, acting as interpreter. When the arguments had ended, the king and a majority of the assembly decided for Wilfred and the Anglo-Catholics (see Bede, lib. iii, c. 25). This decision, however, was far from effecting peace. The dominant party soon became intolerant, and required the clergy of Colman to be reordained; that their churches, previous to the performance of Catholic worship, "should be sprinkled with exorcised water" (Usher, vol. vi, p. 274); and also that they should observe many new rites and usages to which they had been entire strangers. To all of these, like the Welsh Christians before them, Colman and the most of his clergy refused to submit, and quietly relinquished in North Britain the churches which they

had built or had restored, and in which they had successfully preached for nearly seventy years. Colman now returned to Ireland, taking with him all his own countrymen and thirty-six ecclesiastics or students who adhered to his teaching. For the latter he established on the east of the island an institution long known as "Mayo of the English," to which Bede says many flocked from England, that they might "gain knowledge and lead a holy life." But, notwithstanding his success in his new enterprise, he could not recover himself from his former defeat; he went abroad, traveled on the Continent, visited the East, and died about A. D. 676. See Bede, *Hist. Eccl.*, i. c., and also iv, 4; Moore, *History of Ireland* (Am. edit., Philad.).

Colman, BENJAMIN, D. D., an eminent Congregational minister, was born in Boston, Oct. 19, 1678. He graduated at Harvard 1692, and sailed for London 1695, but on the voyage was taken by a French vessel and carried to France. After remaining in England some three years, he was called to take charge of Brattle Street Church, Boston. He accepted, and was ordained Aug. 4, 1699, in London. He died Aug. 29, 1747. He was made D. D. by the University of Glasgow, 1781. Dr. Colman published a *Poem on Elijah's Translation, occasioned by the Death of Rev. Samuel Willard* (1707); *The Incomprehensibility of God, in four Sermons* (1715); *Five Sermons from Luke xi, 21, 22* (1717); *Observations on Inoculation* (1722); *A Treatise on Family Worship* (1780); *A Dissertation on the Image of God wherein Man was created* (1786); and a large number of occasional sermons.—Sprague, *Annals*, i, 228.

Cologne, a celebrated city on the Rhine, the seat of an early bishopric. The legend that a disciple of the apostle Peter, by the name of Maternus, was the founder and first bishop of the church of Cologne, is now generally abandoned even by Roman Catholic writers. Maternus, the first (historical) bishop of Cologne, is mentioned as early as 818 (Mansi, *Collectio Concil.* t. ii, fol. 486). The successor of Maternus, Euphrates, attended in 847 the Synod of Sardica, and was one of the delegates of this synod to the Emperor Constantius. The acts of a Synod of Cologne of 846, which state that Euphrates was deposed for being an Arian, are now generally regarded as spurious. In 623-668 we find Cunibert mentioned as archbishop of Cologne (Rettberg, *Kirchengesch. Deutschlands.* ii, 602); yet it does not appear to have been at the time a regular archbishopric, for bishops of Cologne are mentioned after that date, and Bonifacius (q. v.) in 748 subjected it to the metropolitan of Mayence, from which it was probably detached under Charlemagne, between 794 and 799, in order to be raised to the dignity of an archbishopric. A national synod was held at Cologne in 874, to regulate the administration of the goods of the Church, and to consecrate the cathedral. The importance this see had obtained in the 10th century is proved by the fact that the Emperor Otto I gave it to his brother Bruno I, the first archbishop who was at the same time a prince of the German Empire. Popes and emperors vied in increasing the wealth and power of the archbishop of Cologne, and synods held at that place declared him to have the right of precedence over all other clergy, the papal legates *a latere* alone excepted. About the middle of the 12th century, the archbishops of Cologne were elevated to the rank of electors. Prominent among the archbishops of this period were Anno II, who abducted the young emperor Henry IV, and Rainald, count of Dossel, an able general of the Emperor Frederick I, who patronized the anti-popes, and brought from Milan to Cologne the pretended bodies of the "three holy kings," which up to this day are venerated as the most precious relics of Cologne. The political troubles of the 12th and 13th centuries diminished the power of the archbishopric, but it rose again under Conrad von Hochstaden

(1288-1261). But, while outwardly prospering, the see was inwardly weakened by the relaxation of the clergy, which became so great that complaint was made of it to Pope Alexander IV, by whose direction Conrad held a synod at Cologne in 1260, for the purpose of reforming abuses (*Hartzheim, Concil. Germ.* iii, p. 588 sq.). In 1266 (according to others, 1271 or 1272) another council was held against the violators of the rules of discipline. After the Reformation of the 16th century, two archbishops of Cologne, Herman V, count of Wied, and Gebhard II, turned Protestants, and were on that account deposed. After that, the see was held for 178 years without interruption (until 1761) by Bavarian princes. Joseph Clement († 1728), who was elected in 1688, was not even ordained a priest until 1706. Clement Augustus (1728-1761) was at the same time bishop of Munster, Paderborn, Hildesheim, and Osnabrück. Maximilian Frederick (1761-1784) founded the Academy of Bonn. Maximilian Francis, archduke of Austria (1784-1801), changed the Academy of Bonn into a university, and supported his brother, Emperor Joseph II, in his ecclesiastical reforms (see *EMS, CONGRESS OF*). His successor, Anthony Victor, archduke of Austria, was the last elector, as in 1803 the dominions of the archbishop were secularized, and divided among other princes. The electorate of Cologne at that time had about 2645 English sq. miles and 230,000 inhabitants. But the diocese of Cologne was much more extensive than the electorate. Even the city of Cologne, being a free city of the empire, was subject only to the spiritual, not to the temporal rule of the archbishops who resided at Bonn. At the time of the Reformation the diocese had about 800 parishes, divided into 22 deaneries; in the 18th century the number of parishes was about 1800 (a map of the diocese is given in *Spruner's Histor. Atlas*, No. 11). After the reorganization of Germany by the Vienna Congress, Cologne, now belonging to Prussia, was reconstituted an archbishopric by a bull of July 16, 1821, with the suffragan bishoprics of Treves, Munster, and Paderborn. The diocese of Cologne had, in 1867, 44 deaneries, about 600 parishes, and a population of about 1,000,000. The first archbishop, Ferdinand Joseph, count Spiegel (1824-1835), was a man of moderate principles, and a patron of the Hermsians (q. v.). His successor, Clement Augustus Droste von Vischering (1835-1845), had a violent controversy with the Prussian government on the subject of marriages between Protestants and Roman Catholics, was arrested in 1837, and set free in 1840 only on condition that he resigned the administration of the diocese into the hands of a coadjutor. Joannes von Geissel, who succeeded him in 1845, was created a cardinal in 1850, and died in 1864. He was succeeded by Paul Melchers, who was the incumbent in 1867. See *GERMANY* and *PRUSSIA*.

Of the councils of Cologne, besides those already mentioned, the most important were, (1) in 1280, called by the Archbishop Sifridus (Sifroi), in which eighteen canons of discipline were drawn up; (2) in 1536, by Herman, on discipline, the duties of bishops, offices of the Church, etc.; (3) in 1549, by Adolphus, where several statutes were made for the reformation of the Church. The restoration of learning was recommended as one of the means of accomplishing this end.—*Wetzer u. Welte, Kirchen-Lex.* ii, 673; *Rettberg, Kirchen-Gesch. Deutschlands* (Gött. 1846); *Friedrich, Kirchen-Gesch. Deutschlands* (Bamberg, 1867); *Binterim & Mooren, Die alte und neue Erzdiöc. Köln* (4 vols. Mayence, 1828); *Mering u. Reischert, Die Bischöfe u. Erzbisch. von Köln* (Cologne, 1843); *Ersch u. Gruber*, s. v. (vol. xviii, 175 sq.; here a complete list of the bishops and archbishops of Cologne is given); *Landon, Manual of Councils*, s. v.; *Smith, Tables of Ch. History*.

Colombia, United States of, a republic in South America (until 1861 called New Granada). The country was discovered in 1498 by Christopher Colum-

bus. In 1782 the viceroyalty of New Granada was established of what are now the United States of Colombia and Ecuador. In 1810 New Granada separated herself from the Spanish monarchy, and maintained a constant war until 1824, when the Spanish army was conquered by the Colombian. New Granada formed with Venezuela (since 1817) and with Ecuador (since 1821) the republic of Colombia. But Venezuela separated herself in Nov. 1829, and Ecuador in May, 1830, and the central part constituted itself as the republic of New Granada on Nov. 21, 1831. Several times some of the states forming the republic declared themselves independent: thus the state of Panama was independent from 1863 to 1866. Since then the united republic has been constituted of the nine states of Antioquia, Bolivar, Boyacá, Cauca, Cundinamarca, Magdalena, Panama, Santander, Tolima, together, according to the last official census, with a population of 2,794,473 inhabitants. The population is rapidly increasing; in 1810, when the revolution commenced, there were 800,000 inhabitants; in 1826, 1,300,000; in 1835, 1,685,038; in 1843, 1,932,279. According to a decree of 1851, slavery ceased on January 1, 1852. The whole native population belongs to the Roman Catholic Church, whose ministers receive a salary from the state. The hierarchy consists of one archbishop at (Santa Fé de) Bogota, and seven bishops at Antioquia, Cartagena, Santa Martha, New Pampelona, Panama, Pasto (established in 1859), and Popayan. Church affairs have for many years been the subject of violent controversies between the Liberal party, who are in favor of absolute freedom of worship, of separating the state from the Church, of expelling the Jesuits, and similar measures, and the Conservative party, to whom belong all the fanatical partisans of the Church of Rome. Generally the government has been in the hands of the Liberal party, which several times has made attempts to enforce a full separation of the Church from Rome. Protestant foreigners received the right of public worship in 1822, and later the same right was given to the natives. In all the large towns the government enforces the legal toleration of all religions, but in the country the ignorance and fanaticism of the populace make it often difficult to obtain the full benefit of the law. In 1856 the Old School Presbyterian Church of the United States occupied Bogota as a missionary station, and in 1866 a second missionary was sent to the same place. A boys' school was opened January 1, 1867. The American Bible Society, in 1866, opened a depository at Bogota. At the English services the average attendance on the Sabbath, during the year 1866, was over thirty; but worship was still held in private houses, no suitable hall or edifice having yet been obtained by the missionaries. A large number of foreign Protestants, chiefly from the United States and England, have settled at Panama and Aspinwall (Colon), and they have a church and school, but hardly any progress has been made toward establishing a native Spanish congregation.—See the *Annual Reports of the Board of Foreign Missions of the Presbyterian Church*; *New American Cyclopaedia* and *Lippincott's Gazetteer*, s. v. New Granada; *Herzog, Real-Encyclop.* ii, 792.

Colonna (De Columna), the name of an ancient princely family in Italy, which was famous for many centuries, and especially during the Middle Ages, for the number of cardinals and bishops which it gave to the Roman Church, and for the prominent influence which it exercised upon the election of the popes and the government of the papal states. In the quarrels between the popes and the emperors, the *Colonnas* mostly sided with the emperors. Boniface VIII became so incensed at the hostile attitude of the family, that the descendants of the princes John III and Otto XVII were declared by him to be "irregular" until the fourth generation. According to some ecclesi-

ical writers, Pope Alexander III (according to others Gregory IX) declared all the members of the family, for all time to come, incapable of holding any ecclesiastical office. The authenticity of this decree is doubtful; if it was ever issued, it soon fell into disuse, for there is no other family which counts so large a number of cardinals among its members as the Colonnas. Only one of the family ascended the papal chair under the name of Martin V (q. v.); in general, public opinion in Rome was so much opposed to the election of a Colonna as pope, that there was a proverb: *Nec frater, nec Gallus, nec Columna erunt papa* (Neither a brother [of the deceased pope], nor a Frenchman, nor a Colonna, must be elected pope). A great many of the cardinals of this family were known for their fighting propensities; and as late as 1527 the Cardinal Pompey Colonna expelled Pope Clement VII from Rome, who on that account deposed him from his ecclesiastical dignity, and pronounced the ban against him. He was, however, restored to all his dignities in 1529. But very few of the Colonnas published any theological writings; one of these few was

Colonna, GIOVANNI, born at the beginning of the 13th century. He entered the Dominican order; was in 1296 provincial of his order in Tuscany; became in 1295 archbishop of Messina, and in 1292 archbishop of Nicosia, in Cyprus. The latter see he resigned in 1268, on account of political disturbances in Cyprus. He died between 1280 and 1290. He wrote *Liber de viris illustribus ekleisicis et Christianis* (published in 1720, with notes by B. Zoanelli). A number of other works (as *Mare historicarum, Epistolæ ad diversos, De gloria Paradisi*, etc.) have never been printed. See Wetzer u. Welte, *Kirchen-Lex.* ii, 679 sq.

Colony (κολώνια, for the Lat. *colonia*), a distinction applied to the city of Philippi, in Macedonia (Acts xvi, 12). After the battle of Actium, Augustus assigned to his veterans those parts of Italy which had espoused the cause of Antony, and transported many of the expelled inhabitants to Macedonia, by which means the towns of Philippi, Dyrrachium, etc., acquired the right of Roman colonies (Dio Cass. p. 455). Accordingly, we find Philippi described as a "colonia" both in inscriptions and upon the coins of Augustus (Orelli, *Inscr.* 612, 8658, 8746, 4064; Rasche, vol. viii, pt. ii, p. 1120). See PHILIPPI. Such towns possessed the *jus coloniarium* (Plin. *Nat. Hist.* v, 1), i. e. so-called *jus italicum* (*Digest. Leg.* viii, 8), consisting, if complete, in a free municipal constitution, such as was customary in Italy, in exemption from personal and land taxes, and in the commerce of the soil, or the right of selling the land. Originally and properly a colony was a body of Roman citizens sent out as volunteers (Livy, x, 21) to possess a commonwealth, with the approbation of their own state (Servius, ad *Æneid.* i, 12). The old Roman colonies were thus in the nature of garrisons planted in conquered towns, having a portion of the conquered territory (usually a third part) assigned to them, while the native inhabitants retained the rest, and lived together with the new settlers (Dionys. *Ant. Rom.* ii, 53). Such colonists, of course, remained Roman citizens in the fullest sense. The original natives, however, and their descendants, did not become Roman citizens by having a colony planted among them, unless it was conferred, either at the time or subsequently, by a special act of the Roman people, senate, or emperor. Their exact relation in this respect it is somewhat difficult to determine in the absence of such a specific act, as the *jus italicum*, readily and often conferred upon provincial cities, and which now would be more likely to obtain than colonial ones, conferred only the above rights upon the community, without making the individual inhabitants Roman citizens in full. (See Smith's *Dict. of Class. Antig.* s. v. Colonia.) See CITIZENSHIP.

In one passage of the Apocrypha (Wisd. xii, 7) the

term "colony" stands for *ἀνοικία*, a *settlement*, referring to Palestine as the seat of the chosen people of God.

Color. Names of colors expressly mentioned as such in the Old Test. are: (a.) לבן, *laban'*, white; צהוב, *tsach, bright*; חֲרוֹץ, *chivvar'*, pale; שָׁרֵב, *seyb, gray*; צהוב, *tsachor', cream-colored*; (b.) צהוב, *tsachob', yellow*; ירוק, *yarak', green*; (c.) אדום, *adom', red*; שָׂרוֹק, *sarok', fox-colored*; תּוֹלַת־שָׁנִי, *tolat-shani', crimson*; שָׁשׂוּר, *shasher', ochre-red*; (d.) אֲרָגָמֹן, *argamon', purple*; תֵּבֶת־לֶחֶם, *tebet-lehem, violet*; (e.) שָׁחֹר', *shachor', black*; חֲמוּם, *chum, brown*; (f.) נָקִד, *nakod', speckled*; תֵּלֵן, *talu', spotted*; בָּרָד, *barod', pie-bald*; עֵקֵד, *akod', striped*. In the N. T. the colors mentioned are: λευκός, *white*; μέλας, *black*; πυρρόος, *red*; χλωρός, *green*; πορφύρα, *porphureos, purple*; κόκκινος, *scarlet*. The following statements are chiefly from Smith and Kitto, s. v.

The terms relative to color, occurring in the Bible, may be arranged in two classes, the first including those applied to the description of natural objects, the second those artificial mixtures which were employed in dyeing or painting. In an advanced state of art, such a distinction can hardly be said to exist; all the hues of nature have been successfully imitated by the artist; but among the Jews, who fell even below their contemporaries in the cultivation of the fine arts, and to whom painting was unknown until a late period, the knowledge of artificial colors was very restricted. Dyeing was the object to which the colors known to them were applied: so exclusively, indeed, were the ideas of the Jews limited to this application of color, that the name of the dye was transferred without any addition to the material to which it was applied. The Jews were not, however, by any means insensible to the influence of color: they attached definite ideas to the various tints, according to the use made of them in robes and vestments; and the subject exercises an important influence on the interpretation of certain portions of Scripture. See DYE.

I. The natural colors noticed in the Bible are white, black, red, yellow, and green. It will be observed that only three of the prismatic colors are represented in this list; blue, indigo, violet, and orange are omitted. Of the three, yellow is very seldom noticed; it was apparently regarded as a shade of green, for the same term *greenish* (רֵחָקֵק) is applied to gold (Psa. lxxviii, 18), and to the leprous spot (Lev. xiii, 49), and very probably the golden (צָהוּב) or yellow hue of the leprous hair (Lev. xiii, 30-32) differed little from the greenish spot on the garments (Lev. xiii, 49). Green is frequently noticed, but an examination of the passages in which it occurs will show that the reference is seldom to color. The Hebrew terms are *raaman'* (רָעָמָן) and *yarak'* (יָרוֹק): the first of these applies to what is vigorous and flourishing; hence it is metaphorically employed as an image of prosperity (Job xv, 82; Psa. xxxvii, 35; lii, 8; xcii, 14; Jer. xi, 16; xvii, 8; Dan. iv, 4; Hos. xiv, 8); it is invariably employed wherever the expression "green tree" is used in connection with idolatrous sacrifices, as though with the view of conveying the idea of the *outspreading* branches, which served as a canopy to the worshippers (Deut. xii, 2; 2 Kings xvi, 4); elsewhere it is used of that which is fresh, as oil (Psa. xcii, 10), and newly-plucked boughs (Cant. i, 16). The other term, *yarak'*, has the radical signification of *putting forth leaves, sprouting* (Gesenius, *Theas. Heb.* p. 682): it is used indiscriminately for all productions of the earth fit for food (Gen. i, 30; ix, 8; Exod. x, 15; Num. xxii, 4; Isa. xv, 6; comp. *χλωρός*, Rev. viii, 7; ix, 4), and again for all kinds of garden herbs (Deut. xi, 10; 1 Kings xxi, 2; 2 Kings xix, 26; Prov. xv, 17; Isa. xxxvii, 27; con-

trast the restricted application of our *greens*); when applied to grass, it means specifically the *young, fresh grass* (שֶׁבֶט, *de'shè*, Psa. xxxvii, 2) which springs up in the desert (Job xxxix, 8). Elsewhere it describes the sickly yellowish hue of mildewed corn (Deut. xxviii, 22; 1 Kings viii, 37; 2 Chron. vi, 28; Amos iv, 9; Hag. ii, 17); and, lastly, it is used for the entire absence of color produced by fear (Jer. xxx, 6; comp. *χλωρός*, Hom. *Il.* x, 876); hence *χλωρός* (Rev. vi, 8) describes the ghastly, livid hue of death. In other passages "green" is erroneously used in the A. V. for *white* (Gen. xxx, 37; Esth. i, 6), *young* (Lev. ii, 14; xxiii, 14), *moist* (Judg. xvi, 7, 8), *sappy* (Job viii, 16), and *unripe* (Cant. ii, 13). Thus it may be said that *green* is never used in the Bible to convey the impression of proper color. See GREEN.

The only fundamental color of which the Hebrews appear to have had a clear conception was *red*; and even this is not very often noticed. They had, therefore, no scientific knowledge of colors, and we cannot but think that the attempt to explain such passages as Rev. iv, 8, by the rules of philosophical truth must fail (see Hengstenberg, *Comm.* in loc.). Instead of assuming that the emerald represents *green*, the jasper *yellow*, and the sardine *red*, the idea intended to be conveyed by these images may be simply that of *pure, brilliant, transparent* light. The emerald, for instance, was chiefly prized by the ancients for its *glittering, scintillating* qualities (*αίγλημος*, Orpheus, *De lap.* p. 608), whence, perhaps, it derived its name (*σμάραγδος*, from *μαρμαίρειν*). The jasper is characterized by John himself (Rev. xxi, 11) as being crystal-clear (*κρυσταλλίζου*), and not as having a certain hue. The sardine may be compared with the amber of Ezek. i, 4, 27, or the burnished brass of Dan. x, 6, or, again, the fine brass, "as if burning in a furnace," of Rev. i, 16, each conveying the impression of the color of fire in a state of pure incandescence. Similarly the beryl, or, rather, the *chrysolite* (the Hebrew *tarshish*) may be selected by Daniel (x, 6) on account of its transparency. An exception may be made, perhaps, in regard to the sapphire, in as far as its hue answers to the deep blue of the firmament (Exod. xxiv, 10; compare Ezek. i, 26; x, 1), but even in this case the pellucidity (*קִרְבָּבִי*, *ibnah'*, omitted in A. V., Exod. xxiv, 10) or polish of the stone (comp. Lam. iv, 7) forms an important, if not the main, element in the comparison. The highest development of color in the mind of the Hebrew evidently was *light*, and hence the predominance given to *white* as its representative (comp. the connection between *λευκός* and *lux*). This feeling appears both in the more numerous allusions to it than to any other color—in the variety of terms by which they discriminated the shades from a *pale, dull* tint (*קִהְקִה*, *kehek'*, *blackish*, Lev. xiii, 21 sq.) up to the most brilliant splendor (*קִרְבָּבִי*, *so'har*, Ezek. viii, 2; Dan. xii, 8)—and in the comparisons by which they sought to heighten their ideas of it, an instance of which occurs in the three accounts of the Transfiguration, where the countenance and robes are described as like "the sun" and "the light" (Matt. xvii, 2), "shining, exceeding white as snow" (Mark ix, 3), "glistening" (Luke ix, 29). Snow is used eleven times in a similar way, the sun five times, wood four times, milk once. In some instances the point of the comparison is not so obvious, e. g. in Job xxxviii, 14, "they stand as a garment" in reference to the *white* color of the Hebrew dress, and in Psa. lxxviii, 13, where the glancing hues of the dove's plumage suggested an image of the brilliant effect of the *white* holiday costume. Next to *white, black*, or rather *dark*, holds the most prominent place, not only as its opposite, but also as representing the complexion of the Orientals. There were various shades of it, including the *brown* of the Nile water (whence its name —)the *reddish* tint of early dawn, to which the

complexion of the bride is likened (Cant. vi, 10), as well as the *livid* hue produced by a flight of locusts (Joel ii, 2)—and the darkness of blackness itself (Lam. iv, 8). As before, we have various heightening images, such as the tents of Kedar, a flock of goats, the raven (Cant. i, 6; iv, 1; v, 11), and sackcloth (Rev. vi, 12). *Red* was also a color of which the Hebrews had a vivid conception; this may be attributed partly to the prevalence of that color in the outward aspect of the countries and peoples with which they were familiar, as attested by the name Edom, and by the words *adamah* (earth) and *adam* (man), so termed either as being formed out of the red earth, or as being red in comparison with the fair color of the Assyrians and the black of the *Æthiopiæ*. Red was regarded as an element of personal beauty: comp. 1 Sam. xvi, 12; Cant. ii, 1, where the lily is the *red* one for which Sria was famed (Plin. xxi, 11); Cant. iv, 8; vi, 7, where the complexion is compared to the red fruit of the pomegranate; and Lam. iv, 7, where the hue of the skin is redder than coral (A. V. "rubies") contrasting with the white of the *garments* before noticed. The three colors, white, black, and red, were sometimes intermixed in animals, and gave rise to the terms *קִרְבָּבִי*, *tsahor'*, *dappled* (A. V. "white"), probably white and red (Judg. v, 10); *קִרְבָּבִי*, *akod'*, *ringstreaked*, either with white bands on the legs, or white-footed; *קִרְבָּבִי*, *sabod'*, *speckled*, and *קִרְבָּבִי*, *tala'*, *spotted*, white and black; and lastly *קִרְבָּבִי*, *barod'*, *piebald* (A. V. "grizzled"), the spots being larger than in the two former (Gen. xxx, 32, 35; xxxi, 10); the latter term is used of a horse (Zech. vi, 8, 6) with a symbolical meaning; Hengstenberg (*Christol.* in loc.) considers the color itself to be unmeaning, and that the prophet has added the term strong (A. V. "bay") by way of explanation; Hitzig (*Comm.* in loc.) explains it, in a peculiar manner, of the complexion of the Egyptians. It remains for us now to notice the various terms applied to these three colors. (See each of the above words in its place.)

1. WHITE. The most common term is *קִרְבָּבִי*, *lahal'*, which is applied to such objects as milk (Gen. xiii, 12), manna (Exod. xvi, 31), snow (Isa. i, 18), bones (Zech. i, 8), raiment (Eccl. i, 8); and a cognate word expresses the color of the moon (Isa. xxiv, 23). *קִרְבָּבִי*, *tsach*, *dazzling* white, is applied to the complexion (Cant. v, 10); *קִרְבָּבִי*, *chivvar'*, a term of a later age, to snow (Dan. vii, 9 only), and to the paleness of shame (Isa. xxxix, 22, *קִרְבָּבִי*); *קִרְבָּבִי*, *shib*, to the hair alone. Another class of terms arises from the textures of a naturally white color, as *קִרְבָּבִי*, *sheek*, and *קִרְבָּבִי*, *bats*. These words appear to have been originally of foreign origin, but were connected by the Hebrews with roots in their own language descriptive of a white color (Gesenius, *Thesaur.* p. 190, 1884). The terms were without doubt primarily applied to the material; but the idea of color is also prominent, particularly in the description of the curtains of the tabernacle (Exod. xxvi, 1), and the priests' vestments (Exod. xxviii, 6). *Sheek* is also applied to white marble (Esth. i, 6; Cant. v, 15); and a cognate word, *קִרְבָּבִי*, *shoahan'*, to the lily (Cant. ii, 16). In addition to these we meet with *קִרְבָּבִי*, *klar* (*βύσσος*, Esth. i, 6; viii, 15), and *קִרְבָּבִי*, *karpa'* (*καρπασός*; A. V. "green," Esth. i, 6), also descriptive of white textures.

White was symbolical of innocence; hence the raiment of angels (Mark xvi, 5; John xx, 12), and of glorified saints (Rev. xix, 8, 14), is so described. It was also symbolical of joy (Eccl. ix, 8); and, lastly, of victory (Zech. vi, 8; Rev. vi, 2). In the Revelations (vi, 2) the term *λευκός* is applied exclusively to what belongs to Jesus Christ (Wordsworth's *Apoc.* p. 105). See WHITE.

2. BLACK. The shades of this color are expressed in the terms שָׁחֹרֶת, *shachor'*, applied to the hair (Lev. xiii, 31; Cant. v, 11); the complexion (Cant. i, v), particularly when affected with disease (Job xxx, 30); horses (Zech. vi, 2, 6): שָׂרָף, *sharaf*, lit. scorched (פָּחוּל, *phaul*), A. V. "brown," Gen. xxx, 32), applied to sheep; the word expresses the color produced by influence of the sun's rays: קָדָר, *kadar*, lit. to be dirty, applied to a complexion blackened by sorrow or disease (Job xxx, 30); mourner's robes (Jer. viii, 21; xiv, 2; Mal. iii, 14; Zech. vi, 2, 6; see Plutarch, *Pericel*, 88; Mishna, *Middoth*, v, 3; comp. *vestes fusca*, Apulei, *Metam.* ii, p. 40, Bip.; see generally Götzse, *De vestium nigrar. usu*, Helmst. 1726); a clouded sky (1 Kings xviii, 45); night (Mic. iii, 6; Jer. iv, 28; Joel ii, 10; iii, 15); a turbid brook (whence possibly ΚΕΔΡΟΝ), particularly when rendered so by melted snow (Job vi, 16). Black, as being the opposite to white, is symbolical of evil (Zech. vi, 2, 6; Rev. vi, 5). See BLACK.

3. RED. אָדָם, *adam*, is applied to blood (2 Kings iii, 22); a garment sprinkled with blood (Isa. lxiii, 2); a heifer (Num. xix, 2); pottage made of lentiles (Gen. xxv, 30); a horse (Zech. i, 8; vi, 2); wine (Prov. xxiii, 31); the complexion (Gen. xxv, 25; Cant. v, 10; Lam. iv, 7). אָדָמָדָם, *adamdam*, is a slight degree of red, reddish, and is applied to a leprous spot (Lev. xiii, 19; xiv, 37). שָׂרָף, *sharaf*, lit. *fox-colored*, bay, is applied to a horse (A. V. "speckled;" Zech. i, 8), and to a species of vine bearing a purple grape (Isa. v, 2; xvi, 8); the translation "bay" in Zech. vi, 8, A. V. is incorrect. The corresponding term in Greek is πυρόεις, lit. red as fire. This color was symbolical of bloodshed (Zech. vi, 2; Rev. vi, 4; xii, 3). See RED.

II. Artificial Colors.—The art of extracting dyes, and of applying them to various textures, appears to have been known at a very early period. We read of scarlet thread at the time of Zarah's birth (Gen. xxxviii, 28); of blue and purple at the time of the Exodus (Exod. xxvi, 1). There is, however, no evidence to show that the Jews themselves were at that period acquainted with the art; the profession of the dyer is not noticed in the Bible, though it is referred to in the Talmud. They were probably indebted both to the Egyptians and the Phœnicians; to the latter for the dyes, and to the former for the mode of applying them. The purple dyes which they chiefly used were extracted by the Phœnicians (Ezek. xxvii, 16; Plin. ix, 60), and in certain districts of Asia Minor (Hom. *Il.* iv, 141), especially Thyatira (Acts xvi, 14). It does not appear that those particular colors were used in Egypt, the Egyptian colors being produced from various metallic and earthy substances (Wilkinson, *Anc. Egypt.* iii, 301). On the other hand, there was a remarkable similarity in the mode of dyeing in Egypt and Palestine, inasmuch as the color was applied to the raw material previous to the processes of spinning and weaving (Exod. xxxv, 25; xxxix, 8; Wilkinson, iii, 125). The dyes consisted of purples, light and dark (the latter being the "blue" of the A. V.), and crimson (A. V. "scarlet"); vermilion was introduced at a late period.

1. PURPLE (אַרְגָּמָן, *argaman*; Chaldaic form, אַרְגָּמָן, *argemana*; Dan. v, 7, 16; πορφυρα; *purpura*). This color was obtained from the secretion of a species of shell-fish (Plin. ix, 60), the *Murex trunculus* of Linnaeus, which was found in various parts of the Mediterranean Sea (hence called πορφυρα θαλασσία, 1 Macc. iv, 28), particularly on the coasts of Phœnicia (Strab. xvi, 757), Africa (Strab. xvii, 835), Laconia (Hor. *Od.* ii, 18, 7), and Asia Minor. See ELISHAH. The derivation of the Hebrew name is uncertain; it has been connected with the Sanscrit *rāgamāna*, "tinged with red;" and again with *arghamāna*, "costly" (Hitzi; *Comment. in Dan.* v, 7). Gesenius, however

(*Theaur.* p. 1268), considers it highly improbable that a color so peculiar to the shores of the Mediterranean should be described by a word of any other than Shemitic origin, and connects it with the root רָגַם, *ragam*, to heap up or overlay with color. The coloring matter was contained in a small vessel in the throat of the fish; and as the quantity amounted to only a single drop in each animal, the value of the dye was proportionately high; sometimes, however, the whole fish was crushed (Plin. ix, 60). It is difficult to state with precision the tint described under the Hebrew name. The Greek equivalent was, we know, applied with great latitude, not only to all colors extracted from the shell-fish, but even to other brilliant colors; thus, the purple upper garment (ἡλιον πορφυροῦν) of John xix, 2—the crimson cloak (χλαμύς κοκκίνη) of Matt. xxvii, 28 (comp. Plin. ix, 62). The same may be said of the Latin *purpureus*. The Hebrew term seems to be applied in a similarly broad sense in Cant. vii, 5, where it either = black (comp. v, 11), or, still better, *shining* with oil. Generally speaking, however, the tint must be considered as having been defined by the distinction between the purple proper and the other purple dye (A. V. "blue"), which was produced from another species of shell-fish. The latter was undoubtedly a dark violet tint, while the former had a light reddish tinge. Robes of a purple color were worn by kings (Judg. viii, 26), and by the highest officers, civil and religious; thus Mordecai (Esth. viii, 15), Daniel (A. V. "scarlet;" Dan. v, 7, 16, 29), and Andronicus, the deputy of Antiochus (2 Macc. iv, 38), were invested with purple in token of the offices they held (comp. Xenoph. *Anab.* i, 5, 8); so also Jonathan, as high-priest (1 Macc. x, 20, 64; xi, 58). They were also worn by the wealthy and luxurious (Jer. x, 9; Ezek. xxvii, 7; Luke xvi, 19; Rev. xvii, 4; xviii, 16). A similar value was attached to purple robes both by the Greeks (Hom. *Od.* xix, 225; Herod. ix, 22; Strab. xiv, 648) and by the Romans (Virg. *Georg.* ii, 495; Hor. *Ep.* 12, 21; Suet. *Cæs.* 48; *Nero*, 82). Of the use of this and the other dyes in the textures of the tabernacle, we shall presently speak. See PURPLE.

2. BLUE (רֹבֶלֶת, *robel'eth*; Sept. ὑάκινθος, *hyakinthos*; ὀλοπόρφυρος, Num. iv, 7; Vulg. *hyacinthus*, *hyacinthinus*). This dye was procured from a species of shell-fish found on the coast of Phœnicia, and called by the Hebrews *Chilon* (Targ. Pseudo-Jon. in Dent. xxxiii, 19), and by modern naturalists *Helix ianthina*. The Hebrew name is derived, according to Gesenius (*Theaur.* p. 1502), from a root signifying to *unshell*; but according to Hitzi (*Comment.* in Ezek. xxiii, 6), from כָּלַל, *kalal*, in the sense of *dulled*, *blunted*, as opposed to the brilliant hue of the proper purple. The tint is best explained by the statements of Josephus (*Ant.* iii, 7, 7) and Philo that it was emblematic of the sky, in which case it represents not the light blue of our northern climate, but the deep dark hue of the eastern sky (*Opp.* i, 586). The term adopted by the Sept. is applied by classical writers to a color approaching to black (Hom. *Od.* vi, 281; xxiii, 158; Theoc. *Id.* 10, 28); the flower, whence the name was borrowed, being, as is well known, not the modern *hyacinth*, but of a dusky red color (*ferrugineus*, Virg. *Georg.* iv, 188; *caelestis luminis hyacinthus*, Colum. ix, 4, 4). The A. V. has rightly described the tint in Esth. i, 6 (margin) as *set*; the ordinary term *blue* is incorrect; the Lutheran translation is still more incorrect in giving it *gelbe Seide* (yellow silk), and occasionally simply *Seide* (Ezek. xxiii, 6). This color was used in the same way as purple. Princes and nobles (Ezek. xxiii, 6; Ecclus. xl, 4), and the idols of Babylon (Jer. x, 9), were clothed in robes of this tint; the riband and the fringe of the Hebrew dress was ordered to be of this color (Num. xv, 88); it was used in the tapestries of the Persians (Esth. i, 6). The effect of the color is well described in Ezek. xxiii, 12, where

such robes are termed כְּבוֹשֵׁי מְבֻלָּוּ *robes of perfection*, i. e. gorgeous robes. We may remark, in conclusion, that the Sept. treats the term תַּחֲשֵׁי *tach'ash* (A. V. "badger") as indicative of color, and has translated it ὑακινθίνος, *hyacinthinus* (Exod. xxv, 5). See BLUE.

3. SCARLET (CRIMSON, Isa. i, 18; Jer. iv, 80). The terms by which this color is expressed in Hebrew vary: sometimes טָנִי, *shanis*, simply is used, as in Gen. xxxviii, 28-30; sometimes תּוֹלַאֲתֵי טָנִי, *tola'ath shanis*, as in Exod. xxv, 4; and sometimes תּוֹלַאֲתֵי צִרְמִיזִי, *tola'ath, Carmil* (A. V. "crimson;" 2 Chron. ii, 7, 14; iii, 14) was introduced at a late period, probably from Armenia, to express the same color. The first of these terms (derived from טָנִי, *shanah*, to shine) expresses the brilliancy of the color; the second, תּוֹלַאֲתֵי, *tola'ath*, the worm, or grub, whence the dye was procured, and which gave name to the color occasionally without any addition, just as *vermilion* is derived from *vermiculus*. The Sept. generally renders it κόκκινον, occasionally with the addition of such terms as κελευσμένον (Exod. xxvi, 1), or διανεμημένον (Exod. xxviii, 8); the Vulgate has it generally *coccinum*, occasionally *coccus bistinctus* (Exod. xxviii, 8), apparently following the erroneous interpretation of Aquila and Symmachus, who render it βίβαφος, *double-dyed* (Exod. xxv, 4), as though from נָפַץ, to repeat. The process of double-dyeing was, however, peculiar to the Tyrian purples (Plin. ix, 89). The dye was produced from an insect, somewhat resembling the cochineal, which is found in considerable quantities in Armenia and other Eastern countries. The Arabian name of the insect is *hermes* (whence *crimson*); the Linnæan name is *Coccus ilicis*. It frequents the boughs of a species of *Ilex*: on these it lays its eggs in groups, which become covered with a kind of down, so that they present the appearance of vegetable galls or excrescences from the tree itself, and are described as such by Pliny, xvi, 12. The dye is procured from the female grub alone, which, when alive, is about the size of a kernel of a cherry, and of a dark amaranth color, but when dead shrivels up to the size of a grain of wheat, and is covered with a bluish mould (Parrot's *Journey to Ararat*, p. 114). The general character of the color is expressed by the Hebrew term חָרִיזִי, *chamuzis* (Isa. lxiii, 1), lit. *sharp*, and hence dazzling (compare the expression χρῶμα ὄξυ), and the Greek λαμπρά (Luke. xxiii, 11), compared with ποικίλη (Matt. xxvii, 28). The tint produced was *crimson* rather than scarlet. The only natural object to which it is applied in Scripture is the lips, which are compared to a scarlet thread (Cant. iv, 3). Josephus considered it as symbolical of fire (*Ant.* iii, 7, 7; comp. Philo, i, 536). Scarlet threads were selected as distinguishing marks from their brilliancy (Gen. xxxviii, 28; Josh. ii, 18, 21), and hence the color is expressive of what is *excessive* or *glaring* (Isa. i, 18). Scarlet robes were worn by the luxurious (2 Sam. i, 24; Prov. xxxi, 21; Jer. iv, 30; Lam. iv, 5; Rev. xvii, 4; xviii, 12, 16); it was also the appropriate hue of a warrior's dress from its similarity to blood (Nah. ii, 8; comp. Isa. lx, 5), and was especially worn by officers in the Roman army (Plin. xxii, 3; Matt. xxvii, 28). See SCARLET.

The three colors above described, purple, blue, and scarlet, together with white, were employed in the textures used for the curtains of the tabernacle, and for the sacred vestments of the priests. The four were used in combination in the outer curtains, the veil, the entrance curtain (Exod. xxvi, 1, 81, 86), and the gate of the court (Exod. xxvii, 16), as also in the high-priest's ephod, girdle, and breastplate (Exod. xxviii, 5, 6, 8, 15). The first three, to the exclusion of white, were used in the pomegranates about the

hem of the high-priest's robe (Exod. xxviii, 33). The loops of the curtains (Exod. xxvi, 4), the lace of the high-priest's breastplate, the robe of the ephod, and the lace on his mitre, were exclusively of blue (Exod. xxviii, 28, 31, 37). Cloths for wrapping the sacred utensils were either blue (Num. iv, 6), scarlet (8) or purple (13). Scarlet thread was specified in connection with the rites of cleansing the leper (Lev. xiv, 4, 6, 51), and of burning the red heifer (Num. xix, 6), apparently for the purpose of binding the hyssop to the cedar wood. The hangings for the court (Exod. xxvii, 9; xxxviii, 9), the coats, mitres, bonnets, and breeches of the priests, were white (Exod. xxix, 7, 28). The application of these colors to the service of the tabernacle has led writers both in ancient and modern times to attach some symbolical meaning to them (see Philo and Josephus, *ut sup.*). The subject has been followed up with a great variety of interpretations, more or less probable (see Krause, *De colore sacro*, Vit. 1707; Creuzer, *Symbolik*, i, 125 sq.; Bahr, *Symbolik*, i, 335 sq.; Friederich, *Symbol. d. Mos. Stiftshütte*, Lpz. 1841; *Stud. u. Krit.* 1844, ii, 315 sq.). Without entering into a disquisition on these, we will remark that it is unnecessary to assume that the colors were originally selected with such a view; their beauty and costliness is a sufficient explanation of the selection. See CRIMSON.

4. VERMILION (רֹשֶׁתִּי, *shashar*; Sept. μίτρος; Vulg. *sinopia*). This was a pigment used in fresco-painting, either for drawing figures of idols on the walls of temples (Ezek. xxiii, 14), for coloring the idols themselves (Wisd. xiii, 14), or for decorating the walls and beams of houses (Jer. xxii, 14). The Greek term μίτρος is applied both to *minium*, red lead, and *rubrica*, red ochre; the Latin *sinopia* describes the best kind of ochre, which came from Sinope. Vermilion was a favorite color among the Assyrians (Ezek. xxiii, 14), as is still attested by the sculptures of Nimrod and Khorsabad (Layard, ii, 308). See VERMILION.

III. Hebrew Symbolical Significance of Colors.—Throughout antiquity color occupied an important place in the symbology both of sentiment and of worship. Of the analogies on which these symbolical meanings were founded, some lie on the surface, while others are more recondite. Thus *white* was everywhere the symbol of *purity* and the emblem of *innocence*; hence it was the dress of the high-priest on the day of atonement, his holy dress (Lev. xvi, 4, 32); the angels, as holy (Zech. xiv, 5; Job xv, 15), appear in white clothing (Mark xvi, 5; John xx, 12); and the bride, the Lamb's wife, was arrayed in white, which is explained as emblematical of the *δικαιώματα τῶν ἁγίων* (Rev. xix, 8). White was also the sign of *festivity* (Eccl. ix, 8; comp. the *albatus* of Horace, *Sat.* ii, 2, 6) and of *triumph* (Zech. vi, 8; Rev. vi, 2; see Wetstein *N. T.* in loc.). As the light-color (comp. Matt. xvii, 2, etc.) white was also the symbol of *glory* and *majesty* (Dan. vii, 9; comp. *Ps.* civ, 2; Ezek. ix, 3 sq.; Dan. xii, 6 sq.; Matt. xxviii, 3; John xx, 12; Acts x, 30). As the opposite of white, *black* was the emblem of *mourning*, *affliction*, *calamity* (Jer. xiv, 2; Lam. iv, 8; v, 10; comp. the *atratus* and *toga pallia* of Cicero, in *Vatin.* 18); it was also the sign of *humiliation* (Mal. iii, 14) and the omen of *evil* (Zech. vi, 2; Rev. vi, 5). Red indicated, poetically, *bloodshed* and *war* (Nah. ii, 4 [A. V. 8]; Zech. vi, 2; Rev. vi, 4). Green was the emblem of *freshness*, *vigor*, and *prosperity* (*Ps.* xli, 15; iii, 10; xxxvii, 35). Blue, or *hyacinth*, or *cerulean*, was the symbol of *revelation*; it was pre-eminently the celestial color, even among heathen nations (comp. e. g. Jer. ix, 10, of the idols of Babylon, and what Eusebius says, *Præp. Evang.* iii, 11, of the *ὀνομασθησῶς Κνήφ*, and the *Crishna* of the Hindoo mythology); and among the Hebrews it was the *Jebothic* color, the symbol of the revealed God (comp. Exod. xxiv, 10; Ezek. i, 26). Hence it was the color pre-

dominant in the Mosaic ceremonial; and it was the color prescribed for the ribbon of the fringe in the border of the garment of every Israelite, that as they looked on it they might remember all the commandments of Jehovah (Num. xv, 38, 39). With purple, as the dress of kings, were associated ideas of *royalty* and *majesty* (Judg. viii, 26; Esth. viii, 15; Cant. iii, 10; vii, 5; Dan. v, 7, 16, 29; comp. *Odys.* xix, 226, the *palium purpureum* of the Jupiter Capitolinus at Rome, the *purpurea vestis* of Phœbus [Ovid, *Metam.* ii, 1, 23], the *χλαμίδες πορφύρα* of the Dioscuri [Pausan. iv, 27], the *πορφυρογέννητος* of the Byzantines, etc.). *Crimson* and *scarlet*, from their resemblance to blood (probably), became symbolical of life; hence it was a crimson thread which Rahab was to bind on her window as a sign that she was to be saved alive when Jericho was destroyed (Josh. ii, 18; vi, 25), and it was crimson which the priest was to use as a means of restoring those who had contracted defilement by touching a dead body (Num. xix, 6-22). From its intensity and fixedness this color is also used to symbolize what is indelible or deeply engrained (Isa. i, 18). The colors chiefly used in the Mosaic ritual were white, hyacinth (blue), purple, and crimson. It is a superficial view which concludes that these were used merely from their brilliancy (Braun, *De Vest. Sa. Heb.*; Bähr, *Sym. d. Mos. Cult.*). See further below.

COLORS, CHRISTIAN SYMBOLISM OF. Colors are made use of in religious symbolism among the Jews, and in several branches of the Christian Church. Specific directions were given in the O. T. for the colors to be used in building of the tabernacle and the making of the dress for the Jewish priests. Colors are also introduced in giving moral or spiritual lessons, and in describing scenes in revelation, as in Isa. i, 18, in the description of the Transfiguration, and often in the imagery of the Apocalypse. See article above.

Very early in the history of Christianity the symbolism of colors was introduced in the ritualism and the art of the Church. In the Greek Church this symbolism has been worked out to such a degree of minuteness that little or no discrimination in the use of colors is allowed to the painter. In the Romish Church somewhat more latitude is allowed to the artist. Five colors are recognised as having a theological meaning or expression: White, Red, Green, Violet, and Black.

I. *White* is the most often referred to in the Scriptures. As the union of all the rays of light, it is the symbol of *truth* and *spotless purity*. It is applied to: (1.) *God the Father*, the source and essence of immutable truth. In Daniel (vii, 9) the Ancient of Days has garments white as snow, with his hair like pure wool. The manna in the wilderness, being white, has been considered as the emblem of the Word of God. (2.) *Christ*, at the Transfiguration, appeared in garments "white as the light" (Matt. xvii, 2; Mark ix, 8). As the Great Judge, he will be seated on a great white throne (Rev. xx, 11). In works of art, when Christ appears as the Lord of truth among the doctors of the law, he is represented in white garments. (3.) The *angels* are never represented in the Scriptures as clothed otherwise than in white—as at the sepulchre of Christ (Matt. xxviii, 3), at the Ascension (Acts i, 10). (4.) The *saints* in glory shall walk in white (Rev. iii, 4), shall be arrayed in white (iv, 4; vii, 9; xv, 6, and xix, 8, where the fine linen, clean and white, is the righteousness of the saints), and they shall receive a white stone (ii, 17). (5.) The *priests*, at the consecration of the Temple, were "arrayed in white linen" (2 Chron. v, 12). In the fourth century the priests of the Christian Church wore white garments while performing their offices. In the Romish Church white is yet retained for the alb, the cope, the amice, etc., and in the entire priestly garments on the festivals of the Nativity, Epiphany, Easter, etc. In the Church of England the white surplice of the Romish Church is

retained. It is the same as the *alb*, except that the sleeves are broad and full. (6.) The *catechumens* formerly were dressed in white for one week from their baptism, and white is yet usually the dress worn by girls in their confirmation.

II. *Red* is a symbol of fire and of glowing love. It was used in the dress of the Jewish priesthood. It is usually adopted largely in painting Christ performing his miracles or other labors of love, or as he is giving to his disciples the mission to carry into the world the fire of his word (Luke xii, 49). On the famous standard or labarum of Constantine, the monogram of Christ rested on a purple cloth. Bede says that at his time the holy sepulchre was painted white and red. Some *angels* have been painted with red wings (perhaps from the word seraph—plentitude of love). The priestly vestments in the Romish Church are red on Whitsuntide and on days of the martyrs. The Ambrosian rite prescribes red during the consecration of the host, and the Ambrosian and Lyonnese rites during the festival of the Circumcision. The red dress of the cardinals is professedly intended to keep before them constantly the love and passion of the Saviour. The pope wears red on Good Friday. The Greek priests wear red ornaments during funeral services.

The red spoken of above is always scarlet. Crimson red is appointed for certain days in certain rites of the Romish Church.

III. *Green*, from its analogy to the vegetable world, indicates life and hope, especially in the future life and in the coming of our Lord. The perpetual youth of angels is often indicated by painting them in garments of green. The saints, and especially John the Evangelist, were often represented in green by painters and sculptors (who often colored their works). The tree of life in Paradise is painted green. An old tradition has it that a twig of the tree of life was transplanted, and produced the tree from which the cross of Christ was made! John the Baptist and the Virgin Mary are often represented in mantles of green. Branches of cypress, laurel, and other evergreens are often placed in the coffins or over the graves of the dead, as emblems of the hope in a future life. The Romish Church directs the priests to wear green from the Epiphany to Sexagesima Sunday, and from the third after Easter to Advent. The Ambrosian rite orders the cloth that covers the host to be green.

IV. *Violet* is considered the color of penitence and sorrow. The Romish Church orders it to be worn during all times of penance. In painting, this color is often applied to John the Baptist, who preached repentance; to the Virgin Mary, as the mother of grief; and to the angels, who are sent to call men to repentance.

V. *Blue* is forbidden by the Romish Church, but it is sometimes used as the color peculiarly appropriate to the Virgin Mary.

VI. *Black* is the universal representative of sorrow, destruction, and death, and is considered only appropriate on mourning occasions. It was also appointed in one of the later reforms of the Benedictine order of monks as the dress of that order. The students of the universities of Oxford and Cambridge thus were given the black gown, which they wear yet. This gown was adopted by the Reformed Church of England as the dress of ministers, who were all students of the universities, and thus it passed over to the Protestant Episcopal Church of America, and, further, gave the color of clerical dress to all Protestant churches.—Kreuser, *Bilderbuch* (Paderborn, 1863); Martigny, *Dictionnaire des Antiquités Chrétiennes* (Paris, 1866); Palmer, *Antiquities of the English Ritual*; *Pariser Messbuch* (1766); Jamieson, *Sacred and Legendary Art*, i, 85 sq.

Colos'sæ (Κολοσσαί, Col. i, 2; but the preponderance of MS. authority is in favor of Κολασσαί, Co-

Colossæ, a form used by the Byzantine writers, and which perhaps represents the provincial mode of pronouncing the name. On coins and inscriptions [see Eckhel, *Doct. Num.* I, iii, 147], and in classical writers [see Valcken. *ad Herod.* vii, 80], we find *Κολοσσαί*, a city of Phrygia Pacatiana, in the upper part of the basin of the Mæander, on one of its affluents named the Lycus. Hierapolis and Laodicea were in its immediate neighborhood (Col. ii, 1; iv, 13, 15, 16; see Rev. i, 11; iii, 14). Colossæ fell as these other two cities rose in importance. At a later date they were all overthrown by an earthquake. Herodotus (vii, 80) and Xenophon (*Anab.* i, 2, 6) speak of it as a city of considerable consequence (comp. Pliny, v, 29). Strabo (xii, 576) describes it as only a *πόλις*, not a *πόλις*; yet elsewhere (p. 578) he implies that it had some mercantile importance; and Pliny, in Paul's time, describes it (v, 41) as one of the "celeberrima oppida" of its district. Colossæ was situated close to the great road which led from Ephesus to the Euphrates. Hence our impulse would be to conclude that Paul passed this way, and founded or confirmed the Colossian Church on his third missionary journey (Acts xviii, 23; xix, 1). He might also have easily visited Colossæ during the prolonged stay at Ephesus, which immediately followed. The most competent commentators, however, agree in thinking that Col. ii, 1, proves that Paul had never been there when the epistle was written (but see the *Stud. u. Krit.* 1829, iii, 612 sq.). See PAUL. Theodoret's argument that he must have visited Colossæ on the journey just referred to, because he is said to have gone through the whole region of Phrygia, may be proved fallacious from geographical considerations; Colossæ, though ethnologically in Phrygia (Herod. l. c.; Xen. l. c.), was at this period politically in the province of Asia (see Rev. i. c.). That the apostle hoped to visit the place on being delivered from his Roman imprisonment is clear from Philemon 22 (compare Phil. ii, 24). Philemon and his slave Onesimus were dwellers in Colossæ. So also were Archippus and Epaphras. From Col. i, 7; iv, 12, it has been naturally concluded that the latter Christian was the founder of the Colossian Church (see Alford's *Prolegomena to Gr. Test.* iii, 35). See EPAPHRAS. The worship of angels mentioned by the apostle (Col. ii, 18) curiously reappears in Christian times in connection with one of the topographical features of the place. A church in honor of the archangel Michael was erected at the entrance of a chasm in consequence of a legend connected with an inundation (Hartley's *Researches in Greece*, p. 52); and there is good reason for identifying this chasm with one which is mentioned by Herodotus. This kind of superstition is mentioned by Theodoret as subsisting in his time; also by the Byzantine writer Nicetas Choniates, who was a native of this place, and who says that Colossæ and Chonæ were the same (*Chron.* p. 115). The probability is that under the later emperors, Colossæ, being in a ruinous state, made way for a more modern town, *Chonæ* (*Xūva*, so Theophylact. *ad Col.* ii, 1), situated near it. The neighborhood (visited by Pococke) was explored by Mr. Arundel (*Seven Churches*, p. 158; *Asia Minor*, ii, 160); but Mr. Hamilton was the first to determine the actual site of the ancient city, which appears to be at some little distance from the modern village of Chonæ (*Researches in Asia Minor*, i, 508). The huge range of Mount Cadmus rises immediately behind the village, close to which there is in the mountain an immense perpendicular chasm, affording an outlet for a wide mountain torrent. The ruins of an old castle stand on the summit of the rock forming the left side of this chasm. There are some traces of ruins and fragments of stone in the neighborhood, but barely more than sufficient to attest the existence of an ancient site (Pococke, *East*, iii, 114; Schubert, *Reise*, i, 282; see generally Hofmann, *Introd. in lectio. ep. ad Colos.* Lips. 1749; Cellarii *Notit.* ii, 162 sq.; Mannert,

Geogr. VI, i, 127 sq.; Smith, *Dict. of Class. Geogr.* s. v.).—Smith, s. v. See COLOSSIANS (EPISTLE TO THE).

COLOSSIANS, EPISTLE TO THE, the seventh of the Pauline epistles in the New Test. (see Davidson's *Introd. to the N. T.* ii, 394 sq.). See EPISTLE.

I. *Authorship*.—That this epistle is the genuine production of the apostle Paul is proved by the most satisfactory evidence, and has never, indeed, been seriously called in question. The external testimonies (Just. M. *Trypho.* p. 811 b; Theophil. *ad Autol.* ii, p. 100, ed. Col. 1686; Irenæus, *Haer.* iii, 14, 1; Clem. Alex. *Strom.* i, p. 825; iv, p. 588, al., ed. Potter; Tertull. *de Præscr.* ch. 7; *de Resurr.* ch. 23; Origen, *contra Cel.* v, 8) are explicit, and the internal arguments, founded on the style, balance of sentences, positions of adverbs, uses of the relative pronoun, participial anacolutha, unusually strong and well defined. It is not right to suppress the fact that Mayerhoff (*Der Brief an die Kol.* Berl. 1838) and Baur (*Der Apostel Paulus*, p. 417) have deliberately rejected this epistle as claiming to be a production of the apostle Paul. The first of these critics, however, has been briefly, but, as it would seem, completely answered by Meyer (*Komment.* p. 7); and to the second, in his subjective and anti-historical attempt to make individual writings of the N. T. mere theosophistic productions of a later Gnosticism, the intelligent and critical reader will naturally yield but little credence (see Rübiger, *De Christologia Paulina*, etc. Vratil. 1862; Klöpffer, *De origine Epp. ad Ephesios et Colossenses*, Gryph. 1853). It is, indeed, remarkable that the strongly-marked peculiarity of style, the nerve and force of the arguments, and the originality that appears in every paragraph, should not have made both these writers pause in their ill-considered attack on this epistle (see Tregelles, in Horne's *Introd.* new edit. vol. iii).

II. It is less certain, however, *when* and *where* it was composed. The common opinion is that Paul wrote it at Rome during his imprisonment in that city (Acts xxviii, 16, 30). Erasmus, followed by others, supposes that Ephesus was the place at which it was composed; but this suggestion is obviously untenable from its incompatibility with the allusions contained in the epistle itself to the state of trouble and imprisonment in which the apostle was whilst composing it (i, 24; iv, 10, 18). In Germany, the opinions of theologians have been divided of late years between the common hypothesis and one proposed by Schulz in the *Theologische Studien und Kritiken* for 1829 (p. 612 sq.), viz. that this epistle, with those to the Ephesians and Philemon, was written during the apostle's (two years') imprisonment at Cæsarea previous to his being sent to Rome. This opinion has been adopted and defended by Schott, Böttger, and Wiggers, whilst it has been opposed by Neander, Steiger, Harless, Rückert, Credner, and others. In a more recent number of the same periodical, however, the whole question has been subjected to a new investigation by Dr. Wiggers, who comes to the conclusion that, of the facts above appealed to, none can be regarded as *decisive* for either hypothesis (*Stud. u. Krit.* 1841, p. 496). The above opinion that this epistle and those to the Ephesians and to Philemon were written during the apostle's imprisonment at Cæsarea (Acts xxi, 27-xxvi, 32), has been recently advocated by several writers of ability, and stated with such cogency and clearness by Meyer (*Eislat. z. Ephes.* p. 15, sq.), as to deserve some consideration. It will be found, however, to rest on ingeniously-urged plausibilities; whereas, to go no further into the present epistle, the notices of the apostle's imprisonment in chap. iv, 8, 4, 11, certainly seem historically inconsistent with the nature of the imprisonment at Cæsarea. The permission of Felix (Acts xxiv, 23) can scarcely be strained into any degree of liberty to teach or preach the Gospel, while the facts recorded of Paul's imprisonment at Rome (Acts xxviii, 23, 31)

are such as to harmonize admirably with the freedom in this respect which our present epistle represents to have been accorded both to the apostle and his companions (see chap. iv, 11, and comp. De Wette, *Einleit.* s. *Coloss.* p. 12, 13; Wieseler, *Chronol.* p. 420) (Kitto, s. v.; Smith, s. v.). Finally, the foundation for this opinion is taken away by the fact that the imprisonment of Paul at Cæsarea was not so long as commonly supposed. See PAUL. It is most likely, therefore, that it was written during Paul's first imprisonment at Rome, probably in the spring of A. D. 57, and apparently soon after the Epistle to the Ephesians, with which it contains numerous and striking coincidences. In support of this date the following facts may be adduced: Timothy was with Paul at the time (chap. i, 1; comp. Phil. ii, 19); Epaphroditus (Epaphras) had lately come from Asia Minor (i, 4, 7, 9; comp. Phil. ii, 25; iv, 18), and was now with Paul (iv, 2); Paul was in prison, and had been preaching in his confinement (iv, 3, 18; see Acts xxviii, 30, 31); various friends were at this time with him (iv, 7-14; these had therefore had time to gather about him, and it was not a season of danger); Tychicus (on his second journey) and Onesimus carried the letter (iv, 7, 8; and subscription; comp. Eph. vi, 21; Philem. 12). From this last circumstance, it would appear that the epistle could not have been written very early in his imprisonment, as the letter to Philemon (doubtless written not long after) speaks confidently of a speedy release (see Conybeare and Howson's *Life and Epistles of St. Paul*, ii, 384).

"The striking similarity between many portions of this epistle and of that to the Ephesians has given rise to much speculation, both as to the reason of this studied similarity, and as to the priority of order in respect to composition. These points cannot here be discussed at length, but must be somewhat briefly dismissed with the simple expression of an opinion that the similarity may reasonably be accounted for, (1) by the proximity in time at which the two epistles were written; (2) by the high probability that in two cities of Asia, within a moderate distance from one another, there would be many doctrinal prejudices, and many social relations, that would call forth and need precisely the same language of warning and exhortation. The priority in composition must remain a matter for a reasonable difference of opinion" (Smith). See EPHESIANS and PHILEMON (*Epistles* to).

III. *Design.*—The Epistle to the Colossians was written, apparently, in consequence of information received by Paul through Epaphras concerning the internal state of their church (i, 6-8). Whether the apostle had ever himself before this time visited Colossæ is matter of uncertainty and dispute. From chap. ii, 1, where he says, "I would that ye knew what great conflict I have for you and for them at Laodicea, and for as many as have not seen my face in the flesh," etc., it has by some been very confidently concluded that he had not. It has been urged, however, that when, in ver. 5, the apostle says, "though I am absent in the flesh, yet am I with you in the spirit," etc., his language is strongly indicative of his having formerly been amongst the Colossians, for the *ἀπείμι* is used properly only of such absence as arises from the person's *having gone away* from the place of which his absence is predicated. In support of the same view have been adduced Paul's having twice visited and gone through Phrygia (Acts xvi, 6; xviii, 23), in which Colossæ was a chief city; his familiar acquaintance with so many of the Colossian Christians, Epaphras, Archipus, Philemon (who was one of his own converts, Phil. 13, 19), and Apphia, probably the wife of Philemon; his apparent acquaintance with Onesimus, the slave of Philemon, so that he recognised him again at Rome; the cordiality of friendship and interest subsisting between the apostle and the Colossians as a body (Col. i, 24, 25; ii, 1; iv, 7, etc.); the apostle's familiar ac-

quaintance with their state and relations (i, 6; ii, 6, 7, etc.); and their knowledge of so many of his companions, and especially of Timothy, whose name the apostle associates with his own at the commencement of the epistle, a circumstance which is worthy of consideration from this, that Timothy was the companion of Paul during his first tour through Phrygia, when probably the Gospel was first preached at Colossæ. Of these considerations it must be allowed that the cumulative force is very strong in favor of the opinion that the Christians at Colossæ had been privileged to enjoy the personal ministrations of Paul. At the same time, if the Colossians and Laodiceans are not to be included among those of whom Paul says they had not seen his face, it seems unaccountable that in writing to the Colossians he should have referred to this class at all. If, moreover, he had visited the Colossians, was it not strange that he should have no deeper feeling towards them than he had for the multitudes of Christians scattered over the world whose faces he had never seen? In fine, as it is quite possible that Paul may have been twice in Phrygia without being once in Colossæ, is it not easy also to account for his interest in the church at Colossæ, his knowledge of their affairs, and his acquaintance with individuals among them, by supposing that members of that church had frequently visited him in different places, though he had never visited Colossæ? See LAODICEANS (*Epistle* to).

A great part of this epistle is directed against certain false teachers who had crept into the church at Colossæ (see Rheinwald, *De pseudo doctoribus Colossensibus*, Bonnæ, 1834). To what class these teachers belonged has not been fully determined. Heinrichs (*Nov. Test. Koptian.* VII, ii, 156) contends that they were disciples of John the Baptist. Michaelis and Storr, with more show of reason, conclude that they were Essenes. Hug (*Introd.* ii, 449) traces their system to the Magian philosophy, of which the outlines are furnished by Iamblichus. But the best opinion seems to be that of Neander (*Planting and Training*, i, 374 sq.), by whom they are represented as a party of speculatists who endeavored to combine the doctrines of Oriental theosophy and asceticism with Christianity, and promised thereby to their disciples a deeper insight into the spiritual world, and a fuller approximation to heavenly purity and intelligence than simple Christianity could yield. (See below.) Against this party the apostle argues by reminding the Colossians that in Jesus Christ, as set before them in the Gospel, they had all that they required; that he was the image of the invisible God; that he was before all things; that by him all things consist; that they were complete in him, and that he would present them to God holy, unblamable, and unreprouvable, provided they continued steadfast in the faith. He then shows that the prescriptions of a mere carnal asceticism are not worthy of being submitted to by Christians, and concludes by directing their attention to the elevated principles which should regulate the conscience and conduct of such, and the duties of social and domestic life to which these would prompt.—Kitto, s. v. (See *Jour. Soc. Lit.* vol. iii.) See PHILOSOPHY.

What these dangerous tendencies therefore were that had appeared in the doctrine and practice of the Colossian Church we discover more particularly from three specifications: 1. A pretentious philosophy, which affected an esoteric knowledge, received through tradition, and which, abandoning Christ the Head, indulged in unhallowed speculations on the number and nature of the spiritual beings with which the invisible world is peopled (Col. ii, 8, 18). 2. The observance, if not the asserted obligation (for this does not appear), of Jewish ordinances (Col. ii, 16, 20-22). 3. The practice of ascetic regulations (Col. ii, 23). A question here at once arises, Were these various errors found united in the same party or individual? At first sight they seem mutually to exclude each other. The phar-

laic Judaizers exhibited no proneness either to a speculative gnosis or to asceticism; the Gnostic ascetics, on the other hand, were usually opposed to a rigid ceremonialism. It is so improbable, however, that, in a small community like that of Colossæ, three distinct parties should have existed, that we are driven to the conclusion that the corrupt tendencies in question did really exist in combination in the same persons; and the difficulty will perhaps be alleviated if we bear in mind that in the apostolic age two classes of Judaizing teachers, equally opposed to the simplicity of the apostolic message, though in different ways, busied themselves in sowing tares among the wheat in the visible Church. The former consisted of the rigid formalists, chiefly Pharisees, who occupy so prominent a place in the history of the Acts and in several of Paul's epistles, and who contended for the continued obligation of the law of Moses upon Gentile converts; the latter were speculative adherents of the Alexandrian school, whose principle it was to subordinate the letter to the spirit, or rather to treat the former as a mere shell, which the initiated were at liberty to cast away as worthless, or intended only for the vulgar. With this false spiritualism was usually combined an element of Oriental theosophy, with its doctrine of the essential evil of matter, and the ascetic practices by which it was supposed that the soul is to be emancipated from the material thralldom under which it at present labors. To angelology, or the framing of angelic genealogies, the Jews in general of that age were notoriously addicted; in the pastoral epistles (see 1 Tim. i, 4) we again meet this idle form of speculation. That persons imbued with these various notions should, on becoming Christians, attempt an amalgamation of them with their new faith is but natural; and the ill-assorted union seems to have given birth to the Gnosticism of a subsequent age, with its monstrous tenets, the product of an unbridled imagination. Teachers then, or perhaps a single teacher (Col. ii, 16), of this cast of Judaism had effected an entrance into the Colossian Church, and seems to have there experienced a favorable reception. In a Gentile community like this, pharisaic Judaism could not so easily have gained a footing; but the mixture of mystical speculation and ascetic discipline, which distinguished the section of the Alexandrian school alluded to, was just adapted to attract the unstable, especially in Phrygia, from time immemorial the land of mystic rites, such as those connected with the worship of Cybele, and of magical superstition. From this congenial soil, in a subsequent age, Montanism sprang; and, as Neander remarks (*Apostelgeschichte*, i, 442), it is remarkable that in the 4th century the Council of Laodicea was compelled to prohibit a species of angel-worship, which appears to have maintained its ground in these regions (Can. 85). We must not, however, suppose that these tendencies had worked themselves out into a distinct system, or had brought forth the bitter practical fruits which were their natural consequence, and which, at a later period, distinguished the heresiarchs alluded to in the pastoral epistles, and the followers of Cerinthus. The corrupt teaching was as yet in its bud. The apostle therefore recommends no harsh measures, such as excommunication: he treats the case as one rather of ignorance and inexperience; as that of erring but sincere Christians, not of active opponents; and seeks by gentle persuasion to win them back to their allegiance to Christ.—Fairbairn, s. v. See Gnosticism.

IV. *Contents*.—Like the majority of Paul's epistles, that to the Colossians consists of two main divisions, one of which contains the doctrinal, the other the practical matter.

After his usual salutation (chap. i, 1-2), the apostle returns thanks to God for the faith of the Colossians, the spirit of love they had shown, and the progress which the Gospel had made among them as preached by Epaphras (i, 8-8). This leads him to pray with-

out ceasing that they may be fruitful in good works, and especially thankful to the Father, who gave them an inheritance with his saints, and translated them into the kingdom of his Son—his Son, the image of the invisible God, the first-born before every creature, the Creator of all things earthly and heavenly, the Head of the Church, He in whom all things subsist, and by whom all things have been reconciled to the eternal Father (i, 9-20). This reconciliation, the apostle reminds them, was exemplified in their own cases; they were once alienated, but now so reconciled as to be presented holy and blameless before God, if only they continued firm in the faith, and were not moved from the hope of which the Gospel was the source and origin (i, 21-24). Of this Gospel the apostle declares himself the minister; the mystery of salvation was that for which he toiled and for which he suffered (i, 24-29). Nor were his sufferings only for the Church at large, but also for them and others whom he had not personally visited, even that they might come to the full knowledge of Christ, and might not fall victims to plausible sophistries; they were to walk in Christ and to be built on him (ii, 1-7). Here the apostle brings in the particular theme of the epistle. Especially were the Colossians to be careful that no philosophy was to lead them from Him in whom dwelt all the fulness of the Godhead, who was the Head of all spiritual powers, and who had quickened them, forgiven them, and in his death had triumphed over all the hosts of darkness (ii, 8, 15). Surely with such spiritual privileges they were not to be judged in the matter of mere ceremonial observances or beguiled into creature-worship. Christ was the head of the body; if they were truly united to him, what need was there of bodily austerities? (ii, 16-23.)

In the latter half of the epistle the apostle enforces the practical duties flowing from these truths. The Colossians were, then, to mind things above—spiritual things, not carnal ordinances, for their life was hidden with Christ (iii, 1-4): they were to mortify their members and the evil principles in which they once walked; the old man was to be put off, and the new man put on, in which all are one in Christ (iii, 5-12). Furthermore, they were to give heed to special duties: they were to be forgiving and loving, as was Christ. In the consciousness of his abiding word were they to sing; in his name were they to be thankful (iii, 13-17). Wives and husbands, children and parents, were all to perform their duties; servants were to be faithful, masters to be just (iii, 18-iv, 1).

In the last chapter the apostle gives further special precepts, strikingly similar to those given to his Ephesian converts. They were to pray for the apostle, and for his success in preaching the Gospel; they were to walk circumspectly, and to be ready to give a reasonable answer to all who questioned them (iv, 2-7). Tychicus, the bearer of the letter, and Onesimus would tell them all the state of the apostle (iv, 7-9): Aristarchus and others sent them friendly greetings (iv, 10-14). With an injunction to interchange this letter with that sent to the neighboring church of Laodicea (iv, 16), a special message to Archippus (iv, 17), and an autograph salutation, this short but striking epistle comes to its close.—Smith, s. v. See EPISTLE.

V. *Commentaries*.—The following are expressly on this Epistle (including, in some instances, one or more of the other Pauline letters), the most important being designated by an asterisk (*) prefixed: Jerome, *Comment.* (in *Opp.* [*Sappoa.*] ii); Chrysostom, *Hom.* (in *Opp.* ii, 368); Zuingli, *Annotations* (in *Opp.* iv, 512); Melancthon, *Enarrationes* (Wittenb. 1559, 4to); Zanchius, *Comment.* (in *Opp.* vi); Musculus, *Commentarius* (Basil. 1565, 1578, 1595, fol.); Arctius, *Commentarius* (Morg. 1580, 8vo); Olevianus, *Nota* (Gen. 1580, 8vo); Gryneus, *Explicatio* (Basil. 1585, 8vo); Rollock, *Commentarius* (Edinb. 1600, 8vo; Genev. 1602); also Lectures (Lond. 1608, 4to); Cartwright, *Commentary* (Lond.

1612, 4to); *Byfield, *Exposition* (Lond. 1616, fol.; also 1627, 1649); Elton, *Exposition* (Lond. 1615, 4to; 1620, 1631, fol.); Quiros, *Commentarius* (in *Disput.*, Lugd. B. 1623); Crellius, *Commentarius* (in *Opp.* i, 523); Cocceius, *In Ep. ad Col.* (in *Opp.* xii, 218); Altling, *Analystis* (in *Opp.* iv); *Davenant, *Expositio* (Cantab. 1627, fol.; also 1690, 1689, fol.; Genev. 1655, 4to; in English, London, 1831, 2 vols. 8vo); Calixtus, *Expositio* (Brunsw. 1654, 4to); Daillé, *Sermons* (in French, Gen. 1662, 2d ed. 3 vols. 8vo; in English, Lond. 1672, fol.); and *Exposition* (Lond. 1841, 8vo); Fergusson, *Commentarius* (Lond. 1658, 8vo); Martin, *Analysis* (in *Opp.* iv, 889); *D'Outreain, *Sendbrief*, etc. (Amst. 1695, 4to; in German, Frankfurt, 1696, 4to); Schmid, *Commentarius* (Hamb. 1696, 4to; also 1704); Suicer, *Commentarius* (Tiguri, 1699, 4to); Stresio, *Meditationes* (Amst. 1708, 8vo); Gleich, *Predigten* (Dresden, 1717, 4to); Lutken, *Predigten* (Gardel. 1718, 1737, 4to); Hazevoet, *Verklaring* (Lugd. B. 1720, 4to); Van Til, *Commentarius* (Amst. 1726, 4to); Roell, *Exegesis* (Traj. 1731, 4to); Peirce, *Paraphrase* (London, 1733, 4to); Koning, *Openlegging* (L. B. 1739, 4to); Storr, *Interpretatio* (in his *Opusc. Acad.* ii, 120-241); Boysen, *Erklärung* (Quedlb. 1766-1781); Jones, *Version* (London, 1820, 12mo); Junker, *Commentar* (Mannheim, 1828, 8vo); Böhmer, *Auslegung* (8vo, Berl. 1829; Breslau, 1835); Flatt, *Erklär.* ed. by Kling (Tüb. 1829, 8vo); *Bähr, *Commentar* (Basel, 1833, 8vo); Watson, *Discourses* (Lond. 1834, 8vo; also 1838); Steiger, *Uebers. u. Erklär.* (Erlang. 1835, 8vo); Schleiermacher, *Predigten* (Berlin, 1835, 2 vols. 8vo); Lange, *Homilien* (Barmen, 1839); Decker, *Bearbeitung* (Hamb. 1848, 8vo); Hüther, *Commentar* (Hamb. 1841, 2 vols. 8vo); *De Wätte, *Erklärung* (Lpz. 1843, 1847, 8vo); Wilson, *Lectures* (London, 1845, 8vo; also 1846); Baumgarten-Crusius, *Commentar* (Jena, 1847, 8vo); Meyer, *Handbuch* (Gött. 1848, 8vo, pt. ix); Kähler, *Auslegung* (Eisleb. 1853, 8vo); Bisping, *Erklärung* (Münst. 1855, 8vo); *Eadie, *Commentary* (Glasg. 1856, 8vo); Dalmer, *Auslegung* (Gotha, 1858, 8vo); *Elliot, *Commentary* (London, 1858, 1861, 8vo; Andover, 1865, 8vo); Gisborne, *Exposition* (Lond. 1860, 12mo); Messmer, *Erklärung* (Brixen, 1863, 8vo); Passavant, *Auslegung* (Basel, 1865, 8vo); *Bleek, *Vorlesungen* (Berlin, 1865, 8vo). See COMMENTARY.

Colt (prop. כֹּלֵט, *o'gir*, a young ass, Judg. x, 4; xiii, 14; Job xi, 12; Zech. ix, 9; πῶλος, Matt. xxi, 2, etc.), spoken of the young of the horse, ass, or camel. See FOAL.

Colton, CALVIN, D.D., was born in Longmeadow, Mass., and graduated at Yale College in 1812. He studied divinity at Andover, and was ordained a Presbyterian clergyman in 1815, when he settled at Batavia, N. Y., where he preached until 1826, at which time he lost his voice, and thenceforth devoted his time to writing for periodicals. He travelled in Europe for several years, returning to New York in 1835, when he took orders in the Protestant Episcopal Church. After this he turned his attention to political subjects, and from 1838 to 1842 wrote many pamphlets. He held for some years before his death the chair of Political Economy in Trinity College, Hartford. Among his theological writings are *The Genius and Mission of the Protestant Episcopal Church in the United States* (12mo); *The Religious State of the Country* (12mo). He died at Savannah, March 20, 1857.

Columba was the first of the numerous Irish missionaries of the sixth and seventh centuries. He was born about A.D. 520, in Donegal, Ireland, of the royal family. His real name was Colum, but, from his dove-like appearance in childhood, it was Latinized to Columba (dove). Among his own countrymen he was called *Colum na Cille*, or *Columbkille*, Colum of the Church. His mother, Ethena, was of the royal house of Leinster. Before Columba went abroad on his mission he had travelled over Leinster, Connaught, Meath,

and other parts, preaching and calling upon all immediately to repent and believe in Christ. The Venerable Bede (*Eccl. Hist.* lib. iii) says, "Before Columba came into North Britain he founded a noble monastery in Ireland, which, in the language of the Scots [Irish], was called Dairmach, that is, the 'Field of Oaks.'" Archbishop Usher, who studied the life of this saint carefully, says "that, directly or indirectly, Columba founded nearly one hundred monasteries in Ireland." The bishop may have meant simply Christian schools; for, like his prototype St. Patrick, wherever he had built a church he founded a school. With these early Irish Christians religion and learning were twin sisters. But Columba is better known in history as "The Apostle of the Picts, or the Western Isles." Passing over on a religious visit to the Irish colony in Allyn or North Britain, the chieftains of which were his own relatives, for the first time he was brought into contact with the Picts, who were then pagans. From that moment he resolved to devote his life to their evangelization. For this purpose, about A.D. 563, Columba formed a company of twelve, and embarked for Druids' Island, situated west of Mull, in the country afterwards called Scotland. Here he founded the monastery, or, more properly, the great theological school known on the Continent during the Dark Ages as "The Western Star of literature and religion." Its government was wholly within itself, presbyterian and republican; the abbot or head invariably to be a presbyter, and to be chosen only by the inmates. Having built his huts, and left some of his men to till the ground for their support, with a few attendants he set out to preach to the Picts and the Highlanders on the north side of the Grampian Range. At first he was sternly resisted by the chieftain and his Druidic priest. At last, however, the king not only embraced Christianity, but became active in spreading it among his people. Columba and his companions afterwards set sail for the Western and Orkney Islands, and founded several churches and schools upon them. Having thus established his mission beyond the Grampian Hills, he returned to Iona and Albyn. For several years his field of labor was very large, extending from the Western Islands to the Lowland Picts, to the Irish colony in Argyleshire, to the Anglo-Saxons in Northumberland, and occasionally to Ireland. Although never episcopally ordained, he thus became the greatest missionary bishop of his day. His last visit to Ireland was one of peace, to adjust a political difference between two princes. On reaching Iona, "the isle of his heart," as he usually called it, he was very feeble. Finding that he was drawing near the close of life, he was taken to a little eminence from which he could see the holy settlement, and from which he invoked God's blessing upon it. Having returned, he began his favorite employment of transcribing the Scriptures. That night, being led to the altar, he fell on his knees and began to pray; soon, however, he was discovered leaning against the railing in a dying state. The brotherhood, now gathering around him with their lighted torches, began to weep and to crave his last blessing. Recovering for a moment, and feebly opening his eyes and smiling on all around, he attempted to raise his hand to pronounce the blessing, but it immediately fell. He then sank down in death, and breathed his last, in the 78th year of his age.

Columba was no ordinary man. In person he is said to have been very comely—beautiful even to old age. He was never idle. When not engaged in study, prayer, or missionary duty, he employed himself in transcribing the Holy Scriptures. When travelling he was always seeking for opportunities to do good. If he met a child, he gave it his blessing; if an adult, he inquired in regard to his soul. On entering a house, he invoked God's blessing upon it; and often, when reaching the threshing-floor, he would request all to stop

work till they had thanked God, the giver of bread. His early biographers say that he was a powerful preacher, speaking the Irish and Latin with equal ease, and both with great fluency. His voice was tender, tremulous, musical, and sufficiently strong to be heard at a great distance. His soul was in his preaching, and was constantly manifesting itself through his words, tones, and gestures. He was a man of great prayer; the spirit of devotion seemed to have been the atmosphere in which he lived. If he entered a boat, mounted a horse, administered medicine, or parted with a friend, in all these he acknowledged God, and asked his protection. He was not a Romanist—Romanism proper had not reached Ireland in his day. He enjoined on all his disciples to receive nothing as religious truth that was not sustained by proof drawn from the Holy Scriptures (*Prolati sacra Scripturas testimoniis*).—Adamnan, *Life of Columba*; Bede, *Ecol. Hist.* iii, 4; Moore, *Hist. of Ireland*, often; *Pict. Hist. of England*, i, 277; Montalembert, *Monks of the West*, vol. iii; Todd, *Ancient Irish Church*; Smith, *Religion of Ancient Britain*, p. 256; McLearn, *Christian Missions in the Middle Ages*, Lond. 1863; *Princeton Rev.* Jan. 1867, p. 5.

Columbanus, a missionary of the sixth century, was born in Leinster, Ireland, about A.D. 560, and descended from a noble family of that province. In early life, from talents, position, and property, the world opened to him with unusual attractions, but he decided to enter the monastery of Banchor, in Ulster, then giving instruction to about one thousand students. Having formed a company of missionaries, Columbanus set out for France, and settled at the foot of the Vosges Mountains, among the wildest, poorest, and most uncivilized of all the Franks. Here he built huts. The daily routine of the fraternity was, in their cabins, reading, praying, and transcribing the Scriptures and other books; in the field, cultivating the ground for their sustenance and to give to the poor; and when abroad, visiting the people, and inviting them to hear the Gospel. Their establishment, although generally called a monastery, was far more like one of our modern missionary stations. After a few years another was commenced at Fontaines—"The Springs"—which soon became a place of general resort, and which greatly enlarged their sphere of usefulness. In these places they continued for about twenty years, exerting the most benign influence on all the surrounding country; and through the wives and daughters of the semi-barbarous chieftains, Christianizing its political institutions. "The common people had followed these missionaries gladly; but the keen rebukes of Columbanus had long chafed the most of the ruling classes. At a royal festival a glass of wine was presented to him, which he dashed on the floor because it had 'been polluted by the touch of an adulterer'" (*Godwin's Ancient Gaul*, p. 868). At another time four illegitimate children of Theuderik, or Thierry, the king, were placed before him to receive his blessing, which he refused, and pronounced them to be the offspring of sin. Upon this the famous Brunehilda vowed his destruction. When the soldiers came to disperse his establishment, he met them with intrepidity. But the monastery was broken up. The brotherhood now rallied around him, and were willing to die with him; but he advised them to go to Germany.

Columbanus went to Italy, where new troubles awaited him. Holding with the Irish Church in regard to the Three Chapters (q. v.) and the time of keeping Easter (q. v.), he learned that the Roman Church had condemned these views under severe penalties. He found, however, a protector in Theodolinda, the pious queen of the Lombards, who agreed with him about the Three Chapters. He had everywhere avowed his principles, and even addressed a letter to pope Boniface, in which he charged him and the General Council with departing from the faith of the apostles. He remind-

ed him that in Rome and Italy there had been many disputes and dissensions, while in Ireland "there never had been a heretic or schismatic but that from the beginning they had held without wavering (*inconvulsae*), the true catholic faith." Soon afterwards he retired to Bobbio, in the Apennines, where he founded his last monastery, and died prematurely at fifty-six.

Columbanus was one of those men who cannot pass easily through this world. The subjects of his rebukes were generally shining marks—kings, queens, dukes, popes, and others in high places. By nature he was a poet; and the fragments of Irish poetry left by him are said by competent judges to have been imitated in Macpherson's *Osian*. He has been almost overlooked in English literature, while the authors of the *Literary History of France* are even extravagant in his praise. He left a treatise on Penitence, from which it is evident that communion in both kinds was allowed in the Irish Church in his day. Of the works written by Columbanus are still extant: *De octo vitiiis principalibus*, *Penitentiale*, *Instructiones de officiis Christianis*, and some letters and poems. They have been published by Fleming (Louvain, 1607), and in Gallandus, *Bibl. veterum Patr.* tom. xii. Columbanus's monastic rule has been published in Holsten-Brockie, *Codex Regul.* i, 166 sq. Biographies of Columbanus were written by his companion Jonas and by the monk Walafrid Strabo, both of which are given by Mabillon, *Acta SS. Ord. S. Ben.* i, sec. 2.—See Wetzer u. Welte, *Kirchen-Lex.* ii, 700; Herzog, *Real-Encyclop.* ii, 789; Hefele, *Gesch. der Einführ. des Christ. in Süd-deutsch.* p. 262-280; Knotenbelt, *Disp. de Columbanus* (Leyd. 1859); *Hist. Litt. de France*, iii, 279-505; Usher, vi, 281; *Lives of Illus. Men of Ireland*, i, 125 (Dublin, 1888); Moore's *History of Ireland*, p. 186 (Philadelphia); Neander, *Light in Dark Places*, p. 187.

Column (Lat. *columna*), a pillar to support a roof or other part of a building. It is more usually applied to ancient architecture, the columnus of Gothic buildings being usually termed *pillars*. Still, this distinction of terms is not universally observed. A column generally has a base, shaft, and capital. The proportions vary with the style of architecture, and the size and purpose of the building. It was frequently merely an architectural ornament, and was used in all cultivated ages. Those employed by the ancient Egyptians, Greeks, and Persians may be taken as the best and most classical examples of antiquity. See **PILLAR**.

1. Egyptian columns may be classed in eight orders, as in the accompanying wood-cut, where, being drawn to the same scale, their respective dimensions are shown. For, though columns of the same order vary very much in different buildings, an average proportion may be assigned to them, which, indeed, is all that can be done in those of Greece, though they varied less than in Egyptian architecture. In point of antiquity, the first was certainly the square pillar; then the polygonal and round fluted column of the second order; and soon afterwards the third and fourth came into use. But the fourth and fifth, though used long before, were not common till the 18th dynasty, and the fourth assumed a larger size than any other, as at Karnak and Luxor. The sixth, though mostly in Ptolemaic and Roman temples, dates at least as early as the 18th dynasty; as does the eighth, which is, in fact, the square pillar, with a figure attached, and the evident original of the Caryatide of Greece; but the seventh is limited to the age of the Ptolemies, and has an endless variety in the form and ornaments of its capital. It was, however, quite Egyptian, and in no way indebted to Greek taste for its introduction. Of the same kind were the columns described by Athenæus (v, 108), with circular capitals, set round with rose-like ornaments, or with flowers and interlaced leaves, some of which were made of the long tapering

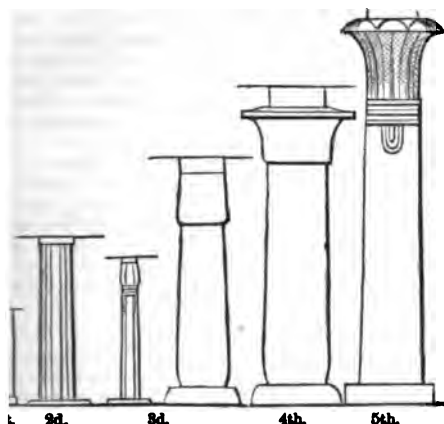

ern used in their houses, to which he also alludes. here was also a pilaster surmounted by a cow's head Wilkinson's *Anc. Egyptians*, ii, 285, 286, abridgm.).

2. Among the Greeks, also, the grandeur of the temples, which were very simple in form, was greatly owing to the beautiful combinations of columns which adorned the interior as well as the outside. These columns either surrounded the building entirely, or were arranged in porticoes on one or more of its fronts, and according to their number and distribution tem-

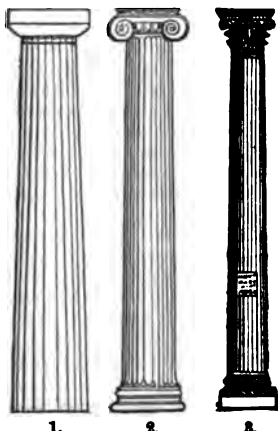

Ancient Grecian Columns. 1. Doric; 2. Ionic; 3. Corinthian.

ples have been classified both by ancient and modern writers on architecture. Columns were originally used simply to support the roof of the edifice; and, amidst all the elaborations of a later age, this object was always kept in view. Hence we find the column supporting a horizontal mass technically called the entablature. Both the column and the entablature are again divided into three distinct parts. The former consists of the base, the shaft, and the capital; the latter of the architrave, the frieze, and the cornice. The architrave is the chief beam (*επιστύλιον, epistylion*), resting on the summit of the row of columns; the frieze (*ζωφόρος, zophorus*) rises above the architrave, and is frequently adorned by figures in detail; and above the frieze projects the cornice (*κορωνίς, coronis*), forming a handsome finish (Smith's *History of Greece*, p. 144; see Müller, *Ancient Art* [Lond. 1842], § 277).

3. The Persian style of columns (see ASSYRIA; JACHIN) greatly resembled the Ionic, having a circular and ornamental base, a fluted shaft, and a capital, consisting either of two half-formed animals (the horse-head or demi-bulls were the favorites) crosswise of the architrave, or of a complex pyramidal ornament surmounted by volutes (Fergusson's *Nineveh and Persepolis*, p. 159 sq.). See ARCHITECTURE.

Comander. See KOMANDER.

Comb. See HONEY.

Combat. See SINGLE COMBAT.

Combeffis, FRANÇOIS, a learned Dominican monk, was born in November, 1605, at Marmande, in the Department of Lot-et-Garonne, in France. He was educated by the Jesuits at Bordeaux, and in 1624 entered the Dominican order. After completing his theological studies, he was appointed professor of philosophy and theology in several houses of his order (in 1640 at Paris). But soon he withdrew from his professorship in order to devote all his time to literary labors, and, in particular, to the study and publication of the ancient writers of the Church. After publishing, in 1644, the works of Amphilocheus, bishop of Iconium, of Methodius and Andreas of Crete (2 vols. fol., Greek and Latin, with notes), and in 1645 the Scholia of St. Maximus on Dionysius, he attracted great attention by the publication of the *Novum Auctarium Græco-Latinæ Bibliothecæ Patrum* (Paris, 1648), which consists of an exegetical and a historical part. The former contains homilies and sermons of St. Asterius, bishop of Amasea, of St. Proclus, of St. Anastasius of Alexandria, and of several other Church fathers and writers. The second part contains a history of the Monothelites, which was not well received in Rome, and the writings of several Greek writers, ecclesiastical and secular. In 1655 he published the *Chronography* of the Byzantine writer Theophanes, which had been begun by the Dominican monk Goar, but left unfinished at his death. In order to encourage these literary labors, the French bishops, at a meeting in Paris in 1655, assigned to Combeffis an annual salary of 500 livres, which in the next year was increased to 800, and later to 1000 livres. In 1656 he published several works of Chrysostom; in 1660 the acts of martyrs of the Greek Church (*Illustrium Christi Martyrum Lecti Triumphi*, Greek and Latin). In 1662 appeared one of his greatest works, the *Bibliotheca Patrum Concionatoria* (8 vols. Paris). Among the most important of his later works are the following: *Auctarium novissimum Bibliothecæ Græcorum Patrum* (Paris, 1672, 2 vols.), containing *Liber Flavii Josephi de imperio rationis in laudem Maccabeorum*, two books of Hippolytus, one essay of Methodius, two works against the Manicheans by Alexander of Lycopolis (formerly himself a Manichean), and by Didymus of Alexandria; some essays of the Hesychast Palamas and his opponent Manuel Kalakas, who, on account of his Romanizing tendencies, had been expelled from the Greek Church and

had entered the Dominican order; the *Ecclesiastes Graecus* (Par. 1674), containing a Latin translation of select works of Basil the Great and Basil bishop of Seleucia; and new editions of the works of Maximus Confessor (Paris, 1675, 2 vols. fol.: this work was left incomplete in consequence of the death of Combefis) and of Basil the Great. The edition of Gregory of Nazianzus, and of the works of those Byzantine writers who wrote after Theophanes, were prepared by Combefis, but not finished. The latter was published by Du Fresnoy (Paris, 1685); the former was made use of by the Maurine Louvard for his edition of Gregory. Combefis died March 23, 1679. See Wetzler u. Welte, *Kirchen-Lex.* ii, 701 sq.; Quetif and Echard, *Script. Ord. Prædic.* ii, 678 sq.

Comber, Thomas, a learned English divine, was born at Westerham, Kent, March 19, 1644. It is said that he could read Greek at ten years old. Admitted B.A. at Cambridge in 1662, he was made Prebendary of York in 1677, dean of Durham in 1691, and died in 1699. His chief works are: *Companion to the Temple* (new edit., Oxford, 1841, 7 vols. 8vo, one of the most complete works extant on the Book of Common Prayer);—*Short Discourses on the Common Prayer* (1684, 8vo);—*Roman Forgeries in the Councils of the first four Centuries* (London, 1689, 4to). His *Memoirs*, by his great grandson, T. Comber, were published in London in 1799 (8vo).—Hook, *Eccles. Biography*, iv, 156; Kippis, *Biographia Britannica*, iv, 45.

Comber, Thomas, grandson of the preceding, passed M.A. at Cambridge in 1770, and LL.D. in 1777. He died rector of Buckworth in 1778. Besides the *Life* of his grandfather, mentioned above, he wrote *The Heathen Rejection of Christianity in the first Ages considered* (Lond. 1747, 8vo);—*Examination of Middleton's Discourse against Miracles* (8vo);—*Treatise of Laws, from the Greek of Sylburgius* (1776, 8vo).

Comenius (properly *Komensky*), JOHN AMOS, was born at Comna, in Moravia, March 28, 1692. Having studied at Herborn and Heidelberg, he entered the ministry of the Bohemian Brethren's Church, and took charge (1616) of the parish of Prerau, as also of the rectorship of its theological seminary. In 1618 he removed to Fulneck, where he filled the same offices. Driven from his native country in the Bohemian anti-Reformation, he settled at Lissa, in Poland, where he superintended the high school of the Brethren. In 1632 he became one of their bishops, and, as such, prepared the way for their renewal as a church, caring in particular for the continuance of their episcopal succession. His skill as an educator, especially his new method of teaching Latin, gave him great celebrity, and he traveled through a large part of Protestant Europe to improve the methods of education, being called to England for this purpose in 1641, and to Sweden in 1642. He became closely connected with the mystic Antoinette Bourignon (q. v.), and in 1657 published *Luz in Tenebris* (4to), in which he reported the "visions" of Kottler, Poniatovia, and Drabicius. In after years, however, he regretted this connection, and acknowledged that "he had been entangled in an inextricable labyrinth." He settled finally at Amsterdam, where he died in 1631. His principal works are: *Theatrum divinum* (Prague, 1616);—*Labyrinth der Welt* (Prague, 1631; Berlin, 1787);—*Janua linguarum reæratæ* (Lissa, 1631), translated into many languages, and, among others, into Persian and Arabic, an elementary encyclopedia divided into 100 chapters and 1000 paragraphs;—*Opera didactica omnia* (Amst. 1657, fol.);—*Ratio disciplina ordinisque eccl. in Unitate Fratrum Bohemorum* (Lissa, 1632; Amsterd. 1660; Halle, 1702; in German by Köppen; in English by Seiffert, *Ch. Const. of the Boh. Brethren* (Lond. 1867).

Comer, John, one of the early Baptist ministers in America, was born in Boston, Aug. 1, 1704. He was venticed to a glover, but at seventeen, by the influ-

ence of Increase Mather, he was released by his master, and soon entered Harvard College, whence he removed, after a few years, to Yale. In 1721 he joined the Congregationalist Church at Cambridge, but in 1725 became a Baptist, connecting himself with Mr. Callender's church in Boston. In the same year he began preaching, and in 1726 he was ordained co-pastor at Newport. In 1729 a dispute about the "laying on of hands" in admitting baptized members into the Church led to his dismissal from his charge. In 1732 he became pastor at Old Rehoboth, about ten miles from Providence, where he died of consumption, May 23, 1784. He left a *Diary* in MS., which is of great interest for the early history of the Baptist Church in America.—Sprague, *Annals*, vi, 42.

Comforter. See HOLY SPIRIT.

Coming (*παρουσία*, being present) OF CHRIST, a phrase employed, (1.) literally, in reference to our Lord's first appearance in the flesh (1 John v, 20; 2 John vii), or to his future appearance at the last day to fulfil his promises to raise the dead and judge the world in righteousness (Acts i, 11; iii, 20, 21; 1 Thes. iv, 15; 2 Tim. iv, 1; Heb. ix, 28).

(2.) Metaphorically, Christ is said to come when his Gospel is introduced or preached in any place by his ministers (John xv, 22; Ephes. ii, 17); when his church or kingdom is visibly or powerfully established in the world (Matt. xvi, 28); when he bestows upon believers the influence of his spirit, and the peculiar tokens of his love (John xiv, 18, 23, 28); when he executes his judgment on wicked communities who reject or corrupt his Gospel (2 Thes. ii, 8); and when his providence calls us away from the world by death, as preparatory to the judgment of the last day (Matt. xxiv, 42). The basis of this metaphorical usage in regard to the coming of Christ is the same as in relation to the coming of God; that as he governs the world, every specific act of his providence and authority indicates his presence in a more striking manner to human conception, on the principle that no agent can act where he is not. See ESCHATOLOGY.

Commandery or Commandry, a kind of benefice belonging to a military order. There are also "commanderies" in the orders of Bernard and Anthony, and for the knights of Malta, accorded for distinguished services.—Eden, *Churchman's Dict.* a. v.

Commandment. See DECALOGUE.

COMMANDMENTS, THE FIVE, or COMMANDMENTS OF THE CHURCH, certain rules of the Roman Catholic Church which, within the last three centuries, have been considered to be as obligatory on the laity as the *commandments of the decalogue*. These five commandments are generally stated as follows: 1. To keep holy the obligatory feast-days; 2. Devoutly to hear mass on Sundays and feast-days; 3. To observe the days of fast and abstinence; 4. To confess to the priest at least once a year (at Easter) (*Conc. Lat. IV*, Can. 21); 5. To partake of the sacrament at least once a year, towards Easter. As these different rules have no common origin in the regulations of the Church, and are not even taken from the *Catechismus Romanus*, it is not to be wondered at that they have undergone several modifications. Among other variations, it has been a general practice to join the fourth and fifth commandments together, and to replace the fifth by "Not to marry at certain prohibited times." Others have made various alterations. Bellarmine includes the paying of tithes among the commandments of the Church, whilst some of the French catechisms, unable to include all the rules under the five heads, have added a sixth, yet without reaching their object. In the United States the "commandments" are enjoined in the following form:

1. The Catholic Church commands her children, on Sundays and holidays of obligation, to be present at the holy sacrifice of mass, to rest from servile works on those days, and to keep them holy.

2. She commands them to abstain from flesh on all days of fasting and abstinence, and on fast-days to eat but one meal.
3. She commands them to confess their sins to their pastor at least once a year.
4. She commands them to receive the blessed sacrament at least once a year, and that at Easter, or during the paschal time.
5. To contribute to the support of their pastor.
6. Not to marry within the fourth degree of kindred, nor privately without witnesses; nor to solemnize marriage at certain prohibited times.

We have said that these commandments are as obligatory for the Romanist layman as the *commandments of God*. The Council of Trent has dogmatically settled the point (Sess. VI, *De Justif.* Can. xx). The Protestant opposition to this great wrong was commenced by such writings as Luther's *De captivitate Babilonica* and Zwingle's *Von Erkiezen und Fryheit der Sypoen*. The Evangelical Confessions express the same opposition, as, for instance, the *Augustana*, in the articles XV, XVII, XXVI, the *Helvetica* in 23, 24, and 27, *Tetrapol.* cap. 7, 8, 9, 10. The clearly-expressed protestation contained in these passages does in no way seek to overthrow the dutiful obedience commanded towards pastors and rulers (Heb. xiii, 17), or towards decency and order (1 Cor. xiv, 40), and the power of government held by the Church in the persons of its constituted organs. All this is entirely different from the commandments established by the Romish hierarchy in opposition to the Word of God, as expressed in Col. ii, 16, 18, 20-25; Matt. xv, 17; 1 Tim. iv, 1-4; 1 Cor. viii, 8; vii, 6; iii, 21; Mark ii, 23; Gal. iv, 9-11. The old plea constantly presented by the Romish apologists, that the doctrine of the commandments of the Church has its foundation in the power of the keys and in the commandments of God himself, is of no weight.—Herzog, *Real-Encyclop.* iv, 644; Wetzer u. Welte, *Kirch.-Lex.* iv, 844.

Commendam. When a vacant living is commended in the Church of England to the charge of a clergyman until it can be supplied with a pastor, the benefice is said to be supplied *in commendam*. Anciently the administration of vacant bishoprics belonged to the nearest bishop, thence called *commendatory*. This custom was at a very early period introduced into the Church. Athanasius says of himself, according to Nicephorus, that there had been given him, *in commendam*, another church beside that of Alexandria, of which he was the stated bishop. When a priest is made bishop, his parsonage becomes vacant, but he may still hold it *in commendam*. It has been the practice sometimes in England for the crown thus to annex to a bishopric of small value either the living which had been held by the newly made bishop, and of which, in virtue of such elevation of its incumbent, the patronage became at the disposal of the crown, or some other in its stead.—Eden, *Churchman's Dict.*; Farrar, *Ecll. Dict.*; Wetzer u. Welte, *Kirch.-Lex.* ii, 706.

Commendone. GIOVANNI FRANCESCO, a cardinal and papal legate in Germany, was born at Venice March 17, 1523. After studying law, he went (1560) to Rome, where he attracted the attention of Pope Julius III, and was employed as early as 1551 for a political mission. In 1552 he went as papal envoy to the Netherlands, and from there to England, where he had an important secret interview with Mary, the daughter of Henry VIII, who, on the death of her brother Edward, was to ascend the English throne. Mary gave him an autograph letter to the pope, and promised that the Roman Catholic religion should be re-established as the state Church. Commendone, having now gained the entire confidence of the pope, was at once employed for other important missions to Portugal, Spain, and France. Paul IV made him papal secretary and bishop of Zante. Pius IV sent him to Germany to invite the Protestant princes to send delegates to the Council of Trent. He addressed the Protestant convention at Naumburg (1561), and pre-

sented the papal bull of invitation and letters to the several princes, but met with no success, the letters being returned unopened and the invitation declined. Subsequent efforts to prevail upon the elector of Brandenburg and the kings of Denmark and Sweden to send deputies to the council remained likewise without effect. More successful was a mission to Poland in 1568. Whilst staying at the Polish court he was appointed a cardinal. In 1566 and 1568 he was sent to the Emperor Maximilian, who was suspected of leaning toward Protestantism, in order to detain him from making concessions to the Protestants. Soon after he was again sent to Poland in order to secure the election of a French prince, who was known as a fanatical partisan of the Church of Rome, as king of Poland. He returned to Rome in 1573, and died in 1584. His life was written by A. Maria Gratiani, his secretary, and subsequently bishop of Amelia. See Wetzer u. Welte, *Kirch.-Lex.* i, 707 sq.; Prissac, *Die päpstlichen Legaten Commendone und Cappaccini in Berlin* (Neuss, 1846).

Commentary (*ὑπομνηματισμός*, Lat. *commentarii*, 2 Macc. ii, 18), BIBLICAL (see Carpenter's *Guide to the Study of the Bible*, pt. i, ch. iii, sec. 1-4; Davidson, in Horne's *Introd.* new ed. ii, 377-385; M. Stuart in the *Am. Bib. Repos.* iii, 180 sq.). See INTERPRETATION.

I. Definition.—By *commentary*, in its theological application, is usually meant an exhibition of the meaning which the sacred writers intended to convey; or a development of the truths which the Holy Spirit willed to communicate to men for their saving enlightenment. This is usually effected by notes more or less extended—by a series of remarks, critical, philological, grammatical, or popular, whose purport is to bring out into view the exact sentiments which the inspired authors meant to express. It is true that this can only be imperfectly done, owing to the various causes by which every language is affected; but the *substance* of revelation may be adequately embodied in a great variety of garb.

(1.) The *characteristics* of commentary are: (a.) An elucidation of the meaning belonging to the words, phrases, and idioms of the original. The signification of a term is generic or specific. A variety of significations also belongs to the same term, according to the position it occupies. Now a commentary points out the particular meaning belonging to a term in a particular place, together with the reason of its bearing such a sense. So with phrases. It should likewise explain the construction of sentences, the peculiarities of the diction employed, the difficulties belonging to certain combinations of words, and the mode in which they affect the general meaning.

(b.) Another characteristic of commentary is an exhibition of the writer's scope, or the end he has in view in a particular place. Every particle and word, every phrase and sentence, forms a link in the chain of reasoning drawn out by an inspired author—a step in the progress of his holy revelations. A commentary should thus exhibit the design of a writer in a certain connection—the arguments he employs to establish his positions, their coherence with one another, their general harmony, and the degree of importance assigned to them.

(c.) In addition to this, the train of thought or reasoning pursued throughout an entire book or epistle, the various topics discussed, the great end of the whole, with the subordinate particulars it embraces, the digressions made by the writer—these, and other particulars of a like nature, should be pointed out by the true commentator. The connection of one argument with another, the consistency and *ultimate* bearing of all the statements advanced—in short, their various relations, as far as these are developed or intimated by the author, should be clearly apprehended and intelligently stated.

(1.) Another characteristic of commentary is, that it presents a comparison of the sentiments contained in one book, or one entire connected portion of Scripture, with those of another, and with the general tenor of revelation. A beautiful harmony pervades the Bible. Diversities, indeed, it exhibits, just as we should expect it *à priori* to do; it presents difficulties and mysteries which we cannot fathom, but with this variety there is a uniformity worthy of the wisdom of God. A commentator should therefore be able to account for diversities of sentiment, in reference to the same topic, that appear in the pages of books written at different periods, and addressed to individuals or communities whose circumstances, intellectual and physical, were dissimilar. Without it religious truth will be seen in disjointed fragments; no connected system, compact and harmonious in its parts, will meet the eye.

(2.) From what has been stated in regard to the constituents of commentary, it will also be seen that it differs from *translation*. The latter endeavors to find in another language equivalent terms expressive of the ideas which the words of the Hebrew and Greek languages were framed to convey. It is easy to see, however, that in many cases this cannot be done, and that in others it can be effected very imperfectly. There are and must be a thousand varieties of conception expressed in the original languages of Scripture, of which no other can afford an adequate representation. The inhabitants of the countries where the sacred books were written lived amid circumstances in many respects diverse from those of other people. These circumstances naturally gave a coloring to their language. They affected it in such a way as to create terms for which there are no equivalents in the languages of tribes who are conversant with different objects, and live amid different relations. In such a case no expedient is left but circumlocution. By the help of several phrases we must try to approximate at least the sentiment or shade of thought which the inspired writers designed to express. *Commentary* is thus more diffuse than *translation*. Its object is not to find words in one language corresponding to those of the original languages of the Scriptures, or nearly resembling them in significance, but to set forth the meaning of the writers in notes and remarks of considerable length. *Paraphrase* occupies a middle place between translation and commentary, partaking of greater diffuseness than the former, but of less extent than the latter. It aims at finding equivalent terms to those which the sacred writers employ, accompanied with others that appear necessary to fill up the sense, or to spread it out before the mind of the reader in such a form as the authors themselves might be supposed to have employed in reference to the people to whom the paraphrase belongs. *Scholia* differ from commentary only in brevity. They are short notes on passages of Scripture. Sometimes difficult places alone are selected as their object; at other times they embrace continuously an entire book.

II. There are two kinds of commentary which we shall notice, viz. the *critical* and the *popular*. 1. The former contains grammatical and philological remarks, unfolds the general and special significations of words, points out idioms and peculiarities of the original languages, and always brings into view the Hebrew or Greek phraseology employed by the sacred writers. It dilates on the peculiarities and difficulties of construction which may present themselves, referring to various readings, and occasionally bringing into comparison the sentiments and diction of profane writers, where they resemble those of the Bible. In a word, it takes a wide range, while it states the processes which lead to results, and shrinks not from employing the technical language common to scholars. Extended dissertations are sometimes given, in which the language is made the direct subject of examination, and

the aid of lexicons and grammars called in to support or confirm a certain interpretation. 2. *Popular* commentary states in perspicuous and untechnical phraseology the sentiments of the holy writers, usually without detailing the steps by which that meaning has been discovered. It leaves philological observations to those whose taste leads them to such studies. All scientific investigations are avoided. Its great object is to present, in an attractive form, the thoughts of the sacred authors, so that they may vividly impress the mind and interest the heart. It avoids every thing that a reader unacquainted with Hebrew and Greek would not understand, and occupies itself solely with the theology of the inspired authors—that holy sense which enlightens and saves mankind. This, however, is rather what popular commentary should do, than what it has hitherto done.

The limits of *critical* and *popular* commentary are not so wide as to prevent a partial union of both. Their ultimate object is the same, viz. to present the exact meaning which the Holy Spirit intended to express. Both may state the import of words and phrases; both may investigate the course of thought pursued by prophets and apostles. They may develop processes of argumentation, the scope of the writers' remarks, the bearing of each particular on a certain purpose, and the connection between different portions of Scripture. Yet there is much difficulty in combining their respective qualities. In *popularizing* the critical, and in elevating the popular to the standard of intelligent interpretation, there is room for the exercise of great talent. The former is apt to degenerate into philological sterility, the latter into trite reflection. But by vivifying the one, and solidifying the other, a good degree of affinity would be effected. Critical and antiquarian knowledge should only be regarded as a means of arriving at the truth taught. Geographical, chronological, and historical remarks should solely subserve the educement or confirmation of Jehovah's will.

III. The prominent defects of existing commentaries.—1. *Prolixity*. This defect chiefly applies to the older works; hence their great size. It is not uncommon to meet with a large folio volume of commentary on a book of Scripture of moderate extent. Thus Byfield, on the Epistle to the Colossians, fills a folio volume; and Venema, on Jeremiah, two quartos. Peter Martyr's "most learned and fruitful commentaries upon the Epistle to the Romans" occupy a folio, and his "commentaries upon the book of Judges" another tome of the same extent. But Venema on the Psalms, and Caryl on Job, are still more extravagant, the former extending to no less than six volumes quarto, the latter to two goodly folios. It is almost superfluous to remark that such writers wander away, without confining themselves to exposition. We do not deny that even their extraneous matter may be good and edifying to those who have the patience to wade through its labyrinths, but still it is not *commentary*. It is very easy to write, *currente calamo*, any thing however remotely connected with a passage, or to note down the thoughts as they rise; but to *think out* the meaning of a place, to exercise independent mental effort upon it, to apply severe and rigid examination to each sentence and paragraph of the original, is quite a different process. To exhibit in a lucid and self-satisfying manner the results of deep thought and indomitable industry, is far from the intention of those prolix interpreters who, in their apparent anxiety to compose a *full* commentary, present the reader with a chaos of annotations, and bury the holy sense of the inspired writers beneath the rubbish of their prosaic musings.

2. Some commentators are fond of detailing various opinions without sifting them. They procure a number of former expositions, and write down out of each what is said upon a text. They tell what one and

another learned annotator affirms, but do not search or scrutinize his affirmations. No doubt an array of names looks imposing; and the reader may stare with surprise at the extent of research displayed; but nothing is easier than to fill up pages with such patchwork, and to be as entirely ignorant of the nature of commentary as before. The intelligent reader will be inclined to say, What matters it to me what this rabbi has said, or that doctor has stated? I am anxious to know the true sense of the Scriptures, and not the varying opinions of men concerning them. It is a work of supererogation to collect a multitude of annotations from various sources, most of which the industrious collector knows to be improbable or erroneous. It is folly to adduce and combat interpretations from which the common sense and simple piety of the uneducated reader turn away with instinctive aversion. If plausible views be stated, they should be thoroughly analyzed. But in all cases the right meaning ought to be a prominent thing with the commentator, and prominently should it be manifested, surrounded, if possible, with those hues which Heaven itself has given it, and qualified by such circumstances as the Bible may furnish.

3. Another defect consists in dwelling on the easy and evading the difficult passages. This feature belongs especially to those English commentaries which are most current among us. By a series of appended remarks, plain statements are expanded; but wherever there is a real perplexity, it is glossed over with marvellous superficiality. It may be that much is said about it, but yet there is no penetration beneath the surface; and when the reader asks himself what is the true import, he finds himself in the same state of ignorance as when he first took up the Commentary in question. Pious reflections and multitudinous inferences enter largely into our popular books of exposition. They spiritualize, but they do not expound. They sermonize upon a book, but they do not catch its spirit or comprehend its meaning. When a writer undertakes to educe and exhibit the true sense of the Bible, he should not give forth his own meditations, however just and proper in themselves. Put in the room of exposition, they are wholly out of place. The simple portions of the Bible are precisely those which require little to be said on them, while to the more difficult superlative attention should be paid. But the reverse order of procedure is followed by our popular commentators. They piously descant on what is well known, leaving the reader in darkness where he most needs assistance.—Kitto, s. v.

4. A very common fault with modern commentators is the attempt to go over too much ground of text, and thus do the whole work superficially. Many are ambitious of writing a commentary on the whole Bible, often with very inadequate preparations, or leisure, or research, and thus do but little else than rehearse the conclusions of others, with scarcely any original investigation themselves. The commentator should come to his work only after a long and matured study of the Scriptures as a whole, and then, with great deliberation, and patient study and balancing of various views and conflicting opinions, proceed step by step with one book at a time; not hastily run over the entire volume, and produce the crude and first-caught materials that he has gathered suddenly and by one-sided investigations. Hence those annotations are almost always the best where a writer has confined himself to a single book or epistle, and has perhaps made it his life-long study, looking at it from every possible point of view, and verifying his conclusions by repeated comparisons and researches. Commentaries "written to order" have almost invariably been worthless. See *American Biblical Repository*, January, 1833, art. iv.

IV. We shall briefly review the principal works of this class on the Bible (adopting substantially the crit-

icisms on the older commentaries found in Kitto's *Cyclopædia*, s. v.).

1. Such as are most accessible by having been written in *English* or *Latin*, or translated into one of those languages. (See a select list of this kind, with criticisms, in the Supplem. to Jenks's *Comprehensive Commentary*.)

(1.) J. Calvin (*"Commentarii,"* etc. in his *Opp.*, translated, Edinb. 1845-56, 52 vols. 8vo).—In all the higher qualifications of a commentator Calvin is pre-eminent. His knowledge of the original languages was not so great as that of many later expositors, but in developing the meaning of the sacred writers he has few equals. It has been well remarked that he chiefly attended to the *logic* of commentary. He possessed singular acuteness, united to a deep acquaintance with the human heart, a comprehension of mind by which he was able to survey revelation in all its features, and an enlightened understanding competent to perceive sound exegetical principles, and resolute in adhering to them. He can never be consulted without advantage, although all his opinions should not be followed, especially those that result from his doctrinal prepossessions.

(2.) T. Beza (*"Test. Vet. c. schol. Tremellii et Junii, Apocr. c. notis Junii, et N. T. c. notis Beza,"* fol. Gen. 1575-79, Lond. 1598, and often; *"Bible with Annotations,"* fol. Gen. 1561-2, and often).—Beza's talents are seen to great advantage in expounding the argumentative parts of the Bible. He possessed many of the best exegetical qualities which characterized his great master. In tracing the connection of one part with another, and the successive steps of an argument, he displays much ability. His acuteness and learning were considerable. He was better acquainted with the *theology* than the *criticism* of the New Testament.

(3.) H. Hammond (*"Paraphrase and Annotations"* on the N. T., Lond. 1658, best ed. 1702; on the Psalms, in his *Works*, 4 vols. fol. 1674-84).—This learned annotator was well qualified for interpretation, and many good specimens of criticism are found in his notes. Yet he has not entered deeply into the spirit of the original, or developed with uniform success the meaning of the inspired writers. Many of the most difficult portions he has superficially examined or wholly mistaken.

(4.) M. Poole (*"Annotations"* on the whole Bible, Lond. 2 vols. fol. 1700 and before, best ed. Lond. 1840, 3 vols. 8vo).—Poole's annotations on the Holy Bible contain several valuable, judicious remarks. But their defects are numerous. The pious author had only a partial acquaintance with the original. He was remarkable neither for profundity nor acuteness. Yet he had piety and good sense, amazing industry, and an extensive knowledge of the older commentators.

Poli (*"Synopsis Criticorum"*) (fol. 4 vols. in 5, Lond. 1669-76, and several eds. since; best ed. by Leusden, Ultr. 1684).—In this large work, the annotations of a great number of the older commentators are collected and condensed, many of them from the still more extensive collection known as the *Critici Sacri* (q. v.), edited by Bp. Pearson and others (2d edit. with two supplemental vols. Frct. a. M. 1696-1701, 9 vols. fol.). But they are seldom sifted and criticised, so that the reader is left to choose among them for himself.

(5.) H. Grotius (*"Annotations"* on all the Bible and Apocr. in his *Opp.*, also ed. Moody, Lond. 1727, 2 vols. 4to).—This very learned writer investigates the literal sense of the Scriptures with great diligence and success. He had considerable exegetical tact, and a large acquaintance with the heathen classics, from which he was accustomed to adduce parallels. His taste was good, and his mode of unfolding the meaning of a passage simple, direct, and brief. His judgment was sound, free from prejudice, and liberal beyond the age in which he lived. As a commentator

he was distinguished for his uniformly good sense. It has been said without reason that he found Christ nowhere in the Old Testament. It is true that he opposed the Cocceian method, but in this he was often correct. His chief defect is in *spiritual discernment*. Hence he rests in the literal meaning in many cases, where there is a higher or ulterior reference.

(6.) J. Le Clerc ("V. T. c. *Paraphrasi, Commentario*," etc. 4 vols. fol. Amst. 1710 sq.).—Excellent notes are interspersed throughout the commentaries of this author (his work by a similar title on the N. T. was based upon that of Hammond, 2 vols. in 1, fol. Amst. 1699). His judgment was good, and his mode of interpretation perspicuous. From his richly-stored mind he could easily draw illustrations of the Bible both pertinent and just. Yet he was very defective in theological discrimination. Hence, in the *prophetic and doctrinal* books he is unsatisfactory. It has been thought, not without truth, that he had a rationalistic tendency. It is certain that he exalted his own judgment too highly, and pronounced dogmatically where he ought to have manifested a modest diffidence.

(7.) A. Calmet ("*Commentaire Littéral*" on the entire Bible and Apoc. Par. 1724, 8 vols. in 9, fol.; transl. into Latin, with the *dissertations* by J. D. Manse, 19 vols. 4to, Wirceb. 1789).—Calmet is perhaps the most distinguished commentator on the Bible belonging to the Roman Catholic Church. In the higher qualities of commentary his voluminous work is very deficient. It contains a good collection of historical materials, and presents the meaning of the original where it is already plain; but his historical apparatus needs to be purified of its irrelevant, erroneous statements, while on the difficult portions no new light is thrown.

(8.) Patrick, Lowth, Arnald, and Whitby ("*Critical Commentary*," etc. on the O. and N. T. and Apoc. 6 vols. 4to, Lond. 1822; 4 vols. 8vo, Phila. and N. Y. 1845).—Bishop Patrick had many of the elements belonging to a good commentator. His learning was great when we consider the time at which he lived, his method brief and perspicuous. Lowth is inferior to Patrick. Whitby presents a remarkable compound of excellences and imperfections. In philosophy he was a master. In critical elucidations of the text he was at home. Nor was he wanting in acuteness or philosophical ability. His judgment was singularly clear, and his manner of annotating straightforward. Yet he had not much comprehensiveness of intellect, nor a deep insight into the spiritual nature of revelation.

(9.) M. Henry ("*Exposition of the O. and N. Test.*" Lond. 1704 sq., 5 vols. fol., and various eds. since, latest Lond. 1849, 6 vols. 4to, condensed with Scott's *Notes* and Doddridge's *Practical Observations*, besides additions from other sources, in Jenks's *Comprehensive Commentary*, Brattleboro, Vt. 1836 sq., 5 vols. 8vo).—The name of this good man is venerable, and will be held in everlasting remembrance. His commentary does not contain much *exposition*. It is full of *sermonizing*. It is surprising, however, to see how far his good sense and simple piety led him into the doctrine of the Bible, apart from many of the higher qualities belonging to a successful commentator. His prolixity is great. *Practical preaching* is the burden of his voluminous notes.

(10.) J. Gill ("*Exposition of the O. and N. Test.*" Lond. 1763, 9 vols. fol., and several times since).—The prominent characteristic of Gill's commentary is *heaviness*. It lacks condensation and brevity. The meaning of the inspired authors is often undeveloped, and more frequently distorted. Gill's chief merit was his Rabbinical learning.

(11.) P. Doddridge ("*Family Expositor of the N. T.*" Lond. 1789, 6 vols. 4to, and often since; Amherst, Mass. 1837, 1 vol. 8vo).—The taste of this pious commentator was good, and his style remarkably pure, and not much acumen or comprehension of mind;

but he had an excellent judgment, and a calm candor of inquiry. His paraphrase leaves much unexplained, while it dilutes the strength of the *original*. The practical observations are excellent. The notes are few, and ordinarily correct.

(12.) T. Scott ("*Holy Bible with Notes*," etc. Lond. 1692, and often since; Lond. 1841, 6 vols. 4to; Bost. 1827, 6 vols. 8vo).—The prevailing characteristic of Scott's commentary is judiciousness in the opinions advanced. The greater portion of it, however, is not *proper exposition*. The pious author preaches abet and paraphrases the original. His simplicity of purpose generally preserved him from mistakes; but as a commentator he was neither acute nor learned. He wanted a competent acquaintance with the original power of analysis, a mind unprepossessed by a doctrinal system, and penetration of spirit.

(13.) A. Clarke ("*Holy Bible, with Commentary*," etc. 8 vols. 4to, Lond. 1810-23, and often since; best ed. Lond. 1844, 6 vols. 8vo, N. Y. 1843).—In many of the higher qualities by which an interpreter should be distinguished, this man of much reading was wanting. His commentary, however, which was the chief literary labor of his life, is replete with profound and varied, though not always accurate, and often inapposite, learning. He is always thoroughly earnest and practically spiritual. Some of his notions are indeed extravagant, but they are never the errors of the heart. Many of the dissertations scattered through the work possess a permanent value for their diligent research. Its historical notes are the best. Its quotations from ancient and Oriental authors are abundant and usually apt. Its remarks in vindication of the truth and consistency of Scripture are also often worthy of consultation.

(14.) E. F. C. Rosenmüller.—The "*Scholia*" of this laborious writer extend over the greater part of the Old Testament (11 pts. in 23 vols. 8vo, Lpz. 1735 sq.; "in *Compendium redacta*," by Lechner, 5 vols. 8vo).—The last editions especially are unquestionably of high value. They bring together a mass of annotation such as is sufficient to satisfy the desires of most Biblical students. Yet the learned author undertook too much to perform it in a masterly style. Hence his materials are not properly sifted, the chaff from the wheat. He has not drunk deeply into the spirit of the inspired authors. He seems, indeed, not to have had a soul attuned to the spirituality of their utterances, or impregnated with the celestial fire that touched their hallowed lips. His father, J. G. Rosenmüller, the author of the "*Scholia*" on the New Testament (5 vols. 8vo, Nurnbg. 1785, and since), is a good *word-explainer* for students beginning to read the original. He has not produced a masterly specimen of commentary on any one book or epistle.

(15.) H. Olshausen ("*Biblisches Commentar*" on the N. T. continued by Ebrard and others, 7 vols. 8vo, Königsb. 1837-56; tr. in Clarke's *Library*, Edinb. 1847 sq.; ed. by Kendrick, N. Y. 1856 sq., 6 vols. 8vo, have hitherto appeared).—One of the best examples of commentary on the New Testament with which we are acquainted has been given by this writer. The arrangement, however, being semi-historical, has some inconveniences, especially as the text is not given. The exposition is almost wholly free from the influence of German neology. Verbal criticism is but sparingly introduced, although even here the hand of a master is apparent. He is intent, however, on higher things. He investigates the thought, traces the connection, puts himself in the same position as the writers, and views with philosophic ability the holy revelations of Christ in their comprehensive tendencies. The critical and the popular are admirably mingled. The continuation of the work by other hands is scarcely equal in value.

(16.) A. Tholuck.—The commentaries of this eminent writer on various books of the New Testament, especially those on the Epistles to the Romans and

Hebrews, exhibit the highest exegetical excellences. While he critically investigates phrases and idioms, he ascends into the pure region of the ideas, unfolding the sense with much skill and discernment. His commentary on John is of a more popular cast. His interpretation of the *Bergpredigt*, or Sermon on the Mount, is very valuable. That on the Psalms is less thorough. (For the editions, see each of these books in their place.)

(17.) E. W. Hengstenberg.—This writer is too fanciful in his exegesis, too arbitrary in his philology, and too extreme in his theology to be fully trustworthy as a commentator; yet his expositions of the Psalms, Ecclesiastes, Revelation, etc., may be consulted with advantage, if used with comparison of other authors.

(18.) E. Henderson.—This commentator's translation and notes on the Minor Prophets, as well as Isaiah, Jeremiah, and Ezekiel, are admirable specimens of sound learning, good judgment, and evangelical piety. Their only fault in the exposition is an excessive leaning to literalism.

(19.) A. Barnes.—This series of *Notes on the New Test.* (N. Y. 12 vols. 12mo; Lond. 1850-52), and portions of the Old (Job, Isaiah, Daniel), have had a popularity which shows their adaptation to an extensive want. They are simple, lucid, and practical, and written with the author's happy flow of style, and are marked by genuine spirituality; but they are not characterized by critical or extensive learning.

(20.) J. A. Alexander.—The notes of this eminent scholar on Isaiah are a thorough and well-digested production. His commentaries on the Psalms and historical books of the N. T., however, are too popular to add anything to his reputation.

(21.) C. T. Kuinöl.—The commentaries of this writer, especially on the Gospels and Acts (in Latin, best ed. London, 1835, 3 vols. 8vo), although strongly tinged with rationalism, are among the best, critically and philologically considered, extant. Learning, acuteness, and candor are everywhere apparent.

(22.) G. Bush.—This author's annotations on several of the first books of the O. T., although intended for popular use, are generally characterized by good sense, genuine learning, and pious sentiment; and are the more valuable as being nearly the only good commentary on these portions of Scripture available to the common reader.

(23.) M. Stuart.—His commentaries on Romans, Hebrews, Daniel, Revelation, Proverbs, and Ecclesiastes, albeit rather diffuse and grammatical, are yet of great value for their eminent candor, careful investigation, and general apprehension of the genius and scope of the writers. To the young student especially they are indispensable.

(24.) S. T. Bloomfield.—This author's critical *Digest* (8 vols. 8vo, Lond. 1826-8), as well as his *Commentary* (Lond. 1830 sq. 2 vols. 8vo; Phila. 1836) and its *Supplement* (London, 1840, 1 vol. 8vo), all on the N. T., give very much sound and judicious exposition, and have the advantage of placing before the reader the views of earlier interpreters. Without any great attempt at originality, there is generally a careful sifting of opinions and balancing of arguments that make his comments, on the whole, the best synopsis of simple exegesis yet produced.

(25.) H. Alford ("*Gr. Test.*" with critical apparatus and notes, Lond. 1858-61, 5 vols. 8vo; vol. i, N. Y. 1869).—This scholarly edition of the Greek Test. contains a critically-revised text, a copious exhibit of various readings, valuable prolegomena, and a series of analytical, philological, and expository notes. There is not much strictly new in any of these departments, but a convenient assemblage of materials not usually accessible. The whole is wrought out with great care and learning, and presented in the most condensed form. A very serious drawback upon its value, how-

ever, is the latitudinarianism evident in the author's theological, or, perhaps, rather hermeneutical principles, which leads him in very many difficult passages rather to array the sacred authors against one another than to reconcile their apparent discrepancies. Under arrogance of superior "honesty," he too often declines the prime task of an expositor by pronouncing difficulties insoluble. The critical apparatus is pervaded by the same subjective proclivity, inasmuch that the writer has himself once or twice completely remodelled it.

(26.) F. J. V. D. Maurer ("*Commentarius in V. T.*" Lps. 1835-47, 4 vols. 8vo).—This is a series of brief annotations on the Old Test., considerably full on the poetic portions, and characterized by great acumen, with much accuracy of scholarship, but little or no combination of the spiritual insight into Holy Writ. It is chiefly valuable to students for expounding the literal meaning.

(27.) J. C. Wolf ("*Curæ in N. T.*" 5 vols. 4to, Basil. 1741).—This author, although somewhat old, deserves especial notice for his valuable mass of sound annotations.

Besides the above, the following English commentaries on portions of Scripture are entitled to particular mention, including several German works presented in an English dress by the publishers Clark, of Edinburgh (valuable additions to our literature these last, but sadly in need, as a general thing, of judicious editing), and some reprinted in this country: Trench on the Miracles and Parables; Stier on the words of Christ; Kitto's *Pictorial Bible and Daily Bible Illustrations*; Conybeare and Howson's *Life and Epistles of St. Paul*; Watson on Matt. and some other parts of the N. T.; Bengel on the N. T.; Baumgarten on the Acts; Eadie on several of the Pauline epistles; Horsley on Hosea; Elliott on Revelation; Lowth on Isaiah; Wemyss and Fry on Job; Ellicott on the pastoral epistles; Good on the Psalms and Canticles; Steiger on 1st Peter; Umbreit on Job; Billroth on Corinthians; Tittmann on John; Lightfoot's *Hora Hebraica*; Keil on Joshua and Kings; Auberlein on Daniel; Kalisch on Gen. and Exod.; Stanley on Corinthians; Jowett on several of Paul's epistles; Ginsburg on Cant. and Eccles.; Phillips and De Burgh on the Psalms; Maclean on Hebrews; Preston on Ecclesiastes, and many others which space does not permit us here to enumerate. There are commentaries on the entire Bible by Girdlestone, Wellbeloved, Wesley, Coke, Benson, Cobbin, Sutcliffe, and others; on the New Test. by Baxter, Burkitt, Gillies, Trollope, and others; on the Gospels by Quesnel, Campbell, Norton, Ryle, and others; on the Epistles by Macknight, Pyle, and others. There are also serviceable annotations on various parts of Scripture by several of the early Church fathers, especially Origen, Jerome, and Chrysostom (see CATENA), by the mediæval theologians and reformers, especially Luther, and an almost innumerable series of later commentators more or less extensive, sufficiently complete lists of which are given under the appropriate heads in this Cyclopædia. There also exist an immense number of academical dissertations of an exegetical character, chiefly by Germans, for certain collections of a few of which, well known on the Continent, see Walch, *Bibl. Theolog.* iv, 920 sq. See also the several books and divisions of Scripture in their proper place in this work. For Hebrew commentaries on the whole Jewish Scriptures, see RABINIC BIBLES.

2. The modern *Germans*, prolific as they are in theological works, have seldom ventured to undertake an exposition of the whole Bible. Each writer usually confines himself to the task of commenting on a few books. In this their wisdom is manifested. Yet they do not usually excel in good specimens of commentary, at least in the more sacred elements. They are *word-explainers*. In pointing out various readings, in

grammatical, historical, and geographical annotations, as also in subtle speculations respecting the genius of the times in which the writers of the Bible lived, they are at home. In the *lower criticism* we willingly sit at their feet and learn. But with regard to the *higher*, in all that pertains to the *logic* of commentary, in development of the sense in its holy relations, the great majority of them are lamentably wanting. Refined notions usurp the place of practical piety in their minds; and the minutiae of verbal criticism furnish them nutriment apart from the rich repast of theological sentiment and sanctifying truth. But there are some noble exceptions, several of which are designated above.

One of the most complete and recent series of German commentaries (although somewhat meagre in detail) is that published by Hirzel (Leipzig, 1841-57), consisting of a *Kurzgefasstes exegetisches Handbuch*, on the Old Test., by Hitzig, Hirzel, Thenius, Knobel, Bertheau, and J. Olshausen (in 16 vols. 8vo); on the New Test. by De Wette, with additions by Brückner, Messner, and Lücke (in 11 vols. 8vo); on the Apocrypha by Fritzsche and Grimm (in 5 vols. 8vo). A most copious and (in the German sense) valuable series is also the *Kritisch exegetischer Kommentar zum Neuen Testament*, by Dr. H. A. W. Meyer and others (Gött. in 16 pts. lately completed, with new eds. of the earlier portions). Another is the *Exeg. Handb. zu den Briefen des Apostels Paulus*, by A. Bisping (Münster, 1858); and still more deserving of notice, *Die Heilige Schrift, m. Einleit. u. erkl. Anmerkungen*, by Otto von Gerlach (2d ed. Berl. 1858); to which may be added *Die poetischen Bücher des alten Bundes, erklärt*, by H. Ewald (Gött. 1836-54, 4 vols. 8vo), together with his *Drei Erste Evangelien* (ibid. 1851, 8vo), *Sendschreiben des Paulus* (ib. 1857, 8vo), *Das B. Ijob* (ib. 1854, 8vo); *Die Propheten des alten Bundes erklärt* (Stuttg. 1842, 2 vols. 8vo), and *Comment. in Apocalypsin* (Lips. 1828, 8vo); likewise F. W. C. Umbreit's *Commentar üb. d. Propheten* (Hamb. 1842-6, 4 vols. 8vo), *Römer* (Gotha, 1856, 8vo), *Psalter* (ib. 1848, 8vo), *Sprüche Salomos* (ib. 1826, 8vo), *Kohelet* (ib. 1820, 8vo), and *Hiob* (ib. 1832, 8vo); also the *Handb. d. Einleit. d. Apocryphen*, by G. Volkmar (Tüb. 1860 sq.). A new series of critical and exegetical commentaries of great value, in German, on the books of the O. T., is also in progress by Delitzsch and Keil (Lpz. 1861 sq.), which will doubtless include the substance of those already published by these writers on several of the books (Genesis, Psalms, Canticles, Habakkuk, Joshua, Kings, Chron. separately); it is in course of publication, in an English dress, by the Messrs. Clark of Edinburgh.

J. P. Lange, assisted by several evangelical scholars, is also issuing a series of admirable homiletical commentaries on the books of the O. and N. T., of which improved translations are in course of publication in this country, edited by Dr. Schaff (N. Y. 1864 sq.). Wetstein's *Novum Testamentum Græcum* (Amst. 1751, 2 vols. fol.), and Grinfield's *Hellenistic Editio and Scholia* on the New Test. (Lond. 1843, 1848, 4 vols. 8vo) afford much valuable philological elucidation of the text. Bunsen's *Bibelwerk*, now in progress of publication (Lpz. 1858 sq. 8vo), although eccentric in many respects, has also its valuable exegetical features, especially the new translation of the text.

In addition to these, Germany has produced many other specimens of commentary that occupy a high place in the estimation of competent judges, but still remain untranslated. Among these are Lücke on John's writings, especially in the *third* edition; Genesis on Isaiah; De Wette on the Psalms; Fritzsche on Matt., Mark, and Rom.; Bähr on Colossians; Philippi on Romans; Bleek on Hebrews; Hupfeld on the Psalms; Gramberg on Chronicles; Rückert on Romans and Corinthians; Flatt on the Epistles; Lengerke on Daniel; Stier on Acts, Hebrews, James, and Jude; Hävernick on Ezekiel and Daniel; Harless on

Ephesians; Winer (in Latin) on Galatians; Schüzler (Lat.) on Job and Proverbs; and Tuch on Genesis: with numerous others, which possess much merit, accompanied, it is true, with some serious faults. Dr. Nast, of Cincinnati, is publishing in this country a commentary on the New Test. in German on an excellent plan, of which an edition in English is also issued.

8. To these may be added the *American commentaries* of Turner on Genesis, Romans, John, Ephesians, Galatians, and Hebrews; Hackett on Acts; Moore on Haggai, Zechariah, and Malachi; the notes of Owen, Whedon, Ripley, Jacobus, Hodge, and others, on the Gospels, Epistles, etc.; and numerous other less important works that might be specified, but which are given more fully under the respective books of Scripture. We may also refer to the notes accompanying the revision of the Engl. Bible now in progress by the Am. Bible Union, as furnishing much exegetical elucidation. (See a convenient list of works most accessible and useful to American students, with prices attached, and judicious practical hints on the general subject of aids to Biblical knowledge, in the *Methodist Quar. Rev.* April, 1856, p. 288-297.) Notwithstanding the above somewhat copious statement, it must, however, be admitted that a convenient and satisfactory manual of exposition on the entire Bible, adapted to the wants of the public in this country, is still a desideratum.

4. The following is a chronological conspectus of professed Commentaries on the whole canonical Scriptures (exclusive of merely improved versions or editions), as complete as we have been able to make it. For those covering the Old or the New Testament alone, see under those titles. The most important of those here enumerated are designated by an asterisk (*) prefixed: Origen, *Commentaria* (ed. Hueticus, Rothmagi, 1668, 2 vols. fol.); Augustine, *Exegetica* (in *Opp.* iii-vi), also his *Sermones* (ib. vii), and his *Questiones* (Lugd. 1561, 8vo); Paterius, *Expositio* (from Gregory, in the latter's *Opp.* IV, ii); Hugo de S. Caro, *Postilla* (6 vols. fol., Ven. et Basil. 1487, Basil. 1496, 1504, Par. 1508, Colon. 1621; 8 vols. fol., Lugd. 1645, 1688); *Walafridus Strabo, *Glossa*, etc. (a sort of *Catena*, including extracts from Rabanus Maurus, and the *Postilla* of De Lyra, 6 vols. fol., Nurem. 1494; also more complete, Duac. 1617, and Antw. 1634); Nesen, *Operationes Biblicæ* [from Luther's expositions] (Jen. 1510-11, 2 vols. 4to); Dionysius Cartusianus, *Commentarii* (Colon. 1532 sq., 12 vols. fol.); *Pellicani, *Commentarii* [except Jonah, Zech. and Rev.] (Tiguri, 1532 sq., 7 vols. fol.; with Meyer's notes on the Apocalypse, Tigur. 1542, 10 vols. fol.); Bp. Clario, *Annotaciones* [those on the O. T. are chiefly from Seb. Munster] (Venice, 1542, 1557, 1564, fol.; also in the *Crivici Sacri*); Gastius, *Commentarii* [from Augustine] (Basil. 1542, 2 vols. 4to); Vatablus, *Scholæ* [from his lectures] (in Stephens's Latin Bible, Paris, 1545, 1551; also separately, Salamanca, 1684, 2 vols. fol.; and in the *Crivici Sacri*, and since); Bruccioli, *Commentarii* (Venice, 1546, 7 pts. fol.); Castalio, *Biblia Sacra*, etc. (Basil. 1551, fol.; later with various additions, especially Francfort, 1697, fol.; also in the *Crivici Sacri*); Marloratus, *Commentarii* [on many portions of Scripture] (various places and forms, 1562-85, etc.); Strigelius, *Scholæ* [on the books of the O. T. separately, Lips. etc. 1566 sq., 18 vols. 8vo] and *Hypomnemata* (on the N. T., Lips. 1565, 8vo, and later); L. Osiander, *Annotaciones* (Tüb. 1578-84, 8 vols., 1587, 1 vol. 4to, 1589-92, 1597, Franc. 1609, 8 vols. fol.; also in German, Stuttg. 1600, and often); Tremellius and Beza, *Scholæ et Notæ* [chiefly notes by Tremellius and Junius] (Gen. 1575-9, Lond. 1593, fol., and later); Brentz, *Commentarii* [sermons] (in his *Opp.* i-vii, Tüb. 1576-90); *Calvin, *Commentarii* [except Judges, Ruth, 2 Sam., Kings, Chron., Esther, Neh., Ezra, Prov., Eccles., Cant., and Rev.] (at various times in different languages; together in Latin, in his *Opera*, Geneva, 1678, 12 vols.,

17, 7 vols., Amst. 1671, 9 vols. fol.; in English [except 1 Sam. and Job], Edinb. 1845-56, 52 vols. 8vo); Lucas Brugensis, *Notationes* (Antw. 1580, 4to; also in *critici Sacri*); also his and Molanus's and others' in the *Biblia Locomensis* (Antw. 1580, 1582 sq.; 90, fol.; also in the *Critici Sacri*); Chytraeus, *Commentarii* [on most of the books of Scripture] (in *Opp. reg.* Vitemb. 1590-2, Lips. 1598-9, 2 vols. fol.); *Sa, *otationes* (4to, Antw. 1598, 1610, Lugd. 1609, 1647, olon. 1610, 1620; fol. Lugd. 1641; also in Mariana's *choia*, Antw. 1624, fol., and in De la Haye's *Biblia*, ar. 1643, fol.); Piscator, *Commentarii* (Herb. 1601 sq., 1 vols. 8vo; 1643-5, 4 vols. fol., N. T. also separate); nodati, *Annotationes* (Genev. 1607, fol.; in English, ond. 1608, enlarged 1651, fol.); Cramer, *Auslegung* Argent. 1619, 3 vols. 4to; without the text, 1727, 4to; ad M. 1780, 2 vols. 4to); *Mariana, *Scholia* (Madid. 1619, Paris, 1620, Antw. 1624, fol.); *Eatius, *Anotationes* (Antw. 1621, fol.; Colon. 1622, 4to; enlarged y Nemius, Duaci, 1623, Antw. 1658, Par. 1663, 1683, dogunt. 1668, fol., and in De la Haye; also with the uthor's excellent notes on the Epistles, Antw. 1699, ol.); Pareus, *Commentaria* [on most of the books of he Bible] (at different times, also collected Francfort, 623, 1641, 1648, Gen. 1642, fol.; and in *Opp. Exeg.* Franc. 1647, 3 vols. fol.); Haræus, *Expositiones* [Patri- stic and mystical] (Antw. 1630, fol.); *Menochius, *Expositio* (fol. Colon. 1630, 3 vols.; Antw. 1673, Lugd. 1683, 1695, 1 vol.; with important additions by Tournemine, Par. 1719, 2 vols., Ven. 1722, 1 vol.; also in De la Haye, etc.); *Tirinus, *Commentarius* [chiefly compiled, especially from A Lapide] (fol. Antw. 1632, 3 vols.; 1645, 1656, 1668, 1688, 1719, Lugd. 1664, 1678, 1690, 1697, 1702, Venice, 1688, 1704, 1709, 1724, Aug. Vind. 1704, 2 vols.; also in De la Haye's *Biblia* and Poole's *Synopsis*); Strabo Fuldensis [ed. Leander], *Glossa* [with Lyra's *Postilla*] (Antw. 1634, 6 vols. fol.); Haak, *Dutch Annotations of Syn. of Dort* (Lond. 1637, 1667, 2 vols. fol.); Gordon, *Commentaria* (Par. 1686, 3 vols. fol.); Card. Cajetan, *Commentarii* (Lugd. 1689, 5 vols. fol.); the Nuremberg (otherwise Vinarian or Ernestian, *Erklärung* [by various authors, edited by Gerhard, Major, and other Jena professors] (Nürnb. 1640-2, and often afterwards, fol.); Quistorp, *Annotationes* (Roet. 1643, 2 vols. 4to); *De la Haye, *Biblia Magna* [a collection of the comments of Gagneus, Este, Sa, Menoch, and Tirinus] (Par. 1648, 5 vols. fol.); also his *Biblia Mariana* [an enlarged but less correct edition of the preceding, with some omissions, and the addition of De Lyra's and some original comments] (Par. 1660, 19 vols. fol.); Bp. Hall, *Contemplations* (in *Works*, i, ii, Lond. 1647; also often since separately); Friedlib, *Observationes* (Stral. 1649-50, 2 vols. fol.; enlarged, F. ad M. 1650); the Westminster Assembly's (q. v.) *Annotations* [by various divines] (Lond. 1650-7, 2 vols.; 3d ed. 1657; 3 vols. fol.); Escobar and Mendoza, *Commentarii* (Lugd. 1652-67, 9 vols. fol.); Mayer, *Commentary* [chiefly compiled] (Lond. 1658, 6 vols. fol., and 1 vol. in 4to, etc.); Trapp, *Commentary* [quaint] (Lond. 1654, 5 vols. fol.; 1867 sq., 8vo); *Grotius, *Annotationes* (O. T., Par. 1654, 3 vols. fol.; Venice, 1663, fol.; N. T., Par. 1644, 1646, 1649, fol., etc.; together, Lond. 1660, fol.; also in *Opera*, i, ii; and the *Critici Sacri*, vii, abridged by Moody, Lond. 1727, 2 vols. 4to); the *Critici Sacri* (q. v.), ed. by Bp. Pearson and others [an immense collection of exegetical treatises by various eminent scholars] (Lond. 1660, 9 vols. fol.; with the 2 additional vols. called *Supplementum*, F. ad M. 1698-1701, 9 vols. fol.; and with 4 more vols. called *Theaurus Theologicophilologicus et Theosaurus Novus*, Amst. 1698-1782, 13 vols. fol.; condensed by Poole in his *Synopsis*); Pruckner, *Commentarium* (F. ad M. 1663, 2 vols. fol.); F. de Carrières, *Commentaria* (Lugd. 1663, fol.); Brenius, *Adnotationes* [Socinian] (ed. Cuper, Amst. 1664, fol.); A Lapide, *Commentaria* [except Job and the Psalms] (Antw. 1664, 1671, 1681, 1694, 1706, Venice, 1708, 1730, 10 vols. fol.); Heinlin, Reb-

stock, Zeller, Jäger, Pfaff, and Hochstetter, *Summarien* [by order of the duke of Wirtemberg:] (Stuttgart, 1667, Lpz. 1709, Rudest. 1721, 4to, Lpz. 1721, fol. in 6 vols.); S. and H. Marestus, *Bibel* (Amst. 1669, fol.); *Poole, *Synopsis* [in large part a condensation of the *Critici Sacri*, De la Haye's *Biblia*, and similar works] (Lond. 1690-1678, 4 vols. in 5, fol.; Franc. 1679, 5 vols. fol.; Ultra. 1685, 5 vols. fol.; Franc. 1694, 5 vols. 4to; 1712, 5 vols. fol.); a different work is his original *Annotations* [completed by others] (London, 1683-5, also 1700, 2 vols. fol.; Edinb. 1803, 4 vols. 4to; Lond. 1840, 3 vols. 8vo); De Sacy, *Sainte Bible*, etc. [chiefly Patristic] (Par. 1672, 80 vols. 8vo; Leyd. 1696, 82 vols. 12mo; Bruxelles, 1728, 8 vols. 4to; Lyons, 1702, 3 vols. fol., and other eds.); Calovius, *Biblia illustrata* [in opposition to Grotius] (F. ad M. 1672-6, Dresd. 1719, 4 vols. fol.); Cocceius, *Commentarii* [on many portions of Scripture] (at various times, separately; also in *Opera*, i-v, Amst. 1675, fol. and later); Olearius, *Erklär.* (Lips. 1618-81, 5 vols. fol.); *Patrick, Lowth, Arnold, Whitty, and Lowman, *Commentary* [originally in separate portions by each author on the successive books, Lond. 1679 sq.] (Lond. 1738 sq., 7 vols. fol.; ed. Pitman, Lond. 1821, 6 vols. 4to; Phila. 1844, Lond. 1853, 4 vols. 8vo); *Schmid, *Commentarii* [on most of the books of Scripture] (at various places, separately, 1680-1704, 18 vols. 4to); Allix, *Reflections* (Lond. 1688, 2 vols. in 1, 8vo; 1809, 8vo; Oxf. 1822, 8vo; also in Bishop Watson's *Theol. Tracts*; also in French, Lond. 1687-9, 8vo; Amst. 1689, 2 vols. 8vo); S. Clarke, *Annotations*, etc. (Lond. 1690, 1760, Glasg. 1765, fol.); Ness, *Hist. and Mystery* (Lond. 1690-96, 4 vols. fol.); L. de Carrières, *Commentaire* (Paris, 1701-16, 24 vols. 12mo); Haase, *Anmerk.* etc. (Lpz. 1704, 1710, 1733, 8vo; 1707, fol.; also in Dutch, Amst. 1725, 4to); Du Hamel, *Annotations*, etc. (Par. 1706, 2 vols. fol.); Martin, *Bible expliquée* (Amst. 1707, 2 vols. fol.); *Henry, *Exposition*, etc. [completed from Acts by others] (London, 1707-15, 5 vols. fol.; 4th ed. complete, London, 1787, 5 vols. fol., and often since; new ed. Lond. 1849, 6 vols. 4to; condensed in Jenks's *Comprehensive Commentary*); *Calmet, *Commentaire* (Par. 1707-16, 23 vols., 1718, 26 vols. 4to; 1724, 8 vols. in 9, fol.; the *Dissertations*, etc., separately, Par. 1715, 5 vols. 8vo, 1720, 3 vols. 4to; the last in Latin by Manse, Lucca, 1729, 2 vols. fol., and the whole by the same, Wirceb. 1789-93, 19 vols. 4to; also in German by Mosheim, Brem. 1738-47, 6 vols. 8vo; abridged in French, Par. 1721, 8vo; many of its notes were inserted in the Abbé Vence's *Bible*, Paris, 1767-73, 17 vols. 4to, and later); Wells, *Paraphrase*, etc. (in parts, Oxf. 1708-27, 7 vols. 4to and 8vo); Raphellius, *Annotations* [illustrations from Xenophon, etc.] (first separately on the O. and N. T., Hamb. 1709-15, 2 vols. 8vo; together, Lunenb. 1731, 8vo; enlarged, L. Bat. 1747, 2 vols. 8vo); Horche, *Erklärung* [mystical—Cant. and Rev. omitted] (Marb. 1712, 4to); Mdma. Gnyon, *Explications* [mystical] (Col. et Amst. 1713-5, 20 vols. 12mo); Osterwald, *Observations*, etc. [tr. from his French *Bible*, Amst. 1714, fol.] (by Chamberlayne, Lond. 1722, 8vo; 5th edition enlarged, Lond. 1779, 2 vols. 8vo); Anon. *Bibel*, etc. (Stuttg. 1716, fol.); Parker, *Commentary* [in large part compiled] (Oxf. 1717-25, 4to); Anon. *Bibel*, etc. (Lemgo, 1720, fol.); the Berleburg (q. v.) *Bibel* [pietistical], by various anonymous editors (Berleburg, 1726-9, 7 vols. fol.); Pitschman, *Anmerk.* (Zitt. 1728, 4to); *Gill, *Exposition* [largely from Rabbinical sources] (originally in separate works, Lond. 1728-67, 9 vols. fol.; together, Lond. 1810, 9 vols. 4to; 1854, 6 vols. 8vo); Pfaff and Klemm, *Anmerk.* (Tüb. 1729, fol.); *Lang, *Erklär.* [in part by Adler] (in separate works, Hal. 1729-37, 7 vols. fol.); also substantially condensed in his *Biblia parenthetica* [in German—an elliptical or paraphrastic elucidation] (Lpz. 1743, 2 vols. fol.); Zeltner, *Erklärung* (Alt. 1730, 8vo; 1740, 4to); Wall, *Notes* (London, 1730-39, 3 vols. 8vo); Willisch, *Selbst-Erklär.* [completed by Haymann] (Freib. 1739,

fol.); Schmidt, *Erklär.* (Erf. 1740, 4to); Starck, *Auslegungen* (O. Test., Lpz. and Hal. 1741-7, 4 vols., N. T., Lpz. 1733-7, 8 vols. [and at other times in parts], 4to); *Chais [completed by Maclaine], *Commentaire*, etc. [from the best English interpreters] (Hague, 1743-90, 7 vols. 4to; the former part also in German, Lips. 1749-62, 4 vols. 4to); Luca ed. [by order of the pope], *Commentarii*, etc. [from various authors] (Ven. 1745, 4to); also [by the same authority] ed. Cartier, *Commentarii* [a more extensive work, with a Germ. version, for the use of the monastery of Ettenheim] (Constantine, 1751, fol.); Edwards, *Notes* [in *Works*, ii, 676]; Koke, *Anmerk.* (Hild. 1750, 4to); Slezina, *Commentarius* (Prague, 1757-60, 1770, 4 vols. 4to); Goadby, *Illustrations* [Arian] (London, 1759-70, 8 vols. fol., and later); Rider, *Family Bible* (Lond. 1763, 8 vols. fol.); Wesley, *Notes* [those on the N. T. are short, but valuable] (London, 1764, 4 vols. 4to; also in *Works*); Allen, *Exposition* [Antinomian] (London, 1765, 2 vols. fol., and later); Liebich ed., *Anmerk.* (Hirschberg, 1765, 8 vols. 8vo); *Dodd, *Commentary*, etc. [in part extracts from MSS.] (in numbers, Lond. 1765; complete, 1770, 8 vols. fol.); Hawies, *Expositor* (London, 1765-66 [also published in America], 2 vols. fol.); J. S. Braun, *Erklärung* (Erf. 1768, 8 vols. fol.); Michaelis, *Anmerk.* (Gött. and Gotha, 1769-83, and 1790-2, 17 vols. 4to; also in Dutch, Utrecht, 1780-86, 8vo; and *Erinnerungen* on the same by Schulz, Halle, 1790-4, 6 vols. 4to); Körner, *Anmerk.* (Lpz. 1770-3, 8 vols. 4to); Moldenhauer, *Erläut.* (Quedlinb. 1774-87, 10 vols. 4to and 2 vols. fol.); Weitenauer [Rom. Cath.], *Anmerk.* (Augsb. 1777-82, 14 vols. 8vo); Hezel, *Anmerk.* (Lemgo, 1780-91, 10 vols. 8vo; condensed by Schenk, Lemgo, 1787, 8vo; with the author's partial enlargement, Halle, 1788-90, 9 vols. 8vo; and this again annotated by Roos, Tübing. 1788, fol.); Bp. Wilson, *Notes*, etc. (Lond. 1785, 8 vols. 4to); H. Braun, *Anmerk.* (Nürnberg, 1786, 8vo; ed. by Feder, 1808, 3 vols.; by Allioli, 1830-2, 6 vols.); also his [patristic] *Bemerk.* (Augsb. 1788-1805, 18 vols. 8vo; with a *Lexikon*, 1806, 2 vols. fol.); Yonge, *Commentary* (Lond. 1787, 4to); *Scott, *Notes*, etc. (in parts, Lond. 1788 sq., 4 vols. 4to; 5th ed. Lond. 1822, 6 vols. 4to; new ed. Lond. 1841, 6 vols. 4to; often reprinted in England and America; also condensed in Jenks's *Comprehensive Commentary*); *Rosenmüller and Son, *Schohia* [on all the books except Sam.-Ezra] (O. T. by the son, Lips. 1788-1817, etc., 22 vols. 8vo; also abridged, by Lechler, Lips. 1823-36, 6 vols. 8vo; the N. T. by the father, Norimb. 1777, 6th ed. enlarged by the son, 1815-81, 5 vols. 8vo); Brentano, *Erklär.* (Erfkt. 1797-9, 18 vols. 8vo); Horst, Rullmann, Scherer, and others, *Commentar* (Altenb. 1799-1809, 7 vols. 8vo); Alber, *Interpretatio* (Pesth, 1801-4, 16 vols. 8vo); Bulkley, *Notes* [chiefly illustrations from the ancients] (ed. by Toulmin, Lond. 1802, 3 vols. 8vo); Priestley, *Notes* (Northumb. 1803, 4 vols. 8vo); Coke, *Commentary* [mostly a reprint of Dodd] (Lond. 1806, 6 vols. 4to); Webster, [Rev. T.], *Notes* [chiefly from the Geneva Bible and Beza] (London, 1810, 4to); *A. Clarke, *Commentary* (Lond. 1810-26, 8 vols. 4to; N. Y. 1811-25, 6 vols. 4to; new ed. Lond. and N. Y. 1832, 6 vols. 8vo; Lond. 1844, 6 vols. 4to and 8vo); Hewlett, *Notes* (London, 1811, 3 vols. 4to); Fawcett, *Devotional Bible* (London, 1811, 2 vols. 4to); Benson, *Commentary* [largely after Poole] (Lond. 1811-18, 5 vols. 4to; 6th ed. 1848, 6 vols. 8vo; N. Y. 1839, 5 vols. 8vo); Hawker, *Commentary* (Lond. 1816-22, 10 vols. 12mo, and later); Mrs. Cornwallis, *Observations* (London, 1817, 4 vols. 8vo); D'Oyly and Mant, *Notes* [chiefly compiled] (Oxf. 1817, 8 vols. 4to, and often since; N. Y. 1818-20, 2 vols. 4to; London, 1856, 1861, 3 vols. 8vo); Von Meyer, *Anmerkungen* (F. ad M. 1819, 1822, 8 vols. 8vo); Anon. *Erläut.* (Quedlinb. 1819-21, 5 vols. 8vo); the Richters' *Hausbibel* (Barm. 1820, 8vo); Mrs. Stevens, *Comments* (Knaresb. 1823-31, 20 vols. 8vo); Boothroyd, *Version*, etc. (Huddersf. 1824, 8 vols. 4to; Lond. 1853, 8vo); Williams, *Age Bible* (Lond. 1825-27, 3 vols. 8vo); Greenfield,

Comprehensive Bible (Lond. 1827, 4to); Plumtree, *Sermons* (London, 1827, 2 vols. 8vo); Stokes, *Commentary* [chiefly from Scott] (London, 1835-36, 6 vols. 8vo and 12mo); Abbé Glairé, *Notes*, etc. [from various authors] (Par. 1835-38, 8 vols. 4to); Jenks, *Comprehensive Commentary* [chiefly an assemblage of Henry, Scott, and Doddridge] (Brattleb. 1835-38, 5 vols. 8vo); Gridstone, *Lectures* (Lond. 1835-42, 8 vols. 8vo); Davidson, *Pocket Commentary* (Edinb. 1836, 3 vols. 24mo); Wellbeloved, *Notes*, etc. [Unitarian] (London, 1838, 2 vols. 8vo); *Kitto, *Pictorial Bible*, etc. [valuable for illustrations of Oriental customs] (Lond. 1838-39, 4 vols. 4to; 1855, 4 vols. 8vo; also without the text, as *Illustrated Commentary*, Lond. 1840, 5 vols. 8vo); Cobbin, *Condensed Commentary* (2d ed. Lond. 1839, 8vo); also *Portable Commentary* (Lond. 1846, 12mo); Abbé Migne, *Commentarius* [chiefly compiled] (Paris, 1839-43, 5 vols. 8vo); *Simeon, *Discourses* [mostly practical] (Lond. 1840, 21 vols. 8vo); Sutcliffe, *Commentary* (3d ed. Lond. 1850, 2 vols. 8vo; 1854, 1 vol. 8vo); Bunse, *Bibelwerk* [intended as a popular elucidation—learned and ingenious, but extravagant] (Lpz. 1858 sq., 9 vols. [18 half vols.] 8vo [pt. i, translation; ii, exposition; iii, history, with supplemental Atlas]); Lange, *Bibelwerk* [mostly theological and homiletical] (Bielefeld. 1864 sq., 8vo [a large part of the N. T. has been issued and several books of the O. T., in successive volumes, a considerable number of which have been translated in Clark's *Foreign Theological Library*, Edinb., and some of them in N. Y., greatly enlarged and improved under the editorship of Dr. Schaff]); Wardworth, *Notes* (Lond. 1865 sq., 8vo).

Commerce, a word that does not occur in the Auth. Vers., which uses the term "trade" or "traffic;" but the idea is designated by two Heb. words: 1. רִכְוּלָה, *rekullah'* (Gesenius, *Thea. Heb.* p. 1289); Sept. in Ezek. xxvi, 12, τὰ ὑπάρχοντα, Vulg. *negotiationes*; in xxvii, 5, 16, 18, ἐμπορία, *negotatio*; from רָכַל, *rekal'*, to travel (on foot); 2. סְחָרָה, *sechorah'* (Gesen. *ib.* p. 946), Sept. ἐμπορία, Vulg. *negotatio*, Ezek. xxvii 15; from סָחַר, *sachar'*, to travel (migrate). See TRADE.

1. Commerce, in its usual acceptation, means the exchange of one thing for another—the exchange of what we have to spare for what we want, in whatever country it is produced. The origin of commerce must have been nearly coeval with the world. As pasturage and agriculture were the only employments of the first inhabitants, so cattle, flocks, and the fruits of the earth were the only objects of the first commerce, or that species of it called barter. It would appear that some progress had been made in manufactures in the ages before the flood. The building of a city or village by Cain, however insignificant the houses may have been, supposes the existence of some mechanical knowledge. The musical instruments, such as harp and organs, the works in brass and in iron exhibited by the succeeding generations, confirm the belief that the arts were considerably advanced. The construction of Noah's ark, a ship of three decks, covered over with pitch, and much larger than any modern effort of architecture, proves that many separate trades were at that period carried on. There must have been parties who supplied Noah and his three sons with the great quantity and variety of materials which they required, and this they would do in exchange for other commodities, and perhaps money. That enormous pile of building, the tower of Babel, was constructed of bricks, the process of making which appears to have been well understood. Some learned astronomers are of opinion that the celestial observations of the Chinese reach back to 2249 years before the Christian era; and the celestial observations made at Babylon, contained in a calendar of above nineteen centuries, transmitted to Greece by Alexander, reach back to within

been years of those ascribed to the Chinese. The
dians appear to have had observations quite as early
the Babylonians. See **ANTEDILUVIANS**.
Such of the descendants of Noah as lived near the
ster may be presumed to have made use of vessels
ilt in imitation of the ark—if, as some think, that
is the first floating vessel ever seen in the world—
t on a smaller scale, for the purpose of crossing riv-
s. In the course of time the descendants of his son
pheth settled in "the isles of the Gentiles," by which
e understood the islands at the east end of the Med-
ranean Sea, and those between Asia Minor and
reece, whence their colonies spread into Greece, Ita-
, and other Western lands. See **ETHNOLOGY**.

In short, from the time that men began to live in
sities, trade, in some shape, must have been carried
to supply the town-dwellers with necessaries (see
eeren, *Afr. Nat.* i, 469); but it is also clear that in-
ntrational trade must have existed and affected to
me extent even the pastoral nomade races, for we
nd that Abraham was rich, not only in cattle, but in
lver, gold, and gold and silver plate and ornaments
Gen. xiii, 2; xxiv, 22, 53; and further, that gold and
lver in a manufactured state, and silver, not improb-
ably in coin, were in use both among the settled in-
habitants of Palestine, and the pastoral tribes of Syria at
hat date (Gen. xx, 16; xxiii, 16; xxxviii, 18; Job
lii, 11), to whom those metals must in all probability
ave been imported from other countries (Hussey, *Anc.*
Veights, c. xii, 3, p. 198; Kitto, *Phys. Hist. of Pal.* p.
09, 110; see Herod. i, 216). See **CITY**.

2. Among trading nations mentioned in Scripture,
gypt holds in very early times a prominent position
see Hubbard, *Commerce of Ancient Egypt*, in the *Bibli-*
cal Repository, April, 1836), though her external trade
was carried on, not by her own citizens, but by for-
igners, chiefly of the nomade races (Heeren, *Afr. Nat.*
468; ii, 371, 372). It was an Ishmaelite caravan,
aden with spices, which carried Joseph into Egypt,
nd the account shows that slaves formed sometimes a
art of the merchandise imported (Gen. xxxvii, 25;
xxix, 1; Job vi, 19). From Egypt it is likely that
it all times, but especially in times of general scarcity,
orn would be exported, which was paid for by the
on-exporting nations in silver, which was always
weighed (Gen. xli, 67; xlii, 3, 25, 35; xliii, 11, 12, 21).
These caravans also brought the precious stones as
well as the spices of India into Egypt (Exod. xxv, 8,
1; Wilkinson, *Anc. Eg.* ii, 235, 237). Intercourse with
lyre does not appear to have taken place till a later
period, and thus, though it cannot be determined
whether the purple in which the Egyptian woollen and
linen cloths were dyed was brought by land from
Phœnicia, it is evident that colored cloths had long
been made and dyed in Egypt, and the use, at least,
of them adopted by the Hebrews for the tabernacle as
early as the time of Moses (Exod. xxv, 4, 5; comp.
Heeren, *Asiat. Nat.* i, 362; see Herod. i, 1). The pas-
ture-ground of Shechem appears from the story of Jo-
seph to have lain in the way of these caravan journeys
(Gen. xxxvii, 14, 25), probably a thoroughfare from
Damasus. See **CARAVAN**.

At the same period it is clear that trade was carried
on between Babylon and the Syrian cities (see Hub-
bard, *Commerce of Anc. Bab.* in the *Biblical Repos.*
July, 1837), and also that gold and silver ornaments
were common among the Syrian and Arabian races; a
trade which was obviously carried on by land-carriage
(Num. xxxi, 60; Josh. vii, 21; Judg. v, 30; viii, 24;
Job vi, 19). See **BABYLON**.

Sidon, which afterwards became so celebrated for
the wonderful mercantile exertions of its inhabitants,
was founded about 2200 years before the Christian era.
The neighboring mountains, being covered with excel-
lent cedar-trees, furnished the best and most durable
timber for ship-building. The inhabitants of Sidon
accordingly built numerous ships, and exported the

produce of the adjoining country, and the various ar-
ticles of their own manufacture, such as fine linen,
embroidery, tapestry, metals, glass, both colored and
figured, cut, or carved, and even mirrors. They were
unrivalled by the inhabitants of the Mediterranean
coasts in works of taste, elegance, and luxury. Their
great and universally acknowledged pre-eminence in
the arts procured for the Phœnicians, whose principal
seaport was Sidon, the honor of being esteemed, among
the Greeks and other nations, as the inventors of com-
merce, ship-building, navigation, the application of as-
tronomy to nautical purposes, and particularly as the
discoverers of several stars nearer to the north pole
than any that were known to other nations; of naval
war, writing, arithmetic, book-keeping, measures and
weights—to which, it is probable, they might have
added money. See **SIDON**.

The earliest accounts of bargain and sale reach no
higher than the time of Abraham, and his transaction
with Ephron. He is said to have weighed unto him
"400 shekels of silver, current money with the mer-
chant" (Gen. xxiii, 16). The word merchant implies
that the standard of money was fixed by usage among
merchants, who comprised a numerous and respectable
class of the community. Manufactures were by this
time so far advanced that not only those more immedi-
ately connected with agriculture, such as flour ground
from corn, wine, oil, butter, and also the most neces-
sary articles of clothing and furniture, but even those
of luxury and magnificence, were much in use, as ap-
pears by the ear-rings, bracelets of gold and of silver,
and other precious things presented by Abraham's
steward to Rebecca (Gen. xxiv, 22, 53.) See **BAR-**
GAIN.

In the book of Job, whose author, in the opinion
of the most learned commentators, resided in Arabia,
and was nearly contemporary with Abraham, much
light is thrown upon the commerce, manufactures,
and science of the age and country in which he lived.
There is mention of gold, iron, brass, lead, crystal,
jewels, the art of weaving, merchants, gold brought
from Ophir, which implies commerce with a remote
country, and topazes from Ethiopia; ship-building, so
far improved that some ships were distinguished for
the velocity of their motion; writing in a book, and
engraving letters or writing on plates of lead and on
stone with iron pens, and also seal-engraving; fishing
with hooks, and nets, and spears; musical instru-
ments, the harp and organ; astronomy, and names
given to particular stars. These notices tend to prove
that, although the patriarchal system of making pas-
turage the chief object of attention was still main-
tained by many of the greatest inhabitants where the
author of the book of Job resided, the sciences were
actively cultivated, the useful and ornamental arts in
an advanced state, and commerce prosecuted with dil-
igence and success; and this at a period when, if the
chronology of Job is correctly settled, the arts and
sciences were scarcely so far advanced in Egypt, from
whence, and from the other countries bordering upon
the eastern part of the Mediterranean Sea, they after-
wards gradually found their way into Greece. See
JOB.

The inhabitants of Arabia appear to have availed
themselves at a very early period of their advanta-
geous situation between the two fertile and opulent
countries of India and Egypt, and to have obtained
the exclusive monopoly of a very profitable carrying
trade between those countries. They were a class of
people who gave their whole attention to merchandise
as a regular and established profession, and travelled
with caravans between Arabia and Egypt, carrying
upon the backs of camels the spices of India, the
balm of Canaan, and the myrrh produced in their own
country, or of a superior quality from the opposite
coast of Abyssinia—all of which were in great demand
among the Egyptians for embalming the dead, in their

religious ceremonies, and for ministering to the pleasures of that superstitious and luxurious people. The merchants of one of these caravans bought Joseph from his brothers for twenty pieces of silver, and carried him into Egypt. The southern Arabs were eminent traders, and enjoyed a large proportion, and in general the entire monopoly, of the trade between India and the western world from the earliest ages, until the system of that important commerce was totally overturned when the inhabitants of Europe discovered a direct route to India by the Cape of Good Hope. See ARABIA.

At the period when Joseph's brethren visited Egypt, inns were established for the accommodation of travellers in that country and in the northern parts of Arabia. The more civilized southern parts of the peninsula would no doubt be furnished with caravanserais still more commodious. See CARAVANSERAI.

During the residence of the Israelites in Egypt manufactures of almost every description were carried to great perfection. Flax, fine linen, garments of cotton, rings and jewels of gold and silver, works in all kinds of materials, chariots for pleasure, and chariots for war, are all mentioned by Moses. They had extensive manufactories of brick. Literature was in a flourishing state; and, in order to give an enlarged idea of the accomplishments of Moses, it is said he was "learned in all the wisdom of the Egyptians" (Acts xii, 22). See EGYPT.

The expulsion of the Canaanites from a great part of their territories by the Israelites under Joshua led to the gradual establishment of colonies in Cyprus, Rhodes, and several islands in the Ægean Sea; they penetrated into the Euxine or Black Sea, and, spreading along the shores of Sicily, Sardinia, Gaul, Spain, and Africa, established numerous trading places, which gradually rose into more or less importance. At this period mention is first made of Tyre as a strong or fortified city, whilst Sidon is dignified with the title of Great. See CANAANITE.

The rising prosperity of Tyre soon eclipsed the ancient and long-flourishing commercial city of Sidon. About 600 years before Christ her commercial splendor appears to have been at its height, and is graphically described by Ezekiel (xxvii). The imports into Tyre were fine linen from Egypt; blue and purple from the isles of Elishah; silver, iron, tin, and lead from Tarshish—the south part of Spain; slaves and brazen vessels from Javan or Greece, Tubal, and Meshech; horses, slaves bred to horsemanship, and mules from Togarmah; emeralds, purple, embroidery, fine linen, corals, and agates from Syria; corn, balm, honey, oil, and gum from the Israelites; wine and wool from Damascus; polished ironware, precious oils, and cinnamon from Dan, Javan, and Uzal; magnificent carpets from Dedan; sheep and goats from the pastoral tribes of Arabia; costly spices, some the produce of India, precious stones, and gold from the merchants of Sheba or Sabæa, and Ramah or Regma, countries in the south part of Arabia; blue cloths, embroidered works, rich apparel in corded cedar-chests, supposed to be original India packages, and other goods from Sheba, Ashur, and Chilmad, and from Haran, Canneh, and Eden, trading ports on the south coast of Arabia. The vast wealth that thus flowed into Tyre from all quarters brought with it its too general concomitants—extravagance, dissipation, and relaxation of morals. See TYRE.

The subjection of Tyre, "the renowned city which was strong in the sea, whose merchants were princes, whose traffickers were the honorable of the earth," by Cyrus, and its subsequent overthrow by Alexander, after a determined and most formidable resistance, terminated alike the grandeur of that city and the history of ancient commerce, as far as they are alluded to in Scripture. (See Anderson's *History of Commerce*, Lond. 1764, and latest 1801; Vincent's *Commerce and*

Navigation of the Indian Ocean, Lond. 1807; Heeren's *Researches*; Barnes on the *Ancient Commerce of Western Asia*, in the *Biblical Repository*, Oct. 1840, Jan. 1841; Gilbert, *Lect. on Anc. Commerce*, Lond. 1842. See ALEXANDER.

3. Until the time of Solomon the Hebrew nation may be said to have had no foreign trade (see Tychea, *De Comm. et Nav. Hebræorum*, in the *Com. Soc. Gall.* 1808, p. 150-79). Foreign trade was indeed contemplated by the Law, and strict rules for morality in commercial dealings were laid down by it (Deut. xxviii, 12; xxv, 18-16; Lev. xix, 35, 36), and the tribes near the sea and the Phœnician territory appear to have engaged to some extent in maritime affairs (Gen. xlix, 18; Deut. xxxiii, 18; Judg. v, 17); but the spirit of the Law was more in favor of agriculture and against foreign trade (Deut. xvii, 16, 17; Lev. xxy see Josephus, *Apion*, i, 12). See ALLIANCE.

During the reign of David, king of Israel, that powerful monarch disposed of a part of the wealth obtained by his conquests in purchasing cedar-timber from Hiram, king of Tyre, with whom he kept up a friendly correspondence while he lived. He also hired Tyrian masons and carpenters for carrying on his works. See DAVID. Solomon, however, organized an extensive trade with foreign countries, but chiefly, at least so far as the more distant nations were concerned, of an import character. He imported linen yarn, horses, and chariots from Egypt. Of the horses, some appear to have been resold to Syrian and Canaanitish princes. For all these he paid gold, which was imported by sea from India and Arabia by his fleets in conjunction with the Phœnicians (1 Kings x, 22-29; see Gesenius, *The Heb.* p. 1202; comp. Heeren, *As. Nat.* i, 334). It was by Phœnicians also that the cedar and other timber for his great architectural works was brought by sea to Joppa, whilst Solomon found the provisions necessary for the workmen in Mount Lebanon (1 Kings v, 6, 9; 2 Chron. ii, 16). The united fleets used to sail into the Indian Ocean every three years from Elah and Eziongeber, ports on the Ælanitic gulf of the Red Sea, which David had probably gained from Edom; and they brought back gold, silver, ivory, sandal-wood, ebony, precious stones, apes, and peacocks. Some of these may have come from India and Ceylon, and some from the coasts of the Persian Gulf and the east coast of Africa (2 Sam. viii, 14; 1 Kings ix, 26; x, 11, 22; 2 Chron. viii, 17; see Herod. iii, 114; comp. Livingstone, *Travels*, p. 687, 692). See OPHIR.

But the trade which Solomon took so much pains to encourage was not a maritime trade only. He built, or more probably fortified, Baalbek and Palmyra; the latter at least expressly as a caravan station for the land-commerce with eastern and south-eastern Asia (1 Kings ix, 18). See SOLOMON.

After his death the maritime trade declined, and an attempt made by Jehoshaphat to revive it proved unsuccessful (1 Kings xxii, 48, 49). See TARSHISH. We know, however, that Phœnicia was supplied from Judæa with wheat, honey, oil, and balm (1 Kings v, 11; Ezek. xxvii, 17; Acts xii, 20; see Josephus, *War.* ii, 21, 2; *Life*, 13), whilst Tyrian dealers brought fish and other merchandise to Jerusalem at the time of the return from captivity (Neh. xiii, 16), as well as timber for the rebuilding of the Temple, which then, as in Solomon's time, was brought by sea to Joppa (Ezra iii, 7). Oil was exported to Egypt (Hos. xii, 1) and fine linen and ornamental girdles of domestic manufacture were sold to the merchants (Prov. xxxi, 24). The successive invasions to which Palestine was subjected, involving both large abstraction of treasure by invaders, and heavy imposts on the inhabitants to purchase immunity or to satisfy demands for tribute, must have impoverished the country from time to time (under Rehobam, 1 Kings xiv, 26; Ass xv, 18; Joash, 2 Kings, xii, 18; Amaziah, xiv, 18; Ahaz, xvi, 8; Hezekiah, xviii, 15-16; Jehoahaz and Jehoiakim, xxiii.

3, 35; Jehoiachin, xxiv, 18); but it is also clear, as be denunciations of the prophets bear witness, that such wealth must somewhere have existed in the country, and much foreign merchandise have been imported; so much so that, in the language of Ezekiel, Jerusalem appears as the rival of Tyre, and through its port, Joppa, to have carried on trade with foreign countries (Isa. ii, 6, 16; iii, 11, 23; Hos. xii, 7; Ezek. xvi, 2; Jonah, i, 3; comp. Heeren, *As. Nat.* i, p. 28). See PHENICIA.

Under the Maccabees Joppa was fortified (1 Macc. iv, 34), and later still Cesarea was built and made a port by Herod (Joseph. *Ant.* xv, 9, 6; Acts xxvii, 2). Joppa became afterwards a haunt for pirates, and was taken by Cestius; afterwards by Vespasian, and destroyed by him (Strab. xvi, p. 759; Josephus, *War.* ii, 8, 10; iii, 9, 1). See PALESTINE.

4. The internal trade of the Jews, as well as the external, was much promoted, as was the case also in Egypt, by the festivals, which brought large numbers of persons to Jerusalem, and caused great outlay in victims for sacrifices and in incense (1 Kings viii, 63; comp. Heeren, *Afr. Nat.* ii, 868). See FESTIVAL.

The places of public market were, then as now, chiefly the open spaces near the gates, to which goods were brought for sale by those who came from the outside (Neh. xiii, 15, 16; Zeph. i, 10). See GATE.

The traders in later times were allowed to intrude into the Temple, in the outer courts of which victims were publicly sold for the sacrifices (Zech. xiv, 21; Matt. xxi, 12; John ii, 14). See TEMPLE.

In the matter of buying and selling great stress is laid by the Law on fairness in dealing. Just weights and balances are stringently ordered (Lev. xix, 35, 36; Deut. xxv, 13-16). Kidnapping slaves is forbidden under the severest penalty (Exod. xxi, 16; Deut. xxiv, 7). Trade in swine was forbidden by the Jewish doctors (see Surenhusius, *Mischna, de damn.* c. 7, vol. iv, 10; Lightfoot, *Hor. Heb. on Matth.* viii, 38; Saalschütz, *Arch. Hebr.* c. 15, 16).—Kitto, s. v.; Smith, s. v. See MERCHANT.

Commination, an office in the Liturgy of the Church of England, which contains God's *threatenings* against impenitent sinners. It is directed to be used on the first day of Lent, and at other times, as the ordinary shall appoint. It is called Commination from the opening Exhortation to Repentance, in which the curses of God against sin are recited. The office for 'A Commination, or denouncing of God's anger and judgments against sinners,' was left out of the American Prayer-book, but the three concluding prayers of that office were introduced into the service for Ash-Wednesday, immediately after the Collect for that day. See Procter on *Common Prayer*, 429; Hook, *Church Dictionary*, s. v.; Eden, *Churchman's Dictionary*, s. v.

Commissary. 1. In the Church of England, an officer who fills the bishop's place in exercising ecclesiastical jurisdiction, in places so far distant from the chief city that the chancellor cannot call the people to the bishop's principal consistory court without great trouble to them.—Eden, *Churchman's Dictionary*, s. v.

2. In the Church of Rome, archbishops, bishops, or other dignitaries are deputed as *Papal Commissaries* for the exercise of functions properly belonging to the pope; and in the same manner bishops may depute *episcopal commissaries*. If they are deputed for one particular act they are temporary commissaries (*commissarii temporarii*). If several individuals are conjointly deputed for such a function they are called a *commission*. If persons are clothed by the pope, or by a bishop, with power to exercise regularly functions belonging to them, they are called *perpetual commissaries* (*commissarii perpetui*). See Wetzler und Welte, *Kirchen-Lex.* ii, 714.

Commission, 1. מִצְוָה, *dath* (a *mandate*, Ezra viii,

86; elsewhere "decree," etc.); 2. ἐπιτροπή (full *charge*, Acts xxvi, 12).

COMMISSION, ECCLESIASTICAL. See COMMISSARY.

Commissioner, a gloss rendering (1 Macc. ii, 25) for ἀντιπ, *man*, i. e. officer.

Commodianus, a Christian historian, supposed to have been born in Africa in the second half of the 3d century, and to have been converted from heathenism. He wrote, in a sort of acrostic verse, *LXXX instructions ad gentium deos*, which ridicules heathenism and exhorts the Christians to lead a pure life. It also contains Chilastic notions, and gives out the idea that Nero was the Antichrist. It is one of the oldest monuments of Christian history. It was published by Rigalt (1650); by Priorius, together with the works of Cyprian (Paris, 1666); by Schurzfleisch (Wittenb. 1704, 4to); and by Davisius (Cambridge, 1711). See Clarke, *Succession of Sac. Lit.* i, 171; Wetzler u. Welte, *Kirch.-Lex.* ii, 715.

Commodus, LUCIUS ÆLIUS AURELIUS, a Roman emperor, was born A. D. 161, and succeeded his father, Mark Aurelius, as emperor in 180. From early youth he was noted for weakness of character, licentiousness, and cruelty. His father was the first emperor who issued a decree of persecution against the Christians. On the accession to the throne of Commodus the persecution ceased, owing, it was said, to the influence of his concubine, Marcia. According to Irenæus, Christians were found during the reign of Commodus even in the palace, and in the service of the emperor. But, though Commodus did not decree to persecute the Christians, there were laws according to which Christians who were informed against were to be tried. Thus the learned senator Apollonius, who was informed against by one of his slaves, was condemned to death. Partial persecutions during the reign of Commodus are mentioned by Tertullian, and Irenæus likewise speaks of martyrs of this time. But, as Commodus was supposed to be favorably disposed toward the Christians, the governors of the provinces felt no inclination to carry out the laws against the Christians.—Wetzler u. Welte, *Kirch.-Lex.* ii, 717.

Common (κοινός). The Greek term properly signifies *what belongs to all* (as in Wisd. vii, 3, κοινός ἄνθρωπος), but the Hellenists applied it (like the Hebrew כָּל) to what was profane, i. e. *not holy*, and therefore of common or promiscuous use (Acts x, 14). They also applied the term to what was *impure*, whether naturally or legally (as in Mark vii, 2, compared with 1 Macc. i, 47, 62). Finally, it was used of meats forbidden, or such as had been partaken of by idolaters, and which, as they rendered the partakers thereof impure, were themselves called κοινά (common), and ἀκάθαρα (unclean) (see Kuinöl on Acts x, 14). See CLEAN.

Common-house. A room in a monastery where a fire is constantly kept for the monks to warm themselves.

Common Life. See BRETHREN OF THE COMMON LIFE.

Common Lot, BROTHERS OF THE. See BRETHREN OF THE COMMON LIFE.

Common Prayer, the service-book of the Church of England and of the Protestant Episcopal Church. It is so called because it contains the prayers which the members of those churches use *in common*, as distinguished from their devotions as private individuals. In the view of those churches, the devotions of separate families or persons may be conducted in any mode which best suits the circumstances of each; but joint worship, *common prayer*, must be in forms on which all are previously agreed, because these alone can equally express common wants (see Canons 4, 88, and 98, Church of England, on the obligation to use the Book of Common Prayer; Eden, *Churchman's Diction-*

ary, s. v.). As to the question of the value of such forms, see FORMS OF PRAYER. On liturgies proper (i. e. *communion service*), see LITURGY. We give here a brief sketch of the history of English and American Prayer-books.

I. *The English Prayer-book*.—The "Common Prayer" contains, in one volume, the articles of faith, and all the rites, ceremonies, and prescribed forms of the Church of England; and it is thus not only a Prayer-book, but a Ritual and Confession of Faith. Before the Reformation, the Missals, Breviaries, etc., of the Church of Rome were in use in England. In 1537 the Convocation put forth, in English, "*The godly and pious Institution of a Christian Man*," containing the Lord's Prayer, the Creed, the Commandments, and the Ave Maria. In 1547, the first of Edward VI, a committee was appointed to draw up a liturgy in English, free from Popish errors. Cramer, Ridley, and other eminent reformers were of this committee, and their book was confirmed in Parliament in 1548. This is known as the *first Prayer-book of Edward VI*. Great part of it was taken from the old services used in England before the Reformation; but the labors of Melancthon and Bucer helped to give the book its Protestant form. "About the end of the year 1550 exceptions were taken against some parts of this book, and archbishop Cramer proposed a new review. The principal alterations occasioned by this second review were the addition of the *Sentences, Exhortation, Confession, and Absolution*, at the beginning of the morning and evening services, which in the first Common Prayer-book began with the Lord's Prayer; the addition of the *Commandments* at the beginning of the communion office; the removing of some rites and ceremonies retained in the former book, such as the use of oil in confirmation, the unction of the sick, prayers for the departed souls, the invocation of the Holy Ghost at the consecration of the eucharist, and the prayer of oblation that used to follow it; the omitting the rubric that ordered water to be mixed with the wine, with several other less material variations. The habits, likewise, which were prescribed in the former book were in this laid aside; and, lastly, a rubric was added at the end of the communion office to explain the reason of kneeling at the sacrament" (Hook). The liturgy, thus revised and altered, was again confirmed by Parliament A.D. 1551. This is cited as the *second Prayer-book of Edward VI*. See Cardwell, *Two Books of Common Prayer set forth under Edward VI compared* (Lond. 1838, 8vo); Kotley, *The two Liturgies*, A.D. 1549 and 1552 (edited for the Parker Society, 8vo, 1844). See CRANMER.

Queen Mary, on her accession, repealed the acts of Edward, and restored the Romanist prayer-book. "On the accession of Elizabeth, however, this repeal was reversed, and the second book of Edward VI, with several alterations, was re-established. This liturgy continued in use during the long reign of Elizabeth, and received further additions and improvements. An accurate edition of it, and of the Latin translation of it made by Alexander Ales, was published for the Parker Society by the Rev. W. K. Clay, B.D. It is entitled *Liturgies and occasional Forms of Prayer set forth in the Reign of Queen Elizabeth* (Cambridge University Press, 1847, 8vo). Early in the reign of James I it was again revised. At this revision a collect in the daily morning and evening service, and a particular intercession in the litany, were appointed for the royal family; the forms of thanksgiving upon several occasions were then added; the questions and answers concerning the sacraments were subjoined to the catechism; and the administration of baptism was by the rubric expressly confined to the lawful minister. These and some other additions and improvements were made by the authority of James I, though they were not ratified by Parliament. In 1661, the year after the restoration of Charles II, the commissioners,

both Episcopal and Presbyterian, who had met at the Savoy to revise the liturgy, having come to no agreement [see SAVOY CONFERENCE], the Convocation agreed to the following alterations and additions, viz. several lessons in the calendar were changed for others more proper for the days; the prayers upon particular occasions were disjoined from the litany; several of the collects were altered; the epistles and gospels were taken out of the last translation of the Bible, published in 1611, instead of being read from the old version. Further, the prayer for the Parliament, that for all conditions of men, the general thanksgiving, the office of baptism for those of riper years, the form of prayer to be used at sea, for the anniversary of the martyrdom of Charles I, and for the restoration of the royal family, were added; and throughout the whole liturgy ambiguities were removed, and various improvements made. The whole book, being finished, passed both houses of Convocation; it was subscribed by the bishops and clergy, and was ratified by act of Parliament, and received the royal assent May 12, 1662. This was the last revival of the *Book of Common Prayer* in which any alteration was made by public authority. (Wheatly's *Illustr. of the Common Prayer*, appendix to introduction; Nicholl's *Pref. to his Comment. on the Book of Common Prayer*; Tomline's *Christ. Theol.* ii, 20-29; Dr. Cardwell's *History of Conferences and other Proceedings connected with the Revision of the Book of Common Prayer, from the year 1558 to the year 1660*, Oxford, 1840, 8vo). Hamon l'Estrange's *Alliance of Divine Offices* (Lond. 1659, fol.; reprinted at Oxford in 1844 in 8vo), exhibits all the liturgies of the Church of England since the Reformation, as also the service-book introduced into the Church of Scotland in 1637: it is illustrated with ample annotations. The *Liturgies Britannicæ*, published by the Rev. William Kelling, B.D., at London in 1842, exhibits the several editions of the *Book of Common Prayer* of the Church of England from its first compilation to its last revision in 1662, together with the liturgy set forth for the use of the Episcopal Church in Scotland. The Rev. W. K. Clay's *Book of Common Prayer Illustrated* (Lond. 1841, 8vo) most commodiously shows its various modifications, the date of its several parts, and the authority on which they rest. An appendix, containing various important ecclesiastical documents, concludes the volume. To those who can procure more expensive publications, the complete collection of the authentic editions of the *Book of Common Prayer*, published at London in 1848, in six large folio volumes, will doubtless be preferred. The collection, which is uniformly printed in black letter, like the original editions, comprises the liturgies of king Edward VI, 1549 and 1552; the first Prayer-book of queen Elizabeth, 1550; king James the First's Prayer-book, as settled at the Hampton Court Conference in 1604; the Scotch book of king Charles I; and Charles the Second's book, as settled at the Savoy Conference in 1662. By the Act of Uniformity, 18 and 14 Car. II, c. 4, sec. 28, it was enacted that true and perfect copies of that act, and of the *Book of Common Prayer*, 1662, should be delivered into the respective courts, and into the Tower of London, to be preserved among the records thereof in all time to come. These copies are usually termed 'the Sealed Books,' from their being exemplified under the great seal of England. From the copy in the Tower of London the folio fac-simile edition of 1848 was chiefly printed. In 1849-50 Mr. A. J. Stephens published an edition of the *Book of Common Prayer* in three octavo volumes, with notes legal and historical. The text of this edition is taken from the 'Sealed Book' of the Court of Chancery, collated with the copies preserved in the courts of Queen's Bench and Exchequer, and also with the copies in the Tower of London; in the library of St. Paul's Cathedral, London; of Christ Church, Oxford; at Ely; and with the manuscript *Book of Common Prayer* originally annexed to the

Irish statute 17 and 18 Car. II, c. 6, now preserved in the Rolls' Office at Dublin. In 1849-55 Mr. Stephens also published (3 vols. 8vo) the text of the *Book of Common Prayer* for the use of the Church of Ireland, from the same manuscript, with an introduction and notes" (Eadie, *Eccles. Encyclopædia*, s. v.).

Several attempts have been made to revise the book since 1662 without success. The first was in the reign of William III, furthered by Tillotson and Stillingfleet, who in 1688 had united with Bates, Manton, and Baxter in preparing a bill for the "comprehension of Dissenters." Failing then and in 1681, the scheme was resumed after the Revolution, and in 1689 a commission was formed to revise the Prayer-book. A number of alterations were suggested, in order, if possible, to gratify the Dissenters (see the *Revised Liturgy* of 1689, a blue-book, 1855). Nothing came of the proposition. A full account of this and other proposed revisions is given by Procter, *Hist. of the Book of Common Prayer* (Camb. 1856, 2d edit.). There is now a *Liturgical Revision Society* in England, which in its *Declaration of Principles and Objects* proposes the following changes: "1. The Rubric: the word priest to be changed; 2. The Ordination Service: words abused to the purposes of sacerdotal assumption to be altered. 3. The Visitation of the Sick: the absolution to be omitted or qualified. 4. The Baptismal Offices: words asserting the spiritual regeneration of each recipient to be altered. 5. The Catechism to be revised. 6. The Burial Service: general language to be employed in expressing hope for the departed. 7. The Athanasian Creed: the damnable clauses to be omitted. 8. The Apocryphal Lessons to be replaced by Scripture. A careful examination of the changes here specified will illustrate the chief aim of this society, which is to bring the *Book of Common Prayer* into closer conformity with the written word of God and the principles of the Reformation, by excluding all those expressions which have been assumed to countenance Romanizing doctrine or practice. It is believed this object will be greatly advanced by the combination of numbers, and the abandonment of desultory for systematic action. All, therefore, who are friendly to the cause of Protestantism in our Church—all who would gladly see the letter of our formularies, which have been altered for the worse more than once since the Reformation, brought again into harmony with the spirit of that glorious epoch—are invited to co-operate in this work, and to aid the society with their contributions, their influence, and, above all, their prayers." Four hundred and sixty English clergymen signed a petition in 1860, presented by Lord Ebury, asking for a commission to revise the *Book of Common Prayer*. On the other hand, the clerical declaration against the proposed revision received between six and seven thousand signatures. See also Fisher, *Liturgical Purity our Rightful Inheritance* (Lond. 1857, 12mo).

The *Nonjurors* (q. v.), whose quasi-separation from the Church of England lasted from 1688 to 1779, generally used the authorized Prayer-book, except in the prayer for the king. "Dr. Hicks, whose example was probably followed by Jeremy Collier, used the communion office in the first book of king Edward VI, which he regarded as more conformable to the ancient practice; but most others continued to use the *English Prayer-book* until the year 1718 (Lathbury's *History of the Nonjurors*). The following are the principal liturgies of the Nonjurors: (1.) *A Communion Office, taken partly from the Primitive Liturgies, and partly from the first English Reformed Common Prayer-book: together with Offices for Confirmation and the Visitation of the Sick* (London, 1718, 8vo. Reprinted in the fifth volume of Hall's *Fragmenta Liturgica*, in 1848, 12mo). From the publication of these offices the Nonjurors were divided into two parties—those who adopted the new, and those who retained the old offices. The obsolete, not to say superstitious ceremonies, revived in

this new communion office, were four, viz. mixing water with the wine, prayer for the dead, prayer for the descent of the Holy Spirit on the elements, and the prayer of oblation. These were called the *usages*, and those who practised them were called *usagers*. Three other ceremonies, apart from these usages, are frequently reckoned among them, viz. trine immersion at baptism; chrism, or consecrated oil in confirmation; and unction at the visitation of the sick (*ibid.* vol. I, p. xxxviii). (2.) *A Complete Collection of Devotions, taken from the Apostolical Constitutions, the Ancient Liturgies, and the Common Prayer-book of the Church of England. Part I comprehending the Publick Offices of the Church. . . . Part II Method of Private Prayer* (London, 1784, 8vo). Part I is reprinted in Hall's *Fragmenta Liturgica* (Eadie, s. v.).

II. *Common Prayer-books of Dissenters from the Church of England.*—(1.) "The earliest of these is *A Book of the Forms of Common Prayers, Administration of the Sacraments, etc., agreeable to God's Word and the use of the Reformed Churches*. This liturgy was printed by Waldegrave at London, without date, and at Middleburg, in Holland, in 1686, 1687, and 1692. The text of Waldegrave's edition is reprinted in Hall's *Fragmenta Liturgica*, vol. I; and that of the Middleburg edition, 1686, in his *Reliquia Liturgica*, vol. I. (2.) At the conference held in the Savoy in 1661 between the royal commissioners for reviewing the liturgy and the Nonconformists, the office of drawing up certain additional forms was assigned to Baxter, who presented a new form of prayer of his own composition, entitled, *The Reformation of the Liturgy as it was presented to the Right Reverend the Bishops, by the Divines appointed by his Majesties Commission to treat with them about the alteration of it*. This form of prayers is now more generally known as the Savoy Liturgy. It has been repeatedly reprinted, and will be found in the fourth volume of Hall's *Reliquia Liturgica*. A new edition of *The Book of Common Prayer, as amended by the Westminster Divines* in 1661, edited by the Rev. Dr. C. W. Shields, was published in Philadelphia (1866). The Savoy Liturgy comprises forms of prayer for 'the ordinary public worship of the Lord's day; the order of celebrating the sacrament of the body and blood of Christ, and the celebration of the sacrament of baptism; a short discourse of catechizing, and the approbation of those who are to be admitted to the Lord's Supper; the celebration of matrimony; directions for the visitation of the sick, and their communion,' with prayers; 'the order for the burial of the dead, prayer and thanksgiving for particular members of the Church;' a discourse 'of pastoral discipline,' with forms of 'public confession, absolution, and exclusion from the holy communion of the Church.' (3.) William Whiston (q. v.) was deprived of his professorship as an Arian, and being for a time suspended from communion with the Church by an act of convocation, he formed a religious society at his house in London for public worship. There he employed *The Liturgy of the Church of England reduced nearer to the primitive standard, humbly propos'd to publick consideration*. This liturgy was first published at London in 1718. Whiston believed the pseudo-Apostolical Constitutions to be the genuine work of the apostles, and has made use of them in the composition of some of his prayers. (4.) *The Book of Common Prayer, Reformed according to the Plan of the late Dr. Samuel Clarke*; or, as it is designated in the prefatory advertisement, *The Liturgy of the Church of England, with the Amendments of Dr. Clarke, and such further Alterations as were judged necessary to render it unexceptionable with respect to the Object of Religious Worship*, was first published in 1774 by the Rev. Theophilus Lindsay, M.A., who Socinianized the Arian alterations proposed by Dr. Samuel Clarke, rector of St. James's, Westminster. This Prayer-book has subsequently passed through numerous editions. It contains al-

most all the offices in the *Book of Common Prayer*, except the order of baptism for persons of riper years and the commination. The great object of the whole is to address the entire worship to God the Father, to the utter exclusion of God the Son and God the Holy Spirit. This liturgy is the basis of *A Liturgy collected principally from the Book of Common Prayer, for the Use of the First Episcopal Chapel in Boston* [Massachusetts], together with the *Psalter or Psalms of David* (Boston, 1785, 8vo). This was reprinted in 1811, and again in 1838, with further alterations. (5.) *The Book of Common Prayer, compiled for the Use of the English Church at Dunkirk, together with a Collection of Psalms*, was printed at Dunkirk in 1791. The anonymous compiler states that he followed throughout the plan proposed by Dr. Clarke. This book deviates less from the liturgy of the Church of England than the Socinian liturgy above noticed" (Eadie, s. v.). (6.) *The Sunday Service of the Methodists* was originally prepared by John Wesley. On comparing a copy of the edition of *The Sunday Service of the Methodists, with other Occasional Services* (reprinted in 1826), with the *Book of Common Prayer*, we find that the first lessons for Sundays are retained; but for the second lessons in the morning, a chapter out of the four Gospels or the Acts of the Apostles is to be read, and in the evening a chapter out of the epistles in regular rotation. Many verbal expressions, which have been excepted against, are here corrected. Select psalms are appointed to be read, while others are abridged. The only creed read is that of the apostles. The offices for the baptism of infants, or of persons of riper years, the celebration of matrimony, the communion of the sick, and the burial of the dead, are shortened. The offices for the ordination of priests and deacons, and for the consecration of bishops, are altered into forms for the ordination of deacons, elders, and superintendents; and the Thirty-nine Articles are reduced to twenty-five. The Nicene and Athanasian Creeds, and the apocryphal books of the Old Testament, are omitted. Some obsolete words are replaced by others which are more easily understood. An edition of this book was prepared, with the necessary modifications, for the use of the American Methodist Church, by Mr. Wesley, in 1784; a second edition, slightly modified, in 1786. This Prayer-book was used for some time in the American Methodist Church; but it gradually dropped out of use, without any prohibition, however, on the part of the General Conference. A modified form of it appears in *The Sunday Service of the Methodist Episcopal Church South*, edited by T. O. Summers, D. D. (Nashville, 1867). (7.) *The Liturgy of the New Church, signified by the New Jerusalem in the Revelation, prepared by Order of the General Conference*, was published in 1828, and superseded all the liturgies which had previously been used by the Swedenborgians, or followers of Emanuel Swedenborg.

III. *Scottish Common Prayer-books*.—"1. *Ancient Liturgy of the Kirk of Scotland*.—At the commencement of the Reformation in Scotland the Protestant nobles and barons, assembled at Edinburgh in December, 1577, agreed that they would rest satisfied for the present with the reading of the prayers and lessons in English, according to the order of the *Book of Common Prayer*, that is, the liturgy of king Edward VI, in every parish on Sundays and other festival days. This regulation, however, continued in force only a short time; for in 1562 the *Book of Common Order*, commonly termed 'Knox's Liturgy,' was partially introduced; and by an act of the General Assembly, passed December 26, 1564, its use was authoritatively ordained in all the churches in Scotland. This liturgy was taken from the order or liturgy used by the English church at Geneva. It contains forms for morning and evening prayer, the celebration of baptism, the Lord's Supper, and marriage; and for the election of superintendents or presbyters who were invested with

episcopal functions; the order of ecclesiastical discipline, of excommunication, and of public repentance: a treatise on fasting; and forms of prayer for domestic and private use. A new edition of *The Liturgy of the Church of Scotland*; or, *John Knox's Book of Common Order*, was published by the Rev. Dr. Cumming, at London, in 1840, in 18mo. *The New Book of Common Prayer, according to the Forme of the Kirke of Scotland, our Brethren in Faith and Covenant*, printed in 1644, is a very brief abstract of Calvin's Geneva Prayer-book, or rather of Knox's *Book of Common Order*. It is reprinted in the first volume of Hall's *Fragmenta Liturgica*. See DIRECTORY.

"2. *Liturgy of the Episcopal Church in Scotland*.—The liturgy of the Episcopal Church in Scotland is at present nearly the same as that of the Church of England. Charles I, in 1637, made an unsuccessful attempt to introduce into Scotland a *Book of Common Prayer*, copied, with some alterations, from that of England, which produced the Solemn League and Covenant. That liturgy was prepared by archbishop Spotswoode, of St. Andrew's, and Lindsay of Glasgow, assisted by Wedderburn, dean of the Chapel Royal at Edinburgh, and by bishops Guthrie, Maxwell, and Whitford. On its being sent to London, Charles I referred it to the examination of archbishop Laud, and of Wren, bishop of Ely. It was published at Edinburgh in folio, and entitled *The Book of Common Prayer and Administration of the Sacraments and other parts of Divine Service, for the Use of the Church of Scotland*. This liturgy is reprinted in the second volume of Hall's *Reliquiæ Liturgicæ*; a copious bibliographical and historical account of it will be found in vol. i, p. xiii-xxxv. From 1645 until after the restoration in 1660, the *Westminster Directory* was adopted, but by no means strictly adhered to, in various instances (as in that of praying for the civil government); and when episcopacy was restored together with monarchy, it was not thought advisable to renew the attempt to introduce a public liturgy; so that, except at ordinations, when the English forms were used, as far as local circumstances would admit, no regular form of prayer was in general use, while episcopacy continued to be the form of ministry in the Established Church. Many, indeed, of the episcopal clergy compiled forms to be used by themselves in their particular congregations, with some petitions and collects taken out of the English book, and all of them uniformly concluded their prayers with the Lord's Prayer, and their singing with the doxology. *Prayers for the Morning and Evening Service of the Cathedral Church of Aberdeen*, composed by the Rev. Henry Scougal, professor of theology in the King's College, continued in use until the Revolution, when the Presbyterians would no longer tolerate a written prayer. At length, in 1712, the *English Book of Common Prayer* was universally adopted by the Scottish Episcopal Church with little variation, except in the celebration of the Eucharist. In that service the order for the administration of the Lord's Supper is substantially that in the liturgy authorized by Charles I, but with alterations made to make it more conformable to the first and comparatively imperfectly reformed liturgy of king Edward VI. By the twenty-first canon of *The Code of Canons of the Episcopal Church in Scotland*, as revised, amended, and enacted, by an ecclesiastical synod, holden for that purpose at Edinburgh, from August 20 till September 6, 1838 (Edinburgh, 1838, 8vo), after ratifying and confirming the permission formerly granted by the bishops 'to all those who profess to be of the episcopal persuasion in Scotland. . . . to retain the use of the English office in all congregations where the said office had previously been in use,' it is enacted, 'That in the use of either the Scotch or English office no amalgamation, alteration, or interpolation whatever shall take place, nor shall any substitution of the one for the other be admitted, unless it shall be approved by the bishop.

From respect, however, for the authority which originally sanctioned the Scotch liturgy, and for other sufficient reasons, it is hereby enacted, that the Scotch communion office continue to be held of primary authority in this Church, and that it shall be used in all consecrations of bishops, but also at the opening of all general synods—p. 29, 80. Although the Scotch communion office is thus established, it is worthy of notice that this canon does not prescribe what specific edition is to be used, almost every single bishop, in the lapse of years, having made additions, and even some changes, according to their own judgment or preference. In point of doctrine, the difference between the English and Scotch offices is clear and unequivocal—the English offices being exclusively commemorative, and the Scottish most distinctly sacrificial. Besides which, the following usages are practised, not one of which is adopted in the English offices, viz.: 1. The mixing of water with the wine in the Eucharist; 2. Commemorating the faithful departed at the altar; 3. Consecrating the elements by an express invocation; 4. Using the oblatory prayer before distribution” (Eadie, s. v.). See COMMUNION SERVICE.

IV. *The American Prayer-book*.—After the American Revolution the “Protestant Episcopal Church” was established as an organization separate from the Church of England in 1784. In 1786 a committee was appointed to adapt the English liturgy to use in this country, and they prepared a book which, however, never went into general use (*The Proposed Book*, 1786; reprinted in Hall, *Reliquia Liturgicæ*, Lond. 1847).

“At the General Convention in October, 1789, the whole subject of the liturgy was thrown open by appointing committees on the different portions of the Prayer-book, whose several reports, with the action of the two houses thereupon, were consolidated in the Book of Common Prayer, etc., as it is now in use, the whole book being ratified and set forth by a vote of the Convention on the 16th of October, 1789, its use being prescribed from and after the 1st day of October, 1790. The American liturgy retains all that is excellent in the English service, omits several of its really objectionable features, brings some of the offices (the communion, for example) nearer to the primitive pattern, modifies others to suit our peculiar institutions, and, on the whole, is a noble monument to the wisdom, prudence, piety, and churchmanship of the fathers of the American Church. By the 45th canon of 1882, it is required that every minister shall, before all sermons and lectures, and all other occasions of public worship, use the Book of Common Prayer, as the same is or may be established by the authority of the General Convention of this Church. And in performing said service, no other prayers shall be used than those prescribed by the said book” (Hook, *Church Dictionary*, Am. ed. s. v.).

There seems to be a widely-diffused conviction, both in England and America, quite apart from doctrinal considerations, that the forms of morning service, which are composed of what were formerly several distinct services, are too long for use. Bennett, in his *Paraphrase with Annotations on the Book of Common Prayer* (Lond. 1709, 8vo), observes that the using of the morning prayer, the litany, and communion service at one and the same time, in one continued order, is contrary to the first intention and practice of the Church. On this subject the *Church of England Quarterly* (Lond. 1855, p. 20) remarks, “That our services are too long is generally, although not universally conceded. There is, no one will deny, much repetition in them as they are at present conducted; and the recitation of the Lord’s Prayer six times on a sacrament morning may be taken as an instance. We recognise our liturgy as deservedly endeared to our people; and neither would we recommend, nor would they suffer, any alterations in it which would tend to lower its tone. A few verbal changes, the omission of a few rubrics, a new ar-

range of the morning lessons, and we might go on without detriment for another three centuries. Much, too, must at all times be left to the discretion of the clergy.” On this and other questions as to needed changes, see the *Memorial Papers*, containing the *Circular and Questions of an Episcopal Commission* ordered by the General Convention of the P. E. Church in 1853, edited by Bp. A. Potter (Phila. 1857, 12mo); Powys, *Reconstruction of the Liturgy* (Lond. 1854).

“A writer in the *London Daily News* (1867) relates the discovery, in the library of the House of Lords, of the copy of the Act of Uniformity, 14 Charles II, 1662, with the roll affixed containing the words of the Book of Common Prayer, which had been detached and lost from the copy deposited with the House of Commons. Technically and practically, therefore, the writer remarks, the two rolls form one engrossed act, and ‘nothing can be so distinct a proof that the prayers, psalms, rubrics, etc., are the law of the land’” (*Nation*, Sept. 19, 1867).

The most important works on the Common Prayer, besides those cited in the course of this article, are Wheatly, *Rational Illustration of the Common Prayer* (Lond. 1720, fol.; new ed. 1842, 8vo); also in Bohn’s Standard Library, 12mo); Comber, *Companion to the Temple* (new ed. Oxf. 1841, 7 vols. 8vo); Sparrow, *Rationale upon the Book of Common Prayer* (new ed. Oxf. 1889, sm. 8vo); Bailey, *The Liturgy compared with the Bible* (Lond. 1838, 2 vols. 8vo); Palmer, *Origines Liturgicæ* (Oxf. 1882, 2 vols. 8vo); Berens, *Lectures on Catechism and Offices* (Oxf. 1828); Procter, *History of the Book of Common Prayer* (Lond. 1856, 2d ed. 8vo); Cardwell, *The two Liturgies of Edward VI compared* (Oxf. 1838, 8vo); Maskell, *Monumenta Rituality Ecclesiæ Anglicanæ* (Lond. 1846, 8 vols. 8vo); Freeman, *Principles of Divine Service* (Lond. 1855, 8vo); *Christian Remembrancer*, Oct. 1856, art. vii; Lathbury, *History of the Book of Common Prayer from the Reformation* (1858, 2d ed. 8vo); Cardwell, *History of Conferences for revision of the Common Prayer from 1658 to 1690* (Oxf. 1849, 8d ed. 8vo); Humphrey, *Historical and Explanatory Treatise on the Common Prayer* (Lond. 2d ed. 1856, 8vo); Stoddart, *The History of the Prayer-book, and of its Formation from previous Liturgies, with a Draft showing how our present Liturgy might, with some alterations, be advantageously revised and rearranged in more varied services* (Lond. 1864, crown 8vo); *The Annotated Book of Common Prayer, being an Historical, Ritual, and Theological Commentary on the Devotional System of the Church of England*, edited by John Henry Blunt (Lond. 1866, imp. 8vo). On the American book, see Brownell, *Family Prayer-book* (N. Y. 1855, royal 8vo); Butler, *Common Prayer interpreted by its History* (Boston, 1845, 12mo); *Am. Church Review*, Jan. 1858, art. i. See FORMS OF PRAYER; LITURGY.

Commune, or Communicate, a term made use of to denote the act of receiving the Lord’s Supper. See LORD’S SUPPER.

Communicants, (1.) a sect of Anabaptists (q. v.); (2.) a term used to designate church-members who partake of the Lord’s Supper (q. v.).

Communicatio Idiomatum, a doctrine of the Lutheran Church as to the person of Christ. In the ancient Church the question arose if a real personal unity of the divine and the human elements in the person of Christ could be effected without destroying the distinction of natures. The ancient Church maintained the reality of the personal unity of the two elements by condemning the Nestorian, Monophysite, and Monotheistic doctrines. The Lutheran theology undertook to show the possibility of this union. Luther laid the foundation of the doctrine by the assertion that Christ, according to his humanity, fills all things, and is ubiquitous. He did not use, however, the expression *communicatio idiomatum*, which was first employed

in the *Formula Concordiæ* (q. v.). Three classes of Scriptural passages were adduced by the old Lutheran writers in behalf of this doctrine: 1, those in which qualities belonging to one nature only are attributed to the whole person; 2, those which predicate of one nature an activity which belongs to the work of redemption, consequently to the whole person; 3, those which transfer divine attributes to Christ's human nature. The *Formula Concordiæ*, however, expressly rejects a restriction of the divine nature, in consequence of its union with the human. Zwingle, with whom, on the whole, the theologians of the Reformed Church agreed, rejected the doctrine of a real *communicatio idiomatum* (peculiar qualities of the two natures), and explained the passages adduced by the Lutherans as figures of speech (*ἀλλοιωσις*). The Supranaturalistic school of the later German theology does not expressly reject the doctrine, but explains it away. The Rationalistic, Æsthetic, and Speculative schools of Germany either reject it entirely, or partly put upon it an ethical or speculative construction. The revived Lutheran orthodoxy of the 19th century partly restricts itself to a mere revival of the old doctrine, and partly attempts to complete it by asserting a self-restriction of the divine nature in Christ, in consequence of his union with the human. According to this doctrine, which was in particular developed by Sartorius (*Dorpater Beiträge zu den theologischen Wissenschaften*, Hamburg, 1832) and Thomasius (*Beiträge zur kirchlichen Christologie*, Erlangen, 1845), the Logos, from the moment of his incarnation, renounced his *divine self-consciousness* in order to develop himself in a merely human form. See, besides the works already mentioned, Dörner, *History of the Person of Christ*, Edinb. translation, vol. ii.; Hase, *Evangelische Dogmatik*, p. 221 sq.; Gieseler, *Church History*, edited by Smith, vol. iv, § 37; Hagenbach, *History of Doctrines* (Smith's), § 266, 267; Pearson *On the Creed*, art. ii.; and the article CHRISTOLOGY, p. 281.

Communicative Life. Ecclesiastical writers, in describing the habits of monks, distinguish between *vita communicativa* and *vita renuntiativa*. The usual plan was for candidates to take a solemn vow of poverty, and consequently to renounce the world by disposing of their estates to charitable uses, before they entered into a community, where they were to have all things in common. Others kept their estates in their own hands, and yet enjoyed no more of them than if they had passed over to others; for they distributed their whole yearly revenue to the poor, and to such uses as the daily necessities of men required. The latter was called the *communicative life*.—Farrar, *Ecclesiastical Dictionary*, s. v.; Bingham, *Orig. Ecclesiastical*, vii, 3, 9.

Communio Laica, in the language of the Church of Rome, means properly the rank of the laity, but is more commonly used to signify the *status* of a clergyman transferred from the privileged class of the clergy to the lay community. Only the clergy of the lower grades (see CLERGY) could voluntarily go back to the rank of the laity; those who had received one of the higher orders (upwards from the diaconate) could be transferred back to the laity only by legal dispensation granted by the pope, or by degradation. Clergymen of the lower grades can, according to the canon law, contract a valid marriage, but thereby lose their benefices and the privileges of the clergy. The Council of Trent allowed that in exceptional cases the lower orders be conferred upon married men (in case they had not been married oftener than once), and, on condition of their wearing the tonsure and the clerical habit, granted to them the *privilegia canonici et fori* (see CLERGY). Papal dispensation for members of the higher clergy to re-enter the rank of the laity (in particular, for the purpose of marrying) has only been given in rare instances. The transfer of a clergyman from the rank of the laity, as a punishment, took place,

according to the ancient canonical law, in connection with deposition, but, according to the later law, only in consequence of degradation (q. v.). See Wetzer u. Welte, *Kirchen-Lex.* ii, 718; Bingham, *Orig. Ecclesiastical* xvii, 2; Farrar, *Ecclesiastical Dictionary*, s. v.

Communio Peregrina. In the early Church the term *communio* denoted not only a participation of the Eucharist, but also a right of partaking of the bounty of the Church. When travellers or strangers came to any church without bringing *letters testimonial*, by which they might be ascertained to be members of some Christian church, they were liable to the suspicion that they were under the censure of the Church to which they had belonged. Until they could thus clear themselves from imputation, they were not admitted to the Lord's table, but were allowed to derive their means of temporal maintenance from the Church fund. In this way delinquent clergymen were sometimes treated in their own churches, and this was called *communio peregrina*. They were not permitted to officiate or to be present at the celebration of the Lord's Supper until they had given satisfaction to the Church.—Farrar, *Ecclesiastical Dictionary*, s. v.; Bingham, *Orig. Ecclesiastical*, xvii, 8, 1.

Communion (*κοινωνία*, a *sharing*), in ordinary terms, an association or agreement when several persons join and partake together of one thing; hence its application to the celebration of the Lord's Supper as an act of fellowship among Christians (1 Cor. x, 16); and it is to this act of participation or fellowship that the word "communion," in the religious sense, is now chiefly applied in the English language. In 2 Cor. vi, 14, it takes the derived sense of *concord*. The "communion of the Holy Ghost" (2 Cor. xiii, 14) signifies that spiritual intercourse with the divine Spirit which the child of God maintains by faith and prayer. The Greek term has also a secondary meaning of *bestowal* in charity, in other passages, where it is rendered "contribution," "distribution," or "communication" [which see]. The word is elsewhere translated simply "fellowship" (q. v.). For a large number of treatises on this subject, see Volbeding, *Index Dissertationum*, p. 147 sq.

(1.) *Communion* (*κοινωνία*) therefore "properly means the sharing something in common with another. Hence, in the Christian sense, it signifies the sharing *divine converse* or intercourse (1 John i, 8); and as this takes place, sacramentally, in the Lord's Supper, the word, in a third stage, signifies a *joint participation* in a spiritual sense of the body and blood of Christ, i. e. of his Spirit (John vi, 68) in that sacrament (1 Cor. x, 16). Some explain the *κοινωνία* in the Lord's Supper to be a *communication* of the 'body and blood of Christ,' as though these were given by the Church to the receiver, but the above account of the order in which the senses of the word have grown out of one another shows that such an interpretation is untenable. The Church has not, nor pretends to give, anything as from herself in that ordinance, but Christians come together to hold 'communion' with each other, and with their (once-sacrificed) Lord, of the benefits of whose death, sacramentally exhibited, they are in a special, though only spiritual, manner then *partakers*. 'Communion' (*κοινωνία*) is that which is sought and spiritually partaken of by the receiver, not that which is actually conveyed by any person as the *giver*. Of the several names by which the Supper of the Lord has been at different times distinguished, that of the 'Holy Communion' is the one which the Church of England has adopted for her members. The Rubric, Articles, and Canons almost invariably employ this designation" (Eden). See EUCHARIST; LORD'S SUPPER.

(2.) In a historical sense, *communion* denotes participation in the mysteries of the Christian religion, and, of course, Church fellowship, with all its rights and privileges. Hence the term "excommunication."

In this sense the word is used also with reference to the admission of persons to the Lord's Supper. This is said to be open when all are admitted who apply; to be *strict* when confined to the members of a single society, or at least to members of the same denomination; and it is *mixed* when persons are admitted from societies of different denominations, on the profession of their faith and evidence of their piety, as is the case in Protestant churches generally. The principal difficulty on this point arises between the strict Baptists and Pædo-baptists.

CLOSE COMMUNION, Question of.—Among the Baptists there is a controversy on the subject, in which the two parties (called *Free* and *Strict* Communions) may be represented respectively by Robert Hall and by J. G. Fuller. The following statement, embracing the substance of the controversy, is taken from Brown's *Encyclopædia of Religious Knowledge*, s. v.

(a) "The opinion of Mr. Hall that baptism is not a prerequisite to the participation of the Eucharist runs through all his reasonings in favor of unrestricted communion, and is the real foundation on which they rest. His positions are the following: 1. The baptism of John was a separate institution from that appointed by Christ after his resurrection; from which it follows that the Lord's Supper was anterior to Christian baptism, and that the original communicants consisted entirely of such as had not received that ordinance. 2. That there is no such connection, either in the nature of things or by the divine institution, between baptism and the Eucharist as renders it, under all circumstances, indispensable that the former should precede the latter. 3. That admitting this to be the prescribed order, and to be sanctioned by the uniform practice of the apostles, the case of pious Pædo-baptists is a new case, calling for some peculiar treatment, in which we ought to regard rather the *spirit* than the *letter* of apostolic precedent. 4. That a schism in the Church, the mystical body of Christ, is deprecated in the New Testament as the greatest evil. 5. That a reception to Church fellowship of all such as God has received, notwithstanding a diversity of opinion and practice in matters not essential to salvation, is expressly enjoined in the New Testament (Rom. xiv, 1-5; xv, 1, 5-7). 6. That to withhold the Lord's Supper from those with whom we unite in other acts of Christian worship is a palpable inconsistency. And, lastly, that it is as impolitic as it is illiberal, being calculated to awaken a powerful prejudice, and place beyond the reach of conviction our Pædo-baptist brethren, and to engender among the Baptists themselves a narrow and sectarian feeling, wholly opposed to the enlarged spirit of the present age (*Complete Works of Robert Hall*, ii, 207-230; also i, 238-50).

(b) "The positions urged on the opposite side by Mr. J. G. Fuller are these: 1. That all the arguments which are used to destroy the identity of baptism as practiced by John and the apostles before the death of Christ, with that practiced afterwards, amount only to proof of a *circumstantial*, not an *essential* difference, and cannot, therefore, warrant the inferences of Mr. Hall in any one point. 2. That the commission of our Lord (Matt. xxviii, 19, 20) furnishes the same evidence that baptism is an indispensable prerequisite to external Church fellowship as that faith is an indispensable prerequisite to baptism. 3. That the uniform examples of the apostles is an inspired explanation of the commission under which they acted, and a pattern intended for the instruction of the Church in all succeeding ages. 4. That strict conformity to the commission of Christ, thus explained, is not *schism*, but the only possible mode of restoring and perpetuating *Christian union*. 5. That the mutual forbearance enjoined on Christians in the New Testament related to matters of real indifference, not involving the surrender of any positive institution of Christ, and is therefore inapplicable to the present case. 6. That to unite

with Pædo-Baptist brethren in all such acts of worship and benevolent effort as do not imply an abandonment of the commission is not an inconsistency, but the dictate of Christian charity. And, lastly, that to whatever imputations a strict adherence to the commission of Christ may subject the Baptist churches, it is better to suffer them than to sin; and that a deviation in deference to modern error, however conscientiously maintained, is neither charity nor Christian wisdom, since "whatever is right is wise." Christians may cordially unite in the evangelization of the world, but they do not, nor can they, without a change of sentiments, unite in the constitution of their churches (*Conversations on Strict and Mixed Communion*, by J. G. Fuller)."

It is said that most of the English Baptists favor free communion; those of the United States are mostly close communionists, except the Free-will Baptists, who are, as a body, open communionists. See Curtis, *Communion, a Review of the Arguments of Hall and Noel* (Phila. 1850, 12mo), for a full argument for close communion; also *Christian Review*, xvi, 210, and an able article by Dr. Hovey, *Bibliotheca Sacra*, Jan. 1862, art. v. See also the same Journal, July, 1864, art. i, and July, 1867, art. iii. See BAPTISTS.

II. A similar controversy has been going on in the Lutheran Church, in which the High-Church party refuses the admission of members of the Reformed and all non-Lutheran churches to communion. See LUTHERANS.

III. The Reformed Presbyterians (Covenanters) in Scotland and the United States, and the United Presbyterians in the United States, are also believers in the doctrine of close communion; but in all these churches there is a party which strongly contends against this doctrine, and in favor of open communion. At the United Presbyterian General Assembly of 1867 the subject of close communion was the chief topic of discussion. The Rev. W. C. McCune, the author of a book against close communion, was censured by a large majority. See W. C. McCune, *Close Communion, or Church Fellowship*, by Rev. J. T. Pressly, D.D., of the *United Presbyterian Theological Seminary at Allegheny, Penn.* (Cincinnati, William Scott, 1866, p. 147); also W. Annan (O. S. Presbyterian), *The Doctrine of Close Communion tested by Scripture and Reason* (Pittsburg, 1867). Mr. Annan endeavors to establish that the views entertained and defended by the leading men at present in that Church are not those which were held by the fathers of the Associate Reformed Church. In discussing the subject, Mr. Annan presents the views of Drs. Mason, Smith, and Annan, father of the author, and others, down to 1867, in support of his positions.

COMMUNION IN BOTH KINDS. "The communion was universally administered in both kinds (bread and wine), to both clergy and laity, until about the twelfth century, when the cup began to be gradually withdrawn from the laity in the Western Church, on account (as was affirmed) of the disorders to which the use of it had given rise. Communion in one kind is intimately connected with the doctrine of transubstantiation. Romanists profess to believe that Christ, whole and entire—soul, body, and divinity—is contained in either species, and in the smallest particle of each. Hence they infer that, whether the communicant receives the bread or the wine, he enjoys the full benefit of the sacrament. Thus, to support this absurd and monstrous dogma, a Christian ordinance is divided; transubstantiation justifies communion in one kind, and communion in one kind proves the truth of transubstantiation. This is the principal reason assigned in the Catechism of the Council of Trent. After alleging many frivolous reasons, such as that there is danger of spilling the wine in a crowded assembly, and thus inflicting an indignity on the blood of Christ; that many cannot bear the smell or taste of wine; that it may become vapid; that it is extremely scarce in some places, and would involve

great expense to procure it—it says, 'A circumstance which principally influenced the Church in establishing this practice was, that means were to be devised to crush the heresy which denied that Christ, whole and entire, is contained under either species, and asserted that the body is contained under the species of bread without the blood, and the blood under the species of wine without the body. This object was attained by communion under the species of bread alone, which places, as it were sensibly before our eyes, the truth of the Catholic faith.' Protestants believe that without the cup there can be no sacrament at all, and therefore the Eucharist is not celebrated in the Romish Church." For the history of this question, see LORD'S SUPPER.—Bingham, *Orig. Eccl.* xv, 5; Farrar, *Eccl. Dict.* s. v.

COMMUNION OF SAINTS, one of the points of a Christian's faith according to the Apostles' Creed.

1. According to the *Roman Catholic* definition, it is the "union between the Church triumphant (in heaven), the Church militant (on earth), and the Church suffering (in purgatory). These three form the one body, of which Christ is the invisible head, and of which the pope, Christ's vicar, is the visible head. Its members are united by a mutual communication of intercessions and prayers" (Bergier). This definition, it will be seen, prepares the way for the Roman superstitions of the invocation of saints and prayers for the dead. The saints in heaven are to be venerated and invoked by the Church militant, and the members of the latter are to be supported by the intercessions of the former. The Church militant is to support by her prayers the Church suffering; and the members of the Church militant may also offer prayers for each other. See Wetzler und Welte, *Kirchen-Lexikon*, iv, 929 sq.

2. The *Protestant* definitions vary somewhat. (a) The *Westminster Confession* says: "All saints that are united to Jesus Christ, their head, by his Spirit and by faith, have fellowship with him in his graces, sufferings, death, resurrection, and glory. And being united to one another in love, they have communion in each others' gifts and graces, and are obliged to the performance of such duties, public and private, as do conduce to their mutual good, both in the inward and outward man. Saints by profession are bound to maintain a holy fellowship and communion in the worship of God, and in performing such other spiritual services as tend to their mutual edification, as also in relieving each other in outward things, according to their several abilities and necessities; which communion, as God offereth opportunity, is to be extended unto all those who in every place call upon the name of the Lord Jesus. This communion which the saints have with Christ doth not make them in anywise partakers of the substance of his Godhead, or to be equal with Christ in any respect; either of which to affirm is impious and blasphemous." (b) Pearson and Leighton agree, substantially, in stating that "Christians have communion or fellowship with the Father, from whom cometh every good and perfect gift (1 John i, 3; 2 Pet. i, 4), with his son Jesus Christ, through whom forgiveness and mercy are conveyed to us (1 John i, 3; John xvii, 20, 23), and with the Holy Ghost, whose sanctifying graces are conferred on those whose hearts are duly prepared for their reception (Phil. ii, 1; 2 Cor. xiii, 14); that Christians have also communion with the holy angels, who are ministering spirits sent forth to minister for them who shall be heirs of salvation (Heb. i, 14; Luke xv, 10; Matt. xviii, 10); that, besides the external fellowship which they have in the word and sacraments of the Church, they have an intimate union and conjunction with all the saints on earth, as the living members of Christ (John i, 7; Col. ii, 19); and that Christians have communion not only with the saints on earth, but are of one city and one family with all those who have ever

died in the true faith and fear of God, and now enjoy the presence of the Father, and who, in their state of glory, still sympathize with the faithful below, assisting, comforting, and praying for them (Heb. xii, 22, 23). The belief of this communion of saints should excite and encourage us to holiness of life. If 'we walk in the light, as God is in the light, we have fellowship one with another;' but 'if we say that we have fellowship with him, and walk in darkness, we lie, and do not the truth' (1 John i, 6, 7). It should induce us to wish well to all mankind, and to render them every good in our power. To those who have obtained the like precious faith with ourselves, we are still more nearly related, as being in a peculiar sense children of the same Father, disciples of the same Master, animated by the same spirit, and members of the same body" (Secker, *On Catechism*, lect. xiv; Pearson, *On the Creed* (ed. 1710, p. 759); Leighton, *On the Creed* (Works, ii, 412). (c) Another view is given by Wilson, who remarks that, while the Romish view is unscriptural, that of Pearson and others is vague. His work aims to show that the bond of union among Christians (denoted by the *communio of saints*) is not to be sought (1) in identity of doctrinal beliefs, or (2) in identity of religious feeling or experience, as feeling, or (3) in identity of forms of Church government in worship, but in *moral* unity, founded in the action of the grace of God not merely in the hearts, but in the activities of Christians. See Wilson, *Bampton Lectures* (Oxford, 1851, 8vo).

COMMUNION OF THE SICK. See LORD'S SUPPER.

COMMUNION SERVICE, the office for the administration of the Eucharist, or sacrament of the Lord's Supper. See LITURGY.

COMMUNION-TABLE, a table on which the sacramental bread and wine are placed for the communion in Protestant churches. At the Reformation, *stone altars* were rejected, as likely to support the notion of a material sacrifice, against which the Reformers protested. See ALTAR; LORD'S SUPPER.

Communism, a theory of "community of property," often attempted to be realized in practice.

1. *Communitistic Ideas in the religious and philosophical Systems of ancient Paganism.*—The most ancient form of communism known to us is found in the monasteries of Buddhism, in attempts to reach an ideal of sanctity by renouncing marriage and property. In the history of Greece, a form of society based upon community of goods is ascribed to the order of Pythagoreans. But by far the most important representative of communitistic ideas in pagan antiquity is Plato, whose work on the ideal state still ranks among the best that has ever been written in favor of communism. Plato regards the possession of private property as the source of every evil for the state—of avarice, of egotism, of a low character. He therefore allows only the lowest of the three classes, into which, according to him, the state is divided, and which he excludes from a participation in the government of the state, to possess private property. The two ruling classes, the archontes and the warriors, are subjected by Plato to compulsory communism in the widest sense of the word. As both classes were to live exclusively for the state, and any private possession appeared to Plato as productive of egotism, he not only demanded for these two classes community of property, but, under certain restrictions, to be regulated by law, community of women. After the establishment of Christianity, the Neo-Platonic philosopher Plotinus was a prominent representative of communitistic ideas, and applied to the Roman Emperor Gallienus for permission to establish a state according to the Platonic ideal, upon the ruins of a destroyed city of Calabria.

II. *Communism among the Jews.*—Among the Jews, the sects of the Therapeutæ and the Essenes, whose fundamental principle was the dualism of the Eastern

religions, formed, like the Buddhists, communistic societies, the former on Lake Moeris in Egypt, the latter in the deserts near the Dead Sea. See ESSENES, THERAPEUTÆ.

III. *Monastic Communism and Socialism in the ancient Christian Church.*—The infant Christian Church at Jerusalem has been held up as at once an example of communism and an argument for it (Acts ii, 42, 44, 46). But the passage in Acts does not imply either an absolute, total, or compulsory community of goods. There is no trace in the New Testament of Jewish Essenism or of modern communism. Christianity carefully guards the individuality of each member, and considers love as the only law by which Christians are bound. It is true, however, on the other hand, that a communistic tendency existed in the Church, which developed itself in the 4th century in the establishment of the communities of anachorets and monks. See MONACHISM. The reformation of the monastic orders, began principally through the efforts of Bernard de Clairvaux in the 12th century, gave a new socialistic and communistic impulse to the laity, and led to the formation of religious bodies, united by vows of life-long poverty and asceticism. Such were the *Humilistates* (q. v.), who made vows of voluntary poverty, chastity, and fasting, but were not distinguished from the people in dress, though living together as a religious community; the *Beghards* (q. v.), a society of unmarried men, who lived in community under a master, and devoted themselves to manual labor and devotions; and a similar female association, formed as early as the 11th century, under the name of *Beguines* (q. v.). These lay associations differed from the clerical communities by considering poverty and continence as essential rules, and bore more of a socialistic than a communistic character. In the 18th century, the *Mendicant orders* (q. v.) united the socialistic organization to the clerical character, and cast the lay brotherhoods in the shade. Another sort of communistic union was that of the *Fratres et sorores liberi spiritus* (see BRETHREN OF THE FREE SPIRIT) (18th century), who held that the original state anterior to the Fall should be restored, and that the distinctions created by the law, of Church, state, society, should be abolished. In their secret assemblies (*paradieses*) the principles of the community of goods and of women was advocated by naked preachers before naked audiences of both sexes. This sect extended under different names through France, Italy, and Germany. A similar sect, under the name of *Adamites* (q. v.), advocating the community of women, arose during the Hussite wars, but was put down by the Hussite general Ziska.

IV. *Communistic and Socialistic Associations of the Times of the Reformation.*—A socialistic impulse, tending to a universal division of property, lay at the foundation of the peasant war of Germany in the early days of the Reformation. The twelve articles of the peasants, however, demanded only the abolition of feudal privileges, not a total subversion of society. The *Heavenly Prophets*, instituted by Nicholas Storch in 1521, went further; they advocated the community of goods, the substitution of polygamy for monogamy, and the abolition of all civil and ecclesiastical authority. Münzer (q. v.) went still further; his doctrine of the absolute community of all possessions was pure communism. These doctrines were admitted to the fullest extent by the Anabaptists (q. v.) of Munster. Some isolated followers of Anabaptism in the Netherlands disseminated these doctrines afterwards in France and the north of Germany. Following in the same road we find the *Libertines* of Geneva, whom Calvin strenuously opposed, and the *Familists* of Holland and England, about 1645. The communistic element is also apparent in a pure form in the organization of the Herrnhuters (Moravians), and in some communities of Auvergne, which are unions of

families under one head, by whom work is divided according to different individual capacities.

V. *Modern Communism and Socialism.*—By the side of the above religious communistic doctrines arose the modern communism, taking its source in the new antagonism to the institutions of the Middle Ages, which recognised two classes of people—the rulers, nobles and clerks, and the ruled, civilians and peasants. All the privileges belonged to the former, all the burdens to the latter. For the old divisions of society—nobles and peasants—were substituted gradually two new classes, a *moneyed aristocracy* and a *proletariat*. The recognition of the principle of equality tended to overthrow all conventional authority and privileges.

In Great Britain the germs of communism are to be found in Roger Bacon's *New Atlantis*; in More's *De optimo reipublice statu* (1516); and in Harrington's *Oceana* (1656); but no practical form of socialism appeared till the 18th century, when the *Buckamies* (q. v.) of Scotland formed a religious communistic association, which lasted fully for half a century. In the 19th century, Robert Owen (q. v.) attempted to better the condition of the cotton-weavers of New Lanark. He published his system (*A new View of Society*, 1813), in which, starting from the principle that all men are born equal, he maintains that they become good or bad through the influence of outward circumstances. But his political radicalism obliged him to leave England, and he came to the United States, where he founded the colony of New Harmony. The experiment was successful so long as money lasted, but this failing, it was abandoned in 1826. See OWEN. In the mean time, the *Owenites* had founded another colony at Orbiston, near Edinburgh, Scotland, under the guidance of Abram Combe, but it was dissolved after his death in 1827. Owen, having returned to England, became the founder and director of the *National Labor Equitable Exchange*, and the *Community Friendly Society of Manchester*. These Owenite working associations brought forth the *Chartists*, who aimed at the suppression of the powers of the clergy, the land-owners, the large capitalists, and all privileged classes.

In France, the *Declaration of the Rights of Man*, in 1789, laid down the principle of equality as the foundation of the state organization. The Constitution of 1791 acknowledged the right of property, but recognised also the corresponding right of employment for those destitute of property. The Constitution of 1793 aimed to establish greater material equality, and Marat often expressed the idea that real equality could only be established on the basis of equality of rights and equality of tastes. Under Napoleon and the Restoration these ideas were for a time forgotten, until the Revolution of July, 1830, showed again their existence and power among the *proletariat*. The Socialists before the Revolution, whose way had been prepared by other Utopists, such as Fénelon (*Republique de Salente*, *Voyage dans l'île des plaisirs*, etc.), are but few in number, if considered as distinct from the advocates of equality. Among their works the most remarkable are *La Bailliade*, a novel by Morellé (Paris, 1753); *Le Code de la Nature* (1756), presenting the idea of systematizing labor. The materialist and atheistic works of Holbach, Helvetius, Diderot, Voltaire, Rousseau, Reynal, full of Utopian theories, greatly damaged the authority of existing institutions. Communism did not practically take its modern form until after the end of the Reign of Terror; but after the Constitution of 1795 had made the franchise of voting to depend on property, the remaining terrorists joined the disfranchised classes in their opposition to all right of individual property. They aimed at bringing back society to the state of nature, claiming that in a true state of society there should be neither rich nor poor; that a common education would make all equal in their attainments. The heads of the party were Babeuf and his followers. After the fall of Babeuf, and under the military rule of

Napoleon, arose the socialistic doctrines of St. Simon and Fourier. The former explained his views in *Le Catechisme des Industriels* and *Le nouveau Christianisme*, in the former of which he proposed to establish an industrial system on the basis of perfect equality; while in the latter he attempts to demonstrate that this equality is a result of the divine commandment to love one another as brethren. In order practically to arrive at the object of St. Simon, Bazard proposed that after the death of a person, the community at large, instead of his family, should inherit his estate. Fourier expounded his system in *La Théorie des quatre Mouvements*, and *Le Traité de l'Association Domestique Agricole* (1822, 2d edit. 1841). He aims at the practical perfection of mankind, and considers happiness as the aim of all living creatures. Wealth is to be increased and disseminated, and this is to be accomplished by dividing the common property and by regulating labor, uniting persons to work in groups, industrial series, and phalanges, according to their capacity for labor; the result of the joint labor to be divided among the producers in proportion to their capital, labor, and talent. Fourier succeeded in gaining the public ear after the fall of St. Simonism, and was greatly helped by Victor Considérant. He published a newspaper, *Le Phalanstère*, in 1832, and in 1836 another, *La Phalange, Journal de la Science Sociale*, to disseminate his ideas.

St. Simonism and Fourierism gave rise to an immense number of publications in France. Among the most eminent writers are found, among the Socialists, Lamennais, who, in his *Essais sur l'Indifférence* (1827), attempts to bring the socialistic idea into unison with religious dogmas, while in his pamphlet *D'avenir* he calls the people back to union with the Church of Rome on the ground that it upholds the doctrine of equality before God, from which social equality will follow. For this he was put under the ban by the pope. Stung by this treatment, he published the *Paroles d'un Croquant; Politique à l'Usage du Peuple; Pays et Gouvernement*, which are among the most radical works extant. Of a more abstract and speculative character are the works of Pierre Leroux, *Essais sur l'Égalité* (1837), and *De l'Humanité* (1840), wherein he considers the principle of equality as a dogma, and recognises no distinctions of country, family, or property. The latter point is the foundation of Proudhon's doctrine; he attempts to prove that the right of property is unnatural in his work *Qu'est-ce que la Propriété?* (1840), to which question he returns the significant answer, *La Propriété c'est le Vol*. This work was followed by *De la Création de l'Ordre dans l'Humanité* (1848), and the *Philosophy of Misery* (1846). As the advocate of socialism among the newspapers, Louis Blanc stands first. His principal object is the organization of labor, to be accomplished by using state competition to destroy private competition; the state acting as capitalist, and rewarding each worker according to his deserts. Buonarotti's († 1837) *History of the Conspiracy of Babeuf* (*La Conspiration de Babeuf*) (Paris, 1828), gave fresh circulation to Babeuf's theories, which found organs in *Le Moniteur Républicain*, 1837-38, and *L'homme libre*, after August, 1839. A practical application of these principles was prevented by the insurrection of the *Société des Saisons*, May 12th, 1839, led by Blanqui and Barbès. The failure of that enterprise damped the communistic spirit, and for a while there were only a few solitary attempts made, such as Quenisset's (1841). Still, secret societies continued to be organized, such as the *Société des Travailleurs Égalitaires*, composed of the remaining followers of Barbès, who pushed the communistic principles to extremes, and considered materialism as the immutable law of nature. Opposed to them were the *Réformistes*, comprising the greater part of the workmen, who aimed at community of labor; a newspaper advocating their principles, *L'Atelier*, appeared in 1840. The *Icarian Communists*, headed by

depicted by the latter in his *Voyage en Icarie* (1840). The state, in this system, has no property, money, or distinct function; there are no distinctions of classes or ranks, and yet the state is immensely rich, as every thing belongs to it; the integrity of the family is preserved, and marriage held sacred, but the women are employed in the general workshops; all affairs are to be settled by the *Comités*, from whose decisions there is no appeal. These ideas were further disseminated in Cabet's newspaper, *Le Populaire*. An extreme sect of these communists was established in 1843 by Dézamy, who, bringing everything back to the individual, arrived at the fundamental maxim, *We must do as we can*; consequently, one may take all he requires for the time being. In this system no God is necessary, and man satisfies himself with what he finds in nature.

VI. *Communism and Socialism since the Revolution of February, 1848.*—This revolution gave at first a new impulse to socialism. The words *Liberté, Égalité, Fraternité*, posted on all the walls and appended to all the decrees of the republic, seemed to contain all that Socialists could wish for. The government itself was composed in part of Socialists. The result was the organization of the national work-shops, which only served to prove again the impracticability of these theories. But communism began to lift its head by the side of socialism, and made great progress with the lower classes. Both united in the insurrection of June, 1848. The putting down of the movement by General Cavaignac dispersed the leaders, some of whom took refuge in England; but their doctrines, nevertheless, continued to gain adherents among the lower classes of France. In 1850 a secret socialistic society was discovered, whose ramifications, from its centre at Beziers, extended almost through the whole of southern France, and which had completed a plan of general insurrection. This also led to the discovery, in Paris, of the secret society *La Némésis*, whose members, at their initiation, swore to defend the inalienable rights of man to liberty, equality, and fraternity.

The Socialism and Communism of Switzerland and Germany present no particularly new features, being mostly based on French theories. After the failure of the Revolution of 1849, the leaders fled from Germany to England, from whence they continued to direct the operations of the *Communist Association of Labor*, divided in circuits and communities, and strongly organized in Germany. But the alliance of the governments in 1850, the lack of energy among the confederates, and the publication of the aims of the society in June, 1851, by a tailor's apprentice, Peter Nothjung, at Leipsig, materially injured the organization. In Belgium French communistic ideas also obtained to some extent, and were upheld in several newspapers. In 1845 Considérant went to Brussels to advocate the Fourierite theories, but found no opportunity of carrying them into practice. These ideas, however, took a firmer hold among the lower classes of Italy: Pius IX, in a letter to the Italian bishops and archbishops, December 9th, 1849, recommended them to use all efforts to prevent the propagation of socialism. That the existence of these communistic societies depends on the personality of their founders, and not on their own excellence, has been demonstrated. After the death of the leading spirits, the organizations invariably degenerate, if they do not entirely disperse. In the United States a number of attempts have been made to establish communistic colonies, partly upon a merely humanitarian, and partly upon a religious basis. Among the former belong the communistic colony established by Cabet at Nauvoo, several colonies established by the German communist Weitling and his adherents, and several phalanges established by the admirers and followers of Fourier. They have all perished. Among the second class of communistic asso-

civilians belong to the Shakers (q. v.) and the German Seventh-day Baptists (q. v.), who enjoin universal celibacy, the colonies Economy and Zoar, established by Separatists from Wurtemberg, and the Oneida Community (q. v.), which teaches a community of women as well as of property.—Pierer, *Universal-Lexikon*, s. v.; Herzog, *Real-Encyclopädie*, iii, 21; Romang, *Bedeutung des Communismus aus dem Gesichtspunct des Christenthums* (Bern, 1847); Reybaud, *Études sur les Réformateurs ou Socialistes Modernes* (2 tom. Paris, 1848); Sudre, *Hist. du Communisme* (4th edit. Paris, 1850); L. Stein, *Der Socialismus u. C. d. heutigen Frankreichs* (Lpz. 1842; 2d ed. 1848); *Gesch. d. socialen Bewegung in Frankreich v. 1789 b. a. unsere Tage* (Lpz. 1850, 3 vols.); Karl Grün, *Die sociale Bewegung in Frankreich u. Belgien* (1845); Th. Mundt, *Die Gesch. d. Gesellschaft in ihren neueren Entwicklungen u. Problemen* (1844); Williams, *The Harmony Society at Economy, Pennsylvania* (New Haven, 1867). See SOCIALISM.

Community of Goods. (1.) From the fact "that the early Christians 'had all things common' (Acts ii, 44), some have supposed that to renounce all property, and to share one's goods with fellow-Christians, is the perpetual duty of Christians. But it is to be observed that no precept is given in Scripture to this effect; we have only the fact recorded that the early disciples were indifferent to property, unselfish, and 'willing to communicate.' And, if history is to be our help in this matter, it seems never to have been a part of Church discipline that goods should be common. It is usually supposed that the renunciation of private property, and the system of community of goods, was, for a time at least, adopted by the whole of the infant Church of Jerusalem. That the system, if ever so adopted, was soon discontinued, is perfectly evident. Those 'who were rich in this world' were exhorted to be 'ready to give, and glad to distribute,' which implies both that there were rich men in the churches, and that they were not required to sell all that they had, and cease to possess property, which would have left them, for the future, nothing to give. And the same may be learned from all that we read about the collections made in Greece for the poor Christians of Judæa, and from many other circumstances in the sacred history.

(2.) "But it has been contended that even in the infancy of the Church of Jerusalem, the community of goods was in reality confined to those engaged in the ministry, including the female catechists, or deaconesses, who were called 'widows.' Just at first, this description may have included all the believers; that is, those who were the first to embrace the Gospel may all have been employed in some department of the ministry. That Ananias and Sapphira thus offered themselves for the ministry is (doubtless) both a correct supposition, and one which will make the whole of the transaction recorded in Acts v intelligible" (Eden, *Churchman's Dictionary*, s. v.). This view is taken by Hinds, *Early Christianity* (pt. ii, ch. ii), who refers to Eusebius (lib. iii, c. 187) for confirmation of the suggestion.

(3.) Mosehm treats the subject largely in his treatise *De Vera Natura Communis bonorum in eccl. Hierosol.* (Dies. ad Eccl. Hist. partin. vol. i), and seeks to show that the passages in Acts ii, 44; iv, 32, imply a communion merely of the use, not the possession of property, and that only for a temporary purpose. But the more likely view is that the infant Church of Jerusalem "went so far in the ardor of their first love as to abolish the external distinction of rich and poor," perhaps as "a prophetic anticipation of the state of things in the perfected kingdom of God." The offering was entirely voluntary, and not the fruit of any command. On the contrary, the N. T. abounds in precepts for the right use of property, implying its separate and proper possession. See Hinds (l. c.); Schaff, *Apost. Ch. Hist.* § 114; Killen, *Ancient Church*, p. 52;

Neander, *Planting and Training* (Bohn's ed.), i, 258; ii, 64.

Commutation of PENANCE in the Roman Catholic Church. See PENANCE.

Compass (usually כִּנּוּר, *κεκλωδω*, to surround) is used as a noun by the A. V., especially in the phrase "fetch a compass" (כִּנּוּר, Num. xxxiv, 5; Josh. xv, 8; 2 Sam. v, 23; 2 Kings iii, 9; περιρχομαι, Acts xxviii, 18), i. e. go around.

Compel, in Matt. v, 41; xxvii, 82; Mark xv, 21, is the rendering of the A. V. for the technical term ἀγγαρεύω, to impress into public service [see ANGA-REUO]; in Luke xiv, 23 (ἀναγκάζω, often to "constrain"), it has a milder sense, i. e. urge, rather than the full meaning of coercion (as elsewhere).

Compiègne, SYNODS OF (*Conventus Compendienses; Concilium Compendiense*). The synods held in Compiègne began first in the middle of the 8th and ended in the 14th century. The Diet held by Pepin the Little, A. D. 757, at Compiègne, is counted among the synods, because the privileges of the archbishop Chrodegang were ratified and signed before the assembled bishops (Mansi, *Conciliorum nova et ampl. Collectio*, vii, 653 sq., Florent. 1766). Whether the few church laws which were issued under Charlemagne in the year 775 as capitularies, which related partly to church government, partly to ecclesiastical revenues, and partly to monastic discipline, were established at a synod in Compiègne is very doubtful, because in the record of the capitulary there is only mention made of a *synodalis conventus* (see Harduinus, *Acta Conciliorum*, iii, 2056, Paris, 1714). A synod held there in 828, at which the bishops spoke of the usurpations practised by laymen in church matters, may indeed be regarded as a diet (Mansi, l. c. xiv, 410, Venet. 1769). The synod held in Compiègne in 838 was of real importance in the development of the Church. In the year 829, a Council at Paris, in a letter to the kings Louis and Lothaire, referring to an explanation which it was said the Emperor Constantine had given, set up the opinion that the bishops were the judges of kings, but that the bishops themselves could not be judged by men. This thesis first found a practical application at the above-mentioned synod in Compiègne, as the sons of Louis desired their father to be sentenced to a public penance by the bishops, and thus declared unfit to reign (Harduinus, l. c. iv, 1878, Par. 1714; Mansi, l. c. xiv, 647). The synod of 1095 declared a nobleman, Hugo de Juicui, under the ban; that of 1286 established several regulations which aimed at securing ecclesiastical liberties; and that of 1270 declared against the unlawful possession of ecclesiastical benefices, which was regarded as sacrilege (see Harduinus, l. c. vii, 654, Par. 1714; Mansi, l. c. xxiv, 13, Venet. 1782). More important was the synod in 1801, as it made several decisions concerning ecclesiastical jurisdiction (Harduinus, l. c., p. 1247; Mansi, l. c. xxv, 87, Venet. 1782). The last synod in Compiègne issued only some decrees for the maintenance of Church discipline (see Harduinus, l. c. p. 1263; Mansi, l. c. p. 117).—Herzog, *Real-Encyclopädie*, Supplement. i, 345.

Competentes, a class of catechumens in the early Church. See CATECHUMENS.

Completorium, Completinum, or Compline (from Lat. *compleri*, to fill up), the last service in the evening; the bed-time service. According to the canonical hours, fixed hours for public prayer were introduced into the Church with the institutions of the monastic life. In the Western Church the practice of praying seven times a day was adopted in the 5th or 6th century, and the completorium was the last or finishing canonical hour. See Procter, *Hist. of the Common Prayer*, p. 11; Freeman, *Principles of Divine Service*, p. 88. Comp. CANONICAL HOURS; BREVIARY.

Complutensian POLYGLOT. See POLY-
GLOTS.

Compostella, MILITARY ORDER OF ST. JAMES OF. "St. James the Elder was adopted as the patron saint of Spain after the victory of Clavijo, and his relics were preserved at Compostella. The marvels supposed to be performed by these relics drew vast numbers of pilgrims, for whose support hospitals were established by the canons of St. Eloi. The vicinity of the Moors having rendered the roads unsafe, thirteen noblemen united for the protection of the pilgrims, and with the canons resolved to found an order of the same kind as that of the Hospitallers or Templars. The pope granted his assent in a bull, dated 5th July, 1775, accompanied with the statutes of the order. Whatever conquests were made from the infidel were declared the property of the order, and a council of thirteen knights was vested with authority to elect and depose a grand master. The knights made vows of poverty, obedience, and celibacy, and professed their belief in the immaculate conception. To protect Christians and convert infidels they vowed to be the only object in their wars with the Saracens. In most of the great battles between Christian and Moor the red cross of the order was conspicuous. The conquests of the order itself, combined with the grateful munificence of the nation, speedily increased its wealth and power beyond those of any of the other orders of knighthood. In addition to the three large commanderies of Leon, Castile, and Montalvan, it possessed nearly 200 minor commanderies, comprising, it is said, more than 200 priories, with many fiefs, cloisters, hospitals, castles, boroughs, two towns, and 178 villages, exclusive of its possessions in Portugal. This enormous wealth and power of the order excited the jealousy of the crown, in which, in 1522, the grand mastership was permanently vested by the pope. Having thus become merely honorary and dependent on the crown, the order rapidly decreased in importance."—Chambers, *Encyclopædia*, s. v.



Cross of the Order
Compostella.

and professed their belief in the immaculate conception. To protect Christians and convert infidels they vowed to be the only object in their wars with the Saracens. In most of the great battles between Christian and Moor the red cross of the order was conspicuous. The conquests of the order itself, combined with the grateful munificence of the nation, speedily increased its wealth and power beyond those of any of the other orders of knighthood. In addition to the three large commanderies of Leon, Castile, and Montalvan, it possessed nearly 200 minor commanderies, comprising, it is said, more than 200 priories, with many fiefs, cloisters, hospitals, castles, boroughs, two towns, and 178 villages, exclusive of its possessions in Portugal. This enormous wealth and power of the order excited the jealousy of the crown, in which, in 1522, the grand mastership was permanently vested by the pope. Having thus become merely honorary and dependent on the crown, the order rapidly decreased in importance."—Chambers, *Encyclopædia*, s. v.

Compostella, SANTIAGO DE, a town in Spain, and one of the three most famous places of pilgrimage in the Church of Rome, the two others being Rome and Jerusalem. The place was formerly called *ad Sanctum Jacobum Apostolum* or *Giacomo Postolo*, whence by abbreviation Compostella was formed. According to a Spanish tradition, the apostle James the Elder came to the Pyrenean peninsula, and is buried at Compostella. The legend of the apostle having preached in Spain is first mentioned in the ninth century, and has generally been repudiated by the Roman Catholic writers, although it was defended by the Bollandists (*Acta Sanct.* tom. vi, *Julii, Appendix*; and tom. i, *Aprilis, Diatribe*), and by the Protestant J. A. Fabricius (*Salutaris Lux Evangelii*, c. 16, § 2). The claim of Compostella to the body of the apostle has found more advocates among the Roman Catholic writers, although the church of St. Saturnine at Toulouse prefers the same claim. The rival claims have been compromised by assuming that each church had one half, as a division of famous relics, it is alleged, frequently occurred in the Middle Ages. Compostella was made a bishopric in the beginning of the 9th century, and in 1120 an archbishopric.—Wetzer u. Welte, *Kirchen-Lex.* ii, 736.

Comprehension, in English history, "the scheme first proposed by Sir Orlando Bridgman in 1688 for relaxing the terms of conformity to the Established Church of England, and admitting Protestant dissenters into its communion. In 1674, Tillotson and Stillfleet renewed the attempt, and the terms were set-

led to the satisfaction of the nonconformists; but, the bishops unanimously refusing their consent, the project fell to the ground. Immediately after the Revolution, the scheme was renewed at the instance of William III, but after two attempts the design of union was abandoned, and the Act of Toleration passed in its stead." See Macaulay, *History of England*, iii, 68, 380; art. ENGLAND, CHURCH OF; Eden, *Churchman's Dictionary*, s. v.

Compton, HENRY, bishop of London, son of the second Earl of Northampton, was born at Compton in 1632, and was educated at Queen's College, Oxford, which he left in 1652. After some years spent in travel on the Continent, he returned to England on the restoration of Charles II. For a short time he was a cornet in the army; then went to Cambridge, passed M.A., took orders, and was made canon of Christ Church, Oxford, in 1666. After various preferments, he was made bishop of Oxford in 1674, and was translated to the see of London in 1675 or 1676. He became tutor to the princesses Mary and Anne, and imbued them with his own earnestly Protestant sentiments. On the accession of James II he was dismissed from the council and from his deanery of the Royal Chapel on account of his vigorous opposition to popery. In 1686 he was tried before the lords commissioners (the notorious Jeffries presiding) on a charge of disobedience to the king's mandate (for the suspension of Dr. Sharp), and was suspended from his episcopal functions. He was restored in 1688, and on the accession of William he recovered all the offices from which he had been expelled. Bishop Compton sought to conciliate Dissenters, and to find means of reuniting them to the Church of England. His so-called "ultra-Protestantism" made him unpopular with High-churchmen. He died July 7, 1713. He published *A Treatise of the Holy Communion* (Lond. 1677); a number of episcopal letters and charges, etc.—*New and General Biog. Dictionary*, iv, 64 sq.

Comstock, GROVER S., a Baptist missionary, was born at Ulysses, N. Y., March 24, 1809. He graduated at Hamilton College in 1827, studied law afterwards, and was admitted to the bar in 1830. Under the ministry of the Rev. C. G. Finney he was converted, and then studied theology at the Madison University. Deciding to devote his life to missions, he entered the service of the Baptist Foreign Missionary Board, and sailed from Boston for Bernab on July 2, 1834. He remained some time at Amherst and Maulmain studying the language, and then chose Arracan for his field of labor. In 1837 he organized a native church at Kyouk Phyou; and he remained, in spite of a deadly climate, to which his wife and two children fell victims in 1843, unremitting in labor until the illness which ended in his death, April 25, 1844.—*American Missionary Memorial*, p. 155.

Comte, AUGUSTE, founder of the so-called Positivism, was born at Montpellier Jan. 12, 1798, and died at Paris Sept. 5, 1857. He was the propounder of an elaborate system of philosophy, to which he gave the name of Positive, to denote its scientific and practical character, and to distinguish it from all schemes of metaphysical speculation.

He sprung from a family eminently Roman Catholic in religion and Royalist in politics, and these influences affected the development of his theories, notwithstanding the fever of innovation which always possessed him. He was educated in Paris at the Polytechnic school, in which he became a subordinate instructor in 1832. His first dreams of philosophic reform are ascribed by him to his fourteenth year, perhaps in rivalry of the precocity attributed to Bacon. In 1816 he contemplated emigration to the United States, and the transplanting of his nascent philosophical career to America. In August, 1817, he became acquainted with the notorious St. Simon—half seer,

half charlatan—and was so strongly impressed with his visionary raptures as to be considered his most hopeful disciple, and the successor upon whom that strange sage desired his mantle to fall, though recognising Comte's fatal want of religious susceptibility. This connection was always acknowledged by Comte, though mentioned in later years with increasing bitterness and disgust. He disclaimed all obligations to St. Simon, and fumed and fretted whenever the traces of St. Simonism were recognised in his own philosophy. In April, 1826, he opened a course of gratuitous prelections on the new scheme, which had been reduced to a somewhat determinate form by several essays previously published. The course was interrupted by brain fever, terminating in insanity. In consequence of this attack, which he designates *une crise cérébrale*, he was for some time confined in a lunatic asylum.

In 1829 he commenced the immense structure of his Positive Philosophy. It was completed in six heavy volumes, containing nearly 6000 pages. The first volume appeared in 1830, its 750 pages having been composed in the space of three months. M. Comte rarely revised, and never recopied his manuscript. As it came from his brain it passed to the press, and from the press to the public. The Revolution of July delayed the prosecution of his labors for five years, but with the return of more tranquil times he resumed them, and achieved the sixth and last volume in 1842. This is the work on which M. Comte's reputation as a philosopher almost exclusively rests. It is the only one of his works accepted by the majority of his disciples, or regarded by those who follow his guidance without attaching themselves to his banner. It contains the body and substance of Positivism, and was justly rebaptized *Système de Philosophie Positive*. In his later philosophical development Comte endeavored to infuse the vital breath of a moral and religious spirit into the cadaverous Pyrrhonism of his earlier views. But this attempt, which was flagrantly unsuccessful, offended alike his sect and his distant admirers, who hailed and honored his labors rather for their systematic infidelity than for their recognised truth.

On the completion of his scheme of philosophy Comte proceeded to apply its principles to the rectification of society. It was nine years, however, before the first volume of his *Système de Politique Positive* appeared. They were years of annoyance, anguish, misfortune, and strange adventure. He had supported himself and his family by the scanty fruits of his vocation as a public and a private teacher of mathematics. To this vocation we are indebted for his *Treatise of Analytical Geometry*, published in 1843. He relieved the dull routine of duty by lectures to the Parisian community on topics connected with science, or with the promulgation of his philosophy. One of these courses is perpetuated in his *Philosophical Treatise on Popular Astronomy* (1845). His heretical opinions, and, still more, his arrogant and irritable disposition, provoked opposition, and excited ill-will among his colleagues. His position in the Polytechnic School was rendered precarious, and he was finally deprived of it. At a later period his public lectures were for a short time closed by the interference of the government. This is the long personal persecution of which he complains with habitual acrimony in his later works. He was married, but had been separated from his wife. While his heart was wrung and parched by many sorrows, a new fascination consoled him, and opened unsuspected fountains in a dry and thirsty soil. In 1845 Comte became violently attached to an accomplished lady, Madame Clotilde de Vaux, who was separated from her husband, as he was from his wife. Their association was purely Platonic, and terminated in a year by the death of the siren on April 5, 1846. The *Positive Politics* is animated throughout by her in-

spiration, and is dedicated to her, with a commemoration of her virtues, in language which would sound extravagant in Dante or Petrarch. Brief as the intimacy had been, it revolutionized Comte's whole nature and the entire spirit of his speculations.

This strange transmutation of doctrine exhibited itself in the *Discourse on the general Character of Positivism*, which belonged to the midsummer of 1848, and was employed as an introduction to the *System of Positive Politics*. The rigidity and sterility of the cold and heartless rationalism of the *Positive Philosophy* was evidently unsuited to act upon society and to regenerate it; and the application of the Positive doctrine to practical ends almost necessitated the admission of the moral element, which had been previously disregarded. Men are not controlled by their reason; they are stimulated by their imagination, and impelled by their affections. To discipline the heart, an authority, and not arguments, is required. But no practical morals are possible, as an obligatory rule of action, which do not result from the decrees of a supreme will. Thus the first step towards a systematic plan of political authority, or of sociological interpretation, must be the recognition of a Divine Legislator and the acceptance of an incontestable creed. M. Comte was thus driven, by the extension of his theories to their practical applications, to introduce ethics into the circle of the sciences, to institute a divinity, to recognise or to invent a religion. His perception of the need was quickened, if his susceptibilities were not awakened, by the resuscitation of his natural affections, and the glow of sentiment was kindled by his preposterous passion. The long interval which separated the completion of the *Philosophie Positive* from the commencement of the *Politique Positive* may have been, in reality, due less to the personal persecution of which he complains, and to the revolutionary anarchy of 1848, than to the time and thought requisite to systematize his new views, and to produce some appearance of harmony between the philosophic doctrine and its efflorescence in a theocratic dream. The whole plan was, however, arranged in his own mind when he entered upon the composition of his sociological treatise. Nothing is more admirable than the rapidity and completeness, the methodical regularity, and the preordained precision with which each successive year brought forward at the appointed time a new volume of the *Politique Positive*, till the whole was accomplished. Each volume appeared in its season, like the blossoms of the returning summer. The first was published in July, 1851; the second in May, 1852; the third in August, 1853; and the fourth in August, 1854. The second volume of the *Positive Politics* was preceded in the same month by the publication of the *Calendar of Positivism*—that singular and elaborate rebaptism of the months of the year and the days of the week which substitutes the notabilities of human progress for the Sundays and saints' days of the Catholic Church, and the months of imperial Rome. In the October of the same year was published the *Catechism of Positivism*, designed to diffuse a knowledge of the new philosophy and the new creed among the masses of the people. At the close of the *Politique Positive* M. Comte marks out the ulterior projects which he designed to achieve before advancing years should demand repose. Seven years were to be devoted to the enlargement and rectification of his theory; and then, on the attainment of his grand climacteric, he would sing his *Dimittus*. *A System of Positive Logic, or the Philosophy of Mathematics*, was promised for 1856; *A System of Positive Morals, or Treatise on Universal Education*, for 1859; and *A System of Positive Industry, or Treatise on the Action of Humanity on its terrestrial Abode*, for 1861. The first volume of the first of these works was published, according to announcement, in 1856, but before the second was ready Comte died, in 1857. Various

pamphlets had been issued by M. Comte at different periods of his career, in order to give immediate consistency to his views on special points, or to popularize his doctrine. These it is needless to specify. More interesting in themselves, as more important for an appreciation of the man, are the annual circulars issued to those who participated in the subscription for his support.

The System of Positivism, in accordance with what has already been observed, requires to be considered under two distinct, though connected aspects—the scientific theory as originally expounded in M. Comte's earlier work, and the practical application of that theory as presented in his latest complete treatise.

(1.) *The Positive Philosophy*.—This is the development and co-ordination of all the materialistic tendencies of science in the age of the Encyclopædia and the Revolution. It is not itself materialistic, because it proceeds beyond materialism in the same direction, and is attenuated into a pure sensuous phenomenalism. It contemplates merely "the shows of things," and it co-ordinates them according to their concomitances and sequences, recognising no actual bond of connection between them, nor any power on which they depend. The function of philosophy is simply to introduce order and coherence into observed phenomena. Positivism is, accordingly, a habit or intellectual temperament rather than a philosophy, a method rather than a doctrine. Hence the most characteristic peculiarity of this work, as of the whole intellectual evolution of its author, is his arrangement of the sciences, with the principles on which that arrangement proceeds. The treatise becomes, in consequence, an orderly exposition of the sciences and of their reciprocal dependencies, embracing the statement of the results and processes of science, with an indication of deficiencies, excrescences, and aberrations in their present constitution. It is more profound in its execution than in its conception—in its details than in its general spirit. The solitary principle on which the whole elaboration of Positivism reposes is the doctrine of the Three States. To this may be referred Comte's classification of the sciences—his rule for their evolution, composition, and rank—his exposition of their significance and disciplinary value—his history of society, and his theory of humanity. This cardinal position is, that the whole human family, as well as each individual mind, passes through three successive and incompatible conditions: 1. The Theological State, which ascribes all phenomena to divine agency; 2. The Metaphysical State, which questions the divine action, and attributes all changes to influences, entities, occult causes, laws of nature, etc.; and, 3. The Positive State, which accepts the phenomena without reference to their origination, and arranges them under general laws, which merely state "the invariable relations of succession and resemblance." This principle of the Three States has been assailed by both admirers and opponents; but it is rather imperfect and misapplied than false. The succession of these states is explained by the confusion and multiplicity of apparently disconnected facts, which perplex the untutored mind, and suggest the arbitrary will of superior existences. As order reveals itself in the midst of disorder, an arbitrary government of the universe is repudiated, and law maintained by the operation of natural forces is more or less extensively accepted as the solution of the enigma of creation. Thus metaphysics is the crucible in which theology and faith are gradually evaporated. As the regularity of phenomena is more generally apprehended, the jurisdiction of metaphysics is by degrees restricted, and is finally denied. No knowledge is admitted which does not promise to become science, no science which is not phenomenal only, no phenomena which suggest any other principle than uniform harmony and consecution of facts. In the process of speculative disentanglement by

which the Positive habit is attained, those subjects are naturally the first to assume a scientific form which are characterized by the greatest simplicity in themselves, and are, according to the Baconian expression, "least immersed in matter." Hence the relations of number and space are the earliest to exhibit an orderly coherence; and mathematics is not merely the disciplinary introduction to the sciences, but the eldest by birth. Increasing complexity and speciality characterize the sciences as they successively detach themselves from the general mass of unsystematized knowledge. The principle on which the classification of the sciences proceeds is thus from greater to less simplicity, from the more general to the more special, from the more abstract to the more concrete. By the application of this rule M. Comte organizes the whole hierarchy of the sciences. Six only are recognised in the *Politique Positive*: I. Mathematics; II. Astronomy; III. Natural Philosophy, or Physics; IV. Chemistry; V. Biology; VI. Sociology; to which was afterwards added, VII. Morals. Having thus arranged the several sciences, M. Comte proceeds to the exhibition of their functions, their constitution, their conquests, and their condition. He thus furnishes an abstract of all scientific knowledge. This immense elaboration culminates in his creation of the new science of sociology. That science is roughly sketched rather than definitely constituted in the *Philosophie Positive*. It is divided into two parts, Statics and Dynamics. Social Statics treats of the formal conditions of the existence of societies; social Dynamics of society in its vital state of incessant transformation. Having ascertained all that had been accomplished, and all that legitimately sought accomplishment, Comte considered that a solid foundation had been laid for a scientific theory of political action adequate to the regeneration of society.

(2.) *Positive Politics*.—It has been shown how M. Comte was reduced to the necessity of discovering or imagining a God, and of reconstructing a theology, a ceremonial, and a religious organization. The new divinity—*le Nouveau Être Suprême*—is humanity. The units of the living race are separately united by death to this great spirit, and become atomic constituents of the immortal essence. It is a complete deification of man, a complete resolution of divinity into humanity. It is a strange counterpart to Pantheism which is produced in this scheme of thorough-going Panhumanism. The new divinity was to be adored, to be approached with prayer, to be honored with an appropriate ceremonial, worshipped with due rites, and served by a numerous army of priests. Of this priesthood M. Comte was to be the living head. Science and religion were at length reconciled by their union and identification; the priest was the scientific instructor; the priesthood consisted of the consecrated devotees of science; the high-priest was the supreme director of the intellectual, moral, industrial, and social development of society. In the midst of these wild imaginations, it is startling to find a sedate and sober estimation of the whole order of society and of each of its separate parts. The sanctity of the family, the consecration of marriage and its indissolubility, the domestic culture of infancy, the relation and subordination of the sexes, the general inviolability of property, the duties of capital and industry, the distribution and retribution of service—are all maintained in a manner utterly antagonistic to the current doctrines of communism and agrarianism. The most original and instructive part of this treatise is to be found in the consideration of the reciprocal influences of external nature upon man, and of man upon external nature. By this inquiry, brief as it is, the first permanent foundation is laid for a scientific exposition of the transformation of societies.

From the rapidity with which Comte's works were composed, from the absence of all revision, from gen-

eral inattention to the arts of composition and disposition, his treatises are swelled and deformed by continual repetitions and by want of perspicuous arrangement. They are vast and rambling essays rather than systematic expositions of philosophic doctrine. The blemishes which he was careless of avoiding have now ceased to be important. The impulse communicated by Comte remains, but few will ever again dream of reading the ten thick volumes in which his whole vast project was originally set forth. The direct effect of his career has been very slight, its indirect effect very great. He has linked his name with no enlargement of science or philosophy except in sociology—with no practical reform in society. His principles have found of late numerous followers in England, and a small number of them adopt "the religion of humanity" as well as the Positive philosophy. One of the chief of these is Mr. Thomas Congreve, who has taken steps (1867) to found a church, with a building and regular services. Mr. Congreve has announced that a church will shortly be built, and regular services instituted, for promoting the new creed which is to regenerate humanity.

Literature.—All Comte's important works have been enumerated in this notice. For his biography reference may be made to the autobiographical statements scattered through his prefaces, circulars, etc.; to Robinet, *Notice sur l'Œuvre et sur la Vie d'Auguste Comte* (Paris, 1860), and to Littré, *Auguste Comte et la Philosophie Positive* (Paris, 1863). For a fuller account of his philosophy than has been given here, recourse may be had to the last-named work; to Littré, *Conservation, Révolution, et Positivisme* (Paris, 1852); Lewes, *Comte's Philosophy of the Sciences* (Lond. 1858); Harriet Martineau, *The Positive Philosophy of Auguste Comte* (Lond. 1858, 2 vols. 8vo); Lewes, *History of Philosophy* (3d ed. 1867, Lond. 2 vols. 8vo); Céléstin de Blignières, *Exposition Abrégée de la Philosophie et de la Religion Positives* (Paris, 1857); Herbert Spencer, *The Classification of the Sciences, etc.* (New York, 1864); J. S. Mill, *Comte's Philosophy* (Lond. 1866); also to Sir David Brewster's notice of the first two volumes of the Positive Philosophy in the *Edinburgh Review*, July, 1838, and to the Essays on Comte and his Philosophy in the *Methodist Quarterly Review*, New York, January, 1852; April, 1852; July, 1853; October, 1853; and July, 1854; and in the *North British Review*, May, 1854. See also POSITIVISM.

Conani'ah (Heb. in the text *Konanya'hu*, כּוֹנָנְיָהוּ, i. e. *Konanya'hu*, כּוֹנָנְיָהוּ, but as read in the Masoretic margin, *Konanya'hu*, כּוֹנָנְיָהוּ; settled by *Jehovah*; Sept. *Xuvvriac* v. r. *Xuvvriac*, Vulg. *Chomenias*), the name of two chief Levites.

1. A person appointed (with his brother Shimei) as "ruler" (רָדָה) by Hezekiah, to superintend the disposal of the sacred utensils of the Temple (2 Chron. xxxi, 12, 13, where the Auth. Vers. Anglicizes the name "Cononiah"). B. C. 726.

2. A person who, with several of his kindred, made large offerings for the Paschal sacrifices as renewed by Josiah (2 Chron. xxxv, 9). B. C. 628.

Conception of CHRIST. (1.) This was supernatural, by the agency of the Holy Spirit (Luke i, 35; Matt. i, 20). (2.) It was without the communication of original depravity (Heb. vii, 26; iv, 15, etc.). For some of the literature of the subject, see Volbeding, *Index Dissert.* p. 9; Meyer, *Kommentar*, i, 54 sq. See CHRIST, PERSON OF.

Conception of the Virgin Mary. 1. The *Immaculate Conception of the Virgin Mary*, a doctrine of the Church of Rome. See IMMACULATE CONCEPTION. 2. *Monastic Institutions of the Conception of Mary.* (1.) *Order of Knights of the Immaculate Conception of the Blessed Virgin.* In 1617 three Italian noblemen of the family De Pétrignan announced their

intention to establish a military order under the above name, whose object was to be to fight against all infidels and heretics. The plan was not executed, but in 1618 an order under the same name was established in Vienna. According to some writers the first impulse came from one of the brothers De Pétrignan; but the bull by which pope Urban VIII, in 1623, confirmed the order, mentions only Ferdinand, duke of Mantua, Charles, duke of Nevers, and Adolphus, count of Athlun, as founders. The order did not exist long.—Hélyot, *Dict. des Ordres Relig.* i, 1077 sq. (2.) *Nuns of the Immaculate Conception of Mary*, also called Conceptionists. An order under this name was in 1484 founded by Beatrice de Sylva at Toledo, in Spain. It was sanctioned in 1489 by pope Innocent VIII. Cardinal Ximenes united this order with that of the Clarisses, the rule of which they adopted with some modifications. Pope Julius II, in 1511, gave to the Conceptionists a special rule, but they continued to be a part of the order of the Clarisses. (3.) *Congregation of the Immaculate Conception of the Blessed Virgin* was the name of congregations of lay-women which were established in connection with the convents of the congregation of Notre Dame, founded by Peter Fourier (q. v.).

Concha (Gr. κόγχη, a shell), the plain round or polygonal semi-dome that covers the apsis (q. v.) of a church. See CHURCH EDIFICES.

Concilia. See COUNCILS.

Conciliabule, a term applied by Roman writers to synods and councils held by "heretics and schismatics."

Concision (*καταρσίς*, a cutting down, i. e. entire mutilation of the parts), a contemptuous term used by Paul in Phil. iii, 2, to denote the zealots for circumcision. In classical writers the Greek word denotes a groove or channel, etc. (see Liddell and Scott, s. v.), but the apostle parodies the term previously employed, for the purpose of indicating more pointedly the real character of the sectaries in question; instead of saying "beware of the circumcision" (*περιτομή*), namely, the party who pressed the necessity of still observing that ordinance, he says "beware of the concision" (*καταρσίς*); as much as to say they no longer deserve the old and venerable name; what they stickle for is a mere concision, a flesh-cutting. He then goes on to state the reason, "for we are the circumcision"—the reality has now passed over into us, who believe in Christ and are renewed in the spirit of our minds. (See Sommel, *Obes. Philol.* on this passage, Lond. 1798.) Similarly in Gal. v, 12, he says even more pointedly, "I would they [the same class of Judaizing teachers] were even cut off" (*ἀποκόψονταί*, would for themselves cut off wholly the organ circumcised, and not be content with a mere scarification of it), i. e. make themselves outright eunuchs (comp. the allusions to their impurity, ver. 13, 19, 24). So Chrysostom and Jerome explain (*περιτομίσθων*, *abscindantur*). See CIRCUMCISION.

Conclave (Lat. *con*, with, and *clavis*, a key, because from their strict seclusion its inmates as it were *unam habent clavem communem*) is applied (1.) to the apartments in which the cardinals of the Roman Catholic Church meet to elect a new pope; and (2.) to the assembly itself convened for this object. The place of assembling was frequently changed until 1455, from which date to 1823 the conclave was held in the Vatican palace; since 1823 the Quirinal palace has been used for this purpose. When necessary, however, another place, even if without the city of Rome, may be designated. Little chambers, technically called cells, are prepared for the separate accommodation of each cardinal and his attendants, which are assigned by lot, and those falling to the occupancy of cardinals created by the late pope are draped with some purple material as a badge of mourning, while green is used

for the others. The coat of arms of each cardinal is affixed to his cell. When a pope dies, ten days are allowed for the obsequies, for the arrival of absent cardinals, and for the preparations above mentioned for the conclave, together with the selection of persons styled conclavists, who are to enter the conclave as servants of the cardinals (two to each, or, if the cardinal be very old, sickly, or of princely birth, three), masters of ceremonies, confessors, clerks, physicians, carpenters, masons, barbers, and other servants. The prescribed time having elapsed, the cardinals and conclavists attend the mass of the Holy Ghost, formerly in St. Peter's, lately in St. Sylvester's church. The papal ordinances governing the conclaves are read, to the strict observance of which all who are to enter the conclave are sworn. Then the cardinals, with their conclavists, proceed solemnly to the apartments prepared, and repair severally to their cells, where they receive visits until evening from persons not of their number. At the third signal from the bell, about three hours after sunset, all not belonging to the conclave are excluded, and all the entrances except one are walled up, the windows also, except so much as may be necessary for air and light. The excepted entrance is closed by double locks and strictly guarded, admission being allowed to none except the absent cardinals. No egress is allowed except by permission of the conclave itself in case of grave illness. The theory is that all communication between those within and persons without in regard to the pending election must be prevented; but these precautions have not always secured their end. In spite of the law, there is frequent correspondence between the cardinals within and their political friends without. The decree of Gregory X prescribed that, if a choice was not made by the cardinals within three days, for the next five days only one dish at noon and evening should be allowed to each, and after that time only bread, wine, and water; but this rigid regimen was modified somewhat by Clement VI (1361). The execution of these regulations is intrusted externally to the civil authorities of the place where the conclave is held, and internally to the officers appointed by the conclave.

Prior to the latter half of the 11th century, the choice of the bishop of Rome was the joint prerogative of the clergy and people, exercised, we may suppose, at first directly, though subsequently the popular participation in the election appears to have been through some representative body; while the supreme secular power asserted its authority by requiring that the election should receive its sanction, the origin, doubtless, of the right exercised by certain Catholic governments (France, Spain, and Austria), and claimed by Italy (Naples) and Portugal, of each excluding from the papal throne some particular cardinal, a right, however, to be exercised before an election, and limited to one veto at each conclave. By a decree of Pope Nicholas II (*In nomine Domini*), 1059, the election of pontiff was given to the cardinal bishops, the other cardinals, and the clergy, the people merely approving it. By a further decree of Alexander III (1179), the choice was vested exclusively in the college of cardinals, with the proviso that the concurrence of two thirds of the cardinals present should constitute a legal election, the assent of clergy and people being no longer required. The Council of Lyons (1274), under the auspices of Gregory X, promulgated a constitution minutely prescribing the forms to be observed in regard to such elections, which were to be made in *conclavi clauso*, so as to shut out secular influence. These three instruments furnish the organic laws and regulations, both of franchise and ceremonials, which, without fundamental change, are still in force in papal elections.

It is laid down as a settled principle that no pope can appoint his successor, and that every cardinal,

however recently made such, provided he has taken deacon's orders, may participate in a conclave, though under papal censure, suspension, interdict, or excommunication.

According to the bulls of Gregory XV (*Æterni Patris Filius* and *Decret Romanum Pontificum*), confirmed by that of Urban VIII (*ad Romani Pontificis provisionem*), the choice must be made in one of three ways, viz., by inspiration, compromise, or ballot. Election by inspiration is when all the electors spontaneously (*per quasi inspirationem*), without any previous concert, proclaim the same person for the office. Examples of such elections are given by early ecclesiastical writers, as that of Fabianus (Euseb. *Hist. Eccles.* vi, 29), but in modern times none such has occurred. Election by compromise is when, in default of agreement themselves, the cardinals delegate to a select number of their body, with or without conditions, authority to choose a pope, as was the case in the election of Clement V. The ordinary way, however, is by ballot. In this method, after the usual morning mass, each cardinal (when the conclave is assembled in the balloting-room or chapel), invoking Christ as witness to the purity of his intentions in the vote, deposits in the chalice on the altar a square paper, folded at opposite corners so as to conceal the voter's name and motto (which, once selected, must be adhered to), while the name of the person voted for is written on the open central space. These ballots are then examined in turn by three cardinals, appointed *scrutatores*, and the numbers taken, which must agree with that of the cardinals present, all being required to vote, and are filed to await the result. If any one has received just two thirds, the folded ends are opened to see that he has not voted for himself, which is not allowable. If no one has attained the required majority, the conclave proceeds in the afternoon session, after the hymn *Veni Creator Spiritus*, to try the process called *accensus* (*accessus*), in which each cardinal may give a supplementary vote, in the words *accedo domino cardinali*, to any one who received votes in the first process from others than the accedent; those declining to change the morning's choice write *secessi*. If the supplementary votes for any, added to the morning's votes for the same, do not make up the two thirds majority, the papers are burned, and the same process of balloting is repeated the next day. When the requisite majority is given, the papers are examined to see that no cardinal has voted twice for the same person, and that the mottoes of the evening and morning vote tally; then the recipient of the highest vote equalling or exceeding two thirds is declared duly elected. On his acceptance the work of the conclave strictly ends, for the newly elected is deemed to be legally pope, with all his prerogatives and powers; he is invested with the pontifical robes, receives the homage of the cardinals, adopts his official name, and is proclaimed from a reopened balcony window to the people by the cardinal dean, in the words *Ananias vobis gaudium magnum. Papam habemus Eminensissimum ac Reverendissimum —, qui sibi imponit nomen —*, and the shouts of the people are recorded as their assent, still, in theory, necessary to an election. The other ceremonies belonging to the inauguration follow in due order.—Ferraris, *Bibliotheca Canonica*, etc., art. Papa; Herzog, *Real-Encyclopædie*, art. Papstwahl; Ranke, *History of the Papacy* (see Index); *North British Review*, Dec. 1866, art. Conclaves; Petrucciello della Gattina, *Historia Diplomatica des Conclaves* (Paris, 1865, 2 vols. 8vo); Cartwright, *Papal Conclaves* (Lond. 1867). See CARDINALS; POPE.

Concomitant. (1.) A term used by Roman theologians to denote the grace of God *accompanying* an action, as distinguished from *prevenient* grace, which (against the Pelagians) is necessary to excite to good desires and actions (Berger). (2.) *Concomitance*, in the Roman doctrine of the Lord's Supper (q. v.), means

the "accompanying of the body of Christ by the blood, and of the blood by the body," in the Eucharist. Aquinas introduced the term (*concomitantia*). The withholding of the cup from the laity is justified by this Romanist doctrine of concomitance on the ground that as Christ is present entirely in each of the elements, he is received fully in either by the communicant. Of course this theory goes along with transubstantiation. — Burnet, *On the Articles*, art. xxxi; Smith's Hagenbach, *History of Doctrines*, § 195. See LORD'S SUPPER.

CONCORD, FORMULA OF (FORMULA CONCORDIÆ), the seventh and last symbolical book of the Lutheran Church, first publicly adopted in 1580. It was framed in consequence of the long disputes between the stricter Lutherans and the milder Philippists and the Crypto-Calvinists in Germany. The principal theologians and evangelists considered it their duty to unite the Church as much as possible by clearly defining its fundamental doctrines in accordance with the principles of the Augsburg Confession of 1530. In 1574, duke Julius of Brunswick and the elector Augustus of Saxony commissioned professor Jacob Andrea (q. v.), of Tübingen, to frame a suitable formula. His work underwent divers alterations in the hands of Chemnitz and Chytræus, and was finally received as the confession of Swabia and Saxony. Subsequently, by the influence of prince George Ernest of Henneberg, a second formula of concord was framed by Osiander and Bidenbach, theologians of Württemberg, and revised and completed by a body of theologians in the convent of Maulbronn in January, 1576 (known as the formula of Maulbronn). Andrea considered this latter as too short, the former as too diffuse, and undertook to base a third on these two. For this purpose the elector, in May, 1576, called a meeting of theologians at Torgau. Among the eighteen who answered to the call were Andrea, Chemnitz, Chytræus, Selnecker, Cornerus, Musculus, Crell, and Mörlin. Between them, and based on the two preceding formulas and the Augsburg Confession, they framed the *Book of Torgau* (published by Semler, Halle, 1760), which was submitted to the elector and his council on the 7th of June, and by him sent to the other evangelical princes and states, to be approved or altered according to their suggestions. After many additions had been made to it, the elector required Chemnitz, Andrea, and Selnecker to remodel it. This was done in March, 1577, in the convent of Bergen, near Magdeburg. In order to embody the different additions made to the primitive production (*Solida declaratio*), they made a small supplement (*Epitome*). At a second session in April they adopted a new redaction; and in a third, in May, where they were assisted by Musculus, Cornerus, and Chytræus, they perfected the final version, which was then handed to the elector. The latter named it *Formula Concordiæ*, and with the elector of Brandenburg called on the theologians of their states to sign it. It was then joined with the other received symbols in a *Corpus doctrinæ*, and this *Book of Concord* was officially recognised at Dresden, June 25th, 1580, as the fundamental symbol of the Lutheran Church.

It is divided into two parts: 1. The *Epitome*, or summary, consisting of eleven articles, each headed by the enunciation of some controverted point of doctrine (*status controversiæ*), which is then followed by the orthodox doctrine (*pars affirmativa*), and finally by the condemnation of the opposite view (*pars negativa*). 2. The *Solida declaratio*, or fundamental exposition, which treats of the same articles in connection with each other. The eleven articles, taken in the order of the Augsburg Confession, are, on 1. Original Sin (human nature by original sin has become utterly depraved [*in universum corrupta*]); 2. Free-will; 3. Justification by Faith; 4. Good Works; 5. The Law and the Gospel; 6. The third Use of the Law; 7.

The Lord's Supper (the body and blood of Christ is really and substantially [*vere et substantialiter*] present: there is a sacramental union between bread and wine and the body and blood of Christ, and consequently an oral [*ore*] reception of the body and blood of Christ, in a supernatural and heavenly manner, so that also the unworthy and the unbelievers receive the real body and blood of Christ, though to their condemnation); 8. The Person of Christ; 9. The Descent of Christ into Hell; 10. The Customs of the Church; 11. Predestination and Election (the foreknowledge of God [*præscientia*] relates to all men, the predestination only to the good). To these is joined an appendix concerning heresies and sectaries (i. e. all who had not accepted the Augsburg Confession). The appended testimony of the witnesses of the Holy Scriptures, and of the pure doctrines of the original Church, on the person and work of Christ (*Communiatio idiomatum*), by Andrea and Chemnitz, in eight articles, is not considered as part of the creed.

As to Anthropology, the Formula Concordiæ carries out the doctrines of the Augsburg Confession with regard to original sin to their logical results, and after distinctly rejecting the view of Flacius, which made original sin to be the substance of the human soul's agency, and not the soul's essence, the Formula Concordiæ affirms that "Christians ought not only to acknowledge and define actual faults and transgressions of the commands of God to be sins, but they ought also to regard that hereditary disease (*morbus*), by which the whole nature of man is corrupted, as a specially dreadful sin, and, indeed, as the first principle and source of all other sins, from which all other transgressions spring as from their root." The first position in the statement of the doctrine of original sin, according to the Formula Concordiæ, is that "this hereditary evil is guilt (*culpa*) or crime (*reatus*); whence it results that all men, on account of the disobedience of Adam and Eve, are odious in the sight of God, and are by nature the children of wrath, as the apostle testifies" (Hase, *Libri Symbolici*, p. 639, 640; Shedd, ii, 155).

The Formula "is the only Lutheran symbol in which the distinction between the active and passive righteousness of Christ appears." Its statement is as follows: "That righteousness which is imputed to faith, or to the believer, of mere grace, is the *obedience*, suffering, and resurrection of Christ, by which he satisfied the law for us and expiated our sins. For since Christ was not only man, but truly God and man in one undivided person, he was no more subject to the law than he was to suffering and death [i. e. if his Person merely be taken into account, without any reference to his vicarious relations], because he was the divine and eternal Lord of the law. Hence not only that obedience to God his Father which he exhibited in his passion and death, but also that *obedience which he exhibited in voluntarily subjecting himself to the law, and fulfilling it for our sakes*, is imputed to us for righteousness, so that God, on account of the total obedience which Christ accomplished (*prostitit*) for our sake before his heavenly Father, both in acting and in suffering, in life and in death, may remit our sins to us, regard us as *holy and righteous, and give us eternal felicity*" (Hase, *Libri Symbolici*, p. 68; Shedd, *Hist. of Doctrines*, ii, 342). As to the work of regeneration, it teaches that "before man is illuminated, converted, regenerated, and drawn by the Holy Spirit, he can no more operate, co-operate, or even make a beginning towards his conversion or regeneration, with his own natural powers, than can a stone, a tree, or a piece of clay" (Hase, *Libri Symbolici*, p. 622; Shedd, ii, 366). For a full discussion of the Christology of the Formula, see Dorner, *History of the Doctrine of the Person of Christ*, div. ii, vol. ii, 209 sq.

The Formula was originally framed in German; the Latin translation by Osiander was adopted by Sel-

necesser in his first Latin edition of the Book of Concord; but the latter afterwards made another translation of it, which, after being revised in the convent of Quedlinburg in 1583, was inserted in the new edition of the Book of Concord in 1584. The signatures of the princes who endorsed it were placed after the preface, which was prepared at Jüterbock in 1579; those of 8000 ministers (put in A.D. 1582) follow immediately after the text. The Formula was for a long time rejected by Denmark and Sweden; in the former country its publication was, until 1580, forbidden under penalty of death. It was received in Hungary (1598-1596), Holstein (1647), Pomerania (1685), and Livonia. It was rejected in Hesse, Anhalt, a part of Mecklenburg, and the free cities of Frankfurt on the Main, Spire, Worms, Strasburg, Nuremberg, Magdeburg, Bremen, Dantzic, etc.; the electors of the Palatinate (in 1583), and Brandenburg (1614), and the Duke Julius of Brunswick, who had previously accepted it, retracted afterwards. Thus, of the three Protestant electors of the German empire, Palatinate, Brandenburg, and Saxony, only one (Saxony) remained a champion of the Formula of Concord, and he subsequently joined the Church of Rome. The Formula of Concord, united with the Augsburg Confession of 1550, the Apology, the Articles of Smalcald, and the two catechisms of Luther, forms the "Concordienbuch," or the Book of Concord, of which there are many editions in German and Latin. "But the Lutheran Church is still divided upon this symbol. The so-called High Lutherans insist that the Formula Concordiæ is the scientific completion of the preceding Lutheran symbolism, while the moderate party are content to stand by the Augsburg Confession, the Apology, and the Smalcald Articles" (Shedd, *Hist. of Doctrines*, ii, 458). See CONFESIONS OF FAITH; SYMBOLICAL BOOKS; LUTHERANS.

See Hospinian, *Concordia discors* (Zurich, 1607; Gen. 1678); Leonhard Hutter, *Concordia concors* (Wittenb. 1614, 1621; Lpz. 1690); J. Musæus, *Prolectiones in epitomen Formula conc.* (Jena, 1701); Balthasar, *Hist. d. Torgischen Buches* (Greifsw. 1741-56, 8 vols.); J. N. Anton, *Geach. d. Form. conc.* (Lpz. 1779, 2 vols.); Francke, *Lib. Symbol.* pt. iii; Moseheim, *Ch. Hist.* 158-165; Herzog, *Real-Encyclopædie*, iii, 87 sq.; Franck, *Theologie der Concordienformel* (Erlang. 1865, 4 vols.).

Concordance (Lat. *concordantia*), a book containing the words in the Holy Scriptures, in alphabetical order, with their context more or less fully given, and a designation by chapter and verse of the places in which they are to be found. (See Glauchius, *De usu Concordantiarum Bibliocarum*, Lips. 1668.) While the Scriptures remained in manuscript, or were not divided into sections and paragraphs, indexes of their words and phrases could neither be formed nor used. As soon as any regular divisions began to be made, the importance of concordances, or alphabetical indexes, was felt, and learned men devoted their labors to form them. The first concordances were prepared for the Latin Vulgate. (See below.) See Orme's *Bibliotheca Biblica*, p. 112; Watts's *Bibliotheca Britannica*; Winer's *Handbuch*; Walch, *Biblioth. Theol.* iv, 807; Röhr's *Kritische Prediger-Bibliothek*, 1841; *Met. Quar. Review*, 1847, p. 451; *Princeton Review*, 1828, p. 471. The following are the most important works of this description.

I. *Hebrew*.—1. The first Hebrew concordance was by Rabbi Isaac (or Mordecai) Nathan (q. v.), in 1445. It cost seven years' hard labor by himself and some assistants. It was first printed at Venice in 1524, fol., by Dan. Bomberg, then by Franzoni (ib. 1564, fol.), again by Pesaro (Basle, 1581, fol.), and afterwards at Rome in 1622. It is entirely Hebrew, and entitled *Meir Nathib* (מֵיר נָתִיב), "The Light of the Way." It was translated into Latin by A. Reuchlin (Basil. 1556, fol., 1569, 4to), but both the Hebrew and the Latin editions are full of errors.

2. These errors were for the most part corrected and other deficiencies supplied by Mario di Calasio (q. v.), a Franciscan friar, who published *Concordantia Sac. Bibl. Hebr. et Latin.* (Rome, 1621, 4 vols. fol.), republished in London under the direction of W. Romains (1747-9, 4 vols. fol.), under the patronage of all the monarchs in Europe, not excepting the pope himself.

3. *Concordantia Bibl. Ebraica, nova et artificiosa methodo disposita* (Basil. 1632, fol.), by John Buxtorf, the father, but published by his son. It takes for its basis the work of Rabbi Nathan, though it is much better arranged, more correctly printed, the roots more distinctly ascertained, and the meanings more accurately given; but as the references are made by Hebrew letters, and relate to the rabbinical divisions of the Old Testament, it is of little service, unless the student is familiar with the Masoretic system. This work was abridged under the title of *Fons Leonis*, etc. (Berolini, 1677, 8vo). A new edition of Buxtorf's Heb. Concordance, by Bär, has lately been published (Stettini, 1861 sq., 4to).

4. Before the republication of Calasio there appeared Chr. Nolde's (q. v.) *Concr. particularum Ebraeo-Chaldaicarum* (Hafn. 1679, 4to: an edition seems to have been begun in 1675, fol., but this never saw the light). This concordance contains the particles, or indeclinable words, omitted in former (as well as later) concordances. The best edition of Nolde is that by Tympe (Jena, 1784, 4to). It contains, as an appendix, a Lexicon of the Hebrew Particles, by John Henry Michaelis and Christ. Kerber.

5. But the best, or at least to the English reader most important work up to the present century on this subject is *The Hebrew Concordance, adapted to the English Bible, disposed after the manner of Buxtorf*, by John Taylor, D.D. (London, 1764, 2 vols. fol.). It was the fruit of many years' labor, and still has its value.

6. An edition of Buxtorf's *Hebrew Concordance*, which has received so much care and attention on the part of the editor as nearly to deserve the name of a new work—*Hebräische und Chaldäische Concordanz zu den heiligen Schriften des alten Testaments*, by Dr. Julius Fürst (Leipzig, 1840, fol.), offers one of the most useful aids to the study of the Bible that has ever appeared. In addition to those of a more mechanical kind, such as a good type and clear arrangement, there are, 1. A corrected text, founded on Hahn's *Vanderhooght*; 2. The Rabbinical significations; 3. Explanations in Latin, giving the etymology of the Rabbinical; illustrations from the three Greek versions, the Aramaic Paraphrase, the Vulgate, etc.; the Greek words employed by the Seventy as renderings of the Hebrew; together with philological and archaeological notices, so as to make the Concordance contain a brief Hebrew lexicon.

7. *The Englishman's Hebrew and Chaldean Concordance*, edited by G. V. Wigram (Lond. 1848, 2 vols. 8vo), is an original and exceedingly useful work, and remarkably accurate. It gives the Hebrew words in their order, but quotes the passages in which they occur from the common English Bible. It contains the first complete list of the Heb. proper names ever made. It deserves to be more extensively known and used. Its high price is a serious check to its circulation.

8. Aaron Pick, *The Bible Student's Concordance* (Lond. 1848, 8vo), a work of little account to scholars.

9. W. Wilson, *The Bible Student's Hebrew Guide* (Lond. 1850, 4to), equally brief and insufficient.

Other and earlier Heb. Concordances are: Rabbi Anshel, *אנשׁל וְהַשְׁמֵרָה* (a vocabulary, with references to passages, Cracow, 1584, 4to, and later); Crispius, *Concordantia Ebraica* (Vitemb. 1627, 4to); Layman, *Concordantia Ebraeo-sacra*, etc. (1681, fol.); Trostius, *Concordantia Chaldaica* (Vitemb. 1617, 4to).

II. *Greek Concordances*.—(a) *To the Septuagint*.—1. Conrad Kircher, *Concordantia Veteris Testamenti Gra-*

cas Ebraicis vocibus respondentes (Francof. 1607, 2 vols. 4to). This work follows the order of the Hebrew words, placing the corresponding Greek word after it; in consequence of which, it is more useful in consulting the Hebrew than the Greek Scriptures.

2. The best Greek Concordance to the Septuagint is that which bears the title A. Trommii *Concordantia Græcæ Vers. vulgo dic. LXX Interpret.* (Amst. et Traj. ad Rh. 1718, 2 vols. fol.). See TROMMIE. It follows the order of the Greek words, of which it first gives a Latin translation, and then the Hebrew word or words for which the Greek term is used in the Seventy. Then the different places in which the words occur follow in the order of the several books and chapters. When the word occurs in any of the Greek translators, Aquila, Symmachus, or Theodotion, the places where it is found are referred to at the end of the quotations from the Sept. The words of the Apocrypha are placed at the end of each enumeration. There are two indices at the end of the work: one Hebrew and Chaldaic, by examining which the Greek term used in the Septuagint for any Hebrew or Chaldaic word is seen at once, with the Latin version and the place where it is found in the concordance, so that Tromme serves in a measure for a Hebrew concordance; the other index contains a lexicon to the Hexapla of Origen, and comprehends the Greek words in the fragments of the old Greek translators published by Montfaucou.

(b) *To the New Testament.*—1. The first Greek concordance to the New Testament, now exceedingly rare, is entitled Xysti Betuleii *Concordantia Græcæ Novi Testamenti* (Basil. 1546, fol.). The author's real name was Birch.

2. A concordance to the Greek New Testament, projected and partly executed by Robert Stephens, and completed and published by his son Henry (Genev. 1594, and with a supplement, 1600, fol.), is too inaccurate to merit more than a passing notice.

3. Of much value is Erasmus Schmidii *Novi Testamenti J. C. Græci; hoc est, originalis linguae rapuiov* (Vitemb. 1638, fol.; revised ed. Gotha, 1717, fol.; also Glasg. 1819, 2 vols. 8vo; recently by the Messrs. Bagster of London, in a thin, flat pocket volume, and in another form, 32mo, being one of their "Polymicrion series").

4. J. Williams, *Concordance to the Greek Testament* (Lond. 1767, 4to), a work especially useful to the mere English reader.

5. A new and very superior edition of Schmid's *rapuiov* has been put forth by C. H. Bruder, *Concordantia* (Leipz. 1842, 4to). Among the advantages of this edition, let it suffice to specify, 1. Fulness, accuracy, and correspondence with Griesbach's edition; 2. Regard has been paid to the editions of Lachmann and Scholz; all the readings of the Elzevirs, Mill, Bengel, Knapp, Tittmann, Scholz, and also of Erasmus, Robert Stephens's third edition, and of Schmid himself, are either given or pointed out. The student is presented also with a selection of readings from the most ancient MSS., from the interpreters of Scripture who lived in the earlier ages of the Church, and the works of the ecclesiastical fathers: no various reading possessing critical value is omitted.

6. One of the most valuable aids for the general study of the New Testament which modern times have produced is *The Englishman's Greek Concordance of the New Testament*, being an attempt at a Verbal Connection between the Greek and the English Texts (Lond. 1839, 8vo). The work, which is carefully compiled, takes Schmid as its basis. The plan is the same as that of the "Englishman's Hebrew Concordance" above, and it is by the same editor. It has been republished in this country (N. Y. 1848, 8vo).

III. *Latin Concordances.*—1. Antony of Padua (born A.D. 1195, died 1231) is said to have produced the first work of the kind, entitled *Concordantia Morales*, which was formed from the Vulgate translation.

2. Hugo de Santo Caro, better known as Cardinal Hugo, a Dominican monk, who died about 1262, followed Antony in 1244, by compiling for the Vulgate a concordance of the Scriptures. Having given himself sedulously to the study of Holy Writ, with a view of writing a commentary thereon, he was, in order to facilitate his labor, led to project and undertake to form a concordance, calling to his aid his brother monks to the number of no fewer than five hundred. Their labors have been a rich storehouse for subsequent compilers. The concordance thus made was improved by Conrad of Halberstadt, who flourished about 1290, and by John of Segovia in the ensuing century.

3. R. Stephens, *Concordantia Bibliorum utriusque Testamenti* (1555, fol.).

4. After the revision of the Vulgate by Sixtus V, a concordance to it appeared, entitled *Concordantia Sacr. Bibl. Vulgat.* edit. F. Lucæ Brugensis (Antw. 1617; Paris, 1688). Most of the Latin concordances are reprints of this, e. g. by Luca and Phalesti (Vien. 1825, fol.).

5. A new Latin Concordance to the Vulgate, edited by Ducrison, appeared in Paris in 1838 (4to).

IV. *German Concordances.*—The first German concordance was that of *Conrad Agricola* (Nurnb. 1609, fol.), repeatedly reprinted and revised.

2. The most useful is that of F. Lankisch, *Concordant. Bibl. Germanico-Hebraico-Græca* (Lips. 1677, fol., often reprinted; best edition that of Reinneccius, Lips. 1718). There are several modern German concordances, the most noteworthy of which is

3. J. G. Hanff, *Biblische Real- und Verbal-Concordanz* (2 vols. in 4 pts. 8vo, Stuttg. 1828-34).

4. We may also mention a valuable concordance for the German Bible—*Biblische Hand-Concordanz für Regimentslehrer und alle Freunde der Heiligen Schrift* (pub. by H. Schott, Leipzig, 1827, 8vo). The work is more comprehensive than similar writings in the English language. It is divided into three parts: (1.) A full and complete register of all the words found in the Bible; (2.) An index of the most important things, subjects, and ideas found in the Bible, with references to the places where they lie in the sacred volume; as, for instance, under the head "Lord's Supper, a meal commemorative of the death of Jesus, it brings us into intimate fellowship with Christ; the worthy participation of the same; spiritual enjoyment of the flesh and blood of Christ," etc. (3.) The leading doctrines of Christianity systematically arranged, drawn up according to Luther's *Catechism*, and accompanied by scriptural proofs.

Other concordances in German are those of G. Böhner (Jena, 1750, 1757, 1776; Halle, 1837; Lpz. 1806), Wichmann (Lpz. 1782), F. J. Bernhard (Lpz. 1850-2), J. M. Otto (Sulzb. 1842), K. A. Toller (Stuttg. 1838), S. Lueg (Passau, 1841).

IV. The first complete *French* concordance was that of Mark Wilks, *Concordance des Saintes-Ecritures* (Paris, 1840, 8vo).

V. *English Concordances.*—1. The first concordance to the English version of the New Testament was published without date, but certainly before 1540, by "Mr. Thomas Gybson," being chiefly, as appears probable from the prefatory epistle to the reader, the work of the famous printer John Day. It is entitled *The Concordance of the New Testament, most necessary to be had in the hands of all such as desire the communication of any place contained in the New Testament.*

2. The first English concordance to the entire Bible was that of John Marbeck—*A Concordance, that is to say, a Worke wherein by the order of the letters of the A, B, C, ye may redely find any worde contayned in the whole Bible, so often as it is there expressed or mentioned*, Lond. 1550, fol. Till the year 1555, when Robert Stephens published his concordance, it was not customary to mark the verses in books of this sort. At

first it was thought sufficient to specify the chapter with the letters a, b, c, d, as marks to point out the beginning, middle, and end of each chapter. But in 1545 Robert Stephens divided the Bible into verses, thus preparing the way for a more exact reference in concordances, etc.; but Marbeck does not appear to have made use of this improvement, as his work refers merely to the chapters. In Townley's *Bib. Lit.* vol. iii, p. 118, may be found some interesting particulars respecting Marbeck's condition in life, labors, and ill treatment.

3. The following work, which appeared in the same year as the last, is a translation from the German—*A Briefe and a Compendious Table, in manner of a Concordance, opening the waye to the principall Histories of the whole Bible, and the most comon articles groundend and comprehended in the Newe Testament and Olde, in manner as amply as doeth the great Concordance of the Bible. Gathered and set forth by Henry Bullinger, Leo Jude, Conrade Pellicone, and by the other ministers of the Church of Liguria. Translated from the Hygh Almayne into English by Walter Lynne. To which is added, a Translation of the Third Boke of Machabees* (8vo, 1550). Lynne, the translator, was an English printer, who flourished about the middle of the 16th century, a scholar, author, and translator of several books. See BULLINGER.

4. All earlier English concordances were superseded by the more correct and valuable work of Alexander Cruden (q. v.), entitled *A Complete Concordance to the Holy Scriptures of the Old and New Testament, etc., to which is added a Concordance to the books called Apocrypha* (1787, 4to). Three editions were published by the author during his life, and many have appeared since his death. The London edition of 1810 is the best standard edition. Several useful editions of Cruden have been put forth by the Messrs. Bagster, who have also issued *An Alphabetical Index of the Holy Scriptures, comprising the Names, Characters, and Subjects, both of the Old and New Testament*, in two sizes, which the Biblical student will find very serviceable.

Cruden's Concordance has been for a century the basis of every other work of the kind, such as Brown's, Butterworth's, Coles's, Eadie's, etc. With all its excellences, however, it has more serious defects than is generally apprehended. The Rev. Thomas Scott was so well aware of this that he contemplated a revision of the work. Its chief fault is its great want of completeness, but a moiety of the words being really given at all, and only a part of the occurrences of these, the proper names being especially defective. These and other defects are in a good measure remedied in the edition issued by the "Society for Promoting Christian Knowledge" (Lond. 1859, 8vo), but this still is far from perfect. A really complete and accurate English concordance is yet a desideratum. The want is about to be met by Strong's *Exhaustive Concordance to the Auth. Engl. Version of the Holy Scriptures*, lately announced as nearly ready for the press.

Concordat. I. A treaty, but usually restricted to a convention between the pope of Rome and any secular Roman Catholic government for the settling of ecclesiastical relations. Treaties which the pope, as a secular sovereign, concludes with other princes, are not called concordats. Conventions between the pope and a Protestant government for the settlement of the ecclesiastical relations of the Roman Catholic subjects of the latter are properly only called *concessions*, though it is common to apply the term concordat to any convention. The name concordat was for the first time applied to the convention made in 1418 between Pope Martin V and the representatives of the German nation, which was called *Nullum capitula concordata et ab utraque parte suscepta*. The name is now, however, generally applied to earlier conventions also. One of the most important of the earlier concordats is that of Worms, called also the Calixtine Concordat, made in

1122 between Calixtus II and Henry V, in order to put an end to the long contest on the subject of investiture, and which has since been considered a fundamental ordinance in Germany. Most of the concordats have been extorted from the popes by the different civil powers. This was done as early as the fifteenth century; for when the Council of Constance urged a reformation of the papal court, Martin V saw himself obliged, in 1418, to conclude the concordats of *Constance* with the German, the French, and the English nations. Chap. 1 restricts the number of cardinals, and makes provisions as to their character and mode of appointment. Chap. 2 restricts the papal reservations. Chap. 3 treats of papal annates and taxes, which for France were reduced for the space of five years to one half of their former amount; while in the English concordat these were abolished altogether. Chap. 4 defines what trials are to be lodged at Rome. Chap. 5 reduces the number of commendams. Chap. 6 enjoins a strict proceeding against simony before the *forum conscientie*. Chap. 7 provides that excommunicated persons need not be shunned before the publication of the ban. Chap. 8 reduces the number of papal dispensations. Chap. 9 treats of the revenue of the papal curia. Chap. 10 reduces for Germany the papal indulgences, and repeals those that had been issued since the death of Gregory XI: in the French concordat nothing is said about this point. Chap. 11 provides that the German and French concordats are to be valid only for five years, and that with regard to the French the royal sanction is reserved. The English concordat is definite. The German and English concordats obtained at once legal authority; the French in 1424.

At a meeting of the German electors at Frankfurt, in October, 1446, the reformatory demands of the German nations, which for several years had been the subject of negotiations, were finally agreed upon. They chiefly concerned the recognition of the supreme authority of general councils, the convocation of a new general council, and the redress of the grievances of the German nation. Pope Eugene IV, through his ambassadors, declared his readiness to concede these demands, and on his death-bed, Feb., 1447, signed five bulls by which they were severally granted. The Frankfurt demands, and the bulls of Eugene IV, by which they are ratified, are together called the *Frankfurt Concordats*, or the *Concordat of Princes*. The chief basis of these concordats was the series of reformatory decrees which had been adopted by the Council of Basle. Nicholas V, on March 28, 1447, ratified the concessions made by his predecessor to the German nation.

On Feb. 17, 1448, the Emperor Frederick III concluded (without the co-operation of the electors) with the cardinal legate Carvajal a concordat at Vienna, which made to the pope far-reaching concessions; in particular, the right of ratifying the election of all the bishops (which right, by the Concordat of Princes, had been restricted to the bishops immediately subject to the pope), of cancelling uncanonical elections, and of appointing bishops for the dioceses thus become vacant. This convention was formerly called the *Ashaffenburg Concordat* or *Recess*, but the more correct name is the *Vienna Concordat*. The Frankfurt Concordats and the Vienna Concordat together are called the *Concordats of the German Nation*. They formed a fundamental law of the German Empire, and part of them continued, even after the destruction of the German Empire, to be a part of the ecclesiastical law of the several German countries.

In France, the reformatory decrees of the Council of Basle had been, in 1488, adopted as a law of the kingdom at the Diet of Bourges. But this law—the *Pragmatic Sanction of Bourges*—was never recognised by any of the popes of the 15th century; and in 1516, Pope Leo X prevailed upon king Francis I to conclude a new concordat, which the Lateran Council, then in

session, approved and embodied with its decree, while the king made it a law of the country, notwithstanding the protest of the Parliament and the University of Paris. It established the annates, referred the *causes majores* for adjudication to Rome, and gives to the king the right of nominating the bishops.

In 1451 a concordat was concluded with the duke of Savoy, by which the latter received the right of nominating for the most important benefices. In 1486 king John II of Portugal concluded a concordat with Pope Innocent VIII, by which he abandoned the *Placet Regium*, which the kings had exercised since the beginning of the century, though, since 1427, the popes had protested against it. The concordat was disapproved by the Cortes. In 1528 Pope Adrian II gave to the kings of Spain the same right as regards the nominating for ecclesiastical benefices which had been conceded to France. No concordat was concluded during the 16th century after the year 1528, and none at all during the 17th century.

II. *The Concordats of the Eighteenth Century.*—The concordats of this period (1717–1774) were occasioned by the revival of the anti-papal tendencies of the Church of Rome, which had prevailed in the 16th century, and still more by the development of the theory of the absolute state. They all belong to the Latin nations of Europe.

1. *Savoy.*—The arrangement of 1451 had been the subject of long controversies, which were partly settled by an agreement in 1727, and fully by a concordat on Jan. 6, 1741, which made provisions on the admission and authority of papal bulls in the country, on the limits of ecclesiastical jurisdiction, on the exemption of church property, on the right of asylum, etc.

2. *For Milan*, which, since 1706, belonged to Austria, a concordat was concluded Dec. 10, 1757, concerning exclusively the exemption of church property.

3. In *Naples* the so-called *Monarchia Sicula*, or the right claimed by kings to act as papal legates, had long been a hereditary subject of controversy between the secular governments and the popes. It was finally regulated, together with other differences, by a treaty concluded June 2, 1741, which recognised, though in somewhat modified form, the exemption of church property and of the clergy from taxation, the right of asylum, ecclesiastical jurisdiction in marriage affairs, and the right of the Church to superintend the importation of foreign books.

4. *Spain.*—The conflicts between Spain and the pope concerning the extent of the royal right of collation were settled by a preliminary agreement in 1757, and by a concordat concluded Jan. 11, 1758. An appendix to the concordat concerning the rights of the papal nuncio in Madrid was agreed upon.

5. *Portugal.*—In 1740 Benedict XIV granted to the kings of Portugal, by a concordat, the right of nominating for the episcopal sees and all benefices.

III. *The Concordats of the Nineteenth Century.*—The present century has witnessed the conclusion of a very large number of concordats. Most of them were called forth by a desire of the secular government to rearrange ecclesiastical affairs, which had been thrown into utter disorder by the French Revolution and the territorial changes in Europe following it.

1. *France.*—Bonaparte, when first consul, concluded a concordat with Pius VII, July 15, 1801, which went into operation in April, 1802. It re-established the Roman Catholic Church, which is declared to be the religion of the majority of Frenchmen, and has become the basis of the present ecclesiastical constitution of that country. It guaranteed to the Roman Catholic Church freedom and publicity of worship, which was, however, placed under the general laws of police; promised a new circumscription of dioceses, and provided for the resignation of all the bishops at that time in office; it gave to the first consul the right of nominating the bishops, and prescribed the oath of fidel-

ity toward the secular government which the bishops and other priests have to take. The bishops received the right to appoint the parish priests, but the latter must be agreeable to the secular government. Of the churches not yet sold, as many as were necessary for divine worship were to be restored to the bishops. The Church renounced all claims to the property that had been sold during the Revolution, and the state promised to pay the bishops and priests a sufficient salary. The former rights and prerogatives of the French crown were recognised as having been transferred to the first consul, but in case a person not a member of the Church of Rome should be invested with the latter office, new provisions were reserved. The concordat was published as a law of France in 1802, together with some introductory "organic articles." Against the latter, however, the popes always protested. The concordat and the new circumscription of dioceses were also valid for Belgium, and those parts of Germany (the left bank of the Rhine), Switzerland, and Savoy which, by the treaties of peace at Lunéville and Amiens, had been united with France.

In 1808 a special concordat was concluded between Pius VII and Napoleon for the Italian republic. It substantially agrees with the French concordat, though some provisions are more favorable to the pope. This concordat remained valid for the kingdom of Italy, which was established in 1805.

In 1818 Napoleon negotiated with the pope a second concordat (the Concordat of Fontainebleau), which was published against the consent of the pope, who had regarded it only as a preliminary agreement, and at once took back his consent. As the reign of Napoleon ceased soon after, the concordat never became effective.

Louis XVIII concluded at Rome with Pius VII (July 11, 1817) a new concordat, by which that of 1516, so injurious to the liberties of the Gallican Church, was again revived; the concordat of 1801 and the *articles organiques* of 1802 were abolished; the nation was subjected to an enormous tax by the demand of endowments for forty-two new metropolitan and episcopal sees, with their chapters and seminaries; and free scope was afforded to the intolerance of the Roman court by the indefinite language of art. 10, which speaks of measures against the prevailing obstacles to religion and the laws of the Church. This revival of old abuses, this provision for the luxury of numerous clerical dignitaries at the expense of the nation, could please only the ultra-royalist nobility, who saw in it the means of providing their sons with benefices. The nation received the concordat with almost universal disapprobation; voices of the greatest weight were raised against it; the Chambers rejected it, and it was never carried through. After the Revolution of 1830 the government fell back on the concordat of 1801, and the organic articles became a new subject of controversy between Church and State.

2. *Germany, Prussia, and Austria.*—The relations of the German Roman Catholics to the pope were greatly disturbed by the dissolution of the German empire. For some time everything was in confusion; at the time of the Congress of Vienna only five German bishops were still alive. When the political reorganization was begun, the pope at first demanded the restoration of the entire former state of things. But when it was found out that this demand would never be granted, negotiations with particular states concerning the conclusion of concordats began. (1.) *Bavaria* was the first state which succeeded (July 5, 1817) in arriving at an agreement. By the Bavarian concordat two archbishoprics were established; seminaries were instituted and provided with land; the nominations were left with the king, with the reservation of the papal right of confirmation; the limits of the civil and ecclesiastical jurisdiction were precisely settled, and the erection of new monasteries was prom-

ised. This concordat was published in May, 1818, together with the new political constitution, by which all apprehensions for the Protestant Church in Bavaria were allayed.

(2.) The government of Prussia, in 1821, agreed with the pope upon a bull of circumscription (*De Salute Animarum*), which was published by the Prussian government as a law of the state. It divides the state into two archbishoprics and six bishoprics, and contains provisions as to the re-establishment of chapters, the election of bishops by chapters, the dotation of bishops and chapters, and the taxes to be paid by the episcopal chancelleries to Rome.

8. *The Ecclesiastical Province of the Upper Rhine.*—In 1818 the state governments of Würtemberg, Baden, and a number of other minor German states sent delegates to a conference at Frankfurt to conduct joint negotiations with the pope concerning the reconstruction of episcopal sees. In 1821, a bull of circumscription, beginning *Provida solersque*, and providing for the establishment of an archbishopric in Baden, and bishoprics in Hesse-Darmstadt, Hesse-Cassel, Nassau, and Würtemberg, and for the dotation of the bishops, was issued and ratified by the governments in 1822. Some further points were agreed upon between these governments and the pope in 1827, and others continued to be the subject of animated controversy, and were in most states not yet settled in 1867.

A concordat with the king of Würtemberg, consisting of thirteen articles, was concluded in 1857. The government promises in it to execute the dotation of the bishopric as soon as circumstances will permit. The bishop received the right to confer all benefices which have no patron, of appointing his vicar general, the extraordinary members of the chapter, and the rural deans, yet he must appoint persons to whom the government has no objections. To the bishops belong all the regulations concerning divine service, the holding of synods, and the introduction of monastic orders, the latter, however, only in concert with the government. The episcopal court has jurisdiction over all ecclesiastical affairs, in particular also over all marriage affairs. The bishop has the right of inflicting ecclesiastical censures on clergymen and laymen. If clergymen transgress civil laws, the secular court will act in concert with the bishop. The intercourse of the bishop, the clergy, and the people with the papal see is free, and ecclesiastical decrees do not require the *placet regium*. The religious instruction of the youth, both in public and private institutions, is under the control of the bishop. He selects the catechism. He has the right of establishing seminaries and of superintending them. Provisionally, special regulations are made for the continuance of the three seminaries at Ehingen, Rottwell, and Tübingen. The theological faculty of the university of Tübingen is also under the control of the bishop, who authorizes the professors to lecture, and may refuse this authorization; who takes their confession of faith, and examines the manuscript of their lectures. The property of the Church is inviolate, but subject to public taxes. It is administered by the Church. The vacant benefices and the intercalary fund are administered by a joint committee of Church and State. The concordat was published by the government in its official paper in 1858, but did not receive the consent of the Legislature, without which many of its provisions cannot become valid.

4. In 1821 Hanover obtained a bull of circumscription similar to the one issued for Prussia, by which two bishoprics were established. For the kingdom of Saxony two bishops in *partibus* were appointed as vicars apostolic. The other minor states had their Roman Catholic subjects placed under the subjection of Prussian or Hanoverian bishops, or of those of the province of the Upper Rhine, and thereby ratified the agreements concluded between those states and Rome.

5. *Austria.*—The government of Austria began to

negotiate with the pope about a new concordat soon after the beginning of the revolutionary movements in 1848. The concordat was concluded in 1855, and was most favorable to the claims of the papacy. The following are the most important points of the Austrian concordat. The Roman Catholic Church in all parts of the empire enjoys the protection of the government. The *Placet Regium* is abolished, and the intercourse of the bishops with the pope is free. The instruction of the Roman Catholic youth must be in accordance with the Roman Catholic religion. The bishops have the power to detain the faithful from reading pernicious books. Cases of the canon law, especially marriage affairs, belong to the ecclesiastical courts, while the civil relations of marriage remain under the jurisdiction of the secular judge. The bishops have the right of exercising the discipline of the Church, and of proceeding against members of the Church with ecclesiastical punishments. The power of the state is promised to the maintenance of the immunity of the Church. The episcopal seminaries are under the jurisdiction of the bishops. The emperor has the right of nominating the bishops, after taking counsel with the other bishops of the ecclesiastical province. The first dignity at every metropolitan and suffragan church is conferred by the pope. The monastic orders are under the jurisdiction of their superiors. The bishops have the right of introducing new orders, after coming previously to an understanding with the government. Church property may be acquired in the legal way, and is secured to the Church. In Feb. 1856, twenty "*Separat-Artikel*" (separate articles) to the concordat were published. They provide that the bishops may found one university independent of the state; that only Roman Catholic professors shall be appointed at the University of Pesth; that Church and State will work together for the suppression of books against religion and morals; that the state shall lay no obstacle in the way of erecting such confraternities and associations as the Church has approved; and that the bishops shall not be hindered from regulating in religious institutions everything that concerns religion and the purity of the Christian life. The immense majority of the Austrian people were indignant at this concordat, and in July, 1867, the Austrian Parliament, by an almost unanimous vote, called on the government to abolish it.

6. *The Netherlands and Belgium.*—Between the government of the Netherlands and the pope a concordat was concluded in 1827, which extended to the northern provinces the provisions of the French concordat of 1801, with the exception that the bishops were not to be nominated by the Protestant king, but to be chosen by the chapter from a list of candidates from which the government had the right to strike out any names not agreeable to it. The concordat was officially published by the government, but the bull of circumscription by which the provinces were divided into bishoprics was not recognised, and the concordat was never carried out. Later the papal government itself disregarded the concordat, and made a new division of dioceses without concert with the government.

In Belgium, which at the time of the publication of the French concordat of 1801 was a part of France, that concordat continued in force, while the country was annexed to Holland (1815-1830). In the new Belgian kingdom the Church was separated from the state, and thus the concordat naturally lost its authority.

7. *Switzerland.*—The idea of establishing one national bishopric could not be carried out, as some of the cantons were unable to agree with the papal see. Gradually, by agreement with some of the cantonal governments, the ecclesiastical relations of the Roman Catholics were regulated, and six bishoprics established.

8. *Italy.*—For Sardinia a new bull of circumscrip-

tion was issued July 17, 1817. *Naples* concluded a convention with the pope July 18, 1818, which in the same year was promulgated as a law of the country. The convention consists of thirty-five articles, and yields all the chief demands of the Roman court. The Roman Catholic Church is declared to be the exclusive religion of the state; the right of nominating the bishops is given to the king; the right to nominate the members of the chapters is divided among the pope and the bishops of the diocese. The Church recognises the sale of Church property which had taken place during the French rule, and the property not yet sold is restored to her; she also receives the right of acquiring new landed property. The jurisdiction of bishops is enlarged; the influence of the Church upon public instruction is guaranteed; the abolition or fusion of ecclesiastical benefices without the consent of the pope is declared invalid; the property of the Church is declared inviolate.

The concordat with *Tuscany* of June 19, 1851, consists of fifteen articles. It provides that the ecclesiastical authorities, in the exercise of their offices, shall find the protection of the state. The intercourse of the bishops with their dioceses and the papal see shall be free. They shall also have the censorship over religious publications, and the right of preventing the faithful from reading pernicious books. If priests offend against civil laws they shall be amenable to the civil courts, but the punishment shall not be inflicted without the consent of the bishops; and if it be the penalty of death, or any penalty involving infamy, the papal see shall take cognizance of the case. The property of the Church shall be administered by the bishops and the parish priests, and, in case of vacancies, by a joint committee of priests and laymen. By this concordat the ecclesiastical legislation of Leopold II, which was nearly the same as that of Joseph II in Austria, was abolished. The concordat was soon followed by some organic interpretations, by which the state, with the consent of the papal see, guarded some of its former rights. The provisional government of Tuscany in 1859 declared this concordat abolished. By the absorption of Naples and Tuscany into the kingdom of Italy their special concordats ceased.

9. *Russian Concordat*.—For the Roman Catholic Church of Russia a concordat was concluded by the emperor Nicholas Aug. 16, 1847. It guarantees to the Roman Catholics of Russia the free exercise of their religion, and permits the establishment of a new bishopric at Cherson for Bessarabia, Tauris, and the Caucasus. The government charged itself with maintaining the bishop, his chapter, and seminary. It also contained provisions on the elections of bishops not yet officially published.

10. A concordat with *Spain*, consisting of forty-five articles, was concluded March 16, 1851. According to it, the Roman Catholic religion is, to the exclusion of every other religious worship, the only religion of the Spanish people. Public instruction in all institutions is to be imparted in accordance with the Roman Catholic doctrine, and placed in this respect under the control of the bishops. The government is bound to assist the bishops in maintaining the purity of doctrine and of morals, and in suppressing pernicious books. The female orders which occupy themselves with education, and the Sisters of Charity, are to be maintained. The confiscated Church property which was not yet sold at the time of the conclusion of the concordat was to be restored to the Church, and to be administered by the clergy. The pope, on the other hand, promised to leave the former buyers of Church property in the undisturbed possession thereof. A new concordat, slightly modifying the preceding, was concluded Nov. 25, 1859.

11. *Portugal*.—A concordat with Portugal was concluded in 1857, and ratified by the Portuguese Legislature in 1859—almost unanimously by the Chamber of

Peers, but only by a majority of fifteen (66 votes against 51) in the Chamber of Deputies. This concordat concerns only the present and former Portuguese possessions in India. It places again nearly the whole of British India under the jurisdiction of bishops appointed by the Portuguese government.—Pierer, *Universal-Lexikon*, s. v.; Herzog, *Real-Encycl.* iii, 60-87; Wetzer u. Welte, *Kirch.-Lex.* ii, 741-760; the Manuals of Church Law (*Kirchenrecht*) of Richter and Walter; Münch, *Vollständige Sammlung aller ältern u. neuern Concordate* (Leipz. 1830, 2 vols.); *Revue des deux Mondes*, May 1, 1865; Sept. 15, 1866.

Concubinage, the sexual connection of two persons of different sexes who are not united by the bond of matrimony. Externally, marriage and concubinage were equal according to Roman law, as even for marriage nothing was required but the agreement of the contracting parties. But they were different with regard to the legal effect of the union. In a regular marriage the wife obtained the rank of the husband (*dignitas mariti*), and her children were legitimate and in the power of the father. None of these results took place in case of concubinage. The Church distinguished between temporary and life-long concubinage. The former was always forbidden; the latter, though not approved, was long tolerated. The Council of Toledo (A.D. 400), by its Canon 17, excommunicates a married man keeping a concubine, but permits unmarried men to do so; and allows either a wife or a concubine. In the Latin Church, it was not until the Council of Trent, which made the validity of a marriage dependent upon a declaration of consent before the parish priest and two witnesses, that life-long concubinage was declared to be criminal, and subjected to punishment. The punishment for ministerial *concubinarius* was withholding of income, suspension, imprisonment, and, ultimately, excommunication. The evangelical churches have never recognised concubinage.—Herzog, *Real-Encycl.* iii, 105; Lea, *Sacerdotal Celibacy*, chap. xii. See **CONCUBINE**.

Concubine (פְּדָיָה, *pe'edah*, deriv. uncertain, but apparently connected with the Gr. *πάλλαξ* [fully in the plur. פְּדָיָה, *pe'edah*, 2 Sam. xv, 16; xx, 8]; Chald. פְּדָיָה, *lechenak'*, Dan. v, 2, 8, 28), denotes in the Bible not a paramour (Gr. *καλακίη*), but only a female conjugally united to a man in a relation inferior to that of the regular wife (יָמָה). See **WIFE**. The positions of these two among the early Jews cannot be referred to the standard of our own age and country; that of concubine being less degraded, as that of wife was, especially owing to the sanction of polygamy, less honorable than among ourselves. The natural desire of offspring was, in the Jew, consecrated into a religious hope, which tended to redeem concubinage from the debasement into which the grosser motives for its adoption might have brought it. The whole question must be viewed from the point which touches the interest of propagation, in virtue of which even a slave concubine who had many children would become a most important person in a family, especially where a wife was barren. Such was the true source of the concubinage of Nahor, Abraham, and Jacob, which indeed, in the two latter cases, lost the nature which it has in our eyes, through the process, analogous to adoption, by which the offspring was regarded as that of the wife herself. From all this it follows that, save in so far as the latter was generally a slave, the difference between wife and concubine was less marked, owing to the absence of moral stigma, than among us. We must therefore beware of regarding as essential to the relation of concubinage what really pertained to that of bondage.

The concubine's condition was a definite one, and quite independent of the fact of there being another woman having the rights of wife towards the same

man. The state of concubinage is assumed and provided for by the law of Moses. A concubine would generally be either (1) a Hebrew girl bought of her father, i. e. a slave, which alone the rabbins regard as a lawful connection (Maimonides, *Halack-Melakim*, iv), at least for a private person; (2), a gentile captive taken in war; (3), a foreign slave bought, or (4), a Canaanitish woman, bond or free. The rights of (1) and (2) were protected by law (Exod. xxi, 7; Deut. xxi, 10), but (3) was unrecognised, and (4) prohibited. Free Hebrew women also might become concubines. So Gideon's concubine seems to have been of a family of rank and influence in Shechem, and such was probably the state of the Levite's concubine (Judg. xx). The ravages of war among the male sex, or the impoverishment of families, might often induce this condition. The case (1) was not a hard lot. The passage in Exod. xxi is somewhat obscure, and seems to mean, in brief, as follows: A man who bought a Hebrew girl as concubine for himself might not treat her as a mere Hebrew slave, to be sent "out" (i. e. in the seventh year, v, 2), but might, if she displeased him, dismiss her to her father on redemption, i. e. repayment probably of a part of what he paid for her. If he had taken her for a concubine for his son, and the son then married another woman, the concubine's position and rights were secured, or, if she were refused these, she became free without redemption. Further, from the provision in the case of such a concubine given by a man to his son, that she should be dealt with "after the manner of daughters," we see that the servile merged in the connubial relation, and that her children must have been free. Yet some degree of contempt attached to the "handmaid's son" (עַבְדֵי הַיָּדָיִם), used reproachfully to the son of a concubine merely in Judg. ix, 18; see also Psa. cxvi, 16. The provisions relating to (2) are merciful and considerate to a rare degree, but overlaid by the rabbis with distorting comments.

Concubinage therefore, in a scriptural sense, means the state of cohabiting lawfully with a wife of second rank, who enjoyed no other conjugal right but that of cohabitation (q. v.), and whom the husband could repudiate, and send away with a small present (Gen. xxi, 14). In like manner, he could, by means of presents, exclude his children by her from the heritage (Gen. xxv, 6). Such concubines had Nahor (Gen. xxii, 24), Abraham (xxv, 6), Jacob (xxxv, 22), Elliphaz (xxxvi, 12), Gideon (Judg. viii, 8), Saul (2 Sam. iii, 7), David (1 Sam. v, 18; xv, 16; xvi, 21), Solomon (1 Kings xi, 8), Caleb (1 Chron. ii, 46), Manasseh (ib. vii, 14), Rehoboam (2 Chron. xi, 21), Abijah (2 Chron. xiii, 21), and Belshazzar (Dan. v, 2). Their issue was reputed legitimate (though the children of the first wife were preferred in the distribution of the inheritance), but in all other respects these concubines were inferior to the primary wife, for they had no authority in the family, nor any share in household government. If they had been servants in the family before they came to be concubines they continued to be so afterwards, and in the same subjection to the mistress as before. If a woman were made captive in war she was allowed a month in which she was at liberty to mourn the loss of her parents and friends; and neither father nor son was permitted to take her as a concubine until the expiration of that time (Deut. xx, 10, 14). To judge from the conjugal histories of Abraham and Jacob (Gen. xvi and xxx), the immediate cause of concubinage in patriarchal times was the barrenness of the lawful wife, who in that case introduced her maid-servant of her own accord to her husband for the sake of having children. Accordingly, we do not read that Isaac, son of Abraham, had any concubine, Rebecca, his wife, not being barren. In process of time, however, concubinage appears to have degenerated into a regular custom among the Jews, and the institutions of Moses were directed to prevent excess

and abuse in that respect by wholesome laws and regulations (Exod. xxi, 7-9; Deut. xxi, 10-14). The unfaithfulness of a concubine was regarded as criminal (Judg. xix, 2; 2 Sam. iii, 7, 8), but it was not punished as was that of a wife (Lev. xix, 20). See ADULTERY. Such a case, however, as that mentioned (Judg. xix), where not only is the possessor of the concubine called her "husband" (ver. 8), but her father is called his father-in-law and he his son-in-law (4, 5), shows how nearly the concubine approached to the wife. Hired women, such as "uxores mercenariæ conductæ ad tempus ex pacto," whom Ammianus Marcellinus attributes to the Saracens (xiv, 4), were unknown among the Hebrews. To guard adult male offspring from debauchery before marriage, their parents, it appears, used to give them one of their female slaves as a concubine. She was then considered as one of the children of the house, and she retained her rights as a concubine even after the marriage of the son (Exod. xxi, 9, 19). When a son had intercourse with the concubine of his father, a sort of family punishment, we are informed, was inflicted on him (Gen. xxxv, 22; 1 Chron. v, 1). Where polygamy was tolerated—as it was among the Hebrews—the permission of concubinage would not seem so much at war with the interests and preservation of society as we know it to be. Christianity restores the sacred institution of marriage to its original character, and concubinage is ranked with fornication and adultery (Matt. xix, 5; 1 Cor. vii, 2). See POLYGAMY.

In the Talmud (tit. *Cetuboth*), the Rabbins differ as to what constitutes concubinage, some regarding as its distinguishing feature the absence of the betrothing ceremonies (*sponsalia*) and of the dowry (*libellus dotis*), or portion of property allotted to a woman by special engagement, and to which she was entitled on the marriage day, after the decease of the husband, or in case of repudiation; others, again, the absence of the latter alone. In the books of Samuel and Kings the concubines mentioned belong to the king, and their condition and number cease to be a guide to the general practice. A new king stepped into the rights of his predecessor, and by Solomon's time the custom had approximated to that of a Persian harem (2 Sam. xii, 8; xvi, 21; 1 Kings ii, 22). To seize on royal concubines for his use was thus a usurper's first act. Such was probably the intent of Abner's act (2 Sam. iii, 7), and similarly the request on behalf of Adonijah was construed (1 Kings ii, 21-24). For fuller information, Selden's treatises *De Uxore Hebrææ* and *De Jure Naturæ et Gent. v, 7, 8*, and especially that *De Successionibus*, cap. iii, may, with some caution (since he leans somewhat easily to rabbinical tradition), be consulted; also the treatises *Sotah*, *Kidushin*, and *Cetuboth* in the Gemara Hierosol., and that entitled *Sanehedrin* in the Gemara Babyl. The essential portions of all these are collected in Ugolini, vol. xxx, *De Uxore Hebrææ*. See also Otho, *Lex. Rabbin.* p. 151; Selden, *De Successionibus*, iii; Michaelis, *Laws of Moses*, i, 455-466.

The Roman law calls concubinage an allowed custom (*licita consuetudo*). When this expression occurs in the constitutions of the Christian emperors, it signifies what we now sometimes call a *marriage of convenience*. The concubinage tolerated among the Romans, in the time of the Republic and of the heathen emperors, was that between persons not capable of contracting legal marriage. Inheritances might descend to children that sprung from such a tolerated cohabitation. Concubinage between such persons they looked on as a kind of marriage, and even allowed it several privileges; but then it was confined to a single person, and was of perpetual obligation, as much as marriage itself (Gail, *Institut.* lib. i, § 109 sq.; Justin. *Institut.* lib. i, tit. x). Hottoman observes that the Romans had allowed concubinage long before Julius Cæsar enacted the law by which every one was at

liberty to marry as many wives as he pleased. The emperor Valentinian, Socrates tells us, allowed every man two. Concubinage is also used to signify a marriage with a woman of inferior condition, to whom the husband does not convey his rank. Dajos (Paratilla) observes that the ancient laws allowed a man to espouse, under the title of concubine, certain persons who were esteemed unequal to him on account of the want of some qualities requisite to sustain the full honor of marriage; and he adds that, though such concubinage was beneath marriage both as to dignity and civil rights, yet was concubine a reputable title, and very different from that of "mistress" among us. The connection was considered so lawful that the concubine might be accused of adultery in the same manner as a wife (see Smith's *Dict. of Class. Antiq.* s. v. Concubina).

This kind of concubinage is still in use in some countries, particularly in Germany, under the title of *half-mariage* (half-marriage), left-hand or morganatic marriage, in allusion to the manner of its being contracted, namely, by the man giving the woman his left hand instead of the right. This is a real marriage, though without the usual solemnity, and the parties are both bound to each other forever, though the female cannot bear the husband's name and title.—Kitto, s. v.; Smith, s. v. See MARRIAGE: CONCUBINAGE.

Concupiscence (Lat. *concupiscentia*), evil desire (*ἐπιθυμία*, Rom. vii, 8; *ἐπιθυμία κακή*, Col. iii, 5); generally used in the sense of indwelling sin. The term is especially used in Roman Catholic theology. For its import there, and the controversy concerning it, see SIX.

Conder, JOSIAH, born in London 17th September, 1789, was the son of a bookseller, and very early displayed a taste for literature. In 1814, being at the time a bookseller, he purchased the *Eclectic Review*, of which he continued to be editor until 1837. Under his management the *Eclectic Review* received the assistance of many eminent men among the Nonconformists, such as Robert Hall, John Foster, Dr. Chalmers, Dr. Vaughan, and others. In 1818 he published a treatise *On Protestant Nonconformity* (Lond. 2 vols. 8vo); in 1824 *The Star in the East*, a poem; and in 1834 a new translation of the *Epistle to the Hebrews*, with Notes. In 1836 he edited *The Congregational Hymn-book*, issued under the sanction of the Congregational Union. Besides these, he issued *An Analytical View of all Religions* (1838, 8vo); *Exposition of the Apocalypse* (8vo); *Literary History of N. T.* (1845, 8vo). His works are chiefly compilations, but are carefully executed, and well adapted to popular use. He died Dec. 27, 1855.

Condescension, a term both earlier and more correct for the modern theory of the ACCOMMODATION (q. v.) of Scripture; we have therefore reserved for this place some remarks supplementary to the article under that head. The general idea expressed by the term accommodation is that some object is presented, not in its absolute reality as it is in itself, but under some modification, or under some relative aspect, so as the better to secure some end at which the writer or speaker aims. Of this leading conception there are several forms known among Biblical scholars under the titles of *formal* and *material* accommodation. The following is a somewhat fuller analysis.

1. *Real*.—This takes place when a person is set forth as being or as acting under some modified character, accommodated to the capacity for conceiving him, or the inclination to receive him, of those to whom the representation is addressed. Thus God is frequently in Scripture described anthropomorphically or anthropopathically, i. e. not as he is in himself, but relatively to human modes of thought and apprehension. See ANTHROPOMORPHISM. So also the apostle describes himself as becoming all things to all men, that by all

means he might save some; i. e. he accommodated himself to men's habits, usages, and modes of thought, and even prejudices, in order that he might disarm their opposition, and secure a favorable reception for the gospel of salvation which he preached. This species of accommodation is what the Christian fathers usually have in view under the terms *συγκατάβασις*, or *condescensio*, and *οἰκονομία*, or *dispensatio*. They apply these terms also to the incarnation and state of humiliation of Christ, which they regarded as an accommodation to the necessities of man's case for his redemption. (See Suicer, *Theaurus Ecol.* s. v. *συγκατάβασις* and *οἰκονομία*; Chapman's *Miscellaneous Tracts relating to Antiquity*, London, 1742.) To this head may be referred many of the symbolical actions of the prophets.

2. *Verbal*.—This takes place when a passage or expression used by one writer is cited by another, and applied with some modification of the meaning to something different from that to which it was originally applied. Such accommodations are common in all languages. Writers and speakers lay hold of the utterances of others for the sake of giving to their own ideas a more graceful and a more forcible clothing than they feel themselves able to give them, or for the purpose of procuring for them acceptance, by uttering them in words which some great writer has already made familiar and precious to the general mind. Sometimes this is done almost unconsciously. "Wherever," says Michaelis, "a book is the object of our daily reading and study, it cannot be otherwise than that passages of it should frequently flow into our pen in writing; sometimes accompanied with a conscious recollection of the place where we have read them, at other times without our possessing any such consciousness. Thus the lawyer speaks with the *corpus juris* and the laws, the scholar with the Latin authors, and the preacher with the Bible" (*Einleit.* i, 223). Our own literature is full of exemplifications of this, as is too well known to need illustrative proof. In the writings of Paul we find him making use in this way of passages from the classics (Acts xvii, 19; 1 Cor. xv, 84; Tit. i, 12), all of which are of course applied by him to Christian subjects only by accommodation. We need not be surprised, then, to find the later Biblical writers quoting in this way from the earlier, especially the N.-T. writers, from the great classic of their nation, the *ἑρμηνεία* of the former dispensation. As instances may be adduced, Rom. x, 18 from Psa. xix, 4, and Rom. xii, 20 from Prov. xxv, 21, 22. See also Matt. ii, 15, 18, with Calvin's notes thereon. "They have done this," says Michaelis, "in many places where it is not perceived by the generality of readers of the N. T., because such are too little acquainted with the Septuagint."

3. *Rhetorical*.—This takes place when truth is presented, not in a direct and literal form, but through the medium of symbol, figure, or apologue. Thus, in the prophetic writings of Scripture, we have language used which cannot be interpreted literally, but which, taken symbolically, conveys a just statement of important truth, e. g. Isa. iv, 5; xxvii, 1; xxxiv, 4; Joel ii, 28-31; Zech. iv, 2, 10, etc. Many instances occur in Scripture where truth is presented in the form of parable, and where the truth taught is to be obtained only by extracting from the story the spiritual, or moral, or practical lesson it is designed to enforce. In all the sacred books there are instances constantly occurring of words and statements which are designed to convey, under the vehicle of figure, a truth analogous to, but not really what they literally express. (See Knobel, *Prophetismus der Hebräer*, § 70-88; Smith, *Summary View and Explanation of the Writings of the Prophets*, Prel. Obs. p. 1-22; Glassius, *Phil. Sac.* l. v, p. 669 sq., ed. 1711; Lowth, *De Sac. Poesi Heb.*, pl. loc.; Davidson, *Sacred Hermeneutics*, ch. ix.)

4. *Logical*.—In arguing with an opponent it is sometimes advantageous to take him on his own ground, or to argue from principles which he admits, for the purpose of shutting him up to a conclusion which he cannot refuse, if he would retain the premises. It does not follow from this that his ground is admitted to be the right one, or that assent is given to his principles; the argument is simply one *ad hominem*, and may or may not be also *ad veritatem*. When it is not, that is, when its purpose is merely to shut the mouth of an opponent by a logical inference from his own principles, there is a case of logical accommodation.

5. *Doctrinal*.—This takes place when opinions are advanced or statements made merely to gratify the prejudices or gain the favor of those to whom they are addressed, without regard to their inherent soundness or truthfulness. If, for instance, the N.-T. writers were found introducing some passage of the O. T. as a prediction which had found its fulfilment in some fact in the history of Jesus Christ or his Church, merely for the purpose of overcoming Jewish prejudices, and leading those who venerated the O. T. to receive more readily the message of Christianity; or if they were found not only clothing their ideas in language borrowed from the Mosaic ceremonial, but asserting a correspondence of meaning between that ceremonial and the fact or doctrines they announced when no such really existed, thereby warping truth for the sake of subduing prejudices, they would furnish specimens of this species of accommodation.

In both respects, a charge to this effect has been brought against them. It has been alleged that when they say of any event they record that it was fulfilled such and such a statement of the O. T., or that the event occurred that such and such a statement might be fulfilled, they did so merely in accommodation to Jewish feeling and prejudices. A fitter place will be found elsewhere for considering the import of the formula *ἵνα πληρωθῆ, τότε πληρωθῆ*, and the like. See QUOTATION. At present it will suffice to observe that it may be admitted that these formulae are occasionally used where there can have been no intention on the part of the writer to intimate that in the event to which they relate there was the fulfilment of a prediction; as, for instance, where some gnome or moral maxim contained in the O. T. is said to be fulfilled by something recorded in the N. T., or some general statement is justified by a particular instance (comp. Matt. xii, 85; John xv, 25; Rom. i, 17; Jam. ii, 23; 2 Pet. ii, 22, etc.). It may be admitted, also, that there are cases where a passage in the O. T. is said to be fulfilled in some event recorded in the N., when all that is intended is that a *similarity* or *parallelism* exists between the two, as is the case, according to the opinion of most, at least, in Matt. ii, 17, 18. But, whilst these admissions throw the *onus probandi* on those who, in any special instance, maintain that there is in it an actual fulfilment of an ancient prediction, it would be preposterous from them to foreclose the question, and maintain that in no case is the N.-T. passage to be understood as affirming the fulfilment in fact of an ancient prediction recorded in the Old. Because some accommodations of the kind specified are admitted, it would be folly to conclude that nothing but accommodation characterizes such quotations. If this position were laid down, it would not be easy to defend the N.-T. writers, nay, our Lord himself, from the charge of insincerity and duplicity.

Still more emphatically does this last observation apply with respect to the notion that our Lord and his apostles accommodated their teaching to the current notions and prejudices of the Jews of their own times. It might seem almost incredible that any one should venture to impute to them so unworthy and so improbable a course, were it not that we find the imputation broadly made, and the making of it defended by some very eminent men of the anti-supernaturalist

school, especially in Germany. By them it has been asserted that our Lord and his disciples publicly taught many things which privately they repudiated, and an attempt has been made to save them from the charge of downright dishonesty which this would involve by an appeal to the usage of many ancient teachers who had an exotic doctrine for the multitude, and an exotic for their disciples. (Semler, *Programm. Acad. Sel. Hal. 1779*; Corrodi, *Begrüpe sur beförderung des vernünftigen Denkens in d. Religion*, 15th part, p. 1-25; P. Van Hemert, *Ueber Accom. in N. T. Leipz. 1791*, etc.). The prompt and thorough repudiation of such views even by such men as Wegscheider (*Instit. Theologicae*, p. 105, 6th ed.) and Bretschneider (*Handb. der Dogmat.* i, 260, 265, 2d ed.) renders it unnecessary to enlarge on the formal refutation of them. These writers, however, contend that, though our Lord and his apostles did not make use of a *positive* accommodation of their doctrine to the prejudices or ignorance of the Jews, they did not refrain from a *negative* accommodation, by which they intend the use of *reserve* in the communication of truth or refutation of error, and the allowing of men to retain opinions not authorized by truth without express or formal correction of them. They adduce as instances, John xvi, 12; vi, 15; Luke xxiv, 21; Acts i, 6; 1 Cor. iii, 1, 2; viii, 9, etc. By these passages, however, nothing more is proved than that in teaching men truth our Lord and his apostles did not tell them *everything at once*, but led them on from truth to truth as they were able to receive it or bear it. In this there is no accommodation of the *material* of doctrine; it is simply an accommodation of *method* to the capacity of the learner. In the same way Paul's assertion, which they have also cited, that he became all things to all men, that he might by all means save some (1 Cor. ix, 22), is to be regarded as relating merely to the mode and order of his presenting Christian truth to man, not to his modifying in any respect the substance of what he taught. When he spoke to Jews, he opened and alleged out of their own Scriptures that Jesus was the Christ (Acts xvii, 2, 8). When he spoke to the Athenians on Mars' Hill, he started from the ground of natural religion, and addressed the reason and common sense of his audience; but in either case it was the same Jesus that he preached, and the same Gospel that he published. Had he done otherwise, he would have been found a false witness for God.

This accommodation theory is often spoken of as identical with the historical principle of interpreting Scripture. It is so, however, only as the historical principle of interpretation means the treating of the statements of our Lord and his apostles as merely expressing the private opinions of the individual, or as historically traceable to the prevailing opinions of their day. This is not to be confounded with that true and sound principle of historical interpretation, which allows due weight to historical evidence in determining the meaning of words, and to the circumstances in which statements were made as determining their primary application and significance. (Storr, *Opusc. Acad.* vol. i; *Abhandlung u. d. Zweck des Todes Jesu*, § 10; *Lehrb. d. Chr. Dogmatik*, § 18 [Eng. tr. by Schmucker, p. 67, Lond. 1886]; Planck, *Introduct. to Soc. Interpretation*, tr. with notes by Turner [N. Y. 1834], p. 138, 276; Unselt, *De accommodations orthodoxis* [Lips. 1766]; Smith, *First Lines of Christian Theology*, p. 518; Alexander, *Connection and Harmony of the Old and New Testaments*, p. 45-48; 148-157, 416, 2d ed.). — Kitto, s. v. Accommodation. See HERMENEUTICS.

Condict, IRA, D.D., a clergyman of the Reformed Dutch Church at New Brunswick, N. J., from 1798 to 1811, and vice-president of Queen's (now Rutgers) College, and professor of moral philosophy. He was an eminent, useful, and honored minister and collegiate officer. He died suddenly in 1811. It is to be re-

gretted that no materials are left for a more satisfactory notice of this venerated man.

Condignity AND Congruity (*meritum de condigno* and *de congruo*), "terms used by the schoolmen to express their peculiar opinions relative to human merit and deserving. The Scotists maintain that it is possible for man in his natural state so to live as to *deserve* the grace of God, by which he may be enabled to obtain salvation; this natural *fitness* (*congruitas*) for grace being such as to oblige the Deity to grant it. Such is the *merit of congruity*. The Thomists, on the other hand, contend that man, by the divine assistance, is capable of so living as to *merit* eternal life, to be *worthy* (*condignus*) of it in the sight of God. In this hypothesis, the question of previous preparation for the grace which enables him to be *worthy* is not introduced. This is the *merit of condignity*." The 13th article of the Church of England is directed against these opinions, and maintains that the grace of Christ and the inspiration of his Spirit can alone produce the fitness required in Christians; and that so far as any works not springing of faith in Christ from being pleasing to God, that they have the nature of sin.—Hook, *Eccles. Dictionary*, s. v.

Conditional. Strict Calvinists maintain that the decrees of God with regard to the salvation or damnation of individual men are *absolute*; Arminians, that they are *conditional*. The Pelagian doctrine is that God's will to grant grace to men is always conditioned on their so using their *natural* power as to merit that grace. To say that God decrees to save all men if they will, i. e. if they, without grace, are willing to obey God, is Pelagian; to say that God wills to save all men if they will use the preventent grace given to them, which they are left at liberty to resist, is Arminian. See ARMINIANISM; GRACE.

Condillac, ETIENNE BONNOT DE MABLY, one of the chief French philosophers of the 18th century, brother of the abbé Mably, was born at Grenoble in 1715. At the age of thirty he published his first important work, *Essai sur l'origine des connaissances humaines* (Amsterdam, 1746, 2 vols.; Eng. transl. by Th. Nugent, 1766), by which he largely contributed to the spreading of the views of Locke in France, and to their farther development. This book is a natural history of human cognition, the foundation of which is found by Condillac in the sensuous impressions and their transformations. To refute the metaphysical systems which do not proceed from experience, he wrote his *Traité des Systèmes* (Amsterdam, 1749, 2 vols.). His views on the origin of human cognition were more fully developed in his *Traité des Sensations* (Amsterdam, 1754, 2 vols.). As he was charged with having plagiarized from Diderot and Buffon, he wrote for his defense *Traité des Animaux* (Amsterdam, 1775). By all these writings Condillac became one of the chief representatives of Sensualism, although he steered clear of the Materialism of his age. His knowledge had procured for him at an early age the position of tutor of the infants of Parma, a nephew of Louis XV. He wrote for him a *Cours d'étude* (Parma, 1775, 18 vols.), which contains a grammar, an *Art d'écrire*, an *Art de raisonner*, an *Art de penser*, and a universal history. In 1768 he was made a member of the French Academy. During the latter part of his life he lived very retired, and died August 8, 1780. His complete works have appeared in several editions (*Œuvres Complètes*, Paris, 1798, 23 vols.; 1808, 32 vols.; 1824, 16 vols.).—(Brockhaus) *Conversat. Lex.* s. v.; Wetzler u. Welte, *Kirchen-Lex.* ii, 764.

Conduit (תְּעֵלָה, *te'elah*) [from תָּעַל, *alah*, to ascend, Gesenius, *Theb. Heb.* p. 1022], a *channel*, "watercourse," Job xxxviii, 25, stream, Ezek. xxxi, 4, or "trench," 1 Kings xviii, 32-38), spoken of the aqueduct made by Hezekiah for conveying the waters from

the upper pool in the valley of Gihon into the western part of Jerusalem (2 Kings xviii, 17; xx, 20; Isa. vii, 8; xxxvi, 2); apparently the same with that which now supplies the mosque enclosure with water from the pools at Bethlehem. It seems at first to have been an open trench, but was closed by Hezekiah with masonry on the approach of the Assyrians (Sirach xlviii, 12). See JERUSALEM.

1. Although no notice is given either by Scripture or by Josephus of any connection between the pools of Solomon beyond Bethlehem and a supply of water for Jerusalem, it seems unlikely that so large a work as the pools should be constructed merely for irrigating his gardens (Ecl. ii, 6); and tradition, both oral and as represented by Talmudical writers, ascribes to Solomon the formation of the original aqueduct by which water was brought to Jerusalem (Maundrell, *Early Trav.* p. 458; Hasselquist, *Trav.* 146; Lightfoot, *Descr. Templ.* c. xxiii, vol. i, 612; Robinson, i, 890). Pontius Pilate applied the sacred treasure of the Corban to the work of bringing water by an aqueduct from a distance, Josephus says of 300 or 400 stadia (*War*, ii, 9, 4), but elsewhere 200 stadia, a distance which would fairly correspond with the length of the existing aqueduct with all its turns and windings (*Ant.* xviii, 8, 2; Williams, *Holy City*, ii, 501). His application of the money in this manner gave rise to a serious disturbance. Whether his work was a new one, or a reparation of Solomon's original aqueduct cannot be determined, but it seems more than probable that the ancient work would have been destroyed in some of the various sieges since Solomon's time. The aqueduct, though much injured, and not serviceable for water beyond Bethlehem, still exists; the water is conveyed from the fountains which supply the pools about two miles S. of Bethlehem. The watercourse then passes from the pools in a N. E. direction, and, winding round the hill of Bethlehem on the S. side, is carried sometimes above and sometimes below the surface of the ground, partly in earthen pipes and partly in a channel about one foot square of rough stones laid in cement, till it approaches Jerusalem. There it crosses the valley of Hinnom at the S. W. side of the city on a bridge of nine arches at a point above the pool called *Birket es-Sultân*, then returns S. E. and E. along the side of the valley and under the wall, and, continuing its course along the east side, is finally conducted to the Haram. It was repaired by Sultan Mohammed Ibn-Kalaf of Egypt about A. D. 1800 (Williams, *Holy City*, ii, 498; Raumer, *Pal.* p. 280; Robinson, i, 514; ii, 166; new ed. iii, 247). See POOL.

2. Among the works of Hezekiah he is said to have stopped the "upper watercourse of Gihon," and brought it down straight to the W. side of the city of David (2 Chron. xxxii, 80). The direction of this watercourse of course depends on the site of Gihon. Dr. Robinson identifies this with the large pool called *Birket es-Mamilla* at the head of the valley of Hinnom, on the S. W. side of Jerusalem, and considers the lately-discovered subterranean conduit within the city to be a branch from Hezekiah's watercourse (*Researches*, new ed. iii, 248-4; i, 827; Gesenius, *Theb. Heb.* p. 616, 1395). Mr. Williams, on the other hand, places Gihon on the N. side, not far from the tombs of the kings, and supposes the watercourse to have brought water in a S. direction to the temple, whence it flowed ultimately into the Pool of Siloam, or Lower Pool. One argument which recommends this view is found in the account of the interview between the emissaries of Sennacherib and the officers of Hezekiah, which took place "by the conduit of the upper pool, in the highway of the fuller's field" (2 Kings xviii, 17), whose site seems to be indicated by the "fuller's monument" mentioned by Josephus as at the N. E. side of the city, and by the once well-known site called the Camp of the Assyrians (Josephus, *War*, v, 4, 2; 7, 8; 12, 2). (See Maundrell, p. 456 sq., Bohn's ed.; Richardson,

Travels, ii, 879; Bertheau, *D. Büch. d. Könige*, p. 409; Schultz, *Jerusalem*, p. 40.)—Smith. See GIBSON.

CONE, SPENCER H., D.D., an eminent Baptist minister, was born in Princeton, N. J., April 80, 1786. His early education was carefully conducted, and at twelve years of age he entered Princeton College. Two years after, through his father's failure in business, he was compelled to leave college, and devoted himself to teaching, first in Princeton, then in Burlington, and finally (under Dr. Abercrombie) in Philadelphia. Here he began to study law; but his fine powers of elocution led him in 1805 to become an actor. He "trod the boards" with distinction for eight years, and then was suddenly converted, and was baptized by immersion Feb. 4, 1814. Obtaining a government clerkship in Washington, he removed thither, and began to preach within a year after his baptism. In 1815-16 he was chaplain to Congress, and immediately became pastor of a Baptist church at Alexandria, D. C. In 1823 he accepted a call from the Oliver Street Baptist Church, New York, where he remained until 1841, when he became pastor of the First Baptist Church, which built a new edifice in Broome Street. In this charge he remained until his death, Aug. 28, 1855. Dr. Cone's career as a preacher was very brilliant. He spoke with great ease, with a rich, sonorous voice, and very appropriate and expressive gestures. In doctrine he was a Calvinist, and a strenuous advocate of Baptist views, but yet courteous and charitable to all Christians. His preaching and pastoral labor exhausted but a small part of his activities. He took a deep interest in missions, was a member of the Baptist Board, and was president of the Convention from 1832 to 1841. He did his utmost to avert the disruption of the Convention in 1845 through the slavery disputes. He was also an officer of the Baptist Home Missionary Society from its beginning in 1832 to 1855. For many years he was active in the service of the American Bible Society, but on the formation of the Baptist (American and Foreign) Bible Society in 1836, which he aided greatly in organizing, he was made its president. On the refusal of this society to embark in the enterprise of "Bible Revision," so called, he seceded from it in order to form the American Bible Union, one of the chief objects of which was to substitute "immerse" for "baptize" in the versions of Scripture.—Sprague, *Annals*, vi, 658.

Coney (חֶפְזִי, *shaphan*; Sept. χοιρογρόλλις), an animal joined in Lev. xi, 5, and Deut. xiv, 7, with the hare, and described as chewing the cud; in *Ps.* civ, 18, it is spoken of as an inhabitant of the mountains and rocks, and in *Prov.* xxx, 26, it is represented as a feeble, but gregarious and cunning animal. These descriptions some think agree best with the different species of the *jerboa*, the *Mus jaculus* of Linnæus. It is on the authority of Rabbinical writers that the word has by our translators been rendered "coney," or *rab-bit*, which cannot be sustained, as the rabbit is not an Asiatic animal, and does not seek a rocky habitation, which is the leading characteristic by which the *shaphan* is distinguished. "The animal is, in truth, as Bruce justly indicated, the same as the *Ashkoko* of Abyssinia, or *Daman* of Syria, the *Wabber* of the Arabs, and in scientific zoology is one of the small genus *HYRAX*, distinguished by the specific name of Syrian (*Syriacus*). This animal has been described by travellers as a ruminant, but this is an error. The number, shape, and structure of the teeth are totally different (as is true also of the hare); nor is the jawbone articulated so as to admit freely of a similar action; finally, the internal structure, as well as the whole osteology, represents that of a rhinoceros in miniature, and has no appearance of the complicated four-fold stomachs of ruminants; therefore the hyrax is neither a rodent like hares and rabbits, nor a ruminant, but is anomalous, and most nearly allied to the

great pachyderms of systematic zoology. It may be that the peculiar structure of their anterior teeth is convenient for stripping off the seeds of grasses and tritica, and that these, in part retained in the mouth, cause a practice of working the jaws, which, to common observers, may appear to be chewing the cud. In hares and rats a similar appearance is produced by a particular friction of the incisors or nippers, which, growing with great rapidity, would soon extend beyond a serviceable length if they were not kept to their proper size by constant gnawing, and by working the cutting edges against each other. This action, observed in the motion of the lips of most rodents when in a state of rest, caused the belief of ruminantia in the hare, though, like the hyrax, all rodents are equally unprovided with the several stomachs, and want the muscular apparatus necessary to force the food back into the mouth for remastication at pleasure, which constitute the leading peculiarities of the anatomical structure of the ruminantia. But they may possess, in common with pachydermata, like the boar and hog, the peculiar articulation and form of jaws which give them the power of grinding their food, and laminated teeth fitted for the purpose. Externally the hyrax is somewhat of the size, form, and brownish color of a rabbit, and it has short, round ears, sufficiently like for inexact observers to mistake the

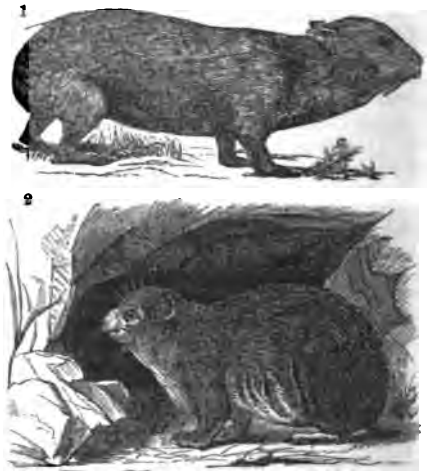

Hyrax Syriacus: 1, From a specimen in the British Museum; 2, Ordinary appearance in its native haunts.

one for the other. The hyrax is of clumsier structure than the rabbit, without tail, having long bristly hairs scattered through the general fur; the feet are naked below, and all the nails are flat and rounded, save those on each inner toe of the hind feet, which are long and awl-shaped; therefore the species cannot dig, and is by nature intended to reside, not, like rabbits, in burrows, but in the clefts of rocks. This character is correctly applied to the shaphan by David" (Kitté). The total length of the animal as it sits is about one foot. It presents at first sight the idea of a rat rather than any other creature. The color is gray, mixed with reddish-brown, and the belly white. They do not appear to have any cry, nor do they stand upright in walking, but seem to steal along as if in fear, advancing a few steps at a time, and then pausing. "Their timid, gregarious habits, and the tenderness of their paws, make them truly 'the wise and feeble folk' of Solomon, for the genus lives in colonies in the crevices of stony places in Syria, Palestine, Arabia, Eastern Egypt, Abyssinia, and even at the Cape of Good Hope, where one or two additional species exist. In every locality they are quiet, gentle creatures, preferring to bask in the sun, never stirring far from their

streets, moving with caution, and shrinking from the shadow of a passing bird, for they are often the prey of eagles and hawks; their habits are strictly diurnal, and they feed on vegetables and seeds" (Kitto). The flesh of the shaphan was forbidden the Hebrews, and appears that the Mohammedans and Christians of the East at the present day abstain from the flesh of the daman. (See further particulars in the *Penny Cyclopaedia*, s. v. Hyrax; also Bochart, *Hieroz.* ii, 421 sq.; Rosenmüller, *Akerth.* IV, ii, 218 sq.; Shaw, *Trav.* p. 77 sq.; Sonnini, i, 98; Bruce, vii, 241; Hasselquist, p. 77 sq.; Wilson, *Bible Lands*, ii, 28; Laborde, *Voyages*, p. 47; Robinson, *Researches*, new edit. iii, 887; Thomson, *Land and Book*, i, 460; Oedmann, *Samm.* v, 48; Lucas, *Allerneuste R.* p. 800; Oken, *Naturgesch.* VII, ii, 889; Ehrenberg, *Symbol. phys.* i, fig. 2; Ludolf, *Lez. Amhar.* p. 58; *Hist. Ethiop.* lib. i. c. 10, § 75; Peyron, *Lez.* p. 814; Gesenius, *Theo. Heb.* p. 1467; Vloten, *Spec.* p. 46; Schubert, *Reis.* iii, 110; Gesen. *ad Burckhardt*, p. 1076; Forskal, *Descript. ansim.* p. v; Fresnel, in the *Asiatic Journal*, June, 1838, p. 514; Isenberg, *Lez. Amhar.* p. 122; Kitto, *Phys. History of Palest.* p. ccclxxvi; Laborde, *Syria*, p. 114.) See ZOOLOGY.

Confalon, a fraternity of seculars in the Church of Rome called penitents, established originally by some Roman citizens. Henry III commenced a similar fraternity in Paris in 1583, and, dressed in the habit of a penitent, assisted at a procession wherein the cardinal of Guise carried the cross, and his brother, the duke of Mayence, was master of the ceremonies.—*Hook, Church Dictionary*, s. v.

Confection (רִקְעָה, *ro'kach*, Exod. xxx, 85), **CONFECTIO** (רִקְעָה, *rakkachah**, 1 Sam. viii, 18), both derived from the root רִקַּע (*rakac*), to *spice*, denote respectively *perfume* and a *female perfumer*, as the passages cited and the kindred terms derived from the same root (and translated "apothecary," "perfume," "ointment") indicate. See APOTHECARY.

Conference, the bringing together of individual opinions upon any subject of debate: hence applied, peculiarly, to religious discussions of any kind (Gal. ii, 6).

CONFERENCE, FREE-WILL BAPTIST. The ecclesiastical bodies among Free-Will Baptists, higher than the congregation, are the Quarterly Meeting, the Yearly Meeting, and the General Conference. The latter meets every three years. See BAPTISTS, FREE-WILL.

CONFERENCE, HAMPTON-COURT. A conference held at Hampton Court in the year 1604, between nine bishops and as many other dignitaries of the Church on the one side, and four Puritan divines on the other. It was held in the presence of James I, and lasted for three days. Some of the demands of the Puritans were acceded to, but others were rejected. One lasting advantage, however, resulted from this conference, namely, our present authorized version of the Bible. Some alterations also were made in the Liturgy; all the thanksgivings now in use were inserted except the "general" one, which was subsequently introduced; and there was annexed to the Catechism the portion explaining the sacraments.—*Eden, Churchman's Dictionary*, s. v.; Neal, *History of the Puritans*, ii, 90; Mosheim, *Ch. Hist.* iii, 408.

CONFERENCE, METHODIST. There are three synods or judicatories styled *Conferences* in the Methodist Episcopal Church.

I. The *Quarterly Conference* of each circuit or station consists of the "travelling and local preachers, exhorters, stewards, and class-leaders of the circuit or station. The presiding elder, and, in his absence, the preacher in charge, is president. The regular business of the Quarterly Conference is to hear complaints, and to receive and try appeals; to superintend the inter-

ests of Sunday-schools, to license local preachers, to appoint stewards," etc. (*Discipline*, pt. ii, ch. i, § 8).

II. The *Annual Conference* is composed of all the ministers in a certain territory included in the "Conference." There are now (1867) fifty-nine Conferences of the Methodist Episcopal Church, including Mission Conferences, besides those of the Methodist Episcopal Church South. The functions of the Annual Conference are purely administrative. At each session the preachers are "appointed" to their several stations for the ensuing year by the bishop (*Discipline*, pt. ii, ch. i, § 2).

III. The *General Conference* is "composed of one member for every twenty-seven members of each Annual Conference, appointed either by seniority or choice, at the discretion of such Annual Conference." It meets once in four years, and is presided over by the bishops. It has full power to "make rules and regulations for the Church," subject to certain limitations known as "constitutional restrictions" (*Discipline*, pt. ii, ch. i, § 1). See METHODISM.

In the Wesleyan Church, in England, all the ministers meet in one Conference. "The first Conference of the Wesleyan Methodists was held in London in the year 1744. It was attended only by six persons, five of whom were clergymen. By them the characters of the preachers were examined, differences of theological opinions repressed, the stations of the preachers determined, and their hearts warmed and cheered by mutual consultation and prayer. As Mr. Wesley declined into the vale of years, the perpetuity of that system of doctrine and discipline, which had been so signally owned of God in the conversion and salvation of men, became a matter of anxious concern both to himself and his people. The appointment of the preachers to the various chapels, and to the consequent pastoral charge of the societies, presented the greatest difficulty. The preachers felt the importance of the case, and requested Mr. Wesley to consider what could be done in this emergency, so that, in the event of his death, the connection might not be dissolved. He took legal advice, and drew up the 'deed of declaration,' constituting one hundred preachers by name 'the Conference of the people called Methodists;' at the same time defining their powers, and making provision for the filling up of all vacancies occasioned by death, superannuation, or expulsion. This deed he caused to be enrolled in the High Court of Chancery in the year 1784. Thus the power of government which Mr. Wesley possessed during his life, by his appointment devolved upon the Conference after his decease, he having nominated its members, provided for its perpetuity, and defined its powers by the 'deed of declaration.' To prevent any abuse of this instrument on the part of the 'legal hundred,' Mr. Wesley left a letter, to be read by the Conference at its first assembling after his death, of which we subjoin an extract: 'I beseech you, by the mercies of God, that you never avail yourselves of the "deed of declaration" to assume any superiority over your brethren, but let all things go on, among those itinerants who choose to remain together, exactly in the same manner as when I was with you, so far as circumstances will permit. Have no respect of persons in stationing the preachers, in choosing children for Kingswood school, in disposing of the yearly contribution and the preachers' fund, or any other public money, but do all things with a single eye, as I have done from the beginning.' When this letter was read after Mr. Wesley's decease, the Conference unanimously resolved that all the preachers who are in full connection with them shall enjoy every privilege that the members of the Conference enjoy, agreeably to the above-written letter of our venerable deceased father in the Gospel. The Conference of the preachers of the Methodist societies is held annually in some one of the principal cities and towns in the kingdom. Representatives from the Irish Con-

ference, whose sittings precede the English Conference by a few weeks, regularly attend." See Jackson, *Centenary of Wesleyan Methodism*, 1889; Stevens, *History of Methodism*.

CONFERENCE, PASTORAL, a meeting of ministers for the discussion of questions relating to their pastoral duties. Many meetings of this name are regularly held in many countries, both within the Protestant and the Roman Catholic churches. Among the best known of the class in Europe belong the annual meetings of the ministers of the Protestant churches of France at Paris. See FRANCE.

CONFERENCE, ROMAN CATHOLIC, a meeting of priests for the discussion of religious and ecclesiastical topics. They are either convoked by the bishop of the diocese, or are held by priests of their own accord. Conferences are not mentioned before the 11th century. They seem to have had their origin in the large extent of the dioceses, which made the regular meetings of all the clergy of a diocese difficult. They consequently met in deaneries and archpresbyteries, under the presidency of the dean and archpriest. They were called *Calendas* because they were held on the first day of the month, or Chapters, Consistories, Synods, Sessions. They were common until the middle of the 18th century, when they fell into disuse. In the 16th century cardinal Charles Borromeo gave special regulations on these conferences, and ordered them to be held regularly. The same order was given by a number of French provincial synods. In 1720 they were declared by the congregation of the Council of Trent to be a proper substitute for diocesan synods. They have, however, never been in general use.—Wetzer u. Welte, *Kirchen-Lex.* ii, 766.

CONFERENCE, SAVOY, a series of meetings held by royal commission at the residence of the bishop of London, in the Savoy, in the year 1661, between the bishops and the Nonconformist ministers, in order so to review, alter, and reform the Liturgy as to meet the feelings of those who had serious scruples against its use, and thereby promote the peace of the Church. The individuals chosen comprehended the archbishop of York, with twelve bishops, on the one side, and eleven Nonconformist ministers on the other. Had the episcopal ministers entered into a fair and open discussion on the points at issue, reconciliation, to a certain extent, might have taken place; but as they were from the beginning averse from conceding a single iota to the Dissenters, the negotiation turned out a complete failure. At a convocation of the bishops, held almost immediately after, instead of removing anything that was at all likely to stumble tender consciences, they rendered the Liturgy still more objectionable by adding the story of Bel and the Dragon to the lessons taken from the Apocrypha.—Henderson's Buck, *Theol. Dict.* s. v.; Procter, *On Common Prayer*, ch. v; Neal, *History of the Puritans*, pt. iv, ch. 6.

Confessio Augustana. See AUGSBURG, CONFESSION OF.

Confessio Belgica. See BELGIC CONFESSION.

Confession. In the Church of Rome and in the Eastern churches the confession of sins is considered to be one of the seven sacraments. See AURICULAR CONFESSION. The law prescribing how often the member of the Church should go to confession was not uniform in all parts of the Church, some synods enjoining one, others two, others three confessions a year. Since the Council of Trent, the Church inflicts ecclesiastical censures only upon those who omit going to confession once a year. For nuns the Council of Trent prescribes a confession once a month. Priests are exhorted to go often to confession; some synods, like that of Ghent, enjoined upon them a weekly confession.

In the Middle Ages it was customary to pay a tax

to the priests (*summus confessionarius*) for hearing confession; but the demand for the abolition of this custom was so urgent that after the 16th century the payment of the tax was generally optional, and in this form it still exists in some Roman Catholic countries. Offerings of this kind remained also in use in many Lutheran churches until the present century, while the Reformed churches entirely abolished them.

The priest to whom a confession is made has the duty of observing with regard to it an absolute silence. No exception *whatever* is allowed to this rule. If a person makes communication to a priest of a crime which is still to be committed, the priest must try to change the mind of such a person, and induce him to do all that is possible to prevent its being committed by others, but he is not allowed to notify the secular government of it. In several countries (as Prussia) the civil law demanded in the latter case a notification, but the Church of Rome has always refused compliance with such a law. Luther, and the Church regulations in the Lutheran countries, also enjoined the strictest observance of the secret of confession.

Confession, AURICULAR. See AURICULAR.

CONFESSION OF FAITH, a collection of the articles of belief of any Church. See CREED.

1. *Their Use in the Church*.—(1.) The Protestant Confessions were the result of efforts, at the dawn of reviving toleration, to separate the Christian doctrines from the mass of corruption which ignorance, negligence, or artifice had conduced to accumulate around them, under an implicit obedience to the authority and domination of the Church of Rome.

(2.) Many persons altogether object to Creeds and Confessions of Faith on the ground that they infringe Christian liberty, supersede the Scriptures, exclude topics which ought not to be excluded, and admit such as ought not to be admitted; are often too particular and long; are liable to be abused; tempt men to hypocrisy; preclude improvement; and have been employed as means of persecution. It is said further "that confessional formularies, if they do not supersede the Word of God, are placed on a parity with it, and, to a wide extent, are of greater practical authority. Two consequences follow: the first is, that spiritual life is either altogether extinguished, or, where it exists, is so dwarfed and imprisoned that it has neither scope nor power of manifestation; and the second, that fellow-Christians who occupy a domain on the outside of the confessional pale are condemned as schismatics, and at the same time feared as if they were foes."

(3.) On the other hand, the arguments in favor of them are such as the following. All arts and sciences have been reduced to system, and why should not the truths of religion, which are of greater importance? A compendious view of the principal points of the Christian religion must be useful to inform the mind, as well as to hold forth to the world which are the sentiments of particular churches. They tend to discover the common friends of the same faith to each other, and to unite them together. The Scriptures countenance them. We have the moral law, the Lord's prayer, "the form of doctrine," mentioned by St. Paul (Rom. vi, 17), and "the form of sound words" (2 Tim. i, 13). Their becoming the occasion of hypocrisy is not the fault of the Confessions, but of those who subscribe them. If all Creeds and Confessions were expressed in the words of Scripture, this would set aside all exposition and interpretation, and would destroy all means of distinguishing the sentiments of one man from those of another (Farrar, s. v.). And to say that each individual is to interpret the Creeds by the Bible, and to hold and publish his own interpretation, without reference to that of the Church to which he may belong, "is not to exalt the Scriptures, but only to confound the uses of the Word

of God and the word of the Church. The one is at all times the ultimate appeal of every believer's conscience; the other is the interpretation of that appeal by the collective body of the Church. The Church does not first make a minister, and then tie him down to her articles; but the minister, professing to have been moved by the Holy Ghost, and demanding to exercise his office and to be intrusted with the cure of souls in the community to which he applies, is asked by the Church whether his individual interpretation of the Scripture accords with that of the collective mind of his brethren. If he cannot answer in the affirmative, it is evident that he must exercise his ministry elsewhere. A particular Church may be in the wrong, and an individual may be in the right; in which case there will arise controversy, and the Church, by the secession and opposition of individuals, may be led to modify and improve its theology. But this must be done by a collective act, and not by the insubordination of private clergymen filling the Church with various doctrines, and giving to its proclamation of the Gospel an uncertain sound. For, if it were otherwise, what heresy could be excluded?"

(4.) In the interpretation of Confessions there are some distinctions perpetually overlooked, some most important principles of interpretation but little attended to. For instance, sometimes the *private opinions* of the framers of formularies confessedly go beyond them; now these *private opinions* are sometimes appealed to as a proof that the formularies ought to be understood in that extended sense, whereas they prove the direct *contrary*. (See Archbishop Whately's *Kingdom of Christ*, sec. 24.) If, indeed, the writings of these framers contain indications of the *design* with which they were framed, this ought to be considered. For instance, articles, etc., framed manifestly on purpose to exclude certain Romish doctrines, as being so utterly unscriptural as to justify and enforce that separation from Rome which the Reformers deliberately resolved on, ought not to be interpreted so as to be consistent with these doctrines; not, however, because this would have been at variance with the *private opinions* of each Reformer separately, but because it would be at variance with their deliberate *public* declaration as a *body*. Again, there is a distinction to be observed between the interpretation (i) of anything put forth by an *individual* for the purpose of instructing others or explaining his own views, and (ii) of anything emanating from an *assembly*, the members of which could not be expected exactly to agree, not only in every shade of opinion, and the relative importance also of every point, but also in the degree of concession to be made to those before whom their declarations were to be put; e. g. an individual (unless a blunderer) will never make one part of his statement so far neutralize the other, that the whole effects no object which might not have been equally well obtained by omitting the whole, yet some public declarations drawn up by assemblies of sensible men may be expected to be such; the XVIIth 'Article' of the Church of England, for instance, is by many considered to contain nothing which might not have been attained by omitting it. In any such case, it may have been that a strong majority think it will be requisite to say something on the point; many may think that so and so ought to be said; and many others may object to this, unless some qualification be added, such as nearly to neutralize it. These principles of interpretation are incalculably important, and should be constantly remembered" (Eden, s. v.). See CREEDS.

II. *Confessions of different Churches*.—1. That of the *Greek Church*, entitled "The Confessions of the True and Genuine Faith," which was presented to Mohammed II in 1453, but which gave place to the "Orthodox Confession of the Catholic and Apostolic Greek Church," composed by Mogila, metropolitan of Kiev, in Russia, and approved in 1648 by the patriarchs of

Constantinople, Alexandria, Antioch, and Jerusalem. It contains the standard of the principles of the Russian-Greek Church. For the originals, see *Libri Symbolici ecclesie Orientalis*, ed. E. J. Kimmel (Jena, 1848, 8vo); Neale, *Hist. of the Eastern Church* (Lond. 1850, 2 vols.). See GREEK CHURCH.

2. The *Church of Rome*, though she has always received the Apostles', Nicene, and Athanasian creeds, had no fixed, public, and authoritative symbol till the Council of Trent. A summary of the doctrines contained in the canons of that council is given in the creed published by Pius IV (1564) in the form of a bull. It is introduced by the Nicene Creed, to which it adds twelve articles, comprising those doctrines which the Church of Rome finally adopted after her controversies with the Reformers. See CREED OF PIUS IV. Besides this creed, and the "Canons and Decrees of the Council of Trent," the Church of Rome acknowledges no symbolical books as authoritative. See TRENT, COUNCIL OF. The best editions are *Canon. et Decret. Concil. Trid.* (Lips. 1853, 8vo); Buckley, *Canons and Decrees of Trent* (Lond. 1851, 12mo); Donovan, *Catechism of the Council of Trent* (Balt. 8vo). See also Streitwolf, *Lib. Symb. Eccl. Cath.* (Gött. 1844), and the article TRENT.

3. The *Lutheran* books of faith and discipline are called *Libri Symbolici Ecclesie Evangelicae*. They contain the three creeds—Apostles', Nicene, and Athanasian [see CREEDS], the Augsburg Confession [see AUGSBURG], the "Apology" for that Confession by Melancthon, the Articles of Smalcald (q. v.) drawn up by Luther, the Catechisms of Luther, and in many churches the Form of Concord, or Book of Berg. See CONCORD. The Saxon, Württemberg, Swabian, Pomeranian, Mansfeldtian, and Copenhagen Confessions agree in general with the symbolical books of the Lutherans, but are authoritative only in the countries after which they are respectively called. There are many editions of the *Libri Symbolici*; the best and most convenient are those of Hase (3d edit. Leip. 1846, 12mo) and of Francke (*edit. stereot.* Leips. 1846, 12mo). See LUTHERAN CHURCH.

4. Of the *Calvinistic* Confessions the following are the principal: (1.) The four Helvetic Confessions—that of Basle, 1580; the Summary and Confession of the Helvetic churches, 1586; the *Expositio Simplex*, etc., 1566, ascribed to Bullinger; and the *Formula Consensus Helveticæ*, 1675. See HELVETIC. (2.) The Tetrapolitan Confession, 1581, which derives its name from four cities, Strasburg, Constance, Memmingen, and Lindau, by the deputies of which it was signed: it is attributed to Bucer. (3.) The Palatine or Heidelberg Catechism, framed by Ursinus and Olevianus, first published in 1568. See HEIDELBERG. (4.) The Confession of the Gallic churches, accepted at the first synod of the Reformed, held at Paris, 1559. See GAL-LICAN CONFESSION. (5.) The Confession of the Reformed churches in Belgium, drawn up in 1569, and approved in 1561. See BELGIC. (6.) The Confession of Faith of Scotland, allowed by the Estates in 1560, and subscribed by king James in 1561. (7.) The Westminster Confession. See WESTMINSTER. (8.) The Canons of the Synod of Dort. See DORT. See *Corpus Librorum Symbolicorum*, ed. J. C. G. Augusti (Elberfeld, 1827, 8vo); *Collectio Confessionum in eccles. reformatis*, edit. H. A. Niemeyer (Lipsiæ, 1840, 8vo, the most complete and convenient manual); Böckel, *Die Bekenntnisschriften der evangelisch-reformirten Kirche* (Leipz. 1847). The last-named work contains, besides all the Reformed Confessions of Faith (of Germany, Switzerland, France, Great Britain, Bohemia, Hungary, Poland, and the Netherlands), brief introductions and notes to each of them.

5. The *Anglican* Confession, or "Thirty-nine Articles of the Church of England," agreed on in the Convocation held in London, 1552. They were drawn up in Latin, but in 1571 they were revised, and subscribed

both in Latin and English. See ARTICLES, XXXIX; ENGLAND, CHURCH OF. They were adopted by the Protestant Episcopal Church in 1801, with some alterations, and the rejection of the Athanasian Creed. A selection from these forms the "Articles of the Methodist Episcopal Church." See ARTICLES, XXV; METHODIST EPISCOPAL.

The subject of "Confessions of Faith" is treated in Systematic Theology under the head of *Symbolism*, or *Symbolica*. The best special collections and textbooks, besides those already named, are: Marheineke, *Institutiones symbolicae doct. Cath., Prot., Socin., ecclesie Græcæ Minorumque Societ. Christian.* (Berlin, 1830, 3d ed. 8vo); Guericke, *Allgemeine chr. Symbolik* (Leips. 1846, 8vo); Winer, *Comparative Darstellung des Lehrbegriffs der verschiedenen christlichen Kirchenparteien* (Lips. 1837, 4to); Möhler, I. A. (Romanist), *Symbolism, or Exposition of the Doctrinal Differences betw. Cath. and Prot.* (New York, 1844, 8vo); *Corpus et Synagma Confessionum fidei* (Genev. 1654, 4to); Hall, *Harmony of Protestant Confessions* (London, 1844, 8vo); *Sylloge Confessionum, edit. auct.* (Oxon. 1827, 8vo). Very convenient manuals are Hahn, *Das Bekenntnis der evangelischen Kirche, in seinem Verhältnis zu d. römischen u. griechischen* (Lips. 1853, 12mo); Hofmann, *Symbolik* (1856, 8vo); Heurtley, *Harmonia Symbolica* (Oxford, 1858, 8vo).—Winer, *Theol. Lit.* xi; Hend. Buck, s. v.; Pelt, *Theol. Encyclopædia*, § 67; Hagenbach, *Theol. Encyclop.* § 76; Hill, *Divinity*, Am. ed., p. 761.

The general harmony of the Protestant Confessions has been shown in various publications. Bossuet's *Histoire des Variations des Eglises Protestantes* (1688) was written to show that the Protestant churches were wide asunder in points of faith; and Basnage's *Histoire de la Religion des Eglises Réformées* (Rott. 1726, 2 vols. 4to) affords a thorough refutation of Bossuet. The Assembly of Frankfort, 1577, entertained the question of a new Confession, which should be adopted by all, or nearly all, the Protestant bodies. A number of divines (among whom Beza, Salvat, and Daleau are named) accordingly drew up a *Harmonia Confessionum Fidei Orthodoxarum et Reformatarum Ecclesiarum*, etc. (Geneva, 1581, 4to). It embodies, under heads of doctrine, the following eleven Confessions: Augsburg, the Tetrapolitana, Basle, Helvetian, Saxony, Würtemberg, France, England, Helvetica posterior, Belgium, and Bohemia (see Niemeyer, *Præf. ad Coll. Confess.* v-ix). An English translation was immediately made, and published under the title, *An Harmony of the Confessions of Faith of Christian and Reformed Churches*, etc. (Camb. 1686, 12mo; London, 1648, 4to). A new edition of this very valuable work was published in 1842 by the Rev. P. Hall, with important prolegomena and additions (Lond. 1842; again 1844, 8vo). This edition gives also in an appendix, in English, the XXXIX Articles; the Westminster Confession of 1647; Usher's Articles adopted by the Convocation of the Episcopal Church in Ireland, 1615; and the Articles of the Synod of Dort.

Among minor works of this class we name Stuart, *The Scriptural Unity of Protestant Churches, exhibited in their published Confessions* (Dublin, 1835, 12mo); contains the XXXIX Articles, the Irish Articles, the Confession of the Church of Scotland, and a Declaration of Faith of the Congregational dissenters. Also Cumming, *Unity of Protestantism, being Articles of Religion from the Creeds of the Reformed Churches* (Lond. 1837, 8vo), which contains extracts from nine Confessions, arranged under heads. See Hall, *Harmony of Protestant Confessions* (Lond. 1842, 8vo). For the three oecumenical Confessions, see CREED, APOSTLES'; CREED, ATHANASIAN; CREED, NICENE.

CONFESSORIAL, the cell in which the Romish confessor sits to hear confessions. It is erected within the church, with a boarded back against the wall, or against a pillar or pier, and is divided into three niches. The centre, which is intended for the priest, is closed

half-way up by a dwarf door, and has a seat within it. There is a small grated aperture in each of the partitions between the priest and the side-cells, which are for those who come to confess. The earliest laws which give a prescription concerning the place where confession (q. v.) is to be made, provide that such places shall be open so that they may be seen by all. Nuns, according to a decree of the Synod of Paris of 825, must confess before the altar in the presence of witnesses not standing off very far. The first traces of confessorials as they are now in use in the Church of Rome are found in the second half of the 16th century, when several synods (Cosenza, 1579; Malfi, 1591) enjoined that every church should have as many confessorials and confessors (priests hearing confessions) as were necessary, which, however, should be so conspicuous that both the priest and the confessing person could be seen without difficulty by every one in the church.—Herzog, *Real-Encycl.* ii, 786.

CONFESSOR. (1.) In early ecclesiastical history the word is frequently used for martyr (q. v.), but its proper application was to those who, after having been tormented, were permitted to live and die in peace. At length it indicated those who, after having lived a good life, died under the reputation of sanctity. According to Cyprian, he who presented himself to torture, or even to martyrdom, without being called to it, was not designated a confessor, but a professor; and if any through want of courage abandoned his country, and became a voluntary exile for the sake of the faith, he was called *ex terris*. Later the title Confessor was applied to persons of eminently pious life as "witnessing a good confession." Edward of England was made "Confessor" by a bull of Alexander III. (2.) In the Romish Church, a confessor is an ordained priest who has power to hear sinners in the so-called sacrament of penance, and to give them "abolition." He is generally designated *confessorius*, to distinguish him from confessor. The confessors of the kings of France, from the time of Henry IV, were constantly Jesuits; before them, the Dominicans and Cordeliers shared the office between them. The confessors of the house of Austria have also ordinarily been Dominicans and Cordeliers, but the later emperors have taken Jesuits.—Hend. Buck; Mosheim, *Ch. Hist.* i, 54. See AURICULAR.

CONFIRMATION, a rite by which, in some Christian churches, baptized persons are fully admitted into the Church by the imposition of hands and prayer. The Churches which practise this ceremony profess to do it in imitation of apostolic example recorded in the New Testament. (1.) It appears from the Acts that the apostles laid hands only on baptized persons, as in the case of the converted Samaritans, Acts viii, 12-17, and the disciples at Ephesus, Acts xix, 5, 6. It is, however, evident that in those passages allusion is made to the miraculous gifts imparted by the apostles. It is said that "when Simen saw that through laying on of the apostles' hands the Holy Ghost was given, he offered them money, saying, Give me also this power, that on whomsoever I lay hands he may receive the Holy Ghost." Nothing is said of the laying on of hands in the baptism of the three thousand on the day of Pentecost (Acts ii, 38-42). Nor does the ceremony appear to have taken place at the baptism of Lydia and her household, Acts xvi, 15; or the Philippian jailer and his family, Acts xvi, 31-38. In Heb. vi, 2, mention is made of "the doctrine of the laying on of hands" immediately after that of "the doctrine of baptisms;" but there is no intimation that the two transactions were connected. The journey of St. Paul through Syria and Cilicia to confirm the churches does not necessarily imply the rite of confirmation as practised by the Church of England. These churches had been probably planted by himself at an earlier period, and he now gives them such regulations as are neces-

sary for their welfare, ordaining elders, imparting miraculous gifts, so important to the instruction of converts, and to the furnishing convincing evidences of the truth and power of the Gospel. The unction, or chrism, referred to in 1 John ii, 27, and 2 Cor. i, 21, has been supposed by some to refer to the ceremony of confirmation; it seems rather to relate to a spiritual anointing, to the royal and priestly dignity of Christians, or to the communication of extraordinary and miraculous gifts. (2.) As the practice cannot be traced to New-Testament authority, so neither do the earliest records of ecclesiastical antiquity contain any clear and certain testimony concerning it. Passages supposed to refer to this rite have been pointed out in the writings of Dionysius, in the Apostolical Constitutions, in Clement, and in Eusebius; but they rather relate to the sacrament of baptism. *Confirmation in connection with baptism* may be traced to the time of Tertullian, who informs us that the ceremonies of unction and the imposition of hands followed immediately after baptism. Cyprian refers to the subject of confirmation, and applies to it the word *sacramentum*; but it is evident, from the use of the term at the time in which he wrote, and from the scope of the passages in which it occurs, that *sacramentum* was not used in its strictly theological meaning, but simply in the sense of *ceremony*. Numerous references to later writers might be made to show the connection of baptism and confirmation. The baptism of adults being regarded as a solemn compact or covenant, confirmation followed as the seal by which the contract was ratified; and hence confirmation was administered, not by the person officiating, but by the bishop. At the stated baptismal seasons, the bishop was chiefly occupied with the rite of confirmation; but he sometimes commenced the whole solemnity by the baptism of a few individuals with his own hands. When baptism was administered in the absence of the bishop, confirmation was solemnized at some convenient season afterwards, either by the bishop or by his representative. Hence it followed that confirmation was often deferred until several years after baptism, especially in those dioceses which were seldom visited, either on account of their great extent, or the negligence or ignorance of the bishop. Even after the general introduction of infant baptism, confirmation immediately succeeded. In the Oriental churches, baptism, confirmation, and the Lord's Supper are administered in immediate succession; a probable evidence that such was the ancient custom. (3.) The permanent separation of confirmation from baptism is generally traced to the 13th century. The bishop was, for the most part, the ordinary minister. Several canons deny to the other orders of the clergy the right of confirming; but presbyters appear to have conferred imposition of hands, (a) in the absence of the bishop; or, (b) in the presence of the bishop, only by his express orders; or, (c) on the conversion of a reputed heretic, if such a one, desirous of being received into the church, was at the point of death while the bishop was absent. Deacons were on an equality with presbyters in this respect, until they were absolutely forbidden to administer this rite by the Council of Toledo, A. D. 400.

In the Latin Church, after the separation of confirmation from baptism, a series of preliminary religious exercises was requisite for this rite, similar to those which had been previously required for baptism. Names given in baptism were sometimes changed in confirmation. Sponsors were also required; and a separate edifice in some instances provided, called *consignatorium*, *albatorium*, and *chriamarium*. After the disuse of baptisteries, both baptism and confirmation were administered in the church (Farrar; Bingham, *Orig. Eccles.* bk. xii, ch. i, ii; Neander, *Ch. Hist.* i, 816).

Confirmation is a sacrament in the Romish and Greek churches. In the Greek Church confirmation is

administered at the same time with, or as soon as possible after, baptism, even in the case of infants, it being considered perilous to die without it; and in the Latin Church also it is often administered to young children—the Church of Rome not considering a person a “complete Christian” till he has partaken of this “sacrament.” To reconcile this opinion with the salvation of children who die after baptism but before confirmation, or “committing actual sin,” the Church of Rome has decided that they are confirmed by death, as they cannot sin afterwards. In England, five centuries ago, children were usually confirmed at the age of five years. The Council of Trent appointed from the age of seven to twelve; and a synod of Milan, in 1565, prohibited confirmation under seven years of age. The canon law fixes no time, but says “of perfect age,” which may be interpreted strictly or laxly. The earlier German Reformers rejected it even as a ceremony; but it was restored through the influence of Spener in the 17th century, and is now in use, as a renewal of the baptismal covenant, in the Reformed and Lutheran Churches. In the Church of England, and in the Protestant Episcopal Church, it is a formal rite, administered by the bishop. These churches direct that the child shall be confirmed “so soon as he can say the Creed, the Lord's Prayer, and the Ten Commandments in the vulgar tongue, and is further instructed in the Church Catechism set forth for that purpose.” Bishop Gibson, to elucidate the words “years of discretion,” in the Act 13, 14, Car. II, refers to Lyndwood's Gloss upon Archbishop Walter's Constitutions, which makes the proper age to be above seven and under fourteen. The ritualists and canonists of the English Church generally incline to a tender age. Thus, in reply to Bucer, who “finds fault with our Church for administering confirmation too soon,” and says that none ought to be confirmed “who have not had opportunity of giving sufficient testimonies of their faith and desire of living to God by their life and conversation,” Wheately argues that confirmation is administered “to assist them in manifesting their faith and practice, and is not to be deferred till these are already manifested.” The rite, he says, is to guard them against sin, before they are exposed to temptation, “that so the Holy Spirit may take early possession of their youthful hearts, and prevent those sins to which, without his assistance, the very tenderness of their age would be apt to expose them.” All that the Church demands, he adds, is “that they should understand the nature and advantages of the rite, and the obligations it lays upon them.” The High and Low Church differ as to the essence of confirmation, the latter regarding it as being essentially a personal renewal of the promises made in the name of the subject by others at baptism, while the High-Churchmen look upon it as a kind of sacramental rite for conveying the strengthening power of the Holy Ghost. Some High-Churchmen have therefore maintained that the Roman doctrine of the sacramental character of confirmation (as well as of all the other sacraments of the Church of Rome) may, in some sense, be accepted by the Anglican Church. It is connected with this difference of views as to the sacramental character of confirmation that the High-Churchmen generally urge an earlier (about five or six years) and the Low-Churchmen a later age (from fourteen to sixteen), for the performance of the rite. Their difference of opinion became the subject of an animated conference when, a few years ago, bishop Baring, of Durham, refused to confirm any children less than fourteen years of age. See Coleman, *Ancient Christianity*, ch. xx; Bangs, *Original Church*, p. 819 (N. Y. 12mo); Burnet, *Hist. of Engl. Reformation*, i, 466, 588; Wilson, *Bampton Lecture*, p. 260; Whately, *Infant Baptism*, p. 86; Schaff, *Apostolic Church*; Palmer, *On the Church*; Procter, *On Common Prayer*; Elliott, *Delimitation of Romanism*. See a list of treatises on catechumens and

confirmation in Volbeding's *Index Disertationum*, p. 144, 146.

Conflagration, GENERAL. The opinion that the end of the world is to be effected by the agency of fire is very ancient, and was common among heathen philosophers (Ovid, *Metamorph.* i, 256). Other testimonies are quoted by Grotius (*De Veritate Rel. Chr.* lib. i, § 22). It is not easy to discover the origin of this opinion; it can scarcely be traced to tradition derived from revelation, since there is no distinct reference to such a catastrophe in the Old Testament. It is, moreover, remarkable, considering how universal and definite is the ordinary belief on the subject, that there is only one passage in the New Testament, viz., 2 Pet. iii, 7-10, which can be adduced as speaking distinctly of this event. This passage is, indeed, very explicit, but some learned and able expositors have referred it altogether to the destruction of Jerusalem and of the Jewish polity. Among these are Dr. Lightfoot (*Hora Hebr.* in Joh. 21, 22) and Dr. John Owen (*Geology*, edit. Bremen, 1684, p. 147, quoted by Dr. Pye Smith, *Scripture and Geology*, sect. 6, p. 233, 1st ed.). If, however, with the majority of interpreters, we refer the prediction to the end of the world, to which it seems most naturally to apply, we could not have a more distinct statement of the fact that the present order of things is to be terminated by the world we inhabit and all the works of man it contains being "burnt up." There is no reason for assuming that the whole material universe is to be involved in this catastrophe; the mention of the heavens leads our thoughts no farther than the atmosphere and vapors surrounding this planet. Nor should we regard this conflagration as involving the absolute destruction or annihilation of the world; it is more consistent with the narrative itself, as well as with physical science, to consider it as introductory to a new and better state of things—"new heavens and a new earth wherein dwelleth righteousness" (ver. 11). By what means the conflagration is to be effected we are not informed, and all attempts to explain how this is to be accomplished must be mere speculation. We have only at present to remark that such an event is not inconsistent with physical facts. We know that the temperature of the earth increases gradually and with considerable regularity as we descend below the surface (Phillips, *Geology*, ii, 232), and we have every reason to believe that the central mass is intensely hot. We know, moreover, that there are subterranean fires of great extent, if not forming part of this heated central mass. The means, therefore, of combustion are near at hand. But even if there were no such central heat, chemistry points out very easy means by which the conflagration may be effected through the agency of various elementary substances (Phillips, *Geology*, ii, 211). We find evidence also in the pyrogenous rocks which form so large a part of the crust of the earth, that the world has already been subjected, if not to conflagration, yet to a more intense and general action of heat than any which is now observed on the surface of the earth; and it is clearly not impossible that the action may be yet more intense and more general. The example of the conflagration of a star in the constellation of the Northern Crown in May, 1866, by the sudden evolution of hydrogen gas, shows one way in which such a catastrophe might be produced (*Bibliotheca Sacra*, July, 1867, p. 478). In speculating on this subject, however, the caution of Calvin should not be disregarded, that the apostle is not speaking to gratify the speculations of the curious, but to add impressiveness to his pious exhortations (*Comm. in 2 Pet.* iii, 10).—Kitto, s. v.

Conformity strictly means, (1) the being reduced to the same shape with anything else; hence it has acquired the figurative sense of (2) agreement with any existing set of principles, or any institution; and has,

in a more limited and technical sense, been used for (3) compliance with the discipline of the Church of England. "Conformists" are therefore generally contrasted with "Nonconformists," a name which now includes generally all those who, either in doctrine or government, or both, dissent from the Church of England. A declaration is required of all persons who are to be licensed or instituted to an ecclesiastical charge in the Church of England in the following words: "I, A. B., do declare that I will conform to the Liturgy of the Church of England as it is now by law established." This declaration is to be made and subscribed before the bishop or his commissary, and the making and subscription thereof is to be testified under the episcopal seal of the bishop, and under the hand of the bishop or his commissary.—Eden, *Churchman's Theol. Dict.*; Hook, *Church Dict.*

Conformists. See CONFORMITY.

Confucius (Latinized by the Jesuit missionaries from Cong-fu-tse or Koong-foo-tse), a Chinese reformer and moralist, was born about 551 B.C. at the village of Tsen-se, in the small kingdom of Lu (now a part of the province of Shantung), and died B.C. 479. He is said to have been a descendant of the emperor Hoang-ti, who reigned B.C. 2600. When he was three years old his father died, but his mother trained him with great care, and was rewarded by the rapid progress and filial tenderness of her son. At seventeen he was called to public life as inspector of the grain-markets. He was married at nineteen, but, according to some accounts, subsequently divorced his wife (after she had borne him a son) in order to devote himself to the study of the ancient writings, and prepare for the work of restoring the usages and doctrines of the old sages. He was soon after promoted to the office of inspector general of agriculture. At twenty-four, having lost his mother, he resigned his public employments that he might pay the respect to her memory prescribed by the ancient traditions. During the three years passed in mourning he was a diligent student. China at that period was divided into a number of feudal kingdoms but slightly under the control of the central authority, whose constant quarrels filled the land with disorder, while the social and moral condition of the people had fallen so low that the ancestral religious rites were no longer observed. To restore the proper observance of these, rather than to introduce any new religious system, was the task to which Confucius determined to devote himself. About the age of thirty he began his public teachings, making journeys through the various states of China, instructing all ranks of the people, and gaining fame and disciples, though meeting often with opposition, and even persecution, in his efforts to reform the manners and better the condition of his countrymen. When fifty-five years old he re-entered public life as prime minister of his native kingdom, Lu, with opportunity and authority to test the efficacy of his proposed means of amelioration. In three years, it is said, he brought about a complete change in its social and moral condition. His success, however, excited the jealousy of neighboring princes, and through their intrigues he was obliged to flee to the north of China. After several unsuccessful efforts to obtain office and opportunities to teach the people, he retired to the kingdom of China, where he lived in great poverty. His doctrines, however, had taken root, but his rigid principles and practice made him many enemies. When full of years, in company with some chosen disciples, he retired from the world, that he might complete and arrange the works which, under the name of the *Ky* (or Books), constitute the sacred books of the Chinese, and, standing at the head of their literature, have for more than 2000 years been the recognized authority in moral and political conduct for nearly one third of the human race. Soon after the completion of these works:

he died, leaving a single descendant, his grandson, Tse-Tse, whose offspring, numbering A.D. 1671 about 11,000 males, mostly of the seventy-fourth generation, form a distinct caste in Chinese society, the only instance of a hereditary nobility among them. The veneration of the Chinese for Confucius amounts to worship, to which the second and third months are devoted. In every district and every department there is a temple erected in his honor (Culbertson, p. 41).

The Rev. Dr. Wentworth, Methodist Episcopal missionary at Fuh-Chau, gives an account of the worship as witnessed by himself in a temple in that city, from which we make the following extracts: "The temple is one of the finest buildings in the city. It is one storied, in the form of a hollow square, with a spacious court in the centre, apartments on each side, and the main temple at the end. It has a fine portico, and the roof within is sustained by columns of solid granite of enormous size. There are no idols, but ancestral tablets supply their places in the gilded shrines. In the centre is that of Confucius, on the sides are those of twelve of his most celebrated disciples, six on each side. The worship of the philosopher is monopolized by the literati; and the mandarins, who are literary graduates of the highest distinction, are the only priests who officiate upon the occasion. The sacrifice takes place twice a year, in the second and eighth months. It is performed before daylight in the morning, and the common people are rigidly excluded. We were an hour too early, but better than five minutes too late. The mandarins had not yet made their appearance. A burst of music indicated the coming of the magnates. Their first business was to get the 'whang-kee-angs,' 'foreign babies,' out of the sacred precincts, and a mandarin of high rank came to request us to go outside. We asked him to let us stand next one of the great doors on the portico outside. To this he consented. The platform was cleared and the ceremonies began. The darkness was dispelled by rows of gaudy lanterns and a forest of blazing torches. The court was filled with mandarins and their servants. Privileged spectators from the literary classes, with their attendants, crowded all the available space below. In front of the great central door of the temple, on the portico, was a band of musicians, with flutes and 'soft recorders,' and another of boys fantastically dressed. Within were musicians chanting vocally, accompanied by the instruments without, the praises of the sage. The loud voice of a crier within the temple, and the loud response of a herald below, indicated that all was ready. Clouds of incense filled the temple, while two or three mandarins, in full official dress and caps, preceded by attendants, ascended the steps and entered the lofty doors on either side, prostrating themselves with the head to the pavement before the shrines successively, and offering the various articles placed in their hands by the attendants for that purpose to Confucius and his favorite followers. This was repeated three times in succession, the officers retiring and re-entering with the same stately ceremony on each occasion. The offerings were animal and vegetable. On a broad table in front of the shrine and altar of Confucius lay shrouded the carcase of a whole ox, denuded of his skin, and on either side of him a pig and a goat. On the altar were vases of flowers and plates of cooked provisions. At one point in the ceremony an official kneeled before the shrine of Confucius at a respectful distance, and in a loud voice chanted a prayer or a hymn of praise. The ordinary chants were very simple, consisting of four notes perpetually repeated, thus:

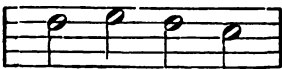

The last offering was material for clothing; a sort of

coarse silk, in large patches, first offered bodily in the temple, and then taken down into the court and burned, that it might become spirit-silk in the other world. The Buddhists usually offer ready-made clothing, stamped on paper. The mandarins send Confucius the raw material. About the first gray streakings of the dawn of a cloudy morning the ceremonies ended, the torches were suddenly extinguished, and the officers and their retinues slowly retired" (*Christian Advocate and Journal*, 1859).

"It was the great object of Confucius to regulate the manners of the people. He thought outward decorum the true emblem of excellence of heart; he therefore digested all the various ceremonies into one general code of rites, which was called Le-ke, or Ly-king, etc. In this work every ritual in all the relations of human life is strictly regulated, so that a true Chinese is a perfect automaton, put in motion by the regulations of the Ly-king. Some of the rites are most excellent: the duties towards parents, the respect due to superiors, the decorum in the behavior of common life, etc., speak highly in favor of Confucius; but his substituting ceremony for simplicity and true politeness is unpardonable. The Ly-king contains many excellent maxims and inculcates morality, but it has come to us in a mutilated state, with many interpolations" (Gutzlaff, *Sketch of Chinese History*).

In the writings of Confucius the duties of husbands towards their wives were slightly dwelt upon; the duties and implicit submission of children to their parents were most rigidly inculcated. Upon this wide principle of filial obedience the whole of his system; moral and political, is founded. A family is the prototype of the nation; and, instead of the notions of independence and equality among men, he enforces the principles of dependence and subordination—as of children to parents, the younger to the elder. By an easy fiction, the emperor stands as the father of all his subjects, and is thus entitled to their passive obedience; and, as Dr. Morrison observes, it is probably (he might say certainly) this feature of his doctrines which has made Confucius such a favorite with all the governments of China, whether of native or Tartar origin, for so many centuries. At the same time, it should be observed that this fundamental doctrine has rendered the Chinese people slavish, deceitful, and pusillanimous, and has fostered the growth of a national character that cannot be redeemed by gentleness of deportment and orderliness of conduct.

Confucius was a teacher of morals, but not the founder of a religion. His doctrines constitute rather a system of philosophy in the department of morals and politics than any particular religious faith (Davis). Arnauld and other writers have broadly asserted that he did not recognise the existence of a God (Bayle, *Dict. in art. Maldonat*). In his physics Confucius maintains that "out of nothing there cannot be produced anything; that material bodies must have existed from all eternity; that the cause or principle of things must have had a co-existence with the things themselves; that therefore this cause is also eternal, infinite, indestructible."

The system of Confucius is essentially ethical and political, and cannot be called a religion or a philosophy. He disclaims originality in doctrine. His object was to re-establish the ancient *cultus* of China, and to mould the manners of her people by minute regulations, embodying the usages of the past, and digested into one general code of rites (*Li-ki*), in which the proper ritual for all the relations of life is prescribed. To the influence of this code may be referred the automatic character of Chinese life. While many of his doctrines are deserving of high praise, and may justly claim to rank, in a moral point of view, above the ethics of Greece and Rome, they fall short of the elevation and ameliorating power of the Mosaic and Christian codes, which the encyclopædist writers of

the eighteenth century asserted were equalled, if not surpassed by them. To show the falsity of such statement, we need only contrast the results achieved by the development of the two systems, starting from what has been claimed to be cognate doctrinal bases. Founding his system upon the duty enjoined in the fifth commandment of the Decalogue, Confucius inculcates in such wise dependence and subordination, first of children to parents, then of citizens to the emperor, the representative father of the state, as to give to the imperial power that despotic cast which, while it has made him so great a favorite with all governments in China, native or Tartar, has nevertheless undoubtedly tended to check progress and make the people deceitful and pusillanimous, though the long-continued existence of their nationality vindicates the promise made by God of long life to those who honor their parents, for this injunction, it would seem, the Chinese obey beyond all nations of the earth. His celebrated maxim of negative reciprocity, "What you would not wish done to yourself, that do not to others" (*Anat.* xv, 28), fitly contrasts the immobile, selfish spirit of Confucianism, limited in its aims to China only, with the active reciprocity of Christ's golden rule, whose progressive spirit embraces all the world.

Whether Confucius recognised the existence of a personal God has been questioned, though the religious ceremonies observed by him, and certain expressions of his (*Anat.* iii, 18, and xiv, 18)—"He who offends against Heaven has none to whom he can pray," "But there is Heaven that knows me"—are urged as proofs that he did (see preface to the Amer. ed. of the recent translation by Dr. Legge). He maintained that *ex nihilo nihil fit*, and consequently that matter is eternal; that the cause or principle of things had a coexistence with the things themselves, and therefore also is eternal, infinite, indestructible, omnipotent, and omnipresent, having the blue firmament (Tien) as the central point; therefore offerings, particularly at the equinoxes, should be made to Tien. Neither Confucius nor his true followers have ever represented the Great First Cause by any image. "The images and idols of China belong to other faiths." The doctrine of the soul's immortality is implied in the worship paid to ancestors, and the absence of the word death from his philosophy. When a person dies, the Chinese say "he has returned to his family." The spirits of the good were, according to him, permitted to visit their ancient habitations on earth, or such ancestral halls or places as were appointed by their descendants, to receive homage and confer benefactions. Hence the duty of performing sacred rites in such places, under the penalty, in the case of those who, while living, neglect such duty, of their spiritual part being deprived after death of the supreme bliss flowing from the homage of descendants. The aim of the living should be the attainment of perfect virtue by the observance of the five fundamental laws of the relation between ruler and subject, parents and children, husband and wife, friends and brothers, and the practice of the five cardinal virtues—humanity, justice, order, rectitude, and sincerity, or good faith."

Of the five canonical books composing the King, three (I-King, Shi-King, and Shu-King) were compiled, and one (Chun-Tsien) was composed by Confucius, while one (Li-Ki) was compiled from his teachings by his disciples, and brought to its present form some centuries after him. The first (I-King, Book of Changes), assigned by tradition to the mythical emperor Fuhí (B.C. 2800) as its author, is "simply a number of figures made up of straight lines, entire and broken, variously put together in parallel arrangement," and which "are regarded as typifying the elements and processes of nature, and the great truths of the moral and intellectual world," and "expressing the earliest cosmical philosophy of the Chinese. To the brief early interpretation of these emblematic fig-

ures Confucius added a fuller one of his own." The second (Shi-King, Book of Songs) is a selection of 10 pieces of lyric poetry, relating to moral sentiments public and private affairs, as harvesting, marriage, etc., with praise of the good and censure of the wicked. The third and most important (Shu-King, Book of Annals) is a historical work, recording not only events, but the maxims, conversations, decrees, and insinuations of the sovereigns of ancient China, drawn confessedly from authentic sources, and coming down to about 200 years before Confucius. The fourth (Chun-Tsien, Spring and Autumn), composed by Confucius as a supplement to the third, records from memorial of his native kingdom Lu the events from Pingwang to B.C. 660. This is the only work coming directly from the hand of Confucius. The fifth (Li-Ki, Book of Rites) is a "compilation, brought into its present form some centuries after Confucius, and made up from material of very different age and character." It is a text-book especially of ceremonial and etiquette, in which the personal teachings of Confucius occupy an important place. His doctrines are also set forth in the Hiao-King (Filial Piety) by an anonymous writer, which contains apothegms of Confucius, collected during his conversations with his disciple Tsang-Tsan, and in the four Chinese classics termed *Sé-shu*, viz. (1) *Tahis* (Great Learning, or doctrine for adults), consisting of seven verses of text from Confucius, with ten chapters of commentary by Tsang; (2) *Chung-Yang* (the Doctrine of the Mean), by *Tsé-tse*, the grandson of Confucius; (3) *Lung-yu* (conversations—replies), conversations of Confucius, written by two disciples after his death; (4) the *Meng-tse-shu*, the work of his great disciple Meng-tsé (Mencius), who lived about B.C. 370, and ranks among the Chinese next to Confucius as moralist and philosopher. Dr. Legge is now publishing all the Chinese classics, giving original texts, versions, and literary apparatus. Four volumes have appeared (Hong Kong); see also his *Life and Teachings of Confucius* (Lond. 1867, Phila. 1867, 12mo); *Huc, Trav. in the Chinese Empire* (N. Y., Harpers, 2 vols. 12mo); *New-Englanders*, Feb. 7, 1859, p. 116-121; *Edinb. Rev.* April, 1856, p. 223-5 (Amer. ed.); *Quart. Rev.* xi, 832; *Culbertson, China, its Religions and Superstitions* (N. Y. 1857, 1 vol. 12mo); *Bibl. Sacra*, May, 1846, art. iii; *The Chinese Classics*, pt. i, *Confucius*, Worcester, Mass. (a translation of the *Analecta*, the *Great Learning* and the *Doctrine of the Mean*), taken from Dr. Legge's larger work; *Marshman, Works of Confucius* (Serampore, 1809, 4to); *Plath, Confucius u. seiner Schüler Leben u. Lehren* (Munich, 1867, vol. i); *Maurice, Religions of the World* (Lond. 1846); *Christ. Examiner*, Sept. 1858; *Hardwick, Christ and other Masters*, bk. iii, ch. i; *Loomis, Confucius and the Chinese Classics*, 1867; *Brit. Quart. Rev.* Jan. 1867. See *CHINA*.

CONFUSION OF TONGUES. See **TONGUES (CONFUSION OF)**.

Congé d'élire, a French term, signifying *leave to choose*. It is used in England to denote the king's writ or license to the dean and chapter of the diocese to choose a bishop in the time of vacancy of the see. Prior to the reign of Edward I the kings of England used to invest bishops with the ring and staff, in virtue of their donative right. Henry I so far ceded this right as to give a *congé d'élire* to deans and chapters for the election of bishops. Henry VIII added "letters missive," nominating the person whom he required them to elect, under pain of preemunure; and Edward VI (1 Edw. VI, c. 1, 2) abolished elections by writ of *congé d'élire*, but they were revived by queen Elizabeth. The *congé d'élire* is now a mere form, as the nominee of the crown is invariably chosen by the dean and chapter.

Congo, a country of Western Africa, extending from latitude 6° to 8° 20' S. It was discovered in 1482 by the Portuguese, who soon afterwards made settlements

and erected forts along its coast. A few years after, Dominican monks were sent there as missionaries, and in 1491 the prince of Congo was baptized under the name of Emanuel. The missionaries themselves, however, admit that the life of the prince after his baptism remained very licentious. His son, Alphonse I, who reigned fifty years, sent ambassadors to Rome, of whom several were ordained priests. The next king, Peter I, obtained for Congo a special bishop. The following kings remained, with the people, nominal adherents of the Church of Rome, but practically, in their opinions as well as their lives, they relapsed into the worst kind of fetishism. The efforts of Roman Catholic missionaries to introduce reforms have been fruitless. Congo is nominally still an Episcopal see, but at present united with the Portuguese diocese of Angola (q. v.). Some Roman Catholic writers (as P. Karl v. Heil, *Aloys, Jahrbuch d. Kirche*, Ratisbon, 1812) claim for the diocese of Congo a Roman Catholic population of 80,000, and for that of Angola of 800,000.—Wetzer u. Welte, *Kirchen-Lex.* ii, 784.

Congregatio de auxiliis divinæ gratiæ is the name given to a commission formed by pope Clement VIII in 1598, to examine Molina's (q. v.) book entitled *Concordia liberi arbitrii cum gratiæ*. This work had been the cause of great disputes between the Jesuits and the Dominicans, and it was hoped that the investigations of the commission would settle these difficulties. The *congregatio de auxiliis*, after three months, decided that the Jesuits were in the wrong in most of the controverted points. Instead of submitting to this decision, that powerful order managed to inveigle the civil authorities, and even kings and emperors, into the quarrel. After colloquies between the most celebrated theologians of the two parties had led to no result, in 1602 the pope ordered the controversy to be discussed in his own presence. These transactions lasted until 1606. The Dominicans still tried to show that the doctrines of Molina were Semipelagian errors, and the Jesuits charged their opponents with Calvinistic views. Pope Clement VIII, who personally sympathized with the views of the Dominicans, resolved to read the book himself, but before he could do so he died (1605). During the conclave following his death, every cardinal had to take an oath that if elected pope he would bring the controversy, as soon as possible, to a close. The new pope, Paul V, consequently dissolved in 1607 the congregation, and in an encyclica, addressed to the generals of the Jesuits and Dominicans, and which the latter had to communicate to all the provincials of the two orders, allowed both parties to retain, teach, and defend their opinions, and forbade them to charge the other party with heresy. This decision was confirmed by a constitution of Oct. 2, 1783. Soon after the dissolution of the congregation, the general of the Jesuits prescribed that in the schools of the order a somewhat modified form of Molina's views should be taught. As some of the Jesuit theologians maintained that Paul V had really condemned the views of Molina in a special constitution which the Jesuits had subsequently induced him not to publish, pope Innocent X in 1654 declared that such a constitution did not exist. Nevertheless, the accounts of the Dominican and Jesuit writers of the history of this congregation have never been harmonized.—Wetzer u. Welte, *Kirchen-Lex.* ii, 786.

Congregation (usually קְהִלָּה, *edah*, or perhaps more technically קְהִלָּה, *kahal*'), both often rendered "assembly;" Gr. ἐκκλησία or συναγωγή), a term that describes the Hebrew people in its collective capacity under its peculiar aspect as a holy community, held together by religious rather than political bonds. Sometimes it is used in a broad sense as inclusive of foreign settlers (Exod. xii, 19), but more properly as exclusively appropriate to the Hebrew element of the population (Num. xv, 15); in each case it expresses

the idea of the Roman *civitas* or the Greek πολιτεία. See ALIEN. Every circumcised Hebrew (קְהִלָּה; ἀπόχθων; *indigena*; A. V. "home-born," "born in the land," the term specially descriptive of the Israelite in opposition to the non-Israelite, Exod. xii, 19; Lev. xvi, 29; Num. ix, 14) was a member of the congregation, and took part in its proceedings probably from the time that he bore arms. It is important, however, to observe that he acquired no political rights in his individual capacity, but only as a member of a *house*; for the basis of the Hebrew polity was the house, whence was formed in an ascending scale the *family* or collection of houses, the *tribe* or collection of families, and the *congregation* or collection of tribes. See GOVERNMENT. Strangers (גֵּרִים) settled in the land, if circumcised, were, with certain exceptions (Deut. xxiii, 1 sq.), admitted to the privilege of citizenship, and are spoken of as members of the congregation in its more extended application (Exod. xii, 19; Num. ix, 14; xv, 15); it appears doubtful, however, whether they were represented in the congregation in its corporate capacity as a deliberative body, as they were not, strictly speaking, members of any house; their position probably resembled that of the *πρόξενoi* at Athens. The congregation occupied an important position under the Theocracy, as the *convocatio* or national Convention, invested with legislative and judicial powers. In this capacity it acted through a system of patriarchal representation, each house, family, and tribe being represented by its head or father. These delegates were named קְהִלָּה קְהִלָּה (Sept. *πρεσβύτεροι*; Vulg. *seniores*; A. V. "elders"), אֲבֵרֵם (ἀρχοντες; *principes*; "princes"), and sometimes קְהִלָּה (ἐπίκλητοι; *qui vocabantur*, Num. xvi, 2; A. V. "renowned," "famous"). See ELDER. The number of these representatives being inconveniently large for ordinary business, a farther selection was made by Moses of 70, who formed a species of standing committee (Num. xi, 16). Occasionally, indeed, the whole body of the people was assembled, the mode of summoning being by the sound of the two silver trumpets, and the place of meeting the door of the tabernacle, hence usually called the tabernacle of the *congregation* (בֵּית מִוֶּלֶךְ, lit. *place of meeting*) (Num. x, 8); the occasions of such general assemblies were solemn religious services (Exod. xii, 47; Num. xxv, 6; Joel ii, 15), or to receive new commandments (Exod. xix, 7, 8 [comp. Acts vii, 88]; Lev. viii, 4). The elders were summoned by the call of *one* trumpet (Num. x, 4), at the command of the supreme governor or the high-priest; they represented the whole congregation on various occasions of public interest (Exod. iii, 16; xii, 21; xvii, 5; xxiv, 1); they acted as a court of judicature in capital offences (Num. xv, 82; xxxv, 12), and were charged with the execution of the sentence (Lev. xxiv, 14; Num. xv, 85); they joined in certain of the sacrifices (Lev. iv, 14, 15); and they exercised the usual rights of sovereignty, such as declaring war, making peace, and concluding treaties (Josh. ix, 15). The people were strictly bound by the acts of their representatives, even in cases where they disapproved of them (Josh. ix, 18). After the occupation of the land of Canaan, the congregation was assembled only on matters of the highest importance. The delegates were summoned by messengers (2 Chron. xxx, 6) to such places as might be appointed, most frequently to Mizpeh (Judg. x, 17; xi, 11; xx, 1; 1 Sam. vii, 5; x, 17; 1 Macc. iii, 46); they came attended each with his band of retainers, so that the number assembled was very considerable (Judg. xx, 2 sq.). On one occasion we hear of the congregation being assembled for judicial purposes (Judg. xx); on other occasions for religious festivals (2 Chron. xxx, 5; xxxiv, 29) [see CONVOCATION]; on others for the election of kings, as Saul (1 Sam. x, 17), David (2 Sam. v, 1), Jeroboam

(1 Kings xii, 20), Joash (2 Kings xi, 19), Josiah (2 Kings xxi, 24), Jehoahaz (2 Kings xxiii, 80), and Uzziah (2 Chron. xxvi, 1). In the later periods of Jewish history the congregation was represented by the Sanhedrim; and the term synagogue (*συναγωγή*), which in the Sept. is applied exclusively to the congregation itself (for the place of meeting *בית מדרש* is invariably rendered *ἡ σκηνὴ τοῦ μαρτυρίου*, *tabernaculum testimonii*, the word *בית מדרש* being considered = *בית*), was transferred to the places of worship established by the Jews, wherever a certain number of families were collected.—Smith, s. v. See ASSEMBLY.

MOUNT OF THE CONGREGATION (*הַר בְּרִיטָה*, *mountain of the assembly*, Isa. xiv, 18 [14]; Sept. *ὄρος ἰσραήλ*, Vulg. *mons testamenti*), usually supposed to refer to Mount Moriah as the site of the Temple (comp. Isa. xxiii, 20). But the untenableness of this interpretation has long since been shown by Michaelis (*Biblioth. Orient.* v, 191). The name designates some place of religious ceremony among the Babylonians, and has hence been compared with the sacred hill of the gods (q. d. mount of their meeting), such as the *Alborj* named in the Zend-Avesta as situated in the north of the earth (comp. Rhode, *Heil. Sage*, p. 280 sq.). We may also compare with this the Mount *Olympus* of the Greek mythology, and the *Meru* of the Indian. Indeed all pagan systems seem to point to the north of the respective regions as the locality of the highest mountains, naturally assumed as the abode of the gods; possibly having a vague reference to the great Caucasian range (see Gesenius, *Jesa.* ii, 816 sq.; Rosenmüller, *Alterth.* I, i, 154 sq.; Henderson, *Comment.* in loc.). See MOUNT.

CONGREGATION, (1.) an assembly, or *gathering together* of persons, more particularly for divine service. This word is used, in the Rubrics of the Church of England, in the same sense as "people" is used, to mean that portion of the Church of the nation who are assembled in any one sacred edifice for the purposes of worship (Eden).

(2.) *Monastic Congregations.*—(a) In a wider sense, all ecclesiastical associations of laymen in the Roman Catholic Church, for contemplative, ascetic, or practical purposes, are called congregations. (b) In a more special sense, *ecclesiastical congregations* are associations which, like monastic orders, lead a common life, and are bound by vows. They differ from the monastic orders by not demanding from their members the vow of poverty, by binding them to less stringent or to no rules of retirement from the world, and frequently by prescribing only the *simple* vow of chastity (see Vow). The number of congregations of this class is very large; among them are the Oratorians, the Priests of the Mission, the Doctrinarians, the Piarists, the Brothers of the Christian Schools, the Mechitarists, Redemptorists, all of which are treated of in special articles. (c) The name is also applied to several branches of reformed Benedictines. In these "congregations" each monastery has its own abbot or prior, but all were subordinate to the head of the chief abbey. The most noted of these congregations were those of Clugny, Vallambrosa, Camaldoli, the Cistercians, Carthusians, and Maurines (see these articles).

(8.) *In Ecumenical Synods.*—At the Ecumenical Synod of Constance, it was resolved to take the vote, not by heads, but by nations, of which there were at first four (German, French, Italian, English), and subsequently five (Spanish). Each nation was to cast one vote. In order to establish the vote of a nation, its members held separate sessions, which were called "congregations." In these congregations, every member, without distinction of rank, had an equal vote. When the vote of each congregation had been established, all the congregations met as a *general congregation*, and the resolutions, for which a majority of

the nation voted, were declared the Resolutions of the Ecumenical Council. See WETZER u. WELTE, *Kirchen-Lex.* ii, 794.

(4.) *Congregation of Cardinals.*—A committee of cardinals, prelates, and others, met for the dispatch of some particular business, and deriving its name from the particular business it has to dispatch. The following account will be found to include the names of the chief of these congregations, and the particular business of each:

1. *The Consistorial Congregation*, instituted in 1586 by Sixtus V. They prepare the most difficult beneficial matters, afterwards debated in the Consistory in the presence of the pope. Such matters are the approbation of new religious orders; the erection of new episcopal sees; the separation, union, or suppression of benefices of the higher grade; the examination of newly-appointed or elected bishops; the appointment of coadjutors. The number of cardinals is not fixed.

2. *The Congregation of the Holy Office, or Inquisition*, instituted in 1542 by Paul III, at the desire of cardinal Caraffa, who afterwards became Paul IV. The privileges were enlarged by the addition of statutes by Sixtus V, by which this tribunal became so formidable that the Italians were accustomed to say, "Pope Sixtus would not pardon Christ himself." It takes cognizance of heresies and all novel opinions, as well as of apostasy, magic, witchcraft, abuse of the sacraments, and the circulation of pernicious books. The pope himself is prefect of this congregation. It consists of 12 cardinals, a number of theologians and canonists as "consultors," of several "qualificators" who give their opinion in special cases, of a defender of the accused, and several other persons. See INQUISITION.

3. *The Congregation de Propaganda Fide*, instituted by Gregory XV in 1622, consists of 24 cardinals, one of the secretaries of state, an apostolical protonotary, a referendary, an assistant or lateral judge, and the secretary of the Holy Office. See PROPAGANDA.

4. *The Congregation of the Council*, for explaining the Council of Trent. When the council closed its sessions, Pius IV deputed certain cardinals, who had assisted in it, to put an end to all doubts which might arise concerning its decrees. This congregation meets once a week. "Its decisions from 1739 to 1843 fill 103 vols. 4to." The prefect is chosen by the pope, and has a salary.

5. *The Congregation of the Index*, instituted in 1570 by Pius V. This committee is deputed to examine all books. It is composed of several cardinals, and has a secretary of the order of Dominic. The pope generally presides himself.

6. *The Congregation of Ecclesiastical Immunity*. This was established by Urban VIII in order to obviate the disputes which arose in the judgment of such suits as were carried on against churchmen for various matters, whether criminal or civil.

7. *The Congregation of Bishops and Regulars*. Sixtus V, in the beginning of his pontificate, united two congregations under this name. It has power to regulate all disputes arising between bishops and regular or monastic orders.

8. *The Congregation for the Election, Examination, and Residence of Bishops*. This was instituted by Clement VIII, to examine into the qualifications of all such churchmen as are nominated to bishoprics. The examiners are chosen by the pope. It has the power of enjoining or dispensing with the residence of bishops, and obliging all abbots to reside in their several communities.

9. *The Congregation of Religious Discipline*. This has the right to inquire into the state of Italian monasteries, and to suppress those whose temporalities are so far diminished that the remainder is not sufficient for the maintenance of six monks.

10. *The Congregation of Apostolical Visitation*. Its

business is to visit, in the name of the pope, the six bishoprics, suffragans to the metropolis of Rome.

11. *The Congregation of Indulgences and Sacred Relics*, instituted in 1689 by Clement IX. Its business is to superintend the relics of ancient martyrs, which are frequently said to be found in catacombs and other subterranean places in Rome, and to distinguish their bones, shrines, and tombs from those of the heathen. After the congregation has pronounced sentence on the validity of any relics, they are consigned to the cardinal-vicar and the pope's sacristan, who distributes them to applicants. This congregation also investigates the causes and motives of those who sue for indulgences. The registrar sends the minutes and conclusions of petitions to the secretary of briefs, who dispatches them under the fisherman's seal.

12. *The Congregation of Sacred Rites*. Sixtus V founded this congregation to regulate all matters relating to ceremonies and rites in worship, and especially to take the chief part in the canonization of saints. It has authority to explain the rubrics of the Mass-Book and the Breviary when any difficulties are started in relation thereto.

13. *The Congregation of the Reverend Fabric of St. Peter*. This was founded to superintend the building of St. Peter's, and is now employed in repairing and beautifying it. This congregation has the peculiar privilege of altering the last wills of those who bequeath money to pious uses, and to apply it to the support of the fabric of St. Peter's.

14. *The Congregation of the Sacred Consulta*. This has supreme civil and criminal jurisdiction over the subjects of the papal states. It was instituted by that famous founder of congregations, Sixtus V.

15. *The Congregation of Good Government*. This watches over the conduct of the magistrates throughout the states, and works in concert with the *Consulta*.

16. *The Congregation of Prisons*. This consists of the governor of the city, and other ecclesiastics bearing civic and judiciary offices. They dispose of cases relating to the numerous occupants of secret prisons, galleys, etc., etc., having under their jurisdiction all that are in legal bonds; the sufferers in the Inquisition and in the monasteries excepted, whom it is not within their province to visit, pity, or release.—Farar, *Ecccl. Dict.* s. v.; Herzog, *Real-Encyklop.* ii, 677; Broughton, *Bibliotheca Historico-Sacra* (London, 1737, vol. i); Meier, *Die heutige römische Curie* in Jacobson, *Zeitschrift f. d. Recht*, 1847, ii; Wetzler u. Welte, *Kirchen-Lex.* ii, 344.

CONGREGATION, LORDS OF THE, a title given, in Scottish Church History, to the chief nobles and gentlemen who signed the Covenant of December 8, 1557. From the frequent recurrence of the word congregation in the document, the adherents were called "the Congregation," and the chief signers (such as the earls of Argyle, Glencairn, and Morton, the Lord of Lorn, Erskine of Dun, etc.) were styled "Lords of the Congregation."—Hetherington, *History of the Church of Scotland*, chap. ii.

Congregational Lectures, a series of lectures delivered in London by Congregational ministers of Great Britain from year to year. The following courses have been published: 1833, *Christian Ethics*, by Rev. Ralph Wardlaw, D.D.; 1834, *The Causes of the Corruption of Christianity*, by Rev. Robert Vaughan, D.D.; 1835, *The Christian Atonement*, by Rev. Joseph Gilbert; 1836, *Divine Inspiration*, by Rev. Ebenezer Henderson, D.D.; 1837, *Holy Scripture Verified*, by Rev. George Redford, D.D., LL.D.; 1839, *Revelation and Geology*, by Rev. John Pye Smith, D.D., LL.D., etc.; 1840, *The Connection and Doctrinal Harmony of the Old and New Testaments*, by Rev. William Lindsay Alexander, D.D.; 1841, *The Theology of the early Christian Church*, by Rev. James Bennett, D.D.; 1843, *The Existence and Agency of Evil Spirits*, by Rev.

Walter Scott; 1844, *The Sacraments (Part I, Baptism)*, by Rev. Robert Halley, D.D.; 1845, *The Doctrine of Original Sin*, by Rev. George Payne, LL.D.; 1847, *The Revealed Doctrine of Rewards and Punishments*, by Rev. Richard Winter Hamilton, D.D., LL.D.; 1848, *The Ecclesiastical Polity of the New Testament unfolded*, by Rev. Samuel Davidson, LL.D.; 1849, *The Work of the Holy Spirit*, by Rev. William Hendry Stowell, D.D.; 1850, *The Sacraments (Part II, the Lord's Supper)*, by Rev. Robert Halley, D.D.; 1853, *Psychology and Theology*, by Rev. Richard Alliot, LL.D.; 1855, *Agees of Christendom before the Reformation*, by Rev. John Stoughton; 1858, *Christian Faith*, by Rev. John H. Godwin; 1860, *The Divine Covenants, their Nature and Design*, by Rev. John Kelly. The course is now (1867) temporarily suspended.

Congregationalists, a denomination of Christians (generally Calvinistic in theology) holding to a system of church government which embraces these two fundamental principles, viz., (1) that every local congregation of believers, united for worship, sacraments, and discipline, is a complete church, and not to be subject in government to any ecclesiastical authority outside of itself; and (2) that all such local churches are in communion one with another, and bound to fulfil all the duties involved in such fellowship. The system is distinguished from Presbyterianism by the first, and from Independency by the second. It involves the equal right of all brethren to vote in all ecclesiastical affairs; and the parity of all ministers, the ministers being set apart by the churches, and not possessed of any power of government as ministers, but only of official power in the churches by which they may be chosen pastors. In England they are often, but not quite accurately, styled Independents. Several denominations in the United States are congregational in practice, but bear other names than that of the denomination known distinctly as "The Congregational Churches of the United States."

I. HISTORY.—Congregationalists claim that their system is only a substantial return to the order and practice of the apostolic churches, which had been corrupted by the tendencies that culminated in the papacy; and that traces of dissent from the episcopal power are found in every age (see Punchard's *History of Congregationalism*). The origin of modern congregationalism is seen in the early stages of the reformation in England. From the beginning of the protest against Romanism, some of the main distinctive views afterwards developed into Congregationalism, especially the identity of "bishop" and "presbyter," and the independent right of each congregation to choose its pastor and exercise discipline, found decided adherents. While Henry VIII, after throwing off the Romish supremacy, clung in the main to the Romish theology, and in part to the Romish polity and practices, the progress of thought continued in the opposite direction. When the reforms carried on by Edward VI were peremptorily stopped by Mary, dissenting congregations, in substance Congregational, came immediately, though privately, into existence in various places, as in London in 1555. Their existence is learned almost entirely from the persecutions to which their members were subjected, and but few particulars in their history are preserved. Among the Congregational martyrs were Barrowe, Greenwood, and Penry, executed in 1593. Of the Congregational church formed in London in 1592, of which Francis Johnson was pastor, and John Greenwood teacher, fifty-six members were seized and imprisoned. Many of them eventually found their way to Amsterdam, where they reorganized under the same pastor. Robert Brown's publication, in 1682, of "A Book which showeth the Life and Manners of all true Christians," etc., presents the earliest full development of the Independent side of Congregationalism. While at first only Puritans, many became Separatists,

in despair of securing complete reformation in the Church of England. About 1602 a church was organized at Gainesborough, in Lincolnshire, Rev. John Smyth pastor. In 1606 another was formed at Scrooby, Nottinghamshire, Richard Clyfton pastor, which met at the house of William Brewster. Of that church John Robinson was a member, and afterwards associate pastor. In 1606 Mr. Smyth and his friends removed to Amsterdam. In 1607 Mr. Clyfton and many of his church, after great persecution, also escaped to Amsterdam, and in 1608 most of the remaining members of the Scrooby church followed. After about a year the church removed to Leyden. Owing to the disadvantages of residing in a country of different language and customs from their own, they resolved to emigrate to America, and a portion of the Leyden church, with elder William Brewster, after many trials landed at Plymouth, Massachusetts, Dec. 21, 1620 (N. S.), while Robinson, with a part of the church, remained at Leyden. In 1616 a Congregational church was established at Southwark, London, under the care of Henry Jacob, who had been confirmed in Congregational views by conference with John Robinson at Leyden. This church, organized after Mr. Jacob had conferred with leading Puritans, probably gathered together some of the scattered members of Mr. Johnson's church. Though sometimes called "the first Independent church in England," there had been the secret congregations in the reign of Mary, and the churches of Gainesborough and Scrooby, and, it is said, one at Duckenfield, Cheshire Co. About 1624 Rev. John Lathrop became pastor of the Southwark church; he was, in 1632, imprisoned, with forty-one other of its members. In 1634 Mr. Lathrop, obtaining release, removed to America, with about thirty of his flock, and in that year organized the church in Scituate, Mass., where he continued until 1639, when the majority removed to West Barnstable, where that church is still existing.

1. *American Congregationalists.*—The Plymouth settlement was distinct in origin and government from that of Massachusetts Bay, the Pilgrim settlers being distinctively known as "the Pilgrims." The persecutions under Laud led many Puritans to the resolution to emigrate. Endicott and his company began the colony at Salem in 1628, and in 1630 John Winthrop, their governor, with other emigrants, occupied Boston and the surrounding towns. Settlements were made at Hartford and Saybrook, in Connecticut, in 1635, and in 1638 Davenport and his associates founded the New Haven colony, while in 1638 a distinct company re-enforced the colonies on the Piscataqua River. The Plymouth church had come out fully organized; in the other settlements churches were immediately formed. None but the Plymouth people had come over as Separatists; the others declared that they did not separate from the Church of England, but only desired to remove its corruptions. But, gathered in a new land, away from all ecclesiastical establishments, and searching the Scriptures for their ecclesiastical order, they all fell into the Congregational order. Their ministers had almost all been regularly ordained in the Church of England, and were highly educated men, as (e. g.) Cotton and Wilson, of Boston; Mather, of Dorchester; Hooker and Stone, of Hartford; Davenport and Hooke, of New Haven.

Congregationalism proper received substantially its form in the early history of New England. If traced to the writings of any one person, it would be to those of John Robinson, of Leyden; those of John Cotton and Thomas Hooker, in America, being next in importance. Robert Brown was never acknowledged as a leader, he being a strict Independent, and finally returning to the communion of the Church of England; but his writings undoubtedly aroused many minds to examine and reject the claims of episcopacy. The system cannot, however, be traced to any one

man, but rather to the united sentiments of the early emigrants, who agreed in carrying into practice the opinion that every church is, according to the Scriptures, confined to the limits of a single congregation, and must be democratic in government; while all churches are in fellowship with one another. Hence the term "the Congregational Church" is never used to denote the denomination, but "the Congregational churches."

Church and State.—From the earliest settlement of New England there was a definite but peculiar relation between the churches and the state. It was neither that in which the State rules the Church, nor that in which the Church rules the State, but rather a peculiar blending of the two. Townships were incorporated with a view to the ability to maintain a settled ministry, and to the convenience of the people in attending public worship. Provision was made by law for the support of pastors, and for all necessary expenses. The choice of a pastor belonged to the church. A peculiar feature of the connection was established in 1631, in Massachusetts Bay, and later (in substance) in the Connecticut colonies, and, by the authority of Massachusetts, in Maine and New Hampshire, that "no man shall be admitted to the freedom of the body politic but such as are members of some of the churches within the limits of the same." This was in no respect a principle of Congregationalism, but grew out of the objects of the emigration from England. As the population increased the rule was modified, and by-and-by abandoned. Ministers, although their influence was great, had no voice as ministers in public affairs. The laws taxing all persons for the support of the ministry were first ameliorated by allowing persons to contribute to whatever church they might prefer; and the whole system of compulsory taxation was abolished in Connecticut in 1816, and in Massachusetts in 1838.

General Synods.—The history of the denomination is rather the history of distinct churches than of an organized body. Yet the fellowship of the churches has always been maintained, and all "matters of common concernment" have been decided by the common consent of the whole body, and sometimes embodied in the pronounced opinions of general bodies convened for the special occasion. Denying the authority of any standing judicatory, Congregationalists recognize the necessity and desirableness of occasional synods for deliberation and advice on great public interests. Only four such general synods have been held. The first met in 1637, at Cambridge, Mass., to deliberate on the doctrinal speculations of John Wheelwright, Anne Hutchinson, and others. It consisted of "all the teaching elders through the country" and of "messengers from the churches;" Rev. Peter Bulkley, of Concord, Mass., and Rev. Thomas Hooker, of Hartford, Conn., were moderators. The second synod met at Cambridge in 1646, and dissolved in 1648. It declared its approval of the Westminster Assembly's Confession of Faith, and set forth an elaborate statement of Church polity, known as the "Cambridge Platform," which has always—though latterly with modifications—been regarded as an important standard. The third synod, or "Convention," met at Albany, N. Y., in 1852, composed, like the preceding, of pastor and delegate from each church. Its main business resulted in the formal dissolution of the "Plan of Union between Presbyterians and Congregationalists" agreed upon by the Presbyterian Church and the General Association of Connecticut in 1801. The fourth synod, styled "National Council," met in Boston, Mass., in 1865, composed of a minister and delegate from every group of ten churches; William A. Buckingham, governor of Connecticut, was its moderator. It was called to deliberate upon the exigencies of religious duty growing out of the circumstances of the country in its emerging from the war of 1861-5.

Among its important acts were a Declaration of Faith and a revised Platform of Church Polity. Partial synods of importance have been held—of Massachusetts in 1662, which recommended the disastrous, and now long since abandoned "Half-way Covenant," by which baptized persons might "own the covenant" of the Church, but without coming into full communion;—of Massachusetts in 1679-80, called the "Reforming Synod;" that synod readopted, with some alterations, the Confession agreed upon by the Congregational Synod which met at the Savoy, in London, in 1658, which was itself that of the Westminster Confession, with slight alterations, the variations of the three documents being carefully shown in the *Congregational Quarterly*, Boston, 1866;—and the Synod of Connecticut, which met at Saybrook in 1708, and framed the "Saybrook Platform" of Discipline, which established the "consociation" system in that state. All of these synods disclaimed authority over the churches to impose either a platform of polity or a creed; they declared only what were the sentiments and usages of the churches in their understanding of the Scriptures.

Other Organizations.—In each state and territory where Congregationalists exist in sufficient numbers, there have been formed General Associations or Conferences, which are without any ecclesiastical authority, and not allowed to hear causes or give advice in any ecclesiastical affairs. All are now composed of both ministers and lay delegates, except the General Associations of Massachusetts and Connecticut, which are purely bodies of ministers; but that of Massachusetts voted unanimously in 1866 to unite with the Conference of the same state, and admit laymen. The General Conference of Maine, where the "Conference" (including laymen) system originated, was organized in 1826; New Hampshire, 1809; Vermont, 1796; Massachusetts, Association in 1803, Conference in 1860; Rhode Island, 1809; Connecticut, 1709; New York, 1834; Ohio, 1852; Indiana, 1858; Illinois, 1848; Michigan, 1852; Wisconsin, 1840; Minnesota, 1855; Iowa, 1840; Missouri, 1865; Nebraska, 1867; Kansas, 1855; Oregon, 1858; California, 1857; Canada, 1858; Nova Scotia and New Brunswick, 1847. These bodies all held annual meetings. In addition, a "Convention" of the Congregational ministers of Massachusetts has met annually since near the beginning of the 18th century, of which Unitarians are a component part, which holds funds, mainly contributed before the division, for the relief of widows and orphans of ministers of either denomination. A "Triennial Convention of the Northwest" was formed in 1858, mainly to supervise the affairs of the Chicago Theological Seminary. Local Conferences of churches covering groups of (usually) from ten to thirty churches have been voluntarily formed, and embrace nearly all the churches: they generally meet semi-annually for religious conference, and are denied every power of jurisdiction. Nearly all the ministers are grouped in local associations of convenient size for purposes of mutual improvement, but with no ecclesiastical authority; but the churches look to them to examine and recommend candidates for the ministry. These associations began in the 17th century. "Ecclesiastical Councils" are occasional bodies, which will be noticed under "government."

"Plan of Union" with Presbyterians.—Congregationalists and Presbyterians, holding the same doctrinal views, have always had more or less intimate relations. When Western New York and the territories beyond were becoming rapidly settled, a formal "Plan of Union" was adopted by the Presbyterian General Assembly and the General Association of Connecticut in 1801. To prevent division into small and weak churches, it was arranged that Congregationalists and Presbyterians in any locality could unite in one church, its character to be settled by the majority; and, if

Congregational, the church could, while retaining power of internal government, hold a qualified relation to Presbyteries. The result was that large numbers of Congregationalists and of Congregational churches were finally absorbed in the Presbyterian Church. The Plan grew into disfavor, and was abrogated by the Congregational Convention of 1852. Many churches which still hold that abnormal relation are now dropped from the Congregational statistics.

Unitarianism.—Owing to various causes—particularly the "Half-way Covenant," the connection of Church and State, and opposition to the great revivals of the middle of the 18th century—there grew up in some of the churches a dislike to the doctrines of the denomination, which developed itself into Unitarianism. The first church to become such, however, was the Episcopal church of King's Chapel, Boston. Sharp controversy ensued, which resulted in an entire separation. The division was going on from about 1810 to 1825 by the steady withdrawal of fellowship from the churches and ministers which had become Unitarian. The change of doctrine was chiefly confined to Massachusetts, and, in a great degree, to Boston and vicinity. In 1825 there were found to be 95 Unitarian churches (a part of which were new churches organized as such), and 310 Congregational; while in the other states the defection was hardly known. Many churches were deprived of their property by adverse majorities in parishes, and were forced to begin anew. The trials of the churches awakened a vigorous life in the denomination, which added 146 new churches in Massachusetts in the following 25 years, and increased the number of communicants from 37,987 in 1830 to 64,830 in 1850. The terms "Unitarian Congregational" and "Trinitarian Congregational" have been sometimes used in Massachusetts; but the latter title has never been allowed by the denomination, while the Unitarian National Conference has refused to insert the term "Congregational" in its official name.

Benevolent and Missionary Operations.—In the earliest history of American Congregationalism efforts were directed to the conversion of the Indians, of which the work of John Eliot is the most noted. Later, when the country became settled westward, missionary societies, of which those of Connecticut were perhaps most important, sent ministers to the new settlements of New York, Ohio, etc. In 1825 an American Home Missionary Society was suggested by Congregationalists, and was organized to embrace the several state societies and the Presbyterians. In Home Missions, the efforts of the denomination have been made through this channel, which has now really become Congregational by the withdrawal of the Presbyterians since 1860. Foreign Missions have been carried on through the American Board of Commissioners for Foreign Missions, which was formed by the General Association of Massachusetts in 1810, but through which the New School Presbyterian Church also does its mission work. An impetus was given to assisting Congregational churches in building meeting-houses by the Albany Convention, under whose recommendation a large amount was immediately raised. That work is successfully carried on by the American Congregational Union, which was organized at New York in 1858. The American Congregational Association has collected a fine and rapidly-increasing Congregational Library in Boston, and a large fund to be devoted to the erection of a Congregational House. Large amounts of money have been collected through co-operative societies for ministerial education, Sabbath-schools, tract and other religious publications, seamen, temperance, education at the West, etc. The denomination, from its polity, has no Church Boards. Its benevolent operations have been carried on through such channels as the churches preferred. The National Council, in 1865, recommended the American Board, the American Home Missionary Society, the American Missionary Association, the

American Education Society, the Society for promoting Collegiate and Theological Education at the West, the American Bible Society, the American and Foreign Christian Union, the Congregational Board of Publication, the American Congregational Association, the Massachusetts Sabbath-school Society, and the objects of the American Tract Societies. While co-operation is still adhered to, there is an evident drift in the denomination towards separate methods of work, due undoubtedly to an increasing conviction of the scripturalness, importance, and efficacy of the denominational polity.

Progress.—The denomination, while always predominant in New England, was retarded in its growth beyond the Hudson River partly by the "Plan of Union," and partly by the advice of theological instructors to their pupils going westward to become Presbyterians. The result has been that the Congregational churches have given a large number of ministers to the Presbyterian Church, and furnished the material of many of its churches. Not a few of the early New York churches became Presbyterian, and Congregational associations were disbanded lest they should interfere with harmony. But the gradual increase of ministers who, removing to the West, refused to give up their ecclesiastical fellowship, and a growing conviction that the Congregational polity demanded its own preservation, has changed the current. The oldest church in Ohio was founded in 1796; in 1866 the number was 166. Commencing in Illinois about 1830, the churches numbered in 1866, 221. Commencing in Michigan about 1827, the number in 1866 was 150. The oldest in Minnesota dates from 1851; in 1866 there were 58. In Iowa, from the first in 1839, the number increased to 166 in 1866. In Missouri, from 2 in 1864, they increased to 41 in 1867. In Kansas, from 1 in 1854, to 83 in 1866. In California, from 10 in 1859 to 82 in 1866. In the Southern States the denomination had no foothold prior to the war of 1861-5; but beginnings have since been made in Delaware, Maryland, the District of Columbia, North and South Carolina, Louisiana, and Tennessee; and Congregationalists have planted the first church, other than Mormon, in Utah.

2. *In the British Islands.*—The removal of Robinson and others to Leyden, and the large emigration of Puritans to America, left many others in England whose views coincided with theirs. The Southwark church, organized in 1616, continued. In the latter part of Mr. Lathrop's pastorate, the Baptists, hitherto mingled with the Pædo-Baptists, by the cheerful consent of those remaining, withdrew and organized the first Baptist church in England. Mr. Jacie succeeded Mr. Lathrop, and, with his congregation, suffered much persecution. Another church appears to have been organized in Southwark in 1621, which soon emigrated to Ireland to avoid the severities under which they suffered; but it returned to England, and chose Rev. John Canne as pastor, who, with others, was soon driven to Holland. In 1640, sixty-six of that congregation were imprisoned at once, who, on trial, boldly declared that they could acknowledge no other head of the Church than Jesus Christ. From these roots grew the denomination which came to exercise potent influence in England. Its adherents increased, and might soon have had comparative quiet but for the opposition of the Presbyterians. In the Westminster Assembly were a few Congregationalists, who steadily upheld their views, such as Thomas Goodwin, Philip Nye, Jeremiah Burroughs, William Bridge, and Sidrach Simpson; but they were overpowered by a vast majority of Presbyterians. The five named issued, during the session, "An Apologetical Narration," in which they asked for toleration, and set forth their distinctive views of polity. "We do here publicly profess," said they, "we believe the truth to lie and consist in a *middle way* betwixt that which is falsely

charged on us, *Brownism*, and that which is the contention of these times, the *authoritative Presbyterian government*, in all the subordinations and proceedings of it." During the Commonwealth they stood on an improved footing, Cromwell being an Independent, with many of the men who overthrew the tyranny of Charles I. Eminent Congregationalist ministers were appointed chaplains, or placed in leading positions in the universities, among whom were John Owen, Thomas Goodwin, Gale, Howe, Charnock, Bridge, Nye, Caryl, and Greenhill. While steadily increasing in the subsequent reigns, Congregationalists resolutely opposed all union of Church and State. The most important early public proceeding was the meeting of elders and messengers at the Savoy, in London, in 1659. They then issued "A Declaration of the Faith and Order owned and practiced in the Congregational churches in England." The declaration of faith, known as the "Savoy Confession," was a modification of the Westminster Confession, changing doctrinal statements only slightly, but excluding everything Presbyterian in polity, and changing the Westminster theory of the relation of the Church and State so as to deny the authority of magistrates to interfere with ecclesiastical liberty. This Confession is the one which, slightly amended, was adopted by the American Synod of 1680, and reaffirmed by the American National Council in 1865. The "Toleration Act" of 1669 gave shelter to the Congregationalists, but at that time they, as well as the Baptists, were few compared with the Presbyterians—the three leading denominations of Dissenters. The Congregationalists had increased considerably at the date of the accession of George I, in whose time that defection from orthodox doctrine appeared which so greatly involved the Presbyterians; from that the Independents were free, to which the labors of Watts and Doddridge were greatly conducive. In 1727, on the adoption of a rule by the Congregational ministers of the metropolis for making up their list, there were found to be fifty ministers in that city. In 1784 a writer says that all the Independent ministers were Calvinists. In 1831 was formed the CONGREGATIONAL UNION OF ENGLAND AND WALES, "on a full recognition of their own distinctive principles, viz. the Scriptural right of every separate church to maintain perfect independence in the government and administration of its own particular affairs." This Union meets annually. "Protesting against subscription to any human formularies as a term of communion," the Union declares the "Principles of Religion" as held by their churches. The English and Welsh churches are associated in local unions or associations. The Congregationalists forming the CONGREGATIONAL UNION OF SCOTLAND trace their immediate origin to the enterprises of Robert and James Haldane (q. v.) in 1798 and subsequent years. Originally having no idea of forming churches, when God blessed their labors their converts instinctively drew towards each other. Places of worship were built in several of the largest towns, in which churches were formed. The Union was organized in 1812. The oldest Congregational churches in Ireland date respectively from 1760, 1787, 1798, and 1796. The churches are united in a Union. In the British colonies there are churches forming the following Unions, viz. Victoria, New South Wales, Queensland, South Australia, Tasmania, and Natal, besides those of Canada, and Nova Scotia, and New Brunswick, which are regularly reported with the statistics of the United States churches.

8. *Continental Europe.*—*L'Union des Églises Évangéliques de France*, which was formed in August, 1843, shortly after the secession from the *Eglise Reformée* of the late Frederick Monod and those who acted with him, though not denominated Congregational, holds to the essential principle of that polity in this constitutional declaration: "Each church which es-

ters the union preserves the liberty of determining for itself its own constitution, according to its conviction and necessities. . . . Every church must be constituted on the principle of individual confession of faith, with a guarantee of discipline being exercised by the church itself." It is a union of self-sustaining churches, and hence is small; but a large number of churches dependent on aid are in sympathy, and are represented at the biennial meetings. In SWITZERLAND the free churches of Vaud are united on a basis which, though Presbyterian in form, secures the independence of each. There are also independent churches in Neuchâtel and Berne. These all, with the Free Church of Geneva, the independent churches of the north of France, compose the alliance of Free or Independent Evangelical churches founded in 1860, admitting all churches free of state control which accept the simple Evangelical Confession of Faith adopted by the Alliance, practise a scriptural discipline, recognise the ministry as a divine institution, and engage in the propagation of the Gospel. In ITALY evangelical communities are being formed, since the establishment of the kingdom, upon independent principles, but no definite statements can be given at present regarding actual organization into churches.

4. *Other Parts of the World.*—Missionary churches exist in all parts of the missionary world, established by missionaries of mainly the London Missionary Society, the American Board of Commissioners of Foreign Missions, and the American Missionary Association.

II. DOCTRINES.—1. *In America.*—The Congregational churches are "orthodox" in the general sense of Christendom, holding that the Scriptures are the only rule of faith and practice, and that no creeds may be imposed on any; yet it is the duty of the churches to set forth declarations of the understanding of the Scriptures in Confessions of Faith. Alleged erroneous opinions are to be tested, however, not by the Confessions of Faith, but by the Scriptures. They are, in their views of human nature, Augustinian in distinction from Pelagian, and, as regards the method of the divine government, Calvinistic in distinction from Arminian. While no power can impose a creed on the churches, and each Church adopts its own formulas, yet the principles of fellowship, in which a council of churches is called for the recognition of a new Church, secures a general agreement in doctrine. For a more general standard, the Westminster Confession was adopted by the synod of 1648; that of the Savoy (a slight modification) by the synod of 1680. The General Association of Massachusetts, comprising 600 ministers, declares the Westminster Catechism to be its standard of doctrine. The National Council of 1865 declared, *nem. con.*, "our adherence to the faith and order of the apostolic and primitive churches held by our fathers, and substantially as embodied in the confessions and platforms which our synods of 1648 and 1680 set forth or reaffirmed." The study of theology has been pursued with great earnestness by Congregationalists, and, as a consequence, many shades of opinion are held, while as a body they stand within the lines indicated. Very many theological writers of great power have published systems or criticisms upon points in divinity, from which has arisen a view of Calvinism often styled the "New England theology," which has many adherents, and which doubtless affects the views of those who do not adopt it as a whole. Its origin is ascribed to the works of the first Jonathan Edwards, who, from his sympathy with the "great revival," directed his powerful energies to such explanations of truth as should remove obstacles supposed to be found in the then understanding of Calvinism. The views which he promulgated were subjected to the scrutiny of his son, Dr. Jonathan Edwards; and those of both were developed or modified by a school of writers, among whom may be named Hopkins, West, Smalley, Bellamy, Emmons, and

Dwight, and, later, Taylor, of New Haven, and Park, of Andover. While not all of these agree in all points, and while the later views are considered by many ministers and churches to be materially different from those of the elder Edwards, yet the Calvinism thus explained is wide-spread. The great problem of this "New England theology" has been to harmonize the sovereignty of God and the freedom of man, and from that centre peculiarities in explaining other doctrines have proceeded. The result of these efforts has been a view of Calvinism of which the following may be called distinctive features. The doctrine of *original sin* is held as involving the hereditary corruption of men's nature, but not as involving the guilt of men before actual transgression. The doctrine of *depravity* is held as indicating a *moral* inability, or such an unwillingness and aversion as render it certain that man will not comply with God's demands without the regenerating grace of God, but not as involving a *natural* inability. Of the *Will*, the doctrine is held that it always chooses the greatest apparent good, but with a power of contrary choice. The doctrine of the regenerating *grace of God* is held as involving the *certainty* of its accomplishing its object, but not as *irresistible*. The doctrine of *Decrees* and *Predestination* is held in the sublapsarian sense, and not in the supralapsarian sense. Of the *Atonement*, the "governmental" theory is held. In regard to the Trinity, the Incarnation, the mode of the Divine existence, etc., the "New England theology" has no peculiarities differing from the general view of the Christian Church. This system is by no means held by all Congregationalists. Very many pastors and churches class themselves among the older Calvinistic schools, and all are held in general conformity with the early Confessions. The Congregationalists are Pædo-Baptists; as to mode, while "sprinkling" or "affusion" is the general custom, adults are held entitled to choose the mode they conscientiously prefer. The doctrine of the Lord's Supper is variously held, although rarely debated; but only persons professing a change of heart are admitted to the communion, and members of all evangelical churches are freely welcomed. The *Declaration of Faith* set forth by the National Council in 1866, adopted on Burial Hill, at Plymouth, Mass., declares (1) the doctrinal standards of the denomination, and (2) the principles of its recognition of fellowship with all the evangelical bodies. It is as follows:

"Standing by the rock where the Pilgrims set foot upon these shores, upon the spot where they worshipped God, and among the graves of the early generations, we, elders and messengers of the Congregational churches of the United States in National Council assembled, like them acknowledging no rule of faith but the Word of God, do now declare our adherence to the faith and order of the apostolic and primitive churches held by our fathers, and substantially as embodied in the confessions and platforms which our synods of 1648 and 1680 set forth or reaffirmed. We declare that the experience of the nearly two and a half centuries which have elapsed since the memorable day when our sires founded here a Christian commonwealth, with all the development of new forms of error since their times, has only deepened our confidence in the faith and polity of those fathers. We bless God for the inheritance of these doctrines. We invoke the help of the Divine Redeemer, that, through the presence of the promised Comforter, he will enable us to transmit them in purity to our children.

"In the times that are before us as a nation, times at once of duty and of danger, we rest all our hope in the Gospel of the Son of God. It was the grand peculiarity of our Puritan fathers that they held this Gospel, not merely as the ground of their personal salvation, but as declaring the worth of man by the incarnation and sacrifice of the Son of God; and therefore applied

its principles to elevate society, to regulate education, to civilize humanity, to purify law, to reform the Church and the State, and to assert and defend liberty; in short, to mould and redeem, by its all-transforming energy, everything that belongs to man in his individual and social relations.

"It was the faith of our fathers that gave us this free land in which we dwell. It is by this faith only that we can transmit to our children a free and happy, because a Christian commonwealth.

"We hold it to be a distinctive excellence of our Congregational system that it exalts that which is more above that which is less important, and by the simplicity of its organization facilitates, in communities where the population is limited, the union of all true believers in one Christian Church; and that the division of such communities into several weak and jealous societies, holding the same common faith, is a sin against the unity of the body of Christ, and at once the shame and scandal of Christendom.

"We rejoice that, through the influence of our free system of apostolic order, we can hold fellowship with all who acknowledge Christ, and act efficiently in the work of restoring unity to the divided Church, and of bringing back harmony and peace among all 'who love our Lord Jesus Christ in sincerity.'

"Thus recognising the unity of the Church of Christ in all the world, and knowing that we are but one branch of Christ's people, while adhering to our peculiar faith and order, we extend to all believers the hand of Christian fellowship upon the basis of those great fundamental truths in which all Christians should agree. With them we confess our faith in God, the Father, the Son, and the Holy Ghost, the only living and true God; in Jesus Christ, the incarnate Word, who is exalted to be our Redeemer and king; and in the Holy Comforter, who is present in the Church to regenerate and sanctify the soul.

"With the whole Church, we confess the common sinfulness and ruin of our race, and acknowledge that it is only through the work accomplished by the life and expiatory death of Christ that believers in him are justified before God, receive the remission of sins, and through the presence and grace of the Holy Comforter are delivered from the power of sin, and perfected in holiness.

"We believe also in the organized and visible Church, in the ministry of the Word, in the sacraments of Baptism and the Lord's Supper, in the resurrection of the body, and in the final judgment, the issues of which are eternal life and everlasting punishment.

"We receive these truths on the testimony of God, given through prophets and apostles, and in the life, the miracles, the death, the resurrection of his Son, our Divine Redeemer—a testimony preserved for the Church in the Scriptures of the Old and the New Testaments, which were composed by holy men as they were moved by the Holy Ghost.

"Affirming now our belief that those who thus hold 'one faith, one Lord, one baptism,' together constitute the one catholic Church, the several households of which, though called by different names, are the one body of Christ, and that these members of his body are sacredly bound to keep 'the unity of the spirit in the bonds of peace,' we declare that we will co-operate with all who hold these truths. With them we will carry the Gospel into every part of this land, and with them we will go into all the world, and 'preach the Gospel to every creature.' May he to whom 'all power is given in heaven and earth' fulfil the promise which is all our hope: 'Lo, I am with you alway, even to the end of the world.' Amen."

2. *In Europe.*—The doctrines of the English Congregationalists were set forth in 1659 in the Savoy Confession. As now stated, they are presented in the Declaration of the Congregational Union, in articles of

a Calvinistic type, but not presenting "a scholastic or critical confession of faith." While able writers have vigorously maintained the great doctrines of the evangelical churches, speculations upon doctrine do not seem to have been carried on as extensively as in the American churches, and the peculiarities of the "New England theology" have not been prominently discussed.

III. GOVERNMENT.—1. *In America.*—The whole administration of Congregationalism grows out of the two cardinal principles of (1) the completeness of the local church for its own government, and (2) the necessary fellowship of the churches. In all matters concerning the *individual church* alone, no other body is necessary to complete or sanction its action, and none has power to revise or overrule it. But in all matters concerning the *churches in fellowship* as a whole, those churches properly convened express their opinions and determine their course; and although their decision is of force only in such churches as adopt it, yet the moral weight of such decisions generally secure acquiescence. The two principles mentioned limit each other.

(1) *Of the local Church.*—The church is composed only of persons supposed to be regenerated, united by a covenant which recognises duty to God and to each other, meeting for worship, sacraments, and discipline. The government is strictly democratic, so far as giving the right of voting to all adult males, and with no power of veto in the pastor. By vote of the brotherhood members are admitted or dismissed, alleged offenders tried, and censures passed, and all officers elected. The permanent officers are pastor (or bishop) and deacons, with clerk and such committees as the Church finds desirable. The pastor is necessarily an ordained minister or elder, and, from his position, "bishop." He is chosen by the Church, and may be dismissed by the Church; but the usual alliance of the Church with an incorporated civil society gives the pastor a legal relation to that society (by which he has also been chosen in concurrence with the Church) which the Church cannot touch. This alliance is a variation from pure Congregationalism, which some churches do not practice; but inasmuch as members of the Church usually compose the far larger part of the civil corporation, harm seldom ensues.

(2) *Of the Fellowship of the Churches.*—All churches stand in a sisterly relation to each other, and are bound to fulfil its duties. This communion is manifested in mutual recognition; in admitting members of one church to the communion of another; in temporary interchange of ministers; in the dismissal and reception of members; in giving and receiving advice; in giving and receiving help; in consultation and co-operation in the edification of a particular church, or matters of general welfare; and in giving and receiving admonition. These principles limit the independence of the local church, and are embodied in the decisions of councils, which are the churches of a greater or less locality, represented each by pastor and delegate, and convened for special occasions. The limiting effect may be seen thus: believers in a given locality may organize a Church, but it is not recognized as in fellowship until a council of churches has examined the need of it, its material, and its doctrine, and approved of its recognition. A Church may settle a pastor, but he is not in fellowship with other churches until those churches in council have considered and approved his doctrinal and religious fitness. A Church may excommunicate a member, and no power outside can replace him in that Church; but inasmuch as the effect of that excommunication is to cut him off from the communion of all churches, the other churches have a right (and under certain circumstances it is their duty) to examine the case, and if the Church appears to have erred, recommend his restoration; in default of which they determine that his fellowship with

ought to continue, and they advise any Church to which he may apply to receive him. A Church may become erroneous in doctrine, or scandalous by its conduct, and no power can reverse its actions; but inasmuch as the scandalous conduct injures all the churches, they have a right to remonstrate and admonish, and, if that fails, withdraw fellowship from the offending Church. The general principle, therefore, is, that while no external power can interfere with any act of a Church whose result is confined to itself, yet if that act, in its effect and influence, goes beyond and affects the body of churches, those churches have full right to consider such external effect and influence. The practical result of the working of these principles has been to secure both the rights of local churches, and the harmony, stability in doctrine, and united action of the denomination.

(3.) *Of the Ministry.*—"The ministry," says the National Council of 1865, "includes all men called to that work, and orderly set apart by ordination. When ordination of a pastor is to be performed, the church in which he is to bear office invite a council to examine as to faith, grace, and ability, that, if he be approved, they may extend the hand of fellowship. If the ordination be in view of any other sphere of labor, the request for a council ought to come from the church of which he is a member. A pastor dismissed does not cease to be a minister, but he cannot exercise any official act over a church until orderly replaced in office, except when particularly invited by a church." Congregationalists acknowledge but one grade of ministers; regarding the apostolic office as extraordinary, and to have ended with the death of those mentioned in the Scriptures. In the early history of American Congregationalism no ministry was recognised except that of a pastorate. But when it became necessary to preach the Gospel where there were no churches, as in missionary work, "evangelists" were ordained, but with no distinction in permanent character or authority from other ministers. A further modification of the original view has taken place. Until "now, all the Congregational churches," says Dr. Leonard Bacon, "acknowledge the difference between a minister of the Gospel and a pastor of a church. The former has no official power in any church or over any Christian. He is only a man set apart to preach the Gospel where God in his providence may call him." In the ordination of a pastor a distinction is now generally recognised between (1) the act of setting him apart as a minister of the Gospel, and (2) the act of his installation as pastor of the particular church. Ordinations without pastoral charge are now frequent, but never except in view of some particular sphere of labor.

Synods and Councils.—There are no standing bodies to hear appeals, give evidence, or declare the opinions of the denomination. But bodies to hear, determine, and advise are held to be involved in the fellowship of the churches, and are always called when the occasion is seen to demand them. They are more or less extensive, according to the number of churches affected by any matter to be considered. In all cases they are meetings of the churches, represented, however, by pastor and delegate. Only four general synods, as stated above, have been held in the United States. Matters affecting only a limited territory cause the convening of a limited council, as in Connecticut in 1709; while matters of merely local interest are the occasion of local councils, or those made up of a few contiguous churches, such as for the ordination of a pastor or the hearing of a case of alleged grievance. All are convened on the motion of a Church or churches, but no Church is obliged to participate. The proposal of the National Council of 1865 was first made in a local association; was recommended by the "Convention of the North-west;" was submitted to all the state bodies, and approved by all save one, which afterwards, however, was represented; and was

called, in behalf of the various churches represented in the state bodies, by a joint committee composed from each body assenting. Local councils are frequent, being called to advise upon the recognition of new churches, the ordination or dismissal of pastors, the complaint of alleged grievance, and for advice to any Church desiring it. In calling a council, a Church must always be a party; the only apparent exception being that wherein, on complaint of injury to a member, the Church ought to be a party by assenting to his request for a council, but *unreasonably* refuses. In the latter case the member may call one himself, with a statement of the grounds and of the unreasonable refusal of the Church, in which case the council is known as *ex parte*, but is entitled to all the respect of a mutual one. If the Church and member (or, in similar circumstances, the Church and pastor, if there be differences between them) unite in the call, it is a *mutual* council. A council is composed of those churches invited, a list of which is given to every Church called, and cannot add to or diminish the number. It can act only on the matters presented in the document calling it, which is known as the "letters-missive." When it has examined the case, it puts its opinion in a "result," which is communicated to all parties, and then dissolves. Refusal to adopt the result does not prejudice the standing of a Church; if the refusal is a grave offence, and such as should affect fellowship with that Church, as in cases of doctrinal error, then new proceedings would be necessary for admonishing the offending Church. But the adoption of the results of council by one party in difference is held to justify that party, and in legal matters, such as relate to the contract of a pastor and parish, will be sustained by courts. The legal decisions on ecclesiastical matters have been numerous in Massachusetts. But the courts merely declare what the usages of Congregationalism are in reference to any contract in dispute, and they refuse to go behind the declaration of facts made by a council properly convened and properly conducted. The system of occasional councils is varied from only in Connecticut, where most of the churches are united in local consociations, in which system all matters which could elsewhere be referred to a special council, originated for the purpose, are referred to a fixed and recorded list of churches united in the consociation, which have bound themselves to constitute a mutual council whenever needed. Any Church may withdraw from a consociation without affecting its standing.

Customs and Usages.—Persons desiring approbation to preach apply, for convenience and fitness, to local associations of ministers, who receive his credentials of Church membership and of theological study, examine him as to his religious experience, his doctrinal views, his knowledge of scriptural learning, and his general fitness. Their approval, given in a certificate, merely commends him to the churches as a candidate for the ministry. In ordinations or installations of pastors, a council of churches makes similar examinations. Ordinations are accompanied by a sermon, an ordaining prayer (in connection with the "laying on of hands" by ordained ministers), charge to the pastor, the hand of fellowship, and an address to the Church. In the celebration of the Lord's Supper there is no prescribed liturgy. Persons applying for membership in the Church on profession of faith are examined by the Church or a committee, publicly propounded for a reasonable time prior to the vote on reception, are voted for or against by the whole brotherhood, and are received in public on adoption of the Church covenant, and (generally) assent to the doctrinal confession of the Church. Persons are dismissed from one Church to another, on their application, by vote of the Church dismissing, which takes effect on the reception of the person by the Church to which he is dismissed, which also votes on his reception.

Public worship is conducted in the form any Church prefers, although there is a very general similarity; but a few churches use a more or less extended liturgy, which is entirely within the control of every Church. In cases of the discipline of alleged offenders, the rules given in the 18th chapter of Matthew are required to be followed. If the first and second steps have been properly taken, the alleged offender is summoned by the Church to appear at a time reasonably distant, and is entitled to a copy of all charges, and an unprejudiced and fair hearing: all the brotherhood vote upon the case. Church censures are of two kinds, admonition (which is often accompanied by suspension from Church privileges) and excommunication. If a member claims to have been unjustly suspended or excommunicated, his remedy is in asking the Church for a mutual council to consider and advise in the matter, and, in case of unreasonable refusal, to call a council himself, with the effect already described under *Councils*.

2. In Great Britain.—The general principles of Congregationalism are held in England precisely as in the United States. In the doctrine of the ministry, Church completeness, fellowship, and discipline, there is no particular variation; but in administration the Congregationalists of the British Islands make far less use of synods and councils. The above explanations, therefore, are in great degree inapplicable to that country, so far as they relate to such bodies. At this time (1867) the subject is attracting attention and causing discussion. There are, however, associations or unions of churches similar to those in the United States, as well as associations of ministers. The English Congregationalists have also organized benevolent religious societies, either alone or with others, on the voluntary principle, for missions, religious publications, church building, education, etc. Among the Congregational societies are the Home Missionary Society, the Colonial Missionary Society, the Irish Evangelical Society, the Congregational Board of Education, etc. Foreign missions are carried on by means of the London Missionary Society, established in 1795, which is undenominational. The British and Foreign Bible Society, the Religious Tract Society, and others, receive the co-operation of the Congregationalists.

IV. STATISTICS.—The statistics of the American churches are given annually in the *Congregational Quarterly* (Boston, Mass.); those of the British Islands and Colonies in the *Congregational Year-book*. As published January, 1867 (collected in 1866), they are as follows, to which, for the American churches, the figures collected in 1867 (the first completely to be relied upon) are prefixed for comparison:

	American.	1866 (for 1867).	1867 (for 1866).
Churches		2,475	2,900
Members		282,549	272,975
Numbers in Sabbath-schools		128,772	293,883
Ministers		2,414	3,009

Of the above, the churches in the United States, in 1866, were 2780; members, 267,453; numbers in Sabbath-schools, 286,275; ministers, 2919. These figures do not include over 200 churches, independent, or still connected with presbyteries on the "Plan of Union." Charitable contributions in 1865-6, excluding all cost of churches or repairs, or support of the ministry, or of endowment of schools, colleges, or theological seminaries, rising \$1,200,000.

Great Britain and Colonies.

	County Associations, or Unions.	Churches.	Ministers.
England	48	1933	1826
Wales	16	788	407
Scotland	8	105	105
Ireland	1	27	25
Colonies	8	278	217
Channel Islands ..	—	13	—
Foreign lands ..	—	—	202
Total	76	3184	2783

Other Parts of the World.—The number of Congregational churches established by missionaries is very considerable, but has never been reported. The number of ministers is included in the English and American reports.

Summary.—Excluding the churches on the European Continent, and also the missionary churches, and omitting the requisite number for Canada, Nova Scotia, and New Brunswick, which are included in both the English and American reports, there are found 1 recognised and formal fellowship: Total churches 5920; ministers, 5706; communicants (estimating the whole from the proportion of members to churches in the United States), 899,840.

INSTITUTIONS OF LEARNING.—United States.—A large number of academies are controlled by Congregationalists, but no record has ever been made. Colleges, though none are conducted on any exclusive principle, or require any denominational test, the Congregationalists control Bowdoin, Dartmouth, Vermont University, Middlebury, Williams, Amherst, Yale, and partially a number in the Western States, which they have helped liberally to endow. Theological schools in 1867, with the number of professors, lecturers, etc. and students, were as follows (one in San Francisco, California, was also chartered in 1866, but is not yet in operation):

	Professors.	Lecturers, etc.	Students.
Bangor, Me.	—	—	40
Andover, Mass.	5	5	163
Yale, Conn.	7	—	80
Hartford, Conn.	4	4	56
Oberlin, Ohio	4	—	14
Chicago, Ill.	4	—	46

Colleges in the British Islands and Colonies.

British Islands	14	Victoria	1
British North America ..	1	Sydney	1

Theological Colleges in the British Islands and Colonies.

	Schools.	Students.
England	8	197
Wales	3	90
Scotland	1	6
Colonies	4	(?)
Private Seminaries in England ..	4	(?)

PERIODICALS.—United States.—No periodical can properly be called an organ of the denomination, inasmuch as none are controlled by either the churches or any body representing the churches. But the following are published in their interests: *Quarterlies*—*Bibliotheca Sacra*, Boston, Mass.; *New Englander*, New Haven, Conn.; *Congregational Quart.*, Boston, Mass.; *Congregational Review*, Boston, Mass. Religious (weekly) newspapers: *Congregationalist and Boston Recorder*, Boston, Mass.; *Christian Mirror*, Portland, Maine; *Vermont Chronicle*, Windsor, Vt.; *Religious Herald*, Hartford, Conn.; *Advance*, Chicago, Ill.; *Pacific*, San Francisco, Cal. The Welsh Congregational churches in the United States have their own publications. Many other periodicals—missionary, tract, Sabbath-school, etc.—are mainly or wholly conducted by Congregationalists, but without distinctive denominational character.

England.—*Year-book*, etc. (annual). *Quarterlies*—*Journal of Sacred Literature*; *British Quarterly Review*. Eighteen monthlies. Newspapers—*Nonconformist*, *English Independent*, *Christian World*, and *The Independent*.

Scotland.—*Congregational Magazine* (monthly). **Ireland.**—*Congregational Magazine* (monthly). **Wales.**—*Dyddiadur Amibynsyr* (annual); *Beirniad* (quarterly), and five other periodicals.

Canada.—*Independent*, Toronto (monthly); *Montreal Witness* (weekly).

V. LITERATURE.—The American Congregational churches have required from the beginning ministers of liberal education and extensive learning. From this culture large contributions have resulted to general as well as denominational and religious literature. Of the very many authors in each department of the

atter, the following may be mentioned as the most prominent:

In *Church Polity*, in the 17th century, John Cotton, John Norton, Thomas Hooker, Richard Mather, John Davenport, Increase Mather (Pres. Harvard College). In the 18th century, Cotton Mather, Samuel Mather, John Wise, Ezra Stiles (Pres. Yale College). In the present century, John Mitchell, Thomas C. Upham, Nathaniel Emmons, Leonard Bacon, Preston Cummings, George Punchard, Henry M. Dexter. The work on "Congregationalism" by the last named, which is the latest American work, is also the fullest and most exhaustive, and is generally received by the churches as a safe and comprehensive guide.

In *Denominational History*, in the 17th century, Gov. John Winthrop, Nathaniel Morton, William Hubbard. In the 18th century, Cotton Mather, Thomas Prince, Jeremy Belknap. In the present century, Leonard Bacon, Bela B. Edwards, George Punchard. The *History of Congregationalism* by the latter, though not yet completed, is a work of thorough research and peculiar value.

In *Theology*, in the 17th century, Cotton, Norton, the Mathers, Thomas Shepard. In the 18th century, Samuel Willard (*Body of Divinity*), Jonathan Edwards, Jonathan Edwards the younger, Joseph Bellamy, Samuel Hopkins, Stephen West. In the present century, John Smalley, Nathaniel Emmons, Asa Burton, Jesse Appleton (Pres. Bowdoin College), Leonard Woods, Enoch Pond, Timothy Dwight (Pres. Yale College), Edward D. Griffin (Pres. Williams College), Nathaniel W. Taylor, Bennett Tyler, Lyman Beecher, Edward Beecher, Charles G. Finney (Pres. Oberlin College), Asa Mahan (Pres. Oberlin College), Mark Hopkins (Pres. Williams College), Edwards A. Park, Horace Bushnell, George P. Fisher.

In *Biblical Literature*, Moses Stuart. The missionaries of the American Board have made very extensive contributions in the languages of the world, as well as to general science; among these, Myron Winslow is specially prominent.

In *various relative Studies and in Religious Works*, Edw. Hitchcock (Pres. Amherst College), Jas. Marsh, Joseph P. Thompson, Richard S. Storrs, Jr., Austin Phelps, Henry Ward Beecher, Augustus C. Thompson, Nathan W. Fiske, Nehemiah Adams, Ray Palmer (hymns and other religious poems), Lowell Mason (in sacred music), Hubbard Winslow, Joseph Haven, Rufus Anderson (sec. A. B. C. F. M.), Noah Porter, Jr., John Lord, Samuel C. Bartlett, Leonard Bacon, Thomas C. Upham, Leonard Woods, Jr., James B. Walker.

In England, after John Robinson, whose writings in Leyden began strictly Congregational literature, are found the names of Milton, Goodwin, Nye, John Owen, Charnock, Watts, Doddridge, and, later, Wardlaw, Davidson, Newman Hall, Robert Vaughan, John Angell James. Hanbury's *Memorials* is a work of great historical value.

VI. **AUTHORITIES.**—As Congregationalists admit no *obligatory* standards of human devising, there are properly no *authorities* for government or doctrine; but their principles are stated in Declarations, in which they are agreed, and which carry great moral force. The principal on doctrine are the Westminster Confession, as revised by the Savoy Synod in 1659, and again by the Boston Synod of 1680; the "Principles of Religion" of the Congregational Union of England and Wales; and the "Declaration of Faith" set forth by the American National Council in 1865. Of ecclesiastical polity, the principal are the Savoy "Order of the Churches" in 1659; the "Cambridge Platform" in 1648; the "Saybrook Platform" in 1708; the "Principles of Church Order and Discipline" of the "Congregational Union of England;" and the "Platform of Church Polity" of the National Council in 1865. The works of many writers are also considered of great value, as showing what Congregational prin-

ciples and usages are. The volumes of the *Congregational Quarterly* (Boston) also contain careful discussions on the several points of polity as well as history, and furnish full statistics. The *English Year-book* furnishes such statistics as are collected in Great Britain.

Congregationalists, or Apostolical Congregation, a designation of the Ultramontane party in France, which, under the reign of Napoleon I, resumed the direction of primary instruction, and established religious associations. After the restoration of the Bourbons, the power of the Congregationalists increased rapidly, and they made extraordinary efforts to bring back the Church of France under the dominion of Rome. They usurped the control of public instruction, established colleges and seminaries, connected themselves with the Jesuits, and even gained the control of the police of Paris. Their leaders held the highest stations at court. The material means of the Congregation were to a large extent furnished by the laboring classes (in 1826 there were 500,000 persons contributing each one cent a week). The celebrated Lamennais belonged to this party. At last their usurpation of power gave rise to the formation of a counterparty, which gradually gained strength and influence. In 1826 count Montlosier proved the existence of the Congregation to be illegal. A large number of bishops appealed to the king against the abuse of the Gallican liberties. The Congregation endeavored to excite the fanaticism of the people by sermons and tracts, but in 1827 the Higher Chamber resolved to interfere actively in putting down all Jesuitic associations, and in 1828 the control of the primary schools was given to the minister of Public Instruction. It was then decided that every teacher should declare in writing that he was not a member of any forbidden religious association, or be suspended. A large number of Congregationalists left France in consequence, but their influence, which made itself felt even after their departure, was not entirely lost until the Revolution of 1830.—Pierer, *Universal-Lexikon*, iv, 358.

Congruity. See **CONDIGNITY**.

Coni'ah (Heb. in the pealoned form *Kong'ah*, כִּנְיָה, a contracted form of *Jeconiah*; Sept. *Ἰεχονίας*), another mode of writing (Jer. xxii, 24, 28; xxxvii, 1) the name of king JEHOLACHIN (q. v.).

Conists. See **CONONITES**.

Conjuration, the form of words or ceremony by which demons are supposed to be expelled in the Church of Rome. See **EXORCISM**.

Connell, ZECHARIAH, a Methodist Episcopal minister, was born in Connellsville, Fayette County, Pa., September 11, 1794. In 1801 his father removed to the West, and settled in Adams County, Ohio. His early education was such as could be obtained in the West at that day, which he diligently improved. He was a faithful student and became a wise man. He entered the itinerant ministry in 1818, and filled various stations, as minister and presiding elder, with uniform fidelity and success, up to the year of his death. Methodism in Ohio is largely indebted to him, not only for its extent, but for its character. By his zeal as a preacher, and his skill as an administrator, he gained and kept the confidence of the Church during his long career of service. He was five times elected to the General Conference. He died December 18, 1863.—*Minutes of Conferences*, 1864, p. 148.

Conon, bishop of Rome. He was a native of Temesvar, in Mysia (now Hungary), educated in Sicily, and was elected bishop of Rome, Oct. 21, 686. He sent the Irish missionary Killan to Germany to preach to the pagan Thuringians. He died Sept. 21, 687.

Cononi'ah (2 Chron. xxxi, 12, 13). See **CONANIAH**.

Cononites, followers of Conon, bishop of Tarsus, in Cilicia, in the 6th century, a disciple of Johannes

Philoponus (q. v.). Conon differed from Philoponus in the doctrine of the resurrection, maintaining that the dissolution of the body after death affected only the form, not the matter of the body, and that at the resurrection the soul was reunited with the same, though transformed body.—Wetzer u. Welte, *Kirchen-Lex.* ii, 798. See JOHANNES PHILOPONUS; TRITHEISM.

Conrad of Marburg. See KONRAD VON MARBURG.

Conrad, WILLIAM, a highly useful minister in the German Reformed Church, born Aug. 11, 1808. He pursued his classical and preparatory studies in the Reformed Academy and Theological Seminary, then located at York, Pa. He was licensed to preach by the Westmoreland Classis, Pa., in May, 1835, and labored the whole of his subsequent life as a pioneer in West Pennsylvania. His death occurred Feb. 16, 1865. He was an earnest student. As a writer he often appeared in the Church papers. He is also the author of a volume on Baptism, published 1847, and of several unpublished works on different subjects—one on the Heidelberg Catechism. For thirty years he gathered geological specimens, the entire collection of which he presented to Westmoreland College, one of whose founders and best friends he was.

Conring (Comringius), HERMAN, one of the most learned men of his time, was born at Norden, in East Friesland, Nov. 9th, 1606; became professor of Philosophy, Medicine, and Jurisprudence at Helmstadt, and in 1660 privy counsellor of the duke of Brunswick. He died Dec. 12, 1681. Public law is greatly indebted to him, and he may be said to have first brought it to a scientific form. He was also among the first to adopt Harvey's theory of the circulation of the blood. His complete works, embracing a number of treatises on ecclesiastical subjects, particularly on the rights of Protestantism as opposed to the Romish Church, were published by Göbel (Brunsw. 1780, 7 vols. fol.).—Pierer, *Universal-Lexikon*, s. v.

Consalvi, ERCOLE, marquis of Consalvi, a cardinal, and one of the ablest diplomatic agents of Rome in the present century, was born at Rome, June 8, 1757. Pius VI appointed him in 1792 to the office of *Uditore della sacra ruota*, and afterwards minister of war. In this capacity he showed himself a steady enemy of the French Revolution. When the French troops took Rome in 1798 he was made prisoner, but soon after released. After the death of Pius VI he was secretary of the conclave which elected cardinal Chiramonte (Pius VII) as pope, and soon after (1800) he was made by the new pope secretary of state and cardinal. In 1801 he went to Paris, where he signed the concordat with Napoleon, July 15; but having afterwards incurred the displeasure of the emperor, Consalvi resigned (1806) his office. He refused his assent to the divorce of Napoleon and Josephine, in the council held on the subject, and was exiled in 1809. The pope having returned to Rome in 1814, Consalvi was restored to his position as prime minister, and soon sent to the conferences held by the great powers at London as representative of the papal interests. He was also papal plenipotentiary at the Congress of Vienna, when he secured the restitution of all the papal territories with the exception of Avignon and Venaissin. Against the incorporation of these places with France he protested, as also against the occupation of Ferrara and Rimini by Austrian troops, and against the secularization of the ecclesiastical states of Germany. This protest, however, was of no avail, and he was also unsuccessful in his endeavor to rearrange the ecclesiastical affairs of Germany by one general concordat. He was more fortunate in his negotiations with particular states, and successfully concluded concordats (q. v.) with France, Russia, Poland, Prussia, Austria, Bavaria, Württem-

berg, Sardinia, Spain, Geneva, and even with St. Domingo and Chili. At the death of Pius VII (1823) he retired to Porto d'Anzo, but was called again to Rome by Leo XII, who placed him at the head of the Propaganda, which office he had hardly accepted when he died, Jan. 24, 1824.—*Mémoires du Cardinal Consalvi* (with introduction and notes by Cretineau-Joly, Paris, 1864, 2 vols.); Wetzer u. Welte, *Kirchen-Lex.* ii, 811. Bartholdy, *Züge aus dem Leben des Card. Consalvi* (Stuttgart, 1824); *Revue Chrétienne*, 5 Feb. 1865.

Consanguinity, alliance by blood, as affinity (q. v.) is alliance by marriage. Certain degrees of consanguinity are among the impediments to marriage, both by the law of nature and by the revealed word of God. These degrees, as defined by the Church of England, are expressed in a table drawn up by archbishop Parker in 1563, and set forth by authority. This table is as follows:

A Table of Kindred and Affinity, wherein whatsoever are related are forbidden in Scripture and our Laws to marry together.

<i>A man may not marry his</i>	<i>A woman may not marry with her</i>
1 Grandmother,	1 Grandfather,
2 Grandfather's Wife,	2 Grandmother's Husband,
3 Wife's Grandmother.	3 Husband's Grandfather.
4 Father's Sister,	4 Father's Brother,
5 Mother's Sister,	5 Mother's Brother,
6 Father's Brother's Wife.	6 Father's Sister's Husband.
7 Mother's Brother's Wife,	7 Mother's Sister's Husband.
8 Wife's Father's Sister,	8 Husband's Father's Brother.
9 Wife's Mother's Sister.	9 Husband's Mother's Brother.
10 Mother,	10 Father,
11 Step-mother,	11 Step-father,
12 Wife's Mother.	12 Husband's Father.
13 Daughter,	13 Son,
14 Wife's Daughter,	14 Husband's Son,
15 Son's Wife.	15 Daughter's Husband.
16 Sister,	16 Brother,
17 Wife's Sister,	17 Husband's Brother,
18 Brother's Wife.	18 Sister's Husband.
19 Son's Daughter,	19 Son's Son,
20 Daughter's Daughter,	20 Daughter's Son,
21 Son's Son's Wife.	21 Son's Daughter's Husband.
22 Daughter's Son's Wife,	22 Daughter's Daughter's Husband.
23 Wife's Son's Daughter,	23 Husband's Son's Son,
24 Wife's Daughter's Daughter.	24 Husband's Daughter's Son.
25 Brother's Daughter,	25 Brother's Son,
26 Sister's Daughter,	26 Sister's Son,
27 Brother's Son's Wife.	27 Brother's Daughter's Husband.
28 Sister's Son's Wife,	28 Sister's Daughter's Husband.
29 Wife's Brother's Daughter,	29 Husband's Brother's Son,
30 Wife's Sister's Daughter.	30 Husband's Sister's Son.

See AFFINITY.

Conscience. See ETHICS; MORAL PHILOSOPHY.

CONSCIENCE, CASES OF. See CASUISTRY.

Conscientiarii (conscience people), the name of a sect of atheistic freethinkers in the 17th century. The founder of the sect was a student of theology at the University of Jena, Matthias von Knutzen (also called Knuzan or Kuntzen), born at Oldensworth, in Schleswig, who, while studying at Jena (in 1674), circulated among the students two writings, in which he denied the existence of God, the authority of the Bible, and the difference between marriage and fornication, recognising only the individual reason and conscience (hence the name) as rules of religious belief. Knutzen claimed to have numerous adherents at all the universities and capitals of Europe, at Jena no less than 700, and thus brought the university into bad repute. The professors of Jena indignantly denied his assertion. The excitement produced by the discovery of the agitation of Knutzen soon died out, and the *Conscientiarii* were no longer heard of. See Wetzer u. Welte, *Kirchen-Lex.* ii, 815; Arnold, *Kirch. u. Ketzehist.* vol. ii.

Consecration (properly some form of the verb

קִדְּשׁ, *kadash*, to be holy, often rendered "sanctify;" *γκαεινίζω*, to dedicate; *τελειώω*, to complete), the act of devoting or setting apart anything to the worship or service of God. See DEDICATION. The Mosaic law ordained that all the first-born, both of man and beast, should be sanctified or consecrated to God. See FIRST-BORN. The whole race of Abraham was in a peculiar manner consecrated to his worship, and the tribe of Levi and family of Aaron were more immediately consecrated to the service of God (Exod. xiii, 2; xii, 15; Num. iii, 12; 1 Pet. ii, 9). See SACERDOTAL ORDER. Besides these consecrations ordained by God, there were others which depended on the will of men, and were either to continue forever or for a time only. See Vow. Hannah, the mother of Samuel, offered her son to the Lord to serve all his lifetime in the tabernacle (1 Sam. i, 11; comp. Luke i, 15). David and Solomon devoted the Nethinim to the service of the Temple forever (Ezra viii, 20). The Hebrews sometimes devoted their fields and cattle to the Lord, and sometimes the spoils taken in war (Levit. xxvii, 28, 29). In like manner, vessels (Josh. vi, 19), profits (Mic. iv, 18), individuals (Num. vi, 9-18; 1 Sam. i, 11; Luke i, 15), and nations (Exod. xix, 6), were often dedicated. See ANATHEMA.

The New Testament also furnishes us with examples of consecration. Christians in general are esteemed as consecrated to the Lord, and are a holy race, a chosen people (1 Pet. ii, 9). Ministers are in a peculiar manner consecrated or set apart, and so are places of worship, the forms of dedication varying according to the views of different bodies of Christians. See ORDINATION. It does not appear that we have any particular accounts of the formal consecration of churches earlier than the fourth century, a fact which may be easily accounted for by considering the circumstances of the times before Constantine. See the articles following; also BELLS.

CONSECRATION-OFFERING. At the inauguration of the Israelitish priesthood, in connection with the oblation, certain parts of the victim (a ram), besides bread and cakes, were laid in the hand of the person to be consecrated, before he came to the altar (Exod. xxix, 22 sq.; Lev. viii, 25 sq.), as a manipulation expressive of the representative power thus conferred (Bähr, *Symbol.* ii, 426). This depositing in the hand is called by the technical term *filling their hand* (A. V. "consecrate," Exod. xxviii, 41; xxix, 9; Lev. xxi, 10; Num. iii, 3; comp. Exod. xxxii, 29; 1 Chron. xxix, 5), and thus the sacerdotal consecration-offering itself was styled a *filling* (מִלֵּא, sc. of the hand, Sept. *τελειώσις*, Lev. vii, 37; xxviii, 31), and the sacrificed ram was designated by the corresponding term (מִלֵּא, Exod. xxix, 26).—Winer, i, 381. See OFFERING.

CONSECRATION, in the Christian Church, a ceremony of dedicating persons or things to the service of God. It is especially applied to the setting apart of bishops for their office, and to the dedication of Church edifices to the worship of God.

I. *Consecration of Bishops.*—The forms for the consecration of bishops in the Greek, Roman, Anglican, and Methodist Episcopal churches are given under BISHOP (i, 822, 823). In the preface to the form used in the Church of England, it is stated that no one shall be accounted or taken to be a bishop, or suffered to execute the same function, unless he be called, tried, and admitted thereunto according to that form, or *hath formerly had episcopal consecration*. The concluding portion of this sentence recognises the validity of consecrations given in foreign churches by any other form adopted by those churches. Thus a Greek or Roman bishop, conforming to the rules of the Church of England, requires no fresh consecration, but is at liberty to officiate in that Church (Hook, s. v.). The

Greek and Roman churches, on the contrary, do not recognise the validity of Anglican consecrations.

According to a canon of the first Nicene Council, there must be four, or at least three bishops present at the consecration of a bishop. See COLLEGE, 2.

II. *Consecration of Churches.*—1. *Ancient Church.*

—The practice of solemnly dedicating to God those edifices which had been built for his worship is very ancient. The precise manner in which it was done for the first three ages of Christianity is unknown; but Eusebius gives an account of the ceremony by which the church of Jerusalem, built by Constantine, was consecrated, A. D. 335. On such occasions it was usual for a whole synod of the neighboring or provincial bishops to assemble. "The solemnity ordinarily began with a panegyric oration or sermon in commemoration of the founder, which was followed by prayers, among which there seems to have been one in particular for the church which was then to be dedicated. The act of consecrating churches was so peculiarly reserved to the office of bishops that presbyters were not allowed to perform it. Anciently churches were always dedicated to God, and not to saints, though they were sometimes distinguished by their names as a memorial of them. Consecration was performed, indifferently, on any day; but, whatever the day was, it was usually kept and observed among their annual festivals. To this pope Gregory, surnamed the Great, added a new custom in England, which was, that on the anniversary of the dedication of churches, and particularly of those which had been heathen temples, the people might build themselves booths round the church, and there feast themselves, in lieu of their ancient sacrifices while they were heathens. The *wakes*, which are still observed in some English countries, are the remains of these feasts of dedication."

2. *Church of Rome.*—"The consecration of a church is performed with much ceremony in the Church of Rome, by whose members this rite is usually termed a dedication. As a preliminary step, the relics which are to be deposited in the altar of the new church are put into a clean vessel, together with three grains of incense, to which a piece of parchment is added, containing the day of the month and year, and the name of the officiating bishop. Three crosses are painted on each of the church walls, and over each cross a candle is placed. On the morning appointed for the ceremony, the bishop, arrayed in his pontifical vestments, and attended by the clergy, goes to the door of the church, where they recite the seven penitential psalms; after which he makes a tour of the church walls, sprinkling them in the name of the Holy Trinity. This rite being performed, he knocks at the church door with his pastoral staff, repeating from Psalm xxiii [xxiv], "*Attollis portas, et introibit Rex Gloria.*" A deacon, shut up in the church, demands, "*Quis est iste Rex Gloria?*" To which the bishop answers, "*Dominus fortis et potens: Dominus potens in prælio?*" At the same time the bishop crosses the door, repeating the following verse:

'Ecce Crucis signum, fugiant phantasmata cuncta!'

On the admission of the bishop and clergy into the church, the *Veni Creator* is sung. Then one of the subdeacons takes ashes, and sprinkles them on the pavement in the form of a cross; next follow the litanies and other parts of divine service. After which the bishop, with his pastoral staff, describes, as with a pen, two alphabets in the ashes sprinkled by the deacon, and proceeds to consecrate the altar by sprinkling it with a mixture of water, wine, salt, and ashes, in the name of Jesus Christ. The consecration of the altar is followed by a solemn procession of the relics, which are deposited under it with great ceremony. During the whole of this imposing solemnity the church is finely adorned, and tapers are lighted upon the altar. Mass is afterwards performed by the bishop, or by

some other person" (Radle, *Ecclesiastical Dictionary*, s. v.).

8. *Protestant Churches*.—The Church of England retains the usage of consecration both for Church edifices and cemeteries. What is called the consecration of a church at present is purely a legal (not a religious) act, duly setting aside a certain building from secular uses. There is no form of prayer for consecration of churches prepared by competent authority; it is left to every bishop to use any which he thinks fit, though the form which was prepared by the bishops in 1712 is that most generally used. But all existing unauthorized forms are illegal, and contrary to the Act of Uniformity (Eden, s. v.). The form of 1712 was adopted, with slight modifications, by the Protestant Episcopal Church in the United States: it is given in the Prayer-book. The form used in the Methodist Episcopal Church (for Dedication) is taken partly from a form of consecration prepared by bishop Andrews, and partly from the above-mentioned form of 1712. It may be found in the *Discipline* (pt. iv, ch. viii). The new "Liturgy of the German Reformed Church" in America contains an excellent form for the consecration of a church, as does also the "Liturgy of the Evangelical Lutheran Church" (§ 18).

Consensus Genevensis, a confession of faith drawn up by Calvin in 1551. Its title is *De aeterna Dei predestinatione, qua in salutem alios ex hominibus elegit, alios vero exitio reliquit, et de providentia, qua res humanas gubernat, consensus pastorum Genevensis ecclesiae, a J. Calvino expositus* (Genev. 1552, 8vo, in Opp. vii, 688). It is given in Niemeyer, *Collectio Confessionum* (1840), p. 218 et sq. Its purpose was to unite the Swiss churches with regard to predestination, as the *Consensus Tigurinus* (q. v.) had served to do with regard to the sacraments. It presents the Calvinistic theory of predestination with great clearness and decision.—Smith's *Hagenbach, History of Doctrines*, § 222; Shedd, *History of Christian Doctrines*, bk. vii, ch. ii, § 2.

Consensus Tigurinus, a confession prepared by Calvin in 1549, and adopted by the Zurich theologians. "It grew out of a desire on the part of Calvin to effect a union among the Reformed upon the doctrine of the Eucharist." Its title is *Consensio mutua in re sacramentaria Ministror. Tigur. et J. Calvini*, and consists of 26 articles (*Calvini Opp. viii*, p. 648 sq. and in his *Tract. theolog.* [Genev. 1611; Amster. 1667, fol.]). It was separately printed in 1554 by Robert Stephen, and is given in Niemeyer, *Confessio Collectionum* [1840], p. 191 sq.).—Shedd, *History of Doctrines*, bk. viii, ch. ii, § 2; Hagenbach, *History of Doctrines*, § 222.

Consilia Evangelica, in the Roman Catholic Church, are such moral counsels as are not obligatory for every Christian, but are advised in order to perfection. The name is generally applied to the three monastic vows of virginity, voluntary poverty, and obedience (to the monastic superior), but some theologians of the Church of Rome count as many as twelve "evangelical counsels." It is needless to say that Protestants admit of no such distinctions.—Herzog, *Real-Encyclop.* iii, 119. See SUPEREROGATION.

Consistory (Lat. *consistorium*), a name designating a college of men who acted as advisers of the Roman emperors in important affairs of the state, as well as the place where these meetings were held. 1. In the *Roman Catholic Church* the name has frequently, but not generally, been used to designate colleges of members of the chapter, also the episcopal chapters themselves, viewed as a whole, in their relations to the bishop and to the diocese. *Papal consistories*, or *consistories of cardinals* (*Consistoria cardinalium*), are meetings of the colleges of cardinals, called by the pope for deliberating on important affairs of the Church, and generally under his presidency. These consistories are partly regular (usually once a night), in which only cardinals take part, under the

presidency of the pope or of the dean of the college of cardinals. They are called *secret consistories* (*consistoria secreta*). When, on solemn occasions, bishops and the ministers of foreign powers are admitted, they are called *public consistories* (*consistoria publica*). The latter are always presided over by the pope. At both the cardinals have only a consultative vote. The subjects which are to be finally disposed of in a consistory are first selected by the pope with the aid of an extraordinary congregation, consisting of the oldest (as to the time of appointment) cardinal bishop, the oldest cardinal priest, and the oldest cardinal deacon, the cardinal vice-chancellor, the cardinal chamberlain, and the cardinal secretary of state; and after that referred for preparatory deliberation to the *Consistorial Congregation*. See CONGREGATION. The resolutions passed at secret consistories are promulgated in a public consistory, and mostly accompanied by a solemn "allegation" (q. v.) of the pope. While presiding the pope is mounted on a magnificent throne and habited in his pontificalia; on his right sit the cardinal bishops and priests, and on the left the cardinal deacons. The other prelates, protonotaries, auditors of the rota, and officers, are seated on the steps of the throne; the courtiers on the ground; ambassadors on the right, and consistorial and fiscal advocates behind the cardinals.—Wetzer u. Welte, *Kirchen-Lex.* ii, 845 and 821.

2. In the *Lutheran state churches* consistories are boards of clerical and lay officers appointed by the sovereign of the country, as highest bishop for the administration and superintendence of ecclesiastical affairs, for exercising jurisdiction in marriage affairs, and for inflicting ecclesiastical penalties. The first consistory was established at Wittenberg in 1537, the second at Leipzig in 1543. The members are called "consistorial councillors," the chief "consistorial president." If there are more than one consistory in a country, a "supreme or national consistory" (*Über-Consistorium, Landes-Consistorium*) is placed over the "provincial consistories." If the right to establish a consistory was conceded by the sovereign of a country to a nobleman or city, such a consistory was called a "mediate consistory" (*Mediat-Consistorium*). Nearly all the consistories of this class have been abolished in modern times. As the power of consistories was defined by the princes, it differed in different countries. In the *Reformed churches* the name consistory is equal to the presbytery of the Presbyterian churches. For full information, consult Böhmer, *Jus Ecclesiasticum Protestantium*, and Richter, *Kirchenordnungen*.

8. The lower Church courts in the *German and Reformed Dutch churches* in America are also called *consistories*.—Herzog, *Real-Encyclop.* iii, 180; Wetzer u. Welte, *Kirchen-Lexikon*, ii, 822; *Constitution of the Reformed Dutch Church*, ch. ii, art. ii.

Consociation. See CONGREGATIONALISTS.

Consolamentum. See CATHARI.

Console (Lat. *consolida*), a bracket to support cornices, figures, busts, etc.

Constance, COUNCIL OF (*Concilium Constantense*), a synod assembled by pope John XXIII, in accordance with the writ of the emperor Sigismund, and which sat from 1414 to 1418. One of its professed objects was to put an end to the schism which had lasted for thirty years, and which was caused by the several claimants of the papacy. At this time, besides John (Balthasar Cossa), two others claimed the title of pope, viz., Pedro of Luna, a native of Catalonia, who styled himself Benedict XIII, and Angelo Corraro, a Venetian, who assumed the name of Gregory XII. Another object of the council was to take cognizance of the so-called heresies of Huss and Wickliffe. The council was convoked to meet at Constance on the festival of All Saints, A.D. 1414, and so great was the influx of persons, that it was reckoned that not less

han thirty thousand horses were brought to Constance, which may give some idea of the enormous concourse of people. It is stated that, during the session, the emperor, the pope, twenty princes, one hundred and forty counts, more than twenty cardinals, seven patriarchs, twenty archbishops, ninety-one bishops, six hundred other clerical dignitaries, and about four thousand priests, were present at this celebrated assembly. The pretended heresies of Wickliffe and Huss were here condemned, and the latter, notwithstanding the assurances of safety given him by the emperor, was burnt, July 6, 1415 [see HUSS], and his friend and companion, Jerome of Prague, met with the same fate May 30, 1416 [see JEROME]. The three popes were formally deposed, and Martin V was legally chosen to the chair of St. Peter; but, instead of furthering the emperor's wishes for a reformation in the affairs of the Church, he thwarted his plans, and nothing was done till the Council of Basle (q. v.). At this council the question was very warmly agitated whether the authority of an oecumenical council is greater than that of a pope or not? Gerson proved that in certain cases the Church, or, which is the same thing, an oecumenical council, can assemble without the command or consent of the pope, even supposing him to have been canonically elected, and to live respectably. These peculiar cases he states to be, "1. If the pope, being accused, and brought into a position requiring the opinion of the Church, refuse to convoke a council for the purpose. 2. When important matters concerning the government of the Church are in agitation, requiring to be set at rest by an oecumenical council, which, nevertheless, the pope refuses to convoke." The sources of information as to this council are ample: among them are Van der Hardt, *Magnam oecumenicum Constantiense Concilium* (ed. Bohnstedt, Berlin, 1742, 6 vols. fol.); Chastenet, *Nouv. Hist. du Concile de Constance* (Paris, 1718, 4to); L'Enfant, *Hist. du Conc. de Constance* (Amst. 1727, fol.); the same translated (Lond. 1730, 2 vols. 4to). See Landon, *Manual of Councils*, 160 sq.; Hase, *Ch. Hist.* 277, 291, 348; Mosheim, *Ch. Hist.* ii, 428 sq.; Wessenberg, *Die grossen Kirchensamml.* vol. ii; Wetzler u. Welte, *Kirchen-Lex.* ii, 849; Herzog, *Real-Encycl.* iii, 144.

Constant, BENJAMIN, a distinguished French politician of the liberal school, was born at Lausanne 1767; educated in England and Germany. He entered public life in 1799; was banished by Napoleon in 1801; took office under Napoleon on his return from Elba, 1814; became a popular representative under Charles X; and died Dec. 8, 1830. He wrote largely in politics; but it is our place only to mention his treatise *De la Religion considérée dans sa source, ses formes et ses développements* (Paris, 1824-31, 5 vols. 8vo), and a posthumous work, *Du Polythéisme romain considéré dans ses rapports avec la philosophie et la religion Chrétienne* (Paris, 1838, 2 vols. 8vo).

Constantine THE GREAT (CONSTANTINUS, CAIUS FLAVIUS VALEBIUS AURELIUS), son of the emperor Constantius Chlorus and of his wife Helena, was born A.D. 272 or 274 (see HELENA) at Naissus (now Nissa) in Illyricum, or, according to other traditions, in Britain. He first distinguished himself by his military talents under Diocletian, in that monarch's famous Egyptian expedition, 296; subsequently he served under Galerius in the Persian war. In 306 the two emperors, Diocletian and Maximian, abdicated, and were succeeded by Constantius Chlorus and Galerius. Galerius, who could not endure the brilliant and energetic genius of Constantine, took every means of exposing him to danger, and it is believed that this was the period when he acquired that mixture of reserve, cunning, and wisdom which was so conspicuous in his conduct in after years. At last Constantine fled to his father, who ruled in the West, and joined him at Boulogne just as he was setting out on an expedition



Ancient Effigies of Constantine and his wife Fausta.

against the Picts in North Britain. Constantius died at York, July 25, 306, having proclaimed his son Constantine his successor. The Roman soldiers, in the Prætorium at York, proclaimed Constantine emperor. He now wrote a conciliatory letter to Galerius, and requested to be acknowledged as Augustus. Galerius, however, would not allow him the title of *Augustus*, and gave him that of *Cæsar* only. Constantine took possession of the countries which had been subject to his father, viz., Gaul, Spain, and Britain; and, having overcome the Franks, he turned his arms against Maxentius, who had usurped the government of Italy and Africa. He conquered Maxentius in three battles, the last at the Milvian bridge, under the walls of Rome. Constantine was now declared by the senate Augustus and Pontifex Maximus (Oct. 28, 312). It was in this campaign that he is said to have seen a flaming cross in the heavens, beneath the sun, bearing this inscription, *In hoc signo vinces*, i. e. "By this sign thou shalt conquer;" and on the same authority it is stated that Christ himself appeared to him the following night and ordered him to take for his standard an imitation of the fiery cross which he had seen. He accordingly caused a standard to be made in this form, which was called the *labarum* (q. v.). This account rests chiefly on the testimony of Eusebius (*Vita Constantini*, i, 29, 30), said to be founded on a communication from Constantine himself. "Lactantius, the earliest witness (*De mortibus persecutorum*, c. 44, a work which may not have been written by Lactantius, but yet was composed about A. D. 314 or 315), speaks only of a dream, in which the emperor was directed to stamp on the shields of his soldiers 'the heavenly sign of God,' that is, the cross, with the name of Christ, and thus to go forth against his enemy" (Schaff, *History of the Christian Church*, vol. ii, § 2, where this point, and indeed the whole relation of Constantine to the Church, is admirably treated). In January, 313, he published the memorable edict of toleration in favor of the Christians, by which all the property that had been taken from the Christians during the persecutions was restored to them. "They were also made eligible to public offices. This edict has accordingly been regarded as marking the triumph of the cross and the downfall of paganism. Having defeated Licinius, who showed a mortal hatred to the Christians, Constantine became sole head of the Eastern and Western empire in 325, the year noted for the oecumenical council which he convened at Nice, in Bithynia, and which he attended in person, for the purpose of settling the Arian controversy. Towards the close of his life he favored the Arians, to which he was induced by Eusebius of Nicomedia, in consequence of which he banished many orthodox bishops. Though he professed Christianity, he was not baptized till he fell sick in 337, in which year he died in Nicomedia" (Buck, *Theol. Dict.* s. v.). The senate of Rome placed him among the gods, and

the Christians of the East reckoned him among the saints: his festival is still celebrated by the Greek, Coptic, and Russian churches on the 21st of May.

"Whatever may have been the true character of Constantine's conversion to the Christian faith, its consequences were of vast importance both to the empire and to the Church of Christ. It opened the way for the unobstructed propagation of the Gospel to a wider extent than at any former period of its history. All impediments to an open profession of Christianity were removed, and it became the established religion of the empire. Numerous, however, in various points of view, as were the advantages accruing to it from this change, it soon began to suffer from being brought into close contact with the fostering influence of secular power. The simplicity of the Gospel was corrupted; pompous rites and ceremonies were introduced; worldly honors and emoluments were conferred on the teachers of Christianity, and the kingdom of Christ in a great measure converted into a kingdom of this world. The character of Constantine has been the object of various and contradictory judgments, according to the religious and political spirit of the various writers. Eusebius, Nazarius, and other Christian contemporaries, grateful for the protection afforded by the emperor to the Christian religion, may be considered his panegyrist, while Zosimus and other heathen writers, animated by an opposite feeling, were his enemies. The brief summing-up of Eutropius is perhaps nearest the truth: 'In the first part of his reign he was equal to the best princes, in the latter to middling ones. He had many great qualities; he was fond of military glory, and was successful. He was also favorable to civil arts and liberal studies; fond of being loved and praised, and liberal to most of his friends. He made many laws; some good and equitable, others superfluous, and some harsh and severe'" (*Hend. Buck*). See Gibbon, *Decline and Fall*, i, 454 sq.; Manso, *Leben Konstantin's* (Breslau, 1817); Keim, *Uebersicht Konstantin zum Christenthum* (Zurich, 1862); Burckhardt, *Die Zeit Konstantin des Grossen*; Schaff, *Ch. Hist.* i. c.; Neander, *Ch. Hist.* (Torrey's ed.), ii, iii; Stanley, *Eastern Church*, Lect. vi. See DONATION.

Constantine, Pope (708-715), a native of Syria, succeeded Sisinnius in 708. He visited Constantinople and Nicomedia, where he was received with great honor by the emperor Justinian the younger. After his return to Rome he defended the worship of images against John, patriarch of Constantinople, and against Philippicus, who had usurped the empire. Felix, archbishop of Ravenna, who had at first refused to acknowledge Constantine, and had been exiled in consequence, made his submission to him, and was reinstated in his see. Constantine died April 8, 715, and was succeeded by Gregory II.—Wetzer und Welte, *Kirch.-Lex.* ii, 888.

Constantinople.—There are few cities which unite more points of interest than Constantinople. It is unsurpassed in many elements of beauty, and for twenty-five centuries has been a place of great political and commercial importance. During several hundred years it was the chief centre of learning, refinement, and military power. As the seat of the Greek Church, in it were held a large number of councils. The indications are that its future will be as important as its past history. Yet no city has suffered more from the desolations of earthquakes, pests, famine, fire, and sword.

I. *History.*—There are three defined epochs: 1, from the foundation of the city (B.C. 667) till it became the capital of the Roman empire (A.D. 808); 2, from this time till its conquest by the Turks (A. D. 1458); and, 8, under the Turkish dominion till the present time.

1. *Byzantium.*—The ancient Greeks attributed the foundation of Byzantium to a colony of Megarians, directed by an oracle of Apollo, built a city (B.

C. 667) on the high land formerly occupied by the old seraglio. This city soon became the entrepôt for the grain trade from the Black Sea to Greece. With out any great military power or ambition of its own Byzantium fell into the hands of the different cities that successively became dominant in Greece. It yielded without resistance to Darius (B.C. 512). The ten thousand rested here in their retreat (B.C. 405). During a siege by Philip of Macedon (B.C. 340), a light suddenly appeared one night, enabling the Athenian garrison to see and thwart an intended assault by the besiegers. In commemoration of this event a crescent appears on some Byzantine coins, and to this is usually attributed the origin of the crescent, the emblem of the Turkish empire, adopted immediately after the conquest of Constantinople. With Greece this city fell under the dominion of Rome (B.C. 146). An ancient legend relates that the apostle St. Andrew, on his arrival at Galata, a suburb of Constantinople, pressed the form of a cross into the rock with his head. After preaching here two years, he was driven away by the tyrant Zeuxippus, and he continued his labor on the opposite Asiatic shore. Byzantium had, in order to resist the frequent sieges of the Northern barbarians, been made the strongest fortified city in the Roman empire. For harboring Piscinus its walls were razed by Septimius Severus (A.D. 169). These were soon rebuilt, but the city was completely destroyed by Constantine (A.D. 324) for having rebelled again.

2. *Under the Eastern Empire.*—Many reasons combined to induce Constantine to remove the capital of the Roman empire from Rome to Byzantium, especially his desire to free himself from the remnants of the power of the Roman senate; his desire to follow the Oriental custom of a great emperor and conqueror founding his own capital; the central commercial position of Byzantium in the then known world, and its favorable position for controlling the troublesome parts of the empire on the Danube and the Euphrates. On May 11, 880, the new capital was inaugurated by festivals and ceremonies, half Christian and half pagan, and lasting forty days. Among the many embellishments which Constantine added to the city were the hippodrome, surrounded by palaces, porticoes, and statues brought from all parts of the Roman empire; the cistern of a thousand columns, the church of St. Sophia, and many other churches and public buildings. Theodosius also greatly embellished and enlarged the capital. In 896 Constantinople became the capital of the Eastern or Greek division of the Roman empire. The glory of the city increased until the time of Heraclius (A.D. 641), although subjected to many scourges. Justinian (527-595) may be regarded as its second founder. After a civil commotion in A.D. 582, in which 80,000 men were slain, and which reduced the city to ashes, Justinian rebuilt St. Sophia with unparalleled magnificence. His gorgeous palace, the twenty-five other churches and many public edifices that he built, have all since perished. The size of the city may be estimated from the fact that 800,000 persons died from the pest in one year. In 675 the Arabs lost 80,000 men before the walls, and in 718 1161 ships of war. The greatest destruction of works of art in all history occurred in the ravaging of Constantinople by the Crusaders (1204), who spent eight days after they took the city in burning and plundering all public and private property. The restoration of the Byzantine empire (1261) had little effect in restoring the glory of the capital. The Genoese and Venetians, who had established themselves in the suburbs of Galata and Pera, had many contests near the city for commercial supremacy. In 1391 the Turks, who had already conquered most of European Turkey, forced the Byzantine emperor to permit a mosque to be erected in Constantinople, to permit the appointment of a kadi to look after the interests of the resident Mohammedan merchants, and to pay the sal-

tan a yearly tribute of 10,000 ducats. In 1458 the Turks took the city by assault, after a siege of forty days. In this siege the Turks had several cannon of three and four feet calibres.

8. *Under the Turks.*—For the space of three days after the taking of the city it was given up to pillage, and was the scene of frightful massacre and destruction of public and private property. After the three days had elapsed Mahomet caused the carnage to be stopped, and offered to such Greeks as chose to remain protection in their property and in the exercise of their religion. The sultan then entered upon the erection of a series of public edifices. He built the castle of seven towers, the two seraglios, and a number of magnificent mosques. He also transformed St. Sophia and other churches into mosques. The chief sultans after Mahomet have followed his example in building at least one magnificent mosque. Constantinople has suffered frequently from fires that have often devastated whole quarters. In 1726 the first printing-press was set up in the city. During an outbreak in the Greek quarter in 1821, during the Greek Revolution, the Greek patriarch was hung by the mob. In 1826 the power of the Janissaries, who had opposed most fanatically the introduction of modern civilization by the sultan, was completely broken by the shooting of 40,000 of them by the other troops of the army.

II. *Description of the City previous to its Occupation by the Turks (1458).*—The ancient Byzantium occupied the extreme point of the peninsula between the Sea of Marmora and the Golden Horn, upon which the great capital was afterwards built. As Constantinople, the city was enlarged to its present limits. On the water side was built a single wall without a ditch. On the land side was a double, later a triple wall, each part from 14 to 20 feet high, 20 feet thick, with a ditch 28 feet broad in front, defended also by 548 towers, and a castle at each corner of the great triangle which the city covered, and penetrated by 8 gates. The private houses were small and poor.

Of the many public places or edifices we can notice but a few. (a) *The Forum of Constantine* (now part of the seraglio palace), which Constantine surrounded with a circus, an imperial palace, churches, baths, and many private palaces. Here he placed the porphyry column surrounded with wreaths of gold, "the Palladium of Rome," which he brought from that city; on this pillar he placed a bronze statue of Apollo, brought from Heliopolis, in Phrygia, and which Constantine wished to have considered as his own statue, substituting the nails of the passion for the rays of the sun, in order to give the statue a resemblance to Christ. This statue is now lost. The column is partly destroyed, the remainder being called the "Burnt Column." (b) *The Forum of Theodosius*, laid out by Theodosius (A. D. 893), and containing a triumphal pillar like the Column of Trajan in Rome, and an equestrian statue of a man with winged feet, whom the popular tradition held to be Joshua commanding the sun to stand still; under the left foot of the horse was buried the *Palladium of Constantinople*, consisting of a doll or body wrapped in woollen garments, and which the Latins (in 1204) dug up and burnt, after having destroyed the statue. (c) *The Forum Bovis*, containing the brazen bull in which criminals were burnt to death. (d) *The Hippodrome or Circus*, near St. Sophia, in which races and other games were held, and which Constantine adorned with the best works of Grecian art, brought from all parts of the empire; over the gate through which the horses entered the circus stood the four horses of Lysippus, which originally were placed in Athens, were brought here from Chios, then taken to Venice (1206), to Paris by Napoleon (1797), and finally returned to Venice (1815); an obelisk, 61 feet high, brought from Egypt to Athens, and thence to Constantinople, is yet standing; the triple bronze snake, that formed the interior of the Tripod of Del-

phos, 18 inches in diameter and 10 feet high, is yet standing, one serpent's head having been cut off by Mahomet with his sabre when he entered the city (1458), the other two having been removed during the last century. These, then, are all the remains of ancient art that have been preserved from the immense number brought to Constantinople. What few the Crusaders left (1204) the Turks have since destroyed. (e) *The Imperial Palace* stood on the site of the old seraglio. It contained many magnificent buildings and rooms; in the chapel of St. Theodor were the relics, consisting of the "original cross" and the "staff of Moses." (f) *The Hebdomon Palace*, where Leo Philosopher held his school, containing five golden towers, supporting a golden tree on which golden birds sung, and containing the "head of John the Baptist." (g) *The Palace and Baths of Leuous*, adorned with many works of art, and containing the imperial library of 120,000 volumes (burnt 475). (h) The many heathen temples were either turned into churches or secularized by Theodosius. (i) *Of churches*, by far the most important is that of *St. Sophia* (q. v.). (j) *The Chorus Church* contained a "picture of the Virgin Mary painted by St. Luke," which the Turks cut to pieces when they took the city. (k) *The Church of the Holy Apostles*, built by Constantine, together with the Heroon (the burial-place of the emperors from the time of Constantine), with their rich ornaments and treasures, were plundered by the Crusaders in 1204, and destroyed in 1468. (l) *The Church of St. George*, the Greek patriarchal church, is an ancient edifice, with many mosaics and Byzantine paintings. Externally it is entirely destitute of ornament. It contains the "chair of St. Chrysostom," richly inlaid with pearl, and on which the patriarch sits during great festivals; also the "pillar to which Christ was bound when he was scourged." (m) *The Blachernen Church*, containing the "holy chest with the garments of the Virgin Mary," and a "miraculous image whose veil lifted itself every Friday evening, and settled down again on Saturday at veapers." On the yearly festival of this church a great procession took place, with the emperor at its head. (n) *The Church of the Virgin at the Golden Spring*, near a spring or cistern of that name containing golden or "fried fish." A tradition has it that "during the last assault by the Turks, a Greek monk in the monastery at this place disbelieved the report that the Turks had entered the walls, saying, 'I would sooner believe that these fish I am frying would leap out of the pan of hot oil and come to life again in the cistern.' Scarcely had he uttered these words when the fish sprang out into the cistern. Their descendants are red on one side and brown on the other, in commemoration of this event." (o) *Monasteries* abounded in the city soon after the origin of this institution. Some of them were large, and occupied slightly positions. (p) *The Jews* were allowed a synagogue by Constantine, but they were expelled from the city by Theodosius. (g) *Large aqueducts* supplied the city with an abundance of water; some of these are yet in use, others are out of repair. (r) *Vast cisterns*, or subterranean reservoirs, were dug out during the reigns of the first emperors. Most of these are now out of repair, and but few contain water. One of the most remarkable of these was the cistern of Philoxenus (now called the cistern of the thousand and one columns), containing three stories, supported each by 224 pillars. It is now used for silk-spinning. It contained 1,000,000 cubic feet of water. The cistern of St. Peter contained 6,000,000 cubic feet of water.

III. *The Modern or Turkish City.*—With Christian nations the city retains its Greek name, Constantinople. The Turks call it *Stamboul*, or *Intamboul*; also *Asnitawa*. The beauty of situation of the city is world-renowned. Each of the seven hills is crowned by a mosque, with its tall slender minarets. The rich profusion of foliage from the public and private gar-

dens blends with the brown of the unpainted wooden houses, and contrasts with the white of the mosques and other public buildings, presenting a picturesque effect to be seen in no other European city. The harbor is crowded with vessels and steamers from all parts of the world. Slight, slender caiques dart between the larger boats, and give an unusual animation to the already over-crowded harbor. The suburbs of Pera and Galata rise on the other side of the Golden Horn, covered with massive palaces and stone houses. Across the Bosphorus is Scutari, with its vast, dark, cypress-bound cemeteries; and in the distance the snow-capped Olympus raises its head above the horizon.

Constantinople is at present the capital of the Turkish empire, of which it forms a distinct province. It is the residence also of the Greek patriarch, who holds here the patriarchal synod, composed of twelve bishops. Here are also an Armenian patriarch and a Greek-Catholic bishop. The Protestant missions of Europe and America for the Orient have their headquarters in Constantinople. The city, with its immediate suburbs, contains above a million inhabitants. Stamboul, or the old city, contains about half this number. More than half of the population are Turks; the remainder are Greeks, Armenians, Bulgarians, and some thousands each of nearly every nation of Europe, Western Asia, and Northern Africa.

Within, the city loses much of its charm. The streets are narrow, uncleanly, and full of dogs; they are not lighted, and every passer-by, after nightfall, is arrested if he has not a lighted lantern: the streets are not named, nor the houses numbered. (a) *The houses* are almost entirely of wood, are unpainted, of two or three stories, and have projecting latticed windows. (b) *Of public squares* there are but few of importance. The chief are the *Hippodrome* (see above, d) and the *Seraskai Place*, containing the offices of the war department and the lofty, fine tower from which is to be obtained the finest view of Constantinople and its environs. This place is about a mile in circumference. (c) *The Seraglio*, once so famous as the splendid palace of the sultans, had not been used as a royal palace since the erection of the new *Seraglio* on the Bosphorus. It was burned in 1865. Near the old seraglio is the office of the grand vizier, entered by the "Sublime Porte," where the sessions of the cabinet are held, and where the sultan meets the foreign ambassadors. There are many *kiosks*, or royal summer-houses on the Bosphorus and the Golden Horn. (d) Constantinople contains thirteen imperial mosques, above a hundred large mosques (or Djami, i. e. places of reunion), and more than a hundred besides of smaller mosques (or Medjid, i. e. places of prayer). The chief mosque is that of *Omar*. See ST. SOPHIA. The second mosque of importance is that of *Achmet the First* (built in 1610). Here are celebrated with great pomp the festival of Bairam, that of Mevloud (the birth of the Prophet), and that of the departure of the caravans for Mecca. It is said to contain a piece of the black stone of Mecca. (e) *Churches and Synagogues*.—The Greeks have twenty-one churches in the old city. Of these, *St. George's* (see above, II, 2) is the chief or patriarchal church. The Armenians have a number of churches, among them the *Patriarchal* church (or, rather, two churches—one for men, the other for women), and the Church of the Nine Angel-choirs, containing a "miracle-working pillar," to which the sick of fevers are brought. The Romish and Protestant churches are in Pera. There are several synagogues in the old city. The British and American Bible Societies have their head-quarters in the old city. (f) There are many Mohammedan monasteries for the different orders of dervishes, and also several Greek monasteries. (g) *Burial-places* for the Turks are found near all the mosques. Burial-chapels (Turbes) for the sultans, the founders of mosques, and their families, are found within the inclosure of the

mosques. (h) *The public instruction* was reorganized in 1847. Schools were divided into three grades. Attendance upon the primary schools is obligatory. In them are taught reading, writing, arithmetic, geography, religion, history of the Turkish empire, and the Turkish language. In the second grade, the history of the Mohammedan religion, mathematics, natural science, and other branches are taught. The technical schools are many in number, as the two schools in the mosques of Achmet and Selim for the persons designed for civil offices; the school founded by the sultanes in 1850 for the education of diplomatists and other high officers of state; the colleges for the education of the ulemas or priests; the schools of military and naval instruction; the college of medicine; the veterinary, and other schools. All of these are supported by the state when the endowments do not suffice. The University, comprising many of their highest schools, has a large building, but is only partly organized. The school systems of the Christians and Jews stand under the direction of their church authorities, and are much neglected. (i) *Of libraries* there are over a hundred smaller ones connected with the mosques, and forty large ones, some of which have fine rooms, and are accessible to non-Mohammedans.

IV. *The Environs of Constantinople*.—(a) *Eyoub*, above Stamboul, on the Golden Horn, is the most sacred spot in Turkey. Eyoub was the standard-bearer of the Prophet, and perished in the first attack on Constantinople by the Saracens (668). His body was miraculously discovered by Mahomet II (1458), who built here the mosque of Eyoub. There is also a stone, surrounded by a silver plate, containing an "impression of the foot of the Prophet," which he made in the rock at the building of the Caaba. Within this mosque is the sword of *Othman*, which the sultans gird on as their inaugural ceremony instead of being crowned. Around the mosque, which is richly built and decorated, are tombs of many great men of state, mingled with trees and shrubbery, and surrounded by hospitals and an extensive cypress-covered grave-yard. (b) *Galata*, on the opposite side of the Golden Horn, was formerly a Genoese city. It now contains many important European houses of business, and one part is filled with the scum of all European nations. (c) *Pera*, on the crown of the hill above Galata, contains the residences of European ambassadors and merchants, many fine and lofty residences, and many Christian churches. (c) At *Kassim-pasha*, where vessels of war are built, and at *Top-kana*, where cannon are made, the works rival those of any European power. (e) *Scutari*, on the Asiatic shore of the Bosphorus, is the landing-place of all the commerce to and from Asia, and hence has many and large khans. As the place from which Mohammedanism set out in its conquest of Europe, it is considered by the Turks to be sacred ground, and its burial-place is by far the largest around Constantinople. Near this burial-place are the famous mosque and barracks of Selim, and the hospital where Florence Nightingale performed her deeds of mercy during the Crimean war. (f) *The Bosphorus* is lined with palaces of the sultan, of pashas, merchants, and ambassadors, and with cities and villages. In one of them, *Bebék*, is a college founded by the missionary Dr. Hamlin, and endowed by American Christians with \$100,000.—Hesychius, *De originibus Constantinopoleos*, 1596 (Leipzig, 1820); Visquesnel, *La Turquie* (Paris, 4 vols. 8vo); Th. Gautier, *Constantinople* (Paris, 1858); Dallaway, *Constantinople, Ancient and Modern*; Adolphe Joanne et Emile Isambert, *Itinéraire, descriptif, historique, et archéologique de l'Orient* (Paris, 1867); Hammer, *Histoire de l'Empire Ottoman* (Paris, 8 vols. 8vo); Hammer, *Constantinople und der Bosphorus*.

CONSTANTINOPLE, COUNCILS OF. I. *General Synods*.—The following are regarded as oecumenical by the Latin or by the Greek Church, or by both: 1.

The First Œcumenical Council of Constantinople (or the second in the list of Œcumenical councils) was convoked at Constantinople in 381 by Theodosius the Great. There were present 150 orthodox bishops (mostly Eastern), and 36 followers of Macedonius, who left Constantinople when their doctrine was rejected by the majority. The council condemned, besides the Macedonians, the Arians, Eunomians, and Eudoxians, and confirmed the resolutions of the Council of Nice. It assigned to the bishop of Constantinople the second rank in the Church, next to the bishop of Rome, and in controversies between the two reserved the decision to the emperor. 2. *The Second Œcumenical Council of Constantinople* (the fifth in the list of Œcumenical councils), held in 553 on account of the Three Chapters' controversy, by 165, mostly Oriental, bishops. This council excommunicated the defenders of the Three Chapters, Theodorus of Mopsuestia, Ibas, and others, and the Roman bishop Vigilius, who refused to condemn the Three Chapters unconditionally. 3. *The Third Œcumenical Council of Constantinople* (the sixth in the list of Œcumenical councils), held from 680 to 681 in the Trullan palace, and attended by 289 bishops, among whom were three Oriental patriarchs, and four legates of the Roman bishop Agathon. The opinions of the Monothelites were condemned, especially through the influence of the Roman legates, as heretical. 4. The General Council convoked in 691 by the emperor Justinian II, and also held in the Trullan palace. As it was regarded as supplementing the fifth and sixth Œcumenical councils, which had given no Church laws, it was called *Quinisexti* (*Synodus*) or *Quinisextum* (*Concilium*). It gave 102 stringent canons on the morals of clergymen and ecclesiastical discipline. It is recognised as an Œcumenical council by the Greeks only. 5. *The fifth Œcumenical Council*, held in 754, and attended by 383 bishops. It passed resolutions against the veneration of images, which were repealed by the second Œcumenical Council of Nice. It is not recognised by the Latin Church, but only by the Greek. 6. *The sixth Œcumenical Council* (by the Church of Rome regarded as the fourth Œcumenical Council of Constantinople, or the eighth in the list of Œcumenical councils), held in 869. It deposed patriarch Photius, restored patriarch Ignatius, and gave laws on Church discipline. It is, of course, not recognised by the Greeks. 7. In 879 another General Synod was held at Constantinople, attended by 380 bishops, among whom were the legates of pope John VIII. Photius was recalled, the resolutions of the preceding council against him repealed, and the position of the patriarch of Constantinople to the pope defined. The Greeks number this council as the Eighth Œcumenical. 8. The ninth Œcumenical Council of the Greek Church was held in Constantinople, under the emperor Andronicus the younger, in 1341. It condemned the opinions of Barlaam as heretical.

II. *Particular Synods*.—The most important of the particular synods are: 1. and 2. In 336 and 389, two Arian synods, under the leadership of Eusebius of Nicomedia. The former deposed and excommunicated Marcellus of Ancyra; the latter deposed and expelled bishop Paulus, of Constantinople, and appointed Eusebius his successor. 3. A semi-Arian synod against Ætius, who was banished. 4. In 426, a synod held against the Messalians; in 448, 449, and 450, synods against the Eutychians. 5. In 495 and 496, Eutychian synods, condemning their opponents, and recognising the *Henoticon* of Zeno. 6. A synod in 516, condemned the resolutions of the Council of Chalcedon. 7. In 586, against Severus, Anthimus, and other chiefs of the Acephall. 8. In 541 (548 ?), against some views of Origen. 9. In 815, two synods on the question of veneration of images, the one, attended by 270 bishops, in favor, and the second against the images. 10. In 861, introducing patriarch Photius, and approving the veneration of images. 11. In 1170 (according to others in

1168), a synod, attended by many Eastern and Western bishops, on the reunion of the Eastern and Latin churches. Similar synods were held in 1277, 1280, 1285, all without effect. 12. In 1450, a council convoked by the emperor Constantine Palæologus deposed the patriarch Gregory, put in his place the patriarch Athanasius, and declined to accept the resolutions passed by the Council of Florence in favor of the union of the Greek and the Latin churches. 13. In 1688 and 1642, two synods held against the crypto-Calvinism of the patriarch Cyril Lucaris.—Pierer, *Univers.-Lex.* iv, 397; Wetzer u. Welte, *Kirchen-Lex.* ii, 838; *Christian Rememb.* April, 1854, art. i; Schaff, *Hist. of the Christian Church*, ii, iii; Landon, *Manual of Councils*; Hefele, *Concil.-Geschichte*; *Edinburgh Review*, July, 1867, p. 49.

CONSTANTINOPLE, PATRIARCHATE OF. Until the time of Constantine the bishop of Constantinople was subject to the bishop of Heraclea as metropolitan. When Constantinople became the residence of the emperor, the dignity of the bishop naturally rose. The second Œcumenical council, in 381, gave to the bishop of Constantinople a precedence of honor next to the bishop of Rome, on the ground that Constantinople was New Rome. This canon implied no extension of jurisdiction except the exemption of the bishop of Constantinople from the metropolitan jurisdiction of the bishop of Heraclea; but gradually the bishop of Constantinople obtained a right of superintendence over the exarchs of the neighboring dioceses. Early in the 5th century an imperial edict placed Eastern Illyricum under the jurisdiction of the bishop of Constantinople, but the Roman bishop Boniface protested against this as an encroachment on the patriarchal rights of Rome in Illyricum, and the decree was not carried through. Theodosius II issued a decree that no bishop in Asia and Thracia should be ordained without the consent of the Council of Constantinople. The execution of this decree met with much opposition, but the metropolitan jurisdiction over Thracia and Asia was nevertheless gradually confirmed, and it was even extended over Pontus and the patriarchate of Antioch. In 451 the Council of Chalcedon formally sanctioned this right of jurisdiction. Canon 9 authorized bishops and clergymen to appeal from the decisions of the metropolitans to either the exarchs or to the see of Constantinople. Canon 28 gave to the bishop of Constantinople equal ecclesiastical prerogatives with the bishop of Rome, stating, however, that the see of Constantinople was the second; and provided that the bishop of Constantinople should have the right to ordain the metropolitans of the three dioceses of Asia, Pontus, and Thracia, and of the bishops of the pagan countries belonging to those three dioceses. The papal legates protested against the 28th canon, and their protest was ratified by the Roman bishop Leo. The opposition of the Roman bishops against this canon prevented it from being received into the Oriental legislation, although the patriarchs of Constantinople never relinquished any of the rights conceded to them by the Council. During the controversy on the images, Leo Isauricus separated the Illyrian churches from the patriarchate of Rome and united them with that of Constantinople. Entire separation from Rome was carried through by the patriarchs Photius and Michael Cædarius. The extensive diocese of the patriarch of Constantinople, containing, since the 8th century, the whole of Eastern Illyricum and the three dioceses of Asia, Thracia, and Pontus, embraced (since the 10th century) also Russia, for which, however, in the 16th century, a special patriarchate was established at Moscow. See RUSSIA. In the 14th century a special Serbian patriarchate was established, which, however, was again dissolved in 1765. See SERBIA. After the establishment of the independence of Greece, the Church of Greece made itself independent of the jurisdiction of the patriarch of Constantinople in 1838. See

GREEK. The Greek bishops of Austria are likewise not subject to the patriarch of Constantinople. See **AUSTRIA**. The jurisdiction of the latter embraces the mediate and immediate provinces of the Turkish empire, with the exception of the patriarchates of Antioch, Alexandria, and Jerusalem, and the archbishoprics of Cyprus and Ochrida in Rumelia. In 1867 the patriarchate of Constantinople had 135 sees, of which 90 are metropolitical and 4 archiepiscopal.

From the conquest of Constantinople by the Latins in 1204 until the reconquest of the city by the Greeks in 1261, there was a Latin patriarch in Constantinople, to whom the pope assigned the highest place in the Church next to himself. Since the destruction of the Byzantine empire the title of patriarch has been given by the popes to some dignitary of Rome. At Constantinople there resides a patriarchal vicar, under whose jurisdiction are about 10,000 Latin Catholics, in Constantinople, Thracia, Macedonia, and Northern Asia Minor.—Herzog, *Real-Encycl.* iii, 188; Wetzler u. Welte, *Kirchen-Lex.* ii, 838; Wiggers, *Kirchl. Statistik*, i, 176; *The Churchman's Calendar for 1867*, p. 39.

Constellation, a cluster of stars, stands in the Auth. Vers. only in Isa. xiii, 10 ("the stars of heaven and constellations thereof shall not give their light"), for the Heb. כִּסְפָא, *kesil'* (in the plur.), i. e. the fat or clear (Sept. Ὀπίωv, Vulg. *splendor*), as a designation apparently of the large stary bodies generally. The same (Heb.) word elsewhere designates some special assemblage of stars ("Orion," Job ix, 9; xxxviii, 31; Amos v, 8); and once the name of a town ("Cheail," Josh. xv, 30). (See Schnaar, *Ueb. d. Sternbilder*, etc. Rink. 1791.) See **ASTRONOMY**.

Constitution, in the Roman Church, a decree of the pope in matters of doctrine. In France, the name has been applied, by way of eminence, to the famous bull *Unigenitus* of the year 1718. See **UNIGENITUS**.

Constitutions, Apostolical. See **CANONS**; **CLEMENTINES**.

Constitutions and Canons, Books of, "the code of 141 rules which regulates the order and worship of the Church of England. The preface thus describes itself: 'Constitutions and canons ecclesiastical, treated upon by the bishop of London, president of the convocation for the province of Canterbury, and the rest of the bishops and clergy of the said province; and agreed upon with the king's majesty's licence, in their synod begun at London, Anno Domini 1603, and in the year of the reign of our sovereign lord James, by the grace of God king of England, France, and Ireland, the first, and of Scotland the thirty-seventh; and now published for the due observation of them by his majesty's authority, under the great seal of England.'"—Eadie, *Eccles. Dict.* s. v. See **CANONS**.

Constitutions of Clarendon. See **CLARENDON**.

Consubstantial, a word of similar import with *co-essential*, denoting something of the same substance with another. The term *ὁμοούσιος* was first used by the fathers of the councils of Antioch and Nicæa to express the orthodox doctrine more precisely. At first the term had only a negative use, as against the Arian heresy; but after the adoption of the Nicene Creed it became a test-word of orthodoxy.—Tomline, *Theology*, ii, 110; Schaff, *History of the Christian Church*, § 127.

Consubstantiation, the doctrine that, in the Lord's Supper, the bread remains bread, and the wine remains wine; but that with and by means of the consecrated elements the true natural body and blood of Christ are communicated to the recipients. It differs from *Transubstantiation* (q. v.) in that it does not imply a change in the substance of the elements.—Brownne on 89 Articles, art. xxviii, § 1; Hagenbach, *History of Doctrines*, ii, 809 (Smith's ed.). See **IMPA-**

NATION; **LORD'S SUPPER**; **LUTHER**; **LUTHERAN CHURCH**; **TRANSUBSTANTIATION**.

Consul (ὕπαρος, i. e. highest in office), a title applied (1 Macc. xv, 16) to Lucius (q. v.), the Roman officer, whose communication to Ptolemy is there cited. The Sept. elsewhere uses the same Greek term as a rendering of the Chald. ܩܘܨܬܐܢܐ, *satraps* ("princes," Dan. iii, 2, 8), and ܩܘܨܬܐܢܐ, *viziers* ("counselors," Dan. vi, 7, etc.). It is often used by classical Greek writers for the Roman *consul*. See **ROME**.

Consumption, as a disease, is the rendering of the Heb. שָׁחַף, *shaché'pheth* (occurs only Lev. xvi, 10; Deut. xxviii, 22), from שָׁחַף, *shachaph'*, to *pin away*; and probably designates a wasting malady. See **DISEASE**.

Contarini, GASPARE, Cardinal, was born in 1483 of a noble Venetian family, and carefully educated. Entering the public service, he was ambassador to Charles V, 1521, and met Luther at Worms. In 1535 he was made cardinal by pope Paul III. In 1538 Contarini, together with the cardinals Caraffa (subsequently Paul IV), Sadolet, and Polus, was appointed a member of a committee on the reformation of the Church. Their report, made to the pope in the same year, and entitled *Consilium de Emendanda Ecclesia*, was printed against their wish and contrary to the order of the pope, and published in a German translation with pungent notes, by Luther. It was subsequently put on the Index. In 1540 Contarini was sent as papal legate to the Diet of Ratisbon, where he showed a conciliatory spirit toward the Protestants, and urgently admonished the bishops to labor for the reformation of the Church. On his return to Italy he was by some accused of having encouraged heresy, but was appointed by the pope cardinal legate of Bologna. His religious feelings were deep; he accepted the doctrine of justification by faith, and looked for a reform of the Roman Church, while he utterly distrusted the Lutheran reformation. He was, on the whole, one of the best men in the Roman Church at the time of the Reformation. He died in Bologna, 1542. Among his writings are, *De Immortalitate Animæ aduersus Petrum Pomponatium*;—*De Libero Arbitrio et Predestinatione*;—*De Septem Ecclesie Sacramentis*;—*Confutatio Articulorum Lutheri*;—*Scholia in Epistolas Diui Pauli*;—*De Officio Episcopis*;—*De Potestate Pontificia* (liberal). His works were collected and published together at Paris (1571, fol.) and Venice (1578, fol.). See Ranke, *History of Popes*, vol. i, passim; Wetzler u. Welte, *Kirchen-Lex.* ii, 860; McCrie, *Reformation in Italy* (Am. ed. p. 171).

Contemplation. See **MYSTICS**.

Contentment (ἀνταρξια, 1 Tim. vi, 6; "sufficiency," 2 Cor. ix, 8) is a disposition of mind in which our desires are confined to what we enjoy without murmuring at our lot, or wishing ardently for more. It stands opposed to envy (James iii, 16); to avarice (Heb. xiii, 5); to pride and ambition (Prov. xiii, 10); to anxiety of mind (Matt. vi, 25, 34); to murmurings and repinings (1 Cor. x, 10). Contentment does not imply unconcern about our welfare, or that we should not have a sense of anything uneasy or distressing; nor does it give any countenance to idleness, or prevent diligent endeavors to improve our circumstances. It implies, however, that our desires of worldly good be moderate; that we do not indulge unnecessary care, or use unlawful efforts to better ourselves; but that we acquiesce with, and make the best of our condition, whatever it be. Contentment arises not from a man's outward condition, but from his inward disposition, and is the genuine offspring of humility, attended with a fixed habitual sense of God's particular providence, the recollection of past mercies, and a just estimate of the true nature of all earthly things. **Mo-**

tives to contentment arise from the consideration of the rectitude of the divine government (Psa. xcvi, 1, 2), the benignity of the divine providence (Psa. cxlv), the greatness of the divine promises (2 Pet. i, 4), our own unworthiness (Gen. xxxii, 10), the punishments we deserve (Lam. iii, 39, 40), the reward which contentment itself brings with it (1 Tim. vi, 6), the speedy termination of all our troubles here, and the prospect of eternal felicity in a future state (Rom. v, 2). See Barrow, *Works*, iii, ser. 5, 6, 7, 8, 9; Burrows, *On Contentment*; Watson, *Art of Contentment*; Dwight, *Theology*, ser. cxxix; Fellows, *Theology*, ii, 423, 500; Buck, *Theol. Dict.* s. v.

Contineney. See CHASTITY; VIRGINITY.

Continents. See ENCRATITES.

Contingency. See FOREKNOWLEDGE; PRE-DESTINATION.

Contract (*συνάλλαγμα*, 1 Macc. xiii, 42), a business agreement or formal compact. See BARGAIN. Various solemnities were used in the conclusion of contracts among the ancient Hebrews. Sometimes it was done by a simple joining of hands (Prov. xi, 21; Ezek. xvii, 18), and thus the Hindoos, to this day, ratify an engagement by one person laying his right hand upon that of the other. Sometimes, also, a covenant was ratified by erecting a heap of stones, to which an appropriate name was given (Gen. xxxi, 44-54); that made between Abraham and the king of Gerar was ratified by the oath of both parties, also by a present from Abraham to the latter of seven ewe lambs, and by giving a name to the well which had occasioned the transaction. Festivities appear to have accompanied the ceremonies attending such alliances, for Isaac and Abimelech made a feast on concluding their covenant (Gen. xxvi, 30; xxxi, 54). A similar practice also obtained among the heathen nations. The Scythians are said to have first poured wine into an earthen vessel, and then the contracting parties, cutting their arms with a knife, let some of the blood run into the wine, with which they stained their armor; after which they themselves, together with the other persons present, drank of the mixture, uttering the direst maledictions on the party who should violate the treaty. Another mode of ratifying covenants was by the superior contracting party presenting to the other some article of his own dress or arms. Thus "Jonathan stripped himself of the robe that was upon him, and gave it to David, and his garments, even to his sword, and to his bow, and to his girdle" (1 Sam. xviii, 4); and at the present day, the highest honor which a king of Persia can bestow upon a subject is to cause himself to be disapparelled, and to give his robe to the favored individual. In Numbers xviii, 19, mention is made of a covenant of salt (q. v.). See OATH.

Among the Hebrews, and, long before them, among the Canaanites, the purchase of anything of consequence was concluded, and the price paid, at the gate of the city, as the seat of judgment, before all who went out and came in (Gen. xxiii, 16, 20; Ruth, iv, 1, 2). From the latter book we also learn that on some occasions of purchase and exchange, the transfer was confirmed by the proprietor plucking off his shoe at the city gate, in the presence of the elders and other witnesses, and handing it over to the new owner.

The earliest notice of written instruments, sealed and delivered, for ratifying the disposal and transfer of property, occurs in Jeremiah xxxii, 10-15, which the prophet commanded Baruch to bury in an earthen vessel, in order to be preserved for production at a future period as evidence of the purchase. No mention is particularly made as to the manner in which deeds were anciently cancelled. Some expositors have imagined that in Colossians ii, 14, Paul refers to the cancelling of them by blotting or drawing a line across them, or by striking them through with a nail; but we have no authority whatever, from antiquity,

to authorize such a conclusion.—Thomson, *Land and Book*, ii, 382-384. See COVENANT.

Contrition, in the Roman Catholic theology, is perfect or thorough repentance (*contritio cordis*), as distinguished from *attrition*, or imperfect repentance, which is not adequate to justification without penance (see ATTRITION for a fuller statement). The Council of Trent makes contrition part of the matter of the sacrament of penance. "The acts of the penitent, namely, contrition, confession, and satisfaction, are the matter, as it were, of this sacrament, which, inasmuch as they are required by divine appointment in order to the completeness of the sacrament, and the full and perfect remission of sins, are for this reason called the parts of penance. . . . Contrition, which holds the first place in the above-mentioned acts of the penitent, is the sorrow and detestation which the mind feels for past sin, with a purpose of sinning no more. Now this emotion of contrition was always necessary in order to obtain the pardon of sins; and when a man has sinned after baptism, it prepares him for the remission of sin, if joined with confidence in the mercy of God, and an earnest desire of performing whatever is necessary to the proper reception of the sacrament. . . . The council further teaches that although it may sometimes happen that this contrition is perfect in charity, and reconciles a man to God before the sacrament of penance is actually received, nevertheless the reconciliation is not to be ascribed to contrition without the desire of the sacrament, which was in fact included in it."—*Canons of Trent*, sess. xiv, chap. iv.

It will be observed from the preceding quotations that the Church of Rome teaches that we are to be truly grieved or sorry on account of our sins; that we are to hate them; and that we must purpose or resolve to forsake them. All this is excellent so far as it goes. But one essential element or mark of true repentance is entirely omitted, or so slightly referred to that this sorrow or hatred of sin, together with all good purposes of amendment, are counteracted, or may be substituted by additional resolutions to do better in future, by priestly absolution, by penances, and by the doctrine of attrition or imperfect contrition. The deficiency to which reference is made is *forsaking sin*. This practical act is overlooked, counteracted, or rendered unnecessary by the resolutions of amendment, absolution, penances, and whatever may pertain to them.—Elliott, *Delineation of Romanism*, bk. x, chap. ii, § 1.

Convent, used in the A. V. only in its old Latin sense of *suitable* or becoming, as a rendering of *יָשָׁר*, *yashar'* (Jer. xl, 4, 5, "right," as often elsewhere), *חֹק*, *chok* (Prov. xxx, 8, an allotted "portion," as sometimes elsewhere), *καθήκον* (Rom. i, 28, "fit," as in Acts xxii, 22), *ἀνήκον* (Eph. v, 4; Philem. 8, "fit," as in Col. iii, 18); but *εὐκαιρός* (Mark vi, 21), *εὐκαιρῶς* (Mark xiv, 11), *εὐκαιρίῳ* (1 Cor. xvi, 12), or simply *καιρός* (Acts xxiv, 25), refer to *opportuneness* of time or season. Similarly in the Apocrypha (*καθήκω*, Eccles. x, 28; 1 Macc. xii, 11; 2 Macc. iv, 19; xi, 86), *ἐπιτήδειος*, (1 Macc. iv, 46; xiv, 84), *ἐπικαιρός* (2 Macc. iv, 32; xiv, 22), simply *καιρός* (Eccles. xxxix, 17), or mere construction (2 Macc. x, 18).

Convent, (1.) the name given in monasteries and similar institutions to the assembly (and the whole) of the members entitled to a vote ("conventuals"). The heads of these institutions (abbots, priors, provosts, rectors, guardians) are bound, in some points of administration, either to hear the counsel or to obtain the consent of the convent. Monastic congregations [see CONGREGATIONS] sometimes hold "general convents" (or "general chapters"), consisting of the abbots of all the houses of the congregation. The constitution of

the mendicant orders and of the regular clerks provides for the holding of "provincial convents" (or provincial chapters), consisting of the heads of the monasteries of a province, and "general convents" (or general chapters), consisting of the chiefs of all the monastic provinces ("provincials"). But the latter, in modern times, have generally fallen into disuse, and written reports have taken their place. (2.) The word is also used to denote a society of monks or nuns in one establishment, or the building itself in which they dwell.—Wetzler u. Welte, *Kirchen-Lex.* ii, 869. See also MONASTERY.

Conventicle (*place of meeting*, Lat. *conventiculum*, diminutive of *conventus*). The word *conventiculum* was known to the primitive Church to designate a house of prayer, *conventicula ubi summus oratur Deus* (Arnob. iv; see also Lactant. v, 11; Orosius, vii, 12). In after times it denoted a cabal among the monks of a convent, to secure the election of some favorite candidate for abbot or superior. The term conventicle is said to have been first applied in England to the assemblies of Wickliffe's followers; but in the reign of Charles II it was given contemptuously to the meetings for religious worship of Protestant dissenters from the Church of England, which were not at the time sanctioned by law.

Conventicle Act, an act of the British Parliament, passed in 1664. It enacted that only five persons above sixteen years of age, besides the family, were to meet for any worship, domestic or social. The first offence on the part of him who officiated was three months' imprisonment, or five pounds' fine; the second, six months' imprisonment, or ten pounds; the third offence was transportation for life, or a fine of one hundred pounds. Those who permitted conventicles to be held in their barns, houses, or outhouses, were liable to the same forfeitures; and married women taken at such meetings were to be imprisoned for twelve months, unless their husbands paid forty shillings for their redemption. The power of enforcing the act was lodged in the hands of a single justice of the peace, who might proceed, without the verdict of a jury, on the bare oath of an informer. In consequence of this act, houses were broken open, goods and cattle distrained, persons arrested, and the jails in the different counties filled with those who had been guilty of no other misdemeanor but that of assembling together to worship God, or listen to the exposition of his holy word.—Buck, *Theol. Dictionary*, s. v.; Neal, *History of the Puritans*, part iv, ch. vii; Orme, *Life of Baxter*, i, 221, 254.

Conventuals, (1.) Monks or clerical knights who are members of a convent, and have the right of voting at the meetings (*conventus*). See CONVENT. (2.) Monks in general, in opposition to hermits. (3.) In several orders, especially the mendicant, Conventuals is a name for those congregations which follow a mitigated rule (see FRANCISCANS, CARMELITES), in opposition to the Observants (q. v.), who demand the observance of the rigorous primitive rule, and who sometimes even pass beyond it. The name is especially applied to the Franciscan conventuals (see FRANCISCANS). (4.) Sometimes, also, a community of candidates for the priesthood, who, in a monastic manner, lived in common under a provost, were designated by this name.

Conversation (דְּרֵכַי, *de'rek way*, Psa. xxxviii, 14; 1, 23; Apocrypha and N. T. ἀναστροφή, but τροπος in 2 Macc. xx, 12; Heb. xiii, 5) is never used in the Scriptures in the sense of *verbal communication*, but always in its now obsolete meaning of course of life or *deportment*, including all one's words and acts. In Phil. i, 27; iii, 20, a different term is found in the original (πολιτεύομαι, *politeuomai*), which literally signifies *residence*, or relations to a community as a citizen. See CITIZENSHIP.

Orientalers are little in the habit of repairing to each

other's houses for the purpose of social intercourse, but rather prefer to resort to some spot out of town, where friends can meet together, and for this purpose the gate of the city is generally chosen. See GATE. Such was the custom of old, and, accordingly, we find that to each city among the Jews there was an open space near the gate, which was fitted up with seats for the accommodation of the people (Gen. xix, 1; Ps. lxxix, 12). Those who were at leisure occupied a position on these seats, and either amused themselves with witnessing those who came in and went out, and with any trifling occurrences that might present themselves to their notice, or attended to the judicial trials, which were commonly investigated at public places of this kind (Gen. xxxiv, 20; Ruth iv, 11; Psa. xxvi, 4, 5; cxxvii, 5). Promenading, so agreeable in colder latitudes, is wearisome and unpleasant in the warm climates of the East, and this is probably one reason why the inhabitants of those climates preferred holding intercourse with one another while sitting near the gate of the city, or beneath the shade of the fig-tree and the vine (1 Sam. xxii, 6; Micah iv, 4).

This mode of passing the time is still customary in the East. "It is no uncommon thing," says Mr. Jewett, "to see an individual or a group of persons, even when very well dressed, sitting with their feet drawn under them, upon the bare earth, passing whole hours in idle conversation. Europeans would require a chair, but the natives here (Syria) prefer the ground; in the heat of summer and autumn, it is pleasant to them to while away their time in this manner under the shade of a tree. Richly-adorned females, as well as men, may often be seen thus amusing themselves."

The Orientals, when engaged in conversation, are, in general, very mild in their demeanor, and do not feel themselves at liberty directly to contradict the person with whom they are conversing, although they may at the same time be aware that he is telling them falsehoods. The ancient Hebrews, in particular, very rarely used any terms of reproach more severe than those of שָׂטָן, *satan*, meaning "adversary," or "opposer;" רֵיקָה, *reykah*, *paká*, "contemptible;" and sometimes נָבָל, *nabal*, "fool," an expression which means "a wicked man," or "an atheist," not, as with us, a person deficient in understanding (Job ii, 10; Psa. xiv, 1; Isa. xxxii, 6; Matt. v, 22; xvi, 23). See FOOL. When anything was said which was not acceptable, the dissatisfied person replied, "Let it suffice thee" (Deut. iii, 26), or "It is enough" (Luke xxii, 88). In addressing a superior, the Hebrews did not commonly use the pronouns of the first and second person, but instead of "I," they said "thy servant," and instead of "thou," they employed the words "my lord." Instances of this mode of expression repeatedly occur in Scripture (as in Gen. xxxii, 4; xlv, 16, 19; xli, 84; Dan. x, 17; Luke i, 38).

The form of assent or affirmation was, "Thou hast said," or "Thou hast rightly said;" and modern travellers inform us that this is the prevailing mode of a person's expressing his assent or affirmation to this day in some parts of the East, especially when they do not wish to assert anything in express terms (comp. Matt. xxvi, 64). See AFFIRMATIVE.

Conversion, a theological term, used to denote the "turning" of a sinner to God. It occurs in Acts xv, 3 ("declaring the conversion [ἐπιστροφή] of the Gentiles"). The verb ἐπιστρέφω is used in the N. T. actively in the sense of turning or converting others (Luke i, 16, et al.); intransitively, in the sense of "turning back," "returning;" and tropically, to denote "turning to good," "to be converted" (Luke xxii, 32, "when thou art converted, strengthen the brethren"). In general, the word is used to designate the "turning of men from darkness unto light, and from the power of Satan unto God" (Acts xxvi, 18). In a general sense, heathens or infidels are "convert-

ed" when they abandon paganism or unbelief, and embrace the Christian faith; and men in general are properly said to be "converted" when they are brought to a change of life through the influence of divine grace upon the soul.

Specifically, then, conversion may be said to be "that change in the thoughts, desires, dispositions, and life of a sinner which is brought about when the Holy Ghost enters the heart as the result of the exercise of a saving faith in the atonement, by which the sinner is justified. The process by which this great change is effected is this: The sinner is convinced of sin by the Holy Spirit; he exercises a penitent faith in Christ as his Saviour; God immediately justifies him; the Holy Spirit attests to the penitent the fact of his pardon, and instantly sheds abroad the love of God in the heart, when all things are indeed new" (Farrar, *Biblical Dictionary*, s. v.).

The word is also used, in a narrower sense, to denote the "voluntary act of the soul consciously embracing Christ in faith;" and in this sense it is to be distinguished from regeneration, which is "a second creation," wrought only by the Spirit of God. Kling, in *Herzog, Real-Encyclopädie* (s. v. Bekehrung), gives the following statement of the relations between God and man in the whole work of conversion: "It is not a purely personal act of man (Jer. xxxi, 18, *Turn thou me and I shall be turned*), but includes both the divine act and the human. Conviction, calling, and justification are of God. The Word of God declares God's will convincingly in the law, and offers salvation through faith in Christ in the Gospel. In Christ law and Gospel are united. None of these divine acts preclude man's activity (Phil. ii, 12, *Work out your own salvation*, etc.). . . . The truth lies midway between that extreme, on the one hand, which teaches that the will of man is entirely absorbed by the grace of God, and that false Synergism, on the other, which conceives man's will as capable of action, in the work of conversion, without the inworking of divine grace."

Wesley (*Letter to Bishop Lavington, Works*, v, 368) remarks: "Conversion is a term I very rarely use, because it rarely occurs in the N. T." Lavington had spoken of Wesley's idea of conversion as "to start up perfect men at once." "Indeed, sir," replies Wesley, "it is not. A man is usually converted before he is a perfect man. It is probable most of those Ephesians to whom St. Paul directed his epistles were converted, yet they were not come (few, if any) to a perfect man, to the measure of the stature of the fulness of Christ." See REPENTANCE; REGENERATION.

CONVERSION OF ST. PAUL, FEAST OF THE, observed in the Roman Church on the 25th of January. It is generally supposed that this festival had its beginning in the year 1200, when it was established by order of Innocent III. Baronius says it was observed in earlier times, but had grown into disuse after the 9th century. After the 13th century it became generally observed. See PAUL.

Conviction. The first stage of repentance, when a penitent is led to see the evil nature of sin, and has been *proved*, to himself, *guilty* of it. See REPENTANCE.

Convocation (מִקְרָא, *mikra'*, from קָרָא, *kara'*, to call; comp. Num. x, 2; Isa. i, 13), applied invariably to meetings of a religious character, in contradistinction to *congregation*, in which political and legal matters were occasionally settled. See GOVERNMENT. Hence it is connected with קָדֵשׁ, *holy*, and is applied only to the Sabbath and the great annual festivals of the Jews (Exod. xii, 16; Lev. xxiii, 2 sq.; Num. xxviii, 18 sq.; xxix, 1 sq.). In this sense, with one exception (Isa. i, 13, "assembly"), the word is peculiar to the Pentateuch; but in Isa. iv, 5, it denotes the *place* of gathering ("assemblies"), and in Neh. viii, 3, it signifies the public "*reading*" of the law in the

synagogue service. The Sept. treats it as an adjective (κλητός, *κλητικός*; *called*); but there can be no doubt that the A. V. is correct in its rendering (Smith, s. v.). See CONGREGATION. Like the Greek πανήγυρις or mass-meeting (Smith's *Dict. of Class. Antiq.* s. v. Panegyris), it signifies "a meeting or solemn assembly of a whole people for the purpose of worshipping at a common sanctuary." The phrase "holy convocation" is applied, I. To the FEASTS: 1. To the *Sabbaths*, all of which were "holy convocations" (Lev. xxiii, 2, 8). 2. To the *Passover*: (a.) its *first day* (Exod. xii, 16; Lev. xxiii, 7; Num. xxviii, 18); (b.) its *last day* (Exod. xii, 16; Lev. xxiii, 8; Num. xxviii, 25). 3. To the *Pentecost* (Lev. xxiii, 21). 4. To the *Feast of Trumpets* on the 1st of Tisri, the New Year's day of the civil year (Lev. xxviii, 24; Num. xxix, 1). 5. To the *Feast of Weeks* or *First-fruits* (Num. xxviii, 26). 6. To the *Feast of Tabernacles*: (a.) its *first day* (Lev. xxiii, 35; Num. xxix, 12); (b.) its *last day* (Lev. xxiii, 36). 7. As introductory to the enumeration of these feasts (Lev. xxiii, 4), and as closing it (ver. 7). II. To the one great FEAST, the annual *Day of Atonement* (Lev. xxiii, 27; Num. xxix, 7). To the deep solemnities of "the Holy Convocation," whether of joy or of sorrow ("afflicting the soul," as in the last passage), one great feature was common, marked by the command, "Ye shall do no servile work therein" (see all the passages); or more fully in Exod. xii, 16, "No manner of work shall be done in them, save that which every man must eat, that only may be done of you." (Such as are curious about the Rabbinical opinions of what might be done, and what might not, on these occasions, may find them in Buxtorf's *Synagoga Judaica*, especially ch. xix; the joyous celebrations are described in ch. xxi, and the expiatory in ch. xxv, xxvi; see also Ugolini *Theaur.* iv, 988-1052.) With this may be compared Strabo's statement (bk. x), "This is a common practice both of Greeks and barbarians, to perform their sacred services with a festive cessation of labor." See SABBATH.

CONVOCAATION, a convention of the English clergy to discuss ecclesiastical affairs in time of Parliament. This body grew out of the ecclesiastical councils held in the earlier times. From the time of Edward I, when the Commons were first assembled in Parliament, it became the practice to summon the Convocation at the same time. About the year 1400 it assumed its present form. There was at this time a Convocation for the province of York, and another for that of Canterbury. At the Reformation the king assumed the title of supreme head of the Church. Both convocations hesitated to acknowledge his claim, but the king, says Strype, made them buckle to at last; and the recognition of his supremacy was made at Canterbury in 1531, and the next year at York. In 1532 the Act of Submission passed: it required the clergy, in the first place, to consent that no ordinance or constitution should be enacted or enforced but with the king's permission; secondly, that the existing constitutions should be revised by his majesty's commissioners; and, thirdly, that all other constitutions, being agreeable to the laws of God and of the land, should be enforced. The bishops demurred, but the king and the commons were against them, and they were compelled to yield; and in 1534 their submission was confirmed by act of Parliament. Since this period the Convocation can only be assembled by the king's writ; when assembled, it cannot make new canons without a royal license, which is a separate act from the permission to assemble; having agreed upon canons with the royal license, they cannot be published or take effect until confirmed by the sovereign; nor, lastly, can they enact any canon which is against the law or customs of the land or the king's prerogative, even should the king himself consent. Prior to this period, the archbishop of each province could assemble his provincial synod at his pleasure; though,

at the same time, the sovereign could summon both provinces by a royal writ (Hook).

England is divided into the two provinces of Canterbury and York, and by the term Convocation is meant the synod or provincial council of those provinces. There are, therefore, two convocations, each independent of the other; but instances have frequently occurred in which they have acted together by mutual consent. Commissioners have sometimes been sent from York to sit in the Convocation of Canterbury, with full powers to act on behalf of the northern Convocation. Since the Reformation, for obvious reasons, the legislation of the Church of England was virtually in the hands of the southern Convocation. That of York seldom originated any important measure, or persisted long in resisting the decisions of Canterbury. It became at length the faint echo of its more favored sister's voice. The Convocation of Canterbury consists of all the bishops of the province, who constitute the upper house; and of the deans, archdeacons, proctors of chapters, and proctors for the parochial clergy, who compose the lower house. In 1867 the upper house of Canterbury consisted of 21 members, and that of York of 7 members; while the lower house of Canterbury had 146 (namely, 24 deans, 56 archdeacons, 24 proctors for cathedral chapters, and 24 proctors for the clergy), and that of York 57 members (6 deans, 15 archdeacons, 7 proctors of the chapters, and 29 proctors for the clergy). As president, the archbishop summons the Convocation to meet at the command of the king. Were he to attempt to assemble a synod by his own authority, he would be subject to a *premunire*, and the proceedings of such synod would be void. Since the Act of Submission the power to summon the Convocation at the commencement of a new Parliament has usually been granted, though from the time of George I (1717) until recently no business was transacted. It is also the duty of the archbishop to prorogue and dissolve the Convocation, under the direction of the crown. Of late the convocations of Canterbury and York have been revived, and the revival of the Irish Convocation has been strenuously urged, especially by the High-Church party. The decisions of Convocation have no legal force in England. "As essentially interwoven with the State, the Church possesses no independent action; its articles, liturgy, organization as to benefices, etc., are all regulated by Parliament; while its discipline falls within the scope of the ecclesiastical courts, a class of tribunals apart from the ministering clergy. The Church, therefore, in its distinct capacity, is left little to do in the way of jurisdiction. It is further urged, as a reason for restricting the power of Convocation, that, being purely sacerdotal, it might be apt to run into excesses, and put forth claims adverse to the prevailing tone of sentiment on religious matters; that, in short, as things stand, it is safer for the public to be under the authority of Parliament than to be subject to the ordinances of a body of ecclesiastics" (Chambers, *Encyclopædia*, s. v.). There is an able article against the revival of Convocations in the *Edinb. Rev.* Jan. 1857. For further information as to the history of Convocation, see Collier, *Eccles. Hist. of Great Britain*; Wilkins, *Concilia Magna Britannia* (London, 1787, 4 vols. fol.); Wake, *State of the Ch. of England*, etc. (Lond. 1708, fol., containing a large collection of documents on Convocation); Fellows, *Convocation: its Origin, Progress, and Authority, Legislative and Judicial, with a Scheme for amending its Power and Constitution* (Lond. 1852; proposes to establish one Convocation instead of the three [2 English, 1 Irish] then in existence); Lathbury, *Hist. of Convocation* (Lond. 1853, 8vo, 2d ed.); Landon, *Manual of Councils*, s. v. *London*; Cardwell, *Documentary Annals* (Oxf. 1844, 2 vols. 8vo); Marsden, *Churches and Sects*, p. 308 sq.; *Christ. Remembrancer*, Oct. 1854, p. 369; Overall, *Convocation Book* (Oxford, 1844, 8vo); Palmer, *On the Church*.

Convulsionists, a term applied to persons who were the subjects of fits, of which they were said to be cured by visiting the tomb of the abbé Paris, a celebrated zealot among the Jansenists. The name was afterwards given, in France, to those whose fanaticism or imposture caused them to work themselves up into the strongest agitations or convulsions, during which they received wonderful revelations, and abandoned themselves to the most extravagant antics that were ever exhibited. They threw themselves into the most violent contortions of body, rolled about on the ground, imitated birds and beasts; and, when they had completely exhausted themselves, went off in a swoon. Pinault, an advocate, who belonged to the convulsionists, maintained that God had sent him a peculiar kind of fits to humble his pride. See JANSENISM.

Conybeare, John, D.D., a learned divine and distinguished preacher, was born at Pinhoe, Devonshire, in 1692, and was educated at Exeter College, Oxford, of which he became fellow in 1710. In 1724 he became rector of St. Clement's, Oxford, and in 1727 obtained great celebrity by his visitation sermon on subscription. He was appointed rector of his college in 1780, dean of Christ Church two years after, and finally bishop of Bristol in 1750. He died at Bath, July 18, 1756. He published several works, the most important of which are, *A Defense of Revealed Religion against the Exceptions of [Tindal's] Christianity as Old as the Creation* (Lond. 1782, 8vo);—*Sermons* (London, 1757, 2 vols. 8vo).—Darling, *Cycl. Bibl.* s. v.

Conybeare, William Daniel, dean of Llandaff, was born at his father's rectory, St. Botolph's, Bishopsgate, June 7, 1787. He entered Christ Church College, Oxford, in January, 1805, and took his degree of B.A. in 1808 and M.A. in 1811. Mr. Conybeare was one of the earliest promoters of the Geological Society, and the important services he has rendered to geological science may be seen in his numerous papers printed in the society's "Transactions." In 1839 he was Bampton lecturer, and was made dean of Llandaff in 1845. He died near Portsmouth, Aug. 12, 1857. Besides his numerous writings on geological topics, he published *The Christian Fathers during the Ante-Nicene Period* (Oxf. 1839, Bampton Lecture, 8vo); *Elementary Course of Theological Lectures* (Lond. 1836, sm. 8vo).

Conybeare, W. J., son of the preceding, was a frequent contributor to the *Edinburgh Review*, especially on ecclesiastical topics. Together with the Rev. J. S. Howson, he published the *Life and Epistles of St. Paul* (Lond. 1854, 2 vols. 8vo, reprinted in N. Y.); also abridged, 2 vols. 12mo), one of the best works of its class. He died in 1857.

Cook (male, כֹּהֵן, *tabbach'*, 1 Sam. ix, 23, 24; female, כֹּהֵנִי, *tabbachak'*, viii, 3, both properly a slayer), a person employed in families of rank to perform culinary service. Cooking (בִּשְׁלוּת, *bashakut'*), however, among the Hebrews (at least in early times) was generally done by the matron of the family, even though she were a princess (Gen. xviii, 2-6; Judges vi, 19). Among the Egyptians the cook was a professional character. (See Wilkinson's *Ancient Egyptians*, i, 174, abridgm.) The process of cooking seems to have been very expeditiously performed (Gen. xxvii, 8, 4, 9, 10), and all the flesh of the slain animal, owing to the difficulty of preserving it in a warm climate, was commonly cooked at once, which is the custom of the East at the present day. (See Rosenmüller, *Morgenl.* ii, 117; Thomson, *Land and Book*, ii, 162.) See FOOD. The Assyrian monuments lately discovered by Layard and Botta contain similar delineations of eunuchs cooking over charcoal braziers, and engaged in other culinary operations, often attended by a servant with a fly-flap. See BAKE; CRACKNEL.

"As flesh-meat did not form an article of ordinary

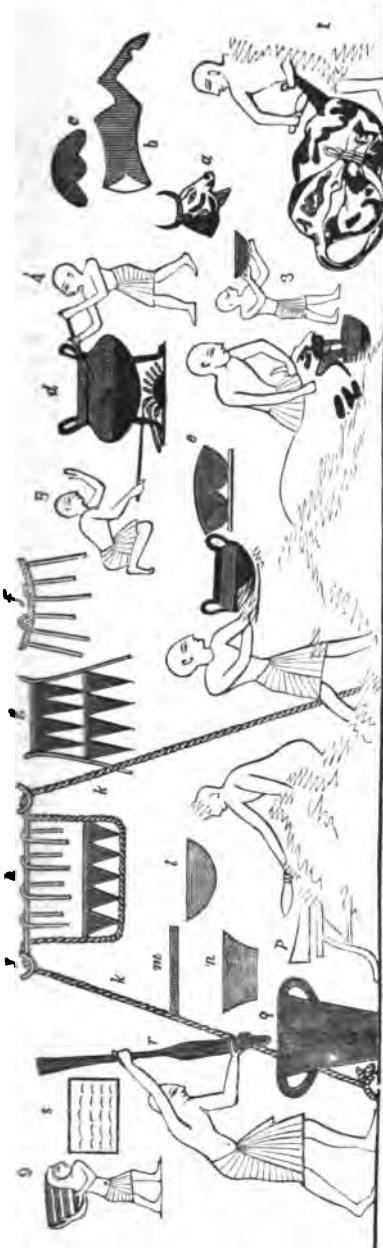

Ancient Egyptian Kitchen.

Fig. 1. Killing and preparing the joints, which are placed at a, b, c. 2. Catching the blood for the purposes of cookery, which is removed in a bowl by fig. 3. 4 and 5. Employed in boiling meat in a large pot, d, and stirring the fire. 7. Preparing on a chopping-board, p, the meat for the caldron, which fig. 6 is taking to the fire. 8. Pounding some ingredients for the cook with a pestle, r, in a mortar, q. 9. Bringing a pile apparently of platters or bowls, s. Probably a piece of meat. f, A. Apparently siphons for drawing liquids from various vessels, l, m, n. 6. Perhaps bottles in a rack. k. Ropes passing through rings, i, j, and supporting different things, as a sort of scaff. 4. Probably plates. 7. A coil. u, v. Tables.

liet among the Jews, the art of cooking was not carried to any perfection; and, owing to the difficulty of reserving it from putrefaction, few animals (other than sacrifices) were slaughtered except for purposes of hospitality or festivity. The proceedings on such occasions appear to have been as follow: On the arrival of a guest, the animal, either a kid, lamb, or calf, was killed (Gen. xviii, 7; Luke xv, 28), its throat being cut so that the blood might be poured out (Lev. xii, 26); it was then flayed, and was ready either for roasting (צֶלֶה) or boiling (בֶּשֶׁל); in the former case the animal was preserved entire (Exod. xii, 46), and roasted either over a fire (Exod. xii, 8) of wood (Isa. xlv, 16), or perhaps, as the mention of fire implies another method, in an oven, consisting simply of a

hole dug in the earth, well heated, and covered up (Burckhardt, *Notes on Bedouins*, 1, 240). The Paschal lamb was roasted by the first of these methods (Exod. xii, 8, 9; 2 Chron. xxxv, 18). Boiling, however, was the more usual method of cooking, both in the case of sacrifices, other than the Paschal lamb (Lev. viii, 31), and for domestic purposes (Exod. xvi, 28), so much so that בָּשָׁל, *bashal*, to cook, generally included even roasting (Deut. xvi, 7). In this case the animal was cut up, the right shoulder being first taken off (hence the priest's joint, Lev. vii, 82), and the other joints in succession; the flesh was separated from the bones and minced, and the bones themselves were broken up (Micah iii, 8); the whole mass was then thrown into a caldron (Ezek. xxiv, 4, 5) filled with water (Exod. xii, 9), or, as we may infer from Exod. xxiii, 19, occasionally with milk, as is still usual among the Arabs (Burckhardt, *Notes*, i, 68), the prohibition 'not to seethe a kid in his mother's milk' having reference apparently to some heathen practice connected with the offering of the first-fruits (Exod. i. c.; xxxiv, 26), which rendered the kid so prepared unclean food (Deut. xiv, 21). No cooking was allowed the Jews on the Sabbath (Exod. xxxv, 8). See FIRE. The materials for making coals were grass and cow-dung. See FUEL. The caldron was boiled over a wood fire (Ezek. xxiv, 10); the scum which rose to the surface was from time to time removed, otherwise the meat would turn out loathsome (6); salt or spices were thrown in to season it (10); and when sufficiently boiled, the meat and the broth (בֶּרַק; Sept. ζωμός; Vulg. jus) were served up separately (Judg. vi, 19), the broth being used with unleavened bread, and butter (Gen. xviii, 8) as a sauce for dipping morsels of bread into (Burckhardt, *Notes*, i, 68). Sometimes the meat was so highly spiced that its flavor could hardly be distinguished: such dishes were called מַטַּמְמִים, *matammim* (Gen. xxvii, 4; Prov. xxiii, 8). There is a striking similarity in the culinary operations of the Hebrews and Egyptians (Wilkinson's *Anc. Egypt*, ii, 874 sq.). Vegetables were usually boiled, and served up as pottage (Gen. xxv, 29; 2 Kings iv, 38). Fish was also cooked (Luke xxiv, 42), probably broiled. The cooking was in early times performed by the mistress of the household (Gen. xviii, 6); professional cooks were afterwards employed (1 Sam. viii, 18; ix, 28). The utensils required were: מִיָּרֵיחַ, *kiryayim* (Sept. χυτροπόδες; Vulg. *chytrópodes*), a cooking range, having places for two or more pots, probably of earthenware (Lev. xi, 85); מִיָּרֵיחַ, *kayor* (λίβης, *lebes*), a caldron (1 Sam. ii, 14); מַצְלֵג, *mazoleg* (απειργα; *fucimula*), a large fork or flesh-hook; סִיר, *sir* (λίβης; *olla*), a wide, open metal vessel, resembling a fish-kettle, adapted to be used as a wash-pot (Psa. lx, 8) or to eat from (Exod. xvi, 8); מְרִיר, *parur*; רִיד, *rud*; מַלְלַחֵי אֵת, *kallach'ath*, pots probably of earthenware and high, but how differing from each other does not appear; and, lastly, מַלְלַחֵי אֵת, *tsalach'ath*, or מַלְלַחֵי אֵת, *tselochih'ath*, dishes (2 Kings ii, 20; xxi, 18; Prov. xix, 24; A. V. 'bosom').—Smith, s. v. The מַלְלַחֵי אֵת, *re'tseph* (תַּמְצוֹן, *tamtsun*), was, according to Gesenius, a hot stone, used for baking on; or, as Winer thinks (in *Synonym. Lex.* p. 926), for cooking milk or broth, by throwing it into the vessel; but

Fürst regards it as simply meaning live embers. See VICTUALS.



Royal Kitchen of the Ancient Assyrians.

Cook, Charles, D.D., one of the founders of French Methodism, was born in London, May 31, 1787. Skeptical in youth, he was converted at twenty-one, chiefly under the instruction of the Rev. Jacob Stanley. After spending a few years as tutor in a seminary, he entered the ministry of the Wesleyan Methodist Church in 1817. In 1818 he was sent to France, and commenced his ministry at Caen, in Normandy. He soon acquired a good French style, both in writing and speaking, and became eminently popular and useful as an evangelist. The Sunday-school Society and Bible Society were originated chiefly through the impulse given by him. In numerous evangelical journeys, especially in the south of France, he preached in the Reformed churches with great acceptance, and revivals of religion followed his labors. His administrative talent was very great. Merle d'Aubigné, in a letter to M. Gallienne, president of the French Conference, says that Cook "was to France, Switzerland, and Sardinia what Wesley was in his day to England." He died Feb. 21, 1858.—J. P. Cook, *Vie de Charles Cook* (Paris, 1862); Stevens, *History of Methodism*.

Cook, Russell S., an American Congregational clergyman, was born in New Marlborough, Mass., March 6, 1811. After being for a short time in a lawyer's office, he studied theology at the Theological Seminary at Auburn. In 1836 he was ordained pastor of the Congregational church in Lanesboro, Mass. In 1839 he was elected secretary of the American Tract Society, in which office he remained until 1856, when failing health obliged him to retire. He was a regular contributor to the *American Messenger*, the monthly organ of the society; and to his labor the development of the colportage system was greatly due. After a visit to Europe in 1856, he in 1857 became the secretary of the Sabbath Committee in New York, and in 1863 he added to his work on this committee several weeks of exhausting labor in organizing and energizing the Christian Commission in New York. He died at Pleasant Valley, near Poughkeepsie, N. Y., Sept. 4, 1864.—See *Annual American Cyclop. for 1864*, p. 354.

Cook, Valentine, a Methodist Episcopal minister. He was born in Pennsylvania (date wanting), of pious and cultivated parents; removed early to Western Virginia; was converted in youth; entered Cokesbury College while a boy, where he was one of the four boys placed on the charity foundation, and, after a partial course in 1787, entered the itinerant ministry in 1788. In 1794-7 he was presiding elder on Philadelphia and Pittsburgh districts; and in 1798, missionary to Kentucky. In 1799 he took charge of Bethel

Seminary, the second Methodist literary institution in America; afterwards was some time principal of Harrodsburg Academy, and finally removed to a farm near Russellville, Logan Co., Ky., where he resided until his death. In his youth he was very studious and serious, and became in subsequent life a good classical scholar. He had great reputation as an eloquent and effective minister. Many were converted by his preaching, and his influence was widely extended.—Stevenson, *Life of Cook* (Nashville, 1856, 12mo); *Methodist Quart. Rev.* April, 1859, p. 183; Geo. Peck, D.D., *Essays on Methodism* (N. Y. 1860, 12mo, p. 71, 72, 96); Sprague, *Annals*, vii, 151; Summers, *Biograph. Sketches*, p. 15.

Cooke, Parsons, D.D., an American Congregational minister, was born in Hadley, Mass., in 1800. He was educated at Williams College, where he graduated in 1821. In 1826 he was ordained as pastor of the Congregational church in Ware, Mass. After continuing in this pastorate for ten or eleven years, he became pastor of the First Congregational church in Lynn, Mass., with which he remained until his death, a period of twenty-eight years. While pastor at Lynn he established the "New England Puritan," which, after some time, was united with the "Recorder," under the name of the "Puritan Recorder," which was later changed to that of the "Boston Recorder," of which Mr. Cooke became, and remained until his death, the senior editor. In 1829 he published a sermon on *The Exclusiveness of Unitarianism*, and afterwards several other controversial writings. He died at Lynn, Feb. 12, 1864.—See *Annual American Cyclop. for 1864*, p. 856.

Cookman, George G., one of the most distinguished orators of the American pulpit, was born in 1800, at Hull, England. His father, a man of wealth and position, was a Wesleyan local preacher, and gave his children a thorough religious training and a careful academical education. In early youth Cookman gave promise of his powers in oratory by speeches at Sunday-school anniversaries, etc., which excited extraordinary interest. When about twenty-one years old he visited America on business for his father, and while at Schenectady, N. Y., he began his labors as a local preacher. In 1821 he returned to Hull, and entered into business with his father, exercising his talents meanwhile zealously in the Wesleyan local ministry. He continued in his father's firm during four years, but with a restless spirit; and finally, deciding to enter the ministry in America, he took passage for Philadelphia in 1825. After laboring a few months in that city as a local preacher, he was received into the Philadelphia Conference in 1826. He continued in the itinerant ranks, without intermission, the remainder of his life, laboring with indomitable energy, and constantly increasing ability and success, in various parts of Pennsylvania, New Jersey, Maryland, and the District of Columbia.

Mr. Cookman was slight, but sinewy in person, and capable of great endurance. His arms were knotted, which gave a striking peculiarity to his gestures. In the act of public speaking, every nerve and muscle of his lithe frame seemed instinct with the excitement of his subject. In 1838-39 he was chaplain to the American Congress, and the Hall of Representatives at Washington never echoed more eloquent tones than during his chaplaincy to Congress. Several of his distinguished hearers, both in Congress and the executive department of the government, were awakened to a personal interest in religion by his powerful appeals. Imagination was Mr. Cookman's dominant mental faculty. It can hardly be doubted that, had he devoted himself to the production of some work in this rare and difficult department of literature, he might have become a worthy disciple of the glorious old dreamer of Bedford Jail. On the 11th of March 1841, he embarked in the ill-fated steamer *President*

visit to England, and was never heard of more. Few of his sermons and speeches have been published. A small volume of *Speeches* (N. Y. 1841, 18mo) contains those referred to above and some others. It is hoped that a suitable memoir of this distinguished man will yet be given to the world.—*National Magazine*, Aug. 1855; *Methodist Quart. Review*, July, 1852; *Prague, Annals*, vii, 711.

Cooper, Ezekiel, an early and celebrated Methodist preacher, born in Caroline County, Md., Feb. 22, 1768. He joined the Conference in 1785; labored from Boston to Baltimore as a travelling preacher for many years, and was editor and general agent of the Book Concern from 1799 to 1804. His abilities for this office were soon shown to be of the highest order. He gave to the "Book Concern" an impulse and organization which has rendered it the largest publishing establishment in the New World. After managing its interests with admirable success for six years, during which its capital stock had risen from almost nothing to forty-five thousand dollars, he resumed his itinerant labors, and continued them in Brooklyn, New York city, Wilmington, Del., Baltimore, etc., for eight years, when he located. He remained in the latter relation during eight years, when he re-entered the travelling ministry, but was soon afterwards placed on the supernumerary list in the Philadelphia Conference. He continued, however, for many years to perform extensive service, visiting the churches, and part of the time superintending a district. During the latter years of his life he resided in Philadelphia, where he died in 1847. He was distinguished for pulpit eloquence, logical ability, and especially for his multifarious knowledge, which obtained for him among his brethren the title of "the Walking Encyclopedia." He published a "Funeral Sermon" on Rev. John Dickman, and "the Substance of a Funeral Discourse on Rev. Francis Asbury," etc., Philad. 1819. The latter was a 82mo volume of 230 pages (Stevens, *Hist. of Meth. Epis. Church*, vol. iii; Sprague, *Annals*, vii, 108; *Minutes of Conferences*, iv, 104).

Cooper, Samuel D.D., a Congregational minister, was born in Boston, March 28, 1725. He graduated at Harvard in 1748, and was chosen collegiate pastor with Dr. Colman in the Brattle-street Church, Dec. 31, 1744. He was ordained pastor May 21, 1746, and died Dec. 23, 1788. He was made D.D. by the University of Edinburgh in 1767. Dr. Cooper published a few occasional sermons, and wrote contributions for the *Boston Gazette* and *Independent Ledger*. He was elected president of Harvard in 1774, but did not accept.—Sprague, *Annals*, i, 440.

Cooper, Samuel C., a Methodist Episcopal minister, was born in Baltimore 1799, converted in Ohio 1818, acted efficiently as exhorter and local preacher for some years, and entered the itinerancy in 1827. He died at Greencastle, Ind., July, 1856. He filled the positions of pastor, presiding elder, and agent for the Asbury University with excellent success. He was twice delegate to the General Conference, and his attendance at the Conference of 1856 was his last service to the Church.—*Minutes of Conferences*, vi, 184.

Cooper, Thomas, a Methodist Episcopal minister, was born at Maidstone, Eng., in 1819; emigrated to America while young; was converted at Mount Vernon, Ohio, while a boy; studied with success at the Norwalk seminary under Dr. Thomson, and entered the itinerancy in 1842. As an agent of the Ohio Wesleyan University, a seamen's missionary, and in the regular pastoral work, he was very able and useful, until his sudden death by cholera, July, 1849.—Thomson, *Biographical Sketches*, p. 191.

Cooper, William, a Congregational minister, was a native of Boston, born in 1694, and graduated at Harvard 1712. He commenced preaching in 1715, and was ordained collegiate pastor of the Brattle-street

Church, May 28, 1716. He was elected president of Harvard in 1737, but declined the honor. He died Dec. 12, 1748. Mr. Cooper published *A Tract defending Inoculation for the Small-pox* (1721); *The Doctrine of Predestination unto Life vindicated in four Sermons* (1740); and several occasional discourses.—Sprague, *Annals*, i, 288.

Co'ös [or rather Cos, as it is usually written] (*Kōs*, contracted for *Kōws*, Anglicized "Coos" only in Acts xxi, 1), a small island (about 80 stadia in circumference, Strabo x, 488), one of the Sporades, in the Ægean Sea, near the coast of Caria in Asia Minor, and almost between the promontories on which the cities Cnidus and Halicarnassus were situated (Plin. v, 86). Its more ancient names were *Cœa*, *Staphylus*, *Nymphæa*, and *Merope*, of which the last was the most common (Thucyd. viii, 41). Homer mentions it as a populous settlement (*Il.* ii, 184; xiv, 255), no doubt of Dorian origin. Its fertility is attested by its celebrity for wine (Plin. xv, 18; xvii, 80), its costly ointments (Athen. xv, 688), and its fabrics of a transparent texture (Horace, *Od.* iv, 13, 7; Tibull. ii, 4, 6). It was the birthplace of Hippocrates. "It is specified, in the edict which resulted from the communications of Simon Maccabæus with Rome, as one of the places which contained Jewish residents (1 Macc. xv, 28). Josephus, quoting Strabo, mentions that the Jews had a great amount of treasure stored there during the Mithridatic war (*Ant.* xiv, 7, 2). From the same source we learn that Julius Cæsar issued an edict in favor of the Jews of Cos (*ib.* 10, 15). Herod the Great conferred many favors on the island (Joseph. *War*, i, 21, 11); and an inscription in Böckh (No. 2502) associates it with Herod the Tetrarch. The apostle Paul, on the return from his third missionary journey, passed the night here, after sailing from Miletus. The next day he went on to Rhodes (Acts xxi, 1). The proximity of Cos to these two important places, and to Cnidus, and its position at the entrance to the Archipelago



Coins of Cos.

from the east, made it an island of considerable consequence. It was celebrated also for a temple of Æsculapius, to which a school of physicians was attached, and which was virtually, from its votive models, a museum of anatomy and pathology. The emperor Claudius bestowed upon Cos the privileges of a free state (*Tac. Ann.* xii, 61). The chief town (of the same name) was on the N. E., near a promontory called Scandarium, and perhaps it is to the town that reference is made in the Acts (1. c.)" (Smith). It is now called *Stanco* or *Stanchio* (a corruption of *ἱερὸν Κωῶν*), and presents to the view fine plantations of lemon-trees, intermixed with stately maples. Its population is about eight thousand, who mostly profess the Greek religion (Turner's *Tour in the Levant*, iii, 41). "There is a monograph on Cos by Küster (*De Co Insula*, Halle, 1833), and a very useful paper on the subject by Col. Leake (in the *Trans. of the Royal Soc. of Literature*, vol. i, second series). An account of the island will be found in Clarke's *Travels* (vol. ii, pt. i, p. 196-213,

and vol. ii, pt. ii, p. 821-338); but the best description is in Ross (*Reisen nach Kos, Halicarnassus, u. s. v. Halle, 1852*, with which his *Reisen auf den Griech. Inseln* should be compared, vol. ii [1843], p. 86-92; vol. iii [1845], p. 126-139) (Smith). See also the *Penny Cyclopædia* and Smith's *Dict. of Class. Geogr.* s. v. Cos.

Cope (Lat. *capa*, Fr. *chape*), a sort of cloak, forming part of the sacerdotal vestments in the Roman Church. It was formerly worn by the clergy of the Church of England during divine service, but has fallen into disuse, except on such occasions as a coronation. It reaches from the neck nearly to the feet, and is open in front, except at the top, where it is fastened by a band or clasp. The canons of the Church of England describe it as a part of clerical dress. See Du Cange, s. v. *Capa*.

Copiātæ (κοπιᾶται, from κοπιᾶω, to toil), undertakers, grave-diggers; in ancient times a subordinate class of servants of the Church and clergy, intrusted with the care of funerals and the burial of the dead. They are also called *ospillones*, *bispillones*, *νεκροθάραται*; also *ordo fossariumum*, *fossores*, grave-diggers; *lecticarii*, bearers of the bier; and *collegiati*, *decani*, collegiates and deans. The order is supposed to have been first instituted by Constantine, and in some codes they are designated *clerici*.—Bingham, *Orig. Eccl.* III, viii, 1.

Coping (also called *capping*), a course of stones, either flat or sloping, to throw off the water, especially used in the end walls of Gothic edifices.

COPING (קֹפֶה, *te'phack*, a *hand-breadth*; Sept. *rd γείσα*) occurs in 1 Kings vi, 9, as an architectural term for the *corbils* (*mutuli*) or projecting stones in a wall on which the ends of the timbers are laid. See CORBEL.

Coponius (Græcized Κωπώνιος), the first Roman procurator of Judæa, established by Augustus after the banishment of Archelaus (Josephus, *War*, ii, 8, 1), A.D. 6. He was of the equestrian order (Josephus, *Ant.* xviii, 1, 1), and was succeeded by M. Ambivus (*ib.* 2, 2), A.D. 9. He was probably the same person as Caius Coponius, a prætor, who, having espoused the cause of Pompey, narrowly escaped execution by the triumvirs (Appian, *Bell. Civ.* iii, 40), but was afterwards held in great respect (Vell. Pat. ii, 83), and seems to have held an office in the imperial mint.—Smith's *Dict. of Class. Biog.* s. v.

Copleston, EDWARD, D.D., bishop of Llandaff and dean of St. Paul's, was born at Offwell, in Devonshire, of which parish his father was at once the patron and incumbent, Feb. 2, 1776. In 1791 he was elected to a scholarship at Corpus Christi, Oxford; in 1793 he obtained the chancellor's prize for a Latin poem; and in 1795 he was elected a fellow of Oriel College. In 1797 he was appointed college-tutor, though he had not then taken his degree of M.A. In 1802 he was elected professor of poetry to the University. He published in 1818 the substance of the lectures which he had delivered, under the title of *Prælectiones Academicæ*, a work which gained him a high reputation for elegant Latin composition. In 1814 he was elected provost of Oriel College, and soon afterwards the degree of D.D. was conferred upon him by diploma. His ablest work is *An Inquiry into the Doctrine of Necessity and Predestination, with Notes and an Appendix on the 17th Article of the Church of England* (London, 1821, 8vo). Between the years 1811 and 1822 he contributed many articles to the *Quarterly Review*. In 1826 he was appointed dean of Chester, and in 1827 he succeeded Dr. Sumner in the bishopric of Llandaff and deanery of St. Paul's. He died Oct. 14, 1849. Dr. Whately published, after Copleston's death, his *Remains, with Reminiscences of his Life* (8vo). See also W. J. Copleston, *Memoirs of E. Copleston, with Selections from his Diary and Correspondence*, etc. (London,

1851, 8vo).—*English Cyclopædia*, s. v.; *North Brit. Review*, Feb. 1852; *English Review*, xvi, 243.

Copper (כֹּפֶר, *mecho'sheth* [whence also proper as an adjective, נֹחֶשֶׁת, *nachushet*, *brazen*, fem. נֹחֶשֶׁת נֹחֶשֶׁתִּים *nachushah'sh*]; Greek χαλκός) occurs in the common translation of the Bible only in Ezra viii, 27 ("vessels of copper, precious as gold," i. e. probably of purer kind or more finely wrought than ordinary), being elsewhere incorrectly rendered "brass," and occasionally even "steel" (2 Sam. xxii, 35; Jer. xv, 1, i. e. hardened so as to take a temper like iron). The expression 'bow of steel' (Job xx, 24; Psa. xviii, 34) should therefore be rendered 'bow of copper,' since the term for steel is בַּרְזֵל, or כְּסֵלֶת (see *Smith's Dict.* s. v. Iron). The ancients could hardly have applied copper to these purposes without possessing some judicious system of alloys, or perhaps some forgotten secret for rendering the metal harder and more elastic than it can make it. It has been maintained that the cutting-tools of the Egyptians, with which they worked the granite and porphyry of their monuments, was made of bronze, in which copper was a chief ingredient. The arguments on this point are found in Wilkinson (*Asc. Eg.* iii, 249, etc.), but they are not conclusive. There seems to be no reason why the art of making iron and excellent steel, which has for ages been practised in India, may not have been equally known to the Egyptians. The quickness with which iron decomposes will fully account for the non-discovery of any remains of steel or iron implements. For analyses of the bronze tools and articles found in Egypt and Assyria, see Napier (*Ancient Workers in Metal*, p. 68). This metal is usually found as pyrites (sulphuret of copper and iron), malachite (carb. of copper), or in the state of oxide, and occasionally in a native state, principally in the New World. It was almost exclusively used by the ancients for common purposes, for which its elastic and ductile nature rendered it practically available (see Smith's *Dict. of Class. Antiq.* s. v. *Aes*). It is a question whether in the earliest times iron was known in India, however, its manufacture has been practised from a very ancient date by a process exceedingly simple, and possibly a similar one was employed by the ancient Egyptians (Napier, *ut sup.* p. 187). There is no certain mention of iron in the Scriptures; and from the allusion to it as known to Tubal-Cain (*Gen.* iv, 22), some have ventured to doubt whether in that place בַּרְזֵל means iron (Wilkinson, *Asc. Eg.* iii, 249). The vessels of 'fine copper,' mentioned in Ezra viii, 27 (comp. 1 Esdr. viii, 57, 'vases of Corinthian brass'), were perhaps similar to those of 'bright brass' in 1 Kings vii, 45; Dan. x, 6. They may have been of *orichalcum*, like the Persian or Indian vases found among the treasures of Darius (*Aristot. De Mirab. Auscult.*). There were two kinds of this metal, as *natural* (Serv. *ad Æn.* xii, 87), which Pliny (*H. Nat.* xxxiv, 2, 2) says had long been extinct in his time, but which Chardin alludes to as found in Somatra under the name *calmbac*; the other *artificial* (identified by some with *electrum*, ἤλεκτρον, whence the mistaken spelling *aurichalcum*), which Bochart (*Hieroc.* vi, ch 16, p. 871 sq.) considers to be the Hebrew כֹּפֶר, *chashmal*, a word compounded (he says) of כֹּפֶר (copper), and Chald. נֶפֶלֶט (? gold, Ezek. i, 4, 27; viii, 2). On this substance, see Pausan. v, 12; Plin. xxxiii, 4 § 28. Gesenius considers the χαλκολίβανον of Rev. i, 15, to be χαλκός λιπαρός = כֹּפֶר־שֶׁמֶן; he differs from Bochart, and argues that it means merely smooth or polished brass" (Smith, s. v.). See AMBER. "Many of the ancient copper alloys had to stand working by the hammer; and their working was such, either by toughness or hardness, that we cannot at the present day make anything like it" (Napier, *ut sup.* p. 54). The Mexicans and Peruvians, when first visited by the

Spaniards, were in possession of tempered implements of copper, and had the means of smelting, refining, and forging this metal. They were also able to harden it by alloying. "The metal used for this latter purpose was tin; and the various Peruvian articles subjected to analysis are found to contain from three to six per cent. of that metal" (Silliman's *Journal*, ii, 51). See METAL.

Tubal-Cain is recorded as the first artificer in brass and iron (Gen. iv, 22). In the time of Solomon, Hiram of Tyre was celebrated as a worker in brass (1 Kings vii, 14; comp. 2 Chron. ii, 14). To judge from Hesiod (*Op. et Dies*, 184) and Lucret. (v, 1285), the art of working in copper was even prior to that in iron, probably from its being found in larger masses, and from its requiring less labor in the process of manufacture. Palestine abounded in copper (Deut. viii, 9), the mines being apparently worked by the Israelites (Isa. li, 1); and David left behind him an immense quantity of it to be employed in building the Temple (1 Chron. xxii, 3-14). Of copper were made all sorts of vessels in the tabernacle and temple (Lev. vi, 28; Num. xvi, 39; 2 Chron. iv, 16; Ezra viii, 27), weapons, and more especially helmets, armor, shields, spears (1 Sam. xvii, 5, 6, 38; 2 Sam. xxi, 16), and bows (2 Sam. xxii, 35), also chains (Judg. xvi, 21), and even mirrors (Exod. xxxviii, 8; Job xxxvii, 18). The larger vessels were moulded in foundries, such as lavers, the great one being called "the copper sea" (2 Kings xxv, 18; 1 Chron. xviii, 8); also the pillars for architectural ornaments (1 Kings vii). It would, however, appear (1 Kings vii, 14) that the art of copper-founding was, even in the time of Solomon, but little known among the Jews, and was peculiar to foreigners, particularly the Phœnicians, who seem to have imported the material and even wrought articles from a distant quarter (Ezek. xxvii, 18), probably from the Moschi, etc., who worked the copper mines in the neighborhood of Mount Caucasus. Michaelis (*Mos. Recht*, iv, 217, 314) observes that Moses seems to have given to copper vessels the preference over earthen (Lev. vi, 28), and on that ground endeavors to remove the common prejudice against their use for culinary purposes. From copper, also, money was coined (Ezek. xvi, 36; Matt. x, 9).—Kitto, s. v. See BRASS.

COPPERSMITH (χαλκεύς, q. d. *brasier*, from χαλκός, *copper*), a worker in metals of any kind, a *smith* (Hesych. s. v.); a sense in which the word is used in other Greek writings (Hom. *Od.* ix, 391). Alexander, an opponent of Paul, is designated as being of this trade (2 Tim. iv, 14). See MECHANIC.

Coptic Church. See COPTS.

Coptic Language, a mixture of ancient Egyptian with Greek and Arabic words, spoken in Egypt after the introduction of Christianity. It is not now a spoken language, having been everywhere supplanted by the Arabic. It has not been spoken in Lower Egypt since the tenth century, but lingered for some centuries longer in Upper Egypt. It is, however, still used by the Copts in their religious services, but the lessons, after being read in Coptic, are explained in Arabic. The Coptic literature consists in great part of lives of saints and homilies, with a few Gnostic works (Chambers, s. v.). It is especially interesting as giving us a clew to the meaning of the *hieroglyphics* (q. v.) after they have been phonetically deciphered. It is divided into three dialects, the Memphitic, or Lower Egyptian, which is the most polished, and is sometimes exclusively called Coptic; the Sahidic, or Upper Egyptian; and the Bashmuric, which was spoken in the Delta, and of which only a few remains exist (*Penny Cyclopædia*, s. v.). See EGYPT. A full list of works on the subject is given by Jolowicz, *Bibliotheca Egyptiaca*, p. 101 sq., 229; also the Supplem. p. 29 sq. See COPTS.

The gender of nouns is indicated by the forms of the

WORDS.	CAPITALS.	SMALL LETTERS.	ENGLISH REPRESENTATIVES.	GREEK EQUIVALENTS.
Alpha.....	Α	α	a	α
Vida.	Β	β	b, v	β
Gamma.....	Γ	γ	g	γ
Dalda.....	Δ	δ	d	δ
Ei.....	Ε	ε	e short	ε
Zida.....	Ζ	ζ	z	ζ
Hida.....	Η	η	e long	η
Thida.....	Θ	θ	th	θ
Iauda.....	Ι	ι	i	ι
Kabba.....	Κ	κ	k	κ
Laula.....	Λ	λ	l	λ
Mi.....	Μ	μ	m	μ
Ni.....	Ν	ν	n	ν
Exi.....	Ξ	ξ	x	ξ
O.....	Ο	ο	o short	ο
Pi.....	Π	π	p, b	π
Ro.....	Ρ	ρ	r	ρ
Sima.....	Σ	σ	s	σ
Dau.....	Τ	τ	t, d	τ
He.....	Υ	υ	y, u	υ
Phi.....	Φ	φ	ph	φ
Ohl.....	Χ	χ	ch	χ
Ebsl.....	Ψ	ψ	ps	ψ
O.....	Ω	ω	o long	ω
Fei.....	Ϝ	ϝ	f	
Hori.....	Ϟ	ϟ	h	
Khei.....	Ϡ	ϡ	kh	
Shei.....	Ϣ	ϣ	sh	
Jianjia.....	Ϥ	ϥ	j	
Skima.....	Ϧ	ϧ	sk	
Del (ligature)	Ϩ	ϩ	ti	
So.....	ϫ	Ϭ	cipher 6	

article, namely, *pi*, *p*, *f*, for the masc. ; *t*, *th*, *ti*, for the fem. ; *si*, *sea*, for the common plur. The simple article is, sing. *u*, plur. *haw*. The plur. of nouns is expressed partly by the termination, as *-i*, *-u*, *-y*, *-x*; partly by an internal change. The cases are supplied by the enclitic additions: nom. *-enje*, gen. *-ente*, dat. and accus. *-e*. The adjectives are indeclinable, but are compared by means of *huo*=more, *emasho*=very. The numerals are: 1, *uai*; 2, *mau*; 3, *shomb*; 4, *fiou*; 5, *tiu*; 6, *sou*; 7, *shashf*; 8, *shmon*; 9, *paib*; 10, *meb*, etc. The ordinals are formed from these by the addition of *-mak*. The personal pronouns are *amok*=I, *entho* (masc.) and *entho* (fem.)=thou, *enthos*=he, *enthos*=she, *amon*=we, *enthoten*=ye, *enthou*=they. Abbreviated forms of these are used, some as possessives, etc., others as suffixes to nouns, verbs, and particles. But instead of them the words *ro* (i. e. "mouth"), *tot* (i. e. "hand"), etc., are commonly employed, with their various inflections. The tenses are formed partly by additional syllables, and partly by means of auxiliaries. There are grammars of the language by Kircher (Rome, 1636), Blumberg (Leipzig, 1716), Tuli (Rome, 1778), Scholz (Oxford, 1778), Valperga (Parma, 1783), Tattam (Lond. 1830, 2d ed. 1863), Rosellini (Rome, 1837), Peyron (Turin, 1841), Schwartze (Berl. 1850), Uhlemann (Lpz. 1858); and dictionaries by La Croze (Oxford, 1775), Tattam (ib. 1835), Peyron (Turin, 1835), and Parthey (Berl. 1840). See Növe, *Monuments de la langue Copte* (in the *Revue Catholique*, Louvain, 1858). For a reading-book the learner may use the so-called *Pistis Sophia*, published by Petermann (Latin version by Schwartze, Berlin, 1851).—Pierer, *Universal-Lexikon*, ix, 712.

Coptic Liturgy. See LITURGY.

Coptic Version. See EGYPTIAN VERSIONS.

Copts, a denomination of Monophysite Christians in Egypt. Some writers derive the name from *Coptos*, once a great city in Upper Egypt (Wilkins; Pococke), but it is generally taken as an abbreviation of the word *Αἰγυπτός*. The native Christians of Egypt chose this name when the Monophysite doctrines became prevalent among them, and they, on this account, fell out with the court of Constantinople. The Monophysites chose their own patriarch, while the imperial court sustained an orthodox patriarch at Alexandria. The Monophysites called themselves *Egyptian* or *Coptic* Christians, and gave to their opponents the nickname *Melchites*, i. e. Imperial Christians (from Melek, king; see Neander, *Ch. Hist.* vol. iii).

I. History.—The Copts are not an unmixed race. Their ancestors in the earlier times of Christianity intermarried with Greeks, Nubians, and Abyssinians. After the condemnation of Monophysitism by the Council of Chalcedon (A.D. 451), the Copts were oppressed so grievously that, from hatred of the Greeks, they facilitated the conquest of Egypt by the Mohammedans. We know from the Arabic historian Macrizi (see below) that at that time there were in Egypt only about 300,000 Jacobites, but several millions of Copts. Persecution and intermarriages with the Moslems greatly reduced their numbers in the course of time, and laid waste many of their churches and convents. It was not until the reign of Mehemet Ali, in the beginning of the 19th century, that they ceased to be a despised race. Some of them have since been raised to the rank of beys. The sad condition of the Coptic Church induced the Church Missionary Society of England in 1825 to send two German missionaries to Cairo for the purpose of awakening among them a new spiritual life. They established several schools and a small theological seminary for the training of priests, where, among others, also the present abuna of the Abyssinian Church was educated. The patriarch for some time seemed to favor the missionaries, and to aid their efforts for the education of the clergy and the circulation of the Bible, numerous copies of

which have been repeatedly supplied by the Bible Society (500 in 1859, at the request of Dr. Tattam). The mission was subsequently transferred to the care of the United Presbyterian Church of the United States and has since then greatly increased in extent and importance. Several native congregations have been constituted, and have been organized into the Missionary Presbytery of Egypt, in connection with the General Assembly of the Church in the United States. At the General Assembly for 1867 the following statistics of the Presbytery of Egypt were reported: ministers, 9; congregations, 3; families, 46; communicants, 126. Besides a number of valuable mission-schools, there is a theological school for training theological students in Osiot. For several years the mission has received a contribution of £1000 annually from the maharajah Dhuleep Singh, besides occasional liberal donations, the maharajah having met his wife in one of the mission-schools at Cairo. The maharajah also presented the missionaries at Cairo with a printing-press, which, up to 1867, has issued a selection of the book of Psalms and 3000 copies of Brown's *Short Catechism*. The Coptic patriarch instituted a fierce persecution against all the Copts associating with the missionaries, causing their children to be beaten and withdrawn from the schools, and burning all the Bibles and other religious books he could lay hands on. The Mussulman authorities at first countenanced these proceedings, but finally stopped them, in consequence of the representations of the American consul general.

II. Doctrines.—It has already been remarked that the Copts are Monophysites (q. v.). They hold seven sacraments. They postpone the baptism of male children forty days, and that of girls eighty days, and administer it only in church. In case of emergency, they substitute baptism for anointing. They agree with the Greek Church in using trine immersion, and also in the doctrine and administration of the Lord's Supper. Confession among them is rare, and is generally followed by unction. Unction in general is used among them very extensively in the case of sickness, and is administered not only to the sick, but also to the by-standers and to the dead. They invoke the saints, pray for the dead, and venerate images and relics, but they reject all sculptured representations except the cross. Their fasts are long, frequent, and rigorous. They observe four Lents—one before Easter, which commences nine days earlier than in the Latin Church; a second after the week of Pentecost, which lasts thirteen days; a third after the feast of Assumption, lasting fifteen days; and a fourth before Christmas, which lasts forty-three days for the clergy and twenty-three for the people.

III. Worship.—They have three liturgies, called after St. Basil, Gregory of Nazianzus, and Cyril of Alexandria (see LITURGY), which are translated into Coptic from the original Greek. They continue to use the Coptic language, though but few persons, even among the priests, understand it. The liturgical books have been translated into Arabic. The reading of homilies from the fathers is generally substituted for preaching. Instead of seats, the congregations are provided with crutches, on which they rest themselves during the service. One part of the worship is celebrated with the clangor of cymbals, in imitation of David's rejoicing before the Lord. The conduct of the priests at divine service is described by all travellers as careless, if not indecorous. In private, it is said, they abide more strictly than other Orientals by the prescribed daily services, which, in reference probably to David's resolution (Psa. cxix, 164), are seven in number. The full form enjoins the recital of one seventh part of the book of Psalms at each service; but there is a shorter form for the lower classes, containing in each of the seven daily prayers the "Pater" seven, and the "Kyrie Eleison" forty-one times—a string of

so many beads being used for the purpose. This service may be gone through while a person is walking, or riding, or pursuing any ordinary employment.

IV. Present Condition and Ecclesiastical Statistics.—In some parts of Upper Egypt there are still villages exclusively inhabited by Copts, and in every village of moderate size is a moallim (a title given to all Copts except those of the poor class or peasants), who keeps the register of the taxes. Most of the Copts in Cairo are employed as secretaries and accountants or tradesmen. They are the chief employés in the government offices; and as merchants, goldsmiths, silversmiths, jewellers, architects, builders, and carpenters, they are generally considered more skilful than the Moslems. In the villages they are employed in agriculture, like the rest of the peasantry. Petty causes among them are judged of by their clergy and the patriarch, but appeal may be made to the cadi. They bear a hatred to other Christian denominations, and are not permitted by their Church to intermarry with them. The clergy, on the whole, are poor and ignorant. At the head of the clergy stands the patriarch of Alexandria, who resides, however, in Cairo. His jurisdiction extends also over Nubia and Abyssinia, for which latter country he has the right of consecrating the *abuna* (q. v.). He himself is always chosen from among the monks of the convents of St. Macarius, in the desert of Scete. It is customary for the patriarch elect to decline the dignity, and only to yield to apparent force. Besides the patriarch, there are four metropolitans (Cairo, Lower Egypt, Codus, Mounoufia) and eleven bishops. They are appointed by the patriarch, and generally chosen among laymen who are widowers. Their income consists of tithes, which they collect for themselves and for the patriarch. The priests are generally simple mechanics, and, although they are at liberty to marry, they live mostly in celibacy. The number of churches and convents is said to amount to about 150. A few years ago Tattam and Curzon discovered in some of these convents a number of the most valuable manuscripts. The population is estimated from 150,000 to 250,000, of whom about 10,000 reside in Cairo. The number of Copts who have acknowledged the authority of the pope (United Copts since 1732) is about 10,000. In 1855 the pope appointed one of his priests vicar apostolic and bishop *in partibus*.—Makrizii *Historia Coptorum Christianorum in Egypto, Arab. et in linguam Lat. translata*, ab H. J. Wetzer (Solihabaci, 1828); Schaff, *History of the Christian Church*, § 145; Stanley, *Eastern Church*, Lect. i; *Churchman's Calendar for 1867*, p. 168; *Evangelical Repository*, July, 1867.

COR (כֶּרֶס, *kor*, properly a round vessel; Gr. κόρα), a measure both for liquids and solids, containing ten ephabs or baths (Ezek. xlv, 14), and equal to the *omer* (q. v.). In 1 Kings iv, 22; v, 11; 2 Chron. ii, 10; xxvii, 5; Luke xvi, 7, it is rendered indefinitely "measure" (q. v.); but in 1 Eedr. viii, 20, it is correctly Anglicized. See METROLOGY.

CORACIN (κορακίνας, a Latinized form for κορακός, from κόρα, a raven), a kind of fish (so called probably from its black color), found, according to Josephus (*War*, iii, 10, 8), in the spring of Capernaum (q. v.) and in the Nile (Theophylact, *Hist.* vii, 17; Oribasia, *Medic. Collect.* ii, 58); accustomed to leap like the salmon (Pliny, xxxii, 5, 10), and called likewise the *saperda* (Athenæus, vii, 16) and other names (Stevens, *Theat. Gr. s. v.*; Reland, *Palest.* p. 274).

CORAL is usually understood to be denoted by the word רַמְתֵּי (ramoth', literally height's, i. e. high-priced or valuable things, or from its upright growth; Sept. μερίωπα, but in Ezek. 'Páμθ), in Job xxviii, 18; Ezek. xxvii, 16; and this interpretation is not unsuitable (comp. Niebuhr, *Beschr.* p. 41), although the etymology is not well made out (Pareau, *De immortalitate*

notitia Job [Daventr. 1806], p. 321 sq.), and the dialects afford little support. According to the Rabbins, it means *red corals*. The ancient translators were evidently much perplexed to determine whether the word רַמְתֵּי (*penimim*', literally *branches*; rendered "rubies," Job xxviii, 18; Prov. iii, 15; viii, 11; xx, 15; xxxi, 10; Lam. iv, 7) meant corals or pearls. This will always be doubtful; but the text in Lam. iv, 7, by describing the article as *red*, suggests a preference of the former. It is scarcely credible, indeed, that such a product should have circulated under two different names (if *ramoth* also means coral); but surely there is no difficulty in conceiving that one word may have denoted *coral* generally, while another may have distinguished that *red coral* which was the most esteemed, and the most in use for ornament (see Gesenius, *Theat. Heb.* p. 1118, 1249).



Branch of Coral.

Coral is a hard, cretaceous marine production, arising from the deposit of calcareous matter by a minute polyπους animal, in order to form the cell or polypidom into whose hollows the tenant can wholly or partially retire. The corals thus produced are of various shapes, most usually branched like a tree. The masses are often enormous in the tropical seas, where they top the reefs and cap the submarine mountains, frequently rising to or near the surface, so as to form what are called coral islands and coral reefs (see Kitto, *Pict. Bible*, on Job xxviii, 18). These abound in the Red Sea (Wellsted, *Trav.* ii, 181; Ruppel, *Abyssin.* i, 140), from which, most probably, was derived the coral with which the Hebrews were acquainted; but coral is also found in the Mediterranean. The coral brought by the merchants of Syria to Tyre must have come from the Indian seas, by the Euphrates and Damascus (comp. Plin. xxxii, 2). Coral was in higher esteem formerly as a precious substance than now, probably because the means of obtaining it in a fine state were not so efficacious as those now practised. It is of different colors—white, black, red. The red was anciently, as at present, the most valued, and was worked into various ornaments (Plin. xxxii, 11; comp. Hartmann, *Hebr.* i, 275 sq.). For the scientific classification of corals, see the *Penny Cyclopædia*, s. v. Polyparia.—Kitto, s. v. The red variety is the stony skeleton of a compound zoophyte, allied to the sea-anemones of our coasts. It forms a much-branched shrub, the beautiful scarlet stone constituting the solid axis, which is covered during life by a fleshy bark, out of which protrude here and there upon the surface

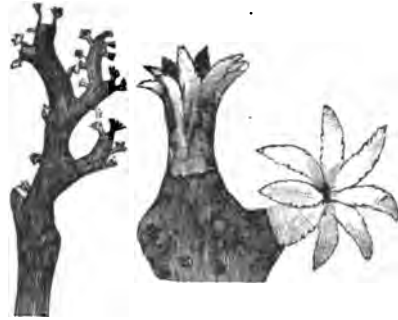

1. Stem of Coral. 2. Part enlarged to show the Zoophyte.

minute polypes with eight tentacles. It is found attached to the rocks at considerable depths, as from 20 to 120 fathoms. The demand for it has given rise to a fishery of some importance, about 180 boats being employed in it on the coast of Algeria, of which 156 fish in the neighborhood of Bona and Calla, obtaining 86,000 kilogrammes (about 720 cwt.) of coral; and this, selling at the rate of 60 francs per kilogramme, produces a return of \$450,000. The mode by which it is obtained is the same which has always prevailed, and is rude and wasteful. A great cross of wood loaded with stones, and carrying at the end of each arm a sort of net formed of cords partly untwisted, is lowered from a boat, and dragged over the bottom. The branches of the corals are entangled in this apparatus, and, as the boat moves on, are torn off; at intervals it is pulled up, and the produce secured. Of course a great deal must be broken off which is not secured, but yet it is a profitable employment. A boat manned by nine or ten hands has been known to bring in 80 or 100 kilogrammes in a day, yielding \$100 or \$125; but such success is rare. The fishery is prosecuted from the 1st of April to the end of September, during which there may be on the average about 100 days in which the fishermen can work (Milne Edwards, *Hist. des Corallines*).—Fairbairn, s. v. See *GRAZ*.

Corban (κορβάν, קֹרְבָן, *korban*, an offering), a Hebrew word (occurring frequently in the original of the O. T., but only in Lev. and Numb., except in Ezek. xx, 28; xl, 48) employed in the Hellenistic Greek, just as the corresponding Greek word *δῶρον* was employed in the Rabbinical Hebrew (Buxtorf, *Lex. Rab.* col. 579) to designate an *oblation* of any kind to God, whether bloody or bloodless, but particularly in fulfillment of a vow (Jahn, *Bibl. Arch.* v, § 392, 394). It occurs only once in the New Testament (Mark vii, 11), where it is explained (as also by Josephus, *Ant.* iv, 4, 4; *contra Ap.* i, 22) by the word "gift." Money, lands, and houses, which had been made the subject of this vow, became the property of the tabernacle or the Temple, except that the land might be redeemed before the year of Jubilee (Lev. xxvii, 1-24). Among other false doctrines taught by the Pharisees, who were the keepers of the sacred treasury (κορβανᾶ, *from corban*, Matt. xxvii, 6), was this, that as soon as a person had pronounced to his father or mother this form of consecration or offering, "Be it (or, It is) *corban* [i. e. devoted] whatever of mine shall profit thee" (בְּדָרְבָן שְׂאֵנִי נִתְּנָה לַיהוָה), he thereby consecrated all he had spoken of to God, and must not thenceforth do anything for his indigent parents if they solicited support from him. Therefore our Lord reproaches them with having destroyed by their tradition not only that commandment of the Law which enjoins children to honor their father and mother, but also another divine precept, which, under the severest penalty, forbade that kind of dishonor which consists in contumelious words (Mark vii, 9; x, 18). They, however, proceeded even further than this unnatural

gloss; for though the son did not give, or even *mean* to give, his property to the Temple, yet, if he afterwards should repent of his rashness, and wish to supply his parents with anything, what he had formerly said precluded the possibility of doing so, for, according to the Pharisaic doctrine, the sacred treasury had a claim upon him in preference to his parents, although he was perfectly at liberty to keep it to himself (see Lightfoot, *Hor. Heb.*, and Grotius, *Annot.*, on Matt. xv, 5). The law laid down rules for vows, 1. affirmative; 2. negative. By the former, persons, animals, and property might be devoted to God, but, with certain limitations, they were redeemable by money payments. By the latter, persons interdicted themselves, or were interdicted by their parents, from the use of certain things lawful in themselves, as wine, either for a limited or an unlimited period (Lev. xxvii; Num. xxx; Judg. xiii, 7; Jer. xxxv; comp. Josephus, *Ant.* iv, 4, 4; *War.* ii, 15, 1; see Acts xviii, 18; xxi, 23, 24). See Vow. Upon these rules the traditionalists enlarged, and laid down that a man might interdict himself by vow, not only from using for himself, but from giving to another, or receiving from him some particular object, whether of food or any other kind whatsoever. The thing thus interdicted was considered as *corban*, and the form of interdiction was virtually to this effect: "I forbid myself to touch or be concerned in any way with the thing forbidden, as if it were devoted by law," i. e. "let it be *corban*." (The exact formula, קֹרְבָן שְׂאֵנִי נִתְּנָה לַיהוָה, "[that] has been given [to God], which [in respect to] me is beneficial to thee," of which the Evangelist's *δῶρον*, ὅ ἐστιν ἐξ ἑμοῦ ὠφελῆσθης seems a strict rendering, is cited by Schöttgen, *Hor. Hebr.* i, 188, from the Mishna, *Nedarim*, fol. 24, 1.) So far did they carry the principle that they even held as binding the incomplete exclamations of anger, and called them קֹרְבָן, *korban*. A person might thus exempt himself from assisting or receiving assistance from some particular person or persons, as parents in distress; and, in short, from any inconvenient obligation under plea of *corban*, though by a legal fiction he was allowed to suspend the restriction in certain cases (Surenhusius, *Mischna, d. Votiv.* i, 4; ii, 2). It was with practices of this sort that our Lord found fault (Matt. xv, 5; Mark vii, 11), as annulling the spirit of the law. See OFFERING.

Theophrastus, quoted by Josephus (*Ap.* i, 22), notices the system, miscalling it a Phœnician custom, but in naming the word *corban* identifies it with Judaism. Josephus (*War.* ii, 9, 4) calls the treasury in which offerings for the Temple or its services were deposited, *κορβανᾶς, corbanas*; and Matthew (xxvii, 6) uses the same word to signify the treasury, saying that the chief priests did not think it lawful to put the money of Judas into it (εἰς τὸν κορβανᾶν) (Bingham, *Orig. Eccl.* v, 4, 2). Origen's account of the *corban*-system is that children sometimes refused assistance to parents on the ground that they had already contributed to the poor fund, from which they alleged their parents might be relieved. In the early Church, oblations were presented monthly, and they were always voluntarily placed in the treasury. Baronius thinks this treasury was called *corban*, because Cyprian uses the word when he speaks of the offerings of the people, rebuking a rich matron for coming to celebrate the Eucharist without any regard to the *corban*. See ALMS.

Cor'bè (Χορβέ, Vulg. *Charaba*), one of the captive Jews whose "sons" (to the number of 705) are stated to have returned from Babylon (1 Eedr. v, 12); apparently the ΖΑΚΚΑΙ (q. v.) of the Hebrew lists (Ezra ii, 9; Neh. vii, 14).

Corbel (Fr. *corbeille*, a basket), in Gothic architecture a projecting stone or timber to bear the superincumbent weight, usually of some architectural member of the structure, as the ribs or groins of an arch.

Great variety is used in ornamenting the corbel, it representing sometimes an animal, a human being, a plant, or a group of mouldings. See COPING.

Corbel-table, a row of corbels supporting a cornice, parapet, or other projecting part of a wall.

Corbey Manuscript (*Codex Corbeiensis*, so called from the abbey of Corbie or Corbey, in Picardy [see below], which once contained it), the name of a very ancient MS., or, rather, of two partially confused codices of the Gospels in the Old Latin version.

1. A MS. from which Martianay edited Matthew (in his *Vulgata Antiqua Latina*, etc., Par. 1695), and which is repeated by Blanchini (in his *Evangelarium Quadruplex*). Sabatier gives its various readings, but seems to confound it with the following.

2. A MS. defective in the first eleven chapters of Matthew. Its readings are cited in the three other Gospels by Blanchini, and throughout by Sabatier.

These texts (which are designated respectively as ff and ff' of the Gospels) are mixed; they occasionally preserve good readings, but there is much officious revision (see Scrivener, *Introd. to N. T.* p. 257). See MANUSCRIPTS, BIBLICAL.

Corbie (*Corbeja Antiqua*, also called *Aurea* and *Gallica*), a Benedictine monastery in Picardy, France, built in 657 by St. Bathildis, wife of king Clovis II and mother of Clotaire III. The first monks in Corbie were Anglo-Saxons from Luxeuil, the monastery of St. Columban. Corbie remained one of the most prominent monasteries of the Benedictine order. An offshoot of Corbie was the German monastery at Corvey (q. v.).—Wetzer u. Welte, *Kirch.-Lex.* ii, 872.

Corbie-steps, the steps up the gable of a house; often used with very picturesque effect, but more common in domestic than in ecclesiastical architecture.

Corbinian, SAINT, born at Chartres in 680, was for fourteen years a hermit, and then went to Rome, where the pope, Gregory II, consecrated him bishop. He returned to his solitude, and afterwards travelled along the Danube and the Isar to preach. Duke Theodo II of Bavaria appointed him first bishop of Freising. He died in 780, and is commemorated as a saint on Sept. 8.—Pierer, *Universal-Lexikon*, s. v.; Butler, *Lives of Saints*, Sept. 8.

Corbit, ISRAEL S., a minister of the Methodist Episcopal Church, was born in Philadelphia, Feb. 16, 1817, and entered the itinerancy in the New Jersey Conference in 1844. He died at Bordentown, N. J., April 11, 1866. Mr. Corbit's ministry, in the most important stations of his Conference, was eminently successful. "A sublimity caught from long converse with the Bible and the Christian poets ran through all his thoughts. He was accomplished, eloquent, and laborious, and gave full proof of his ministry."—*Minutes of Conferences*, vi, 29.

Cord, the rendering in the Auth. Ver. of the following Heb. words: (1.) usually כֶּבֶל, *che'bel* (but not כָּבֵל, a rope [see CHEBEL]; (2.) יֵתֶר, *ye' ther*, a straw ("withe," Judg. xvi, 7, 8, 9; tent-rope, "excellency," Job iv, 21; bow-"string," Psa. xi, 2; halter—"cord," Job xxx, 11); (3.) מֵיֶתֶר, *meythar'*, a line (e. g. tent-rope, Exod. xxxv, 18; xxxix, 40; Num. iii, 26, 37; iv, 26, 82; Isa. liv, 2; Jer. x, 20; bow—"string," Psa. xxi, 12); (4.) אֲבוֹת', *aboth'*, a braid (e. g. "wreathen" work, Exod. xxviii, 14, etc.; "band," Job xxxix, 10; Ezek. iii, 26; iv, 8; Hos. xi, 4; "rope," Judg. xv, 13, 14; Psa. ii, 3; cxviii, 27; cxxix, 4); (5.) חֵט, *chut* (Eccl. iv, 12, a "thread," Gen. xiv, 23; Josh. ii, 18; Judg. xvi, 12; Cant. iv, 8; "line," 1 Kings vii, 15; "fillet," Jer. lii, 21). The first of these terms is the most comprehensive, being from the root כָּבַל, to twist, hence Engl. *cable*. This word occurs often in its proper sense, as well as in the special meanings of

measuring-line (hence also *region*), *snare* (Psa. cxl, 5), and *bridle*. In Mic. ii, 5, it signifies "portion" (as it is frequently rendered elsewhere); and the phrase "cast a cord" denotes a change of inheritance, as in ver. 4. The same word has the secondary sense of a *band* of men (1 Sam. x, 5, 10), and *destruction* (Mic. ii, 10). See ROPE. "In the N. T. the term *αἰσῶνα* is applied to the whip which our Saviour made (John ii, 15), and to the 'ropes' of a ship (Acts xxvii, 32). Alford understands it in the former passage of the rushes on which the cattle were littered; but the ordinary rendering *corde* seems more consistent with the use of the term elsewhere. (See below.)

"The materials of which cord was made varied according to the strength required; the strongest rope was probably made of strips of camel hide, still used by the Bedouins for drawing water (Burckhardt's *Notes*, i, 46); the Egyptians twisted these strips together into thongs for sandals and other purposes (Wilkinson, *Anc. Egypt.* iii, 145). The finer sorts were made of flax (Isa. xix, 9). The fibre of the date-palm was also used (Wilkinson, iii, 210); and probably reeds and rushes of various kinds, as implied in the origin of the word *αἰσῶνιον* (Plin. xix, 9), which is generally used by the Sept. for כָּבֵל, and more particularly in the word אֲזַיִן, *rush* (Job xli, 2), which primarily means a reed; in the Talmud (*Eruvin*, fol. 58), bul-rushes, osier, and flax are enumerated as the materials of which rope was made; in the Mishna (*Sotah*, i, § 6) the כָּבֵל מִצִּירָה, or Egyptian rope, is explained as a *rope of vines or osiers*. See MECHANIC.

"Of the various purposes to which cord, including under that term rope, and twisted thongs, was applied, the following are especially worthy of notice: (1.) For fastening a tent, in which sense מֵיֶתֶר, *meythar'*, is more particularly used (e. g. Exod. xxxv, 18; xxxix, 40; Isa. liv, 2). As the tent supplied a favorite image of the human body, the cords which held it in its place represented the principle of life (Job iv, 21): 'Are not their tent cords (A. V. 'excellency') torn away?' (Eccl. xii, 6). (2.) For leading or binding animals, as a halter or rein (Psa. cxviii, 27; Hos. xi, 4), whence to 'loosen the cord' (Job xxx, 11) = to free from authority. (3.) For yoking them either to a cart (Isa. v, 18) or a plough (Job xxxix, 10). (4.) For binding prisoners, more particularly אֲבוֹת', *aboth'* (Judg. xv, 13; Psa. ii, 3; cxxix, 4; Ezek. iii, 25), whence the metaphorical expression '*bands of love*' (Hos. xi, 4). (5.) For bow-strings (Psa. xi, 2), made of catgut; such are spoken of in Judg. xvi, 7 (מֵיֶתֶרִים לַחֵט, A. V. 'green withs'; but more properly *νευπαί ὑψαρά*, fresh or moist bow-strings). (6.) For the ropes or 'tacklings' of a vessel (Isa. xxxiii, 26). (7.) For measuring ground, the full expression being כָּבֵל מֵיֶתֶר (2 Sam. viii, 2; Psa. lxxviii, 56; Amos vii, 17; Zech. ii, 1); hence to 'cast a cord' = to assign a property (Mic. ii, 6), and cord or line became an expression for an inheritance (Josh. xvii, 14; xix, 9; Psa. xvi, 6; Ezek. xlvi, 18), and even for any defined district (e. g. the *line*, or tract, of *Argob*, Deut. iii, 4). See CHEBEL. (8.) For fishing and snaring. See FISHING; FOWLING; HUNTING. (9.) For attaching articles of dress; as the *wreathen chains* (צַבָּרִים), which were rather twisted cords, worn by the high-priests (Exod. xxviii, 14, 22, 24; xxxix, 15, 17). (10.) For fastening awnings (Esth. i, 6). (11.) For attaching to a plummet. The line and plummet are emblematic of a regular rule (2 Kings xxi, 18; Isa. xxviii, 17); hence to destroy by line and plummet (Isa. xxxiv, 11; Lam. ii, 8; Amos vii, 7) has been understood as a regular systematic destruction (*ad normam et libellam*, Gesenius, *Theaur.* p. 125); it may, however, be referred to the carpenter's level, which can only be used on a flat surface (comp. Thienus, *Comm.* in 2 Kings xxi, 18). (12.) For draw-

ing water out of a well, or raising heavy weights (Josh. ii, 15; Jer. xxxviii, 6, 13). (13.) To place a rope on the head (1 Kings xx, 81) in place of the ordinary head-dress was a sign of abject submission" (Smith, s. v.). (14.) The "small cords" (*σχοῖνιον*, a *rush-rope*) used by our Saviour in expelling the traders from the Temple (John ii, 15) were probably the same used for leading the animals for sacrifice and binding them to the altar (רֶבֶץ, Psa. cxviii, 27). (15.) The same word is employed in Acts xxvii, 82, "ropes," i. e. *cordage*, with which the yawl-boats were secured to the ship (q. v.). See **RUSH**.

Among the figurative uses of the word the following are the most striking: (1.) To gird one's self with a cord was considered a token of sorrow and humiliation (1 Kings xx, 81-83; Job xxxvi, 8). (2.) To stretch a line or cord about a city signifies to ruin it, to destroy it entirely, and to level it with the ground (Lam. ii, 8). (3.) The cords (רֶבֶץ) extended in setting up tents furnish several metaphors in the prophetic books (Isa. xxxiii, 20; Jer. x, 20). (4.) Hence to "loose one's cord" was a metaphor for dissolving one's comfort and hopes (רָחַץ, *yo'ther*, elsewhere "withe"). (5.) "The cords of sin" (Prov. v, 22), metaphorically speaking, are the consequences of crimes and bad habits. (6.) The "silver cord" (i. e. composed of silvery threads, Eccl. xii, 6) is generally supposed to refer to the spinal marrow, to which, as to its form and color, it may not be inaptly compared. (7.) A "three-fold cord" (i. e. one of treble strands) is put as the symbol of union (Eccles. iv, 12, חֵט, *chut*, elsewhere "thread"). (8.) The "cords of a man," in Hos. xi, 4, are immediately explained as meaning "the bands of love," although some interpreters join this clause to the preceding sentence, and render it "amid the desolations of men," referring to the plagues of Egypt (Horsley, in loc.). See **LINE**. For *cords of Sheol*, see **SNARES OF DEATH**.

Cordeliers, a name given to the Franciscans (q. v.) in France. The name is said to have originated in the war of St. Louis against the Infidels, in which the friars having repulsed the barbarians, and the king having inquired their name, it was answered they were people *cordeliés*, that is, tied with ropes. See **FRANCISCANS**.

Cordonniers et Tailleurs, FRÈRES (brothers *Shoemakers and Tailors*), the title of a religious society founded in France by Henry Michael Buch, a shoemaker, in 1645. They chose as their patron Crispin and Crispinian, two sainted shoemakers. They lived in community, and under fixed statutes and officers, by which they were directed both in their temporal and spiritual concerns. The produce of their labor was put into a common stock to furnish necessaries for their support; any surplus was distributed among the poor. The society became extinct in the French Revolution.

Cordova, an ancient city of Spain (called by the Romans *Corduba*), seat of a Roman Catholic bishop, and noted for its cathedral church, which is the most beautiful of all Spain. 1. A celebrated *Synod of Cordova* was held on occasion of the persecution of Spanish Christians from 850 to 859, during the caliphate of Abderrahman II († 852) and of Mohammed. The synod was called at the wish of Abderrahman, in order to enjoin moderation upon monks and others who craved martyrdom by provoking the Mohammedans. In accordance with this wish, the council, of which the metropolitan Hostegis of Malaga seems to have been the leading spirit, forbade self-sought martyrdom. This action met at once with a determined opposition on the part of the rigorists, who called the synod *impium conciliabulum*. The acts of the council are lost, as it soon came to be generally disowned by the Spanish Church. 2. *The School of Cordova* was one of the

most celebrated literary institutions of the Arabs in Spain. It was founded about 980 by caliph Hakeem II, and had the largest Arabic library in Spain, which, according to one, undoubtedly exaggerated, account, numbered as many as 600,000 volumes. The school of Cordova became in particular celebrated for the impulse which it gave to the study of the Aristotelian philosophy. One of the most celebrated professors of Cordova was Averrhoes (q. v.). The conquest of Cordova by the Christians put an end to this school, as also to the flourishing Talmudic school of the same city.—Herzog, *Real-Encyclopädie*, s. v.

Co'rè (Κορέ), a mode of Græcizing (Ecclus. ii, 18; Jude 11) the name of the rebellious ΚΟΡΑΗ (q. v.) of the Mosaic history (Num. xvi).

Corea, a dependency of China. It is an extensive peninsula, bounded east by the Sea of Japan, south by the Strait of Corea, west by the Yellow Sea and the Gulf of Leatong, and north by Manchuria. It is governed by a king, who, though tributary to China, exercises virtually an absolute power. The prevailing religion is Buddhism. Confucius also has many followers. The area is about 87,550 English square miles; the population, according to a census of 1798, was 7,842,351, and in 1867 was estimated at 9,000,000. The Roman Catholic missionaries in China and Japan speak of conversions of natives of Corea to their Church in the latter part of the 16th century. In the 17th century one of the kings of Corea was a patron of the celebrated Jesuit Adam Schall. There seems always since to have been some small number of Roman Catholics in Corea, and in 1800 the total number of Christians was reported to amount to 10,000; but the progress of the Church was prevented by constant persecution. Early in the present century the mission of Corea was placed under the Paris "Congregation of Foreign Missions." The missionaries greatly extol the zeal of the native converts, and report a number of accessions to their Church. Thus, in 1833, the number of catechumens who were admitted to baptism was stated to be 460. A new persecution broke out in February, 1860. Two Roman Catholic bishops and seven priests, all natives of France, were put to death by order of the king for preaching a forbidden religion. Three others succeeded in concealing themselves, and one of them arrived at Chefoo, China, having been sent by the other two to communicate the sad intelligence. The escaped missionary asserted that there were 50,000 converts in Corea, and that great consternation was produced among them by the fierceness of the persecution. The missionary proceeded to Peking to invoke the aid of the French ambassador. In October, 1866, the French undertook an expedition against Corea, demanding the punishment of the three principal ministers who instigated the execution of the missionaries, and the conclusion of a treaty guaranteeing the Christians against future persecutions. The expedition was not successful, and in December returned to Shanghai. Mr. Williamson, the agent of the Scottish National Bible Society, wrote in 1866 from Chefoo, China, that he had visited two Roman Catholic natives of Corea who had come to that port. According to their statement, there are in Corea eleven European priests, who visit from house to house. They have no temples, but worship in private houses. They showed a catechism containing a full statement of their faith, in which Mr. Williamson was delighted to find much truth forcibly expressed. They appeared to be ignorant of any distinction between Protestantism and Roman Catholicism, and when Mr. Williamson spoke to them of Jesus, at once saluted him as "holy father." They agreed to act as the guides of the Rev. J. R. Thomas, who offered to accompany them, on their return to Corea, as the agent of the Bible Society. Subsequently Mr. Thomas changed his plan, and embarked

on board an American vessel, which ran aground in one of the rivers of Corea, when the natives, considering the people on board as pirates and enemies, captured and beheaded them.—Wetzer u. Welte, *Kirchen-Lex.* xii, 254 sq.; *Annual American Cyclop.* for 1866, p. 258; *The Christian Year-book* (Lond. 1867, p. 308).

Coreæ (Κορέαι), a fortified place mentioned by Josephus (*Ant.* xiv, 8, 4) as lying on the northern border of Judæa, on the route of Pompey to Jerusalem (*War*, i, 6, 5), and also visited by Vespasian, who marched in one day thither from Neapolis, and the next reached Jericho (*War*, iv, 8, 1). Near this place (πρός) was situated the fortress Alexandrium (q. v.), where the princes of Alexander Jannæus's family were mostly buried, and whither Herod carried the remains of his sons Alexander and Aristobulus (who were maternally of that family), after they had been put to death at Sebaste (Joseph. *Ant.* xiii, 24; xiv, 6, 10, 27; xvi, 2, et ult.). The situation of Coreæ, which determines that of the castle, is not known; but Dr. Robinson (*Bib. Researches*, iii, 88) conjectures that he may have found it in the modern *Kuriyet*, which is about eight miles S. by E. from Nablous (Shechem), and half an hour N. by E. of Shiloh (Ritter, *Erdk.* xv, 455). It is small, with no very definite traces of antiquity (Wolcott, in the *Bibliotheca Sacra*, 1843, p. 72). The similarity of name to that of Beth-car (Χόρρα, Josephus, *Ant.* vi, 22) seems to be accidental. See EBENZER.

Coreæthè (Κορεάθη), an episcopal village of Trachonitis (Reland, *Palæst.* p. 218) mentioned in the early Church notices (S. Paulo, *Geogr. Sac.* p. 51); probably the modern *Kiratah* (Ritter, *Erdk.* xv, 866), on the southern edge of the Lejah (Porter, ii, 216).

Coriander (קָרְיָא, *qad*, from the root קָרַי, to make an incision, referring to the furrows in the seed). The Syriac, Chaldee, and Arabic, with the Sept. and Vulg., render this word coriander (Gesenius, *Thesaur. Heb.* p. 264), as does our version in Exod. xvi, 13; Num. xi, 7, the only passages where it occurs, and in both which the appearance of manna is compared to that of its seeds as to form, and in the former passage as to color also. See MANNA. According to Dioscorides also (iii, 64) the ancient Carthaginian name for coriander was *goid* (γοιδ'), evidently kindred with the Hebrew

gad. Celsius states (*Hierob.* ii, 78 sq.) that the coriander is frequently mentioned in the Talmud (where it is called קָרְיָא, *kasbar*, or קָרְיָא, *kusebar*). It was known to and used medicinally by Hippocrates: it is mentioned by Theophrastus, as well as Dioscorides, under the name of κόριον or κοριαννον; and the Arabs, in their works on *Materia Medica*, give *korion* as the Greek synonym of coriander, which they call *kusecreh*, the Persians *kushmeez*, and the natives of India (compare Pliny, xx, 82) *dhunya*. It is known throughout all these countries, in all of which it is cultivated, being universally employed as a grateful spice, and as one of the ingredients of currie-powder (see Büsching, *Wöchentl. Nachr.* 1775, p. 42; Rauwolf, *Reise*, p. 94; Gmelin, *Reise durch Russl.* iii, 282). It is also found in Egypt (Prosop. *Alpin. Res. Eg.* ii, 9, p. 156). It is now very common in the south of Europe, and also in England, being cultivated, especially in Essex, on account of its seeds, which are required by confectioners, druggists, and distillers in large quantities; in gardens it is reared on account of its leaves, which are used in soups and salads (see Pereira's *Materia Medica*). The coriander is the *Coriandrum sativum* of botanists, an umbelliferous plant, with a round tall stalk. The flowers are small and pale pink, the leaves are much divided (especially the upper ones) and smooth. The fruit, commonly called seeds, is globular, grayish-colored, about the size of peppercorn, having its surface marked with fine striae. Both its taste and smell are agreeable, depending on the presence of a volatile oil, which is separated by distillation (see *Penny Cyclopædia*, s. v.). See BOTANY.

Cor'inth (Κόρινθος, occurs Acts xviii, 1; xix, 1; 1 Cor. i, 2; 2 Cor. i, 1, 28; 2 Tim. iv, 20; "Corinthus," subscr. to Ep. to Rom.), a Grecian city, placed on the isthmus which joins Peloponnesus (now called the Morea) to the continent of Greece. A lofty rock rises above it, on which was the citadel, or the Acrocorinthus (Livy xlv, 28). It had two harbors: Cenchræa, on the eastern side, about seventy stadia distant; and Lechæum, on the modern Gulf of Lepanto, only twelve stadia from the city (Strabo, viii, 6). Its earliest name, as given by Homer, is *Ephyre* (Ἐφύρη, *Il.* vi, 152); and mysterious legends connect it with Lycia, by means of the hero Bellerophon, to whom a plot of ground was consecrated in front of the city, close to a cypress grove (Pausan. ii, 2). Owing to the great difficulty of weathering Malea, the southern promontory of Greece, merchandise passed through Corinth from sea to sea, the city becoming an *entrepôt* for the goods of Asia and Italy (Strabo, viii, 6). At the same time, it commanded the traffic by land from north to south. An attempt made to dig through the isthmus was frustrated by the rocky nature of the soil; at one period, however, they had an invention for drawing galleys across from sea to sea on trucks. With such advantages of position, Corinth was very early renowned for riches, and seems to have been made by nature for the capital of Greece. The numerous colonies which she sent forth, chiefly to the west and to Sicily, gave her points of attachment in many parts; and the good will, which, as a mercantile state, she carefully maintained, made her a valuable link between the various Greek tribes. The public and foreign policy of Corinth appears to have been generally remarkable for honor and justice (Herod. and Thucyd. *passim*); and the Isthmian games, which were celebrated there every other year, might have been converted into a national congress, if the Corinthians had been less peaceful and more ambitious. When the Achaean league was rallying the chief powers of Southern Greece, Corinth became its military centre; and, as the spirit of freedom was active in that confederacy, they were certain, sooner or later, to give the Romans a pretence for attacking them. The fatal blow fell on Corinth (B.C. 146), when L. Mummius, by order of the Roman

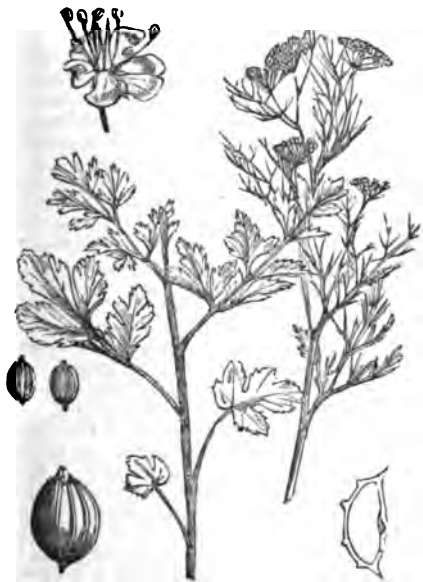

Coriander, with enlarged views of the flower, pericarp, and section of hemisphere of the last.

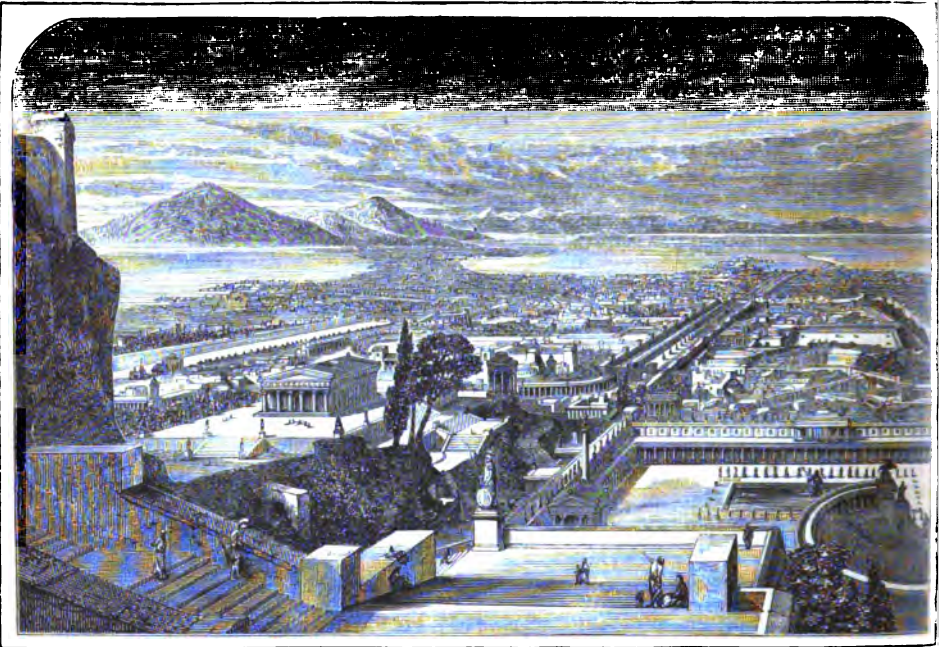

Corinth restored, as viewed from the Acrocorinthus.

sénate, barbarously destroyed that beautiful town (Cicero, *Verr.* i, 21), eminent even in Greece for painting, sculpture, and all working in metal and pottery; and, as the territory was given over to the Sicyonians (Strabo, l. c.), we must infer that the whole population was sold into slavery.

The Corinth of which we read in the New Testament was quite a new city, having been rebuilt and established as a Roman colony, and *peopled with freedmen from Rome* (Pausanias and Strabo, *u. s.*) by the dictator Cæsar a little before his assassination. Although the soil was too rocky to be fertile, and the territory very limited, Corinth again became a great and wealthy city in a short time, especially as the Roman proconsuls made it the seat of government

(Acts xviii) for Southern Greece, which was now called the province of Achaia. In earlier times Corinth had been celebrated for the great wealth of its temple of Venus, which had a gainful traffic of a most dishonorable kind with the numerous merchants resident there—supplying them with harlots under the forms of religion (hence *κοινωδύλεσσαι* = *scortari*, see Schöti *Adagia Gr.* p. 568). The same phenomena, no doubt, reappeared in the later and Christian age. The little which is said in the New Test. seems to indicate a wealthy and luxurious community, prone to impurity of morals; nevertheless, all Greece was so contaminated that we may easily overcharge the accusation against Corinth. We find Gallio, brother of the philosopher Seneca, exercising the functions of proconsul

here during the apostle Paul's first residence at Corinth, in the reign of Claudius. This residence continued for a year and six months, and the circumstances which occurred during the course of it are related at some length (Acts xviii, 1-18). The apostle had recently passed through Macedonia. He came to Corinth through Athens: shortly after his arrival Silas and Timothy came from Macedonia and rejoined him; and about this time the two epistles to the Thessalonians were written (probably A. D. 49 and 50). It was at Corinth that the apostle first became acquainted with Aquila and Priscilla, and shortly after his departure Apollos came to this city from Ephesus (Acts xviii, 27). Corinth was a place of great mental activity, as well as of commercial and manufacturing enterprise. Its wealth was so celebrated as to be proverbial; so were the vice and profligacy of its inhabitants. The worship of Venus here was attended with shameful licentiousness. All these points are indirectly illustrated by passages in the two epistles to the Corinthians, which

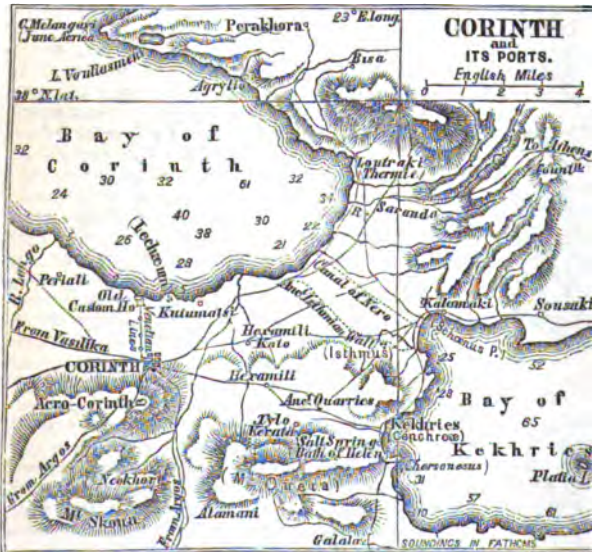

Map.

were written (probably A.D. 54), the first during Paul's stay at Ephesus, the second from Macedonia, shortly before the second visit to Corinth, which is briefly stated (Acts xx, 8) to have lasted three months. See CORINTHIANS (EPISTLES TO). During this visit (probably A.D. 55) the epistle to the Romans was written. From the three epistles last mentioned, compared with Acts xxiv, 17, we gather that Paul was much occupied at this time with a collection for the poor Christians at Jerusalem. It has been well observed that the great number of Latin names of persons mentioned in the epistle to the Romans is in harmony with what we know of the colonial origin of a large part of the population of Corinth. According to Philo (*Opp.* ii, 587), it was extensively colonized by Jews. From Acts xviii we may conclude that there were many Jewish converts in the Corinthian church, though it would appear (1 Cor. xii, 2) that the Gentiles predominated. On the other hand, it is evident from the whole tenor of both epistles that the Judaizing element was very strong at Corinth. Party spirit also was extremely prevalent, the names of Paul, Peter, and Apollos being used as the watch-words of restless factions. Among the eminent Christians who lived at Corinth were Stephanas (1 Cor. i, 16; xvi, 15, 17), Crispus (Acts xviii, 8; 1 Cor. i, 14), Caius (Rom. xvi, 23; 1 Cor. i, 14), and Erastus (Rom. xvi, 23; 2 Tim. iv, 20). The epistle of Clement to the Corinthians is among the most interesting of the post-apostolic writings. The Corinthian church is remarkable in the epistles of Paul by the variety of its spiritual gifts, that seem for the time to have eclipsed or superseded the office of the elder or bishop, which in most churches became from the beginning so prominent. Very soon, however, this peculiarity was lost, and the bishops of Corinth take a place co-ordinate to those of other capital cities. One of them, Dionysius, appears to have exercised great influence over many and distant churches in the latter part of the second century (Eusebius, *Hist. Eccles.* iv, 23). In the year 268 of the Christian era the city was burned by the Goths, and in 525 it was destroyed by an earthquake. During the Middle Ages Corinth shared the fate of many of the cities of Greece in being wrested from the emperors of Constantinople and possessed by a succession of adventurers, and at length formed a part of the duchy of Athens, ruled first by the French, then by the Arragonese kings of Sicily, and finally by the Accaioli, a family of Florence, from whom it was taken by Mohammed II in 1460. During a war between the Venetians and the Turks, it was captured by the former in 1687, but was recovered by the Turks in 1715, and held by them until the period of the Greek revolution, when it became the seat of the new gov-

ernment, although taken and retaken more than once during the war. Corinth is still an episcopal see. The cathedral church of St. Nicholas, "a very mean place for such an ecclesiastical dignity," used in Turkish times to be in the Acrocorinthus. The city has now shrunk to a wretched village, on the old site, and bearing the old name, which, however, is often corrupted into *Gorho* (see Hassel, *Handbuch der neuesten Erdbeschreib.* III, i, 678 sq.).

Pausanias, in describing the antiquities of Corinth as they existed in his day, distinguishes clearly between those which belonged to the old Greek city and those which were of Roman origin. Two relics of Roman work are still to be seen, one a heap of brick-work which may have been part of the baths erected by Hadrian, the other the remains of an amphitheatre



Plan of Corinth.

- A. Acrocorinthus.
- B. Lechaum.
- I, I. Long Walls.



Coins of Corinth.

with subterranean arrangements for gladiators. Far more interesting are the ruins of the ancient Greek temple—the “old columns which have looked down on the rise, the prosperity, and the desolation of two [in fact, three] successive Corinthia.” At the time of Wheler’s visit in 1676 twelve columns were standing; before 1795 they were reduced to five; and further injury has very recently been inflicted by an earthquake. It is believed that this temple is the oldest of which any remains are left in Greece. There are also distinct traces of the Posidonium, or sanctuary of Neptune, the scene of the Isthmian games, from which Paul borrows some of his most striking imagery in 1 Cor. and other epistles. See GAMES. The fountain of Peirene, “full of sweet and clear water,” as it is described by Strabo, is still to be seen in the Acrocorinthus, as well as the fountains in the lower city, of which it was supposed by him and Pausanias to be the source. The walls on the Acrocorinthus were in part erected by the Venetians, who held Corinth for twenty-five years in the 17th century. This city and its neighborhood have been described by many travellers, but we must especially refer to Leake’s *Morea*, iii, 229-304 (London, 1830), and his *Peloponnesiaca*, p. 892 (London, 1846); Curtius, *Peloponnesos*, ii, 514 (Gotha, 1851-1852); Clark, *Peloponnesus*, p. 42-61 (London, 1858). See also Pauly, *Real-Encycl.* ii, 643 sq.; Pott, *Prolegg.* in 1 ad Cor.; Conybeare and Howson, *St. Paul*, ch. xii. There are four German monographs on the subject—Wilckens, *Rerum Corinthiacarum specimen ad illustrationem utriusque Epistolæ Paulinæ* (Bremen, 1747; also in Oelrich’s *Collect. Opusc.* i, 427 sq.); Walch, *Antiquitates Corinthiæ* (Jena, 1761); Wagner, *Rerum Corinthiacarum specimen* (Darmst. 1824); Barth, *Corinthiorum Commercii et Mercaturæ Historia particula* (Berlin, 1844). For a full elucidation of the history and topography of the city, see Smith’s *Dict. of Class. Geogr.* s. v. Corinthus.—Kitto, s. v.; Smith, s. v. See ACHAIA.

Corinthian (Κορινθίος), an inhabitant (Acts xviii, 8; 2 Cor. vi, 11) of the city of Corinth (q. v.).

CORINTHIAN ORDER, the latest developed and the most ornamental of the three orders of Greek architecture. The column (q. v.) is about ten diameters in height, and is fluted. The capital is over a diameter of the column in height, has two rows of richly-carved leaves of acanthus, olive, or other plant, from above which roll out volutes, surmounted by leaves, and crowned by a moulding, called the abacus. The base is richly moulded. The Corinthian order was largely introduced in the Renaissance architecture, both in ecclesiastical and civil buildings. See ARCHITECTURE.

Corinthians, FIRST EPISTLE TO THE. 1. The testimony of Christian antiquity is full and unanimous in ascribing this inspired production to the pen of the apostle Paul (Lardner’s *Credibility, Works*, vol. ii, *plur. loc.*; see also Heydenreich, *Comment. in priorem D. Pauli ad Cor. epist. Proleg.* p. 30; Schott, *Isagoge in N. T.* p. 236, 239 sq.). The external evidences (Clem. Rom. ad Cor. ch. 47, 48; Polycarp, ad Phil. ch. 11; Ignat. ad Eph. ch. 2; Irenæus, *Hæc.* iii, 11, 9; iv, 27, 8; Athenag. de *Resurr.* p. 61, ed. Col.; Clem. Alex. *Pædag.* i, 38; Tertull. de *Præscr.* ch. 38) are extremely distinct, and with this the internal evidence arising from allusions, undesigned coincidences, style, and tone of thought fully accords (see Davidson, *Introd.* ii, 253 sq.).

2. The epistle seems to have been occasioned partly by some intelligence received by the apostle concerning the Corinthian church from the domestics of Chloe, a pious female connected with that church (i, 11), and probably also from common report (ἀκούεται, v, i), and partly by an epistle which the Corinthians themselves had addressed to the apostle, asking advice and instruction on several points (vii, 1), and which probably was conveyed to him by Stephanas, Fortunatus,

and Achaicus (xvi, 17). Apollos, also, who succeeded the apostle at Corinth, but who seems to have been with him at the time this epistle was written (xvi, 12), may have given him information of the state of things among the Christians in that city. From these sources the apostle had become acquainted with the painful fact that since he had left Corinth (Acts xviii, 18), the church in that place had sunk into a state of great corruption and error. One prime source of this evil state of things, and in itself an evil of no inferior magnitude, was the existence of schisms or party divisions in the church. “Every one of you,” Paul tells them. “saith I am of Paul, and I of Apollos, and I of Cephas, and I of Christ” (i, 12). This has led to the conclusion that four great parties had arisen in the church which boasted of Paul, Apollos, Peter, and Christ as their respective heads. By what peculiarities of sentiment these parties may be supposed to have been distinguished from each other it is not difficult, with the exception of the last, to conjecture. It appears that the schisms arose merely from quarrels among the Corinthians as to the comparative excellence of their respective teachers—those who had learned of Paul boasting that he excelled all others, and the converts of Apollos and Peter advancing a similar claim for them, while a fourth party haughtily repudiated all subordinate teaching, and pretended that they derived all their religious knowledge from the direct teaching of Christ. The language of the apostle in the first four chapters, where alone he speaks directly of these schisms, and where he resolves their criminality, not into their relation to false doctrine, but into their having their source in a disposition to glory in men, must be regarded as greatly favoring this view. (Comp. also 2 Cor. v, 16.)

The few facts supplied to us by the Acts of the Apostles, and the notices in the epistle, appear to be as follows: The Corinthian church was planted by the apostle himself (1 Cor. iii, 6) in his second missionary journey, after his departure from Athens (Acts xvii, 1 sq.). He abode in the city a year and a half (ch. xviii, 11), at first in the house of Aquila and Priscilla (ch. xviii, 8), and afterwards, apparently to mark emphatically the factious nature of the conduct of the Jews, in the house of the proselyte Justus. A short time after the apostle had left the city the eloquent Jew of Alexandria, Apollos, after having received, when at Ephesus, more exact instruction in the Gospel from Aquila and Priscilla, went to Corinth (Acts xix, 1), where he preached, as we may perhaps infer from Paul’s comments on his own mode of preaching, in a manner marked by unusual eloquence and persuasiveness (comp. ch. ii, 1, 4). There is, however, no reason for concluding that the *substance* of the teaching was in any respect different from that of Paul (see ch. i, 18; xvi, 12). This circumstance of the visit of Apollos, owing to the sensuous and carnal spirit which marked the church of Corinth, appears to have formed the commencement of a gradual division into two parties, the followers of Paul, and the followers of Apollos (comp. ch. iv, 6). These divisions, however, were to be multiplied; for, as it would seem, shortly after the departure of Apollos, Judaizing teachers, supplied probably with letters of commendation (2 Cor. iii, 1) from the church of Jerusalem, appear to have come to Corinth, and to have preached the Gospel in a spirit of direct antagonism to Paul *personally*, in every way seeking to depress his claims to be considered an apostle (1 Cor. xi, 2), and to exalt those of the Twelve, and perhaps especially of Peter (ch. i, 12). To this third party, which appears to have been characterized by a spirit of excessive bitterness and faction, we may perhaps add a fourth, that, under the name of “the followers of Christ” (ch. i, 12), sought at first to separate themselves from the factious adherence to particular teachers, but were eventually driven by antagonism into positions equally sectarian and inimical to the

unity of the church. At this momentous period, before parties had become consolidated, and had distinctly withdrawn from communion with one another, the apostle writes; and in the outset of the epistle (ch. i. v, 12) we have his noble and impassioned protest against this fourfold rending of the robe of Christ. This spirit of division appears, by the good providence of God, to have eventually yielded to his apostolic rebuke, as it is noticeable that Clement of Rome, in his epistle to this church (ch. 47), alludes to these evils as long past, and as but alight compared to those which existed in his own time. See DIVISIONS (IN THE CHURCH AT CORINTH).

Besides the schisms and the erroneous opinions which had invaded the church at Corinth, the apostle had learned that many immoral and disorderly practices were tolerated among them, and were in some cases defended by them. A connection of a grossly incestuous character had been formed by one of the members, and gloried in by his brethren (v, 1, 2); lawsuits before heathen judges were instituted by one Christian against another (vi, 1); licentious indulgence was not so firmly denounced and so carefully avoided as the purity of Christianity required (vi, 9-20); the public meetings of the brethren were brought into disrepute by the women appearing in them unveiled (xi, 3-10), and were disturbed by the confused and disorderly manner in which the persons possessing spiritual gifts chose to exercise them (xii-xiv); and, in fine, the *ἀγάπαι*, which were designed to be scenes of love and union, became occasions for greater contention through the selfishness of the wealthier members, who, instead of sharing in a common meal with the poorer, brought each his own repast, and partook of it by himself, often to excess, while his needy brother was left to fast (xi, 20-34). The judgment of the apostle had also been solicited by the Corinthians concerning the comparative advantages of the married and the celibate state (vii, 1-40), as well as, apparently, the duty of Christians in relation to the use for food of meat which had been offered to idols (viii, 1-13). For the correction of these errors, the remedying of these disorders, and the solution of these doubts, this epistle was written by the apostle.

8. The epistle consists of four parts. The first (i-iv) is designed to reclaim the Corinthians from schismatic contentions; the second (v-vi) is directed against the immoralities of the Corinthians; the third (vii-xiv) contains replies to the queries addressed to Paul by the Corinthians, and strictures upon the disorders which prevailed in their worship; and the fourth (xv-xvi) contains an elaborate defence of the Christian doctrine of the resurrection, followed in the close of the epistle by some general instructions, intimations, and greetings.

The apostle opens with his usual salutation and with an expression of thankfulness for their general state of Christian progress (ch. i, 1-9). He then at once passes on to the lamentable divisions there were among them, and incidentally justifies his own conduct and mode of preaching (ch. i, 10; iv, 16), concluding with a notice of the mission of Timothy, and of an intended authoritative visit on his own part (ch. iv, 17-21). The apostle next deals with the case of incest that had taken place among them, and had provoked no censure (ch. v, 1-8), noticing, as he passes, some previous remarks he had made upon not keeping company with fornicators (ch. v, 9-13). He then comments on their evil practice of litigation before heathen tribunals (ch. vi, 1-8), and again reverts to the plague-spot in Corinthian life, fornication and uncleanness (ch. vi, 9-20). The last subject naturally paves the way for his answers to their inquiries about marriage (ch. vii, 1-24), and about the celibacy of virgins and widows (ch. vii, 25-40). The apostle next makes a transition to the subject of the lawfulness of eating things sacrificed to idols, and Christian freedom generally (ch. viii), which

leads, not unnaturally, to a digression on the manner in which he waded his apostolic privileges and performed his apostolic duties (ch. ix). He then reverts to and concludes the subject of the use of things offered to idols (ch. x-xi, 1), and passes onward to reprove his converts for their behavior in the assemblies of the church, both in respect to women prophesying and praying with uncovered heads (ch. xi, 2-16), and also their great irregularities in the celebration of the Lord's Supper (ch. xi, 17-34). Then follow full and minute instructions on the exercise of spiritual gifts (ch. xii-xiv), in which is included the noble panegyric of charity (ch. xiii), and further a defence of the doctrine of the resurrection of the dead, about which doubts and difficulties appear to have arisen in this unhappily divided church (ch. xv). The epistle closes with some directions concerning the contributions for the saints at Jerusalem (ch. xvi, 1-4), brief notices of his own intended movements (ch. xvi, 5-9), commendation to them of Timothy and others (ch. xvi, 10-18), greetings from the churches (ch. xvi, 19, 20), and an autograph salutation and benediction (ch. xvi, 21-24).

4. From an expression of the apostle in ch. v, 9, it has been inferred by many that the present was not the first epistle addressed by Paul to the Corinthians, but that it was preceded by one now lost. For this opinion, however, the words in question afford a very unsatisfactory basis. They are as follows: *ἔγραψα ὑμῖν ἐν τῇ ἐπιστολῇ*, κ. τ. λ. Now these words must be rendered either "I have written to you in *this* epistle," or "I wrote to you in *that* epistle;" and our choice between these two renderings will depend partly on grammatical and partly on historical grounds. As the aorist *ἔγραψα* may mean either "I wrote" or "I have written," nothing can be concluded from it in either way. It may be doubted, however, whether, had the apostle intended to refer to a former epistle, he would have used the article *τῇ* simply, without adding *προϊόρῃ*, "former;" while, on the other hand, there are cases which clearly show that, had the apostle intended to refer to the present epistle, it was in accordance with his practice to use the article in the sense of "*this*" (comp. *ἡ ἐπιστολῇ*, Coloss. iv, 16, *τῇν ἐπιστ.* 1 Thess. v, 27). In support of this conclusion it may be added, 1st, that the apostle had really in this epistle given the prohibition to which he refers, viz., in the verses immediately preceding that under notice; and that his design in the verses which follow is so to explain that prohibition as to preclude the risk of their supposing that he meant by it anything else than that *in the church* they should not mingle with immoral persons; 2d, that it is not a little strange that the apostle should, only in this cursory and incidental manner, refer to a circumstance so important in its bearing upon the case of the Corinthians as his having already addressed them on their sinful practices; and, 3d, that, had such an epistle ever existed, it may be supposed that some hint of its existence would have been found in the records of the primitive Church, which is not the case. Alford, indeed (*Comment.* in 2 Cor. i, 16), thinks that 1 Cor. iv, 18, contains an allusion likewise to the lost letter, but the information there spoken of may easily have been otherwise communicated. On these grounds we strongly incline to the opinion that the present is the first epistle which Paul addressed to the Corinthians (Bloomfield, *Recentio Synopt.* in loc.; Billroth's *Commentary*, Eng. tr., i, 4, note a). The same view is taken by Lange (*Apost. Zeitalt.* i, 205) and others.—Kitto, s. v.; Smith, s. v.

5. There is a general agreement as to the date (at least the *place*) of this epistle. It was written from Ephesus (chap. xvi, 8), probably about the time of Passover (chap. v, 7, 8) of the apostle's third year there (Acts xix, 10; xx, 31), after his first severe treatment (chap. xv, 82; Acts xix, 9) had somewhat abated (chap. xvi, 9; Acts xix, 17), and when he had formed the purpose of a journey through Macedonia and

Greece (chap. xvi, 5; Acts xix, 21), and before the culminating act of mobbing (which cannot in any case be referred to in chap. xv, 32, since the apostle was still in Asia, chap. xvi, 19; and he mentions this incident in his next letter as a special piece of news, 2 Cor. i, 8), that only served to expedite his plan (Acts xx, 1; comp. xix, 29). See ACTS. This opinion is further verified by the following coincidences: [chap. i, 1, "Sosthenes" here was a *Christian*, and therefore different from the president of the synagogue at Corinth, Acts xviii, 17] chap. i, 11-16; ii, 1; iii, 1-6, Paul had left the Corinthian church in its infancy some time since, and Apollos had visited them meanwhile (Acts xviii, 18; xix, 1); chap. iv, 17, 19; xvi, 10, 11, Paul had just sent Timothy to them, and designed visiting them himself shortly (Acts xix, 21, 22; xx, 1, 2); chap. xv, 32, he had some time previously been violently opposed (*ἐμάχησα*) at Ephesus (Acts xix, 9); chap. xvi, 1, he had visited Galatia not very long before (Acts xviii, 23); chap. xvi, 5-7, he was about to set out for Macedonia, and thence to Corinth, where he designed to spend the coming winter (Acts xx, 1-3); chap. xvi, 8, he still expected to stay (*ἵκμενών*) at Ephesus till Pentecost, which stay was prolonged till the uproar about Diana (Acts xix, 22, 23); chap. xvi, 3, 4, he afterwards designed to visit Jerusalem (Acts xix, 21) [chap. xvi, 12, Apollos was at this time in the vicinity of Paul, but was not about to revisit Corinth just yet, Acts xix, 1]; chap. xvi, 19, Paul was surrounded by the churches of Asia, in the capital of which Aquila and Priscilla were now settled (Acts xviii, 18, 19, 26). Finally, the *subscription* (so far as of any authority) agrees with all this (comp. chap. xvi, 17), except as to Timothy, who was then on his way to Corinth (chap. iv, 17; xvi, 10) [for from 2 Cor. iii, 17, 18, it does not necessarily follow that Timothy (even supposing him to be there alluded to) did not visit Corinth till afterwards]; and also except as to the date at Philippi (the best copies read Ephesus), an error of tradition apparently arising from the fact that Paul was doubtless expecting to pass through (*διέρχομαι*) that city (Acts xx, 6). See TIMOTHY. (Comp. Conybeare and Howson's *Life and Epistles of St. Paul*, ii, 83). The date assigned this epistle by the foregoing particulars is the spring of A. D. 54. The bearers were probably (according to the common subscription) Stephanas, Fortunatus, and Achaicus, who had been recently sent to the apostle, and who, in the conclusion of this epistle (chap. xvi, 17), are especially commended to the honorable regard of the church of Corinth. For commentaries, see below. Of treatises on special points we may name the following (in Latin): those of Faust on the alleged lost epistle (Argent. 1671); on the schisms of the Corinthian Church, Dorecheus (Hafn. 1722), Mosheim (Helmst. 1726), Schongard (Hafn. 1738), Vitringa (*Obs. sacr.* iii, 800 sq.); on "leading about a wife," Quistorp (Rost. 1692), Witte (Viteb. 1691); on other national allusions, Olearius (Lips. 1807), Schlæger (Helmst. 1789), Wolle (Lips. 1781). See PAUL.

CORINTHIANS, SECOND EPISTLE TO THE. 1. We have seen above that, when writing his first epistle to the Corinthians, Paul expected shortly to visit them, and had indeed formed a detailed plan of the journey. But we may safely infer from 2 Cor. i, 15, 16, 23, that Paul had not been at Corinth between the writing of the first and second epistles, so that we must place his second epistle very soon after the writing of the first epistle, probably on his arrival at Philippi. The place whence it was written was clearly not Ephesus (see chap. i, 8), but Macedonia (chap. vii, 5; viii, 1; ix, 2), whither the apostle went by way of Troas (chap. ii, 12), after waiting a short time in the latter place for the return of Titus (chap. ii, 18). The Vatican MS., the bulk of later MSS., and the old Syr. version, positively assume Philippi as the exact place whence it was written; that the bearers were Titus and his associ-

ates (Luke?) is apparently substantiated by chap. vii, 23; ix, 8, 5.

The following coincidences will serve to establish this date: chap. i, 1, Timothy (who had now rejoined Paul by way of Corinth, 1 Cor. xvi, 10, 11) was in Paul's company (Acts xx, 4); chap. i, 8, Paul had lately escaped death at Ephesus (Acts xix, 30); chap. i, 15, 16, he had originally intended to go through Corinth to Macedonia, and return through Corinth to Judea, but, upon receipt of the information which called forth his first epistle, he had so far altered his plan (chap. i, 17; 1 Cor. iv, 18, 19) as to determine to forego the first of these visits to Corinth, and to make the second a longer one (1 Cor. xvi, 7), and he was ultimately compelled to pass through Macedonia to Corinth, and return through Macedonia to Jerusalem (Acts xx, 1-8); chap. ii, 12, 13, on his way to Macedonia, since writing the first epistle, he had touched at Troas (as usual, Acts xvi, 11; xx, 6), but did not stay, on account of Titus's absence, who afterwards met him in Macedonia, with intelligence of the good effects of his former letter (chap. vi, 5-15); chap. viii, 1; ix, 2, 4, he was now in Macedonia (Acts xx, 2); chap. viii, 6, 16-18, 22, 23, this letter was sent by Titus (compare *subscription*) (Acts xx, 4); chap. viii, 10; ix, 2, Paul was collecting funds for the church at Jerusalem (Acts xx, 16), and had heard of the Corinthians' readiness to contribute a year since, probably by Apollos, who had now returned to Ephesus (Acts xix, 1, compared with 1 Cor. xvi, 12). Finally, the *subscription* exactly tallies with these particulars; comp. chap. viii, 18, 22. (See Conybeare and Howson's *Life and Epistles of St. Paul*, ii, 97.)

2. From 2 Cor. ii, 1; xii, 14; xiii, 1, 2, many have inferred that before writing this epistle Paul had twice visited Corinth, and that one of these visits had been after the church there had fallen into an evil state; and the second of these visits has been most plausibly assigned to the apostle's three years' stay at Ephesus. So Chrysostom and his followers, Œcumenius and Theophylact, and in recent times, Müller (*De tribus Pauli itin.* Basil, 1831), Anger (*Rat. Temp.* p. 70, sq.), Wieseler (*Chronol.* p. 289), and the majority of modern critics. Olshausen adopts a still more complicated theory (*Comment.* iv, 124 sq., Am. ed.). We have seen above that this visit did not take place between the two epistles, and as it cannot be assigned to the subsequent residence in Greece (Acts xx, 2, 8), those who think it occurred are obliged to suppose one not mentioned in the Acts. (See this position maintained by Alford, *Comment. in N. T.*, ii, proleg. 49 sq.) This expedient of interpolating an event in a continuous history is always a doubtful one, and in this case seems excluded by the positive terms in which Paul's residence and labors are confined, during the whole time in question, to Ephesus (see Acts xix, 10, 22, compared with xx, 31). Nor is this hypothesis necessary; the passages that seem to imply an intended third visit, when carefully examined, merely speak of a third *intention* (*ἔπιτρον ἐπιτρομῶν ἔχω ἐλθεῖν*, chap. xii, 14, and *ἔπιτρον ἐπιτρομαί*, chap. xiii, 1, do not state two actual prior visits, as contended by Alford, *Comment.* in loc.; see Horne's *Introd.*, new ed., iv, 529) to visit them, only one of which had heretofore been successful (Acts xviii, 1; comp. 2 Cor. i, 15); and, in like manner, the "second, coming to them in heaviness" and "humbling," instead of depreciating a second such scene, simply intimates the possibility of such a scene on his second coming. (See Davidson's *Introd.* to *N. T.* ii, 218 sq.) This question, however, does not affect the dates assigned each epistle above, except so far as the supposed middle visit may be taken as the occasion of one or both of them—a position which we have shown to be wholly gratuitous and untenable. See PAUL.

3. "On arriving at Troas, Paul expected to meet Titus with intelligence from Corinth of the state of things in that church. According to the common opin-

tion Titus had been sent by Paul to Corinth, partly to collect money in aid of the distressed Christians in Palestine, partly to observe the effect of the apostle's first epistle on the Corinthians. In this expectation of meeting Titus at Troas Paul was disappointed. He accordingly proceeded into Macedonia, where at length his desire was gratified, and the wished-for information obtained (2 Cor. ii, 18; vii, 15 sq.)" (Kitto).

"The epistle was occasioned by the information which the apostle had received also, as it would certainly seem probable, from *Timothy*, of the reception of the first epistle. It has indeed recently been doubted by Neander, De Wette, and others, whether Timothy, who had been definitely sent to Corinth (1 Cor. iv, 17) by way of Macedonia (Acts xix, 22), really reached his destination (comp. 1 Cor. xvi, 10); and it has been urged that the mission of Timothy would hardly have been left unnoticed in 2 Cor. xii, 17, 18 (see Rückert, *Comm.* p. 409). To this, however, it has been replied, apparently convincingly, that as Timothy is an associate in writing the epistle, any notice of his own mission in the third person would have seemed inappropriate. His visit was assumed as a fact, and as one that naturally made him an associate with the apostle in writing to the church he had so lately visited.

"It is more difficult to assign the precise reason for the mission of Titus. That he brought back tidings of the reception which Paul's first epistle had met with seems perfectly clear (chap. vii, 6 sq.), but whether he was specially sent to ascertain this, or whether to convey fresh directions, cannot be ascertained. There is a show of plausibility in the supposition of Bleak (*Stud. u. Krit.* 1830, p. 625), followed more recently by Neander (*Pfanz. u. Leit.* p. 437), that the apostle had made Titus the bearer of a letter couched in terms of decided severity, now lost, to which he is to be supposed to refer in chap. ii, 8 (compared with ver. 4, 9); vii, 8, 11 sq.; but, as has been justly urged (see Meyer, *Einsleit.* p. 3), there is quite enough of severity in the first epistle (consider chap. iv, 18-21; v, 2 sq.; vi, 5-8; xi, 17) to call forth the apostle's affectionate anxiety. Moreover, the supposition of a lost letter is in itself improbable. If it be desirable to hazard a conjecture on this mission of Titus, it would seem most natural to suppose that the return of Timothy and the intelligence he conveyed might have been such as to make the apostle feel the necessity of at once despatching to the contentious church one of his immediate followers, with instructions to support and strengthen the effect of the epistle, and to bring back the most recent tidings of the spirit that was prevailing at Corinth" (Smith).

"The intelligence brought by Titus concerning the church at Corinth was on the whole favorable. The censures of the former epistle had produced in their minds a godly sorrow, had awakened in them a regard to the proper discipline of the church, and had led to the exclusion from their fellowship of the incestuous person. This had so wrought on the mind of the latter that he had repented of his evil courses, and showed such contrition that the apostle now pities him, and exhorts the church to restore him to their communion (2 Cor. ii, 6-11; vii, 8 sq.). A cordial response had also been given to the appeal that had been made on behalf of the saints in Palestine (ix, 2). But with all these pleasing symptoms there were some of a painful kind. The anti-Pauline influence in the church had increased, or at least had become more active; and those who were actuated by it had been seeking by all means to overturn the authority of the apostle, and discredit his claims as an ambassador of Christ.

4. "This intelligence led the apostle to compose his second epistle, in which the language of commendation and love is mingled with that of censure, and even of threatening. This epistle may be divided into three sections. In the first (i-iii) the apostle chiefly dwells on the effects produced by his first epistle and the mat-

ters therewith connected. In the second (iv-ix) he discourses on the substance and effects of the religion which he proclaimed, and turns from this to an appeal on behalf of the claims of the poor saints on their liberality. And in the third (x-xiii) he vindicates his own dignity and authority as an apostle against the parties by whom these were opposed. The divided state of feeling in the apostle's mind will account sufficiently for the difference of tone perceptible between the earlier and later parts of this epistle, without our having recourse to the arbitrary and capricious hypothesis of Semler (*Dissert. de duplici appendice Ep. ad Rom.* Hal. 1767) and Weber (*Prog. de numero epp. ad Cor. rectius constituendo*, Vitemb. 1798), whom Paulus follows, that this epistle has been extensively interpolated" (Kitto).

"A close analysis is scarcely practicable, as in no one of the apostle's epistles are the changes more rapid and frequent. Now he thanks God for their general state (chap. i, 8 sq.); now he glances at his purposed visit (chap. i, 15 sq.); now he alludes to the special directions in the first letter (chap. ii, 8 sq.); again he returns to his own plans (chap. ii, 12 sq.), pleads his own apostolic dignity (chap. iii, 1 sq.), dwells long upon the spirit and nature of his own labors (chap. iv, 1 sq.), his own hopes (chap. v, 1 sq.), and his own sufferings (chap. vi, 1 sq.), returning again to more specific declarations of his love towards his children in the faith (chap. vi, 11 sq.), and a yet further declaration of his views and feelings with regard to them (chap. vii). Then again, in the matter of the alms, he stirs up their liberality by alluding to the conduct of the churches of Macedonia (chap. viii, 1 sq.), their spiritual progress (ver. 7), the example of Christ (ver. 9), and passes on to speak more fully of the present mission of Titus and his associates (ver. 18, sq.), and to reiterate his exhortations to liberality (chap. ix, 1 sq.). In the third portion he passes into language of severity and reproof: he gravely warns those who presume to hold lightly his apostolical authority (chap. x, 1 sq.); he puts strongly forward his apostolical dignity (chap. xi, 5 sq.); he illustrates his forbearance (ver. 8 sq.); he makes honest boast of his labors (ver. 23 sq.); he declares the revelations vouchsafed to him (chap. xii, 1 sq.); he again returns to the nature of his dealings with his converts (ver. 12 sq.), and concludes with grave and reiterated warning (chap. xiii, 1 sq.), brief greetings, and a doxology (ver. 11-14).

5. "The genuineness and authenticity is supported by the most decided external testimony (Irenæus, *Haer.* iii, 7, 1; iv, 28, 8; Athenagoras, *de Resurr.* p. 61, ed. Col.; Clem. Alex. *Strom.* iii, 94; iv, 101; Tertull. *de Pudicit.* chap. 18), and by internal evidence of such a kind that what has been said on this point with respect to the first epistle is here even still more applicable. The only doubts that modern pseudo-criticism has been able to bring forward relate to the unity of the epistle, but these are not such as seem to deserve serious consideration (see Meyer, *Einsleit.* p. 7)" (Smith).

6. The following are the separate *Commentaries* on BOTH epistles, the most important being designated by an asterisk (*) prefixed: Jerome, *Commentarii* (in *Opp.* ii, 901); Chrysostom, *Homilies* (in *Opp.* x, 1, 485; transl. in the *Library of Fathers*, Oxf. 1839, 1848, vol. 4, 7, and 27); Cramer, *Ep. ad Cor.* (*Catenæ Gr. Patr.* v); Hugo a S. Victore, *Annotaciones* (in *Opp.*); Aquinas, *Expositio* (in *Opp.* vi); Zuingli, *Annotaciones* (in *Opp.* iv); *Calvin, tr. by Tymme, *Commentaries* (Lond. 1517, 4to); also tr. by Pringle, *Commentary* (Edinb. 1848, 2 vols. 8vo); Bullinger, *Commentarius* (Tigur. 1584-5, 2 vols. 8vo); Sarcer, *Meditationes* (Argent. 1544, 8vo); Meyer, *Annotaciones* (Berns, 1546, 4to); Major, *Enarratio* (Vitemb. 1558, 1561, 8vo); also *Predigten* (Jen. 1568, 8vo); Musculus, *Commentarius* (Basil. 1559, 1562, 1582, 1600, 1611, fol.); Shangenberg, *Predigten* (Eisleb. 1561-4, 2 vols. fol.); Arethus, *Commentarius* (Lausan. 1579, 8vo; Morg. 1583, fol.); Sta-

pleton, *Antidota* (Ant. 1595 sq., 3 vols. 8vo); Rollock, *Commentarius, cum notis I. Piscatoris* (Herborn. 1600, Jen. 1602, 8vo); Runge, *Disputationes* (Vitemb. 1606, 4to); Steuart, *Commentarius* (Ingolstadt, 1608, 4to); Weinrich, *Commentarius* (Lips. 1609, 1610, 4to); Coutzen, *Commentaria* (Colon. 1631, fol.); Perez, *In epp. ad Cor.* (Barcin. 1632, fol.); Selater, *Explicatio* (Oxon. 1633, 4to); Wandalin's paraphrase (in Danish, Copenhagen, 1648, 4to); Salmeron, *Disputationes* (in *Opp.* xiv); Cocceius, *Commentarius* (in *Opp.* v); Breithaupt, *Predigten* (Hal. 1696, 4to); *Biermann, *Verklarunge* (Tr. a. Rh. 1705-8, 3 vols. 4to); Locke, *Notes* (Lond. 1788, 4to); Pfenniger, *Erklärung* (Zür. 1759, 8vo); *Baumgarten, *Auslegung* (Hal. 1761, 4to); *Mosheim (ed. Windheim), *Erklärung* (Flensb. 1768, 2 vols. 4to); Semler, *Paraphrasis* (Hal. 1770 and 1776, 2 vols. 8vo); Moldenhauer, *Erklärung* (Hamb. 1771, 8vo); Schulz, *Briefe a. d. Kor.* (Hal. 1784-5, 2 vols. in 1, 8vo); Zacharia, ed. Volborth, *Anmerk.* (Gött. 1786, 2 vols. 8vo); Storr, *Notitia* (Tübing. 1788, 4to); Göpfert, *Anmerk.* (Lpz. 1788, 8vo); Morus, *Erklär.* (Leipz. 1794, 8vo); Wirth, *Ueb. d. Br. a. d. Kor.* (Ulm, 1825, 8vo); Pott, *Annotationes* (Götting. 1826, 8vo); Flatt, *Vorlesungen* (Tüb. 1827, 8vo); Lothian, *Leçons* (Edinb. 1828, 8vo); *Billroth, *Commentar* (Lpz. 1838, 8vo; transl. by W. L. Alexander, Edinb. 1837-8, 2 vols. 12mo); *Rückert, *Commentar* (Lpz. 1836-7, 2 vols. 8vo); Jäger, *Erklär.* (Tüb. 1837, 8vo); G. B.—, *Explanation* (Lond. 1842, 12mo); *Stanley, *Notes*, etc. (Lond. 1855, 1862, 1865, 2 vols. 8vo); Hodge, *Exposition* (N. Y. 1857-60, 2 vols. 12mo); Maier, *Commentar* (Freib. 1857-65, 2 vols. 8vo); Osiander, *Commentar* (Stuttg. 1847, 1858, 2 vols. 8vo); Robertson, *Lectures* (London, 1859, 1861, 8vo); *Neander, *Auslegung* (in his *Theol. Vorlesungen*, ed. Beyschlag, Berlin, 1859, 8vo); Kling, *Commentar* (Viteb. 1861, 8vo). See EPISTLES.

On the whole of the FIRST epistle alone: Sampson, *In ep. pr. ad Cor.* (London, 1546, 8vo); Martyr, *Commentarius* (Tigur. 1551, 1568, 4to; 1568, 1569, fol.); Haimo, *Tractatus* (in Duchery, *Spicileg.* i, 42); Hus, *Explicatio* (in *Monumenta*, ii, 88); Covillonius, *Conclusiones* (Romæ, 1554); Melancthon, *Commentarius* (Vitemb. 1661, 8vo); Prædenius, *Commentarius* (in *Opp.* Basil. 1663, fol.); Andreas, *Exegesis* (Francfort, 1665, 8vo); Mathesius, *Predigten* (Lpz. 1590, fol.); Steuart, *Commentaria* (Ingolst. 1694, 4to); Morton, *Expositio* (Lond. 1596, 8vo); Myle, *Explicatio* (Jen. 1600, 8vo); Valdesius's Commentary (in Spanish, without date or place); Crell, *Commentarius* [on chs. i-x, xv] (Racov. 1635, 8vo); Burgess, *Commentary* (London, 1659, fol.); Lightfoot, *Hor. Hebr.* (Cantab. 1664, Amst. 1677, Lips. 1679, 4to); Schmid, *Paraphrasis* (Hamb. 1691, 1696, 1704, 4to); Häberlin, *Explicatio* (Tüb. 1699); *Koning's Comm. (in Dutch, Dort, 1702, 4to); *Akersloot, *Vytlinge* (Leyden, 1707, 4to); Van Til, *Verklaaringe* (Amsterd. 1781, 4to); *Mosheim, *Erklärung* (Alt. and Flensb. 1741, 4to); Nicolai, *Betrachtungen* (Lpz. 1747, 4to); Pearce, *Paraphrase* (in *Comment.* ii); Sahl, *Paraphrasis* (Copenh. 1779, 4to); Vitringa, *Exercitationes* (Francof. 1784-9, 4to); Krause, *Annotatio* (Francof. 1792, 8vo, vol. i); Valkenaer, *Scholia* (ed. Wassenburgh, Amst. 1817 sq.); Heydenreich, *Commentarius* (Marburg, 1825, 1828, 2 vols. 8vo); Tolley, *Paraphrase* (Lond. 1825, 8vo); Peile, *Annotationes* (London, 1848, 8vo); Burger, *Erklär.* (Erlang. 1859, 8vo).

On the SECOND epistle: Heshusius, *Explicatio* (Helmsl. 1580, 8vo); *Koning's *Commentary* (in Dutch, Amst. 1704, 4to); Van Alphen, *Verklaaring* (Amst. 1708, enlarged Utrecht, 1725, 4to); Gabler, *Dissertatio* (Lemgo, 1804, 8vo); Leun, *Annotationes* (Lemgo, 1804, 8vo); Roynards, *Disputatio* (Tr. ad Rh. 1819, 8vo); *Emmerling, *Commentarius* (Lips. 1823, 8vo); Fritzsche, *Dissertationes* (Lips. 1824, 8vo); *Scharling, *Commentar* (Copenh. 1840, 8vo); Turnbull, *Translation* (Lond. 1849). See EPISTLES.

CORINTHIANS, APOCRYPHAL EPISTLES TO AND FROM. There are two such letters extant in the Ar-

menian language: the first is called "*The Epistle of the Corinthians to Paul the Apostle*," and the second "*The Epistle of Paul the Apostle to the Corinthians*." They were evidently based upon the early belief that the apostle had written to these converts more than twice. Their spuriousness has been shown by Carpov (*Epistolæ duæ apocryphæ*, etc. Lips. 1776) and Ullman (*Heidelberger Jahrb.* 1823, vi). The original Armenian with a translation, will be found in Aucher, *Arm. Grammar* (p. 143-161); it was also edited by Rink (*Heidelb.* 1824). These epistles are translated into Arabic, Latin, and English, in Whiston's *Authentic Records* (ii, 585-604). There are also "*Two Epistles of Clement to the Corinthians*" extant, the second of which, at least, is probably apocryphal. See CLEMENT OF ROME; CLEMENTINES. An English version of them exists in Wake's *Apostolical Fathers*. See EPISTLES (*Spurious*).

Corinthus (Κόρινθος), an Arabian, one of Herod's body-guard, greatly trusted by him till arrested on information by Fabatus of being bribed by Syllaes to kill his master, which he confessed on torture, and was sent by Saturninus to Rome for punishment (Josephus, *Ant.* xvii, 8, 2; *War.* i, 29, 8).

CORMAC MACULINAN, a bishop and king of Munster, in Ireland, was born A. D. 837. He was the author or collector of the *Pealler of Cashel*, a work that details the romances of the Milesian kings, a copy of which in the Irish language, according to Moore (*History of Ireland*), was seen in Limerick as late as 1712. He spent nearly his whole life in the duties of religion and pursuits of literature, founding numerous schools. But, being king, he was forced to fight. Before his first and only engagement he made his will, assembled his bishops, named his successor, gave them good advice, said he would die in battle, went into it, and died.

Cormorant. There are two Hebrew words thus translated in our version. (See *Bochart, Hieroz.* iii, 20 sq.)

1. חֲלָבִי' (*shalak'*, that which casts itself down; Sept. *καταβάκτρης*, Vulg. *merculus*, Syr. and Chald. *fish-catcher*; occurring only in Lev. xi, 17; Deut. xiv, 17), in common with the usual Greek version *καταβάκτρης*, is considered to have reference to darting, rushing, or stooping like a falcon; and accordingly has been variously applied to the eagle, the jerfalcon, the gannet, the great gull, and the cormorant. The passages where it occurs only inform us that it was an unclean bird, and associate it with the "gull."

Its apparent Greek name, *cataractes*, though noticed by several authors, is not always referred to the same genus, some making it a minor gull, others a diver. Cuvier thinks Gesner right in considering it to denote a gull, and it certainly might be applied with propriety to the black-backed gull, or to the glaucous; but although birds of such powerful wing and marine habits are spread over a great part of the world, it does not appear that, if known at the extremity of the Mediterranean, they were sufficiently common to have been clearly indicated by either the Hebrew or Greek names, or to have merited being noticed in the Mosaic prohibition. Both the above are in general northern residents, being rarely seen even so low as the Bay of Biscay, and the species now called "Lestris cataractes" is exclusively Arctic. With regard to the cormorant, birds of that genus are no doubt found on the coasts of Palestine, where high cliffs extend to the sea-shore, such, for example, as the *Phalacrocorax pygmaeus*; but all the species dive, and seldom, if ever, rush flying upon their prey, though that habit has been claimed for them by commentators, who have mixed up the natural history of "cormorants" with that of the "sula" or "gannet," which really darts from great elevations into the sea to catch its prey, rising to the surface sometimes nearly half a minute

after the plunge. But the gannet (solon goose) rarely comes further south than the British Channel, and does not appear to have been noticed in the Mediterranean. It is true that several other marine birds of the North frequent the Levant, but none of them can entirely claim Aristotle and Oppian's characters of "cataractes;" for, though the wide throat and rather large head of the dwarf cormorant may be adduced, that bird exceeds in stature the required size of a small hawk, and fishes, it may be repeated, swimming and diving, not by darting down on the wing, and is not sufficiently numerous or important to have required the attention of the sacred legislator.

Thus reduced to make a choice where the objections are less and the probabilities stronger, we conclude the *shalak* to have been a species of "tern," considered to be identical with the *Sterna Caspica*, so called because it is found about the Caspian Sea; but it is equally common to the Polar, Baltic, and Black Seas, and, if truly the same, is not only abundant for several months in the year on the coast of Palestine, but frequents the lakes and pools far inland, flying across he deserts to the Euphrates, and to the Persian and Red Seas, and proceeding up the Nile. It is the largest of the tern or sea-swallow genus, being about the weight of a pigeon, and near two feet in length, having a large black-naped head, powerful, pointed crimon bill, a white and grey body, with forked tail, and wings greatly exceeding the tips of the tail; the feet are very small, weak, and but slightly webbed, so that

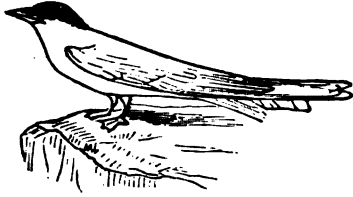

Caspian Tern.

It swims perhaps only accidentally, but with sufficient power on land to spring up and to rise from level ground. It flies with immense velocity, darting along the surface of the sea to snap at molluscs or small fishes, or wheeling through the air in pursuit of insects; and in calm weather, after rising to a great height, it drops perpendicularly down to near the surface of the water, but never alights except on land; and it is at all times disposed to utter a kind of laughing scream. This tern nestles in high cliffs, sometimes at a very considerable distance from the sea. (See *the Penny Cyclopaedia*, s. v. Tern.)—Kitto, s. v. Salach.

2. $\Gamma\aleph\aleph$ (*kaath*), rendered "cormorant" in our version in Isa. xxiv, 11; Zeph. ii, 14, is elsewhere translated "PELICAN," q. v.



Greater Cormorant (*Phalacrocorax Carbo*).—The bird in front is in full plumage, that behind in its Spring dress.

The cormorant belongs to the natural order of the *Pelicanidae* of Linnæus, and the species have the characteristic habit of watching on high cliffs, and, on perceiving a fish in the water, of darting down like an arrow and seizing its prey. The "greater cormorant," however, more frequently shoots along in a line nearly close to the surface of the water, or, sitting on the wave, dives after the prey. It is trained to fish for man's use in China. It is common on the coasts of Syria and Palestine; Rauwolf saw numbers of them along the sea-washed crags of Acre, which he mistook for sea-eagles. The cormorant is a widely-diffused genus, and is found in almost every country in the world. (See *the Penny Cyclopaedia*, s. v. Pelicanidae.) The large kind weighs about seven pounds, and is nearly of the same size as the goose; it lives upon fish, and has a long, straight, and compressed bill, with the upper mandible hooked at the point, to confine the prey with the greater security; its head and neck are of a sooty blackness, more resembling in figure those of the goose than of the gull. Its distinguishing character, however, consists in its toes being united by membranes, and by the middle toe being notched like a saw, to assist it in holding its fishy prey. On the approach of winter these birds are seen dispersed along the seashore, and ascending the mouths of rivers; they are remarkably voracious, and have such a quick digestion that the appetite appears insatiable. They build their nests on the highest parts of the cliffs that overhang the sea; the female usually lays three or four eggs about the size of those of a goose, and of a pale green color. See BIRD.

CORN. There are several words thus translated in the English version of the Scriptures, in which it is used in the proper sense of *grain* of any kind, and never in the American application of maize or "Indian corn" (*Zea mays* of Linn.), which it is generally thought was anciently unknown. In 1817, Parmentier (*Nouveau Dictionnaire d'Hist. Naturelle*, vol. xviii), founding on the silence of Varro, Columella, Pliny, and the other agricultural and botanical writers of classical antiquity, concluded that maize was unknown till the discovery of America; and in 1834 Meyer asserted that "nothing in botanical geography is more certain than the New-World derivation of maize" (quoted by Duchartre in Orbigny's *Dict. d'Hist. Natur.*). But since then, in the magnificent monograph (*Hist. Naturelle du Maïs*, 1836), M. Bonafous, the director of the Royal Garden of Agriculture at Turin, has shown that it is figured in a Chinese botanical work as old as the middle of the sixteenth century—a time when the discoveries of Columbus could scarcely have penetrated to the Celestial Empire; and, what is more conclusive, in 1819 M. Rifaud discovered under the head of a mummy at Thebes not only grains, but leaves of Indian corn. Nor is it at all impossible that the *Zea* of Homer and Theophrastus may include the plant in question. The wide diffusion of this corn through the Indian archipelago, and on the Indian continent itself, is in favor of the hypothesis which claims it as a native of the Old World; and if it was known to the Egyptians, nothing could be more natural than its early introduction into Palestine.—Fairbairn, s. v. See CEREALS.

1. The word $\aleph\aleph$, *dagan*' (from its increase), which is rendered "grain," "corn," and sometimes "wheat" in the Auth. Vers., is the most general of the Hebrew terms representing "corn," and is more comprehensive than any word in our language, seeing that it probably includes not only all the proper cereals, but also various kinds of pulse and seeds of plants, which we never comprehend under the name of "corn," or even of "grain." It may therefore be taken to represent all the commodities which we describe by the different words corn, grain, seeds, pease, beans. Among other places in which this word occurs, see

Gen. xxvii, 28-37; Num. xviii, 27; Deut. xxviii, 51; Lam. ii, 12, etc. See GRAIN.

2. There is another word, **בָּר**, *bar* (i. e. *winnowed*), which denotes any kind of cleansed corn, that is, corn purified from the chaff and fit for use (Gen. xli, 85-49; Prov. xi, 26; Jer. iv, 11; Joel ii, 24). The same word is more rarely used to describe corn in a growing state (Psa. lxx, 13). It elsewhere signifies the open "fields" or country. See LAND.

3. The word **שֶׁבֶר**, *she'ber* (*broken*, i. e. *grist*), which is sometimes rendered corn, denotes in a general sense "provisions" or "victuals," and by consequence "corn," as the principal article in all provisions (Gen. xlii, 1, 2, 20; Exod. viii, 5; Neh. x, 82, etc.). See VICTUALS.

4. The Greek *σῖτος* corresponds to the first two of the above Hebrew words, for which it often stands in the Sept. (Matt. iii, 12; Luke iii, 17; John xii, 24; Acts vii, 12, etc.). See EAR (*of corn*).

The other words occasionally translated "corn" in the Bible are **בִּלְיִל**, *belil'* (Job xxiv, 6), "provesder" (Isa. xxx, 24) or "fodder" (Job vi, 5); **גֹּפְרֵן**, *go'fren* (Deut. xvi, 18), elsewhere "threshing-floor;" **קָמַח**, *kamah'* (Deut. xvi, 9; Isa. xvii, 5), "standing corn," as often elsewhere; **κόκκος** (John xii, 24), a "grain" of any kind, as elsewhere; and **σπόριμα** (Matt. xii, 1), a "corn-field," as elsewhere; besides kindred or different terms rendered "beaten corn," "standing corn," "ears of corn," "heap of corn," "corn ground," etc. A single ear is **רִיבֹחֹת**, *shibbo'leth*; "pounded wheat," **רִיבֹחֹת**, *riphoth'* (2 Sam. xvii, 19; Prov. xxvii, 22). The most common kinds of corn were *wheat*, **חִטָּה**, *chittah'*; *barley*, **שֶׁבֶר**, *se'bar'*; *spelt*, (A. V., Exod. ix, 82, and Isa. xxviii, 26, "rye,"; Ezek. iv, 9, "fitches"), **קִשְׁמִים**, *kusse'mim* (or in plur. form **קִשְׁמֵי**, *kusse'mim*); and *millet*, **דֹּחָן**, *do'chan*: oats are mentioned only by rabbinical writers. The doubtful word **סֹרָח**, *sorah'*, rendered "principal," as an epithet of wheat, in the A. V. of Isa. xxviii, 25, is probably not distinctive of any species of grain (see Gesenius, s. v.). The different products coming under the denomination of corn are noticed under the usual heads, as BARLEY, WHEAT, etc.; their culture under AGRICULTURE; their preparation under BREAD, FOOD, MILL, etc.

"Corn crops are still reckoned at twenty-fold what was sown, and were anciently much more. 'Seven ears on one stalk' (Gen. xli, 22) is no unusual phenomenon in Egypt at this day. The many-eared stalk is also common in the wheat of Palestine, and it is of course of the bearded kind. The 'heap of wheat set about with lilies' (which probably grew in the field together with it) may allude to a custom of so decorating the sheaves (Cant. vii, 2). Wheat (see 2 Sam. iv, 6) was stored in the house for domestic purposes—the 'midst of the house' meaning the part more retired than the common chamber where the guests were accommodated. It is at present often kept in a dry well, and perhaps the 'ground corn' of 2 Sam. xvii, 19, was meant to imply that the well was so used. From Solomon's time (2 Chron. ii, 10, 15), i. e. as agriculture became developed under a settled government, Palestine was a corn-exporting country, and her grains were largely taken by her commercial neighbor Tyre (Ezek. xxvii, 17; comp. Amos viii, 5). 'Plenty of corn' was part of Jacob's blessing (Gen. xxvii, 28; comp. Psa. lxx, 13). The 'store-houses' mentioned 2 Chron. xxxii, 28, as built by Hezekiah, were perhaps in consequence of the havoc made by the Assyrian armies (comp. 2 Kings ix, 29); without such protection, the country, in its exhausted state, would have been at the mercy of the desert marauders. Grain **שֶׁבֶר** were liable to **גֵּרָטוֹן**, *geraton'*, 'mildew' and

שִׁדְדָפוֹן, *shiddaphon'*, 'blasting' (see 1 Kings viii, 37), as well as, of course, to fire by accident or malice (Exod. xxii, 6; Judg. xv, 5). Some good general remarks will be found in Saalschutz, *Archæol. d. Hebr.* (Smith, s. v.). See HUSBANDRY.

Cornarists, the disciples of Theodore Cornbert or Coornhert, secretary of the States of Holland († 1590). He wrote against the Romanists, the Lutherans, and Calvinists. He maintained that every religious communion needed reformation, but he said no one had a right to engage in it without a mission supported by miracles. He was also of opinion that connection with the visible Church of Christ was not essential to experimental Christianity. Arminius was directed to refute the writings of Coornhert against predestination, and in studying the subject was led to abandon that doctrine. The complete works of Coornhert were collected at Amsterdam in 1630 (3 vols. fol.). See Mosheim, *Church History*, iii, 400; Bayle, *Dictionary*, s. v. Koornhart, and the article ARMINIUS-ISM.

Corne'lius (**Κορνήλιος**, Lat. *Cornelius*). The centurion of this name, whose history occurs in Acts x, most probably belonged to the *Cornelii*, a noble and distinguished family at Rome. He is reckoned by Julian the Apostate as one of the few persons of distinction who embraced Christianity. His station in society will appear upon considering that the Roman soldiers were divided into legions, each legion into ten cohorts, each cohort into three bands, and each band into two centuries or hundreds; and that Cornelius was a commander of one of these centuries (*ισχυροτάτης*) belonging to the *Italic* band, so called from its consisting chiefly of Italian soldiers, formed out of one of the six cohorts granted to the procurators of Judæa, five of which cohorts were stationed at Caesarea, the usual residence of the procurators (Jahn, *Biblische Archæologie*, ii, 215, Wien, 1824). See CÆSTRION.

The religious position of Cornelius before his interview with Peter has been the subject of much debate. On the one side it is contended that he was what is called a *proselyte of the gate*, or a Gentile, who, having renounced idolatry and worshipping the true God, submitted to the seven (supposed) precepts of Noah, frequented the synagogue, and offered sacrifices by the hands of the priests, but, not having received circumcision, was not reckoned among the Jews. In support of this opinion it is pleaded that Cornelius is *φοβούμενος τὸν Θεόν* (a man fearing God), ver. 2, the usual appellation, it is alleged, for a proselyte of the gate, as in chap. xiii, 16, 26, and elsewhere; that he prayed at the usual Jewish hours of prayer (x, 30); that he read the Old Testament, because Peter refers him to the prophets (x, 43); and that he gave much alms to the Jewish people (x, 2, 22). On the other side it is answered that the phrases *φοβούμενος τὸν Θεόν*, and the similar phrases *εὐλαβείας* and *εὐσεβείας*, are used respecting any persons imbued with reverence towards God (x, 85; Luke i, 50; ii, 25; Col. iii, 22; Rev. xi, 18); that he is styled by Peter *ἀλλόφυλος* (a man of another race or nation), with whom it was unlawful for a Jew to associate, whereas the law allowed to foreigners a perpetual residence among the Jews, provided they would renounce idolatry and abstain from blood (Lev. xvii, 10, 11, 18), and even commanded the Jews to love them (Lev. xix, 38, 34); that they mingled with the Jews in the synagogue (Acts xiv, 1) and in private life (Luke vii, 8); that, had Cornelius been a proselyte of the gate, his conversion to Christianity would not have occasioned so much surprise to the Jewish Christians (Acts x, 45), nor would "they that were of the circumcision" have contended with Peter so much on his account (xi, 2); that he is expressly classed among the Gentiles by James (xv, 14), and by Peter himself, when claiming the honor

of having first preached to the Gentiles (xv, 7); that the remark of the opposing party at Jerusalem, when convinced, "then hath God also to the Gentiles granted *repentance unto life*," would have been inapplicable upon the very principles of those who assert that Cornelius was a proselyte, since they argue from the traditions of modern Jews, the most eminent of whom, Maimonides, admits a sincere proselyte to be in a *state of salvation*. The other arguments, derived from the observance of the Jewish hours of prayer by Cornelius, and his acquaintance with the Old Testament, are all resolvable into a view of his religious position, which will shortly be stated. The strongest objection against the supposition that Cornelius was a proselyte of the gate arises from the very reasonable doubt whether any such distinction existed in the time of the apostles (see Tomline, *Elements of Theology*, i, 266 sq.). Dr. Lardner has remarked that the notion of two sorts of proselytes is not to be found in any Christian writer before the *fourteenth* century (*Works*, vi, 522). See also Jennings's *Jewish Antiquities* (bk. i, ch. 3). The arguments on the other side are ably stated by Townsend (*Chronolog. N. Test.* note in loc.). See PROSELYTE. On the whole, the position of Cornelius with regard to religion appears to have been in that class of persons described by bishop Tomline, consisting of Gentiles who had so far benefited by their contact with the Jewish people as to have become convinced that theirs was the true religion, who consequently worshipped the true God, were acquainted with the Scriptures of the Old Testament, most probably in the Greek translation, and observed several Jewish customs, as, for instance, their hours of prayer, or anything else that did not involve an act of special profession. This class of persons seems referred to in Acts xiii, 16, where they are plainly distinguished from the Jews, though certainly mingled with them. To the same class is to be referred Candace's treasurer (Acts viii, 27, etc.); and in earlier times the midwives of Egypt (Exod. i, 17), Rahab (Josh. vi, 25), Ruth, Aramath the Jebusite (2 Sam. xxiv, 18, etc.), the persons mentioned 1 Kings viii, 41, 42, 43, Naaman (2 Kings v, 16, 17). See also Josephus, *Antiq.* xiv, 7, 2, and his account of Alexander the Great going into the Temple, and offering sacrifice to God according to the direction of the high-priest (*ibid.* xi, 8, 5); of Antiochus the Great (*ibid.* xii, 8, 3, 4), and of Ptolemy Philadelphus (*ibid.* xii, 2, 1, etc.). Under the influence of these facts and arguments, we regard Cornelius as having been selected of God to become the *first-fruit of the Gentiles*. His character appears suited, as much as possible, to abate the prejudices of the Jewish converts against what appeared to them so great an innovation. It is well observed by Theophylact that Cornelius, though neither a Jew nor a Christian, lived the *life of a good Christian*. He was *σωβήτης*, influenced by spontaneous reverence to God. He practically obeyed the restraints of religion, for he feared God, and this latter part of the description is extended to all his family or household (ver. 2). He was liberal in alms to the Jewish people, which showed his respect for them; and he "prayed to God always," at all the hours of prayer observed by the Jewish nation. Such piety, obedience, faith, and charity prepared him for superior attainments and benefits, and secured to him their bestowment (Psa. xxv, 9; 1, 23; Matt. xiii, 12; Luke viii, 15; John vii, 17). His position in command at Caesarea doubtless brought him into contact with intelligent Jews, from whom he learned the truths respecting the Messiah, and he seems to have been prepared by a personal knowledge of the external facts of Christianity to welcome the message of Peter as of divine authority.

The remarkable circumstances under which the benefits of the Gospel were conferred upon him are too plainly and forcibly related in Acts x to require much comment (see Paley, *Evidences*, prop. 2, ch. 2;

Niemeyer, *Charakt.* i, 660 sq.; Neander, *Planting and Training*, p. 69 sq.). While in prayer at the ninth hour of the day, he beheld, in waking vision, an angel of God, who declared that "his prayers and alms had come up for a memorial before God," and directed him to send to Joppa for Peter, who was then abiding "at the house of one Simon, a tanner." Cornelius sent accordingly; and when his messenger had nearly reached that place, Peter was prepared by the symbolical revelations of a noonday ecstasy, or trance, to understand that nothing which God had cleansed was to be regarded as common or unclean.—Kitto, s. v. This event took place about September, A. D. 32 (see *Meth. Quart. Review*, 1850, p. 499-501). "On his arriving at the house of Cornelius, and while he was explaining to them the vision which he had seen in reference to this mission, the Holy Ghost fell on the Gentiles present, and thus anticipated the reply to the question, which might still have proved a difficult one for the apostle, whether they were to be baptized as *Gentiles* into the Christian Church. They were so baptized, and thus Cornelius became the first-fruit of the Gentile world to Christ, publicly recognised as such. Tradition has been busy with his life and acts. According to Jerome (*adv. Jovin.* l, p. 301), he built a Christian church at Caesarea; but later tradition makes him bishop of Scamandios (Scamandria?), and ascribes to him the working of a great miracle (*Menolog. Græc.* l, 129)."—Smith, s. v.

There are monographs on the history of Cornelius in German by Linder (Basel, 1890), Krummacher (Brem. 1829, transl. Edinburgh, 1889), in Latin by Basili (*Opp.* p. 108), in English by Evans (*Script. Biog.* iii, 809); also in Latin, on his character by Fecht (Roet. 1701), Feuerlin (Altorf. 1786); on Peter's vision, by Deysing (Marb. 1710), Engeström (Lund. 1741); on the effusion of the Spirit, by Goetze (Lubec. 1712); on his baptism, by the same (*ib.* 1713); on his prayers, by Michaelis (in the *Bibl. Brem.* v, 679 sq.); on Peter's sermon, in English, by Taylor (London, 1659). See also Krummacher, *Life of Cornelius* (Edinb. 1839, 12mo); *Jour. Sac. Lit.* April, 1864.

Cornelius, bishop of Rome, succeeded Fabianus in that see June 4, A. D. 251. Some of the clergy and people of Rome, not approving of the election of Cornelius because of his controversy with Novatianus about the *lapsi*, to whom Cornelius was disposed to be lenient, chose Novatianus bishop, and three Italian bishops ordained him; he therefore was the first antipope. In October, 261, Cornelius having convened a numerous council at Rome, consisting of sixty bishops and a number of presbyters and deacons, they confirmed his election. He did not enjoy his honor long, for he was banished by the emperor Gallus to Civita Vecchia, where he died (or, according to some accounts, suffered martyrdom) September 14, 252. Ten of Cyprian's letters are directed to Cornelius. There are two genuine letters of Cornelius to Cyprian still preserved among Cyprian's epistles; they are the forty-sixth and forty-eighth (ed. Oberthur). Besides these, Cornelius wrote a long letter to Fabianus concerning the character and conduct of Novatian, considerable extracts from which Eusebius has preserved (*Hist. Eccl.* bk. vi, chap. xliii).—Lardner, *Works*, iii, 74 sq.; Cave, *Hist. Lit.* i, 80; Wetzer u. Welte, *Kirchen-Lex.* ii, 879.

Cornelius Agrippa. See AGRIPPA.

Cornelius a Lapide (CORNELIUS CORNELIUSSEN VAN DEN STEEN), a learned Roman Catholic commentator, was born in 1566 at Bocholt, in the diocese of Liege, entered the order of Jesuits, and became professor of Hebrew at Louvain, where he gave exegetical lectures for twenty years. He was then made professor at Rome, where he died March 12, 1687. He wrote commentaries on all the books of Scripture except Job and the Psalms, which are in great esteem, more, how-

ever, from the rich material in the form of citations from the fathers than from any critical skill of his own. The commentaries on the Pentateuch and the Pauline Epistles are commonly regarded as the best. They were published at Antwerp, 1681 (10 vols. fol.); at Venice, 1780 (11 vols. fol.); and at Lyons (best edition, 1888, 11 vols. 4to).—Wetzer u. Welte, *Kirchen-Lex.* ii, 679.

Cornelius, Elias, D.D., a Congregational minister, was born in Somers, N. Y., July 31, 1794. He graduated at Yale in 1813. In 1816, after being licensed to preach, he was appointed agent of the American Board of Commissioners for Foreign Missions. In the spring of 1817 he started on a missionary tour to the Creeks and Cherokees, and then to New Orleans, where he remained until April 2, 1818, when he returned to Boston, visiting the Indian Mission on his way. He was ordained collegiate pastor of Tabernacle church in Salem July 21, 1819. In Oct. 1826, he resigned, and entered upon his duties as secretary of the American Education Society. In Oct. 1831, he was elected secretary of the American Board of Commissioners for Foreign Missions. He died Feb. 12, 1832. He published several occasional sermons and useful tracts.—Sprague, *Annals*, ii, 638; Edwards, *Memoir of Cornelius* (Bost. 1834, 12mo).

Corner. The words thus translated in our version of the Bible are the following:

1. פִּנְיָהּ, *pinnah'*, signifies properly a *pinnacle*, as *shooting up* (2 Chron. xxvi, 15; Zeph. i, 16; iii, 6); hence an *angle*, properly exterior, as of a house (Job i, 19), of a street (Prov. vii, 8); also interior, as of a roof (Prov. xxi, 9; xxv, 24), of a court (Ezek. xlii, 20), of a city (2 Chron. xxviii, 24). It is put metaphorically for a *prince* or chief of the people (1 Sam. xiv, 38; Judg. xx, 2; Isa. xix, 18). The abbreviated form, יָנָהּ, *pen*, occurs Prov. vii, 8; Zech. iv, 10.

2. פֶּאֵה, *peah'*, properly the *mouth*, then the *face*; hence, generally, a "*side*" of anything (especially a point of the compass, as on the east side, i. e. eastward, "the four corners" standing for the whole extent), or region, as of the *face* ("part" Lev. xiii, 41); of country ("corners," Neh. ix, 22, i. e. various districts of the promised land allotted to the Israelites; so "corner of Moab," Jer. xlviii, 15, i. e. that country; and in the plural, "corners [literally, the two sides] of Moab," Num. xxiv, 17, the whole land). Secondly it denotes the *extreme part* of anything, as of a field (Lev. xix, 9; xxiii, 22), of the sacred table (Exod. xxv, 26; xxxvii, 18), of a couch or divan, the place of honor (Amos iii, 12). The "corners of the head and beard" (Lev. xix, 27; xxi, 5) were doubtless the extremities of the hair and whiskers running around the ears, which the Jews were forbidden to cut or shave off round, like the *clipped ear-locks* (mistranslated "utmost corners," Jer. ix, 26; xxv, 28; xlix, 82) of the heathen and the ancient Arabs of the desert (Herod. iii, 8). Illustrations of this fashion are still extant; indeed, Mr. Osburn (in his *Ancient Egypt*, p. 125) seems to have identified some figures on the Egyptian monuments with the ancient Hittites, one of the very tribes here alluded to, and who are exhibited as wearing helmets or skull-caps of a peculiar form, so as to leave exposed this peculiar national badge. They appear to have had a hideous custom of shaving a square

3. כַּנְפֵי, *kaneph'*, a *wing* (as elsewhere often), is used in Isa. xi, 12; Ezek. vii, 7, to express "the four corners of the earth," or the whole land.

4. כַּתֶּפֶף, *katheph'*, a *shoulder* or *side* (as often elsewhere), occurs in 2 Kings xi, 11, in speaking of the opposite parts of the Temple.

5. מִקְצוֹתָיו, *miktso'ot* (literally *cut off* or *beams*), as *angle*, spoken of the external extremities of the tabernacle (Exod. xxvi, 24; xxxvi, 29), and the internal ones of a court (Ezek. xli, 22; xlv, 21, 22); also of a bend or "turning" of a wall, conventionally applied apparently to the intersection of the internal wall of Jerusalem skirting Mount Zion on the east, with the continuation of that on the northern brow towards the Temple (2 Chron. xxvi, 9; Neh. iii, 19, 20, 24, 25). A kindred form occurs in the last clause of Ezek. xii, 22, where some render *four-square*.

6. מַצְעָה, *pa'am* (literally a *step*, usually a "time" or instance), spoken of the four corners of the sacred ark (Exod. xxv, 12), and of the brazen laver (1 Kings vii, 80).

7. צַלָּהּ, *tsela'* (literally a *rib* or *side*, as often elsewhere), spoken of either extremity of each side of the altar of incense (Exod. xxx, 4; xxxvii, 27).

8. קַצְוֵי, *katsah'*, an *end* (as elsewhere usually), spoken of the four corners of the same (Exod. xxxvii, 4).

9. קַוְיָיו, *kwiyi'*, spoken of the "corners" of the altar (Zech. ix, 15); fig. of the *corner columns* of a palace (Psa. cxliv, 12, "that our daughters may be as corner-stones"), finely sculptured, in allusion probably to the *caryatides*, or columns, representing female figures, so common in Egyptian architecture (the point of comparison lying in the slenderness and tallness combined with elegance, comp. Cant. v, 15; vii, 8).

10. The Greek word *γωνία* signifies properly an *angle*, either exterior, as when streets meet, forming a *square* or place of public resort (Matt. vi, 5), or interior, a dark recess, put for *secrecy* (Acts xxvi, 26). "The four corners of the earth" denote the whole land or world, as in No. 1 above (Rev. vii, 1; "quarters," xx, 8). On "the head of the corner," see CORNERSTONE below.

11. The "corners" of the great sheet in Peter's vision (Acts x, 11; xi, 5) represent a different word in the original, ἀρχή, which has elsewhere usually the signification of "beginning."

"The פֶּאֵה, *peah'*, or 'corner,' i. e. of the field, was not allowed (Lev. xix, 9) to be wholly reaped. The law gave a right to the poor to carry off what was so left, and this was a part of the maintenance from the soil to which that class were entitled. Similarly the gleanings of fields and fruit-trees, and the taking of a sheaf accidentally left on the ground, were secured to the poor and the stranger by law (xxiii, 22; Deut. xxiv, 19-21). See GLEANING. These seem to us, amid the sharply defined legal rights of which alone civilization is cognizant, loose and inadequate provisions for the relief of the poor. But custom and common law had probably ensured their observance (Job xxiv, 10) previously to the Mosaic enactment, and continued for a long but indefinite time to give practical force to the statute. Nor were the 'poor,' to whom appertained the right, the vague class of sufferers whom we understand by the term. On the principles of the Mosaic polity, every Hebrew family had a hold on a certain fixed estate, and could by no ordinary and casual calamity be wholly beggared. Hence its indigent members had the claims of kindred on the 'corners,' etc., of the field which their landed brethren reaped. Similarly the 'stranger' was a recognised dependent; 'within thy gates' being his expressive description, as shaming, though not by any tie of blood, the domestic claim. There was thus a further security for the maintenance of the right in its



Hittite Ear-locks.

place just above the ear, leaving the hair on the side of the face and the whiskers, which hung down in a *'tailed lock*.

definite and ascertainable character. Neither do we discover in the earlier period of the Hebrew polity, closely detailed as its social features are, any general traces of agrarian distress and the unsafe condition of the country which results from it—such, for instance, as is proved by the banditti of the Herodian period. David, a popular leader (1 Sam. xviii, 30; xxi, 11), could only muster from four to six hundred men out of all Judah, though every one that was in distress, in debt, and every one that was discontented, came to him (1 Sam. xxii, 2; xxv, 18). Further, the position of the Levites, who had themselves a similar claim on the produce of the land, but no possession in its soil, would secure their influence as expounders, teachers, and, in part, administrators of the law, in favor of such a claim. In the later period of the prophets their constant complaints concerning the defrauding of the poor (Isa. x, 2; Amos v, 11; viii, 6) seem to show that such laws had lost their practical force. (These two passages, speaking of 'taking burdens of wheat from the poor,' and of 'selling the refuse [מִנְיָקִים] of the wheat,' i. e. perhaps the gleanings, seem to point to some special evasion of the harvest laws.) Still later, under the Scribes, minute legislation fixed one sixtieth as the portion of a field which was to be left for the legal 'corner,' but provided also (which seems hardly consistent) that two fields should not be so joined as to leave one corner only where two should fairly be reckoned. The proportion being thus fixed, all the grain might be reaped, and enough to satisfy the regulation subsequently separated from the whole crop. This 'corner' was, like the gleanings, tithe-free. Certain fruit-trees, e. g. nuts, pomegranates, vines, and olives, were deemed liable to the law of the corner. Maimonides, indeed, lays down the principle (*Constitutiones de donis pauperum*, cap. ii, 1) that whatever crop or growth is fit for food, is kept, and gathered all at once, and carried into store, is liable to that law. A Gentile holding land in Palestine was not deemed liable to the obligation. As regards Jews, an evasion seems to have been sanctioned as follows: Whatever field was consecrated to the Temple and its services was held exempt from the claim of the poor; an owner might thus consecrate it while the crop was on it, and then redeem it, when in the sheaf, to his own use. Thus the poor would lose the right to the 'corner.' This reminds us of the 'Corban' (Mark vii, 11). For further information, see AGRICULTURE. The treatise *Peah*, in the Mishna, may likewise be consulted, especially chap. I, 2, 3, 4, 5, 6; II, iv, 7; also the above-quoted treatise of Maimonides" (Smith, s. v.). See HARVEST.

The CORNER-GATE (מִצְדֵי הַקִּיָּץ) of Jerusalem, spoken of in 2 Kings xiv, 18; 2 Chron. xxvi, 9; Jer. xxxi, 38, was on the N.W. side of the ancient city, in Josephus's "second wall," and between the present sites of Calvary and the Damascus Gate. (See Strong's *Harmony and Exposition of the Gospels*, Appendix ii, p. 17.) See JERUSALEM.

CORNER-STONE (מִצְדֵי הַקִּיָּץ, Job xxxviii, 6; Isa. xxviii, 16; Sept. and N. T. *κεφαλή γωνίας*), a quoin or block of great importance in binding together the sides of a building. (On Psa. cxlv, 12, see No. 9 above.) Some of the corner-stones in the ancient work of the temple foundations are 17 or 19 feet long, and 7½ feet thick (Robinson, *Researches*, i, 422). Corner-stones are usually laid sideways and endways alternately, so that the end of one appears above or below the side-face of the next. At Nineveh the corners are sometimes formed of one angular stone (Layard, *Nineveh*, ii, 201). The corresponding expression, "head of the corner" (מִצְדֵי הַקִּיָּץ), in Psa. cxviii, 22, is by some understood to mean the coping or ridge, "coign of vantage," i. e. topstone of a building; but as in any part a corner-stone must of necessity be of great im-

portance, the phrase "corner-stone" is sometimes used to denote any principal person, as the princes of Egypt (Isa. xix, 18), and is thus applied to our Lord, who, having been once rejected, was afterward set in the highest honor (Matt. xxi, 42; see Grotius on Psa. cxviii; comp. Harmer, *Obs.* ii, 386). The symbolical title of "chief corner-stone" (ἀρχὸς ἀπογώνιας) is also applied to Christ in Eph. ii, 20, and 1 Pet. ii, 8, 16, which last passage is a quotation from Isa. xxviii, 16, where the Sept. has the same words. The "corner-stone," or half-underlying buttress, properly makes no part of the *foundation*, from which it is distinguished in Jer. li, 56; though, as the edifice rests thereon, it may be so called. Sometimes it denotes those massive slabs which, being placed towards the bottom of any wall, serve to bind the work together, as in Isa. xxviii, 16. Of these there were often two layers, without cement or mortar (Bloomfield, *Recess. Synop.* on Eph. ii, 20). Christ is called a "corner-stone," (1.) In reference to his being the foundation of the Christian faith (Eph. ii, 20); (2.) In reference to the importance and conspicuousness of the place he occupies (1 Pet. ii, 6); and (3.) Since men often stumble against a projecting corner-stone, Christ is therefore so called, because his gospel will be the cause of aggravated condemnation to those who reject it (Matt. xxi, 44). See STUMBLING-STONE.

The prophet (Zech. x, 4), speaking of Judah, after the return from the exile, says, "out of him came [i. e. shall come] forth the corner [i. e. prince], out of him the nail;" probably referring ultimately to the "corner-stone," the Messiah.

CORNERUS, CHRISTOPHORUS (KÖRNER), a German divine, was born in Franconia 1618, and was educated under his uncle, Conrad Wimpina. In 1640 he was made professor at Frankfort-on-the-Oder and ecclesiastical superintendent. He aided Andrea in the preparation of the Formula of Concord (see CONCORD), and wrote several works in Biblical literature and theology, now of little account. He died April 17, 1649.—Melchior Adam, *Vita Eruditorum*, i, 815.

CORNET, properly שֹׁפָר, *shophar*' (prob. from שָׁפַר, to be bright, with reference to the clearness of sound; comp. שֹׁפָרִים, Psa. xvi, 6), Gr. *σαλπιγξ*, Lat. *buccina*, a loud-sounding instrument, made of the horn of a ram or of a chamois (sometimes of an ox), and used by the ancient Hebrews for signals, for announcing the jubilee" (Lev. xxv, 9), for proclaiming the new year (Mishna, *Rosh Hashanah*, iii and iv), for the purpose of war (Jer. iv, 6, 19; comp. Job xxxix, 25), as well as for the sentinels placed at the watch-towers to give notice of the approach of an enemy (Ezek. xxxiii, 4, 5). *Shophar* is generally rendered in the A. V. "trumpet," but "cornet" is used in 1 Chron. xv, 28; 2 Chron. xv, 14; Psa. xcvi, 6; Hos. v, 8. "Cornet" is also employed in 2 Sam. vi, 5, for מִנְצִיטִים, *menadnim*, *sistra*, a musical instrument or rattle, which gave a tinkling sound on being shaken (used in Egypt in the worship of Isis; see Wilkinson, ii, 323 sq.). Finally, in Dan. iii, 5, 7, 10, 15, for the Chald. (and Heb.) term שֶׁרָן, *keren*, a horn (as elsewhere rendered) or simple tube.

Oriental scholars for the most part consider the *shophar* and the *keren* to be one and the same musical instrument; but some Biblical critics regard the *shophar* and the שֹׁפָרִים, *shofarim*' (invariably rendered "trumpet" in the A. V.), as belonging to the species of the *keren*, the general term for a horn (Joel Brill, in preface to Mendelssohn's version of the Psalms). Jahn distinguishes *keren*, "the horn or crooked trumpet," from *shofarim*, the straight trumpet, an instrument a cubit in length, hollow throughout, and at the larger extremity so shaped as to resemble the mouth of a short bill" (*Archæolog.* xcv, 4, 5); but the generally received opinion is, that *keren* designates the crooked

horn, and *shophar* the long and straight one. The *cornet* properly denotes a shrill wind military instrument of wood, now mostly superseded by the *oboe*. It was blown with a mouth-piece, and varied in size and tone (Mersenne's *Harmonie Universelle*). The sounds emitted from the cornet in modern times are exceedingly harsh, although they produce a solemn effect. See **MUSIC**.

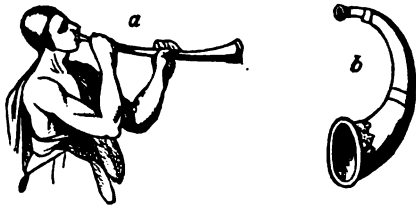

Ancient Cornets: a, from Herculaneum; b, from Calmet.

"The silver trumpets (חֲצוֹצְרוֹת כֶּסֶף) which Moses was charged to furnish for the Israelites were to be used for the following purposes: for the calling together of the assembly, for the journeying of the camps, for sounding the alarm of war, and for celebrating the sacrifices on festivals and new moons (Num. x, 1-10). The divine command through Moses was restricted to two trumpets only, and these were to be sounded by the sons of Aaron, the anointed priests of the sanctuary, and not by laymen. It would seem, however, that at a later period an impression prevailed that 'while the trumpets were suffered to be sounded only by the priests *within* the sanctuary, they might be used by others, not of the priesthood, *without* the sacred edifice' (Conrad Iken's *Antiquitates Hebraicae*, par. i, sec. vii, 'Sacerdotum cum instrumentis ipsorum'). In the age of Solomon the 'silver trumpets' were increased in number to 120 (2 Chron. v, 12); and, independently of the objects for which they had been first introduced, they were now employed in the orchestra of the Temple as an accompaniment to songs of thanksgiving and praise.

"*Yobel*, יוֹבֵל, used sometimes for the 'year of Jubilee' (שָׁנַת חַיִּיבֹל); comp. Lev. xxv, 18, 15, with xxv, 28, 80), generally denotes the institution of Jubilee; but in some instances it is spoken of as a musical instrument, resembling in its object, if not in its shape, the *keren* and the *shophar*. Gesenius pronounces *yobel* to be 'an onomatopoeic word, signifying *jubilation* or a joyful sound, and hence applied to the sound of a trumpet signal, like חֲצוֹצְרוֹת' ('alarm,' Num. x, 5); and Dr. Munk is of opinion that 'the word **YOBEL** is only an epithet' (*Palestine*, p. 456 a, note). Still it is difficult to divest *yobel* of the meaning of a sounding instrument in the following instances: 'When the trumpet (חַיִּיבֹל) soundeth long, they shall come up to the mount' (Exod. xix, 18); 'And it shall come to pass that when they make a long blast with the ram's horn' (בְּקֶרֶן חַיִּיבֹל, Joshua vi, 5); 'And let seven priests bear seven trumpets of rams' horns' (שִׁבְעָרוֹת יוֹבֵלִים, Josh. vi, 6). See **JUBILEE**.

"The sounding of the cornet (תְּקִיעַת שׁוֹפָר) was the distinguishing ritual feature of the festival appointed by Moses to be held on the first day of the seventh month, under the denomination of 'a day of blowing trumpets' (יוֹם תְּרוּעָה), Num. xxix, 1), or 'a memorial of blowing of trumpets' (זִכְרוֹן תְּרוּעָה), Lev. xxiii, 24); and that rite is still observed by the Jews in their celebration of the same festival, which they now call 'the day of memorial' (יוֹם זִכְרוֹן), and also 'New Year' (רֵאשׁ חֹשֶׁנֶּה). 'Some commentators,' says Rosenmüller, 'have made this festival refer to the preservation of Isaac (Gen. xxii), whence it is sometimes called by the Jews 'the Binding of Isaac'

(עֲקִידַת יִצְחָק). But it is more probable that the name of the festival is derived from the usual kind of trumpets (ram's horns) then in use, and that the object of the festival was the celebration of the new year and the exhortation to thanksgivings for the blessings experienced in the year just finished. The use of cornets by the priests in all the cities of the land, not in Jerusalem only (where two silver trumpets were added, while the Levites chanted the 81st Psalm), was a suitable means for that object' (*Morgenland*, vol. ii, No. 837, on Lev. xxiii, 24).

"Although the festival of the first day of the seventh month is denominated by the Mishna 'New Year,' and notwithstanding that it was observed as such by the Hebrews in the age of the second temple, there is no reason whatever to believe that it had such a name or character in the times of Moses. The Pentateuch fixes the vernal equinox (the period of the institution of the Passover) as the commencement of the Jewish year; but for more than twenty centuries the Jews have dated their new year from the autumnal equinox, which takes place about the season when the festival of 'the day of sounding the cornet' is held. Rabbinical tradition represents this festival as the anniversary of the creation of the world, but the statement receives no direct support from Scripture. On the contrary, Moses expressly declares that the month *Abib* (the moon of the spring) is to be regarded by the Hebrews as the first month of the year: 'This month shall be unto you the beginning (רֵאשִׁית) of months; it shall be the first (אֲרִבְּתָא) month of the year to you' (Exod. xii, 2) (Munk, *Palestine*, p. 184 b). See **YEAR**.

"The intention of the appointment of the festival 'of the sounding of the cornet,' as well as the duties of the sacred institution, appear to be set forth in the words of the prophet, 'Sound the cornet (שִׁבְרָה) in Zion, sanctify the fast, proclaim the solemn assembly' (Joel ii, 15). Agreeably to the order in which this passage runs, the institution of 'the festival of sounding the cornet' seems to be the prelude and preparation for the awful day of atonement. The divine command for that fast is connected with that for 'the day of sounding the cornet' by the conjunctive particle אֲתָּה. 'Likewise on the tenth day of this seventh month is the day of atonement' (Lev. xxiii, 27). Here אֲתָּה (likewise) unites the festival 'of the day of sounding the cornet' with the solemnity of the day of atonement precisely as the same particle connects the 'festival of tabernacles' with the observance of the ceremonial of 'the fruit of the *hadar*-tree, the palm branches,' etc. (Lev. xxiii, 34-40). The word 'solemn assembly' (עֲצָרָה) in the verse from Joel quoted above applies to the festival 'eighth day of solemn assembly' (שְׁטִינֵי עֲצָרָה) (Lev. xxiii, 36), the closing rite of the festive cycle of *Tisri* (see Marks, *Religious Discourses*, i, 291-2).

"Besides the use of the cornet on the festival of 'blowing the trumpets,' it is also sounded in the synagogue at the close of the service for the day of atonement, and, among the Jews who adopt the ritual of the *Sephardim*, on the seventh day of the feast of tabernacles, known by the post-biblical denomination of 'the Great Hosannah' (חֹזֶשׁ עֲנָה בְּקֶרֶן).—Smith, a. v. See **TRUMPET**.

Cornhart or Coornhart. See **CORNARISTA**.

Cornice (Gr. *κορνίσις*, a curved line), a horizontal moulded projection crowning the angle of a building or any of its parts, varying with the different orders and periods of architecture. In the early Gothic the cornice consisted of a corbel-table (q. v.). Later, a deep hollow, with a simple moulding (astragal) below, and one or more mouldings above, and with flowers,

animals, or angels richly carved in the hollow, constituted the predominant feature. With the Renaissance the classical cornice returned.

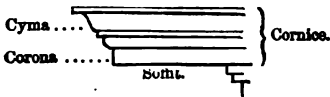

Corona (Lat.), the lower member of a classical cornice. The horizontal under surface of it is called the *soffit*. English ecclesiastical writers often have applied the term *corona* to the semicircular apsis of a choir.

Coronāti, (I.) "a name of the ancient clergy, supposed to have been given to them in consequence of their shaven crowns. But Bingham and others have shown that the tonsure, as used by the Romanists, did not exist at the time of the introduction of this epithet. The custom was to cut the hair to a moderate degree simply for the sake of decent appearance, and especially to avoid conformity to the existing fashion of wearing long hair. St. Jerome says that none but the priests of Isis and Serapis have shaven crowns. The term *coronati* might be given to the clergy out of respect to their office and character, which were held in great honor. It was customary, in addressing bishops, to use some title of respect, such as *per coronam*, and *per coronam vestram*; and the allusion may be to the *corona*, or mitre, which the bishops wore as a part of their priestly dress; or it may be considered as a metaphorical expression, denoting the honor and dignity of the episcopal order" (Farrar, s. v.).—Bingham, *Orig. Eccl.* vi, iv, 17.

(II.) A title traditionally given to four martyrs—Severus, Severianus, Carphorus, and Victorinus—so named because, it is said, they were killed, in 304, by having *crowns* with sharp nails pressed into their heads. A church erected at Rome in their honor is mentioned by pope Gregory I, and still exists. They are commemorated in the Church of Rome on Nov. 8; the Acts of their martyrdom are spurious. See Wetzer u. Welte, *Kirch.-Lex.* ii, 880.

Corporal (*corporale*, sc. *velum*), the linen cloth which is spread over the symbols after communion. It is so called from being originally intended to represent the sheet in which our Lord's body (*corpus*) was wrapped after death. It is of linen with reference to Luke xxiii, 58. Originally it was so large as to cover the host and the wine, hence the name *palla* (*εὐλητόν*); but in the Middle Ages it received its present smaller size. It was retained by the English Reformers.—Herzog, *Real-Encyk.* iii, 158; Wetzer u. Welte, *Kirch.-Lex.* ii, 881.

CORPORAL INFLICTIONS. 1. In all ages, among the Israelites, *beating* was the commonest form of bodily chastisement known in civil offences (Deut. xxv, 2), e. g. in cases of a team of different sorts of beasts (i. e. the driver as well as the person sitting in the wagon), forty blows were inflicted (Mishna, *Chil.* viii, 8). See **BASTINADO**. The delinquent probably

received the strokes from a stick (comp. Prov. x, 18; a rod of "scorpions" is named in 1 Kings xii, 11, 14; 2 Chron. xi, 14, either a thorny, knotty staff [comp. *scorpio* in Isidor. *Orig.* v, 27, 18; thongs of oxhide are mentioned in Lev. xix, 20, as *רִמְמָה*; but see Gesenius, *Thes.* p. 284], or one set with pointed projections [Gesen. *Thes.* p. 1062], probably an unusual severity), in a prostrate attitude (not on the soles of the feet, as in the modern East, Arvieux, iii, 198), and in the presence of the judge (comp. Wilkinson, ii, 41; Rosellini, ii, 3, p. 274); but not over forty stripes (Deut. xxv, 2). The later Jewish infliction (see the Mishna, *Maccoth*) was executed by means of a twisted leather thong (whip), and the blows, not exceeding thirty-nine in number (*Maccoth*, iii, 10; compare Josephus, *Ant.* iv, 8, 21; 2 Cor. xi, 24), were dealt by the officer of justice (*חֹטֵא*) upon the culprit, who stood bent forward (*Maccoth*, iii, 12). The cases in which this punishment was applied were sometimes such as were deemed a capital offence by the Mosaic law (*Maccoth*, iii, esp. 15). That scourging was also in vogue in the synagogue appears from the New Test. (Matt. x, 17; xxiii, 34), where there seems to be an allusion to the threefold sentence that prevailed in that ecclesiastical court (Lightfoot, *Hor. Hebr.* p. 382); yet the Talmudists are not agreed whether forty blows could be inflicted in any case (*Sanhedr.* i, 2). See **SYNAGOGUE**. Scourging is mentioned (Acts v, 40) as a penalty in the power of the Sanhedrim; an increase of severity being employed in instances of repeated offence (*Sanhedr.* ix, 5; see Wendt, *De debitis reciduis*, Erlangen, 1824). See **COUNCIL**. Under the Syrian rule chastisement with the lash occurs as a form of torture (2 Macc. vii, 1; comp. Juvenal, xiii, 195; Cicero, *Cluent.* 68). See **FLAGELLATION**. The Roman scourging (*φραγελλοῦν, μαστιγοῦν*) with thongs was inflicted on Jesus before crucifixion (Matt. xxix, 26; John xix, 1), and on the apostles as a civil penalty (Acts xvi, 22, 27); but Roman citizens could only be beaten with rods (*virgis caedis*, Cicero, *Verr.* v, 66; comp. Acts xxii, 25). That this punishment might be carried to a fatal extent is evident (Cicero, *Verr.* v, 54; Pluto, *Opp.* ii, 528); it was generally applied with fearful severity by the Roman governors (Josephus, *War.* vi, 5, 8). See **SCOURGE**.

2. Physical injuries committed upon a free Israelite were to be avenged by retaliation upon the author (Exod. xxi, 28 sq.; Lev. xxiv, 19 sq.). See **DAMAGES**.

3. Of foreign corporal inflictions we may here enumerate the following: (1.) Partial dichotomy, or the cutting off of the nose and ears, also of the hands or one of them, which species of punishment was often practised among the later Jews, but chiefly in tumultuous times (Josephus, *Life*, 80, 84, 85). A similar maiming of the toes occurs among the Cansanithis incidents (Judg. i, 7). In Egypt such mutilations were sanctioned by law; and it was usually the member through which the offence had been committed that was cut off (Diod. Sic. i, 78); the adulteress must expiate her crime by the loss of the nose (so as to spoil her countenance), a penalty to which Ezek. xxiii, 25, is usually referred, a passage, however, that rather relates to Babylonian usage. (On the Persian custom, see Xenophon, *Anab.* i, 9, 18; Curtius, v, 5, 6; vii, 5, 40. An allusion to dichotomy occurs in the Behistun inscription; see Rawlinson's explanation, p. 9, 17.) On captives in war such disfigurements were and still are (Russeger, *Reise*, ii, 138) most recklessly perpetrated. (2.) Blinding (*רִמְמָה*) was a Chaldean (Jer. lii, 11; 2 Kings xxv, 7) and ancient Persian punishment (Herodotus, vii, 18). See **ERE**. It still prevails in Persia with regard to princes, who are sometimes thus deprived of all prospect to the succession; vision is not entirely obliterated by the process employed in such cases (Chardin, v, 248; Rosenmüller, *Morgenl.* iii,



Modern Egyptian Bastinado.

250 sq.; a different treatment is mentioned by Procopius, in *Phot. Cod.* 63, p. 82). The extinction of the eyes (עִי־אֵי־נִכְרָה), a practice frequent in Persia (*Ctesias, Pers.* 5), is named in *Judg.* xvi, 21, as a piece of Philistine barbarity; in 1 Sam. xi, 12, the same atrocity appears to have obtained with the Ammonites.—Winer, ii, 14. See PUNISHMENT.

Corporation, ECCLESIASTICAL (CORPUS ECCLESIASTICUM), an association for ecclesiastical purposes sanctioned by the state and recognised as a civil person (*corpus*). Among the usual rights of corporations are those to acquire property, to contract obligations and debts, to sue and be sued. Their legal status may be regulated either by general laws applying to all corporations of a certain class, or by special laws given for the benefit of one corporation only.—Wetzer u. Welte, *Kirchen-Lex.* ii, 881.

Corpse (גֵּרִיחַ, *geriyah'*, Neh. iii, 8, a *carcase*, as rendered in *Judg.* xiv, 8, 9, elsewhere "body;" גֵּרִיחַ, *pe'ger*, 2 Kings xix, 85; Isa. xxxvii, 6, a "*carcase*" or "body" [usually dead], as elsewhere rendered; *κρῶμα*, Mark vi, 29, a dead "body" or "*carcase*," as elsewhere rendered), the dead body of a human being. See CARCASS.

Corpus Catholicorum (*body of the Catholics*), formerly the collective name of the Roman Catholic states of Germany, as contradistinguished from the *Corpus Evangelicorum* (q. v.) of the Protestant states. It was not until after the treaty of Westphalia, where-in the pope had, by settling, so to say, the rights of both parties, officially recognised their existence, that the expression *Corpus Catholicorum* came into general use. Yet the confederation had existed before the *Corpus Evangelicorum*, as is proved by the harmonious action of the Roman Catholic states at the Diet of Nuremberg and the decisions of the Confederation of Ratisbon (1524). The elector of Mayence was the President of the *Corpus Catholicorum*, which generally held its proceedings in a convent of that city in which the diet happened to meet. The abolition of the German Empire in 1806 led to the extinction of the *Corpus Evangelicorum*, and, as a consequence, of that of the *Corpus Catholicorum*.—See Faber, *Europäische Staats-Cantley*, who, in vol. liii, p. 287, gives a complete list of the states constituting the *Corpus Catholicorum*; Moser, *Teutsches Staats-Recht*, etc.; and CORPUS EVANGELICORUM.

Corpus Christi (*body of Christ*), a festival instituted in the Roman Church in honor of the consecrated host and of transubstantiation. It owes its origin to a nun of Liège named Juliana. In 1200, while looking at the full moon, she said she saw a gap in its orb, and, by a revelation from heaven, learned that the moon represented the Christian Church, and the gap the want of a certain festival—that of the adoration of the body of Christ in the consecrated host—which she was to begin to celebrate, and to announce to the world. Further, in 1264, while a priest at Bolsena, who did not believe in transubstantiation, was going through the ceremony of benediction, it is said drops of blood fell on his surplice, and, when he endeavored to conceal them in the folds of his garment, they formed bloody images of the host! A bloody surplice is still said to be shown at Civita Vecchia. Urban IV published in the same year a bull, in which he appointed the Thursday of the week after Pentecost for the celebration of the Feast of Corpus Christi throughout Christendom, and promised absolution for a period of from forty to one hundred days to the penitent who took part in it. It was afterwards neglected, but was re-established by Clement V, and since that time the festival has been observed as one of the most important in the Romish Church. Splendid processions form a part of it. The children belonging to the choir with flags, and the priests with lighted tapers, move through

the streets in front of the priest who carries the host in a precious box, where it can be seen under a canopy held by four laymen of rank. A crowd of common people closes the procession.—Buck, *Dict. s. v.*; Elliott, *Delineation of Romanism*, bk. ii, ch. vii; Siegel, *Handb. d. Christl. Alterthümer*, and references there; and for the Romish view, Butler, *Fasts and Fests*, treatise xi.

Corpus Doctrinae, the name given to certain collections of writings which were intended to have authority in the Protestant churches of Germany. The most important of these collections are the following: 1. *Corpus Philippicum*, also called *Saxonicum* or *Misnicum* (published in 1560, fol. and often). It contained the three general symbols (the Apostolic, Nicæan, and Athanasian), the Confession of Augsburg (the *Inseriata*) and the Apology, and Melancthon's *Loci Communes*, *Examen Ordinandorum*, and *resp. ad artic. Bavaric.* It was considered as crypto-Calvinistic, and violently denounced by the rigorous Lutherans. The Elector of Saxony, in 1569, threatened with deposition all who refused to teach in accordance with it, but subsequently this decree was repealed, and a number of defenders of the work were tried and imprisoned. 2. The *Corpus Doctrinae Pomeranicum* had the same contents as the preceding one. 3. The *Corpus Doctrinae Prutenicum* (Prussian), also called *Repetitio doctrinae ecclesiasticae*, was published in 1567, and directed against the Osiandrian errors. A decree of the prince, in 1567, prescribed it as a rule of faith for all times to come, and declared that none who refused to accept it should receive office.

Corpus Evangelicorum (*body of the Evangelical*), formerly the collective name of the evangelical states of Germany. The first league was made between Saxony and Hesse in 1528. Other evangelical states followed, and at the Protestation of Spire in 1529, the *Corpus Evangelicorum* was organized. In the Nuremberg religious peace in 1532, it entered as such in relation with the *Corpus Catholicorum* (q. v.). The head-quarters of the latter were in the electorate of Mayence, while Saxony stood at the head of the evangelical states. At the close of the sixteenth century, Frederic III, elector of the Palatinate, having become Protestant, became head of the *Corpus Evangelicorum*; but after he had lost all his states in the Thirty Years' War, Sweden took the lead, which was, however, restored to Saxony by the Diet of 1658. After the electoral house of Saxony had become Romanist, the lead of the *Corpus Evangelicorum* was claimed by several other Protestant states; yet it remained finally with Saxony, it being, however, stipulated that the envoy of Saxony should receive his instructions, not from the elector, but from the college of the privy council at Dresden. The *Corpus Evangelicorum* ended with the dissolution of the German empire in 1806.—Hernzog, *Real-Encyklop.* iii, 156; Bülow, *Ueber gesch. u. Verf. des Corp. Evang.* (1795).

Corpus Juris Canonici, a collection of the sources of the Church law of the Roman Catholic Church, consisting of old canons, resolutions of councils, decrees of popes, and writings of Church fathers. The collection gradually arose from the desire to have for the decision of ecclesiastical cases a law-book of equally general authority as the *Corpus Juris Civilis* possessed in the province of civil legislation. Its component parts were originally compiled in strict imitation of the *Corpus Juris Civilis*.

I. Component Parts.—Generally recognised as parts of the *Corpus Juris Canonici*, and constituting what is called the *Corpus Juris Clausum*, are the *Decretum Gratiani* (1151), the decretals of Gregory IX (1234), the *Liber Sextus* of Boniface VIII (1298), and the *Clementines* (1818). Disputed is the authority of the two collections of *Extravagantes* of pope John XXII (1340) and of the *Extravagantes Communes* (1484).

generally rejected are now the 47 *Canones penitentiales* taken from the *Summa de Canibus Conscientiis* of cardinal di Asti ("Summa Astesana"), and the *Canones apostolorum*, both of which were, in the earlier editions of the *Corpus Juris Canonici*, given as an appendix to be *Decretum Gratiani*. The same is the case with the *Institutiones Juris Canonici*, and with the *Liber septimus* of Peter Mathews of Lyons.

II. *The Formation of the Collection.*—The name of *Corpus Juris Canonici* was early given to the *Decretum Gratiani* in distinction from the *Corpus Juris Civile*. But from the fifteenth century it became customary to apply the name to the collection of the law-books above enumerated. Printed editions of the collection with the title of *Corpus Juris Canonici* do not occur before the sixteenth century. Among those who are most noted for spending critical labor on the editing of the *Corpus Juris Canonici* are Anthony Demochares (ed. Paris, 1550-52, without glosses, and Paris, 1561, 8 vols. fol., with glosses), who completed the indefinite references in the headings of the *Decretum* by more accurate statements; Charles Dumoulin, or (as he called himself with a Latin name) Car. Molinæus (Lyons, 1554, 4to, and 1559, fol.), who designated the several passages of the *Decretum* (with the exception of the *Paleæ*) with notes; Le Conte, or Contius (Antw. 1569-1571, 4 vols. 8vo), who from older unprinted collections added, in particular in the decretals of Gregory IX, the *partes decies* which had been suppressed by Raymond of Pennafort; the *Correctores Romani* (q. v.), whose work (Rome, 1582, 5 vols. fol.) is a turning-point of the history of the *Corpus*; the brothers François and Pierre Pithou, whose valuable notes were used by Le Pelletier in his edition (Paris, 1687; again Lpz. 1690 and 1705; and Turin, 1746, 2 vols. fol.); Justus Henning Böhmer (Halle, 1747, 2 vols. 4to); Aem. Lud. Richter (Leipzig, 1838-1839, 1 vol. in 2 parts, 4to), who left out all the appendixes having no legal authority. For fuller information on the component parts of the *Corpus Juris Canonici*, and for their legal authority, see article CANON LAW (p. 87 sq.). See also Wetzlar u. Walte, *Kirchen-Lex.* ii, 886.

Corpus Juris Civilis (*body of Civil Law*). See JUSTINIAN.

Correctores Romani, a congregation of cardinals and Roman theologians of thirty-five members, appointed by pope Pius V to revise the *decretum Gratiani* (see *Corpus juris Canonici*). Among the five cardinals who belonged to the college was Hugo Boncompagnus (subsequently pope Gregory XIII). The work was completed during the pontificate of Gregory XIII, who ordered the compilers to index all that had been collected, with regard to the decretum, by the congregation and by others, to invite all Catholic academies to co-operate in the work of revision, and to have all the former editions of the *decretum* compared. Gregory sanctioned the work July 1, 1580.—Wetzlar u. Walte, *Kirchen-Lex.* ii, 894.

Corrodi, HEINRICH, a prominent writer of the Rationalistic school, was born at Zurich, July 31, 1752. He was admitted to the ministry in 1775; continued his theological studies in Leipzig and Halle, where especially Semler (q. v.) had great influence upon him, and was in 1786 appointed professor of ethics and natural law at the gymnasium of Zurich. This position he retained until his death, Sept. 14, 1798. His principal works are *Geschichte des Chiliasmus* (4 vols. Frankf. and Leips. 1781-83, full, but very diffuse, and abounding in worthless matter); *Beleuchtung der Gesch. des jüd. u. christl. Bibeicanons* (Halle, 1792, 2 vols.); *Philos. Aufsätze u. Gespräche* (Winterthur, 1786, 2 vols.); *Versuch über Gott, die Welt u. d. menschl. Seele* (Berlin, 1788), and the periodical *Beiträge zur Beförderung des vernünftigen Denkens in d. Religion* (18 numbers, Winterthur, 1781-1794; two numbers appeared after his death under the name of *Neue Beiträge*).—

Pierer, *Universal-Lexikon*, iv, 464; Herzog, *Real-Encyclopædie*, iii, 157.

Corruption (prop. some form of *חֲרָפָה*, *achachah*, *διαφθορά*). This term is used in Scripture to signify the putrefaction of dead bodies (Psalm xvi, 10), the blemishes which rendered an animal unfit for sacrifice (Lev. xxii, 25), sinful inclinations, habits, and practices, which defile and ruin men (Rom. viii, 21; 2 Peter ii, 12, 19), everlasting ruin (Galat. vi, 8), men in their mortal and imperfect state (1 Cor. xv, 42, 50).

MOUNT OF CORRUPTION (מֶתְחַרְפֵּת הַר, Sept. *ῥος τοῦ Μοσχῆ* v. r. *Μοσχῆ*, Vulg. *mons offensivus*), a hill in the neighborhood of Jerusalem, where Solomon had established the worship of the Ammonitish deity Milcom, which Josiah overthrew (2 Kings xxiii, 18). Tradition assigns the locality of the "Mount of Offence" to the eminence immediately south of the Mt. of Olives (see Barclay, *City of the Great King*, p. 64 sq.; Stanley, *Palest.* p. 185, note). See JERUSALEM.

Corrupticiōles, a sect of Monophysites, who taught that the body of Christ before the resurrection was corruptible. See MONOPHYSITES; SEVERIANS.

Cortex, DONOSO. See DONOSO CORTEZ.

Cortholt, CHRISTIAN, an eminent Lutheran Church historian, was born at Burg, in the island of Femern, Denmark, Jan. 15th, 1632. His studies, commenced at Schleswig, were continued in the universities of Rostock, Jena, Leipsic, and Wittenberg. In 1662 he became professor of Greek at Rostock, where he was made D.D. He was afterwards called to the professorship of theology at Kiel by the duke of Holstein-Gottorp, and in 1666 became vice-chancellor of that university. He died March 31 (or April 1st), 1694. His principal works are, *De persecutionibus ecclesie primitivæ sub imperatoribus ethnicis* (Jen. 1660, 4to; Kiln. 1689); *Paganus obstructor s. de calumniis gentilitium* (lib. iii, Kil. 1698; Lubec, 1708, 4to); *Disquisitiones Anti-Baroniana* (Kil. 1700, 1708, etc.); *Hist. eccl. N. T.* (Lips. 1697), etc. See Pipping, *Memoria Theologorum nostra ætate clarissimorum* (Lips. 1705, p. 571 sq.); Bayle, *Dictionary*, s. v.; Iselin, *Hist. Wörterbuch*; Schröckh (i, p. 178); Herzog, *Real-Encyclop.* viii, 82.

Corvey, ABBEY of, a celebrated monastery near Höxter, in Germany. The Benedictines of Corbie (q. v.), in Picardy (France), sent out in 816 a colony to found a convent in the forests of Sollingen, but the monks removed in 822 to a more healthy region, where they established *Corbeja nova*, or Corvey. Louis the Pious endowed them with numerous possessions and privileges, and his example was followed by many other princes and laymen, so that Corvey soon became the richest of all the German convents. The abbot obtained a voice in the diets, and was amenable only to the papal authority. The school of the convent was highly flourishing during the 9th and 10th centuries. Among the many celebrated men who proceeded from Corvey was Ansgar (q. v.), the apostle of the Scandinavians, the learned Paschasius Radbertus (q. v.), St. Adalbert, archbishop of Magdeburg, and many archbishops of Bremen and Hamburg. At the period of its greatest prosperity the convent had twenty-four theological professors, and its library was celebrated for its large number of classical manuscripts. Thus the first five books of Tacitus, which were commonly regarded as lost, were found in Corvey. Unfortunately, this exquisite library was destroyed in the Thirty Years' War. In 1794 Corvey was erected into a bishopric, but secularized in 1804, and joined in 1807 to Westphalia, and in 1815 to Prussia. See Wigan, *Gesch. d. Abtei Corvey* (Höxter, 1819); and *Korveische Geschichtsquellen* (Lps. 1841); Schumann, *Ueber das Chronicon Corveense* (Gött. 1889); Wetzlar u. Walte, *Kirchen-Lex.* ii, 898.

Corvinus, ANTHONY (properly RÄBENEK), one of the German Reformers, was born at Warburg in 1501.

He became a monk, and as such resided for a time in the convents of Riddagshausen and Loccum, but having embraced the doctrine of Luther, was expelled in 1523. He then went to Wittenberg, and thence to Marburg in 1526, and laid the foundation of the university there. He was present at the two synods of Pattensen, 1544, and Münden, 1545, and made himself very useful to the cause by his preachings, writings, and travels; but the duke Erich II having returned to the Roman Church, Corvinus was taken and held a prisoner at Kalenberg in 1549. He died in Hanover in 1553. His principal work is the *Postilla in evangelia et epistolae*. See Baring, *Leben Corvin's* (Hann. 1749); Uhlhorn, *Ein Sendbrief v. Antonius Corvinus m. einer geographischen Einleitung* (Göttingen, 1853); Herzog, *Real-Encyclop.* iii, 166.

Cos (1 Macc. xv, 23). See **COOS**.

Cos'mam (Κωσάμ, prob. for Heb. כּוּסָם, a *diviner*), son of Elmodam, and father of Addi, ancestors of Christ, and descendants of David in the private line, before Salathiel (Luke iii, 28), B.C. ante 588. He is not mentioned in the Old Testament. See **GENERALOGY** (OF CHRIST).

Cosin, JOHN, a learned prelate of the Church of England, was born at Norwich Nov. 30, 1594. In 1624 he became a prebendary of Durham, in 1628 rector of Brancepath, in 1634 master of Peter-house, and in 1640 dean of Peterborough. The Puritans deprived him of his preferments during the Commonwealth, and even went the length of impeaching him on a charge of being inclined to popery. (For the charges, see Hook, *Eccles. Biography*, iv, 182.) He was acquitted of all these charges, and then retired to France, where he remained until the restoration of Charles II, who raised him to the see of Durham, Dec. 2, 1660, which office he filled with eminent charity and zeal. He died in 1672. Among his writings are, *A History of Transubstantiation*, and *A Scholastical History of the Canon of the Holy Scriptures*, published, with his *Life*, 1673. His whole works are collected in the *Library of Anglo-Catholic Theology* (Oxford, 1848-53, 5 vols. 8vo).

Cosmas, Sr., and his brother **ST. DAMIANUS**, of Arabia, lived in the 3d century, and practiced medicine at *Ægea*, in Cilicia. The governor Lysias commanded that they, with their three other brothers, should sacrifice to the heathen deities, and as they refused so to do, commanded their heads to be cut off in 893. They are honored as martyrs, and as special patrons of physicians and druggists. They are commemorated in the Roman Church on the 27th Sept.—Wetzer u. Welte, *Kirchen-Lex.* ii, 902; *Acta Sanctorum* (Sept., tom. xii).

Cosmas and Damianus, ORDER OF, an order of knights spiritual, founded in the 11th century, who adopted the rule of St. Benedict. They devoted themselves especially to the care of the pilgrims going to Palestine. They were destroyed by the Turks soon after their organization.

Cosmas Indicopleustes (i. e. *traversing India*), an Egyptian monk, living probably about the middle of the 6th century. He visited as a merchant Egypt, India, and other Eastern countries, and wrote a work, entitled *Χριστιανική τοπογραφία*, in which he undertook to substitute for the pagan geography of the ancients a new Christian system of geography, based upon all kinds of delusions. His work is contained in the second volume of Montfaucon's *Collectio nova patrum Gr.* (Paris, 1707).

Cosmogony (from *κόσμος*, the *world*, and *γένος*, *generation*), strictly the science of the origin of the earth. The term is applied also to the various theories of the formation of the material universe. If we except the cosmogony of the Indians (which is for the most part extravagant and even monstrous, although the "Institutes of Menu" speak of a simpler system;

see Sir William Hamilton's *Asiatic Researches*, vol. v.) the earliest profane cosmogony extant is that of Hesiod (in the first part of his *Theogony*, ver. 116-452), which is delivered in verse, and which served as the ground-work for the various physical speculations of most of the Greek philosophers. It differs widely from the notion of Homer (*Iliad*, xiv, 200), which is also poetic, and represented the more popular view of the Greeks on this subject. The first prose cosmogonies among heathen writers were those of the early Ionic philosophers, of whom Thales, Anaximenes, Anaximander, and Anaxagoras were the most celebrated. The theories of the ancients on this subject may be reduced to three; for those of moderns, see **CREATION**; for the view of Ovid (in his *Metamorphoses*), see **CHAOS**.

"1. That which represents the world as eternal in form as well as substance. Ocellus Lucanus is one of the most ancient philosophers who supposed the world to have existed from eternity. Aristotle appears to have embraced the same doctrine. His theory is, that not only the heaven and earth, but also animate and inanimate beings in general, were without beginning. His opinion rested on the belief that the universe was necessarily the eternal effect of a cause equally eternal, such as the Divine Spirit, which, being at once power and action, could not remain idle. Yet he admitted that a spiritual substance was the cause of the universe, of its motion and its form. He says positively, in his *Metaphysics*, that God is an intelligent spirit (*νοῦς*), incorporeal, immovable, indivisible, the mover of all things. According to him, the universe is less a creation than an emanation of the Deity. Plato says the universe is an eternal image of the immutable Idea or Type, united, from eternity, with changeable matter. The followers of this philosopher both developed and distorted this idea. Ammonius, a disciple of Proclus, taught, in the 6th century, at Alexandria, the co-eternity of God and the universe. Several ancient philosophers (as also moderns) have gone further, and taught that the universe is one with Deity. Of this opinion were Xenophanes, Parmenides, Melisus, Zeno of Elea, and the Megaric sect.

"2. The theory which considers the *matter* of the universe eternal, but not its *form*, was the prevailing one among the ancients, who, starting from the principle that out of nothing nothing could be made, could not admit the creation of matter, yet did not believe that the world had always been in its present state. The prior state of the world, subject to a constant succession of uncertain movements, which chance afterwards made regular, they called *chaos*. The Phœnicians, Babylonians, and also the Egyptians, seem to have adhered to this theory" (Hend. Buck, a. v.). "The Chaldean cosmogony, according to Berossus, when divested of allegory, seems to resolve itself into this: that darkness and water existed from eternity; that Belus divided the humid mass, and gave birth to creation; that the human mind is an emanation from the divine nature. The cosmogony of the ancient Persians is very clumsy. They introduce two eternal principles, the one good, called *Oromasdes*, the other evil, called *Arimanius*; and they make these two principles contend with each other in the creation and government of the world. Each has his province, which he strives to enlarge, and *Mithras* is the mediator to moderate their contentions. This is the most inartificial plan that has been devised to account for the existence of evil, and has the least pretensions to a philosophical basis. The Egyptian cosmogony, according to the account given of it by Plutarch, seems to bear a strong resemblance to the Phœnician, as detailed by Sanchoniatho. According to the Egyptian account, there was an eternal chaos, and an eternal spirit united with it, whose agency at last arranged the discordant materials, and produced the visible system of the universe. The cosmogony of the Northern nations, as may be collected from the Edda, supposes an eternal

principle prior to the formation of the world. The Orphic Fragments state everything to have existed in God, and to proceed from him" (Watson, s. v. Creation). "The ancient poets, who have handed down to us the old mythological traditions, represent the universe as springing from chaos without the assistance of the Deity. Hesiod feigns that Chaos was the parent of Erebus and Night, from whose union sprang the Air (*Aiθρη*) and the Day. He further relates how the sky and the stars were separated from the earth, etc. The system of atoms is much more famous. Leucippus and Democritus of Abdera were its inventors. The atoms, or indivisible particles, said they, existed from eternity, moving at hazard, and producing, by their constant meeting, a variety of substances. After having given rise to an immense variety of combinations, they produced the present organization of bodies. This system of cosmogony was that of Epicurus, as described by Lucretius. Democritus attributed to atoms form and size; Epicurus added weight. Many other systems have existed, which must be classed under this division. We only mention that of the Stoics, who admitted two principles, God and matter—in the abstract, both corporeal, for they did not admit spiritual beings. The first was active, the second passive.

"8. The third theory of cosmogony attributes the origin of the world to a great spiritual cause or Creator. This is the doctrine of the sacred Scriptures, in which it is taught with the greatest simplicity and beauty. From its being more or less held by the Etruscans, Magi, Druids, and Brahmans, it would seem to have found its way as a tradition from the regions in which it was possessed as a divine revelation. Anaxagoras was the first who taught it among the Greeks, and it was to some extent adopted by the Romans, notwithstanding the efforts of Lucretius to establish the doctrine of Epicurus" (Buck). Dr. Good, however, shows that this view was far from general among even the most cultivated nations of antiquity, or, indeed, unquestioned by early Christian writers (*Book of Nature*, p. 27). See COSMOLOGY.

COSMOGONY, MOSAIC, or the Biblical account of the origin of the world, especially as contained in the first chapter of the book of Genesis. The following is a close translation of the first (Elohistic) or general account of the creation as given by Moses (Gen. i, 1-ii, 3). See GENESIS.

At first God created the heavens and the earth; but the earth was waste and bare (a scene of ruin), and darkness [was] upon [the] face of the abyss, while the Spirit of God [was] brooding upon [the] face of the waters. Then God said, "Let [there] be light!" and [there] was light; and God saw the light, that [it was] good: so God divided between the light and the darkness; and God called the light DAY, but the darkness he called NIGHT. Thus [there] was evening, and [there] was morning—[the] first day.

Then God said, "Let [there] be a firmament in the midst of the waters, and let [it] be a divider between [the] waters [below it] as to [the] waters [above it]:" so God made the firmament, and divided between the waters that [are] underneath as to the firmament, and the waters that [are] overhead as to the firmament; for it was according; and God called the firmament HEAVENS. Thus [there] was evening, and [there] was morning—[the] second day.

Then God said, "Let the waters underneath the heavens be gathered toward one place, and let the dry [land] appear;" and it was accordingly; and God called the dry [land] EARTH, but the gathering of the waters he called SEAS; so God saw that [it was] good. Then God said, "Let the earth sprout the sprout [grasses], the plant [annuals] seeding seed, the fruit-tree [of woody stem] bearing fruit after its kind—in which [is] its seed upon the earth;" and it was accordingly; for the earth sprouted the sprout, the plant seeding seed after its kind, and the tree bearing fruit—in which [is] its seed after its kind: so God saw that [it was] good. Thus [there] was evening, and [there] was morning—[the] third day.

Then God said, "Let [there] be lights in the firmament of the heavens, to divide between the day and the night; and let them be for signs, and for seasons, and for days, and years; even let them be for lights in the firmament of the heavens, to give light upon the earth;" and it was accordingly; so God made the two great lights—the greater light [sun] to rule the day, and the smaller light [moon] to rule the night—also the stars: and God appointed them in the firmament

of the heavens, to give light upon the earth, and to rule over the day and over the night, and to divide between the light and the darkness; so God saw that [it was] good. Thus [there] was evening, and [there] was morning—[the] fourth day.

Then God said, "Let the waters swarm [with] the swarm of the living creature, and let the bird fly upon the earth—upon the face of the firmament of the heavens:" so God created great [sea-] monsters, and every living creature that creeps, [with] which the waters swarmed, after its kind; also every winged bird after its kind; so God saw that [it was] good: and God blessed them, saying, "Be fruitful, and multiply, and fill the waters in the seas; and let the bird multiply on the earth." Thus [there] was evening, and [there] was morning—[the] fifth day.

Then God said, "Let the earth bring forth the living creature after its kind, beast [large quadrupeds], and reptile [short-legged animals], and [every other] living [thing] of the earth, after its kind;" and it was accordingly; for God made the living [thing] of the earth after its kind, and the beast after its kind, and every reptile of the ground after its kind: so God saw that [it was] good. Then God said, "Let us make MAN in our image—according to our likeness [the exact reflection of the divine [mental] lineaments]; and let him have dominion over the fish of the sea, and over the bird of the heavens, and over the beast, and over all the earth, and over every reptile that creeps upon the earth;" so God created mankind in his [own] image, in the image of God he created him, [yet] male and female he created them: and God blessed them, when God said to them, "Be fruitful, and multiply, and fill the earth, and subdue it; and have dominion over the fish of the sea, and over the bird of the heavens, and over every living [thing] that creeps upon the earth:" for God said, "Lo! I have given to you every plant seeding seed, which [is] upon [the] face of all the earth, and every tree in which [is] the fruit of a tree seeding seed; to you it shall be for food, also to every living [thing] of the earth, and to every bird of the heavens, and to every [thing] creeping upon the earth in which [exists] a living creature, [even] every green plant for food." And it was accordingly; so God saw every [thing] that he had made, and lo! [it was] very good: thus [there] was evening, and [there] was morning—the sixth day.

Now were finished the heavens, and the earth, and all their army [of stars]; for God finished on the seventh day his work which he had made, and [therefore] ceased on the seventh day from all his work which he had made. Then God blessed the seventh day, and sanctified it; because on it he ceased [shabath, rested] from all his work which God created in making.

The statements contained in this passage are thought by a certain class of semi-infidel philosophers to be in conflict with the conclusions of modern science, especially astronomy and geology. We are sure, however, that the works and word of God can never be otherwise than in harmony, and if any conflict appears, it must be in consequence of the unskillfulness or erroneous system of the expounders, either of the book of nature or of revelation. The difficulty consists in the alleged contradiction between the *philological* "interpretation" of the sacred record and the *scientific* or *historical* exposition of the facts. In this, as in all similar instances of apparent discrepancy, it is no disparagement of philology that it is obliged to modify previous interpretations on account of new light from collateral branches of knowledge; the same course has always been pursued, e. g. in the verification of prophecy, where history has necessarily come in as a supplementary aid in fixing a definite meaning to what before was dark and general. This, it is true, would not be allowable if the scriptural statements in question were explicit and in detail, or if they were couched in the precise terms of modern science; but it is a legitimate method of interpretation in the case of such brief and popular phraseology as we often find in the Bible on subjects adverted to for collateral purposes. It is therefore only necessary to show that the essential meaning of the text, when explained according to the analogies of the *usus loquentis* of an unscientific people, should not conflict, as to the real facts involved, with the conclusions of late scientific investigators. See INTERPRETATION. There are three principal modes in which this adjustment has been attempted with regard to Moses's account of the creation. (1.) Some regard chapter i of Genesis as a general statement of the original formation of all created things, including that of man as a race, in the several varieties scattered over

the earth's surface; and chap. ii as a detailed account of a *subsequent* creation of the Adamic or Hebrew lineage in particular. It cannot be denied that the difference in language (especially the distinctive use of the titles "Jehovah" and "Elohim"), and the resumptive form of the latter chapter, somewhat favor this view; but, on the other hand, it is emphatically forbidden by the doctrine of the unity of the human race (and "man" is in both cases alike called אָדָם); and after all it leaves essentially untouched the principal question of the reconciliation of the Mosaic order and date of creation with those suggested by science. See ADAM.

(2.) Others regard the several "days" of the scriptural narrative as periods of indefinite extent, and so find time enough for the astronomical and geological cycles required. See EARTH. But this interpretation is met by two objections: (a) Although the term יוֹם, *day*, is sometimes used in a vague sense for a longer or shorter period of time, such a signification here is forbidden by the distinct recurrence of the divisions "night and morning" stated in connection with each *ἡμέραν* or space of twenty-four hours; and the Sabbath comes in as a similar space of time at the close of the week, in a sense probably strict and literal, since it is made the basis of the hebdomadal cycle religiously observed ever since. See DAY. (b) The exact number of *six* such periods cannot be made out satisfactorily from the records of science: e. g. the astronomical system requires the sun at the outset of the demiurgic period, whereas Moses does not introduce it till the fourth day, although light had existed from the first; and the lowest geological strata exhibit animal life, whereas Moses speaks of vegetables as created first. See GEOLOGY.

(3.) Perhaps the best solution of the difficulty is that which inserts the entire geological period between the original creation of matter in ver. 1 of Gen. i, and the literal account of the last, or, properly, Mosaic creation of the present races of living things detailed in verses 11-31; the intermediate verses (2-10) describing *phenomenally*, i. e. just as the facts would have appeared to a spectator, the gradual restoration of mundane order, after the grand cataclysm that closed the geological period, and swept off the terrestrial tribes then existing; and chap. ii, resuming the account for the purpose of further detail, especially with reference to the formation of Eve. See CREATION.

For a more general exposition of the Hebrew views on this subject, see COSMOLOGY.

Cosmological Argument. See GOD; NATURAL THEOLOGY.

Cosmology, BIBLICAL. The views of the Hebrews on this subject are, in a scientific point of view, confessedly imperfect and obscure. This arises partly from the ulterior objects which led them to the study of natural science, and still more from the poetical coloring with which they expressed their opinions. The books of Genesis, Job, and Psalms supply the most numerous notices: of these, the two latter are strictly poetical works, and their language must be measured by the laws of poetical expression; in the first alone have we any thing approaching to a historical and systematic statement, and even this is but a sketch—an outline—which ought to be regarded at the same distance, from the same point of view, and through the same religious medium as its author regarded it. The act of creation itself, as recorded in the first chapter of Genesis, is a subject beyond and above the experience of man; human language, derived, as it originally was, from the sensible and material world, fails to find an adequate term to describe the act; for our word "create" and the Hebrew *bara*, though most appropriate to express the idea of an original creation, are yet applicable and must necessarily be applicable to other modes of creation; nor does the addition of such expressions

as "out of things that were not" (ἐξ οὐκ ὄντων, 2 Mac. vii, 28), or "not from things which appear" (μὴ ἐκ φανερομένων, Heb. xi, 8) contribute much to the force of the declaration. The absence of a term which shall describe exclusively an original creation is a necessary infirmity of language: as the event occurred but once, the corresponding term must, in order to be adequate, have been coined for the occasion and reserved for it alone, which would have been impossible. The same observation applies, though in a modified degree, to the description of the various processes subsequent to the existence of original matter. Moses viewed matter and all the forms of matter in their relations primarily to God, and secondarily to man—as manifesting the glory of God, and as designed for the use of man. In relation to the former, he describes creation with the special view of illustrating the divine attributes of power, goodness, wisdom, and accordingly he throws this narrative into a form which impresses the reader with the sense of these attributes. In relation to the latter, he selects his materials with the special view of illustrating the subordination of all the orders of material things to the necessities and comfort of man. With these objects in view, it ought not to be a matter of surprise if the simple narrative of creation omits much that scientific research has since supplied, and appears in a guise adapted to those objects. The subject itself is throughout one of a transcendental character; it should consequently be subjected to the same standard of interpretation as other passages of the Bible, descriptive of objects which are entirely beyond the experience of man, such as the day of judgment, the states of heaven and hell, and the representations of the divine majesty. The style of criticism applied to Gen. i by the opponents, and not unfrequently by the supporters of revelation, is such as would be subversive of many of the most noble and valuable portions of the Bible. See below.

1. In common with all ancient notions, the earth was regarded by the Hebrews not only as the central point of the universe, but as the universe itself, every other body—the heavens, sun, moon, and stars—being subsidiary to, and, as it were, the complement of the earth. The Hebrew language has no expression equivalent to our *universe*: the phrase "the heavens and the earth" (Gen. i, 1; xiv, 19; Exod. xxxi, 17) has been regarded as such; but it is clear that the heavens were looked upon as a necessary adjunct of the earth—the curtain of the tent in which man dwells (Isa. xl, 22), the sphere above which fitted the sphere below (comp. Job xxii, 14, and Isa. xl, 22)—designated solely for purposes of beneficence in the economy of the earth. This appears from the account of its creation and offices: the existence of the heaven was not prior to or contemporaneous with that of the earth, but subsequent to it; it was created on the second day (Gen. i, 6). The term under which it is described, *raquia* (רָקִיעַ), is significant of its *extension*, that it was *stretched out* as a curtain (Psa. civ, 2) over the surface of the earth. Moreover, it depended upon the earth; it had its "foundations" (2 Sam. xxii, 8) on the edges of the earth's circle, where it was supported by the mountains as by massive pillars (Job xxvi, 11). Its offices were (1) to support the waters which were above it (Gen. i, 7; Psa. cxlviii, 4), and thus to form a mighty reservoir of rain and snow, which were to pour forth through its windows (Gen. vii, 11; Isa. xxiv, 18) and doors (Psa. lxxviii, 23), as through opened sluiceways, for the fructification of the earth; (2) to serve as the *substratum* (στέρεμμα or "firmament") in which the celestial bodies were to be fixed. As with the heaven itself, so also with the heavenly bodies; they were regarded solely as the ministers of the earth. Their offices were (1) to give light; (2) to separate between day and night; (3) to be for *signs*, as in the case of eclipses or other extraordinary phenomena; for *see*

ness, as regulating seed-time and harvest, summer and winter, as well as religious festivals; and for *days and ears*, the length of the former being dependent on the sun, the latter being estimated by the motions both of sun and moon (Gen. i, 14-18); so that while it might truly be said that they held "dominion" over the earth (Job xxxviii, 83), that dominion was exercised solely for the convenience of the tenants of earth (Psa. civ, 19-23). So entirely, indeed, was the existence of heaven and the heavenly bodies designed for the earth, that with the earth they shall simultaneously perish (2 Pet. ii, 10): the curtain of the tent shall be rolled up, and the stars shall of necessity drop off (Isa. xxxiv, 4; Matt. xxiv, 29)—their sympathy with earth's destruction being the counterpart of their joyous song when its foundations were laid (Job xxxviii, 7).

2. The earth was regarded in a twofold aspect: in relation to God, as the manifestation of his infinite attributes; in relation to man, as the scene of his abode.

(1.) The Hebrew cosmology is based upon the leading principle that the universe exists, not independently of God, by any necessity or any inherent power, nor yet contemporaneously with God, as being coexistent with him, nor yet in opposition to God, as a hostile element, but dependently upon him; subsequently to him, and in subjection to him. The opening words of Genesis express in broad terms this leading principle; however difficult it may be, as we have already observed, to express this truth adequately in human language, yet there can be no doubt that the subordination of matter to God in every respect is implied in that passage, as well as in other passages, too numerous to quote, which comment upon it. The same great principle runs through the whole history of creation: matter owed all its forms and modifications to the will of God; in itself dull and inert, it received its first vivifying capacities from the influence of the Spirit of God brooding over the deep (Gen. i, 2); the progressive improvements in its condition were the direct and miraculous effects of God's will; no interposition of secondary causes is recognised—"He spake, and it was" (Psa. cxxxiii, 9); and the pointed terseness and sharpness with which the writer sums up the whole transaction in the three expressions "God said," "it was so," "God saw that it was good"—the first declaring the divine volition, the second the immediate result, the third the perfectness of the work—harmonizes aptly with the view which he intended to express. Thus the earth became in the eyes of the pious Hebrew the scene on which the divine perfections were displayed: the heavens (Psa. xix, 1), the earth (Psa. xxiv, 1; civ, 24), the sea (Job xxvi, 10; Psa. lxxxix, 9; Jer. v, 22), "mountains and hills, fruitful trees and all cedars, beasts and all cattle, creeping things and flying fowl" (Psa. cxlviii, 9, 10), all displayed one or other of the leading attributes of his character. So also with the ordinary operations of nature—the thunder was his voice (Job xxxvii, 5), the lightnings his arrows (Psa. lxxvii, 17), the wind and storm his messengers (Psa. cxlviii, 8), the earthquake, the eclipse, and the comet the signs of his presence (Joel ii, 10; Matt. xxiv, 29; Luke xxi, 25). See ANTHROPOMORPHISM.

(2.) The earth was regarded in relation to man, and accordingly each act of creation is a preparation of the earth for his abode—light, as the primary condition of all life; the heavens, for purposes already detailed; the dry land, for his home; "grass for the cattle and herb for the service of man" (Psa. civ, 14); the alternations of day and night, the one for his work and the other for his rest (Psa. civ, 26); fish, fowl, and flesh for his food; the beasts of burden, to lighten his toil. The work of each day of creation has its specific application to the requirements and the comforts of man, and is recorded with that special view.

3. Creation was regarded as a progressive work—a gradual development from the inferior to the superior orders of things. Thus it was with the earth's surface,

at first a chaotic mass, *waste and empty*, well described in the paronomastic terms *tohu va-bohu*, overspread with waters and enveloped in darkness (Gen. i, 2), and thence gradually brought into a state of order and beauty so conspicuous as to lead the Latins to describe it by the name *Mundus*. Thus also with the different portions of the universe, the earth before the light, the light before the firmament, the firmament before the dry land. Thus also with light itself, at first the elementary principle, separated from the darkness, but without defined boundaries; afterwards the illuminating bodies with their distinct powers and offices—a progression that is well expressed in the Hebrew language by the terms *br* and *mabr* (מָרִיר, מָרִיר). Thus also with the orders of living beings; firstly, plants; secondly, fish and birds; thirdly, cattle; and, lastly, man. From "good" in the several parts to "very good" as a whole (Gen. i, 31), such was its progress in the judgment of the Omnipotent workman.

4. Order involves time; a succession of events implies a succession of periods; and, accordingly, Moses assigns the work of creation to six days, each having its specific portion—light to the first, the firmament to the second, the dry land and plants to the third, the heavenly bodies to the fourth, fish and fowl to the fifth, beasts and man to the sixth. The manner in which these acts are described as having been done precludes all idea of time in relation to their performance; it was miraculous and instantaneous: "God said," and then "it was." But the progressiveness, and consequently the individuality of the acts, does involve an idea of time as elapsing between the completion of one and the commencement of another; otherwise the work of creation would have resolved itself into a single continuous act. The period assigned to each individual act is a day—the only period which represents the entire cessation of a work through the interposition of night. That a natural day is represented under the expression "evening was and morning was," admits, we think, of no doubt; the term "day" alone may sometimes refer to an indefinite period contemporaneous with a single event; but when the individual parts of a day, "evening and morning," are specified, and when a series of such days are noticed in their numerical order, no analogy of our language admits of our understanding the term in anything else than its literal sense. The Hebrews had no other means of expressing the civil day of twenty-four hours than as "evening, morning" (עֶרְבַּי וּבֹקֶרִי, Dan. viii, 14), similar to the Greek *συχθήμερον*; and, although the alternation of light and darkness lay at the root of the expression, yet the Hebrews in their use of it no more thought of these elements than do we when we use the terms *fortnight* or *se'night*; in each case the lapse of a certain time, and not the elements by which that time is calculated, is intended; so that, without the least inconsistency either of language or of reality, the expression may be applied to the days previous to the creation of the sun. The application of the same expressions to the events subsequent to the creation of the sun, as well as the use of the word "day" in the fourth commandment without any indication that it is used in a different sense, or in any other than the literal acceptance of Gen. i, 5 sq., confirm the view above stated. The interpretation that "evening and morning" = *beginning and end*, is opposed not only to the order in which the words stand, but to the sense of the words elsewhere.

5. The Hebrews, though regarding creation as the immediate act of God, did not ignore the evident fact that existing materials and intermediate agencies were employed both then and in the subsequent operations of nature. Thus the simple fact, "God created man" (Gen. i, 27), is amplified by the subsequent notice of the material substance of which his body was made (Gen. ii, 7); and so also of the animals (Gen. i, 24; ii,

19). The separation of sea and land, attributed in Gen. i, 6, to the divine fiat, was seen to involve the process of partial elevations of the earth's surface (Psa. civ, 8, "the mountains ascend, the valleys descend;" comp. Prov. viii, 25-28). The formation of clouds and the supply of moisture to the earth, which in Gen. i, 7, was provided by the creation of the firmament, was afterwards attributed to its true cause in the continual return of the waters from the earth's surface (Eccl. i, 7). The existence of the element of light, as distinct from the sun (Gen. i, 8, 14; Job xxxviii, 19), has likewise been explained as the result of a philosophically correct view as to the nature of light; more probably, however, it was founded upon the incorrect view that the light of the moon was independent of the sun.

6. With regard to the earth's body, the Hebrews conceived its surface to be an immense disc, supported like the flat roof of an Eastern house by pillars (Job ix, 6; Psa. lxxv, 8), which rested on solid foundations (Job xxxviii, 4, 6; Psa. civ, 5; Prov. viii, 29); but where those foundations were on which the "sockets" of the pillars rested, none could tell (Job xxxviii, 6). The more philosophical view of the earth being suspended in free space seems to be implied in Job xxvi, 7; nor is there any absolute contradiction between this and the former view, as the pillars of the earth's surface may be conceived to have been founded on the deep bases of the mountains, which bases themselves were unsupported. Other passages (Psa. xxiv, 2; cxxvi, 6) seem to imply the existence of a vast subterranean ocean; the words, however, are susceptible of the sense that the earth was elevated above the level of the sea (Hengstenberg, *Comm.* in loc.), and that this is the sense in which they are to be accepted appears from the converse expression "water under the earth" (Exod. xx, 4), which, as contrasted with "heaven above" and "earth beneath," evidently implies the comparative elevation of the three bodies. Beneath the earth's surface was *sheol* (שְׁאוֹל), the *hollow* place, "hell" (Num. xvi, 30; Deut. xxxii, 22; Job xi, 8), the "house appointed for the living" (Job xxx, 28), a "land of darkness" (Job x, 21), to which were ascribed in poetical language gates (Isa. xxxviii, 10) and bars (Job xvii, 16), and which had its valleys or deep places (Prov. ix, 18). It extended beneath the sea (Job xxvi, 5, 6), and was thus supposed to be continuous with the upper world.—Smith, *Dict. s. v.* Earth.

7. The Mosaic statement of the world's formation (Gen. i) has been variously treated by different writers on the connection between science and the Bible. Skeptics have designated the Mosaic *heptameron* as a "myth," or, more mildly, the speculation of an ancient sage. Most Christians speak of it as a "history" or "narrative," or, more vaguely, a "record." Huxtable calls it a "parable" (*Sacred Record of Creation*, Lond. 1861). Others (e. g. Kurtz, Hugh Miller) suggest that it is a "vision;" one styles it a "plan" (Challier, *Creation*, Lond. 1861). But these are evidently mere glosses. The choice still lies between the Chalmersian interpolation of the geological ages before the first creative *day* begins (so Buckland, Pye Smith, Hitchcock, Crofton, Archd. Pratt, Gloag, and others), and the Cuvierian expansion of the six days into geological ages (with Miller, Macdonald, Silliman, Gausson, Sime, M'Causland, M'Caul, Dana, and others). See *DAT.* Mr. Rorison (*The Creation Week*, in *Replies to "Essays and Reviews,"* Lond. and N. Y. 1862, p. 285) thinks he has discovered a new solution of the difficulty by terming the first chapter of Genesis "the inspired *Psalm* of creation," and he accordingly sets his ingenuity to work to draw out the demurgic passage in a parallelized or hemistich form like Hebrew poetry. Yet this is but a modification of the "mythical theory" applied in a less bold form to the sacred

text, but as really destructive of the historical verity of the document as the more palpable rationalistic views. There is no middle ground here between *fact* and *fancy*. The language is too detailed to admit the general dismissal of it as a cosmogonical poem. The same writer's comparison of the 104th Psalm, as being "section by section the daughter, the antiphone, the echo" of the Mosaic poem, is utterly preposterous, as the most casual collation of the two will show. Be a fatal circumstance to this hypothesis is that the first chapter of Genesis lacks nearly every element of acknowledged Hebrew poetry. In *FORM* it has neither the lyrical prosody of the Psalms, nor the epic structure of Job; neither the dithyrambic march of the Prophets, nor the idyllic colloquies of the Canticles, nor even the didactic collocations of the Proverbs and Ecclesiastes. There is no *paronomasia* (except the accidental one in the stereotyped phrase עֵשֶׂת יָמִים = pell-mell), no *ellipsis*, no *introversion*, no *pleonasm*, no climactic character; in short, no figurative element whatever to distinguish its phraseology from the rest of prose. There is no proper *PARALLELISM* (q. v.), based upon intrinsic antithesis and synonyms; no rhythmic measure. (Compare the perfection in all these respects of the earliest real odes on record, Gen. iv, 23, 24.) Again, as to *SENTIMENT*, it lacks that lofty moral tone, that fine play of the imagination, that abrupt change of subject and field, which—even when other criteria fail—serve to indicate the rhapsodies of the Hebrew bards. The only thing at all resembling poetry in its dress is the strophic return of the clause "evening and morning," which is simply due to the necessary regularity of the hebdomadal periods; and the only feature in its substance allying it to poetry is a certain dignity and advance of thought, which is inherent in the incidents themselves: all that can properly be said of the diction is that it is rhetorical and suited to the subject. Even Mr. Rorison fails to point out in its body the requisite artistic constructiveness, or in its spirit the fire of genius essential to all poetic effusions. Almost any descriptive portion of the Old Testament would be found to exceed it in these respects, if carefully analyzed. The very next chapter of Genesis is fully as poetical, whether in regard to its topics, its style, or its composition; and thus, by the same loose, unscientific process, we might (as many would fain do) reduce the accounts of Adam's specific formation, of a local Eden, and of the origin of human depravity, to poetic legends. Just criticism forbids such a distortion of prose to accommodate speculative preconception. See *POETRY.* For an able treatise on the bearings of the Hebrew cosmology upon modern astronomy and geology, see Kurtz, *Hist. of the Old Covenant* (Edinb. 1856, vol. i, ch. i; also separately, Phila. 1857); comp. Johannsen, *Die kosmogonischen Ansichten der Hebräer* (Alt. 1833); Brown, *Mosaic Cosmogony* (Lond. 1864). See *COSMOGONY*: CREATION.

COSMOS. See **WORLD.**

Cossett, FRANCEWAY BANNA, D.D., a prominent minister of the Cumberland Presbyterian Church. He was born in Claremont, New Hampshire, April 24, 1790. His parents were Episcopalians, his grandfather being the founder and for many years the pastor of the first Episcopal church of Claremont. He studied at Middlebury College, Vermont, and graduated in 1813. From the same institution he received in 1839 the degree of Doctor of Divinity, which degree was also conferred upon him in after years by Cumberland College, Kentucky. Soon after leaving college he engaged in teaching a classical school in Morristown, N. J. After two years he accepted a call as principal of Vine Hill Academy, N. C., where he taught several years, when, his health being poor, he returned to New England, where soon after he was converted. He felt deeply impressed with the duty of preaching

the Gospel, and soon after entered the Episcopal Theological Seminary at New Haven. From the seminary he went to Tennessee, with the commendation and action of the bishop as a "lay preacher." Here he became acquainted for the first time with Cumberland Presbyterians, "participated in their extraordinary revivals, attended their delightful camp-meetings." He was especially pleased with their success in winning souls to Christ, and, after a long, prayerful, and hard struggle, he felt it his duty to cast his lot with them. In the year 1822 he was ordained by the Anderson presbytery of this church. He taught very successfully for some time in a classical school in Elkton, Ky. He was the first president of Cumberland College at Princeton, Ky., over which he presided for years with great honor and success. When Cumberland University was started some years later at Lebanon, Tennessee, he accepted a call to the first presidency of that institution. He presided over it until he had arisen to be one of the foremost institutions in the entire South. He was for years, and up to his death, president of the Board of Foreign and Domestic Missions of the C. P. Church. He also started and maintained for several years successfully a weekly religious paper called the "Banner of Peace," which is still (1867) being published at Nashville, Tenn. Dr. Cossett published *The Life and Times of Ewing*, which contains a history of the early years of the C. P. Church. Mr. Cossett was a man of great learning and ability, and in his younger days was a very successful preacher. He was indefatigable in his efforts to promote education among all classes, but especially in the ministry. In all his intercourse with men, either personally, by letter, or as a controversialist, he never deviated from the rules of honorable Christian discussion, or the manners of the Christian gentleman. He died at Lebanon, Tennessee, July 8, 1863.

Costa, Da. See DA COSTA.

Costobárus (*Kooσίβαρος*). 1. An Idumean of honorable connections, married by Herod to his sister Salome, and appointed governor of Idumea, but afterwards renounced by her on pretext of his favoring the escape of the sons of Babas, the last scions of the Hyrcanian dynasty, and eventually slain by Herod (Josephus, *Ant.* xv, 7, 8-10).

2. A relative of Agrippa, and a ringleader of the Sicarii in their excesses at Jerusalem (Josephus, *War*, ix, 9, 4).

Costume, ORIENTAL. The subject of the style of dress of the ancient Hebrews is involved in much obscurity and doubt. Sculptured monuments and coins afford us all useful information respecting the apparel of the ancient Egyptians, Babylonians, Persians, Greeks, and Romans; and even the garb worn by the barbarous nations is perpetuated in the monuments of their antagonists and conquerors. But the ancient Hebrews have left no monuments, no figures of themselves; and the few figures which have been supposed to represent Jews in the monuments of Egypt and Persia are so uncertain that their authority remains to be established before we can rely upon the information which they convey. There are, however, many allusions to dress in the Scriptures, and these form the only source of our positive information. They are often, indeed, obscure, and of uncertain interpretation, but they are invaluable in so far as they enable us to compare and verify the information derivable from other sources.

1. The range of inquiry into *monumental* costume is very limited. It is a common mistake to talk of "Oriental costume" as if it were a uniform thing, whereas, in fact, the costumes of the Asiatic nations differ far more from one another than do the costumes of the different nations of Europe. That this was also the case anciently is shown by the monuments, in which the costumes of Egyptians, Assyrians, Babylo-

nians, Persians, Medes, Syrians, and Greeks differ as much from one another as do the costumes of the modern Syrians, Egyptians, Arabs, Turks, and Persians. It is therefore nearly useless to examine the monumental costume of any nation, remote from Palestine, for the purpose of ascertaining the costume of the ancient Hebrews. Syria, Arabia, Egypt, and, to some extent, Assyria, Persia, and Babylonia, are the only countries where monuments would be likely to afford any useful information; but Arabia has left no monumental figures, and Syria none of sufficiently ancient date, while those of Assyria, Babylonia, and Persia depict few scenes of social life; and it is left for Egypt to supply nearly all the information likely to be of use. But the Egyptians and the Hebrews were an exceedingly different people; and the climates which they inhabited were also so different as to necessitate a greater difference of food and dress than might be presupposed of countries so near to each other. It is true that the Jewish nation was cradled in Egypt; and this circumstance may have had some influence on ceremonial dresses and the ornaments of women; but we do not find that nations circumstanced as the Jews were readily adopt the costumes of other nations, especially when their residence in Egypt was always regarded by them as temporary, and when their raiment was of home manufacture—spun and woven by the women from the produce of their flocks (Exod. xxxv, 25). We find also that, immediately after leaving Egypt, the principal article of dress among the Hebrews was some ample woollen garment, fit to sleep in (Exod. xxii, 27), to which nothing similar is to be seen among the costumes of Egypt.

2. With respect to the supposed representation of *Jesus* in ancient monuments, if any authentic examples could be found, even of a single figure, in the ancient costume, it would afford much satisfaction, as tending to elucidate many passages of Scripture which cannot at present be with certainty explained. (See also under the article BRICK.)

(a) A painting at Beni Hassan represents the arrival of some foreigners in Egypt, and is supposed to figure the arrival of Joseph's brethren in that country. The accessories of the scene, the physiognomies of the persons, and the time to which the picture relates, are certainly in unison with that event; but other circumstances are against the notion. Sir J. G. Wilkinson speaks hesitatingly on the subject; and, until some greater certainty is obtained, we may admit the possible correctness of the conjecture. The annexed cut

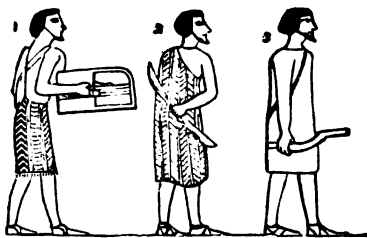

Supposed Representation of Joseph's Brethren on the Egyptian Monuments.

shows the variety of costume which this scene displays. All the men wear sandals. Some of them are clad only in a short tunic or shirt, with close sleeves (fig. 3); others wear over this a kind of sleeveless plaid or mantle, thrown over the left shoulder, and passing under the right arm (fig. 2). It is of a striped and curiously figured pattern, and looks exceedingly like the fine grass woven cloth of the South Sea. Others have, instead of this, a fringed skirt of the same material (fig. 1). All the figures are bare-headed, and wear beards, which are circumstances favorable to the identification. The fringed skirt of fig. 1 is certainly a re-

markable circumstance. Moses directed that the people should wear a fringe at the hem of their garments (Num. xv, 38); and the probability is that this command merely perpetuated a more ancient usage.

(b.) This fringe reappears, much enlarged, in the other Egyptian sculpture in which Jews are supposed to be represented. These are in a tomb discovered by Belzoni, in the valley of Bab el-Meluk, near Thebes. There are captives of different nations, and among them four figures, supposed to represent Jews. The

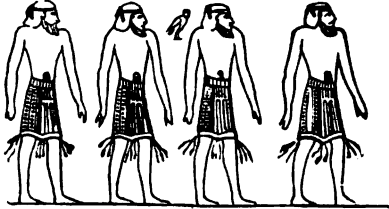

Supposed Representation of Jewish Captives on the Egyptian Monuments.

scene is imagined to commemorate the triumphs of Pharaoh-Necho in that war in which the Jews were defeated at Megiddo, and their king Josiah slain (2 Chron. xxxv, xxxvi).

(c.) On the face of a rock at Behistun (q. v.), on the Median border of the ancient Assyria, there is a remarkable sculpture representing a number of captives strung together by the neck, brought before the king and conqueror, who seems to be pronouncing sentence upon them. The venerable antiquity of this sculpture is unquestionable; and Sir R. K. Porter was led to fancy that the sculpture commemorates the subjugation and deportation of the *ten* tribes by Shalmaneser, king of Assyria (2 Kings xvii, 6). The reasons which he assigns (*Travels in Persia*, ii, 159 sq.) for this conclusion are of little weight, and not worth examination. But the single fact that the figures are arrayed in a costume similar to the ancient and present garb of the people of Syria and Lebanon inclines us to think that the figures really do represent the costume of nations west of the Euphrates, including, probably, that of the Jews and their near neighbors. The dress here



Supposed Representation of Israelitish Prisoners on the Persian Monuments.

shown is a shirt or tunic confined around the waist by a strap or girdle; while others have a longer and larger robe, furnished with a spacious cape or hood, and, probably, worn over the other.

There is no reason to think that the dress of the Jews was in any important respect different from that of the other inhabitants of the same and immediately bordering countries. It would therefore be satisfactory, and would enable us to judge better of the figures which have been noticed, if we had representations of Canaanites, Phœnicians, Syrians, Moabites, etc., by the Egyptian artists, who were so exact in discriminating, even to caricature, the peculiarities of nations. Under the article ARMOR (p. 423) there is a supposed figure of a Canaanite warrior from this source. The dress, being military, does not afford much room for comparison in the present instance; but we at once recognise in it most of the articles which formed the military dress of the Hebrews. The annexed figures, however, convey more information, as they appear to represent inhabitants of Samaria

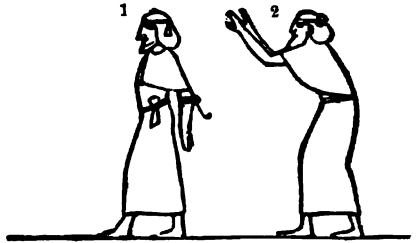

Supposed Representation of Natives of Palestine on the Egyptian Monuments.

and Lebanon. The evidence for the last (fig. 2) is as conclusive as can be obtained, for not only is there the name "Lemamon" (*m* being constantly interchangeable with *b*), but the persons thus attired are represented as inhabiting a mountainous country, and felling trees to impede the chariots of the Egyptian invaders. The dresses are similar to each other, and this similarity strengthens the probability that the dress of the Jews was not very different; and it is also observable that it is similar to the full dress of some of the figures in the sculpture at Behistun: the figures are bearded, and the cap, or head-dress, is bound round with a fillet. The figures are arrayed in a long gown reaching to the ankles, and confined around the waist by a girdle; and the shoulders are covered by a cape, which appears to have been common to several nations of Asia. At first view it would seem that this dress is different from those already figured. But, in all probability, this more spacious robe is merely an outer garment, covering the inner dress which is shown in the figures that seem more scantily arrayed. (See the ingenious papers by a lady on the costumes of the ancient Canaanites in the *Jour. of Sac. Lit.*, Jan. 1853, p. 291 sq. and the cuts in the No. for April, 1854.) See CANAANITE; LEBANON.

3. The information on this subject to be obtained from tradition is embodied—(1.) In the dresses of monks and pilgrims, which may be traced to an ancient date, and which are an intended imitation of the dresses supposed to have been worn by the first disciples



Christian Costumes of Oriental Monks and Pilgrims.

and apostles of Christ. (2.) The garb conventionally assigned by painters to scriptural characters, which were equally intended to embody the dress of the apostolical period, and is corrected in some degree by the notions of Oriental costume which were collected during the Crusades.

To judge of the value of these costumes, we must compare them, first, with the scanty materials already produced, and then with the modern costumes of Syria and Arabia. The result of this examination will probably be that these traditional garbs are by no means bad reminiscences of Hebrew costume; and that the dresses which the painters have introduced into scriptural subjects are far more near to correctness than it has latterly been the fashion to suppose. It is per-



Fancy Sketches of Oriental Costume by early Painters.

aps as nearly as possible a just medium between the ecclesiastical tradition and the practical observation. To dress more suitable to the dignity of the subjects could possibly be devised; and, sanctioned as it has been by long use, and rendered venerable by scriptural associations, we should be reluctant to see it exchanged for the existing Oriental costumes, which the French artists have begun to prefer. But this is only with regard to pictorial associations and effects; for, in an inquiry into the costume *actually* worn by the Israelites, modern sources of information must be by no means overlooked.

4. The value of the *modern Oriental* costumes for the purposes of scriptural illustration arises from the fact that the dress, like the usages, of the people is understood to be the same, or nearly the same, as that used in very ancient times. But this must be understood with some limitations. The dress of the Turks is distinctive and peculiar to themselves, and has no connection with the aboriginal costumes of Western Asia. The dress of the Persians has also been changed almost within the memory of man, that of the ruling Tartar tribe having been almost invariably adopted; so that the present costume is altogether different from that which is figured by Sir Thomas Herbert, Chardin, de Bruyn, Niebuhr, and other travellers of the 17th and 18th centuries. But with the exceptions of the foreign Turkish costume and its modifications, and with certain local exceptions, chiefly in mountainous regions, it may be said that there is one prevailing costume in all the countries of Asia between the Tigris and Mediterranean, and throughout Northern Africa, from the Nile to Morocco and the banks of the Senegal. This costume is essentially Arabian, and owes its extension to the wide conquests under the first Caliphs; and it is through the Arabians—the least changed of ancient nations, and almost the only one which has remained as a nation from ancient times—that the antiquity of this costume may be proved. This is undoubtedly the most ancient costume of Western Asia; and while one set of proofs would carry it up to scriptural times, another set of strong probabilities and satisfactory analogies will take it back to the most remote periods of scriptural history, and will suggest that the dress of the Jews themselves was very similar, without being strictly identical.

We may here remark, (1.) That the usages of the Arabians in Syria and Palestine are more in agreement with those of Scripture than those of any other inhabitants of those countries. (2.) That their costume throws more light on the scriptural intimations than any other now existing, while it agrees more than any other with the materials supplied by antiquity and by tradition. (3.) That the dress which the Arabian Arabs gradually superseded in Syria and Palestine was not the same as that of scriptural times, excepting, perhaps, among the peasantry, whose dress appears to have then differed little from that of the Arabian con-

querors. The Jews had for above five centuries ceased to be inhabitants of Palestine; and it is certain that during the intermediate period the dress of the upper classes—the military and the townspeople—had become assimilated to that of the Greeks of the Eastern empire. Arabia had meanwhile been subjected to no such influences, and the dress which it brought into Syria may be regarded as a restoration of the more ancient costume, rather than (as it was in many countries) the introduction of one previously unknown.

It is to be observed, however, that there are two very different sorts of dresses among the Arabians. One is that of the Bedouin tribes, and the other that of the inhabitants of towns. The distinction between these is seldom clearly understood or correctly stated, but is of the utmost importance for the purpose of the present notice. Instead, therefore, of speaking of the Arabian costume as one thing, we must regard it as two things—the desert costume and the town costume. If, then, our views of Hebrew costume were based on the actual costume of the Arabians, we should be led to conclude that the desert costume represented that which was worn during the patriarchal period, and until the Israelites had been some time settled in Canaan; and the town costume that which was adopted from their neighbors when they became a settled people.

(a) The annexed cut represents, in fig. 2, a Bedouin,



Modern Arab Dress of the Desert Tribes.

or desert Arab, in the dress usually worn in Asia; and fig. 1 represents a townsman in a cloak of the same kind, adopted from the Arabs, and worn very extensively as an outermost covering in all the countries from the Oxus (for even the Persians use it) to the Mediterranean. The distinctive head-dress of the Bedouin, and which has not been adopted by any other nation, or even by the Arabian townsmen, is a kerchief (*keffeh*) folded triangularly, and thrown over the head so as to fall down over the neck and shoulders, and bound to the head by a band of twisted wool or camel's hair. The cloak is called an *abba*. It is made of wool and hair, and of various degrees of fineness. It is sometimes entirely black, or entirely white, but is more usually marked with broad stripes, the colors of which (never more than two, one of which is always white) are distinctive of the tribe by which it is worn. The cloak is altogether shapeless, being like a square sack, with an opening in front, and with slits at the sides to let out the arms. The Arab who wears it by day, sleeps in it by night, as does often the peasant by whom it has been adopted; and in all probability this was the garment similarly used by the ancient Hebrews, and which a benevolent law, delivered while Israel was still in the desert, forbade to be kept in pledge beyond the day, that the poor might not be without a covering at night (Exod. xxii, 27). This article of dress appears to have been little known to Biblical illustrators, although it is the principal and

most common outermost garment in Western Asia. This singular neglect has arisen from their information being chiefly derived from Shaw and others, who describe the costume of the Arab tribes or Moors of Northern Africa, where the outer garment is more generally the *bournos* (fig. 8), a woollen cloak, not unlike the *abba*, but furnished with a hood, and which is sometimes strangely confounded, even by well-informed persons, with a totally different outer garment worn in the same regions, usually called the *hyke*, but which is also, according to its materials, quality, or color, distinguished by various other names; and writers have produced some confusion by not observing that these names refer to an article of raiment which under all these names is essentially the same. Regardless of these minute distinctions, this part of dress may be described as a large woollen blanket, either white or brown, and in summer a cotton sheet (usually blue or white, or both colors together). Putting one corner before over the left shoulder, the wearer brings it behind, and then under the right arm, and so over the body, throwing it behind over the left shoulder, and leaving the right arm free for action. This very picturesque mode of wearing the *hyke* is shown in fig. 2 of the accompanying cut. Another



Various Methods of Wearing the Modern Arab Mantle or Hyke.

mode of wearing it is shown in fig. 8. It is sometimes thrown over the head as a protection from the sun or wind (fig. 1), and calls to mind the various passages of Scripture in which persons are described as covering their heads with their mantles (2 Sam. xv, 30; 1 Kings xix, 18; Esther vi, 12). This article of dress, originally borrowed from the nomades, is known in Arabia, and extends westward to the shores of the Atlantic, being most extensively used by all classes of the population. The seat of this dress, and of the *abba* respectively, is indicated by the direction of their importation into Egypt. The *hykes* are imported from the west (i. e. from North Africa), and the *abbas* from Syria. The close resemblance of the above group of real costume to those in which the traditional ecclesiastical and traditional artistic costumes are displayed, must be obvious to the most cursory observer. It may also be noticed that the *hyke* is not without some resemblance, as to the manner in which it was worn, to the outer garment of one of the figures in the Egyptian family, supposed to represent the arrival of Joseph's brethren in Egypt (above).

(b) We now turn to the costumes which are seen in the towns and villages of south-western Asia.

In the Scriptures *drawers* are only mentioned in the injunction that the high-priest should wear them (Exod. xxviii, 42), which seems to show that they were not generally in use; nor have we any evidence that they ever became common. Drawers descending to the middle of the thighs were worn by the ancient Egyptians, and workmen often laid aside all the rest of their dress when occupied in their labors. As far

as this part of dress was used at all by the Hebrews it was doubtless either like this, or similar to those which are now worn in Western Asia by all, except some among the poorer peasantry, and by many of the Bedouin Arabs. They are of linen or cotton, of ample breadth, tied around the body by a running string or band, and always worn next the skin, not over the shirt, as in Europe.

It will be asked, when the poor Israelite had paved his outer garment "wherein he slept," what dress was left to him? The answer is probably supplied by the annexed engraving, which represents slightly



Modern Oriental Undergarment.

different garments of cotton, or woollen frocks or shirts, which often, in warm weather, form the sole dress of the Bedouin peasants, and the lower class of townspeople. To this the *abba* or *hyke* is the proper outer robe (as in fig. 1, second cut preceding), but is usually, in summer, dispensed with in the daytime, and in the ordinary pursuits and occupations of life. It is sometimes (as in the foregoing cut, fig. 2) worn without, but more usually with a girdle; and it will be seen that the shorter specimens are not unlike the dress of one of the figures (fig. 8) in the earliest of the Egyptian subjects which have been produced. The shirt worn by the superior classes is of the same shape, but of finer materials. This is shown in the accompanying figure, which represents a gentleman as just risen from bed. If we call this a shirt, the Hebrews doubtless had it — the sole dress (excepting the cloak) of the poor, and the inner robe of the rich. Such, probably, were the "sheets" (translated "shirts" in some versions), of which Samson despoiled thirty Philistines to pay the forfeit of his riddle (Judg. xiv, 18, 19). It is shown from the Talmud, indeed, that the Hebrews of later days had a shirt called *חלוקין*, *chaluk'*, which, it would appear, was often of wool (Lightfoot, *Hor. Heb.* on Luke ix, 5), and which is described as the ordinary inner garment, the outer being the cloak or mantle. This shows that the shirt or frock was, as in modern usage, the ordinary dress of the Jews, to which a mantle (*abba*, *hyke*, or *bournos*) was the outer covering.



Modern Oriental Undergarment.

The Talmud enumerates eighteen several garments which formed the clothing of the Jews from head to foot (Talm. Hieros. *Sabb.* fol. 15; Talm. Bab. *Sabb.* fol. 120), mentioning, however, two sandals, two baskins, etc. This shows, at least, one thing, that they were not more springily clad than the modern Oriental

1a. This being the case, we may be sure that although persons of the humbler classes were content with the shirt and the mantle, the wealthier people had other robes between these two, and forming a complete dress without the mantle, which with them was probably confined to out-of-door wear, or ceremonial use. It is, of course, impossible to discriminate these precisely, but in this matter we cannot be far wrong in trusting to the analogy of existing usages.

In all the annexed figures, representing persons of



Modern Oriental Outer Garment.

the superior class, we observe the shirt covered by a striped (sometimes figured) gown or *caftan* of mingled silk and cotton. It descends to the ankles, with long sleeves, extending a few inches beyond the fingers' ends, but divided from a point a little above the wrist, so that the hand is generally exposed, though it may be concealed by the sleeve when necessary; for it is customary to cover the hands in the presence of a person of high rank. It is very common, especially in winter, for persons to sleep without removing this gown, but only unloosing the girdle by which it is bound. It is not unusual within doors to see persons without any article of dress outside this; but it is considered decidedly as an undress, and no respectable person is beheld out of doors, or receives or pays visits, without an outer covering. Hence persons clad in this alone are said to be "naked" in Scripture—that is, not in the usual complete dress; for there can be no manner of doubt that this, or something like this, is the *קִטְוֹנִית*, *ketho'neh*, of Scripture (Exod. xxviii, 40; Job xxx, 18; Isa. xxii, 21, etc.). A similar robe is worn by the women, as was also the case among the Israelites (2 Sam. xiii, 18, 19; Cant. v, 8). It is in the bosom of this robe that various articles are carried. See Bosom.

The girdle worn over this, around the waist, is usually a colored shawl, or long piece of figured white muslin. The girdle of the poorer classes is of coarse stuff, and often of leather, with clasps. This leathern girdle is also much used by the Arabs, and by persons of condition when equipped for a journey. It is sometimes ornamented with workings in colored worsted, or silk, or with metal studs, shells, beads, etc. Both kinds of girdles were certainly in use among the Hebrews (2 Kings i, 8; Matt. iii, 4; Mark i, 6; comp. Jer. xiii, 1). See GIRDLER. It seems from 2 Sam. xx, 8 (comp. fig. 1 above), that it was usual to wear a knife or poniard in the girdle. This custom is still general, and denotes not any deadly disposition, but the want of clasp-knives. Men of literary vocations replace it by an ink-horn, as was also the case among the Israelites (Ezek. ix, 2).

Over the gown is worn either the short-sleeved *gibbeh* (fig. 3), which is a long coat of woollen cloth, or the long-sleeved *besish* (fig. 2), which is also of woollen cloth, and may be worn either over or instead of

the other. The *besish* is, by reason of its long sleeves (with which the hands may be covered), the robe of ceremony, and is worn in the presence of superiors and persons of rank. Over one or both of these robes may be worn the *abba*, *bournos*, or *hyke*, in any of the modes already indicated. Aged persons often wrap up the head and shoulders with the latter, in the manner shown in fig. 4.

This same *hyke* or wrapper is usually taken by persons going on a journey, for the purpose of being used in the same manner as a protection from the sun or wind. This is shown in the annexed cut, represent-



Modern Oriental Travelling Dress.

ing a group of persons equipped for travel. The robe is here more succinct and compact, and the firm manner in which the whole dress is girded up about the loins calls to mind the passages of Scripture in which the action of "girding up the loins" for a journey is mentioned.

From this it is also seen that travellers usually wear a sword, and the manner in which it is worn is correctly shown. It would also appear that the Jews had swords for such occasional uses (Matt. xxvi, 51; Luke xxii, 36).

The necessity of baring the arm for any kind of exertion must be evident from the manner in which it is encumbered in all the dresses we have produced. This action is often mentioned in Scripture, which alone proves that the arm was in ordinary circumstances similarly encumbered by the dress. For ordinary purposes a hasty tucking up of the sleeve of the right arm suffices; but for a continued action special contrivances are necessary. These are curious, as will be seen by the cut adjoining. The full sleeves of the



Girded Sleeves of Modern Orientals.

shirt are sometimes drawn up by means of cords, which pass round each shoulder, and cross behind, where they are tied in a knot. This custom is particularly affected by servants and workmen, who have constant

occasion for baring the arm; but others, whose occasions are more incidental, and who are, therefore, unprovided with the necessary cords, draw up the sleeves and tie them together behind between the shoulders (fig. 2).

For the dress of females, see the article WOMAN. Certain parts of dress, also, admit of separate consideration, such as the head-dress or turban (q. v.), and the dress of the feet or sandals (q. v.).—Kitto, s. v. Dress. (See "The Book of Costume," ancient and modern, by a Lady, Lond. 1847; Prisse and St. John's *Oriental Album*, London, 1847; *Costumes of Turkey*, London, 1802; Lane, *Arabian Nights*, cuts; Perkins, *Residence in Persia*, plates; Ramboux, *Erinner. an. d. Pilgerfahrt nach Jerusalem*, Köln, 1854). Compare the article DRESS.

COSTUME, SACERDOTAL. See PRIEST.

COSTUME, CLERICAL. See VESTMENTS (OF THE CLERGY).

Cote (only in the plur. אָרוֹת, *averoth'*, by transposition for אָרוֹת, *racks* for fodder), properly *cribs*; hence *pens*, or enclosures for flocks (2 Chron. xxxii, 28, where, instead of "cotes for flocks," the original has "flocks for [the] cotes"). See SHEEP-COTE; DOVE-COTE.

Cotelierus (*Cotelier*), JOHN BAPTIST, an eminent French scholar, born at Nismes, 1627. At twelve years of age he could read the Hebrew Bible and the Greek Testament with ease. In 1649 he was elected a member of the Sorbonne. He did not receive the degree of doctor, because he refused to take orders. In 1676 he was made Greek lecturer at Paris, and retained this post, with great reputation, till his death, August 2, 1686. Most of his literary labor was spent upon the Greek fathers; and in 1672 he published the "Apostolic Fathers" (*Patres Aevi Apostolici*, Paris), of which the best edition is *Patrum qui temporibus Apostolicis floruerunt opera*, recensuit J. Clericus (Amst. 1724, 2 vols. fol.). In 1667 he was commissioned by Colbert to revise and catalogue the Greek manuscripts of the Royal Library. He was engaged in this work, conjointly with the celebrated Du Cange, for five years. In 1676 he obtained through Colbert the chair of Greek at the Royal College of Paris. In 1677 he began the publication of his *Ecclesia Græca Monumenta, e MSS. codicibus*, Gr. and Lat. (3 vols. 4to; the 3d vol. appeared two days before his death). The fourth volume of this work, for which he had collected much material, was published in 1692 by the Maurines.—See Wetzler u. Welte, *Kirchen-Lex.* ii, 905; Dupin, *Nouvelle Bibliothèque*, xviii, 186.

Cottage is employed in our version for three Hebrew words. See BOOTH.



Modern Oriental Booths or Sheds.

1. סֹכֶה, *sukkah'*, signifies a hut made of boughs (Isa. i, 8), and is usually elsewhere translated "booth." It was anciently the custom in the East, as it still is to erect little temporary sheds, covered with leaves, straw, or turf, giving shelter from the heat by day and the cold dews at night to the watchman that kept the garden or vineyard while the fruit was ripening, which otherwise might be stolen, or destroyed by jackals. These erections, being intended only for the occasion, were of the very slightest fabric, and when the fruits were gathered were either taken down, or left to fall to pieces, or were blown down during the winter (Job xxvii, 18). See LODGE.



Modern Oriental Lodge in a Melon-patch.

2. מְלוּנָה, *melunah'* (fem. of מְלוּן, *an inn*), signifies properly a lodging-place, and is associated with the booth ("cottage") in the above passage (Isa. i, 8), where it is translated "lodge," being probably a somewhat slighter structure, if possible, as a cucumber patch is more temporary than a vineyard. It also occurs in Isa. xxiv, 20, in the mistranslated expression "and shall be removed [i. e. shaken about] like a cottage," where it denotes a hanging-bed or hammock suspended from trees, in which travellers, and especially the watchmen in gardens, were accustomed to sleep during summer, so as to be out of the reach of wild animals. The swinging of these aptly corresponds with the staggering of a drunken man. Or it may, perhaps, more appropriately denote here these frail structures of boughs, supported by a few poles, which the Orientals use for the same purpose.



Summer Sleeping-place among the Kurdish Hills.

3. In Zeph. ii, 6, the original term is צִיִּים, *zevayim'* (literally *diggings*), i. e. *pits* for holding water, and, instead of "dwellings [and] cottages for shepherds," it should be rendered "fields full of shepherds' cisterns."

for watering their flocks; that is, the sites of the cities of Philistia should be occupied for pastoral purposes. This word does not occur elsewhere.

Cotton (from the Arab. name *katus*), the well-known wool-like substance which envelops the seeds, and is contained within the roundish-pointed capsule or fruit of the cotton-shrub. Every one also knows that cotton has, from the earliest ages, been characteristic of India. Indeed, it has been well remarked that, as from early times sheep's wool has been principally employed for clothing in Palestine and Syria, in Asia Minor, Greece, Italy, and Spain, hemp in the northern countries of Europe, and flax in Egypt, so cotton has always been employed for the same purpose in India, and silk in China. In the present day, cotton, by the aid of machinery, has been manufactured in this country on so extensive a scale, and sold at so cheap a rate, as to drive the manufactures of India almost entirely out of the market. But still, until a very recent period, the calicoes and chintzes of India formed very extensive articles of commerce from that country to Europe. For the investigation of the early history of cotton, we are chiefly indebted to the earliest notices of this commerce; before adducing these, however, we may briefly notice the particular plants and countries from which cotton is obtained. India possesses two very distinct species: 1. *Gossypium herbaceum* of botanists, of which there are several varieties, some of which have spread north, and also into the south of Europe, and into Africa. 2. *Gossypium arboreum*, or cotton-tree, which is little cultivated on account of its small produce, but which yields a fine kind of cotton. This must not be confounded, as it often is, with the silk-cotton tree, or *Bombax heptaphyllum*, which does not yield a cotton fit for spinning. Cotton from these kinds is now chiefly cultivated in Central India, from whence it is carried to and exported from Broach. It is also largely cultivated in the districts of the Bombay Presidency, as also in that of Madras, but less in Bengal, except for home manufacture, which of course requires a large supply, where so large a population are all clothed in cotton. American cotton is obtained from two entirely distinct species—*Gossypium Barbardense*, of which different varieties yield the Sea Island, Upland, Georgian, and the New-Orleans cottons; while *G. Peruvianum* yields the Brazil, Pernambuco, and other South American cottons. These species are original natives of America.—Kitto, s. v. The *Gossypium herbaceum*, a figure of which is annexed, is probably

the species known to the ancients. (See *Penny Cyclopaedia*, s. v. *Gossypium*.)

This substance is no doubt denoted by the term קָרְפָּס , *karpas'* (whence Gr. *κάρπασος*, Lat. *carbasus*, from Sanscr. *karpas*), of Esth. i, 6, which the A. V. renders "green" (Sept. *καρβάσινος*, Vulg. *carbasinus*). There is considerable doubt, however, whether under שֵׁשׁ , *sheesh*, in the earlier, and יָרֵב , *buts*, in the later books of the O. T. rendered in the A. V. "white linen," "fine linen," etc., cotton may not have been included as well. Both these latter terms are said by Gesenius to be from roots signifying originally mere whiteness; a sense said also to inhere in the word בָּד , *bad*, used sometimes instead of, and sometimes together with *sheesh* to mean the fabric. In Ezek. xxvii, 16, *sheesh* is mentioned as imported into Tyre from Egypt, and *buts* as from Syria. Each is found in turn coupled with אַרְגָּמָן (*argamon'*), in the sense of "purple and fine linen," i. e. the most showy and costly apparel (comp. Prov. xxi, 22, with Esth. viii, 15). The dress of the Egyptian priests, at any rate in their ministrations, was without doubt of linen (Herod. ii, 87), in spite of Pliny's assertion (xix, 1, 2) that they preferred cotton. Yet cotton garments for the worship of the temples is said to be mentioned on the Rosetta stone (Wilkinson, *Anc. Eg.* iii, 117). The same was the case with the Jewish ephod and other priestly attire, in which we cannot suppose any carelessness to have prevailed. If, however, a Jew happened to have a piece of cotton cloth, he probably would not be deterred by any scruple about the *heterogenea* of Deut. xxii, 11, from wearing that and linen together. There is, however, no word for the cotton plant (like חֲמֵצָה for flax) in the Hebrew, nor any reason to suppose that there was any early knowledge of the fabric in Palestine. See LINEN.

The Egyptian mummy swathings also, many of which are said to remain as good as when fresh from the loom, are decided, after much controversy and minute analysis, to have been of linen, and not cotton (*Egypt. Antiq.* in the *Lib. of Entertaining Knowl.* ii, 182). The very difficulty of deciding, however, shows how easily even scientific observers may mistake, and, much more, how impossible it would have been for ancient popular writers to avoid confusion. Even Greek naturalists sometimes clearly include "cotton" under *λίνον*. The same appears to be true of *θόνη*, *θόνοιον*, and the whole class of words signifying white textile vegetable fabrics. From the proper Oriental name for the article *karpas*, with which either their Alexandrian or Parthian intercourse might familiarize them, the Latins borrowed *carbasus*, completely current in poetical use in the golden and silver period of Latinity, for sails, awnings, etc. Varro knew of tree-wool on the authority of Ctesias contemporary with Herodotus. The Greeks, through the commercial consequences of Alexander's conquests, must have known of cotton cloth, and more or less of the plant. Amasis indeed (about B.C. 540) sent as a present from Egypt a corset ornamented with gold and "tree-wool" (*ἐπίοισι ἀπὸ ξύλου*, Herod. iii, 47), which Pliny says was still existing in his time in a temple in Rhodes, and that the minuteness of its fibre had provoked the experiments of the curious. Cotton was manufactured and worn extensively in Egypt, but extant monuments give no proof of its growth, as in the case of flax, in that country (Wilkinson, *ut sup.* p. 116-139, and plate No. 856); indeed, had it been a general product, we could scarcely have missed finding some trace of it in the monumental details of ancient Egyptian arts, trades, etc.; but especially when Pliny (A.D. 115) asserts that cotton was then grown in Egypt, a statement confirmed by Julius Pollux (a century later), we can hardly resist the inference that, at least as a curiosity and as an experiment, some plantations existed there. This is



Cotton-plant.

the more likely, since we find the cotton-tree (*Gossypium arboreum*, less usual than, and distinct from, the cotton plant, *Gossyp. herbac.*) mentioned still by Pliny as the *only* remarkable tree of the adjacent Ethiopia; and since Arabia, on its other side, appears to have known cotton from time immemorial, to grow it in abundance, and in parts to be highly favorable to that product. In India, however, we have the earliest records of the use of cotton for dress, of which, including the starching of it, some curious traces are found as early as 800 B.C., in the *Institutes of Menu*; also (it is said, on the authority of Prof. Wilson) in the *Rig-Veda*, 105, v. 8. (For these and some other curious antiquities of the subject, see Royle's *Culture and Commerce of Cotton in India*, p. 117-122.)

Cotton is now both grown and manufactured in various parts of Syria and Palestine, and, owing probably to its being less conductive of heat, seems preferred for turbans and shirts to linen; but there is no proof that, till they came in contact with Persia, the Hebrews generally knew of it as a distinct fabric from linen, whilst the negative proof of language and the probabilities of fact offer a strong presumption that, if they obtained it at all in commerce, they confounded it with linen under the terms *shees* or *bute*. The greater cleanliness and durability of linen probably established its superiority over cotton for sepulchral purposes in the N.-T. period, by which time the latter must have been commonly known, and thus there is no reason for assigning cotton as the material of the "linen clothes" (*ἱδύα*) of which we read. (For the whole subject, see Yates's *Textrinum Antiquorum*, pt. i, chap. vi, and app. D.)—Smith, s. v. See BOTANY.

Cotton, George Edward Lynch, Anglican bishop of Calcutta and metropolitan of the Anglican dioceses of India and Ceylon, was born at Chester, England, Oct. 29, 1832. After studying at Westminster School and Trinity College, he was appointed to a mastership in Rugby School, and shortly after was elected to a fellowship at Trinity College. About 1841 he succeeded to the mastership of the fifth form, the highest but one. In 1852 he was elected head master of Marlborough College, which under his management rose to a high position among leading public schools. In 1858 he was appointed to the metropolitan see of Calcutta, where he rendered himself generally beloved. In 1863, with the full concurrence of the governor general, he officially sanctioned an innovation in the use of consecrated churches, which had often been desired, but never till then secured. Since the mutiny, several Scotch regiments have been stationed in the barracks of Upper India, and in many stations they have no churches of their own. Bishop Cotton ordered that at a convenient hour on the Sunday the Episcopal churches should be available for their worship, and that the Presbyterian clergyman should have full liberty to officiate after the rules of his own Church, to the great dissatisfaction of the High-Church party in the Church of England. In England strong measures were suggested in order to compel him to retract. But he knew that the measure was right in itself, that the law was on his side, and that his conduct was heartily approved by the Indian government and by all right-thinking men. In the same spirit, when the Marriage Bill was brought before the Legislative Council, to provide increased facilities for the marriage of Presbyterians and Non-conformists, and give to Nonconformist ministers and registrars powers which they do not possess in England itself, he gave the act his cordial approval. He was accidentally drowned while disembarking from a steamer, October 6, 1866.—*Amer. Cyclopaedia for 1866*, p. 261; *Brit. Quart. Review*, Jan. 1867.

Cotton, John, an eminent Congregational minister, was born at Derby, Eng., Dec. 4, 1856. He was a student in Cambridge, became fellow of Emmanuel

College, and was chosen successively head lecturer and dean. In 1812 he was settled as minister at Boston, Lincolnshire. After preaching some few years, he was silenced for nonconformity with some ceremonies which he held to be unscriptural, but after a short time he was reinstated. About 1832, to escape examination before the High Commission Court, he secreted himself in London, and thence sailed for New England, arriving in Boston Sept. 3, 1838. On Oct. 10 he was appointed preacher in the First Church. He died Dec. 23, 1852. He published *An Abstract of the Laws of New England* (1641):—*The Church's Resurrection* (1642):—*The Pouring out of the Seven Vials* (1642):—*The Way of Life* (Lond. 1641, 4to):—*Sermons on Mercy and Justice of God* (Lond. 1641, 4to):—*Explication of the Canticles* (Lond. 1642, 8vo):—*The Covenant of Grace* (Lond. 1662, sm. 8vo):—*A practical Commentary upon the 1st Epistle of John* (Lond. 1656, fol.), with several minor writings.—Sprague, *Annals*, i, 26.

Cotton MSS. See PURPURES, CODEX.

Couch (כַּסֵּא, *yatsū ā*, something spread, Gen. xlix, 4; "bed," 1 Chron. v, 1; Job xvii, 18; Ps. lxxiii, 6; cxxxii, 8; כִּסֵּא, *mishkab'*, something to lie upon, Job vii, 18, elsewhere "bed;" כִּסֵּא, *e' res*, something erected, Ps. vi, 6; Amos iii, 12; vi, 4; "bed," Job vii, 18; Ps. xli, 8; cxxxii, 8; Prov. vii, 16; Cant. i, 16; "bedstead," Deut. iii, 11; *κλῆιδιον*, a little bed, Luke v, 19, 24; *καββατος*, a pallet, Acts v, 15, elsewhere "bed"). Feather-beds, as among us, are unknown in the East, as indeed generally in southern climates. The poor sleep on mats or wrapped in their overclothes (Exod. xxii, 27; Deut. xxiv, 13; comp. Theocr. xviii, 19; Stobæi *Serm.* 72, p. 404: as to Ruth iii, 9; Ezek. xvi, 8, see Biel in the *Miscell. Lips. Nr.* v, 209 sq.), and, in the open air, sometimes have only a stone for a pillow (Arvieux, iii, 216; comp. Gen. ix, 21, 28; xxviii, 11). The wealthy use bolsters or mattresses (Russel, *Aleppo*, i, 195), stuffed with wool or cotton. These are not laid upon a bedstead, but on a raised portion (*divan*, q. v.) along the side of the room, which by day serves for a seat (Harmar, i, 184; ii, 71; Rosenmüller, *Morgenl.* iii, 211; vi, 14; Lorent, *Wander.* p. 82). Whether the couches of the ancient Hebrews for the sick or sleeping, which are usually termed כִּסֵּא, *mittab'* (Gen. xlvii, 81; 1 Sam. xix, 13; 2 Sam. iv, 7; 2 Kings i, 4), כִּסֵּא, *mishkab'* (Exod. xxi, 18; 2 Sam. xiii, 5; Cant. iii, 1), כִּסֵּא, *e' res* (Job vii, 18; Cant. i, 16; Prov. vii, 11; properly a *bedstead*, see Deut. iii, 11), were upon such a platform, is uncertain, as they appear to have been movable (1 Sam. xix, 15), and were probably used in the daytime, like sofas, for sitting down and repose (1 Sam. xxviii, 23; Ezek. xxiii, 41; Amos iii, 12; vi, 4; yet compare 2 Kings iv, 10). Costly carpets graced the houses of



Oriental Garden Bedstead.

he rich (Prov. vii, 16 sq.; Esak. xxlii, 41; Amos iii, 2); those who lay upon them covered themselves with similar tapestry, and placed a soft fur under their head (1 Sam. xix, 18). A canopy, or bed with a tester, is named in the Apocrypha (Judith xvi, 28), and elsewhere a hanging bed or hammock (רַחֲבֵלֵי, Isa. xxiv, 20), such as watchers in gardens used (Gesenius, *Theas. Heb.* p. 760; comp. Niebuhr, *Beschr.* p. 158). In the Mishna various kinds of beds or couches are referred to; e. g. the שֵׁרָרִי, *dargash'* (*Nedar.* vii, 5). The couches (κλίνη, κράββατος) for the sick, named in the N. T. (Matt. ix, 6; Mark ii, 4; vi, 55; Luke v, 18; Acts v, 5, etc.) were movable (Becker, *Charicl.* ii, 72). —Winer, i, 178. See BED.

Coulon. See CULON.

Coulter occurs in 1 Sam. xiii, 20, 21, as the translation of פֶּלֶא (*eth*), an agricultural instrument, rendered elsewhere "plough-share" (Isa. ii, 4; Mic. iv, 3; Joel iii, 10), for which, however, a different word stands in the passage in 1 Sam. The Sept. renders it by the general term σείριος, *implement*, in 1 Sam., but *plough-share* in the other passages. The Rabbins understand it to be a *mattock*. It was probably the facing-piece or shoe of a plough, analogous to our coulter, as it was of iron, with an edge that required sharpening, and was easily transformed into a sword. Such an appendage to the plough, however, is not now in use in the East [see AGRICULTURE], but would be greatly needed in improved cultivation, considering the frail structure of the plough itself, the point being usually only of wood (see Wilkinson's *Ancient Egyptians*, ii, 14, 17). See PLOUGH.

Council is the rendering given by our translators chiefly to two Greek words.

1. Συμβούλιον (a *meeting of counsellors*) signifies a *consultation* of persons for executing any enterprise (Matt. xii, 14), a sense elsewhere covered by the usual translation "counsel;" also a *council*, or assembly of persons duly convened. In Acts xxv, 12, it is spoken of *counsellors*, i. e. persons who sat in public trials with the governor of a province; called also *conciliarii* (Suetonius, *Tib.* 83) or *assessores* (Lamprid. *Vit. Alex. Sev.* 46), in the regular proconsular "conventus." This last was a stated meeting of the Roman citizens of a province in the chief town, for the purpose of trying causes, from among whom the proconsul selected a number to try the cases in dispute, himself presiding over their action. From the instance in question, something analogous appears to have obtained under the procuratorship of Judæa (see Smith's *Dict. of Class. Ant.* s. v. *Conventus*). See ASIARCH; PROCURATOR.

2. Συνίδριον (a *sitting together*) signifies a formal assembly or *senate*, and in the N. T. is spoken only of Jewish "*councils*," by which word it is invariably rendered in the common version. These were: (1.) THE SANHEDRIM (q. v.), or supreme council of the nation. (2.) In the plural, the smaller *tribunals* in the cities of Palestine subordinate to the Sanhedrim (Matt. x, 17; Mark xiii, 9). See TRIAL. The distinction between these two grades of courts seems clearly alluded to in Matt. v, 22. See JUDGMENT. According to the Rabbins, these lower courts consisted of twenty-three judges, and the two in Jerusalem were held in the rooms over the Shushan and the Beautiful gates; but Josephus expressly says that the number of judges was seven (*Ant.* iv, 8, 14, 88; *War.* ii, 20, 5); and there are notices in the Talmud of arbitration courts of three judges (Jahn's *Archæol.* § 245). Perhaps the former two of these were but different forms of the same court in different places. See COURT, JUDICIAL. They appear to have been originally instituted by Moses (Deut. xvi, 18; 2 Chron. xix, 5), and to have had jurisdiction even over capital offences; although, under the civil supremacy of the Romans, their powers were doubtless much restricted. See

PUNISHMENTS. In the times of Christ and his apostles the functions of this court were probably confined chiefly to the penalty of excommunication [see ΑΝΑΘΗΜΑ] (John xvi, 2), although there are not wanting intimations of their inflicting corporal chastisement (2 Cor. xi, 24). See TRIBUNAL.

8. In the Old Testament "council" occurs in Psa. lxxviii, 27, as the rendering of פָּרְוֹה, *rigmah'* (literally a *heap*), a *throng* or company of persons. See COURTSEL.

4. In the Apocrypha, "council," in its ordinary sense, is the rendering of βουλή (1 Esth. ii, 17; 1 Macc. xiv, 22), σύμβουλοι (1 Esth. viii, 55), and βουλευόμενοι (2 Macc. ix, 58). See COUNSELLOR.

COUNCIL, APOSTOLICAL, at Jerusalem (Acts xv, 6 sq.). See APOSTOLICAL COUNCIL. Many writers, Protestants as well as Romanists, have regarded the assembly of the apostles and elders of Jerusalem, of which we read in Acts xv, as the first ecclesiastical council, and the model on which others were formed, in accordance, as they suppose, with a divine command or apostolic institution. But this view of the matter is unsupported by the testimony of antiquity, and is at variance with the opinions of the earliest writers who refer to the councils of the Church. Tertullian speaks of the ecclesiastical assemblies of the Asiatic and European Greeks as a human institution; and in a letter written by Firmilian, bishop of Caesarea, to Cyprian, about the middle of the third century, the same custom is referred to merely as a convenient arrangement existing at that time among the churches of Asia Minor for common deliberation on matters of extraordinary importance. Besides this, it will be found, upon examination, that the councils of the Church were assemblies of altogether a different nature from that of the apostles and elders; the only point in which the alleged model was really imitated being, perhaps, the form of preface to the decree, "It hath seemed good to the Holy Ghost and to us" (see the *Studien u. Kritiken*, 1842, i, 102 sq.). See DECREE (OF APOSTLES).

COUNCILS (Lat. *concilium*), assemblies of pastors or bishops for the discussion and regulation of ecclesiastical affairs.

1. The beginning of the system of church councils is traced to the gathering together of the apostles and elders narrated in Acts xv. This is generally considered to be the first council (see above); but it differed from all others in this circumstance, that it was under the special inspiration of the Holy Spirit. Roman Catholic writers speak of four Apostolical Councils, viz., Acts i, 18, for the election of an apostle; Acts vi, to choose deacons; Acts xv, the one above named; Acts xxi, 18 sq. But none of these had a public and general character except that in Acts xv (Schaff, *Hist. of Christian Church*, ii, § 66). Although the Gospel was soon after propagated in many parts of Europe, Asia, and Africa, there does not appear to have been any public meeting of Christians held for the purpose of discussing any contested point until the middle of the second century. From that time councils became frequent; but as they consisted only of those who belonged to particular districts or countries, they are usually termed *diocesan*, *provincial*, *patriarchal*, or *national* councils, in contradistinction to *ecumenical* or *general* councils, i. e. supposed to comprise delegates or commissioners from all the churches in the Christian world, and consequently supposed to represent the Church universal.

2. *Ecumenical Councils*.—The name *σύνδοδος οἰκουμένης* (*concilium universale* or *generale*) occurs first in the 6th canon of Constantinople, A.D. 381 (Schaff, l. c.). No such assembly was held, or could be held, before the establishment of the Christian religion over the ruins of paganism in the Roman Empire. Their title to represent the whole Christian world is not

valid. After the 4th century the lower clergy and the laity were entirely excluded from the councils, and bishops only admitted. The number of bishops gathered at the greatest of the councils constituted but a small portion of the entire episcopate of the world. The œcumenical councils which are generally admitted to bear that title most justly were rather Greek than general councils. In the strict and proper sense of the term, therefore, no œcumenical council has ever been held.

There are seven councils admitted by both the Greek and Latin churches as œcumenical. The Roman Catholics add twelve to the number, making nineteen, named in the following list. For details as to the doings of the councils, see the separate articles under each title in this Cyclopædia.

1. The synod of apostles in Jerusalem (Acts xv).
2. The first Council of Nice, held 325 A.D., to assert the Catholic doctrine respecting the Son of God in opposition to the opinions of Arius.
3. The first Council of Constantinople, convoked under the emperor Theodosius the Great (381 A.D.), to determine the Catholic doctrine regarding the Holy Ghost.
4. The first Council of Ephesus, convened under Theodosius the Younger (431 A.D.), to condemn the Nestorian heresy.
5. The Council of Chalcedon, under the Emperor Marcian (451 A.D.), which asserted the doctrine of the union of the divine with the human nature in Christ, and condemned the heresies of Eutyches and the Monophysites.
6. The second Council of Constantinople, under Justinian (553 A.D.), which condemned the doctrines of Origen, Arius, Macedonius, and others.
7. The third Council of Constantinople, convoked under the emperor Constantine V, Pogonatus (681 A.D.), for the condemnation of the Monothelite heresy.
8. The second Council of Nice, held in the reign of the empress Irene and her son Constantine (787 A.D.), to establish the worship of images. Against this council Charlemagne convened a counter synod at Frankfort (794 A.D.).
9. The fourth Council of Constantinople, under Basilius and Adrian (869 A.D.), the principal business of which was the deposition of Photius, who had intruded himself into the see of Constantinople, and the restoration of Ignatius, who had been its former occupant.
10. The first Lateran Council held in Rome under the emperor Henry V, and convoked by the pope Calixtus II (1123 A.D.), to settle the dispute on investiture (q. v.).
11. The second Lateran Council, under the emperor Conrad III and pope Innocent II (1139 A.D.), condemned the errors of Arnold of Brescia and others.
12. The third Lateran Council, convened by pope Alexander III (1179 A.D.), in the reign of Frederick I of Germany, condemned the "errors and impieties" of the Waldenses and Albigenses.
13. The fourth Lateran Council, held under Innocent III (1215 A.D.), among other matters asserted and confirmed the dogma of transubstantiation and necessity for the reformation of abuses and the extirpation of heresy.
14. The first œcumenical synod of Lyon, held during the pontificate of Innocent IV (1245 A.D.), had for its object the promotion of the Crusades, the restoration of ecclesiastical discipline, etc.
15. The second œcumenical synod of Lyon was held during the pontificate of Gregory X (1274 A.D.); its principal object was the reunion of the Greek and Latin churches.
16. The Synod of Vienne in Gaul, under Clemens V (1311 A.D.), was convoked to suppress the Knights Templars, etc.
17. The Council of Constance was convoked at the request of the emperor Sigismund, 1414 A.D., and sat for four years. It asserted the authority of an œcumenical council over the pope, and condemned the doctrines of John Huss and Jerome of Prague.
18. The Council of Basel was convoked by pope Martin V, 1430 A.D. It sat for nearly ten years, and purposed to introduce a reformation in the discipline, and even the constitution of the Roman Catholic Church. All acts passed in this council, after it had

been formally dissolved by the pope, are regarded by the Roman Catholic Church as null and void. 19. The celebrated Council of Trent, held 1545-1563 A.D. It was opened by Paul III, and brought to a close under the pontificate of Paul IV.

The Church of England (*Homily against the Peril of Idolatry*, pt. ii) speaks of "those six councils which were allowed and received of all men," viz., Nice, A.D. 325; Constantinople, A.D. 381; Ephesus, A.D. 431; Chalcedon, A.D. 451; Constantinople, A.D. 553; Constantinople, A.D. 680 (see *Amer. Quart. Christ. Review*, Oct. 1867, art. iv). The *Articles of Religion* (art. xxi) declare that "general councils may not be gathered together without the commandment and will of princes. And when they be gathered together (far as much as they be an assembly of men, whereof all be not governed with the Spirit and Word of God) they may err, and sometimes have erred, even in things pertaining unto God; wherefore things ordained by them as necessary to salvation have neither strength nor authority unless it may be declared that they be taken out of Holy Scripture."

The importance of the so-called œcumenical councils has been often greatly over-estimated, not only by the Greeks and Roman Catholics, but also by many Protestants. Jortin remarks, with his usual sharpness, that "they were a collection of men who were frail and fallible. Some of these councils were not assemblies of pious and learned divines, but cabals, the majority of which were quarrelsome, fanatical, domineering, dishonest prelates, who wanted to compel men to approve all their opinions, of which they themselves had no clear conceptions, and to anathematize and oppress those who would not implicitly submit to their determinations" (*Works*, vol. iii, charge 2).

The value of the decisions of the councils depends, not upon their authority, as drawn together at the call of emperor or pope, not upon the number of the bishops who attended them, but upon the truth of their decisions, and their conformity to the Word of God. The Councils of Nice and Chalcedon rendered great service to the Church and to theology; but their Christological statements of doctrine have been received by the general Church down to the latest times, not because they emanated from the councils, but because they satisfy the intellectual and moral needs of the Church, and are held to be true statements, though in more scientific form, of doctrines explicitly or implicitly contained in the Word of God. As to the earlier councils, it "must be remembered that the bishops of that day were elected by the popular voice. So far as that went, they truly represented the Christian people, and were but seldom called to account by the people for their acts. Eusebius felt bound to justify his vote at Nice before his diocese in Cæsarea. Furthermore, the councils, in an age of ecclesiastical despotism, sanctioned the principle of common public deliberation as the best means of arriving at truth and settling controversy. They revived the spectacle of the Roman senate in ecclesiastical form, and were the forerunners of representative government and parliamentary legislation" (Schaff, *History*, ii, § 65; also in *New Englander*, Oct. 1863, art. iv, and in *Jahrb. für deutsche Theologie*, 1863, ii).

The Romanists hold that the pope alone can convene and conduct œcumenical councils, which are supposed, on their theory, to represent the universal Church under the guidance of the Holy Ghost. In matters of faith, councils profess to be guided by the holy Scriptures and the traditions of the Church, while in lighter matters human reason and expediency are consulted. In matters of faith œcumenical councils are held to be infallible, and hence it is maintained that all such synods have agreed together; but in matters of discipline, etc., the authority of the latest council prevails. The Roman claim is not sustained by history. The emperors called the first seven councils.

and either presided over them in person or by commissioners; and the final ratification of the decisions was also left to the emperor. But the Greek Church agrees with the Latin in ascribing absolute authority to the decisions of truly oecumenical councils. Gregory of Nazianzus (who was president for a time of the second oecumenical council) speaks strongly of the evils to which such assemblies are liable: "I am inclined to avoid conventions of bishops; I never knew one that did not come to a bad end, and create more disorders than it attempted to rectify." A remarkable view of the authority of councils was that of Nicolas of Clamengis (q. v.), viz. that they, in his opinion, could claim regard for their resolutions only if the members were really believers, and if they were more concerned for the salvation of souls than for secular interests. His views on general councils were fully set forth in a little work entitled *Disputatio de concilio generali*, which consists of three letters, addressed, in 1415 or 1416, to a professor at the Paris University (printed apparently at Vienna in 1482). He not only places the authority of general councils over the authority of the popes, but the authority of the Bible over the authority of the councils. He doubts whether at all the former oecumenical councils the Holy Spirit really presided, as the Holy Spirit would not assist men pursuing secular aims. He denies that a council composed of such men represents the Church, and asserts that God alone knows who are his people and where the Holy Ghost dwells, and that there may be times when the Church can only be found in one maner *ecclesiam*. After the lapse of over 800 years, the pope in 1867 signified his purpose to summon another oecumenical council. Of course none but Romanist bishops will attend it.

3. *Provincial* councils have been too numerous to be mentioned here in detail. The most important of them are mentioned under the names of the places at which they have been held (e. g. Aix-la-Chapelle, Compiègne). Lists are given in most of the books on Christian antiquities, and in Landon, *Man. of Councils*.

4. The most important collections of the acts of the councils are Binius, *Concilia Generalia* (Cologne, 1606, 4 vols. fol.; 1618, 4 vols. fol.; Paris, 1688, 9 vols. fol.); the same, edited by Labbé and Cossart (Paris, 1671 sq., 17 vols., with supplement by Baluze, 1638, 1 vol. fol.); Hardouin, *Collectio Maxima Conciliorum*, etc. (Paris, 1715 sq., 12 vols. fol.); Coleti (Venice, 1728, 28 vols. 4to, with supplement by Mansi, 1748-52, 6 vols. going down to the year 1727); Mansi, *Sacr. Concil. nova et amplius. Collectio* (Florence, 1759-93, 81 vols. fol.). The abbé Migne proposes a complete collection, in 80 vols. There are special collections of the acts of national and provincial councils; e. g. for France, Sirmond (Paris, 1629), La Lande (Paris, 1666); for Spain, Aguirre (Madrid, 1781); for Germany, Binterim (Mainz, 1835-43, 7 vols.). Of manuals, histories of councils, etc., the following are the most important: Walch, *Kirchenversammlungen* (Leips. 1759); Grier, *Epitome of General Councils* (Dublin, 1828, 8vo); Landon, *Manual of Councils* (Lond. 1846), 12mo); Beveridge, *Synodicon, sive Pandectæ Canonum S. S. Apostolorum et Conciliorum* (Oxon. 1672-82, 2 vols. fol.); Hefele, *Conciliengeschichte* (Freiburg, 1855 sq., 6 vols. 8vo—yet unfinished). See also Gibbon, *Decline and Fall*, chap. xx; Lardner, *Works*, iv, 63; Elliott, *Delineation of Romanism*, bk. iii, ch. iii; Ferraris, *Promta Bibliotheca*, s. v. Concilium; Schaff, *History of the Christian Church*, vol. ii, § 65; James, *Corruptions of Scripture, Fathers, and Councils, by the Church of Rome* (Lond. 1688, 8vo); Comber, *Roman Forgeries in the Councils*, etc. (Lond. 1689, 4to); Browne, *On the Thirty-nine Articles*, Art. XXI; Palmer, *On the Church*, ii, 144; Cramp, *Text-book of Popery*, p. 474; Siegel, *Altkathemer*, iv, 406.

COUNCILS, ECCLESIASTICAL. See CONGREGATIONALISTS.

Counsel (prop. מַצְחָה, *etsah'*, βουλή). Beside the common signification of this word, as denoting the consultations of men, it is used in Scripture for the decrees of God, the orders of his providence. God frustrates the counsels, the views, the designs of princes; but "the counsels of the Lord stand for ever" (Psa. xxxiii, 11; cvii, 11; Luke vii, 30). See DECREE (of God).

COUNSELS, EVANGELICAL. See CONSILLA EVANGELICA.

Counsellor (usually מַצְחֵי, *gothé'*, σύμβουλος), an adviser upon any matter (Prov. xi, 14; xv, 22; 2 Chron. xxv, 16; Ezra iv, 5, etc.; Rom. xi, 84), especially the king's state counsellor (2 Sam. xv, 12; Ezra vii, 28; 1 Chron. xxvii, 38, etc.); hence one of the chief men of a government (Job iii, 14; xii, 17; Isa. i, 26; iii, 8, etc.), and once of the Messiah (Isa. ix, 5; Sept. σύμβουλος, Vulg. *consiliarius*). The Chaldee equivalent term is צַחֵי (*gath'*, Ezra vii, 14, 15). Other Chaldee terms thus rendered are חַדְדַּבְרִין (*haddaberin'*), ministers of state or *viziers* (Dan. iii, 24, 27; iv, 86; vi, 7), and דֶּחְבָּר (*dethabar'*, one skilled in law), a *judge* (Dan. iii, 2, 8). In the Apocrypha, σύμβουλος, in the ordinary sense of *adviser*, is thus rendered (Wisd. viii, 9; Eccus. vi, 6; xxxvii, 7, 8; xlii, 21); also *συμβουλευτής* (1 Esdr. viii, 11). In Mark xv, 43; Luke xxiii, 50, the Greek term βουλευτής, which is thus translated, probably designates a member of the Jewish Sanhedrim (q. v.) See COUNCIL.

Country. Heaven is called a *country* in the Bible, in allusion to Canaan. And it is a *better country*, as its inhabitants, privileges, and employments are far more excellent than any on earth (Heb. xi, 14, 16). It is a *far country*, very distant from and unknown in our world (Matt. xxi, 37, and xxv, 14; Luke xix, 12). A state of apostasy from God, whether of men in general or of the Gentile world, is called a *far country*; it is distant from that in which we ought to be; in it we are ignorant of God, exposed to danger, and have none to pity or help us (Luke xv, 18). A state or place of gross ignorance and wickedness is called the region and shadow of death (Matt. iv, 16).—Brown.

Coupling, חֻבְרָה, *chobe'reth*, a *junction*, of curtains (Exod. xxvi, 4, 10; xxxvi, 17), i. q. מַחְבְּרֵי, *machebe'reth* (Exod. xxvi, 4, 5, etc.); but מַחְבְּרֵי, *macheberoth'*, means wooden *bracers* (? girders) for fastening a building (2 Chron. xxxiv, 11), or iron *cramps* for holding stones together ("joinings," 1 Chron. xxii, 8).

Courayer, PETER FRANCIS, an eminent and liberal Roman Catholic divine, born at Vernon, in Normandy, in 1681, was a canon and librarian of St. Genevieve, and a professor of theology and philosophy. Having written a *Defence of the Validity of English Ordinations* (Brux. 1723, 2 vols. 8vo), he was so persecuted that he took refuge in England in 1728, where he entered the English Church, obtained a pension, and died in 1776. He translated into French Sarpi's History of the Council of Trent, and Sleidan's History of the Reformation, and wrote several tracts. His *Disputation on English Ordinations* was republished at Oxford, 1844, 8vo. His edition of Sarpi is better than any other (Lond. 1786, 2 vols. fol.).

Courier. See POST.

Course (ἐφημερία, *daily order*, Luke i, 5, 8). See ABLJAH 4.

Court, an open enclosure, applied in the A. V. most commonly to the enclosures of the Tabernacle and the Temple. 1. The Hebrew word invariably used for the former is חֲצַר, *chatsar'*, from חָצַר, to surround (Gesenius, *Theas. Heb.* p. 512). (See, e. g., Exod. xxvii, 9 to xl, 88; Lev. vi, 16; Num. iii, 26, etc.) The same word is also most frequently used for the "courts" of the Temple, as 1 Kings vi, 86; vii, 8;

xxiii, 12; 1 Chron. xxxiii, 5; Ps. xcii, 18, etc. See TABERNACLE; TEMPLE. The same word is very often employed for the enclosures of the "villages" of Palestine, and under the form of *Haser* or *Hazor* (q. v.) frequently occurs in the names of places in the A. V. See VILLAGE. It also designates the court of a prison (Neh. iii, 25; Jer. xxxii, 2, etc.), of a private house (2 Sam. xvii, 18), and of a palace (2 Kings xx, 4; Esth. i, 5, etc.). In Isa. xxxiv, 19, "court for owls," the cognate חֲצִיר, *chatsir*, is found. 2. In 2 Chron. iv, 9, and vi, 18, however, a different word is employed, apparently, for the above sacred places—*oratria*, חֲצִירֹת, *asarak*, from a root of similar meaning. This word also occurs in Ezek. xliii, 14, 17, 20; xlv, 19 (A. V. "settle"), but apparently with reference to the ledge or offset of the altar (q. v.) 3. In Amos vii, 13, where the Hebrew word is בַּיִת, *beyth*, a "house," our translators, anxious to use a term applicable specially to a king's residence, have put "court." 4. In the Apocrypha *αὐλή* is rendered "court" with respect to the Temple (1 Esdr. ix, 1; 1 Macc. iv, 38; ix, 54), or the palace (1 Macc. xi, 46), which latter is expressed also (1 Macc. xiii, 40) by a periphrasis (*τὰ περὶ ἡμῶν*). 5. In the N. T. the word *αὐλή* designates such an open court (as it is once rendered, Rev. xi, 2, referring to the temple; elsewhere "hall" or "palace"); and βασιλεία, a *palace*, is once (Luke vii, 25) rendered "kings' courts." See PALACE.

The term חֲצִירֹת, *ta'asak* (fully חֲצִירֹת חֲצִיר, *middle of the house*, 1 Sam. iv, 6), also designates in Hebrew the quadrangular area in Eastern houses, denominated in the New Testament τὸ μέσον, the centre or "midst" (Luke v, 19). This court is sometimes paved with marble of various kinds, and in the centre there is usually a fountain, if the situation of the place admits of it. The court is generally surrounded on all sides, but sometimes only on one side, with a cloister or covered walk, called מִטְצָה, *musak*, over which, if the house have more than one story, is a gallery of the same dimensions, supported by columns. Large companies were received into the court on particular occasions (Esth. i, 5; Luke v, 19). At such times, a large veil of thick cloth was extended by ropes over the whole of the court, in order to exclude the heat of the sun. This veil or curtain of the area may be that termed in the New Testament στέγη, covering, or "roof" (Mark ii, 4; Luke vii, 6). See HOUSE.



Court-yard of an Oriental House.

COURT, JUDICIAL. Among the Jews, besides the Sanhedrim (q. v.), or great "council" (q. v.), there were lesser courts (*συμβουρία*, Matt. x, 17; Mark xiii, 9), of which there were two at Jerusalem, and one in each town of Palestine. The constitution of these

courts is a doubtful point. According to Talmudical writers, the number of judges was twenty-three in places where there was a population of 120, and three where the population fell below that number (*Mishna Sanhedr.* i, 6). Josephus, however, gives a different account; he states (*Ant.* iv, 8, 14) that the court, as constituted by Moses (Deut. xvi, 18), consisted of seven judges, each of whom had two Levites as assessors; accordingly, in the reform which he carried out in Galilee, he appointed seven judges for the trial of minor offences (*War*, ii, 20, 6). The statement of Josephus is generally accepted as correct; but it should be noticed that these courts were not always in existence. They may have been instituted by himself on what he conceived to be the true Mosaic model: a supposition which is rendered probable by his further institution of a council of Seventy, which served as a court for capital offences, altogether independent of the Sanhedrim at Jerusalem (*Life*, 14; *War*, ii, 20, 5). The existence of local courts, however constituted, is clearly implied in the passages quoted from the N. T.; and perhaps the *judgment* (Matt. v, 21) applies to them. See MARKET. Under the Roman government there was a provincial court (*συμβούλιον*, Acts xxv, 17), a kind of jury or privy council, consisting of a certain number of assessors (*consularis*, Sueton. *Tib.* 33, 55), who assisted the procurators in the administration of justice and other public matters.—Smith, a. v. Council. See JUDGE.

COURT, ROYAL. The natives of the East have ever been remarkable for a more reverential estimation of the state and dignity of a king than has usually prevailed among other people, and to this fact the language of Scripture bears ample testimony. Although on some special occasions we read of the Jewish monarchs sitting in the gate with their people (2 Sam. xix, 8; Jer. xxxviii, 7), and the prophets appear to have had easy access to them (1 Kings xx, 13; 2 Chron. xxv, 15), yet it is abundantly evident that regal state was, in general, fully maintained, with only that admixture of occasional intercourse and familiarity which may be noticed by every traveller at the present day in the East. Hence it was accounted the height of human felicity to be admitted into that splendid circle which surrounded the person of the sovereign, and they seem to have considered it a good omen if any one was so fortunate as to behold the face of the king (*Prov.* xxix, 26); whence the expression of seeing

God (Matt. v, 8) is to be understood as the enjoyment of the highest possible happiness, such as his favor and protection, especially in the life to come. In reference to this custom, the angel Gabriel replied to Zacharias that he was Gabriel that stood in the presence of God; thus intimating that he was in a state of high favor and trust (Luke i, 19). Hence to "stand before the king" is a phrase which intended the same as to be occupied in his service, and to perform some duty for him (*Gen.* xli, 46; 1 Sam. xxii, 6, 7), and imported the most eminent and dignified station at court. This illustrates the statement of Christ respecting children, "In heaven their angels do always behold the face of my Father

which is in heaven" (Matt. xviii, 1-10), an allusion to the custom of Oriental courts, where the great men, those who are highest in office and favor, are most frequently in the prince's palace and presence (*Esth.* i, 14; 1 Kings x, 8; xii, 6; 2 Kings xxv, 19). In like

manner, the contentions among the apostles for the chief position under Christ shows that they mistook the spiritual nature of his kingdom; the request of the mother of James and John, that her sons might sit, the one on his right hand, and the other on his left, in his kingdom (Matt. xx, 20-28), evidently alludes to the custom which then obtained in the courts of princes, where two of the noblest and most dignified personages were respectively seated, one on each side, next the sovereign himself, thus enjoying the most eminent places of dignity (1 Kings ii, 19; Psa. xlv, 9; Heb. i, 8). See KING.

COURT, ANTOINE, an eminent French Protestant divine, was born in 1696 at Villeneuve-de-Berg (according to others at La Tour d'Aigues), in Vivarais. After the revocation of the Edict of Nantes in 1685, the French Protestant Church was in danger of self-destruction through fanaticism. Under these circumstances, Court, in the synods of Delphinat in 1716 and of Languedoc in 1717, laid the foundation for an ecclesiastical constitution, based upon the old discipline of the French Church. In so doing he met great opposition, and even encountered personal peril, yet his work went on. To obviate the difficulty of intrusting the functions of the sacred office to persons lacking the proper ordination, he sent one of his colleagues to Zurich to receive it, and the latter imparted it to the others in a synod held in 1718. With the aid of the government of Berne and the archbishop of Canterbury, Court established in 1729 a seminary at Lausanne, where ministers were prepared for the churches "of the Desert," as they were called, very appropriately. All the ecclesiastical papers were dated from "the Desert." The duke of Orleans, while regent, was allied with England against Spain, and sought to induce Court to leave France, but the latter remained at his post until his death in 1760. Court wrote *Histoire des troubles des Cévennes*, Geneva, 1760, 3 vols. 12mo; Alais, 1819, 3 vols.; *Le Patriote français et impartial, ou Réponse à la lettre de M. l'Evêque d'Agén à M. le contrôleur-général contre la tolérance des Huguenots* (Villefr. Genève, 1751, 1753); *Lettre d'un patriote sur la tolérance civile des Prot. de France* (1765), etc. Weiss gives an account of numerous MS. writings of Court (preserved in the Geneva library) in his *Histoire des Réfugiés*, ii, 288 (see Camilsards). See also Coquerel, *Histoire de l'Eglise du Désert*; Peyrat, *Hist. des Pasteurs, du Désert*; Haag, *La France Prot.* (Paris, 1854); *Bulletin de la Soc. de l'Hist. de Prot. Fr.*; R. Sayons, *Hist. de la Littérature Française à l'Etranger*, i, 304, 313; Herzog, *Real-Encyclop.* s. v.

Courtesy. Orientals are much more studious of politeness in word and act than Europeans (Niebuhr, *Beschr.* p. 49; Arvieux, iii, 807). So were undoubtedly the ancient Hebrews. Inferiors in an interview with superiors (both on meeting and separating, 2 Sam. xviii, 21) were wont to bow (וַיִּשְׁתַּחֲוּי, προσκυνεῖν; see Kästner, *De generatione in S. S.* Lips. 1735) low (Gen. xix, 1; xxlii, 7; 2 Sam. ix, 6; xviii, 21), in proportion to the rank towards the earth (even repeatedly, Gen. xxxiii, 8; 1 Sam. xx, 41). In the presence of princes, high civil officers, etc., persons threw themselves prostrate (at their feet) upon the ground (נָפַל עַל אַרְצוֹתָם אֲנִיִּם אֲרָצָה, Gen. xlii, 6; נָפַל עַל פְּתֵי־יְהוָה, 1 Sam. xxv, 23; 2 Sam. xiv, 4; 1 Kings xviii, 7; comp. Judith x, 21; נָפַל עַל אַרְצוֹ, Gen. xlv, 14; 1, 18; 2 Sam. i, 2; also simply נָפַל לְפָנָיו, 2 Sam. xix, 19; comp. Matt. ii, 11; Herod. i, 184; ii, 80; see Hyde, *Rel. vet. Pers.* p. 6 sq.; Harmer, ii, 89 sq.; Kype, *Observ.* i, 8, 410; Ruppell, *Abyss.* i, 217; ii, 94). They also bent the knee (2 Kings i, 18; comp. Matt. xxvii, 20; Acts x, 25). Of other gestures, which in the modern East are customary (Harmer, ii, 84; Shaw, *Trav.* p. 207; Niebuhr, *Trav.* i, 262), e. g. laying the

hand on the breast, there is no trace in the Bible. If an inferior mounted on a beast met a superior, he quickly alighted (Arnob. vii, 18; see Orelli ad loc.), and made the due obeisance (Gen. xxiv, 64; 1 Sam. xxv, 28; see Niebuhr, *Beschr.* p. 44, 50; *Trav.* i, 139). Whether in such cases an individual turned out of the road, like the ancient Egyptians (Herod. ii, 80) and modern Arabians (Niebuhr, *Beschr.* p. 60), is uncertain, but probable. On the greeting by a kiss, which, however, does not appear to have been so usual or varied as among the modern Orientals (see Herod. i, 184; Harmer, ii, 86 sq.; Burckhardt, *Arab.* p. 229), see KISS. Rising from a sitting posture before persons entitled to respect, such as elders, was early universal (Lev. xix, 82; Job xxix, 8; comp. Porphyr. *Abstém.* ii, 61). See ELDER. Forms of salutation on meeting or entrance consisted of a pious expression of well-wishing (Gen. xliii, 29; 1 Sam. xxv, 6; Judg. vi, 12; 2 Sam. xx, 9; Psa. cxxix, 8; see Harmer, iii, 172) and inquiries concerning the health of the family (2 Kings iv, 26; hence וְשָׁלוֹם לְאֵלֶיךָ = to greet, Exod. xviii, 7; Judg. xviii, 15; 1 Sam. x, 4; comp. Genesius, *Theo. Heb.* p. 1847). One of the simplest formulæ was "Jehovah be with thee;" to which was replied, "The Lord bless thee;" (Ruth ii, 4). Among the later Jews, the phrase וְיֵשׁוּעָה, "May it go well with thee," was general (Lightfoot, p. 502). With the modern Arabs the expression of salutation, *Salam aleykum*, "Peace be upon you," and the reply, *Aleykum es-Salam*, "On you be peace," are customary (Niebuhr, *Beschr.* p. 48 sq.; Welsted, *Trav.* i, 242). The Heb. equivalent, וְשָׁלוֹם לְךָ, "Peace to thee," does not appear in the O. T. (Judg. xix, 20; 1 Chron. xii, 18) as a constant form of salutation (yet comp. Luke xxiv, 36; John xx, 26; also Tobit v, 12; and comp. on this Purman's *Expositio form. salud.* "Pax Vobiscum," *Fract.* a. M. 1799). The Punic greeting was *Avu* (וְיָוִי) or *Avu domni* (וְיָוִי אֲדֹנָי), according to Plautus (*Pœn.* v, 2, 84, 88; comp. *Αὔδωνος*, *Anthol. Gr.* iii, 25; epigr. 70). Persons were also sent on their way with a similar formula (Tob. v, 28). But besides such set terms, individuals meeting one another made use of verbose methods of inquiring after each other's circumstances (as appears from the prohibition in 2 Kings iv, 29; Luke x, 4; see Niebuhr, *Beschr.* p. 49; Arvieux, iii, 162; Russel, *Alleppe*, i, 229; Jaubert, p. 170; Ruppell, *Abyssin.* i, 208). See SALUTATION. Whether the well-known custom among the Greeks and Romans (Homer, *Odyss.* xvii, 541; Pliny, xxviii, 5; Petron. 98) of wishing well to one who sneezed (which was regarded as ominous, Eustath. *ad Odyss.* xvii, 545; Cicero, *Divin.* ii, 40; Pliny, ii, 7; Xenoph. *Anab.* iii, 2, 9; Propert. ii, 2, 84; Augustine, *Doctr. Chr.* i, 20; comp. Apulei *Metam.* 9, p. 209, ed. Bip.; Harduin *ad Plin.* xxviii, 5; see Wernsdorf, *De ritu sternutantis bene precandis*, Lips. 1741; Rhan, *De more sternutantis salutem approcandis*, Tigr. 1742), prevailed also among the Israelites, is uncertain; the later Jews observed it, and the Rabbins maintain that it was an ancient usage (Buxtorf, *Synag.* p. 129).

In conversation (q. v.) the less important person spoke of himself in the third person, and styled himself the other's servant (Gen. xviii, 8; xix, 2; xxxiii, 5; xliii, 28; Judg. xix, 19) and the other master (Gen. xxiv, 18; 1 Sam. xxvi, 18, etc.). Sometimes he applied, by way of further abasement, epithets (e. g. dog) of disparagement to himself (2 Sam. ix, 8; 2 Kings viii, 18; comp. Oedmann, *Samml.* v, 42 sq.). The usual title of respect was אֲדֹנָי, "My lord" (later שֵׁרֵי); other respectful terms were also אָבִי, "My father" (especially to prophets, 2 Kings v, 18; vi, 21; xiii, 14; comp. the Romanist title "father" for priest); on the later name, רַבִּי, "My master," see RABBI. The later Jews seem to have utterly excluded, in their bigotry, the heathen from all salutation (Matt. v, 47?), as now,

in Syria and Egypt, Mohammedans and Christians hardly deign to greet each other (Harmer, ii, 35). The public sentiment of those times also released holy persons (saints) from the obligation of returning complimentary salutations (Lightfoot, p. 787), which, however, they eagerly claimed (Mark xii, 38; Luke xi, 43; xx, 46). The right side was regarded as the place of honor in standing or sitting by the Hebrews from early times (1 Kings ii, 19; Psa. xlv, 10; Matt. xxv, 33; comp. Sueton. *Ner.* 18, see Douglæs *Anal.* i, 169 sq.; Wetstein, i, 456, 512; Einigh, *De manu dextra honoratiore*, Lips. 1707). Public reverence and homage toward monarchs, generals, etc., consisted in shouts (among others the cry huzza, הוֹרֵא הוֹרֵא , "Long live the king!" Barhebr. *Chron.* p. 447) of acclamation (Josephus, *Ant.* xi, 8, 5; *War.* vii, 5, 2; Ammian. Marc. xxi, 10; Philo, ii, 522), with music (2 Sam. xvi, 16; 1 Kings i, 39, 40; 2 Kings ix, 13; Judith iii, 8; comp. Herodian, iv, 8, 19); also in strewing carpets or garments along the road (comp. *Æschyl. Agam.* 909; Plutarch, *Cato min.* c. 12; Talmud, *Chetaboth*, fol. lxvi, 2; as still is practised in Palestine, Robinson, ii, 888), with branches (see Ugolini *Theaur.* xxx) or flowers (2 Kings ix, 13; Matt. xxi, 8; comp. Curtius, v, 1, 20; ix, 10, 25; Herod. vii, 54; *Ælian, Var. Hist.* ix, 9; Tacitus, *Hist.* ii, 70; Herodian, i, 7, 11; iv, 8, 19; see Douglæs *Analect.* iii, 39; Paulsen, *Regier. des Morgenl.* p. 229 sq.), and in torchlight entrances at night (2 Macc. iv, 22). Festive escorts in procession (with the priests at the head) were also not unusual (Josephus, *Ant.* xi, 8, 5; xvi, 2, 1; see Schmieder, *De solemnitat. vet. reges imperatoresq. recipiend.*, Brig. 1823).—Winer, i, 500. See also GIFT; VISIT.

Cousin is given (Luke i, 86, 58) by the Auth. Vers. in its vague acceptance as the rendering of *συγγενής*, a blood-relative, or "kinsman," as elsewhere translated. So also in the Apocrypha (1 Esdr. iii, 7; iv, 42; Tob. vi, 10; 2 Macc. xi, 1, 35).

Cousin, VICTOR, an eminent philosopher and writer, was born in Paris November 28, 1792, and was educated at the Lycée Charlemagne, where, at sixteen, he gained the grand prize of honor. Soon after he was admitted into the *École Normale*, where he became *répétiteur*, or private teacher of Greek literature, and afterwards professor of philosophy. "In 1811 he attended the lectures of Laromiguière (q. v.), whose theory was a mixture of Condillac and Descartes, of sensation and spiritualism, and who made it his mission to reconcile the two systems. Cousin was at first fascinated by this theory, and still more by the elegant phraseology and lucid exposition of the lecturer. It was very probably at the same period that his great idea first presented itself to his mind, 'that each system is true, but incomplete, and that by collecting all the systems together a complete philosophy would be obtained.' In 1813 and 1814 he attended the courses of philosophical lectures delivered at the *Faculté des Lettres* by Royer-Collard, whose earnest mind had long distinguished that school of sensation which Locke and Condillac had established in the 18th century, and who had sought refuge from these doubts in the doctrines of the Scotch system. This doctrine, which insisted that there were notions in the mind totally independent of the senses, was ardently embraced by Cousin, who became lecturer at the *Faculté des Lettres*, and began his famous course of the History of Philosophy December 7, 1815. Having learned to doubt from Royer-Collard, he resolved to examine in turn all the great philosophers, both ancient and modern, before he formed his opinions. He became a universal inquirer. He professed to judge without prejudice each philosopher, and in each he believed he had found a system, and in each system a fragment of truth. As fast as he proceeded in this inquiry he communicated what he had found to the public, sometimes in lectures, at other times in books. To enable

his pupils to judge for themselves, he published the works of Plato, the inedited works of Proclus, and an edition of Descartes, though the whole did not appear till after his demise. His translation of Plato in 18 vols. would preserve his name had he done nothing else" (*English Cyclopædia*). The government dismissed him from the Faculty of Letters in 1821, and in 1824 he went to Germany as tutor to the young Duke of Montebello. "During his progress the frank opinions he expressed excited the suspicion of the Prussian authorities, who caused him to be arrested and conveyed to Berlin, where he was thrown into prison as an agitator. He remained in close confinement for six months. After his return he published, in 1826, his celebrated *Fragments Philosophiques*, with a remarkable preface, which is still considered the best summary of his particular doctrine." In 1828 he recommenced lectures on Philosophy at the *Faculté des Lettres*. His former lectures had consisted principally of the history of ideal truth, as it had been explained by the great thinkers who had preceded him. But this time his own theory was exhibited. The first series was published in 1828, under the title of *Cours d'Histoire de la Philosophie*; the second in 1829, as *Cours de Philosophie*. Soon after, the accession of Louis Philippe introduced his friends Gairoz and De Broglie to power. He now became a councillor of state, a member of the Board of Public Education, an officer of the Legion of Honor, and a peer of France, in quick succession. In 1831 he was commissioned by the ministry to proceed to Germany to examine the state of education in that country. The results were given to the world in 1832, *Rapport sur l'état de l'instruction publique dans quelques pays de l'Allemagne* (translated by Mrs. Austin, and published in London in 1834). He succeeded Fourier in the Academy, and delivered his *loge*, or reception address, May 5, 1831. He seldom spoke in the Chamber of Peers, and when he did it was almost invariably on the subject of National Instruction. On March 1, 1840, Cousin entered the liberal cabinet of Thiers as minister of Public Instruction. He introduced a number of reforms during his administration, which lasted eight months, and of which he published himself a review in the *Revue des deux Mondes* in 1841. In 1848 M. Cousin seemed cordially to accept the introduction of the republic, and when General Cavaignac appealed to the Academy of Moral and Political Sciences to aid the government in the enlightenment of the people, Cousin published, with a republican preface, a popular edition of the *Profession de foi du vicairé savoyard*. He subsequently wrote, under the title of *Justice et Charité*, a pamphlet against the socialistic tendencies. But after 1849 Cousin altogether withdrew from public life. He published, besides the works already mentioned, among others, *Procli Opera*, 6 vols. 8vo, 1820-27; *Descartes, Œuvres Complètes*, 11 vols. 8vo; *Abélard, Sic et non*, 1836; several series of *Fragments Philosophiques*, 1838-40; *Hist. de la Philosophie* (1st series, 5 vols. 8vo; 2d, 3 vols. 8vo; 3d, 4 vols. 8vo); *Du Vrai, du Beau, du Bien* (1853, 8vo, a republication of his lectures delivered between 1815 and 1821); *Cours de Philosophie Morale*, 5 vols. 1840-41. A collected edition of his principal works (up to 1846) in 22 vols. 18mo, was published in 1846-47. From 1858 to 1864 he published a series of works on celebrated literary women of the 17th century, which are an important contribution to the history of that time, and found a large circulation. The series comprises *Jacqueline Pascal* and *Mad. de Longueville* (1853), *Mad. de Sablé* (1854), *Mad. de Chevreuse* et *Mad. de Hautfort* (1856); *La Société Française au XVII^e Siècle* (1858, 2 vols.); *La Jeunesse de Mad. de Longueville* (1864, 4th edit.); *la Jeunesse de Mazarin* (1865). In 1863 he published *Histoire Générale de la Philosophie depuis les temps les plus reculés jusqu'au XVIII^e siècle* (1863), being a revised edition of his *Cours de l'histoire de la philosophie*. Cousin was also a

frequent contributor to some of the leading periodicals of France, such as the *Revue des Deux Mondes*, the *Journal des Savants*, and others. A kind of Gallican catechism, published anonymously in 1838, under the title *Livre d'instruction morale et religieuse*, has also been ascribed to Cousin. He died in January, 1867.

Cousin undoubtedly rendered great service to modern thought by his advocacy of "spiritualism" (spiritualist philosophy) as opposed to materialistic doctrines. In the preface to *De Vrai, du Beau, du Bien*, he thus expresses himself (1853): "Our true doctrine, our true standard, is spiritualism; the philosophy, generous and solid at the same time, that commences with Socrates and Plato, that the Gospel spreads over the world, that Descartes forced into the severer forms of the genius of modern times. The name of spiritualism is properly given to this philosophy, for its character is that it subordinates the senses to the spirit, and that, by all means which reason can avow, it perpetually tends to elevate man and make him greater. Spiritualism teaches the immortality of the soul, the freedom and responsibility of human action, the obligation of morality, the virtue of disinterestedness, the dignity of justice, the beauty of charity; and, beyond the limits of this earth, spiritualism points to God, the Creator and the Type of humanity, who, having created man evidently for an excellent end, will not abandon him during the mysterious development of his destiny."

As to *method*, Cousin follows the psychological rather than the *a priori* method, but he avoids carefully the views of Locke and the sensationalists. His psychology is idealistic, his ontology also. What he calls "spontaneous reason" acquaints us with the "true and essential nature of things." In place of "commencing, as the Germans do, with ontology, he affirms the possibility of finding a passage from the world of phenomena to real existence. Since reason receives truth spontaneously, by direct and immediate perception, he considers that we may, by means of this faculty, attain to the knowledge of essential and absolute existence" (Morell, *Hist. of Mod. Philos.* pt. ii, ch. viii). The tendency of this view to pantheism has been shown by many writers, especially by Gioberti (*Considerations sur les doctrines religieuses de M. Victor Cousin*, transl. by Tourneur, Paris, 1847, 8vo). Cousin himself always strenuously repudiated the name of pantheist. It is certain that towards the end of his career he "sought more and more the support of the great Christian masters, and drew daily nearer to Pascal, Descartes, and Leibnitz" (*North British Review*, March, 1867, art. v). Of translations of his works, we have, by Daniel, *The Philosophy of the Beautiful* (N. Y. 1849, 8vo); by Wight, *History of Modern Philosophy* (N. Y. 2 vols. 8vo, 1852); by the same, *Lectures on the True, the Beautiful, and the Good* (N. Y. 1854, 8vo); by Henry, *Psychology, including an Examination of Locke's Philosophy* (N. Y. 4th ed., 1856, 8vo). — *English Cyclopaedia*, s. v.; Vapereau, *Dict. des Contemporains*, 1865; Lewes, *History of Philosophy* (Lond. 2 vols. 1867), ii, 645; *Christian Spectator*, vii, 89, *North American Review*, liii, 1; lxxxv, 19; *Edinb. Review*, l, 194 (art. by Sir W. Hamilton); *Brit. Quart. Review*, v, 289; *Westminster Review*, Oct. 1858; Ripley, *Specimens of Foreign Literature*, vol. i; Alaux, *La Philosophie de Cousin* (Paris, 1864).

Cou'tha (Κουθά, Vulg. *Phusa*), named (1 Eedr. v, 32) as one of the heads of the Temple-servants whose "sons" returned from Babylon; but the Hebrew lists (Ezra ii, 58; Neh. vii, 55) contain no corresponding name.

Covel, James, Jr., a Methodist Episcopal minister, was born at Marblehead, Mass., Sept. 4, 1796, became a travelling preacher in 1816, and travelled chiefly in the state of New York. He was the author of a *Dictionary of the Bible* (18mo), and was a man of sound

judgment, sincere piety, and steady industry. From 1838 he was appointed principal of the Troy Conference Academy, and filled the post acceptably until 1841. His last station was State Street, Troy, where he died, May 15, 1845. — *Minutes of Conferences*, iii, 600; Sprague, *Annals*, vii, 564.

Covel, John, an English divine, was born at Horningsheath, Suffolk, in 1688, and was educated at Christ's College, Cambridge, of which he became fellow. In 1670 he went to Constantinople as chaplain to the British embassy. In 1687 he was made chancellor of York, and in 1688 master of Christ's College, Cambridge. He died in 1722. As the fruit of his residence in Constantinople, he wrote *Some Account of the present Greek Church, with Reflections on their present Doctrine and Discipline*, etc. (Camb. 1722, fol.).

Covenant, a mutual contract or agreement between two parties, each of which is bound to fulfil certain engagements to the other. In Scripture it is used mostly in an *analogical* sense, to denote certain relations between God and man. (See *Danville Review*, March, 1862.)

I. Terms.—In the Old Test. בְּרִית, *berith'* (rendered "league," Josh. ix, 6, 7, 11, 15, 16; Judg. ii, 2; 1 Sam. iii, 12, 13, 21; 2 Sam. v, 3; 1 Kings v, 12; xv, 19, twice; 2 Chron. xvi, 8, twice; Job v, 23; Ezek. xxx, 5; "confederacy," Obad. 7; "confederate," Gen. xiv, 13; Psa. lxxxiii, 5), is the word invariably thus translated (Sept. διαθήκη; once, Wisd. i, 16, συνθήκη; Vulg. *foedus, pactum*, often interchangeably, Gen. ix, xvii; Num. xxv; in the Apocrypha *testamentum*, but *sacramentum*, 2 Eedr. ii, 7; *sponsiones*, Wisd. i, 16; in N. T. *testamentum* [*absque foedere*, Rom. i, 81; Gr. *συνθήκων*]). The Hebrew word is derived by Gesenius (*Theo. Heb.* p. 237, 238; so Fürst, *Hebr. Handw.* p. 217) from the root בָּרָה, i. q. בָּרָא, "he *cu*," and taken to mean primarily "a cutting," with reference to the custom of cutting or dividing animals in two, and passing between the parts in ratifying a covenant (Gen. xv; Jer. xxxiv, 18, 19). Hence the expression "to cut a covenant" (בָּרָה בְּרִית, Gen. xv, 18, or simply בָּרָה, with בְּרִית understood, 1 Sam. xi, 2) is of frequent occurrence. (Comp. ὄρκια ἔμμεναι, ῥίμνευαι σπονδάς, *icere, ferire, percutere foedus*. See Slevoigt, *De more Ebraeor. dissectione animalium foedera ineundi*, Jen. 1759.) Professor Lee suggests (*Heb. Lex.* s. v. בְּרִית) that the proper signification of the word is *an eating together, or banquet*, from the meaning "to eat," which the root בָּרָה sometimes bears; because among the Orientals to eat together amounts almost to a covenant of friendship. This view is supported by Gen. xxxi, 46, where Jacob and Laban eat together on the heap of stones which they have set up in ratifying the covenant between them. It affords also a satisfactory explanation of the expression "a covenant of salt" (בְּרִית מֶלַח, διαθήκη ἄλας, Num. xviii, 19; 2 Chron. xiii, 5), when the Eastern idea of eating salt together is remembered. If, however, the other derivation of בְּרִית be adopted, this expression may be explained by supposing salt to have been eaten or offered with accompanying sacrifices on occasion of very solemn covenants, or it may be regarded as figurative, denoting, either, from the use of salt in sacrifice (Lev. ii, 13; Mark ix, 49), the sacredness, or, from the preserving qualities of salt, the perpetuity of the covenant. (See below.)

In the New Test. the word διαθήκη is frequently, though by no means uniformly, translated *testament* in the English Auth. Vers., whence the two divisions of the Bible have received their common English names. This translation is perhaps due to the Vulgate, which, having adopted *testamentum* as the equivalent for διαθήκη in the Apocrypha, uses it always as such in the N. T. (see above). There seems, how-

ever, to be no necessity for the introduction of a new word conveying a new idea. The Sept. having rendered בְּרִית (which never means *will* or *testament*, but always *covenant* or *agreement*) by διαθήκη consistently throughout the O. T., the N. T. writers, in adopting that word, may naturally be supposed to intend to convey to their readers, most of them familiar with the Greek O. T., the same idea. Moreover, in the majority of cases, the same thing which has been called a "covenant" (בְּרִית) in the O. T. is referred to in the N. T. (e. g. 2 Cor. iii, 14; Heb. vii, ix; Rev. xi, 19); while in the same context the same word and thing in the Greek are in the English sometimes represented by "covenant," and sometimes by "testament" (Heb. vii, 22; viii, 8-13; ix, 15). In the confessedly difficult passage, Heb. ix, 16, 17, the word διαθήκη has been thought by many commentators absolutely to require the meaning of *will* or *testament*. On the other side, however, it may be alleged that, in addition to what has just been said as to the usual meaning of the word in the N. T., the word occurs twice in the context, where its meaning must necessarily be the same as the translation of בְּרִית, and in the unquestionable sense of *covenant* (comp. διαθήκη καινή, Heb. ix, 15, with the same expression in viii, 8; and διαθήκη, ix, 18, 17, with ver. 20, and Exod. xxiv, 8). If this sense of διαθήκη be retained, we may either render ἐπι νεκροῖς, "over, or in the case of, dead sacrifices," or ὁ διαθίμενος, "the mediating sacrifice" (Scholefield's *Hints for an improved Translation of the N. T.*), or (with Ebrard and others) restrict the statement of ver. 16 to the O.-T. idea of a covenant between man and God, in which man, as guilty, must always be represented by a sacrifice with which he was so completely identified that in its person he (ὁ διαθίμενος, the human covenantor) actually died (comp. Matt. xxvi, 26). See TESTAMENT.

II. *Their Application.*—In its Biblical meaning of a compact or agreement between two parties, the word "covenant" is used—1. *Properly, of a covenant between man and man*; i. e. a solemn compact or agreement, either between tribes or nations (1 Sam. xi, 1; Josh. ix, 6, 15), or between individuals (Gen. xxi, 44), by which each party bound himself to fulfil certain conditions, and was assured of receiving certain advantages. In making such a covenant God was solemnly invoked as witness (Gen. xxxi, 50), whence the expression "a covenant of Jehovah" (בְּרִית יְהוָה), 1 Sam. xx, 8; comp. Jer. xxxiv, 18, 19; Ezek. xvii, 19), and an oath was sworn (Gen. xxi, 31); and accordingly a breach of covenant was regarded as a very heinous sin (Ezek. xvii, 12-20). A sign (אוֹת) or witness (עֵד) of the covenant was sometimes framed, such as a gift (Gen. xxi, 30), or a pillar, or heap of stones erected (Gen. xxxi, 52). The marriage compact is called "the covenant of God," Prov. ii, 17 (see Mal. ii, 14). The word covenant came to be applied to a sure ordinance, such as that of the show-bread (Lev. xxiv, 8); and is used figuratively in such expressions as a covenant with death (Isa. xxviii, 18), or with the wild beasts (Hos. ii, 18). The phrases בְּרִית אֱנָשִׁי, אֲנִשִּׁי, בְּרִית, "lords or men of one's covenant," are employed to denote confederacy (Gen. xiv, 13, Ob. 7). See CONTRACT.

2. *Improperly, of a covenant between God and man.* Man not being in any way in the position of an independent covenanting party, the phrase is evidently used by way of accommodation. See ANTHROPO-MORPHISM. Strictly speaking, such a covenant is quite unconditional, and amounts to a promise (Gal. iii, 15 sq., where ἐπαγγελία and διαθήκη are used almost as synonyms) or act of mere favor (Psa. lxxxix, 28, where יְקָר stands in parallelism with בְּרִית) on God's part. Thus the assurance given by God after

the Flood that a like judgment should not be repeated, and that the recurrence of the seasons, and of day and night, should not cease, is called a covenant (Gen. ix; Jer. xxxiii, 20). Generally, however, the form of a covenant is maintained, by the benefits which God engages to bestow being made by him dependent upon the fulfilment of certain conditions which he imposes on man. Thus the covenant with Abraham was conditioned by circumcision (Acts vii, 8), the omission of which was declared tantamount to a breach of the covenant (Gen. xvii); the covenant of the priesthood by zeal for God, his honor and service (Num. xxv, 12, 13; Deut. xxxiii, 9; Neh. xiii, 29; Mal. ii, 4, 5); the covenant of Sinai by the observance of the ten commandments (Exod. xxxiv, 27, 28; Lev. xxvi, 15), which are therefore called "Jehovah's covenant" (Deut. iv, 13), a name which was extended to all the books of Moses, if not to the whole body of Jewish canonical Scriptures (2 Cor. iii, 13, 14). This last-mentioned covenant, which was renewed at different periods of Jewish history (Deut. xxxii; Josh. xxiv; 2 Chron. xv, xxiii, xxix, xxxiv; Ezra x; Neh. ix, x), is one of the two principal covenants between God and man. They are distinguished as old and new (Jer. xxxi, 31-34; Heb. viii, 8-13; x, 16), with reference to the order, not of their institution, but of their actual development (Gal. iii, 17); and also as being the instruments respectively of bondage and freedom (Gal. iv, 24). Consistently with this representation of God's dealings with man under the form of a covenant, such covenant is said to be confirmed in conformity with human custom by an oath (Deut. iv, 81; Psa. lxxxix, 8), to be sanctioned by curses to fall upon the unfaithful (Deut. xxxii, 21), and to be accompanied by a sign (סֵמֶן), such as the rainbow (Gen. ix), circumcision (Gen. xvii), or the Sabbath (Exod. xxxi, 16, 17).—Smith, s. v. Hence, in Scripture, the covenant of God is called his "counsel," his "oath," his "promise" (Psa. lxxxix, 8, 4; cv, 8-11; Heb. vi, 18-20; Luke i, 68-75; Gal. iii, 15-18, etc.); and it is described as consisting wholly in the gracious bestowal of blessing on men (Isa. lix, 21; Jer. xxxi, 83, 84). Hence also the application of the term covenant to designate such fixed arrangements or laws of nature as the regular succession of day and night (Jer. xxxiii, 20), and such religious institutions as the Sabbath (Exod. xxxi, 16); circumcision (Gen. xvii, 9, 10); the Levitical institute (Lev. xxvi, 15); and, in general, any precept or ordinance of God (Jer. xxxiv, 18, 14), all such appointments forming part of that system or arrangement in connection with which the blessings of God's grace were to be enjoyed.—Kitto, s. v.

COVENANT OF SALT (בְּרִית מֶלַח). This phrase is supposed to denote a *perpetual covenant*, in the sealing or ratification of which salt was used. As salt was added to different kinds of viands, not only to give them a relish, but to preserve them from putrefaction and decay, it became the emblem of *incorruptibility* and *permanence*. Hence a "covenant of salt" signified an *everlasting* covenant (Num. xviii, 19; Lev. ii, 13; 2 Chron. xiii, 5). See SALT.

Covenant, Solemn League and. There were several covenants drawn up in Scotland having regard to the maintenance of the Reformed or Presbyterian religion in that country. The *First Covenant* was subscribed in Edinburgh Dec. 3, 1557, the mass of signers being known as the Congregation, and the nobility and leading subscribers as the Lords of the Congregation (q. v.). They petitioned the government for liberty of worship. Being met with dissimulation and treachery, a *Second Covenant* was signed at Perth, May 31, 1559, wherein the subscribers bound themselves to mutual assistance in defense of their religious rights. The appeal was made to arms, and the aid of queen Elizabeth of England was called in to counteract the French troops invited by the Papal party. On

the death of the queen-mother in 1560, the French troops were withdrawn, and Parliament, being left at liberty, ordained the Presbyterian as the Established Church of Scotland. In 1638 the *National Covenant* was subscribed over all Scotland with great enthusiasm. This was not only a repetition of the former covenants, but contained, moreover, a solemn protest against prelacy.

The *Solemn League and Covenant* was a compact entered into in 1643 between England and Scotland, binding the united kingdoms to mutual aid in the extirpation of popery and prelacy, and the preservation of true religion and liberty in the realm. It was drawn up by Alexander Henderson, approved by the General Assembly of the Church of Scotland Aug. 17, ratified by the Convention of Estates, and accepted and subscribed Sept. 25 by the English Parliament and the Westminster Assembly (q. v.). In 1645 it was again ratified by the Scottish General Assembly, together with the Directory for Worship framed by the Westminster Assembly. Although Charles I would not approve of it, Charles II engaged by oath to observe it, a promise which he broke upon the first opportunity. The Scottish Parliament of 1661, in the interest of the king, established the royal supremacy, annulled the Solemn League and Covenant, and absolved the lieges from its obligations. The "Covenants" have a place in the volume which comprehends the *Westminster Confession of Faith* (Scottish edition), but for what reason it is difficult to say, for the Church of Scotland does not make adherence to them obligatory on either clerical or lay members. Certain Scottish and Irish dissenters, however, still profess attachment to the covenants, and on particular occasions renew their subscription to them.—Hetherington, *Hist. of Church of Scotland*; McCrie, *Sketches of Ch. Hist.*; Rudloff, *Geschichte der Reformation in Schottland* (Berlin, 1853, 2 vols.). See CAMERONIANS; PRESBYTERIANS, REFORMED; SCOTLAND, CHURCH OF.

Covenants, Theology of. See FEDERAL THEOLOGY.

Covenanters, the name given primarily to that body of Presbyterians in Scotland who objected to the Revolution settlement in Church and State, and desired to see in full force that kind of civil and ecclesiastical polity that prevailed in Scotland from 1638 to 1649. "According to the Solemn League and Covenant, ratified by the Parliaments of England and Scotland, and also by the Assembly of Divines at Westminster in 1643, Presbyterianism was to be maintained in the kingdoms of England, Scotland, and Ireland, and popery, prelacy, superstition, heresy, schism, etc., were to be extirpated. The 'Covenanters' in Scotland contended, as is well known, under much suffering, for this species of Presbyterian supremacy throughout the reigns of Charles II and James VII (II). As a measure of pacification at the Revolution, Presbytery was established in Scotland by act of Parliament, 1690; but it was of a modified kind. Substantially the Church was rendered a creature of the State, more particularly as regards the calling of General Assemblies; and prelacy was not only confirmed in England and Ireland, but there was a general toleration of heresy—i. e. dissent. In sentiment, if not in form, therefore, this party repudiated the government of William III and his successors, and still maintained the perpetually binding obligations of the Covenants. The Covenanters acted under strong convictions, and only desired to carry out to a legitimate issue principles which have always been found in the Presbyterian Church of Scotland; but which, for prudential considerations, had been long practically in abeyance. In short, it is in the standards of the Covenanters that we have to look for a true embodiment of the tenets held by the great body of English and Scotch Presbyterians of 1643. Others gave in to the Revolution settlement, and after-

wards found cause to secede. The Covenanters never gave in, and, of course, never seceded. Although thus, in point of fact, an elder sister of the existing Church of Scotland and all its secessions, the Cameronian body did not assume a regular form till after the Revolution; and it was with some difficulty, amidst the general contentment of the nation, that it organized a communion with ordained ministers. The steadfastness of members was put to a severe trial by the defection of their ministers, and for a time the people were as sheep without a shepherd. At length, after their faith and patience had been tried for sixteen years, they were joined by the Rev. John M'Millan, from the Established Church, in 1706. In a short time afterwards the communion was joined by the Rev. John M'Neil, a licentiate of the Established Church. As a means of confirming the faith of members of the body, and of giving a public testimony of their principles, it was resolved to renew the Covenants; and this solemnity took place at Auchensach, near Douglas, in Lanarkshire, in 1712. The subsequent accession of the Rev. Mr. Nairne enabled the Covenanters to constitute a presbytery at Braehead, in the parish of Carnwath, on the 1st of August, 1743, under the appellation of the Reformed Presbytery. Other preachers afterwards attached themselves to the sect, which continued to flourish obscurely in the west of Scotland and north of Ireland. For their history and tenets we refer to the *Testimony of the Reformed Presbyterian Church* (Glasgow, John Keith, 1842). Holding strictly to the Covenants, and in theory rejecting the Revolution settlement, the political position of the Covenanters is very peculiar, as they refuse to recognise any laws or institutions which they conceive to be inimical to those of the kingdom of Christ" (Chambers, *Encyclopædia*, s. v. Cameronians). The Reformed Presbyterians regard themselves as the modern representatives of the Covenanters. See *History of the Covenanters* (2 vols. 18mo, Philad. Presb. Board); also the articles PRESBYTERIAN (REFORMED) CHURCH; CAMERON; SCOTLAND, CHURCH OF.

Coverdale, MILES, one of the earliest English reformers, was born in Yorkshire in 1487, and was educated at Cambridge, where he became a monk of the Augustine order. At an early period he perceived the errors of Popery. In 1514 he was ordained priest. About 1525 he laid aside his monk's habit, and began to preach against papal errors. In 1528 he joined Tynedale at Hamburg, and in 1535 his own translation of the Bible appeared, with a dedication to Henry VIII. It formed a folio, printed at Zurich. "He thus had the honor of editing the first English Bible allowed by royal authority, and the first translation of the whole Bible printed in our language. The Psalms in it are those now used in the Book of Common Prayer. About the end of the year 1538 Coverdale went abroad again on the business of a new edition of the Bible. Grafton, the English printer, had permission from Francis I, at the request of king Henry VIII himself, to print a Bible at Paris, on account of the superior skill of the workmen, and the goodness and cheapness of the paper. But, notwithstanding the royal license, the Inquisition interposed by an instrument dated December 17, 1538. The French printers, their English employers, and Coverdale, who was the corrector of the press, were summoned before the inquisitors, and the impression, consisting of 2500 copies, was seized and condemned to the flames. The avarice of the officer who superintended the burning of the copies, however, induced him to sell several chests of them to a haberdasher for the purpose of wrapping his wares, by which means a few copies were preserved. The English proprietors, who had fled at the alarm, returned to Paris when it subsided, and not only recovered some of the copies which had escaped the fire, but brought with them to London the presses, types, and printers. This importation enabled Grafton and Whitchurch to print, in 1539, what is called Cramer's, or 'The Great Bible,'

in which Coverdale compared the translation with the Hebrew, corrected it in many places, and was the chief overseer of the work. Coverdale was almoner, some time afterwards, to queen Catharine Parr, the last wife of Henry VIII, at whose funeral he officiated in the chapel of Sudeley Castle, in Gloucestershire, in 1548. On August 14, 1551, he succeeded Dr. John Harman, otherwise Voysey, in the see of Exeter" (*English Cyclopædia*). On the accession of Queen Mary, he was ejected from his see and thrown into prison. On his release, at the end of two years, Coverdale repaired to Denmark, and afterwards to Wesel, and finally to Geneva, where he joined several other exiles in producing that version of the English Bible which is usually called "The Geneva Translation," part of which, the New Testament, was printed at Geneva in 1557 by Conrad Badius, and again in 1560. On the accession of queen Elizabeth Coverdale returned from exile; but having imbibed the principles of the Geneva reformers, as far as respected the ecclesiastical habits and ceremonies, he was not allowed to resume his bishopric, nor was any preferment offered to him for a considerable time. In 1568 bishop Grindal recommended him to the bishopric of Llandaff; but it is supposed that Coverdale's age and infirmities, and the remains of the plague, from which he had just recovered, made him decline so great a charge. In lieu of it, however, the bishop collated him to the rectory of St. Magnus London Bridge. He resigned this living in 1566. The date of his death has been variously stated. The parish register of St. Bartholomew, behind the Royal Exchange, however, proves that he was buried Feb. 19, 1568. His principal writings have been recently republished in England by the Parker Society, under the titles of "*Writings and Translations of Miles Coverdale*, edited by G. Pearson" (Camb. 1844, 8vo); "*Remains of Miles Coverdale*, edited by G. Pearson" (Cambridge, 1846, 8vo). See Bagster, *Memorials of Coverdale*; Johnson, *English Translations of the Bible*; Hook, *Eccles. Biography*, iv, 209.

Covering of the eyes, a phrase of much disputed signification, occurring in the expression כִּסְיוֹת עֵינָיִךְ אֲנִי אֶעֱשֶׂה לָּךְ, *he (or this) [shall be] to thee a covering of the eyes* (Gen. xx, 16; Sept. *ταῖρα ἔσται σοι εἰς ἔμψυχον τοῦ προσώπου σου*; Vulg. *hoc erit tibi in velamen oculorum*), which is usually understood to refer to a veil that ought to have been worn by Sarah to hide her dangerous beauty, and which either her husband (if נָשִׂיא be masc.) or the present (if neuter) would furnish. See ABRAHAM. Against this interpretation, however, there lies this objection, that such a piece of apparel, in modern Oriental usage, covers rather the face or person, and leaves the eyes free. See WOMAN. Hence many commentators (but see Rosenmüller, in loc.) explain the phrase as an idiomatic one for a peace-offering (see Gesenius, *Theb. Heb.* p. 700) or propitiatory present (comp. Gen. xxxii, 21; Exod. xxiii, 8; Job ix, 24; in none of which passages, however, does this expression precisely occur); but this does not so well suit the difficult context, "unto all that are with thee," since her companions had no cause of complaint, and a reproof would then have been inapposite. We may therefore recur to the explanation of Kitto (*Pict. Bible*, note in loc.): "It is customary for all the women inhabiting towns to go about closely veiled; while all the women of the different pastoral people who live in tents do not commonly wear veils, or at most only so far as to cover their foreheads and lower parts of the face, leaving the countenance exposed from the eyebrows to below the nose. Abimelech, according to this view, intended to give the very sensible advice, that while Sarah and her women were in or near towns, they had better conform to the customs of towns, and wear the complete veil, instead of that partial covering which left *the eyes* and so much of the face exposed" (see also

his *Daily Bible Illustrations*, in loc.). At the same time, there appears to be a refined allusion to the other meaning of the phrase in question, by one of those plays upon words so frequent in these early narratives. Hence the terseness of the whole phraseology. See VEIL.

COVERING THE HEAD IN PRAYER (1 Cor. xi, 4-6). See VEIL. (Buchner, *De ritu caput retegendi*, Viteb. 1708; Zeibich, *De morabitate ritus caput operiendi*, ib. 1704; Bergier, *De ritu capitis operiendi*, ib. 1703; Mallincroft, *id.* Lips. 1784). See PRAYER.

Covert, prop. some form of the verb כִּוְּרָה, *sathar*, to hide: namely, כִּוְּרָה, *se'ther*, a shelter (1 Sam. xxv, 20; Job xl, 21; Psa. lxi, 4; Isa. xvi, 4; xx, 2; elsewhere usually "secret place"); כִּוְּרָה, *masior*, protection (Isa. iv, 6); elsewhere some form of the verb סָבַק, *sakak*, to weave: namely, סָבַק, *masak* (text סָבַק, *meysak*), a covered walk or portico (Sept. *ἑμελίον*, apparently reading סָבַק, Vulg. *musac*); סָבַק, *sok*, a lair (Jer. xxv, 8; "den," Psa. x, 9; elsewhere a hut, "pavilion," Psa. xxvii, 5; "tabernacle," Psa. lxxvi, 2); סָבַק, *sakkak* (Job xxxviii, 40), a booth (as elsewhere usually rendered). This term is generally applied to a *thicket* for wild beasts, but in 2 Kings xvi, 18, we read that Ahaz, when spoiling the Temple, "took down the covert (סָבַק, *musak*) for the Sabbath that they had built in the house;" which bishop Patrick imagines was "a covered place, where the king sat, in the porch of the Temple, or at the entrance of it, upon the Sabbath, or other great solemnities. Ahaz took this away, intending, probably, not to trouble himself with coming to the Temple any more, but to sacrifice elsewhere." See COVERT. It rather designates a cloister, shaded from the heat of the sun for the accommodation of the courtly worshippers (Thenius, in loc.), such as we know ran around the interior of the Temple in later times. See TEMPLE.

Covetousness (ἡσυχία, *be'tsa*, *rapine*, *lucra*; *πλεονεξία*, a grasping temper), in a general sense, means all inordinate desire of worldly possessions, such as undue thirst for honors, gold, etc. In a more restricted sense, it is the desire of increasing one's substance by appropriating that of others. It is a disorder of the heart, and closely allied to selfishness. We here consider it under its more restricted aspect.

1. Covetousness (*πλεονεξία*, *phlaugyria*) is a strong, sometimes irresistible desire of possessing or of increasing one's possessions. It is evident that under its influence the heart, instead of aspiring to noble, high, and divine goods, will be brought to the almost exclusive contemplation of earthly, material things; and thus, instead of becoming gradually more closely united with God, will become more and more estranged from him. Since where the treasure is there the heart is also, the heart of the covetous cannot be with God, but with Mammon; he is not a servant of God, but of idols. The love of God and the love of Mammon cannot find place in the same heart; the one excludes the other (Matt. vi, 24; Luke xvi, 13; Col. iii, 5, *Mortify therefore your members which are upon the earth: fornication, uncleanness, inordinate affection, evil concupiscence, and covetousness, which is idolatry*). But since to love God is our highest duty, and God alone is to be prayed to, loved, and trusted, the covetous man, as a servant of Mammon, is forever excluded from the kingdom of Christ and of God (1 Cor. vi, 10, *Nor thieves, nor covetous, shall inherit the kingdom of God*; Eph. v, 5, *For this ye know, that no whoremonger, nor unclean person, nor covetous man, who is an idolater, hath any inheritance in the kingdom of Christ and of God*). We are further told that the citizen of the kingdom of God is to lay up riches in heaven (Matt. vi, 20); he must be

content with food and raiment (1 Tim. vi, 7, 8); but the covetous act in opposition to all these commandments (Heb. xiii, 5, *Let your conversation be without covetousness [ἀφιλάργυρος ὁ τρόπος]; and be content with such things as ye have: for he hath said, I will never leave thee nor forsake thee.*) This state of the heart is very dangerous, and covetousness is the source of all evil, and brings forth all manner of sin (1 Tim. vi, 9, 19, *For the love of money is the root of all evil; which while some coveted after they have erred from the faith, and pierced themselves through with many sorrows.*) Here the folly of covetousness is also shown, inasmuch as it is said to bring "many sorrows." It is further proved by the fact that earthly goods are perishable, and that their possession renders none happy. But it is corrupting as well as unsatisfactory. By attempting to gain the world the soul is wounded, and loses the everlasting life (Matt. vi, 20, *Lay up for yourselves treasures in heaven, where neither moth nor rust doth corrupt, and where thieves do not break through nor steal; xvi, 25, 26, For whosoever will save his life shall lose it, and whosoever will lose his life for my sake shall find it; for what is a man profited if he shall gain the whole world and lose his own soul, or what shall a man give in exchange for his soul?; Luke xii, 15-21, And he said unto them, Take heed, and beware of covetousness; for a man's life consisteth not in the abundance of the things which he possesseth.*)

2. Avarice is also a part of covetousness. It consists in amassing either for the sake of possessing or from fear of future want. This phase of covetousness is the surest mark of a cold-heartedness and worldliness, making pure, high, and holy aspirations impossible. It is also a sort of idolatry, for it is the love of mammon (Matt. vi, 19-24). It is essentially uncharitable, and incapable of affection (James ii, 15, 16, *If a brother or sister be naked, and destitute of daily food, and one of you say unto them, Depart in peace, be ye warmed and filled; notwithstanding ye give them not those things which are needful to the body, what doth it profit?*) Covetousness is as painful as it is deceitful in the end; it cripples the natural powers, renders life miserable and death terrible. The pursuits to which it leads are painfully laborious, and the care of the possessions, once secured, is equally so. The labor it entails is sinful, as it does not spring from love, but from selfishness and worldliness. As the wealth amassed by the covetous is applied to the benefit neither of themselves nor of others, they undergo the severest privations in the midst of plenty (Horace, *congestis undique saccis indormis inhians. Necis quo valeat nummus, quem prabeat usum*):—However great the natural power of a man, it is diminished by this sin. To the covetous death is horrible, as it deprives them of all to which the worldly heart most clings.

Considering the nature of covetousness, it cannot appear strange that the apostle particularly recommends a *bishop* to avoid that sin. The bishop, or spiritual head of the community, is to be spiritual (πνευματικός), the centre of the Christian life of the community (1 Tim. iii, 2, 8); and covetousness is a mark whereby false teachers may be known (2 Tim. iii, 2).—Krehl, *N. T. Handwörterbuch*.

Cow occurs in the Auth. Vers. (see ΚΙΝΣ) as the translation of פָּרָה (*parah*), Job xxi, 10; Isa. xi, 7; elsewhere usually "kine"), עֵגְלָה (*eglah*), Isa. vii, 21, "a young cow"), a heifer (as usually elsewhere), בָּקָר (*bakar*), "kine," Deut. xxxii, 14; 2 Sam. xvii, 29; "cow"-dung, Ezek. iv, 15; a young "cow," Isa. vii, 21), any animal of the ox kind (elsewhere "bullock," "herd," etc.), and שׂוֹר (*shor*, Lev. xxii, 28; Num. xviii, 17), any beef animal (usually an "ox"). See BULL; CATTLE; OX. The first of the above Heb. words (generally found in the plur. פָּרוֹת, *paroth*), rendered "kine" in Gen. xii, 2, 8, 4, and "heifer" in

Num. xix, 2), properly signifies a heifer or young cow in milk (1 Sam. vi, 7); also as bearing the yoke (Hos. iv, 16). In Amos iv, 1, the phrase "kine or heifers of Bashan" is used metaphorically for the voluptuous females of Samaria. See BASEAN.

By the Mosaic law (Lev. xxii, 28), a cow and her calf were not to be killed on the same day. Similar precepts are found in Exod. xxiii, 19; Deut. xxii, 6, 7. Whether they were designed to prevent inhumanity, or referred to some heathen custom, is uncertain. The cow is esteemed holy by the Hindoos. In the remarkable prophecy (Isa. vii, 21-25), the event foretold is, that the face of the land of Judah should be so completely changed, and the inhabitants so greatly reduced in number, that, with only a single young cow, and two sheep, a family should be supplied with an abundance of milk and butter; and vineyards, which before commanded a high rent, should be overgrown with briars and thorns. It may be observed that dried cow-dung was, in Palestine, commonly used for fuel, as it is at the present day among the Arabs, but it is remarkably slow in burning; on this account the Arabs frequently threaten to burn a person with cow-dung as a lingering death. This fuel forms a striking contrast to the short-lived and noisy violence of thorns and furze, which are speedily consumed with a "crackling" noise (Ecc. vii, 6). Roberts, on Ezek. iv, 15, observes: "In some places, firewood being very scarce, the people gather cow-dung, make it into cakes, and dry it in the sun, after which it is ready for fuel. Those who are accustomed to have their food prepared in this way prefer it to any other; they tell you it is sweeter and more holy, as the fuel comes from their sacred animal." See DUNG.

Coward, WILLIAM, M.D., was born at Winchester, 1657, and became fellow of Wadham College, Oxford. He settled first at Northampton, and afterwards at London, where he died in 1724. In 1702 he published *Second Thoughts concerning the Human Soul, demonstrating that the notion of the human soul, as believed to be a spiritual and immaterial substance united to a human, was an invention of the heathens*. This work gave so much offence, by defending the doctrine of materialism, that the House of Commons ordered it to be burned by the hangman. It was answered by Dr. Nichols, in his *Conference with a Theist*; by Broughton, in his *Psychologia*; and by Turner. Dr. Coward also published, in 1704, *Further Thoughts on Second Thoughts*; and *The Grand Essay, or a Vindication of Reason and Religion against the Impostures of Philosophy*.—Darling, *Cyclopaedia Bibliographica*, i, 795.

Cowl (*cusculus*), a sort of hood worn by certain classes of monks. Those worn by the Bernardines and Benedictines are of two kinds: the one white, very large, worn in ceremony, and when they assist at the office; the other black, worn on ordinary occasions and in the streets. Mabillon maintains that the cowl is the same in its origin as the scapular (q. v.). Others distinguish two sorts of cowls; the one a gown, reaching to the feet, having sleeves, and a capuchin, used in ceremonies; the other a kind of hood to work in, called also a scapular, because it covers only the head and shoulders.—Farrar, *Ecc. Dict.* s. v.; Bingham, *Orig. Ecc.* vii, 8, 6.

Cowles, GILES HOOKER, D.D., a Congregational minister, was born in Farmington, Conn., Aug. 26, 1766. He graduated at Yale in 1789, entered the ministry in May, 1791, and was installed pastor of the First Church at Bristol in 1792. He was appointed in 1810, by the Conn. Miss. Soc., to travel through the Northern part of Ohio. He accepted the position of pastor over the churches of Austintown and Morgan, Ohio, and was installed in 1811. He died in the former place July 6, 1885. He was made D.D. by Williams College, 1828.—Sprague, *Annals*, ii, 830.

Cowper, WILLIAM, an eminent Scotch divine, was born at Edinburgh in 1566. He studied at the University of St. Andrews, and in 1586 was appointed minister of Bothkennor, Sterlingshire. In 1598 he removed to Perth, where he continued until 1612, after which he was appointed bishop of Galloway. He died in 1619. His works breathe a spirit of cordial piety, and the simplicity and strength of his style are peculiarly worthy of commendation. Among them we remark "*Heaven opened*" (5th ed., Lond. 1619, 4to). A collection of his works was published after his death (Lond. 1629, fol.).—Darling, *Cyclop. Bibl.* s. v.

COX, F. A., D.D., an eminent English Baptist minister, was born about 1783. He was pastor of the Baptist church at Hackney, London, and was one of the leading men in many of the religious societies of the metropolis. Of his works the most important are the *History of the Baptist Missions*, a volume on *Antiquities*, reprinted from the *Encyclopaedia Metropolitana*; *Our Young Men*, a prize essay (1847); and a *Life of Melancthon*. He was a contributor to the first series of the *Journal of Sacred Literature*. His name is worthy of being associated with those of Ryland, Fuller, Carey, Marshman, Ward, Robert Hall, and John Foster, who in recent times have brought honor on the Baptist denomination by their literary as well as their religious labors.

Cox, Melville Beveridge, a Methodist Episcopal missionary to Africa, was born at Hallowell, Maine, in 1799; was converted in 1818; entered the ministry in 1822; on account of failing health was superannuated from 1825 to 1831; and afterwards served some time as agent of the Wesleyan University. In 1831 he was stationed at Raleigh, N. C. Soon afterwards he volunteered to go to Africa as a missionary, and sailed from Norfolk, Va., November 6, 1832, arriving in Liberia March 8, 1833. Here at once he set to work to lay the foundations of the Church in Africa. He labored faithfully, organizing the mission, collecting information, and preaching and teaching incessantly. In a few months he had formed a school of 70 scholars; but the African fever seized him, and on the 21st of July, 1833, after four months' labor, he died in triumph. Mr. Cox was a man of great piety and devoted zeal.—*Meth. Mag. and Quart. Review*, Jan. 1834; *Amer. Miss. Memorial*, p. 431; Cox, G. F., *Life and Remains of M. B. Cox* (N. Y. 18mo); Sprague, *Annals*, vii, 656.

Cox, Richard, bishop of Ely, was born about 1500, at Whaddon, Buckinghamshire, England. He was educated at Eton School and at King's College, where he obtained a fellowship in 1519. He was invited by cardinal Wolsey to Oxford to fill up his new foundation. For speaking his mind too freely of the corruptions of popery, he was deprived of his preferment and thrown into prison. When he had recovered his liberty he left Oxford; some time after he was chosen master of Eton School, which flourished remarkably under him; and by the interest of archbishop Cramer he obtained several dignities in the Church, viz., the archdeaconry of Ely, a prebend of the same church and of Lincoln, and the deanery of Christ Church. He was appointed tutor to prince Edward, and on that prince's accession to the throne became a great favorite at court. He was made a privy councillor and the king's almoner; was elected chancellor of the University of Oxford in 1547; the next year installed canon of Windsor, and the year following dean of Westminster. About this time he was appointed one of the commissioners to

visit the University of Oxford, and is accused by some of abusing his authority by destroying many books of his zeal against popery. After Mary's accession he was stripped of his preferments and committed to the Marshalsea; but his confinement was not long, and on his release he went to Strasburg, and thence to Frankfurt, where he formed a kind of university, and appointed a Greek and a Hebrew lecturer, a divinity professor, and a treasurer for the contributions remitted from England. On the death of Mary he returned, and was the chief champion on the Protestant side in the disputation at Westminster between eight papists and an equal number of the Reformed clergy. His abilities and zeal were rewarded by the bishopric of Ely, over which see he presided above 21 years. He opposed with great zeal the queen's retaining the crucifix and lights in her chapel, and was a strenuous advocate for the marriage of the clergy, against which she had contracted a strange aversion. He was one of the compilers of the Liturgy of the Church of England; and when a new translation of the Bible was made in the reign of Elizabeth, now commonly known by the name of "The Bishop's Bible," the Four Gospels, the Acts of the Apostles, and the Epistle to the Romans were allotted to him for his portion. A number of his tracts on the Romish controversy are to be found in the addenda to Burnet's *History of the Reformation*. Several letters and small pieces of his have been published by Strype in his *Annals of the Reformation*.—Downe, *Life of Bishop Cox*; Collier, *Ecclesiastical History*; Kippis, *Biographia Britannica*, iv, 396 sq.

COX (Heb. קֹחַ, *Koḥ*, the same name elsewhere Anglicized *Koz* [q. v.], Sept. Κωί), the father of Anub and others of the posterity of Judah (1 Chron. iv, 8, where, however, his own parentage is not stated, unless he be a son or brother of Ashur in ver. 5). B.C. post 1618.

COX'BI (Heb. קֹזְבִי, *Kozbi*, *false*; Sept. Κορβί; Joseph. *Korβία*, *Ant.* iv, 6, 10), the daughter of Zur, a Midianitish prince. Phinehas, in his holy indignation, slew her, while in the act of committing lewdness with Zimri, an Israelitish chief, by thrusting a javelin through the middle of both (Num. xxv, 15, 16). B.C. 1619.

COZRI. See **KOZRI**.

Crackling (קֹרֵק, *coice*, i. e. noise) of thorns (q. v.) under a pot; a proverbial expression for a roaring but quickly-extinguished fire (Eccles. vii, 6). See **FUEL**.

Craoknel (only in the plur. סֻבְּלִימִים, *siblakim*, literally cakes marked with points), probably a kind of biscuit or other cake baked hard and punctured with holes, such as Jeroboam's wife took in disguise



Modern Oriental Pastry-cook.

(they being of a very common description) as a present to the prophet Ahijah (1 Kings xiv, 3, where the Sept. has *καλλυρις*, Vulg. *crustula*). See BREAD. The original word (in nearly the same form) occurs in Josh. ix, 5, 12, where it is improperly rendered "mouldy" (q. v.). See CAKE.

Cradock, Samuel, B.D., an eminent Nonconformist, was born in 1620, and was educated at Emmanuel College, Cambridge, of which he became fellow. He was presented to the college living of North Cadbury, but ejected for nonconformity in 1662, and retired to an estate at Wickham Brook which had been left to him. He died in 1760. He was a man of serious and truly catholic spirit, solid judgment, digested thought, clear method, and unaffected style. His works have been greatly commended by archbishop Tillotson and bishop Reynolds. Dr. Doddridge says that no author assisted him more in what relates to the New Testament. His principal works are, *The History of the O. T. methodized* (Lond. 1683, fol.);—*The Harmony of the Four Evangelists* (Lond. 1686, fol.);—*The Apostolical History, with an Analytical Paraphrase* (Lond. 1672, fol.);—*Knowledge and Practice* (4th ed., with eight new chapters, Lond. 1702, fol.);—Darling, *Cyclop. Bibliog.* s. v.

Cradock, Walter, an eminent English divine, was born at Trefala, Monmouthshire. He was educated at the University of Oxford, joined the Puritans, and became curate of St. Mary's, Cardiff. During the civil wars he became pastor of Allhallows the Great, London, and occasionally itinerated through Wales. He died in 1660. He was an Independent in Church government—a man of excellent character and high reputation; in doctrine, he was zealous in preaching justification by imputed righteousness. His principal works are, *Gospel Libertie in the Extensions and Limitations of it* (Lond. 1648, 4to);—*Divine Drops distilled from the Fountain of Holy Scriptures* (Lond. 1650, 4to);—*Gospel Holinesse* (Lond. 1651, 4to). A collection of his works has been published (Chester, 1800, 8vo).—Darling, *Cyclop. Bibliog.* s. v.

Craftsman (חָרָשׁ, *charash'*, Deut. xxvii, 25; 2 Kings xxiv, 16; Hos. xiii, 2; elsewhere "engraver," "workman," etc.; חָרָשׁ, *che'resh*, Neh. xi, 85; "cunning," Isa. iii, 8; "secretly," Josh. ii, 1; "Charashim," 1 Chron. iv, 14; both from חָרַשׁ, *charash'*, to carve in stone, hence to be an artificer in general; *τεχνίτης*, Acts xix, 24, 38; Rev. xviii, 22; "builder," Heb. xi, 10; an *artisan*, a workman at any mechanical employment requiring skill. See MECHANIC. Persons of this class professionally (for every Jew was required to learn some manual trade, to fall back upon in case of want) seem to have congregated in a

special street or bazaar (q. v.) in the environs of Jerusalem (1 Chron. iv, 14, where it is called a valley), or rather in the vicinity of Lod (Neh. xi, 86); regarded by Dr. Robinson (*Phys. Geogr. of Palest.* p. 118) as the plain of *Beit Nuba*, or rather a side valley opening into it. See CHARASHIM.

Craig, JOHN, one of the Scottish Reformers, was born in Scotland about 1512. "Having spent some time as a tutor in England, he returned to Scotland and entered the Dominican order, of which he had not long been a member when he fell under the suspicion of heresy, and was cast into prison. On his release he travelled on the Continent; and after some time was, through cardinal Pole's influence, intrusted with the education of the novices in connection with the Dominican order at Bologna. While here, Calvin's *Institutes* fell in his way, and converted him to Protestant doctrines. Having openly avowed the change in his opinions, he was brought before the Inquisition, and sentenced to be burnt—a fate from which he was saved by the mob, on the death of pope Paul IV, breaking open the prisons in Rome, and setting the prisoners at liberty. Craig escaped to Vienna, and obtained some favor at the court of Maximilian II; but the news of his being there reached Rome, and the pope demanded his surrender as one condemned for heresy. The emperor, however, instead of complying with the request of his holiness, gave Craig a safe-conduct out of Germany. He now returned to Scotland, and was appointed the colleague of John Knox in the parish church of Edinburgh. Thinking the marriage of queen Mary and Bothwell contrary to the Word of God, he, while holding this position, boldly refused to proclaim the banns. In 1572 Craig was sent 'to illuminate the dark places' in Forfarshire and Aberdeenshire, and remained in the North until 1579, when he was appointed minister to king James VI in Edinburgh. He now took a leading part in the affairs of the Church, was the compiler of part of the Second Book of Discipline, and the writer of the National Covenant signed in 1580 by the king and his household. He was a man of great conscientiousness, and was not slow to oppose the proceedings of the court when he deemed them opposed to Scripture, and to speak wholesome but unpleasant truths to his majesty himself. He died December, 1600."—Chambers, *Encyclopaedia*, s. v.

Crakanthorp, RICHARD, D.D., was born at Strickland, in Westmoreland, in 1567. He was admitted to Queen's College, Oxford, in 1583, and became fellow in 1598. He obtained the rectory of Black Notley, Essex, and died in 1624. He had the reputation of being a general scholar, was quite a canonist, perfectly acquainted with ecclesiastical antiquity and scholastic divinity, and was a celebrated preacher. His principal works are, *Defensio Ecclesie Anglicanae contra M. Antonii de Dominis, D. Archiepiscopi Spalatensis, injurias* (new edit. in *The Library of Anglo-Catholic Theology*, Oxf. 1847, 8vo);—*Rome's Seer overseens* (Lond. 1681, fol.);—*The Defence of Constantine, with a Treatise of the Pope's temporal Monarchie* (Lond. 1621, 4to).—Darling, *Cyclopaedia Bibliographica*, s. v.

Cramer, JOHANN ANDREAS, a German theologian and poetical writer, was born at Josephstadt, Saxony, Jan. 29, 1723. He studied at Leipsic, was invited to Copenhagen by Frederick V, and, with the exception of three years, resided in Denmark from 1754 to 1788, in which latter year he died. At the time of his death he was chancellor of the University of



Modern Oriental Turner.

Kiel. He translated Bossuet's Universal History, the Homilies of St. Chrysostom, and the Psalms of David into verse (Leips. 1756), and wrote the *Northern Spectator* (der nordische Aufseher), three vols. (Copenhagen, 1758); *Sermons*, twenty-two vols.; and *Poems*, three vols. (1782). Germany ranks him among her best lyric poets.

Crane occurs in our version as the translation of צִנְוִר (*sus*, literally a *leaper*, from its swiftness, Isa. xxxviii, 14) or סִיס (*sis*, Jer. viii, 7), in connection with another bird, the צִנְוִר (*agur*), the *chatterer*, or, as Gesenius renders it in Isaiah, the *chattering*, as an epithet of the other), which latter is rendered "swallow" in our version. The Rabbins agree with our version in rendering the former of these words (*sus* or *sis*) by "crane;" but Bochart and Gesenius (in accordance with the Sept., Theod., and Vulg.), more correctly, as we think, decide in favor of "swallow;" while Luther, rejecting both, prefers "heron." Where so much diversity of opinion reigns, it will be most safe to search for the true meaning by examining the internal evidence furnished by the texts in question, the two names occurring in no other instance. In Isaiah, allusion is made to the voice of both the species (if distinct), which is described by the verb "to chatter," in accordance, or nearly so, with all critical authorities. See SWALLOW. In Jeremiah, where both names occur in the same order, the birds are represented as "observing the time of their coming." Now, if the "crane" of Europe had been meant by either denomination, the clamorous habits of the species would not have been expressed as "chattering;" and it is most probable that the striking characteristics of that bird, which are so elegantly and forcibly displayed in Hesiod and Aristophanes, would have supplied the lofty diction of prophetic inspiration with associations of a



Crane (*Grus Cinnerea*).

character still more exalted. *Sus* or *sis* is the name of a fabulous long-legged bird in Arabian legends, but it also indicates the expressive sound of the swallow's voice, while *agur* is transferred with slight alteration to the stork in several northern tongues. The Teutonic *aiber*, Dutch *oyvaer*, Esthonian *aigr* and *aigro*, therefore support the view that the latter term is a tribal epithet of one of the great wading birds; but neither the Hebrew text nor the Teutonic names point to the crane of Europe (*Ardea grus*, Linn., *Grus cinerea* of later ornithologists), since that species has a loud trumpet voice, and therefore does not "chatter;" but especially because in its migrations it crosses the

Mediterranean into Africa, and does not appear in Palestine, unless by accident (driven thither possibly by a western storm of wind); and when a troop of cranes alight under these circumstances, it is only for a moment; they do not give evidence of purposely assembling like the swallow. Thus the few characteristic indicated might seem to point out the stork, which does assemble in Syria in flocks before its departure, and is not a clamorous bird, having little or no voice. But as the stork is clearly designated by a different appellation in the original [see STORK], we must search for another species as the representative of the *sus*, or at least of the latter term; and we fortunately find one which completely answers to the conditions required; for, being neither a genuine crane, a stork, nor a heron, having a feeble voice, and striking, but distinct manners, it is remarkable for beauty, numbers, residence, and periodical arrival and departure. The Numidian crane (*Ardea virgo* of Linn., the *Grus virgo* of later writers, and *Anthropoides virgo* of some)

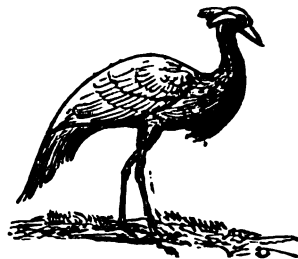

Numidian Crane (*Grus Virgo*).

is the bird, we have every reason to conclude, intended by "agur," though not coming from the north, but from Central Africa, down the Nile (the very circumstance which puzzled Hasselquist), and in the spring arriving in Palestine, while troops of them proceed to Asia Minor, and some as far north as the Caspian. They are frequently found portrayed on Egyptian monuments, and the naturalist just quoted, who saw them on the Nile, afterwards shot one near Smyrna: they visit the swamp above that city, and the lake of Tiberias, and depart in the fall, but do not utter the clangor of the crane, nor adopt its flight in two columns, forming an acute angle, the better to cleave the air. This bird is not more than three feet in length; it is of a beautiful bluish gray, with the cheeks, throat, breast, and tips of the long hinder feathers and quills black, and a tuft of delicate white plumes behind each eye. It has a peculiar dancing walk, which gave rise to its French denomination of "demoiselle" (see the *Penny Cyclopaedia*, s. v. Heron).—Kitto, s. v. See BIRD.

The Hebrew term *sus* occurs frequently elsewhere, but only in the sense of "horse" or *cavalry*.

Crane, JOHN, D.D., a Congregational minister, was born at Norton, Mass., March 26, 1756. He graduated at Harvard in 1780, and was installed pastor at Northbridge, Mass., June 25, 1788, where he remained until his death, Aug. 31, 1836. He published *Eight Discourses on Baptism* (1806) and a few occasional sermons.—Sprague, *Annals*, ii, 214.

Cranmer, THOMAS, archbishop of Canterbury, and one of the greatest of the English reformers, was born at Aslacton, Nottinghamshire, July 2, 1489. He entered Jesus College in 1508, became a fellow in 1510-11, studied Greek, Hebrew, and theology with great diligence, and acquired high repute for scholarship. He forfeited his fellowship by an early marriage, but his wife died within a year, and he was restored. In 1523 he took the degree of D.D. In 1528 he was at Waltham Abbey, the seat of Mr. Cressy, educating that gentleman's children. Here he met Gardiner and Fox, who asked his opinion as to Henry VIII's di-

voce. His reply was made known to the king, and gave him so much satisfaction that he sent for Cranmer, who reluctantly obeyed the summons, and reduced his opinion to writing. "It asserted that the marriage of Henry with his brother's widow was condemned by the Scriptures, the councils, and the fathers; and that the pope had no power to give a dispensation for that which was contrary to the word of God." Pains were taken to make this judgment known. Cranmer himself disputed upon it at Cambridge, and brought several over to his opinion. He was appointed chaplain to the king, presented to the archdeaconry of Taunton, and joined the embassy to Rome about the close of 1529. The ambassadors, finding all arguments unavailing with pope Clement, quickly returned, leaving Cranmer in Italy. The pope conferred on him the empty title of "Supreme Penitentiary." Wearied with delays, Cranmer left Italy in 1530, and went afterwards, on the same business, to France and Germany—an expedition which, although it produced no decisive public result, led to an event of great consequence to himself. Regardless of the Romish injunction for clerical celibacy, he married (1532) a second time, the object of his choice being the niece of Osiander, the pastor of Nuremberg. This secret act exposed him to many unworthy evasions. He was soon after made archbishop of Canterbury, and when consecrated (March 30, 1533), made a public protestation, "That he did not intend by this oath to restrain himself from anything that he was bound to either by his duty to God, or the king, or the country." "By this," says Burnet (*Hist. Reformation*, vol. i), "if he did not wholly save his integrity, yet it was plain he intended no cheat, but to act fairly and above-board." On the 23d of May, 1533, Cranmer declared the king's marriage void. Five days afterwards he publicly married the king to Anne Boleyn, a private marriage having taken place in the January previous. The business of his office and parliamentary duty now occupied his time. With his assistance were passed several statutes, by which the power of the pope in England was materially diminished; the Convocation and universities assented to these statutes, pronouncing that "the bishop of Rome has not any greater jurisdiction conferred on him in this realm of England than any other foreign bishop."

In 1534, with the consent of the Convocation, he set on foot a translation of the Bible, by dividing Tyndale's version of the New Testament into nine or ten parts, which he required the most learned bishops to revise; the translation was completed and ultimately printed at Paris. In 1535 he assisted in the second edition of the "King's Primer," a book containing doctrines bordering upon Protestantism. In 1536 the divorced queen died, and Henry, being now tired of Anne Boleyn, determined to get rid of her, and Cranmer a second time served the bad passions of the king, and, in virtue of his office, pronounced the marriage void (1536). The pope threatened to assemble a synod to censure Henry. Cranmer and others signed a declaration that the king need not obey the decisions of such an assembly. With the assistance of many eminent divines, Cranmer arranged the "*Bishops' Book*," inculcating the doctrines of the Reformers. The king, to whom this book was submitted, himself inserted some corrections, from which the archbishop was bold enough to dissent. The destruction of the greater abbeys was now rapidly proceeding, and the funds which arose from them were lavished by Henry upon unworthy favorites, until Cranmer, who had hoped to apply them to the promotion of religion and education, remonstrated against their improper application. A sum of money was obtained for the foundation of some new bishoprics, but the king's prodigality could be checked no further. From 1538 to 1544 the mind of Henry VIII was against progress in the Reformation. On the 5th of May,

1538, Cranmer and others were appointed commissioners "to inquire" (Le Bas, vol. i, 204) "into the debated doctrines, and to prepare such articles as would pacify the spirit of controversy." At the end of eleven days the labors of the commissioners coming to no result, the duke of Norfolk offered six articles (Burnet, vol. i) for the consideration of the House of Lords. Cranmer's opinion agreed only with one of these articles, but they were passed (see ARTICLES, SIX). Latimer and Shaxton resigned their bishoprics, an example which Cranmer did not think it his duty to follow. In July, 1540, he presided at the Convocation which pronounced the unjustifiable dissolution of the marriage between Henry and Anne of Clèves. The misconduct of Catharine Howard, whom Henry had married, coming to the knowledge of the archbishop, he reported her prodigality to the king (1541). The proofs of her crimes were held to be conclusive; she was condemned and executed. The Reformation now (1542) became the sole occupation of Cranmer, who had transferred to the universities the task of revising a new edition of the Bible published the year before. In a minor degree Cranmer's attention was occupied in reproving the luxury in which some ecclesiastical establishments, as well as the bishops, had indulged.

In May, 1543, appeared the "*King's Book*," which was, in fact, little more than a new edition of the *Institution of a Christian Man*, altered in some points by the papal party; it received its name from the preface, which was written in Henry's name. The clergy being hostile to this book, Cranmer, at a visitation of his diocese, in submission to the king's supremacy, forbade them from preaching against any portions of it, however they or he himself might dissent from them. In 1544 Cranmer carried through Parliament a bill to mitigate the severity of the "Six Articles." He also assisted in compiling an improved English Litany, essentially similar to that which is now in use. Difficulties, however, were increasing around him. The duke of Norfolk and other members of the privy council accused him of spreading heresies through the land, and Henry caused Sir Anthony Denny to carry a message to Cranmer, who rose from his bed to attend upon the king at Whitehall. The council assembled next day, and summoned the primate. Sentence of imprisonment was passed upon him, but, to their confusion, he produced the signet of the king, from whose hands he had received it the night before. The council did not venture to proceed further.

King Henry died 27th January, 1547. Cranmer was named one of the regents of the kingdom. On the accession of Edward, all things indeed betokened a further extension of the Reformation. A visitation was immediately set on foot; twelve homilies, four of which are ascribed to Cranmer, were drawn up, and ordered to be placed in every church, with the translation of Erasmus's paraphrase of the N. T., for the instruction of the people. Gardiner continued to oppose the Reformation, but Cranmer's influence prevailed; and when he produced in convocation an ordinance that the laity as well as the clergy should receive the sacrament in both kinds, the proposition passed unanimously, and soon after obtained the sanction of the Legislature. In 1548 he revived the proposal for substituting a communion office for the mass, and a service was framed in time to be circulated to the clergy for their use at the following Easter. A translation of a catechism, written in German and Latin by Justus Jonas, was published by the archbishop, entitled *Cranmer's Catechism*. In the month of May a commission of twelve divines, with Cranmer at their head, was appointed for the compilation of an English liturgy. See COMMON PRAYER; LITURGY. On the condemnation of Lord Seymour (1549), Cranmer signed the warrant for his execution, notwithstanding the canon law that no churchman should meddle in matters of blood. Bonner, bishop of London, was now

degraded by commissioners, of whom Cranmer was one. An addition was made to the ritual in the shape of a formulary for ordination, and other steps were taken by the primate in order to diffuse a better knowledge of the creed of the Protestants. At Lambeth he received the most eminent foreign divines, Martin Bucer, Fagius, Peter Martyr, and several more. Cranmer was greatly troubled at the discussions respecting the substitution of tables for altars in the churches. In July, 1550, Hooper was made bishop of Gloucester, and soon after Cranmer received from him a refusal to wear the episcopal habits. Cranmer, upon consideration, determined to oppose Hooper, and, in case he persisted, to remove him from his bishopric. Hooper adopted some of the usual habits. The bishop of Chichester would not obey the order respecting the removal of altars, and the primate consequently deprived him of his see. Bishop Gardiner, who had now been in prison nearly two years, was deprived of his bishopric and sent back to the Tower. The conduct of Cranmer in the cases of Bonner and Gardiner was a great exception to his usual moderation. Gardiner, during his imprisonment, occupied himself in answering a treatise published by Cranmer, entitled the *Defence of the True Doctrine of the Sacrament*. This controversy was carried on by the archbishop until the end of his life. A revision of the "Service-book" of 1548 was commenced by Cranmer, with the assistance of Ridley and Cox, Peter Martyr and Bucer. The undertaking was checked in 1551 by the death of Bucer. The bishops being now (1551) for the most part divines favorable to the Reformation, the compilation of articles for the greater uniformity of faith was undertaken by them at the suggestion of the king. This labor so filled the hands of Cranmer, that his time was nearly always occupied by one or other of the great duties that he had imposed upon himself; scarcely could he attend the trial of bishop Tonstal. The bishop was deprived of his see, a sentence which was so contrary to Cranmer's opinion, that, with Lord Stourton, a Roman Catholic, he protested against it. It was not till 1552 that Cranmer gave up all hope of an agreement among all the churches that had withdrawn from the papal supremacy, and for which he had entered into correspondence with Calvin, Melancthon, and other divines of the Continent. The "Service-book" was completed, and the *Book of Common Prayer* adopted by Parliament in the spring of 1552. In May, 1553, Edward issued a mandate that the clergy should subscribe to the Forty-two Articles upon which the divines had agreed, but he died soon afterwards.

A letter was sent to the princess Mary declaring queen Jane (*Lady Jane Grey*) to be the sovereign. This letter was signed by many persons, and among them by Cranmer, whose zeal for the Protestant cause must have blinded him to the danger of the enterprise. On the 9th of July, 1553, the chief officers of the state swore allegiance to Jane; on the 20th we find many of those who had been zealous in her cause "impatient to send in their submissions to Mary." On the same day an order was sent by Mary to Northumberland to disarm. The hopes of the Protestants were now at an end, as queen Mary's unshaken attachment to the Roman Catholic creed was universally known. Gardiner was released and made chancellor, and a commission was formed to degrade and imprison Protestant prelates and ministers on the charges of treason, heresy, and matrimony. In the beginning of August Cranmer was summoned before the council; and in September, with Latimer and Ridley, was committed to the Tower. In March, 1554, he was removed, with bishops Latimer and Ridley, to prison at Oxford, where was renewed the controversy respecting the Lord's Supper, which, by the queen's desire, was named the subject for discussion. On the 18th and 19th of April the discussion was held; and on the 28th the accused were brought

to St. Mary's, where it was declared that, unless they would turn, they were obstinate heretics, and no larger members of the Church. Cranmer then replied, "From this your judgment and sentence I appeal to the just judgment of the Almighty, trusting to be present with him in heaven, for whose presence in the altar I am thus condemned," and he was removed again to prison. It was soon discovered that the tribunal before which Cranmer had been tried was not competent to decide the case. The pope issued a fresh commission, and on the 12th of September, 1555, the primate was examined by Brokes, the bishop of Gloucester, and two civilians, Martin and Story. Before these proceedings, Cranmer was summoned to appear within eighty days before the pope at Rome: this must have been a mere fiction of papal law, as it was impossible for Cranmer to obey. On the 29th of November the eighty days had elapsed, and on the 4th of December he was excommunicated and deprived of his bishopric. A letter from the pope (Paul IV), bearing date the 14th of November, affirming him to be contumacious because "he took no care to appear" at Rome when cited, and declaring him guilty of heresy and other enormities, finally commanded his excommunication. On the 14th of February Cranmer was degraded. In a few days after this his fortitude gave way; he forsook his principles and wrote a recantation. It was of no avail towards the preservation of his life. On the 20th of March, the eve of his execution, he was visited by Dr. Cole, and Cranmer stated that he remained firm in the Catholic faith as he had recently professed it, an answer that has been considered equivocal. On the following day he was led to St. Mary's church, where, after an exhortation by Dr. Cole, Cranmer finished his private devotions and then solemnly addressed the people, openly professing his faith, and at length declaring, "Now I come to the great thing that troubleth my conscience more than any other thing that I ever said or did in my life, and that is the setting abroad of writings contrary to the truth which I thought in my heart, and writ for fear of death, and to save my life, if it might be; and that is all such bills which I have written or signed with mine own hand since my degradation, wherein I have written many things untrue. And forasmuch as my hand offended in writing contrary to my heart, therefore my hand shall first be punished, for, if I may come to the fire, it shall be first burned. And as for the pope, I refuse him as Christ's enemy and Antichrist, with all his false doctrine." The assembly was astonished; they had supposed that he would have confirmed and not retracted his recantation. He was hurried away to the stake, where he stood motionless, holding up his right hand, and exclaiming, until his utterance was stifled, "This unworthy hand! Lord Jesus, receive my spirit!"

Cranmer's diligence and application were unusual; he was deeply read in theology and canon law, and was familiar with Hebrew, Greek, and Latin, as well as French, German, and Italian. His reservation respecting the oaths which he swore when appointed archbishop, his subserviency to Henry VIII in annulling his marriages, his share in the condemnation of some heretics, his conduct at the disgracing of Bonner and Gardiner, and the want of courage which made him recant after his condemnation, are great blot on his character. But, though his conduct on these occasions was marked by want of firmness, it cannot be denied that Cranmer was sincere, mild, and moderate, and, for the most part, a firm man; nor is it to be forgotten that persecution was the policy of all religious parties at this period. "Cranmer was neither fool, knave, nor demigod. He lived in an age when men had need of all the tact they could muster, and he proved himself prudent and learned. He was one of those useful persons who sometimes acquire influence by the very absence of striking and ardent qualities—

the Melancthon of our English Reformation. The greatest defect of his character, want of firmness, which has ruined many a man of genius and learning, by a peculiar combination of circumstances, secured his advancement and guided him to fortune. His mind possessed great acuteness; he could generally perceive what was best, although, had vigorous action been required of him, he would have failed to do justice to the clearness of his views. Such a mind is common enough. Fortunately for the usefulness of Cranmer, the time required of him little more than to follow his bent and be moderate. He was surrounded by vehement and excited spirits, who required all the restraint of his temperate and quiet character. And these very traits of his have impressed upon the Church which he moulded, and upon the public office which he, as primate, had the chief share in drawing up, "a sort of compromising and uncertain character," which has never been lost. It is through Cranmer's influence that the Church of England at the present day is capable of sheltering at once the High and Low Churchman, the Universalist and the Calvinist." His cruel death was one of the most unpopular measures of Mary's government.—See Strype, *Memorials of Cranmer* (Oxford, 1840, 2 vols. 8vo; also 1858, by Barnes, 2 vols. 12mo, and 1864 [*Ecc. Hist. Soc.*], 4 vols. 8vo); Todd, *Life of Cranmer* (Lond. 1881, 2 vols. 8vo); Le Bas, *Life of Cranmer* (Lond. 1838, 2 vols. 12mo; N. Y. 18mo); Burnet, *Hist. Reformation* (passim); Gilpin, *Life of Cranmer; Eng. Cyclopaedia* (which has been freely used in the preparation of this article). Cranmer's writings are still of value for theology as well as for Church history. A full list of them is given by Jenkins, *Remains of Abp. Cranmer, collected and arranged* (Oxf. 1833, 4 vols. 8vo). The "Parker Society" has republished Cranmer's *Writings on the Lord's Supper* (Camb. 1844, imp. 8vo), and his *Miscellaneous Writings and Letters* (Camb. 1846, imp. 8vo).

Crantz. See KRANTZ.

Crassus (Græcized Κράσος), fully M. LICINIUS CRASSUS, surnamed *Dives* ("the Rich"), one of the members of the first Roman triumvirate, was born about B.C. 105, and after various civil and military engagements, on the triumviral coalition started, B.C. 56, as governor of the consular province of Syria (where he succeeded Gabinus, Josephus, *Ant.* xiv, 6, 4), on a campaign against the Parthians. On his way he stopped at Jerusalem (according to Josephus, *War*, i, 8, 8, although the statement is confirmed by no other historian of the times, and this city lay off his route) and plundered the Temple, as he did likewise that of the goddess Derceto at Hierapolis, in Syria (Strabo xvi, in fin.). Infatuated by this sacrilege (Prideaux, *Connection*, pt. II), he proceeded on his campaign, which ended in his defeat, capture, and death (Dio Cass. xl, 27). Plutarch wrote a life of Crassus.—Smith, *Dict. of Class. Biog.* s. v.

Cratès (Κράτης; Vulg. translates *prolatus est*), governor of the Cyprians (ὁ ἐπί τῶν Κ.), who was left in charge of the "castle" (τῆς ἀκροπόλεως) of Jerusalem (?) during the absence of Sostratus, in the reign of Antiochus Epiphanes (2 Macc. iv, 29).—Smith, s. v.

Crato von Crafftheim (*Krafft*), JOHANNES, a prominent representative of Protestantism in Austria, was born at Breslau Nov. 22, 1619. At the University of Wittenberg, to which he went in 1584, he lived for six years in the house of Luther, and while there collected the material for the *Table-talk of Luther*, which was subsequently published by his friend Aurifaber. He became also intimate with Melancthon, whose theological views he, on the whole, adopted. Upon the advice of Luther, he left the study of theology, on account of his feeble health, for that of medicine. In 1560 he was appointed city physician in his native city, Breslau. His successful practice,

especially during the prevalence of the plague in 1558, and a number of able works, procured him a great reputation and an appointment as imperial private physician (1560), which position he retained during the reign of the emperors Ferdinand, Maximilian II, and Rudolph II. He lived at the imperial court of Austria from 1563 to 1581, was made an imperial councillor, and a nobleman under the name of Crato of Crafftheim, and received from the emperor Maximilian II, who was favorable to Protestantism, the privileges of a *Comes Palatinus*, and many other proofs of favor. At the court of Austria he was one of the most zealous and influential representatives of Protestantism, and took a leading part in the regulation of the affairs of the Protestant Church. Being at first a moderate Lutheran of the Melancthonian school, and an earnest opponent of the exclusive system of Flacius, he gradually embraced the views of the "Reformed" Church, with many prominent men of which he was intimately acquainted. After the death of Maximilian (1576), the influence of the Jesuits for a short time occasioned his dismissal from the court, but in 1578 he was recalled. In 1581, tired of court life, he withdrew of his own accord. In 1588 he returned to Breslau, where he exercised a great influence upon the courts of Liegnitz, Brieg, and Ohlau. He died Oct. 19, 1586. See Gillet, *Crato von Crafftheim und seine Freunde* (Frankf. 1860, 2 vols.); Herzog, *Real-Encyclop.* xix, 363.

Cravens, WILLIAM, a celebrated and eccentric Methodist Episcopal minister, was born in Rockingham County, Va., July 31, 1776. Converted in 1794, he began to preach about 1800, and for many years, as a local preacher, he served the Church in his native state. He travelled extensively without fee or reward, everywhere producing great effects by his courageous denunciations of sin. He was a strenuous opponent of slavery, and, having emancipated his own slaves, removed to the West in 1819, chiefly with a view to their advantage. In 1820 he was admitted on trial in the Missouri Conference, which then embraced Illinois, Indiana, and part of Tennessee. He continued to travel and preach on the frontier to the day of his death, which took place at his house, Washington County, Ind., Oct. 10, 1826. He was a man of great physical power, a vast fund of wit and humor, and indomitable energy. Virginia and the West abound in stories of his adventures, which, if collected, would make a biography of romantic interest.—*Minutes of Conferences*, i, 573; Stevens, *History of Methodism*; Wakely, *Heroes of Methodism*.

Crawford, Elijah, a Methodist Episcopal minister, was born in New York in 1812. Trained in a pious household, his youth was virtuous, and at seventeen he united with the Church. His early manhood was spent in trade, but in 1835 he entered the itinerant ministry in the New York Conference. His steadfast piety, manliness or character, and diligence, both in study and labor, in a few years gained him the confidence of the Church, and he filled with great acceptance a number of important pastoral charges. His last station was Hartford, Conn., where he died of dysentery September, 1849.—*Min. of Conferences*, iv, 454.

Crawford, John, a Methodist Episcopal minister, was born in Westchester County, N. Y., in 1761, was converted in 1787, entered the itinerant ministry in the New York Conference in 1789, became superannuated in 1819, and died in 1851, aged over ninety years. He was "a sound and earnest preacher, eminently faithful and punctual, always cheerful, and living the religion he preached."—*Min. of Conferences*, iv, 579.

Creagh, BARTHOLOMEW, a Methodist Episcopal minister, was born in Dublin in 1804, and was converted at sixteen. His studies in Greek and Latin were pursued at Belfast. In 1822 he came to America, and soon, by his admirable qualities of intellect and heart, gained many friends. He entered the itinerant

ministry in the New York Conference in 1827, and for fifteen years was in great repute as an earnest, eloquent, and successful minister. For four years he was presiding elder, and was a delegate to the General Conference in 1848 and 1852. The record in the *Minutes* states that "he was among the very best models of ministerial excellence, a holy man, a faithful pastor, a generous friend." He died at Williamsburgh, Aug. 10, 1852.—*Minutes of Conferences*, v, 211; Sprague, *Annals*, vii, 781.

Creationism. See CREATIONISM.

Creation. Creation is the absolute bringing into existence of the world by God. It is that act of God by which he, standing before and above all mundane and natural things, made and arranged the universe. It embraces everything which is not God.

1. *The Idea of Creation.*—In order to form a proper conception of what creation is, we must concede the absolute dependence of the world upon God. We err in limiting it to the mere beginning of the world. It is true that it was that divine act by which all objects were brought into being. It therefore stands as the beginning of all divine operation in the world, and of the universal development of the world. But that God created the universe implies not only that he gave a beginning to its existence, but that he continues that existence, and that he is the only fountain of its present being. The world is not self-derived nor self-sustained; it is only from and by God that it now exists. But creation is not a mere accident of the divine character, nor a temporary moment in the divine life, nor an impartation and manifestation of God, nor a blind, passive, and pathological evolution or emanation of the divine essence. Yet it is God's work alone, and was as unconstrained as any other deed performed by divine power. When we say that God created the world, we not only do not affirm, but actually deny that God has imparted himself, and passed into his own work. God is the absolute founder of the world, and he has not passed into its nature, but stands high above all the conditions of created being. Nor, while the world is not God himself, can it be said to partake of any other divine nature. It is simply God's work and manifestation; it is a creation which is from, by, and for God. Thus the full idea of creation implies that God is the absolute, impartial, and personal Spirit who, of his own free will, gave existence to the universe.

In the Mosaic account of the creation, we find that magnificent testimony of the faith which recognises God's creation in the surrounding world (compare Heb. xi, 3, *Through faith we understand that the worlds were framed by the word of God, so that things which are seen were not made of things which do appear*). This testimony possesses a strong religious and canonical worth, apart from our views of the peculiar character of the cosmogony of Moses, whether we shape them according to the opinions of the old Church theologians, who held that the Mosaic account was actual history; or whether we harmonize with the modern allegorists, who claim that it is prophecy reversed, or prophetic vision; or whether we take the low view of attributing to it a mythical character. The most important portion of this, as of other scriptural statements concerning the creation, is contained in the proposition that God, in his eternal, infinite love, is the only highest cause; that he is limited by no principle beyond himself; that he is the independent Founder of the world. By *world* we mean *κόσμος*, *αἰῶνες*, Heb. i, 2, 11, or the *universe*, which is always described in the Old Testament, and usually in the New, as "heaven and earth," "heaven, earth, sea, and all which is therein." It is God alone who has brought all things into being (Heb. iii, 4; Acts xvii, 24; xiv, 15; Rev. iv, 11; Heb. xi, 3; Psa. xxxiii, 6; cii, 26; Isa. xlv, 18; Jer. x, 12). Nothing has had a

being without the Logos of God (John i, 3). Everything owes its existence and its life to the word of God. It is because God endowed it with entity; because he so willed it; *ὅδι τὸ θέλημα σου* (Rev. iv, 11); by his word, *רִמָּא*, *רָמַד* (Heb. xi, 3; Psa. xxxiii, 6); by his speaking (Gen. i, 3; 2 Cor. iv, 6); by his absolute power, *παντοδύναμος χρις* (Wisd. Sol. xi, 18); and by his personal power (Jer. x, 12), in which he needed no assistance whatever, but by which he was able to create whatever he desired (Psa. cxv, 3, cxxxv, 6). By this power he, in his own supreme majesty, evoked into existence that which was non-existent (Rom. iv, 17; Psa. xxxiii, 9), and by virtue of the same omnipotence is able to annihilate what he has called into being (Psa. civ, 29; cii, 26, etc.; Isa. li, 6; Luke xxi, 38; Rev. xxi, 1, 4). The Spirit of God, or "the breath of his mouth," which (Psa. xxxiii, 6) stands parallel with the creative word that "moved upon the face of the waters," is nothing less than the active, forming, animating, divine power. The strength by which God creates takes its place beside his wisdom and knowledge (Jer. x, 12; Rom. xi, 38); and the divine wisdom or intelligence appears to have been (Prov. viii, 22, etc.) the first ground and adjusting principle of creation. Instead, however, of reading in John i, 3, of this world-creative "wisdom," we find a description of the same eternal Logos of God who became flesh in Christ. Thus the creative principle is identified with that of redemption; and while the creation is distinguished as an act of love, the highest revelation of that love is to be found in the incarnation of God in the world. In both creation and redemption we perceive the thought that God, without the intervention and aid of any foreign power, gave existence to that which had previously no being; and that he did this by virtue of no blind necessity, but by his own volition alone.

It may be proper here to treat briefly of the meaning of *בָּרָא* (*bara'*, "create"), in Genesis, chap. i. Gesenius and Fürst agree in giving to this word *bara*, in Genesis i, the sense of proper creating, although they seem to give that of *cutting* as the primitive (not usual) idea inherent in the root, comparing as cognate *בָּרַח*, to *choose*, *בָּר*, a *son* (which Fürst, on the other hand, derives from *בָּרַן*), and the Arab. *bara*, etc. Gesenius refers to the Piel form of the Heb. root (*בָּרַע*, to *fashion*), as the most characteristic (?) conjugation. He concludes, however, with the following judicious note (*Theasaur. Heb.* p. 236): "In the trite dispute of interpreters and theologians concerning creation out of nothing, some appeal likewise to the word under consideration, as if it might be gathered from its very etymology and proper signification that the first chap. of Genesis teaches not a creation from nothing, but a conformation of matter eternally existing. On the contrary, from the instances we have given, it will abundantly appear that the actual use of this word in Kal is altogether different from its primary signification, and that it is rather employed with respect to the new production of a thing (see Gen. ii, 3) than to the conformation and elaboration of material. That the opening clause of Genesis sets forth the world as first created out of nothing, and this in a rude and undigested state, while the remainder of the first chapter exhibits the elaboration of the recently created mass, the connection of the whole paragraph renders entirely plain. So also the Rabbins (Aben-Ezra ad Gen. i, 1: 'Most hold *בְּרִיאַת לְהַרְוֵא יֵשׁ בְּרִיאַת*, that creation is the production of a thing from nothing') and the N.-T. writers (Heb. xi, 3; Rom. iv, 27; comp. 2 Macc. vii, 28) teach, although the writer of the Book of Wisdom (xi, 17), following the Grecian dogmas, holds matter to be eternal. See on this question Mos. Maimon. in *More Nebochim*, iii, 13; Mosheim, *De creatione mundi ex nihilo*, appended to Cudworth's *Intellectual Sys-*

tem; Beansobre, *Hist. de Maniché et du Manichéisme*, vol. ii, bk. v, chap. iv."

The examples to which Gesenius refers as sustaining this position are (in addition to the equivalent Arab. *bāriqun*, creator, Koran, Sur. ii, 51; *bāriqatun*, creature, Abulf. *Ann.* i, 18; Janhar. *Spec. ed. Schneid.* p. 14; and all the other Shemitic tongues, which have the same usage), the following: "Spoken of the creation of the heaven and earth, Gen. i, 1; Isa. xl, 26; xlv, 18; of the bounds of the earth, Isa. xl, 26; of the wind, Amos iv, 18; of men, Gen. i, 27; v, 1, 2; vi, 7; Deut. iv, 32; Isa. xlv, 12; Psa. lxxxix, 48; Mal. ii, 10; specially, of Israel, Isa. xliii, 1, 15; of beasts, Gen. i, 21; of light and darkness, Isa. xlv, 7, etc. Add these examples: Psa. li, 12 ('create in me a clean heart, O God'); Isa. xlv, 7 ('I make peace, and create evil'); Jer. xxxi, 22 ('the Lord hath created a new thing; comp. Num. xvi, 30). It is used with a double accusative, Isa. lxxv, 18 ('I create Jerusalem a rejoicing, i. e. joyous); iv, 5; xlviii, 7. The participle (בְּרִיאָה, the plur. of *majesty*, but according to many MSS. in the sing. בְּרִיאָה) stands for the Creator (Eccl. xii, 1). בְּרִיאָה is joined with the words בָּרָא [yatsar, to form], in Isa. xliii, 7; xlv, 18; and עָשָׂה [asah, to make], in Isa. xli, 20; xlv, 7, 12; generally as synonymous: with the latter it is not seldom interchanged, Gen. i, 26 (comp. ver. 27); ii, 4; but that there is nevertheless a difference at least between these two is evident from Gen. ii, 8 ('which God created and made,' בְּרִיאָה לַעֲשׂוֹת [where the ל of union is generally regarded as epexegetical]). These words, which have perplexed many, even Hebrew interpreters, L. de Dieu (ad loc.) has rightly explained by adducing parallel phrases (בְּרִיאָה לַעֲשׂוֹת, בְּרִיאָה לַעֲשׂוֹת, etc.), as meaning produced by making, i. e. made by producing something new; comp. Jer. xxxi, 22, and בְּרִיאָהוּ (ib. p. 235). The word occurs (in the Kal or simple form) likewise in Psa. lxxxix, 12; Isa. xlii, 5; xlv, 8, 18; liv, 16; lvii, 19; lxxv, 17 (in the Niphal or passive) Gen. ii, 4; v, 2; Psa. cii, 18; civ, 30; cxlviii, 5; Ezek. xxi, 80; xxviii, 13, 15 ('done'); Exod. xxxiv, 10.

From this examination, it is evident that although the word in question is etymologically connected with roots (like the Engl. *pare*, Lat. *paro*, etc.) that have a less decided import, yet its current and legitimate signification is that of creation in the modern and proper acceptation. As the Hebrews were not given to philosophical disquisition, their language is peculiarly barren in terms expressive of metaphysical or dialectical niceties, and hence they frequently employed this word in less exact applications. Moreover, as the act of creation was in the nature of the case but once performed, the term could only be used infrequently with reference to that event, just as "create" with moderns etymologically and even practically refers rather to production in a subordinate sense than to absolute origination. In both words, however, the higher and full sense is never lost sight of, and thus they appear as nearly synonymous in actual usage as any two in different and widely remote languages could well be. The translators of the Auth. Vers. have therefore done well by invariably (except in the single passage above noted) rendering בְּרִיאָה (in Kal and Niphal at least), and no other Heb. term, by *create*.

The N.-T. writers employ in the same sense κτίσις (with the nouns κτίσις, creation, κτίσμα, creature, and κτίστης, creator) as the nearest equivalent in Greek, after the example of the Sept., in most passages (in Gen. it has κτίσις). See Macdonald, *Creation and Fall* (Edinb. 1856), p. 61-4.

That this absolute sense is the true one in Gen. i, 1, at least, is demonstrable from the association there with the term "beginning." For if matter had existed eternally, there would have been no proper "be-

ginning" at all of its existence; and to understand the mere arrangement of chaotic elements by the phraseology in question would be to confound something that is said to have taken place "in the beginning" with what is afterwards detailed under successive days. On the other hand, if matter be not eternal, it must at some time have been brought into being, and precisely that act would be the real "beginning" of all material things. This is obviously what the sacred writer intended to state: in opposition to the general belief of antiquity, he affirms that matter was originally the direct product of divine power, and from this event he dates the history of the physical universe.

II. *God's Motive in Creation.*—This motive has been ascribed by doctrinal writers to the free operation of God's love, his *bonitas communicativa*. He was not affected by any compulsion or selfish desire. In the essence and volition of divine love, all the much-discussed antagonism between freedom and necessity is cancelled. To suppose that the creation could have been otherwise than it was is an abstraction of no utility whatever. We only speak *relatively* when we declare that God could not have created otherwise than he did. But if we make the same affirmation *absolutely*, we degrade God's freedom to abstract authority, and creation to accident or a mere experiment. The necessity in which God created the universe is the definitiveness of his own will, his self-determination which he possesses by virtue of his own divine character. It is not an external compulsion, but an interior impulse of the divine nature to manifest itself; a necessity of God's love to communicate itself. The question whether God could have created any other world than he has was discussed earnestly by the Scholastics, and later by Leibnitz in his Theodicy. If we imagine that God had a number of world-plans, out of which he selected the one which he consummated, we concede too much to the Optimists. That creation which he brought into being was the only one to which he was moved by the deep inner love of his infinite divine character. The aim which God had in view was not his own glory exclusively; he was not impelled by a purely egotistical power, but by eternal love; he desired the good of his creatures; and it was only as he wished his creation to be pure that he desired to be glorified by that purity. All created beings are not solely means for an end; but they have been created for their own sake, that they might receive the communications of God and be permeated by his goodness; not that they might subsequently be absorbed in him, but rest eternally happy in and with him. Creation reached its aim relatively in personal creatures and absolutely in Christ the God-man. The kingdom of the natural creation attains its perfection in the kingdom of grace and glory; the effulgence of the glory of God appears in, and concurs with, the happiness of his creatures; and the perfection of the Church takes place, not by the overthrow, but by the renewal and illumination of the world in God (2 Pet. iii, 18; Isa. lxxv, 17; lxxvi, 22; Rev. xxi, 1; comp. Rom. viii, 19, etc.; comp. Twisten, *Vorles. üb. d. Dogmatik*, ii, 89).

III. *Time occupied in Creation.*—La Place's theory of the formation of the whole solar system is that it was originally a mass of vapory or nebulous matter, which, according to the laws of gravitation, assumed the form of an immense sphere. This sphere received from without an impulse which caused it to revolve on its axis from west to east. In consequence of the revolution, the mass became flattened at the poles and swollen in the equatorial region. In consequence of the greatness of the centrifugal force at the equator, and the contemporaneous condensation and contraction of the nebulous mass, a free revolving ring, similar to that of Saturn, detached itself in the region of the equator. This ring, not being of uniform density, and in consequence of contraction, broke in one

or more places; and these fragments, in obedience to the laws of gravitation, became spheres or planets, all revolving from west to east around the parent mass. Another ring was formed in like manner, and another planet came into existence; and so on, until the whole solar system was complete. According to this theory, not only the earth, but all the planets, existed before the sun in its present condition; and thus some of the supposed difficulties of the Mosaic cosmogony are removed (M'Caul, *Aids to Faith*, p. 242, 243), for it is implied in this theory that the earth existed before the sun became the luminary of the system.

In order to arrive at some conclusion harmonious at once with the results of modern science and the account of Moses, we must determine the meaning of the terms "in the beginning" and "day." The Hebrew word for "beginning," רֵאשִׁית (*reshith*), is in the original without the definite article; so that Moses really says, "In *reshith* (not in the *reshith*) Elohim created the heavens and the earth." The Septuagint, Chaldee, and Syriac versions corroborate the antiquity and correctness of this reading. Thus there is an indefiniteness of the time of creation. It may have been millions of years ago just as easily as thousands, for the Hebrew word is indefinite, and the verse reads in substance thus: "Of old, in former duration, God created the heavens and the earth." Arguing from analogy, many contend that the term "day" does not mean literally twenty-four hours. That word often signifies in the Bible undefined periods of time, as the "day of the Lord," "the day of vengeance," "that day," "the night is far spent, the day is at hand." The first day consisted of an alternation of light and darkness; but how long the night lasted, and how long the darkness until the next dawn, is not stated. The whole time of light in which God's creative work proceeded he called "day," and the whole time of darkness he called "night." It was not a day measured by the presence of the sun's light, nor a night measured by the absence of that light. (Compare M'Caul, *Aids to Faith*, p. 231, 246, 247.) The name "day" is therefore regarded as given, not as a measure of extent—which is a later and a subordinate idea—but as denoting a wondrous phenomenon, marking the first great transition, and calling up the dual contrast which has entered into the corresponding name ever since. "God called the light day, and the darkness he called night." He called it *Yom*, and from that has come the lesser naming. We now indicate the gradual, developing character of the creation. It was not the work of six ordinary days, measured by twenty-four hours, but a series of supernatural growths extending over vast periods of time. (Comp. Prof. Taylor Lewis, *Metk. Quart. Review*, April, 1865.)

Others maintain that, while it is true that the word "day" (q. v.) is sometimes used (e. g. in relation to the whole cosmogonical period, Gen. ii, 4) in a vague sense for an indefinite period, or for some set occasion without regard to its length, such a signification in the first chapter of Genesis is emphatically forbidden by the following explicit circumstances subjoined in the context itself: (1) The several demijuric days are regularly numbered—"first," "second," etc., till the last—making an exact and obviously literal week. (2) Each is divided, in the usual Hebrew style, into "night" and "morning," constituting undoubtedly a Jewish *νυκθήμερον*, or *night-and-day*, like the modern phrase "twenty-four hours." (3) To prevent all misconception, these alternations of light and darkness are distinctly called in the same connection "night" and "day." (4) The institution of the Sabbath is based upon the correspondence between this and each of the six preceding days in point of length. To these philological and exegetical considerations, requiring word יום to be here taken in its strictly literal

sense as an actual day, might be added others derived from scientific investigations. (See Hitchcock's *Elementary Geology*, 8d ed., p. 288 sq., and the article COSMOGONY.)

IV. *Eras of Creation*.—The Mosaic account recognises in creation two great eras of three days each—an *Inorganic* and an *Organic*. Each of these opens with the appearance of light: the first, light *cosmical*; the second, light from the sun for the special uses of the earth. Each era ends in a day of two great works; the two shown to be distinct by being severally pronounced "good." On the third "day"—that closing the Inorganic era—there was, first, the dividing of the land from the waters, and afterwards the creation of vegetation, or the institution of a kingdom of life—a work widely diverse from all preceding it in the era. So, on the sixth day, terminating the Organic era, there was, first, the creation of mammals, and then a second far greater work, totally new in its grandest element—the creation of Man. We have, then, the following arrangement:

I. The Inorganic Era.

1st Day.—Light, cosmical.

2d Day.—The earth divided from the fluid around it, or individualized.

3d Day.—{ 1. Outlining of the land and water.
2. Creation of vegetation.

II. The Organic Era.

4th Day.—Light, from the sun.

5th Day.—Creation of the lower orders of animals.

6th Day.—{ 1. Creation of mammals.
2. Creation of Man.

In addition, the last day of each era included one work typical of the era, and another related to it in essential points, but also prophetic. Vegetation, while for physical reasons a part of the creation of the third day, was also prophetic of the future Organic era, in which the progress of life was the grand characteristic. The record of Moses thus accords with the fundamental principle in history, that the characteristic of an age has its beginnings within the age preceding. So, again, man, while like other mammals in structure, even to the homologies of every bone and muscle, was endowed with a spiritual nature, which looked forward to another era—that of spiritual existence. The "seventh" "day"—the day of rest from the work of creation—is man's period of preparation for that new existence; and it is to promote this special end that, in strict parallelism, the Sabbath follows man's six days of work.

Some "interpreters contend that the whole account is to be taken together; that the days are to be understood as literal days; but that the whole, however, is to be interpreted as referring to a more remote period than is commonly imagined, and as not intended to describe the *existing* species of plants and animals, but various other species, now extinct, which have been, by *subsequent* convulsions of nature, destroyed, while others have been successively, by fresh acts of creation, introduced in their place."

"Another interpretation, that of Dr. J. Pye Smith, in his volume on the *Relations of Scripture to Geology*, etc., is briefly this: the separation of the first verse he adopts as above: this refers to the original universal creation; and in the vast undefined interval an almost unlimited series of changes in the structure and products of the earth may have taken place. After this, at a comparatively recent epoch, a *small portion* of the earth's surface was brought into a state of disorder, ruin, and obsecuration, out of which the creation of the existing species of things, with the recall of light, and the restored presence of the heavenly bodies, took place literally, according to the Mosaic narrative, in six natural days."

"Lastly, others have thought that the whole description must be taken literally as it stands; but yet, if found contradicted by facts, may, without ri-

lence to its obvious design and construction, be regarded as rather intended for a mythic poetical composition, or religious apologue, than for a matter-of-fact history." (See Kitto's *Jour.* iii, 159; v, 186; *Lit. and Theol. Rev.* iv, 626; *New Englander*, ix, 510; *Meth. Rev.* vi, 292; xii, 497; *De Bow's Rev.* iv, 177; *Hitchcock's Religion and Geology*, § 2; *Biblioth. Sacra*, xii, 88, 828; xiii, 748; *Jour. Sac. Lit.* 1855; *Amer. Bibl. Repos.* vi, 286.) See GEOLOGY.

To sum up, there are three theories of creation: 1. *The old orthodox view.* This has been most recently defended by Kell. It claims that the world was created in six ordinary, literal days. 2. *The Restitution Hypothesis.* According to it, the theosophic declaration of the *Tohu va Bohu* is accepted. The geological epochs which extend from the first earth-formations down to the diluvium form an incalculably long period before the creation of light, and before the other creative acts recorded in Genesis 1, 8, etc. Therefore the Mosaic six days' work is but the restitution of a preceding organic creation which had been previously many times disorganized and overwhelmed. Chalmers and Buckland were the first to advocate this hypothesis. They have been followed by Hengstenberg, Kurtz, Andr. Wagner, and partially by Delitzsch. 3. *The view of the Harmonists or Concordists*, such as Cuvier, De Serres, Hugh Miller, Ebrard, and others. They hold that the six days are periods of great indefinite length, and are therefore reconcilable with the creative epochs of geology. Parallel with these days are the long geologic formations. Schultz has just written in advocacy of this theory. His work is one of the most satisfactory and exhaustive of all the writings on this important branch of scientific geology.

See, in addition to the works already cited, Hugh Miller, *Testimony of the Rocks*; Dana, *Manual of Geology*; Richers, *Die Schöpfungsgeschichte*, (Leipzig, 1854, 8vo); Keerl, *die Schöpfungsgeschichte u. d. Lehre vom Paradies* (reviewed by Warren, *Bibliotheca Sacra*, Oct. 1868, 2d ed. 1869); Giov. Pianciani, *Cosmogonia naturale comparata col Genesi* (Roma, 1862); P. Laurent, *Études Géologiques sur la Cosmogonie de Moïse* (Paris, 1868); F. H. Rensch, *Bibel und Natur* (Freiburg, 1862); F. Michelis, the chief advocate of the Restitution theory, in his journal, *Natur und Offenbarung*; F. W. Schultz, *Die Schöpfungsgeschichte nach Naturwissenschaft und Bibel* (Gotha, 1865); Baltzer, *Die biblische Schöpfungsgeschichte* (Leips. 1867, vol. 1); Wolff, *Bedeutung der Welt-schöpfung nach Natur und Schrift* (Frankfort, 1866); Zöckler, in *Der Beweis des Glaubens*, No. 1, translated in *Meth. Quart. Rev.* April, 1866, art. 2; Taylor Lewis, *Six Days of Creation.* See GENESIS; MAN; SPECIES.

Creationism, or (in the German mode of spelling from a supposed adjective) Creatianism, is a technical term (very common among German philosophers and divines, but not yet fully naturalized in English) for one of the three or four theories concerning the origin of the human soul. It derives not only the soul of Adam, but every rational soul, directly from God, though not by way of an emanation in a Gnostic or pantheistic sense, but by an act of creation; and supposes that the soul is united to the body at the moment of its generation or afterwards. It differs from traducianism or generationism, so called, which teaches that the soul is propagated, together with the body, through the process of generation from age to age, and from the theory of pre-existence, which assumes that each soul descends from another world, and a previous mode of existence, into the body, to leave it again at the close of its earthly pilgrimage. Creationism is traced back to Aristotle, who made an essential distinction between the animal soul (*ψυχή*) and the rational principle (*νοῦς*), and derived the former, together with the body, from generation, the latter from without or above, as a part or reflex of the general reason of God. Plato, on the other hand, taught the theory of pre-ex-

istence, which was introduced into Christian theology by Origen. Tertullian was the founder of traducianism. The whole question of the origin of the soul was first seriously discussed during the Pelagian controversy, in connection with the problem of hereditary sin and guilt. (See Schaff, *Church History*, iii, 890 sq.) Pelagius, and several Oriental fathers, held the creation theory, which fell in with his view of the complete innocency of every child that is born. Jerome was also a creationist, although he wrote against Pelagius. "Quotidie," he says, "Deus fabricatur animas, cujus velle facies est, et conditor esse non cessat." He appeals for this view to the unceasing creative activity of God, and to such passages as John v, 17; Zech. xii; Psa. xxxiii, 15. Augustine frequently discussed the question, but never arrived at a satisfactory solution. He wavered between creationism and traducianism; but, on the whole, he was inclined to the latter, which best agreed with his doctrine of hereditary sin. "Where the Scripture," he says, "renders no certain testimony, human inquiry must beware of deciding one way or the other. If it were necessary to salvation to know anything concerning it, Scripture would have said more." Among Augustinian divines traducianism has found more acceptance. But creationism has never been without supporters, among whom Leibnitz (in his *Theodicy*) occupies a prominent position. The great argument in favor of creationism is that it guards the dignity and spirituality of the rational soul, which differs in kind from the animal soul, and is the proper seat of the image of God. Traducianism is liable to the objection of materializing the soul. But creationism makes the union of body and soul accidental and mechanical, and does not account for the transmission of sin from generation to generation. It must either confine sin to the sensual sphere, which is not true (for unbelief, pride, profanity, blasphemy, are spiritual sins), or assume that each soul becomes sinful by contact with the naturally generated body; since, from the creative hands of God, it can only proceed free from sin and defect, like the soul of our first parents. These difficulties on both sides point to a theory which combines the truths of creationism and of traducianism, and avoids their errors. Every human being, both as to body and soul, is a child of its parents, and at the same time a creature of Almighty God.

Creature (prop. שֶׁרָץ, *ne' p'heeh*, animated or spirit-having thing; *κρίσμα* [less distinctively *κρίσις*; on Rom. viii, 19, see the *Baptist Quarterly*, Apr. 1867, art. 2]; but also שֶׁרָץ, *she'rets*, "moving creature," elsewhere "creeping thing," i. e. not merely reptile [q. v.], but any gliding or short-legged quadruped), a general term in the Scriptures for any animal (q. v.). See also DOLEFUL CREATURE.

In the New Test. this word designates, 1. *The whole creation*, any or all created objects or beings; so Rom. viii, 39, "Nor height, nor depth, nor any other creature," etc.; Col. i, 15, "the first-born (Master) of every creature;" Rev. iii, 14, "the beginning (source) of the creation of God; comp. also Rev. v, 18; Heb. iv, 18. 2. *Humanity*, or the whole human race, in the universal sense; so Mark x, 6, "But from the beginning of the creation (*κρίσεως*) God made them male and female." The word here cannot mean the creation in general, since we find *αβροῦς* to explain the word *κρίσις*, or to bring the meaning back to it. Mark xvi, 15, "Preach the Gospel to every creature;" Col. i, 28, "the Gospel which was preached to every creature which is under heaven." That mankind alone is here alluded to is self-evident, and the expression "under heaven" shows that all reasonable beings on earth are to be included in the meaning. Particularly remarkable, though different in sense, is the passage Rom. viii, 19-22. "For the earnest expectation of the creature waiteth for the manifestation of the sons of God. For the creature

was made subject to vanity, not willingly, but by reason of him who hath subjected the same in hope; because the creature itself also shall be delivered from the bondage of corruption, into the glorious liberty of the children of God. For we know that the whole creation groaneth, and travaileth in pain together until now," in which also the expression creature is used to designate the totality of mankind. This is first indicated by the *γάρ* in verse 18, which brings forward in behalf of the *κτίσματα* which rests on it, that "all mankind takes part in this aspiration and in the hope of future glorification." In ver. 28, Christians, as part of humanity, are set over against the whole of it. We cannot here place Christians in contrast with the inanimate creation, and overlook entirely the non-Christian part of mankind, to whom a vague longing after the glorious freedom of the children of God could be better attributed than to inanimate nature. Paul nowhere speaks of a "change" or glorification of the earthly abode of men; this *δόξα* is exclusively reserved for man (1 Cor. xi, 85-50).—Krehl, *N. T. Handwörterbuch*; see also Ellicott, *The Destiny of the Creature*, 2d. ed. 1862; *Journal of Sacred Literature*, Oct. 1862, p. 27.

The LIVING CREATURES spoken of in Ezekiel x, 15, 17, 20 (*חַי*, *chay*, alive; the ζῷον of Revelations vi, vi, sq., improperly "beast"), are imaginary or composite beings, symbolical of the divine attributes and operations, such as were common in the

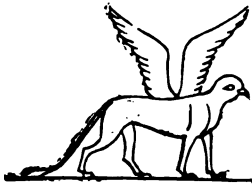

Ancient Oriental composite Winged Figures: 1. Egyptian; 2. Assyrian.

mythological representations of all antiquity. See CHERUB.

CreDESCENCE-table, or CREDESCENCE, a table beside the altar, on which the cup, etc., are placed in the celebration of the mass. Du Cange says that the word *credentiarius* means *pragustator*, one that tastes beforehand, and the reference seems to be to an ancient court-practice, performed by cup-bearers and carvers, who were required to taste the wines and meats which they presented (*securitatis gratiâ*), to insure the safety of the monarch. The Italian word *credenziera* has the same meaning. Hence also the *credents-teller*, credence-plate, on which cup-bearers credenced the wine, and which means generally a plate on which a person offers anything to another; *credens-tische*, credence-table, a sideboard, a cupboard with a table for the purpose of arranging in order and keeping the drinking-apparatus therein. Credences were common in ancient churches. In the Liturgies under the names of Chrysostom and St. James we meet with the words *πρόθεσις* and *παράραπίλλον*. In the *Ordo Romanus* the names *oblacionarium* and *prothesis* occur, and one is made the explanation of the other. We meet also with the word *paratorium*, because when the offerings were received, preparation was made out of them for the Lord's Supper. In many instances the place of the credence-table was supplied by a shelf across the piscina: this shelf was either of wood or stone, and is found in many old churches. The use of cre-



Credence-table.

den-ce-tables is one of the restorations of obsolete usages which have marked the so-called Puseyite movement in England.—Farrar, *Eccles. Dict.* s. v.; Coleman, *Ancient Christianity*.

Creditor (קַדְוָה, *noshek'*, a lender, 2 Kings iv, 1: Isa. l, 1; elsewhere "extortioner," "usurer," etc.: מַשְׁהֵב, *mashahek'*, debt, Deut. xv, 2; δανειστής, a lender, Luke vii, 41). See DEBT; LOAN.

Credner, KARL AUGUST, was born Jan. 10, 1797, at Waltershausen, near Gotha. He studied at Jena, Breslau, and Göttingen. In 1830 he became professor extraordinary of theology at Jena, and in 1832 obtained the appointment of ordinary professor at Gießen. He died in 1857. Among his numerous writings are, *Der Prophet Joel übersetzt u. erklärt* (Halle, 1831):—*Beiträge z. Einleit. in die biblischen Schr. i:—Die Evangelien der Petriener oder Judenchristen* (Halle, 1832, ii):—*Das alttest. Urevangelium* (Halle, 1833):—*Einleit. in das N. T.* (Halle, 1836):—*Zur Gesch. des Kanons* (Halle, 1847; new edition by Volckmar, with additions, Berl. 1860):—*Das N. T. für denkende Leser* (Gieß. 1841-43, 2 vols.). Credner was one of the chief representatives of the Rationalistic school in Germany. In many of his works his theological views are but little apparent, and these, especially his *Einleitung*, are generally valued by theologians of all schools for their vast amount of information. In some of his later works, however, he shows himself a very determined Rationalist. Credner took also an active part in the religious controversies of his time, publishing a number of books in defense of the rights of the Rationalistic party to remain in the state church, and to enjoy liberty of preaching and teaching (*Die Berechtigung der protestant. Kirche Deutschlands*, 1845; *Asteriken*, 1847; *Die sündlichen Verirrungen*, etc., 1853). Credner also contributed many articles to German periodicals, and to Kitto's *Cyclopædia of Biblical Literature*.—Herzog, *Real-Encyclop.* xix, 366.

Creed (*credere*, to believe), a form of words in which articles of belief are comprehended; not necessarily a complete summary of the faith, but a statement respecting some points which are fundamental, and have been disputed. See CONFESSIOX. For instance, while the doctrine of the *atonement* must be reckoned a fundamental part of the apostle's doctrine, it is yet not in the Apostles' Creed as a doctrine. Hence some infer that it was not *believed*, though the more obvious inference would be that it was not *disputed* (Eden, s. v.)

1. In the early Eastern Church a summary of this sort was called *μάθημα*, the lesson, because the catechumens were required to learn it. Sometimes, from the nature of its contents, or the uses to which it was applied, it was called *σύμβολον*, *symbolum*, a mark, token, or badge, as a seal-ring—the proof of orthodoxy; sometimes *κανών*, *regula fidei*, the rule, or the

rule of faith; *πίστις, the faith*; *ἄρα* or *ἐκδοσις πιστεως, the determination or exposition of the faith*. The word *σύμβολον (watchword, token)*, "whether borrowed, as some of the fathers assert, from military language, or, as others assert, from the signs of recognition in use among the heathen in their mysteries, denotes a test and a shibboleth whereby each church may know its own, and is circulated through its members as a warning against the snares of enemies or false brethren" (Hinds, *Early Christianity*, pt. iii, ch. vi).

"Many confessions of faith are to be found, nearly corresponding with the creeds which we now possess, in the writings of the earliest fathers. For example, in Justin Martyr, Irenæus, Tertullian, Origen, Cyprian, the Apostolic Constitutions (cited in Wall, on *Jesuit Baptism*, II, pt. ii, ch. ix, § 10, p. 439, and in Bingham, bk. x, ch. iv). We have also creeds of several different churches preserved to us, agreeing in substance, but slightly varying in form; as, the creeds of Jerusalem, Cæsarea, Alexandria, Antioch, Aquileia, etc. (see them in Bingham, l. c.). But until the time of the Council of Nice there does not appear to have been any one particular creed which prevailed universally, in exactly the same words, and commended by the same universal authority" (Browne, *On the Thirty-nine Articles*, art. viii).

As for the *authority of creeds*, the Protestant doctrine is that the creed may be *norma doctrinæ* (standard of doctrine), but that the Bible alone is *norma fidei* (rule of faith). So Dr. H. B. Smith (*Discourse on Christian Union*), speaking of the Westminster Confession, says, "We receive the Confession, not as a rule of faith and life, for this only the Scriptures can be, but as containing our system of faith, in contrast with Arminianism and Pelagianism, as well as Socinianism and Romanism. We accept it in its legitimate historical sense, as understood and interpreted through the history of our church . . . and as 'containing the system of doctrine taught in the Holy Scriptures.' My liberty here is not to be judged of another man's conscience. Any other view not only puts, for all practical purposes, the Confession above the Scriptures, but also puts somebody's theological system above the Confession." The experience of the Church has attested the value of creeds as standards of doctrine. Churches without creeds (e. g. the Society of Friends) have been torn by doctrinal dissensions quite as thoroughly as those which have adopted confessions of faith. See **CONFESSIONS**.

2. The first object of creeds was to distinguish the Church from the world, from Jews and pagans. In this view, the earliest formularies of this kind contained simply the leading doctrines and facts of the Christian religion; and it was only necessary that they should be generally and briefly expressed; the difference lying not in the exposition, but in the *creden-da*, the "things to be believed" themselves. The second object was to distinguish between persons professing the Christian faith; between those who retained the apostolic doctrine, and those who, through unauthorized speculations, had departed from it, and fallen into different errors on important points. Creeds of this kind, therefore, contained the fundamental truths, with brief expositions, declaratory of the sense in which they were to be understood, in order to the full reception of the doctrine of Scripture respecting them. The *Apostles' Creed* is of the first class, the *Nicene* and *Athanasian* of the second; the *Nicene*, especially, having the most solemn sanction of the congregated churches of Christ. Other creeds and confessions have been at later periods adopted by different churches, orthodox in fundamentals, but differing greatly on some questions of comparatively lighter moment. See **CONFESSIONS**. These were so extended, in consequence, as to embrace not only the principal doctrines of the faith, but the peculiar views

of the churches which agreed upon them, on those subjects of controversy by which the age was distinguished. All these are unquestionably tests, and were designed as such, and all were necessary; the first class to secure the renunciation of Judaism and paganism; the second class to exclude those from the Church who had made shipwreck of the faith; the third class to promote peace, by obliging Christians differing considerably in non-essentials to form themselves into distinct religious societies (R. Watson, *Works*, vii, 498). As to the use of creeds as confessions of faith in the Christian Church, see Sartorius, *Nothwendigkeit der kirchlichen Glaubensbekenntnisse* (Stuttg. 1845); Miller, *On Creeds* (Presb. Board); Bonnar, *Scottish Catechisms* (1866), Preface; **CONFESSIONS**.

For the three ancient creeds, the Apostles', the Athanasian, and the Nicene, see below; and also Harvey, *History and Theology of the Three Creeds*; Guericke, *Christl. Symbolik*, § 12; Coleman, *Ancient Christianity*, ch. xiv, § 4; Walch, *Biblioth. Symb. Vetus*; *New Englander*, July, 1865, art. xi; *Amer. Church Rev.*, July, 1866, art. iv; Hare, *Contest with Rome*, p. 318; Burnet, *On the Articles* (Introduction); Shedd, *Hist. of Doctrines*, bk. vii; Bingham, *Orig. Eccles.* bk. x, ch. iii; Vossius, *De Tribus Symbolis Opera*, t. vi; the authorities cited under each head below; and the article **SYMBOLISM**.

CREED, APOSTLES', an early summary of the Christian faith, in which all Christian churches, Greek, Roman, and Protestant, agree. Augustine calls it *regula fidei brevis et grandis; brevis numero verborum, grandis pondere sententiarum*. "The antiquity of this compendium of Christian doctrine, and the veneration in which it has been held in the Church of Christ, are circumstances which deservedly entitle it to be publicly pronounced from time to time in our assemblies as containing the great outline of the faith we profess, and to be committed to the memory of our children, for the perpetuation of that faith from age to age" (R. Watson, *Works*, vii, 498). It is as follows, Latin and English:

Symbolum Apostolicum.

<i>Latin.</i>	<i>English.</i>
Credo in Deum, Patrem omnipotentem, Creatorem cœli et terræ. Et in Jesum Christum, filium ejus unicum, dominum nostrum; qui conceptus est de Spiritu Sancto; natus ex Maria virgine; pærens sub Pontio Pilato; crucifixus, mortuus est, et sepultus; descendit ad inferna; tertio die resurrexit a mortuis; ascendit ad cœlos; sedet ad dexteram Dei Patris omnipotentis; inde venturus est judicare vivos et mortuos. Credo in Spiritum Sanctum; sanctam ecclesiam catholicam; sanctorum communionem; remissionem peccatorum; carnis resurrectionem; et vitam æternam. Amen.	I believe in God the Father Almighty, Maker of heaven and earth, and in Jesus Christ his only Son our Lord, who was conceived by the Holy Ghost; born of the Virgin Mary; suffered under Pontius Pilate, was crucified, dead, and buried; he descended into hell; the third day he rose from the dead; he ascended into heaven, and sitteth on the right hand of God the Father Almighty; from thence he shall come to judge the quick and the dead. I believe in the Holy Ghost; the holy Catholic Church, the communion of saints; the forgiveness of sins; the resurrection of the body; and the life everlasting. Amen.

1. It is held by many writers of the Church of Rome that this creed was composed by the apostles themselves, who, during their stay at Jerusalem soon after our Lord's ascension, under the guidance of the Holy Spirit, agreed upon it as a rule of faith and as a mark of distinction, by which they were to know friends from foes. Rufinus says (about A.D. 400, in his *Exposit. Symboli*): "There was an ancient tradition that the apostles, being about to depart from Jerusalem, first settled a rule for their future preaching, lest, after they were separated from each other, they should expound different doctrines to those whom they invited to the Christian faith. Wherefore, being all assembled together and filled with the Holy Ghost, they composed this short rule of their preaching, each one contributing his sentence, and left it as a rule to be given to all believers" (Harvey, *Ecol. Angl. Vindex*, i, 555; Bingham, *Orig. Eccles.* bk. x, ch. iii).

2. A writer under the name of Augustine pretends to tell us what article was contributed by each apostle. Peter said, "I believe in God, the Father Almighty." John, "Maker of heaven and earth." James, "And in Jesus Christ, his only Son our Lord." Andrew, "Who was conceived by the Holy Ghost, born of the Virgin Mary." Philip, "Suffered under Pontius Pilate; was crucified, dead, and buried." Thomas, "He descended into hell; the third day he rose again from the dead." Bartholomew, "He ascended into heaven, and sitteth at the right hand of God the Father Almighty." Matthew, "From thence he shall come to judge the quick and the dead." James, the son of Alphæus, added, "I believe in the Holy Ghost; the holy Catholic Church." Simon Zelotes, "The communion of saints, the forgiveness of sins." Jude, the brother of James, "The resurrection of the body." Matthias, "The life everlasting." And accordingly the creed was called *Symbolum Apostolicum*, as being made up of sentences jointly contributed after the manner of persons paying each their shot or share of the reckoning. But this derivation obviously confounds the word *σύμβολον* with *συμβολή*.

8. It is now generally admitted that the creed, in its present form at least, is not of later date than the fourth century. a. Neither Luke in the Acts of the Apostles, nor any ecclesiastical writer before the fifth century, makes mention of an assembly of the apostles for the purpose of forming a creed. b. The fathers of the first three centuries, in disputing against heretics, endeavor to prove that the doctrines contained in this creed were taught by the apostles, but they never pretend that the apostles composed it. c. Had the apostles composed it, it would have been the same in all churches and ages. But it is quite otherwise. Many creeds were extant in the fourth century, which differed not only in the terms, but also in the articles; some omitted in one were inserted in others, such as the "descent into hell," the "communion of saints," and "the life everlasting."

4. It is almost impossible now to ascertain the authorship of this creed; its antiquity may, however, be inferred from the fact that the whole, as it now stands, with the exception of "he descended into hell," may be found in the works of Ambrose and Rufinus, the former of whom flourished in the third century and the latter in the fourth.

5. In early ages it was not admitted into the Liturgy, though catechumens were required to subscribe it before they were admitted to baptism. The use of it in public worship was first instituted in the Greek Church at Antioch, and introduced into the Roman Church in the eleventh century, whence it passed into the service of the Church of England at the Reformation. "The Westminster divines subjoined it, along with the Ten Commandments and the Lord's Prayer, to their catechisms, accompanied with this explanatory statement: 'It is here annexed, not as though it were composed by the apostles, or ought to be esteemed as canonical Scriptures, as the Ten Commandments and Lord's Prayer, but because it is a brief sum of the Christian faith, agreeable to the Word of God, and anciently received in the churches of Christ'" (Cunningham, *Historical Theology*, i, chap. iii, 80). It finds its place, with the Decalogue and the Lord's Prayer, in the catechisms of the Methodist Episcopal and Presbyterian churches. It is used in the baptismal confession in the Greek, Roman, English, Reformed, Lutheran, Methodist Episcopal, and Protestant Episcopal churches. The phrase "he descended into hell" is omitted in some forms of the creed used in Protestant churches; in the Protestant Episcopal Church it is optional to use it or "he went into the place of departed spirits." It is to be noted that no other creed than the Apostles' is used in baptism by any Church.

6. Many histories and expositions of the Apostles' Creed have been written; the most valuable are, King,

History of the Apostles' Creed (Lond. 1702, 8vo); Barrow, *Exposition of the Creed*, Works, vol. ii; Pearson, *Exposition of the Creed* (many editions; the best are Dobeon's, Lond. 1840, 8vo, with an appendix containing the principal Greek and Latin creeds; and Boston's, Oxford, 1847, 2 vols. 8vo); Witsius, *De Symbolo Apostolico* (Basil. 1789, 4to; translated by Fraser, Glasgow, 1828, 2 vols. 8vo); Leighton, *Works*, vol. ii. A thorough investigation on the Roman Catholic side may be found in Meyers, *De Symbolo Apostolico titula, origine*, etc. (Trevir. 1849, 8vo). Dr. Nevin furnishes an able discussion in the *Mercersburgh Review*, 1848, three articles; also 1858, p. 895 sq. There is an elaborate article by Prouditt, *Princeton Review*, October, 1852, which opposes not only the Tridentine theory of the origin of the creed, but also the modern mystico-philosophical theory of Möhler and Newman. Apart from these questions, nearly all the churches of Christendom agree in reverence for this ancient formula as a beautiful, true, and comprehensive statement of the great fundamental facts of Christianity; admitting, with Dr. Schaff, that, though it is "not in form the production of the apostles, it is a faithful compend of their doctrines, and comprehends the leading articles of the faith in the triune God and his revelation, from the creation to the life everlasting, in sublime simplicity, in unsurpassable brevity, in the most beautiful order, and with liturgical solemnity; and to this day it is the common bond of Greek, Roman, and evangelical Christendom" (Schaff, *History of the Apostolic Church*, § 142, p. 568). See also Hinds, *Early Christianity*, pt. iii, ch. vi; Procter, *On Common Prayer*, p. 227; Harvey, *The Hist. etc., of the Three Creeds*; Guericke, *Allg. christl. Symbolik*, § 12; Bingham, *Orig. Eccles.* bk. x, ch. iii; Goode, *Divine Rule of Faith and Practice*, ch. iv; Cunningham, *Historical Theology*, ch. iii; Peck, *Divine Rule of Faith and Practice*, 201 sq.; *Princeton Review*, Oct. 1852, art. iv; Shedd, *History of Doctrines*, bk. vii, ch. i, § 2; Martensen, *Dogmatics* (Clark's Library), § 28.

CREED, ATHANASIAN, one of the three great creeds. It was at one time supposed to have been drawn up by Athanasius in the fourth century. It is also called, from its opening words, the symbol *Quicumque vult*. It is as follows:

Symbolum Athanasii.

Latin.	English.
Quicumque vult salvus esse, ante omnia secula est tenent catholicam fidem. Quam nisi quisque integram, inviolatamque servaverit, absque dubio in æternum peribit. Fides autem catholica hæc est, ut unum Deum in Trinitate; et Trinitatem in Unitate veneremus; neque confundentes personas; neque substantiam separantes. Alii est enim persona Pater, alii Filius, alii Spiritus Sanctus. Sed Pater, et Filius, et Spiritus Sanctus, una est Divinitas; equalis gloria, coæternus major, etas. Quæ Pater, talis Filius, talis Spiritus Sanctus. Inæcreatus Pater, increatus Filius, increatus Spiritus Sanctus. Immensus Pater, immensus Filius, immensus Spiritus Sanctus. Æternus Pater, æternus Filius, æternus Spiritus Sanctus. Et tamen non tres æterni, sed unus æternus. Similiter omnipotens Pater, omnipotens Filius, omnipotens Spiritus Sanctus. Et tamen non tres omnipotentes, sed unus omnipotens. Ita Deus Pater, Deus Filius, Deus Spiritus Sanctus. Et tamen non tres Dei, sed unus est Deus. Ita Dominus Pater, Dominus Filius, Domi-	Whoever will be saved, before all things it is necessary that he hold the catholic faith. Which faith, except every one do keep whole and undefiled, without doubt he shall perish eternally. And the catholic faith this: that we worship one God in Trinity, and Trinity in Unity; neither confounding the persons, nor dividing the substance. For there is one person of the Father, another of the Son, and another of the Holy Ghost. But the Godhead of the Father, of the Son, and of the Holy Ghost, is all one: the glory equal, the majesty coeternal. Such as the Father is, such is the Son, and such is the Holy Ghost. The Father uncreated, the Son uncreated, and the Holy Ghost uncreated. The Father incomprehensible, the Son incomprehensible, and the Holy Ghost incomprehensible. And yet they are not three eternal, but one eternal. And yet they are not three uncreated, but one uncreated, and one incomprehensible. So likewise the Father is almighty, the Son almighty, and the Holy Ghost almighty. And yet there are not three al-

men non tres Domini, sed unus est Dominus. Quia sicut singillatim unamquamque Personam Deum et Dominum confiteri Christiana veritate compellimur, ita tres Deos aut Dominos dicere, catholica religione prohibetur. Pater a nullo est factus; nec creatus, nec genitus. Filius a Patre solo est; non factus, nec creatus sed genitus. Spiritus Sanctus a Patre et Filio; non factus, nec creatus, nec genitus, sed procedens. Unus ergo Pater, non tres Patres; unus Filius, non tres Filii; unus Spiritus Sanctus, non tres Spiritus Sancti. Et in hac Trinitate nihil prius aut posterius, nihil majus aut minus. Sed totus tres personae coeternae sibi sunt, et coaequales. Ita ut per omnia (sicut jam supra dictum est) et Unitas in Trinitate, et Trinitas in Unitate veneranda sit. Qui vult ergo salvus esse, ita de Trinitate sentiat. Sed necessarium est ad aeternam salutem, ut incarnatorem quoque Dominum nostrum Jesu Christi fideliter credat. Est ergo fides recta, ut credamus, et confitemur, quia Dominus noster Jesus Christus, Dei Filius, Deus et homo est. Deus est ex substantia Patris ante saecula genitus; et homo est ex substantia matris in saeculo natus. Perfectus Deus, perfectus homo: ex anima rationali et humana carne subsistens. Aequalis Patri secundum Divinitatem, minor Patri secundum humanitatem. Qui licet Deus sit et homo, non duo tamen, sed unus est Christus. Unus autem non conversione Divinitatis in carnem, sed assumptione humanitatis in Deum. Unus omnino, non confusione substantiae, sed unitate personae. Nam sicut anima rationalis et caro unus est homo, ita Deus et homo unus est Christus. Qui passus est pro salute nostra, descendit ad inferos, tertio die resurrexit a mortuis. Ascendit ad caelos, sedet ad dexteram Dei Patris Omnipotentis; inde venturus est judicare vivos et mortuos. Ad cuius adventum omnes homines consergere habent cum corporibus suis, et redditurus sunt factis propriis rationem. Et qui bona egerunt ibunt in vitam aeternam, qui vero mala in ignem aeternum.

Haec est fides catholica, quam nisi quisque fideliter firmiterque crederit, salvus esse non poterit. Gloria Patri, et Filio, et Spiritui Sancto. Sicut erat in principio, et nunc, et semper, et in saecula saeculorum.

mightys, but one almighty. So the Father is God, the Son is God, and the Holy Ghost is God. And yet there are not three Gods, but one God. So likewise the Father is Lord, the Son Lord, and the Holy Ghost Lord. And yet not three Lords, but one Lord. For like as we are compelled by the Christian verity to acknowledge every person by himself to be God and Lord, so are we forbidden by the catholic religion to say there be three Gods and three Lords. The Father is made of none, neither created nor begotten; The Son is of the Father alone; not made, nor created, but begotten. The Holy Ghost is of the Father and of the Son; neither made, nor created, nor begotten, but proceeding. So there is one Father, not three Fathers; one Son, not three Sons; one Holy Ghost, not three Holy Ghosts. And in this Trinity none is afore or after another, none is greater or less than another. But the whole three persons are co-eternal together, and coequal. So that in all things, as is aforesaid, the Unity in Trinity and the Trinity in Unity is to be worshipped. He therefore that will be saved must thus think of the Trinity. Furthermore, it is necessary to everlasting salvation that he also believe rightly the incarnation of our Lord Jesus Christ. For the right faith is that we believe and confess that our Lord Jesus Christ, the Son of God, is God and man. God of the substance of the Father, begotten before the world; and man of the substance of his mother, born in the world. Perfect God and perfect man, of a reasonable soul and human flesh subsisting. Equal to the Father as touching his Godhead, and inferior to the Father as touching his manhood. Who, although he be God and man, yet he is not two, but one Christ. One, not by conversion of the Godhead into flesh, but by taking of the manhood into God. One together, not by confusion of substance, but by unity of person. For as the reasonable soul and flesh is one man, so God and man is one Christ. Who suffered for our salvation, descended into hell, rose again the third day from the dead. He ascended into heaven, he sitteth on the right hand of the Father, God Almighty. From whence he shall come to judge the quick and the dead. At whose coming all men shall rise again with their bodies, and shall give account for their works. And they that have done good shall go into life everlasting, and they that have done evil into everlasting fire. This is the catholic faith which, except a man believe faithfully, he cannot be saved. Glory be to the Father, and to the Son, and to the Holy Ghost. As it was in the beginning, is now, and ever shall be, world without end. Amen.

was the token of distinction between the Catholics and the Arians, does not occur in the creed, an omission which would be inexplicable in any confession composed by this father. It so plainly rejects the errors of the Nestorians, Eutychians, and Monothelites, that it must have been written after the promulgation of those heresies. The doctrine concerning the procession of the Holy Spirit from the Son as well as from the Father, distinctly asserted in this creed, is one which, however scriptural and true, was not held by the Eastern Church in the time of Athanasius. (c) The style is that of a Latin, not of a Greek writer.

2. Vossius, Quesnel, and others ascribe this creed to Vigilius, bishop of Thapsus, in Africa; others to Vincentius of Lerins (5th century), and again others to Venantius Fortunatus, a French bishop of the 6th century. Waterland ascribes it to Hilary, bishop of Arles, for the following reasons: (1.) Because Honoratus of Marseilles, the writer of his life, tells us that he composed an "Exposition of the Creed," a more proper title for the Athanasian than that of "Creed" simply, which it now bears. (2.) Hilary was a great admirer and follower of Augustine, and the whole composition of this creed is in a manner on Augustine's plan, both with respect to the Trinity and incarnation. (3.) It is agreeable to the style of Hilary, as far as we can judge from the little that is left of his works. The proofs in support of his opinion are far from clear and satisfactory.

3. About A.D. 570 this creed became so famous as to be the subject of comment; but, for several years after, it had not acquired the title of Athanasian, but was simply styled "the Catholic faith." The title of Athanasian probably became attached to it during the Arian controversy in Gaul, as being an exposition of the system of doctrine which was opposed to the Arian system, and which would naturally be called Athanasian from its chief propounder. Many expositors of this creed, and even bishops of the Church of England, while holding the doctrine of the Athanasian Creed and approving its terms, strongly object to the damnable clauses. Archbishop Tillotson, bishop Taylor, and bishop Tomline, all concur in regret that assertions of so peremptory a nature (referring to the damnable clauses), unexplained and unqualified, should have been used in any human composition. On the other hand, "Waterland (*Critical History of the Athanasian Creed*; Works, Oxford, 1848, vol. iii) says: 'The use of it will hardly be thought superfluous so long as there are any Arians, Photinians, Sabellians, Macedonians, Apollinarians, Nestorians, or Eutychians in these parts.' (See articles under these heads.) With respect to what are called the 'damnable clauses' (the clauses, namely, 'Which faith except every one do keep whole and undefiled, without doubt he shall perish everlastingly'; and, 'This is the Catholic faith, which except a man believe faithfully, he cannot be saved'), the churches which adopt the creed do not mean by them to imprecate curses, but to declare, as a logical sequence of a true faith being necessary to salvation, that those who do not hold the true faith are in danger of perishing; as it is said, Mark xvi, 16, 'He that believeth not shall be damned.' These clauses are also held to apply to those who deny the substance of the Christian religion, and not infallibly to every person who may be in error as to any one particular article. A rubric to this effect was drawn up by the commissioners appointed in 1689 for the review of the English Common Prayer-book, but none of their suggestions took effect. Compare also the 18th Article of the Church of England with these clauses" (Chambers, s. v.). The creed is received in the Greek, Roman, and English churches, but is left out of the service of the Protestant Episcopal Church in America. The Convention of 1785 passed an act expunging both the Athanasian and Nicene creeds from the proposed Book of

1. That this creed was not composed by Athanasius is clear on the following, among other grounds: (a) Athanasius himself does not mention it, nor do any of his contemporaries, or of the writers of the following century, ascribe it to him. (b) The contents show that it could not have been written by him. The word *μονού-*

Common Prayer; but when the book was placed before the English bishops they required the restoration of both creeds before they would consent to consecrate the American bishops. The archbishops of Canterbury and York, in the spring of 1786, wrote to the Church committee to that effect, whereupon another Convention was held in Wilmington, Delaware, October, 1786. Bishop White relates that "the Nicene Creed was restored without debate or difficulty, but the Convention wholly refused to restore the Athanasian Creed," and that the members from New England and bishop Seabury yielded their consent to leave it out with great reluctance. Had it been retained, bishop White declared his intention never to read it in his church (*Christian Times*, March, 1866). Many in the Church of England desire its omission from their book; thus the *Church of England Quarterly* (April, 1855, p. 19): "The Athanasian Creed finds few real lovers as a portion of a public service. No one supposes that it was the work of Athanasius; no one is now, at least among us, in any danger from the errors it denounces; no one believes in his heart the damnatory clauses; for no one believes that all the members of the Greek Church are necessarily consigned to everlasting damnation; and thus, every time the creed is read, the officiating minister has solemnly to enunciate what neither he nor any of his hearers believe. It is true that, by distinguishing between the creed itself and the damnatory clauses he may save himself, mentally, from declaring a falsehood; but surely this is reason enough for the removal of the creed from our Liturgy. We have had too much in our Church of mental reservations. So far as the doctrine of the Trinity is concerned, it is abundantly insisted on in the Apostles' and Nicene Creeds."

See, besides the authorities already cited, Bingham, *Orig. Eccles.* bk. x, ch. iv, § 18; Mosheim, *Ch. Hist.* i, 240; Vossius, *Diss. de Symbolo Athanasiano* (Oppvi, 616); Palmer, *Orig. Liturg.* i, 234; Radcliffe, *Athanasian Creed illustrated* (Lond. 1844, 8vo); Schaff, in *Amer. Presb. Rev.* 1866, 584 sq.; also in his *Hist. of the Christ. Church*, § 182; Fletcher, *Works* (N. Y. ed.), iii, 210; Browne, *On the Thirty-nine Articles*, art. viii, § 4.

CREED, NICENE AND CONSTANTINOPOLITAN, a creed adopted at the Council of Nice A.D. 325, and enlarged at the second Council of Constantinople A.D. 381, by which the faith of the Church with regard to the person of Christ was set forth in opposition to certain errors, especially Arianism. See **ARIUS**; **CHRISTOLOGY**; **NICE, COUNCIL OF**.

1. The *Nicene Creed* "is found, together with the similar Eusebian (Palestinian) confession, in the well-known Epistle of Eusebius of Cæsarea to his diocese (*Epist. ad suas parochias homines*), which is given by Athanasius at the close of his *Epist. de decretis Nicæne Synodi* (Opera, i, 239, and in Thilo's *Bibl.* i, 84 sq.); also, though with some variations, by Theodoret, *H. E.* i, 12, and Socrates, *H. E.* i, 8. Sozomen omitted it (*H. E.* i, 10) from respect to the *disciplina arcani*. The Symbolum Nicænum is given also, with unessential variations, by Athanasius, in his letter to the emperor Jovian, c. 3, and by Gelasius Cyzic., *Lib. Synod. de Concil. Nicæno*, ii, 35. On the unimportant variations in the text, comp. Walch, *Bibl. Symbol.* p. 75 sq., and A. Hahn, *Bibliothek der Symbole* (1842). Comp. also the parallel creeds of the Nicene age in the Appendix to Pearson's *Exposition of the Creed.*" (Schaff, *Hist. of the Christian Church*, § 129; see also Dörner, *Person of Christ* [Edinb. transl.], ii, 247, 497.)

We give the Nicene Creed, Greek and English, in parallel columns. [The parts omitted at Constantinople are put in brackets in the Greek text.]

Greek.
Πιστεύομεν εἰς ἕνα Θεόν, |
πατέρα παντοκράτορα, πάντων |
ὁρατῶν καὶ ἄορατων ποιη- |
τὴν καὶ εἰς ἕνα κύριον Ἰησοῦν |
καὶ εἰς ἕνα κύριον Ἰησοῦν καὶ |
ἐκ τοῦ πατρὸς γεννηθέντα |
πρὸ πάντων τῶν αἰώνων, φῶς |
ἐκ φωτός, Θεὸν ἀληθινὸν ἐκ |
Θεοῦ ἀληθινοῦ, γεννηθέντα οὐ |
ποιηθέντα ὁμοούσιον τῷ πα- |
τρὶ δι' οὗ τὰ πάντα ἐγένετο. |
Τὸν δι' ἡμᾶς τῶν ἀνθρώπων |
καὶ διὰ τὴν ἡμετέραν σωτηρίαν |
κατελθόντα [ἐκ τῶν οὐρανῶν], |
καὶ σαρκωθέντα [ἐκ πνεύματος |
ἁγίου καὶ Μαρίας τῆς παρθέ- |
νου], καὶ ἐνανθρωπήσαντα. |
[σταυρωθέντα τε ὑπὲρ ἡμῶν ἐπὶ |
Ποντίῳ Πιλάτῳ], καὶ παθόντα |
[καὶ ταφέντα] καὶ ἀναστάντα |
τῇ τρίτῃ ἡμέρᾳ [κατὰ τὰς γρα- |
φάς] καὶ ἀνελθόντα εἰς τοὺς |
οὐρανοὺς [καὶ καθεζόμενον ἐκ |
δεξιῶν τοῦ πατρὸς], καὶ πάλιν |
ἐρχόμενον [μετὰ δόξης] κριναί |
ζῶντας καὶ νεκρούς [οὗ τῆς βα- |
σιλείας οὐκ ἔσται τέλος]. Καὶ |
εἰς πνεῦμα τὸ ἅγιον [τὸ κύριον, |
τὸ ζωοποιόν, τὸ ἐκ τοῦ πατρὸς |
ἐκπορευόμενον, τὸ σὺν πατρὶ |
καὶ ὑψὸς συμπροσκυνούμενον, καὶ |
συνδοξαζόμενον, τὸ λαλῆσαν |
διὰ τῶν προφητῶν. Εἰς μίαν |
ἁγίαν καθολικὴν καὶ ἀποστολι- |
κὴν ἐκκλησίαν· ὁμολογοῦμεν ὅτι |
βάπτισμα εἰς ἄφεσιν ἁμαρτιῶν· |
προσδοκῶμεν ἀνάστασιν νεκ- |
ρῶν καὶ ζῆν τὸν μέλλοντος |
αἰῶνος]. Ἀμήν.

νηθέντα ἐκ τοῦ πατρὸς [μονο- |
γενῆ, τὸν αὐτὸν ἐκ τοῦ οὐσιῶς |
τοῦ πατρὸς, Θεὸν ἐκ Θεοῦ], φῶς |
ἐκ φωτός, Θεὸν ἀληθινὸν ἐκ Θεοῦ |
ἀληθινοῦ, γεννηθέντα οὐ ποιη- |
θέντα, ὁμοούσιον τῷ πατρὶ, δι' |
οὗ τὰ πάντα ἐγένετο [τὰ τε ἐν |
τῷ οὐρανῷ καὶ τὰ ἐν τῇ γῆ], |
τὸν δι' ἡμᾶς τῶν ἀνθρώπων |
καὶ διὰ τὴν ἡμετέραν σωτηρίαν |
κατελθόντα καὶ σαρκωθέντα καὶ |
ἐνανθρωπήσαντα, παθόντα καὶ |
ἀναστάντα τῇ τρίτῃ ἡμέρᾳ· ἀν- |
ελθόντα εἰς τοὺς οὐρανοὺς, καὶ |
ἐρχόμενον κριναί ζῶντας καὶ νε- |
κρούς. Καὶ εἰς τὸ ἅγιον πνεῦ- |
μα. [Τοῦτο δὲ λέγοντας, ὅτι ἡ |
ποτε ὅτε οὐκ ἦν, καὶ πρὶν γεν- |
νηθῆναι οὐκ ἦν, καὶ ὅτι ἐξ οὐκ |
ὄντων ἐγένετο, ἢ κτιστὸν ἐξ- |
έτερας ὑποστάσεις ἢ οὐσίας |
φάσκοντες εἶναι, ἢ τρεπτόν τι |
ἄλλοκωτὸν τῶν ἰσθῶν τοῦ Θεοῦ, |
ἀναθεματίζομεν ἡ ἁγία καθολικὴ |
καὶ ἀποστολικὴ ἐκκλησία.] |
(Athanasius, *Epist. de decret.* |
Syn. Nic.; Eus. *Cæs. Ep. ad* |
Cæsariens.; Socrates, *Hist.* |
Eccles. i, 8.)

' It was established by this creed that the Son is of the same essence (*ὁμοούσιος*) with the Father.

2. *The Nicæno-Constantinopolitan Creed.*—The doctrine of the Person of Christ, as settled at Nice (A. D. 327), was disputed, especially as to the use of the term *ὁμοούσιος* by the Semi-Arians and Eusebians (see Gieseler, *Ch. History*, i, § 81, 82). Moreover, not only the Semi-Arians, but even many of the Nicœnians (followers of the Nicene Creed), held, with the Arians, and especially the Macedonians (q. v.), that the Holy Spirit was created by the Father (Gieseler, l. c.). After ineffectual attempts, at several synods, to agree upon a formula, the Nicene symbol, with certain additions, was adopted at the second Ecumenical Council of Constantinople A. D. 381. The creed thus adopted is given below, in Greek and English (the form in the English Prayer-book differing somewhat from the Greek). The parts added at Constantinople are put in brackets.

Symbolum Nicæno-Constantinopolitanum.

<p>Greek. Πιστεύομεν εἰς ἕνα Θεόν, πα- τέρα παντοκράτορα [ποιητὴν οὐρανοῦ καὶ γῆς], ὁρατῶν τε πάντων καὶ ἄορατων· καὶ εἰς ἕνα κύριον Ἰησοῦν Χριστόν, τὸν ἰὸν τοῦ Θεοῦ [τῶν μονογενῆ], τὸν ἐκ τοῦ πατρὸς γεννηθέντα [πρὸ πάντων τῶν αἰώνων], φῶς ἐκ φωτός, Θεὸν ἀληθινὸν ἐκ Θεοῦ ἀληθινοῦ, γεννηθέντα οὐ ποιηθέντα ὁμοούσιον τῷ πα- τρὶ δι' οὗ τὰ πάντα ἐγένετο. Τὸν δι' ἡμᾶς τῶν ἀνθρώπων καὶ διὰ τὴν ἡμετέραν σωτηρίαν κατελθόντα [ἐκ τῶν οὐρανῶν], καὶ σαρκωθέντα [ἐκ πνεύματος ἁγίου καὶ Μαρίας τῆς παρθέ- νου], καὶ ἐνανθρωπήσαντα. [σταυρωθέντα τε ὑπὲρ ἡμῶν ἐπὶ Ποντίῳ Πιλάτῳ], καὶ παθόντα [καὶ ταφέντα] καὶ ἀναστάντα τῇ τρίτῃ ἡμέρᾳ [κατὰ τὰς γρα- φάς] καὶ ἀνελθόντα εἰς τοὺς οὐρανοὺς [καὶ καθεζόμενον ἐκ δεξιῶν τοῦ πατρὸς], καὶ πάλιν ἐρχόμενον [μετὰ δόξης] κριναί ζῶντας καὶ νεκρούς [οὗ τῆς βα- σιλείας οὐκ ἔσται τέλος]. Καὶ εἰς πνεῦμα τὸ ἅγιον [τὸ κύριον, τὸ ζωοποιόν, τὸ ἐκ τοῦ πατρὸς ἐκπορευόμενον, τὸ σὺν πατρὶ καὶ ὑψὸς συμπροσκυνούμενον, καὶ συνδοξαζόμενον, τὸ λαλῆσαν διὰ τῶν προφητῶν. Εἰς μίαν ἁγίαν καθολικὴν καὶ ἀποστολι- κὴν ἐκκλησίαν· ὁμολογοῦμεν ὅτι βάπτισμα εἰς ἄφεσιν ἁμαρτιῶν· προσδοκῶμεν ἀνάστασιν νεκ- ρῶν καὶ ζῆν τὸν μέλλοντος αἰῶνος]. Ἀμήν.</p>	<p>English. (1) I believe in one God the Father Almighty, Maker of heaven and earth, and of all things visible and invisible: (2) And in one Lord Jesus Christ, the only-begotten Son of God, begotten of his Father [before all worlds]; (God of God), Light of Light, very God of very God, begotten, not made, being of one substance with the Father; by whom all things were made; (3) Who for us men and for our salva- tion came down from heaven, and was incarnate [by the Holy Ghost of the Virgin Mary], and was made man, [and was crucified also for us under Pontius Pilate,] and suf- fered and was buried; and the third day he rose again, ac- cording to the Scriptures; and ascended into heaven, [and sit- teth on the right hand of the Father]. And he shall come again with glory to judge both the quick and the dead [whose kingdom shall have no end]. And I believe in the Holy Ghost [the Lord and Giver of Life, who proceedeth from the Father (and the Son), who with the Father and the Son together is worshipped and glorified, who spake by the prophets. And I believe one catholic and apostolic Church. I acknowledge one baptism for the remission of sins; and I look for the resurrection of the dead, and the life of the world to come. Amen.]</p>
---	--

The words "and from the Son" (Lat. "filioque") were not added till the fifth century. The first copies of this creed, in the Council of Constantinople, and the councils of Ephesus and Chalcedon, have only the words "proceeding from the Father," without any mention of the Son. This addition to the creed of the Western Church first appears in the acts of an assembly of bishops at Braga (412)—"procedentem a Patre et Verbo" (Concil. Bracar. i; Mansi, iv, 287)—and in the third Council of Toledo (589), according to some copies (Mansi, ix, 981). Mabillon (*De Lit. Gallic.* i, 8) says of it, "quod a Caroli M. tempore exordium ducit." It was then (circ. 800) of old standing. Very probably it is due to the Spanish Church in the middle of the fifth century (Harvey, *Hist. of the Creeds*, p. 452 sq.; Hardwick, *Middle Age*, p. 61, n. 4; Browne, *Exposition of the Articles*, p. 114 sq.).—Procter, *On Common Prayer*, p. 284. See **FILIOQUE**.

Among the Syriac MSS. discovered some years ago, now in the British Museum, is a version of the original Nicene Creed, and also the Nicæno-Constantinopolitan, of which Mr. B. Harris Cowper has printed translations. The differences between this Syrian version and the received text of both creeds are very slight.

The Nicene Creed is held to be of authority in the Greek and Roman churches, and is admitted by most Protestant churches. It was adopted, with the Apostles' and Athanasian creeds, by the Protestants after the Reformation, and was introduced into the *Formula Concordiæ* (q. v.) of the Lutherans and into the English Prayer-book. On its value in theology, see Shedd, *History of Doctrines*, bk. iii, ch. iii; Schaff, *History of the Christian Church*, § 127-131; Cunningham, *Historical Theology*, ch. ix; Dörner, *Doctrine of the Person of Christ*, div. i, vol. ii; Neander, *History of Dogmas* (Ryland's transl.), i, 291-294; Stanley, *Eastern Church* (Lect. iv.); Browne, *On the 39 Articles*, 228 sq.; Waterland, *Works*, vol. iii; Bull, *Defensio Fidei Nicæne* (transl. in Lib. of Anglo-Catholic Theology, Oxford, 1851, 2 vols.). See also Forbes, *Short Explanation of the Nicene Creed* (Lond. 1864); Palmer, *Origines Liturgicæ*, ii, 56; Procter, *On Common Prayer*, p. 234; Harvey, *On the three Creeds*; Harvey, *Eccles. Anglic. Vindez*, i, 568 sq.; Bingham, *Orig. Eccles.* bk. x, ch. iv; *Amer. Quart. Church Review*, April, 1868, art. v.

CREED OF CHALCEDON. See **CHALCEDON**; **CHRISTOLOGY**.

CREED OF POPE PIUS IV, a summary of the doctrines of the Roman Church as contained in the canons and decrees of the Council of Trent. It was issued in the form of a bull in December, 1564, by pope Pius IV, and usually bears his name. All bishops, ecclesiastics, and teachers in the Romish Church, as well as all converts from Protestantism, publicly profess assent to it. The original may be found in Richter, *Canones et decreta Concilii Trident.* p. 574, in Cramp, *Text-book of Popery*, p. 542; and in Elliott, *Delin. of Romanism*, ch. i. We subjoin an English version. It will be seen that the former part is the Nicene Creed, slightly altered.

I, A. B., believe and profess with a firm faith all and every one of the things which are contained in the symbol of faith which is used in the holy Roman Church; namely, I believe in one God the Father Almighty, Maker of heaven and earth, and of all things visible and invisible; and in one Lord Jesus Christ, the only-begotten Son of God, born of the Father before all worlds, God of God, Light of Light, true God of true God, begotten, not made, consubstantial to the Father, by whom all things were made; who for us men and for our salvation came down from heaven, and was incarnate by the Holy Ghost of the Virgin Mary, and was made man; was crucified also for us under Pontius Pilate, suffered and was buried, and rose again the third day according to the Scriptures, and ascended into heaven, sits at the right hand of the Father, and will come again with glory to judge the living and the dead, of whose kingdom there will be no end; and in the Holy Ghost, the Lord and Life-giver, who proceeds from the Father and the Son, who, together with the Father and the Son, is adored and glorified, who spake by the holy prophets; and one holy catholic and apostolic Church. I confess

one baptism for the remission of sins; and I expect the resurrection of the dead, and the life of the world to come. Amen.

I most firmly admit and embrace apostolical and ecclesiastical traditions, and all other constitutions and observances of the same Church. I also admit the sacred Scriptures according to the sense which the holy mother Church has held and does hold, to whom it belongs to judge of the true sense and interpretation of the Holy Scriptures; nor will I ever take or interpret them otherwise than according to the unanimous consent of the fathers. I profess, also, that there are truly and properly seven sacraments of the new law, instituted by Jesus Christ our Lord, and for the salvation of mankind, though all are not necessary for every one—namely, baptism, confirmation, eucharist, penance, extreme unction, orders, and matrimony, and that they confer grace; and of these, baptism, confirmation, and order cannot be reiterated without sacrilege. I do also receive and admit the ceremonies of the Catholic Church, received and approved in the solemn administration of all the above-said sacraments. I receive and embrace all and every one of the things which have been defined and declared in the holy Council of Trent concerning sin and justification. I profess likewise that in the mass is offered to God a true, proper, and propitiatory sacrifice for the living and the dead; and that in the most holy sacrament of the eucharist there is truly, really, and substantially the body and blood, together with the soul and divinity, of our Lord Jesus Christ; and that there is made a conversion of the whole substance of the bread into the body, and of the whole substance of the wine into the blood, which conversion the Catholic Church calls transubstantiation. I confess, also, that under either kind alone, whole and entire, Christ and a true sacrament is received. I constantly hold that there is a purgatory, and that the souls detained therein are helped by the suffrages of the faithful. Likewise that the saints reigning together with Christ are to be honored and invoked, that they offer prayers to God for us, and that their relics are to be venerated. I most firmly assert that the images of Christ, and of the mother of God ever Virgin, and also of the other saints, are to be had and retained, and that due honor and veneration are to be given to them. I also affirm that the power of indulgences was left by Christ in the Church, and that the use of them is most wholesome to Christian people. I acknowledge the holy catholic and apostolic Roman Church, the mother and mistress of all churches; and I promise and swear true obedience to the Roman bishop, the successor of St. Peter, prince of the apostles and vicar of Jesus Christ. I also profess and undoubtedly receive all other things delivered, defined, and declared by the sacred canons and general councils, and particularly by the holy Council of Trent; and likewise I also condemn, reject, and anathematize all things contrary thereto, and all heresies whatsoever condemned, rejected, and anathematized by the Church. This true catholic faith, out of which none can be saved, which I now freely profess and truly hold, I, A. B., promise, vow, and swear most constantly to hold, and profess the same whole and entire, with God's assistance, to the end of my life; and to procure, as far as lies in my power, that the same shall be held, taught, and preached by all who are under me, or are intrusted to my care, by virtue of my office. So help me God, and these holy Gospels of God. Amen.

This creed is also known under the name of the *Professio Fidei Tridentina*, or *Forma Professionis fidei Catholicae*. See Cramp, *Text-book of Popery*, p. 486; Buckley, *History of Council of Trent*, p. 519; Elliott, *Delineation of Romanism*, bk. i, ch. i; Streitwolf und Klener, *Lib. Sym. ecclesie* (Gött. 1846, t. ii).

Creek (κόλπος, *bosom*, as elsewhere rendered), a bay or inlet from the sea (so Josephus, *Ant.* iii, 1, 5), e. g. St. Paul's Bay, on the island of Malta (q. v.), where the apostle was wrecked (Acts xxvii, 39).

Creeping THING (קָרָפָה, *she'rets*, any swarming creature; or קָרָפָה, *re'mes*, any low-gliding animal; ἐρπετόν) is used in Scripture to designate not only reptiles, properly so called, but also insects, aquatic creatures, and even the smaller mammalia. See **REPTILE**.

Creighton, WILLIAM, D.D., was born in New York, Feb. 22d, 1798. He was educated in Columbia College, graduating in the class of 1812, and received his doctor's degree in 1830. He was ordained deacon in 1815, and soon after was employed in Grace Church, N. Y., as an assistant to the Rev. Dr. Bowen. In 1816 he was called to the rectorship of St. Mark's Church, in the Bowery, of which he remained rector until 1830, when he became rector of Zion Church, Greenburgh, and resigned the same in 1845. In the year 1836 the Parish of Christ Church, Tarrytown, was organized, of which he was chosen rector, and remained so up to the time of his death, a period of twenty-nine years,

without salary. In 1845 he was elected president of the Convention of the Diocese of New York, and was re-elected every succeeding year until the consecration of the Rev. Dr. Wainwright in 1852. At the first election of a provisional bishop of New York he was chosen to that high office, but, from various considerations, declined its acceptance. He was also chosen president of the House of Clerical and Lay Deputies of the General Conventions of 1858, 1856, and 1859 respectively. He had previously served the Church in different stations of trust, as member of the Standing Committee, chairman of the Missionary Committee, etc. In 1849-50 the Church of St. Mary's, Beechwood, was founded by him and his son-in-law, the Rev. Edward N. Mead, D.D.; the principal part of the cost for the erection and ground being contributed by them, and divine service being maintained by them in it, as a free church, to the present time. Dr. Creighton died at Tarrytown, April 28d, 1865.—*Church Review*; July, 1865.

Crell (CRELLIUS), **Johannes**, a Socinian divine, whose works form part of the *Bibliotheca Fratrum Polonorum*, was born in Franconia in 1590, and studied at Nuremberg and other German universities. Originally a Lutheran, he afterwards adopted the principles of Socinus, and went to Cracow, in Poland, in 1612, where he became a preacher; he then was appointed professor of Greek, and afterwards rector of the university at that place. He died in 1638. His works are collected in *Opera omnia exegetica, didactica, et polemica, magnam partem hactenus inedita* (Irenopolis, 1656, 4 vols. in 8); *Touching one God* (trans. Lond. 1665, 4to).—Darling, *Cyclop. Bibliographica*, i, 812.

Crell (or **CRELL**), **Nicholas**, a distinguished German jurist, was born at Leipaic between the years 1550-58; graduated at Leipaic 1575, and was called to the court of the elector Augustus. Christian I, who succeeded his father in 1586, made him privy councillor and chancellor. Augustus had been zealous in opposing Crypto-Calvinism, but Christian I did not share his partiality for the *Formula Concordiæ*, and Crell, by his order, superintended the preparation of a German Bible, with practical notes, for popular use. Christian dying before its completion (Sept. 25, 1591), the work was discontinued. The electress Sophia, who governed during the minority of her son Christian II, favored the extreme Lutheran party, and Crell was thrown into prison. In Sept., 1597, he had a hearing in prison, and in 1599 he was condemned as unfaithful to the elector and to his trust. His appeal to the imperial court at Spire was rejected, and he was executed Oct. 9, 1601, commending himself to God. See Niedner, *Zsch. f. hist. Theol.* (1848, p. 315); Hutterus, *Concordia Concordæ*, c. 49; Arnold, *Kirchen-u. Ketzehistorie*, ii, 16, 32; Herzog, *Real-Encyklop.* iii, 183; and CRYPTO-CALVINISTIC CONTROVERSY.

Crell, **Samuel**, grandson of Johannes Crell, born in 1660. After being for some time a preacher at Königswalde, he lived successively in Berlin, in the Netherlands, and in England, where he became acquainted with Sir Isaac Newton, Dr. Grabe, and other eminent men, by whom he was highly esteemed. He died at a very advanced age at Amsterdam in 1747. He wrote several historical treatises on the ante-Nicene fathers, and one on the Introduction to St. John's Gospel. He was a disciple of Socinus, but it is said that towards the end of his life he received the orthodox view of the atonement. See Fock, *Socinianismus*, etc., p. 240; Nichols, *Calvinism and Arminianism*, ii, 642.

CRESCENS (Κρήσκης, for Latin *Crescens*, growing), an assistant of the apostle Paul (2 Tim. iv, 10, where he is stated to have left Rome for Galatia), A.D. 64. He is generally supposed to have been one of the seventy disciples of Christ. It is alleged in the *Apostolical Constitutions* (vii, 46), and by the fathers of the Church,

that he preached the Gospel in Galatia, a fact probably deduced conjecturally from the only text (2 Tim. iv, 10) in which his name occurs. There is a less ancient tradition (in Sophronius), according to which Crescens preached, went into Gaul (Galatia; see Theodoret on 2 Tim. i. c.), and became the founder of the Church in Vienna; but it deserves no notice, having probably no other foundation than the resemblance of the names Galatia and Gallia. From the fact of his having a Latin name, many have inferred that he was a Christian of Rome. (See Bechler, *De Crescens*, Vi. tob. 1689.)

Crescens, a Cynic philosopher who acquired great influence over the mind of the emperor Aurelia. While the other schools of philosophers looked down with contempt on the Christians, the Cynics had been more favorably inclined towards them; but Justin Martyr having offended Crescens by some remarks he made against him in an apology addressed to the emperor, Crescens swore to be revenged, and, to accomplish his purpose, incited the emperor to persecute the Christians. Justin Martyr was one of the victims of this persecution. See JUSTIN MARTYR.

Crescent, the emblem of the Ottoman empire. See CONSTANTINOPLE (I, 1).

Crespin, **JEAN**, a French Reformer, born at Arras, studied law at Löwen and Paris, but, being persecuted for his religious opinions, he fled to Geneva in 1548. Here he established a printing-office, was made a citizen in 1552, and died in 1572. The books issued from his press, which can be recognised by the sign of an anchor, are remarkable for beauty of typography and for correctness. Among his own writings are, *Histoire des martyrs persécutés et mis à mort pour la vérité de l'évangile* (Gen. 1570, fol.; 1619); *L'état de l'église des temps des apôtres jusqu'en 1560* (1564, and a transl., *The Estate of the Church* [Lond. 1602, 4to]); *Bibliotheca studii theologici ex patribus collecta* (1561, fol.).

Crete (Κρήνη), one of the largest islands in the Mediterranean, now called *Candia*, and by the Turks *Kirid*. It is 160 miles long, but of very unequal width, varying from 85 to 6 miles. It is situated at the entrance of the Archipelago, having the coast of the Morea to the south-west, that of Asia Minor to the north-east, and that of Libya to the south. Great antiquity was ascribed by the inhabitants, and it has been supposed by some that the island was originally peopled from Egypt; but this is founded on the conclusion that Crete was the Capthor of Deut. ii, 23, etc., and the country of the Philistines, which seems more than doubtful. See CAPTOR. Surrounded on all sides by the sea, the Cretans were excellent sailors, and their vessels visited all the neighboring coasts. Though extremely bold and mountainous, this island has very fruitful valleys (Virgil, *Æn.* iii, 106), and was highly prosperous and full of people in very ancient times: this is indicated by its "hundred cities" alluded to in the epithet *ἑκατόμυρος*, applied to it by Homer (*Il.* ii, 649). It was remarkable for its patriotism, although it kept aloof from the intestine wars of Greece. One of its peaks was the famous Mt. Ida, and in one of its remarkable caverns was the renowned Labyrinth of antiquity. This island was also the scene of many of the fables of mythology, and was even reputed as the abode of "the father of gods and men." The chief glory of the island, however, lay in its having produced the legislator Minos, whose institutions had so important an influence in softening the manners of a barbarous age, not in Crete only, but also in Greece, where these institutions were imitated. The natives were celebrated as archers. Their character was not of the most favorable description (see Polyb. vi, 46, 8; 47, 5; Diod. Sic. *Exc. Vat.* p. 131; Livy, xlv, 46; Ovid, *Ars Amat.* i, 297; Plutarch, *Philopom.* 18); the Cretans, or Kretans, being, in fact,

one of the three *K's* against whose unfaithfulness the Greek proverb was intended as a caution—Kappadokia, Krete, and Kilikia. In short, the ancient notices of their character fully agree with the quotation which Paul produces from "one of their own poets" (προφήτης) in his Epistle to Titus (i, 12), who had been left in charge of the Christian church in the island: "The Cretans are always liars (ἀει ψεύδοι, eternal liars), evil beasts (κακὰ θηρία, Angl. 'brutes'), slow bellies" (γααστρίες ἀργαί, gorbellies, bellies which take long to fill). The quotation is usually supposed to have been from Callimachus's *Hymn on Jove*, 8; but Callimachus was not a Cretan, and he has only the first words of the verse, which Jerome says he borrowed from Epimenides (q. v.), who was of Crete, and from whose work (Περὶ χρησμάτων, see Clemens Alex. *Strom.* i, 129) the citation appears to have been made (see Gottschalk, *De Epimenide propheta*, Altdorp, 1714; Hoffmann, *De Paulo scripturas profan. ter allegante*, Tub. 1770, p. 17; Heinrich, *Epimenides a. Kreta*, Lpz. 1801). Ample corroboration of the description which it gives of the ancient inhabitants may be seen in the commentators (see Wolfii *Cur.* iv, 554 sq.). See CRETIAN. Mr. Hartley, in his *Researches in Greece*, says, "The Cretans of the present day are precisely what they were in the days of the apostle Paul; they are notoriously, whether Turks or Greeks, the worst characters in the Levant." (See the *Penny Cyclopædia*, s. v. Candia.)

years 1866 and 1867 the whole force of the Ottoman empire, and thereby enlisted the sympathy of all the Christian powers of Europe, most of which urged the Turkish government to consent to the annexation of the island to Greece. (In November, 1867, the fate of Crete was not yet decided.) (See Paulin, *Description physique de l'île de Crète*, Paris, 1869.)

It seems likely that a very early acquaintance took place between the Cretans and the Jews. The story in Tacitus (*Hist.* v, 2) that the Jews were themselves of Cretan origin, may be accounted for by supposing a confusion between the Philistines and the Jews, and by identifying the Cherethites of 1 Sam. xxx, 14; 2 Sam. viii, 18; Ezek. xxv, 16; Zeph. ii, 5, with Cretan emigrants. In the last two of these passages they are expressly called Κρήτες by the Sept., and in Zeph. ii, 6, we have the word Κρήτη. Whatever conclusion we may arrive at on this point, there is no doubt that Jews were settled in the island in considerable numbers during the period between the death of Alexander the Great and the final destruction of Jerusalem. Gortyna (q. v.) seems to have been their chief residence, for it is specially mentioned (1 Macc. xv, 29) in the letters written by the Romans on behalf of the Jews, when Simon Maccabeus renewed the treaty which his brother Judas had made with Rome (see 1 Macc. x, 67). At a later period Josephus says (*Ant.* xvii, 12, 1; *War.* ii, 7, 1) that the pseudo-Alexander, Herod's supposed son, imposed upon the Jews of Crete

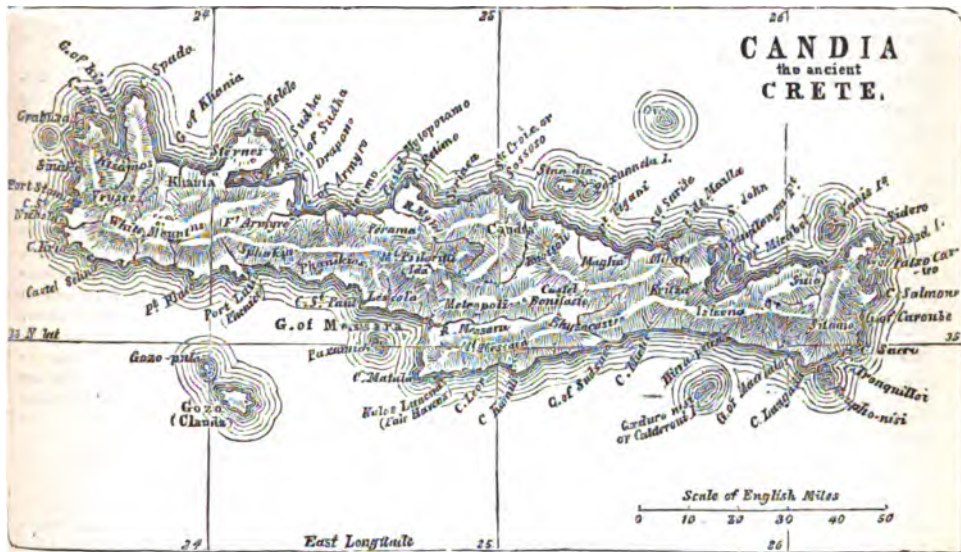

Crete was an independent state, with some variations of government, until it was conquered by the Romans, B.C. 67, under Metellus, hence called Creticus, and united in one province with Cyrenaica, which was at no great distance (Strab. x, 475) on the opposite coast of Africa. See CYRENE. It is possible that in Tit. iii, 1, there may be an implied reference to a turbulent condition of the Cretan part of the province, especially as regarded the Jewish residents. It formed part of the Eastern empire until taken by the Saracens in 823, and was recovered from them by the emperor Nicephorus Phocas in 981. On the establishment of the Latin empire of Constantinople in 1204, it came by purchase into the hands of the Venetians, and was retained by them until the year 1669, when, after a twenty-four years' siege of the capital, the conquest of the whole island was effected by the Turks, to whose dominions it still nominally belongs. In August, 1866, the Christians of Crete rose in insurrection against the Turkish rule, and demanded annexation to the kingdom of Greece. They resisted throughout the

when on his way to Italy. And later still, Philo (*Leg. ad Cai.* § 86) makes the Jewish envoys say to Caligula that all the more noted islands of the Mediterranean, including Crete, were full of Jews. Thus the special mention of Cretans (Acts ii, 11) among those who were in Jerusalem at the great Pentecost is just what we should expect. No notice is given in the Acts of any more direct evangelization of Crete, and no absolute proof can be adduced that Paul was ever there before his voyage from Cæsarea to Puteoli, though it is barely possible that he may have visited the island in the course of his residences at Corinth and Ephesus. See TRUSS. The circumstances of Paul's recorded visit were briefly as follows. The vessel in which he sailed to Italy, being forced out of her course by contrary winds, was driven round the island, instead of keeping the direct course to the north of it. In doing this, the ship first made the promontory of Salmone, on the eastern side of the island, which they passed with difficulty, and took shelter at a place called Fair-Havens, near to which was the city Lasea. But after spend-

ing some time at this place, and not finding it, as they supposed, sufficiently secure to winter in, they resolved, contrary to the advice of Paul (the season being far advanced), to make for Phœnicia, a more commodious harbor on the western part of the island; in attempting which they were driven far out of their course by a furious east wind called Euroclydon, and were wrecked on the island of Melita (Acts xxvii). See SHIPWRECK (OF PAUL). It is evident from Tit. i, 5, that the apostle himself was here at no long interval of time before he wrote the letter. We believe this to have been between the first and second imprisonments. See TITUS, EPISTLE TO. Titus was much honored here during the Middle Ages. The cathedral of Megalo-Castron was dedicated to him; and his name was the watchword of the Cretans when they fought against the Venetians, who themselves seem to have placed him above St. Mark in Candia, when they became masters of the island (Pashley's *Travels in Crete*, i, 6, 175, Lond. 1837). See Höck's *Kreta* (Gött. 1829), and some papers from the Italian in the *Museum of Class. Antiq.* (vol. ii, Lond. 1856). Also Meursius, *De Rhodo, Creta*, etc. (Anatol. 1675); Neumann, *Res. Creticar. spec.* (Gött. 1820); Smith, *Dict. of Class. Geogr. s. v. Creta*; Spratt's *Researches in Crete* (London, 1865, 2 vols. 8vo). See GREECE.

Crete (Acts ii, 11) or **Cre'tian** (Tit. i, 12 and subseq.), a Cretan (Κρής), or inhabitant of the island of CRETE (q. v.). Treatises on the notoriously bad character of this people (referred to in the latter passage) have been written in Latin by Hollebeck (Lugd. B. 1798), Peffinger (Argent. 1701), Schmidt (Lips. 1678), and Steger (Lips. 1684).

Crib (כִּבּוּץ, *ebus*), a stall or barn where fodder is stored (Prov. xiv, 4) and where cattle are fed (Job xxxix, 9; Isa. i, 9); perhaps simply a manger for them to eat out of, as the Sept. and Vulg. render in the last-cited passage. See MANGER.

Crime (חַטָּאת, *judgment*, Ezek. vii, 28; חַטָּאת, *sinn-mah'*, mischief, "heinous crime," Job xxxi, 11; *aitia*, Acts xxv, 27; *ἔγκλημα*, Acts xxv, 16). See LAW; JUDGE; PUNISHMENT.

Crimson, חֲמָצִית, *shams'* (Jer. iv, 30; elsewhere "scarlet;" fully חֲמָצִית הַדְּמָיִת, *crimson-worm*, Exod. xxv, 4, or חֲמָצִית הַדְּמָיִת, *worm-crimson*, Lev. xiv, 4, or simply חֲמָצִית, the worm itself, Isa. i, 15, all rendered, except in this last passage, likewise "scarlet;" later חֲמָצִית, *karmil'* (invariably "crimson," 2 Chron. ii, 7, 14; iii, 14; on this Heb. term, see Lorsch, *Archiv für morgenländ. Literatur*, ii, 305; Gesenius, *Theaur.* p. 714), a well-known red color (Pliny, xxi, 22), of a deep hue bordering on purple (q. v.), and in this respect differing from the brighter scarlet (q. v.), yet of a brilliant color (Isa. i, 18; comp. Pliny, xxxiii, 40; hence *χρῶμα δέυ'*; so in Matt. xxvii, 28, *χλάμυς κοκκίνη* = *ἰσοθήκη λαμπρά* in Luke xxiii, 11), highly prized among the ancients for garments and tapestry (Horsce, *Sat.* ii, 6, 102), as articles of luxury with the nobility (Jer. iv, 30; 2 Sam. i, 24; Prov. xxxi, 21; Lam. iv, 6; comp. Martial, iii, 2, 11; ii, 89, 1; 43, 8; Petron. *Sat.* 32), and with the Romans for the robes of generals and princes (Pliny, xxii, 8; comp. Matt. xxvii, 28, where *κοκκίνη* = *πυροπόρα* in Mark xv, 17, 20, and John xix, 4), especially the emperors (Sueton. *Domit.* 4). Many of the fabrics of the tabernacle and sacerdotal paraphernalia were also woven (Exod. xxxviii; Num. iv, 8) of threads of this dye (Gen. xxxviii, 28; Josh. ii, 18), which was likewise employed for the curtain of Solomon's Temple (2 Chron. iii, 14; comp. Sueton. *Nero*, 30). The color again occurs in the Mosaic ritual (Lev. xiv, 6; Num. xix, 6). As to its symbolical significance, Philo (*Opp.* i, 536; comp. ii, 148) and Josephus (*Ant.* iii, 7, 7) think that

it, like the two sacred colors (scarlet and purple), represents the element of fire; according to Bähr (*Symbol.* i, 388 sq.), it denotes life (i. e. fire and blood, which are both red); while others find in it other typical allusions. See DYE.

Crimson is obtained from the pulverized cochineal berries, i. e. the dead bodies and larvo-nests (see Brandt and Ratzburg's *Medicin. Zoologie*, Berl. 1831 sq., ii, pl. 26, fig. 15) of a small parasitic insect, the female cochineal-worm (קֶרְמֵסִית, *cola' alk*), or *kermes* (the *Coccus ilicis* of Linn., cl. 4, Tetragnyia), which towards the end of April fastens itself, like little raisins, in the form of round reddish or violet-brown berries upon the twigs, less frequently on the leaves, of the palm-oak (πρωϊνος or ἡ κόκκος, *Ilex aquifolia* or *coccifera*; comp. Theophrastus, *Plant.* iii, 16; Pliny, xvi, 12; Pausanias, x, 36, 1; see Kirby, *Entomol.* i, 351; Cuvier, *Anim. King.* iii, 604, 608). This shrubby tree, some two or three feet high, grows abundantly in Asia Minor and Hither Asia (certainly also in Palestine: see Belon, *Observ.* ii, 88), as well as in Southern Europe, has oval, pointed, evergreen, thorny leaves, a grayish smooth bark, and bears round scarlet berries in clustered tufts (Dioscor. iv, 48). Among the ancients, the Phœnicians generally supplied the rest of the world with crimson materials, and best understood the art of dyeing this color (2 Chron. ii, 7; comp. Pliny, ix, 65). (See Beckmann, *Beitr.* III, i, 1 sq.; Bochart, *Hieros.* iii, 524 sq.; Braun, *De vestitib. sacerdot.* l. i, c. 15, p. 215 sq.; Hartmann, *Hebr.* i, 388 sq.; iii, 135 sq.; *Penny Cyclopædia*, s. v. *Cochineal*.) —Winer, i, 218. See COLOR.

Cripple (χωλός, *lame*, as elsewhere usually rendered, or "halt"), a person deprived of the use of the lower limbs (Acts xiv, 8).

Crisp, TOBIAS, D.D., a divine of the 17th century, born 1600, died rector of Brinkworth 1642. His life was distinguished by charity, piety, humility, and purity, but he was nevertheless charged with simony in obtaining the living of Newington Butts in 1627. He followed the Puritan side in the ecclesiastical troubles, and was an extreme Calvinist, running into Antinomianism. The Westminster Assembly proposed to have his sermons burnt. The last edition of them, edited by Gill, appeared in London 1791 (2 vols. 8vo), to which the life of Crisp is prefixed. Dr. Crisp acknowledges that, "in respect of the rules of righteousness, or the matter of obedience, we are under the law still, or else," as he adds, "we are lawless, to live every man as seems good in his own eyes, which no true Christian dares so much as think of." The following sentiments, however, among others, are taught in his sermons: "The law is cruel and tyrannical, requiring what is naturally impossible." "The sins of the elect were so imputed to Christ as that, though he did not commit them, yet they became actually his transgressions, and ceased to be theirs." "The feelings of conscience, which tell them that sin is theirs, arise from a want of knowing the truth." "It is but the voice of a lying spirit in the hearts of believers that saith they have yet sin wasting their consciences, and lying as a burden too heavy for them to bear." "Christ's righteousness is so imputed to the elect that they, ceasing to be sinners, are as righteous as he was, and all that he was." "An elect person is not in a condemned state while an unbeliever; and should he happen to die before God call him to believe, he would not be lost." "Repentance and confession of sin are not necessary to forgiveness. A believer may certainly conclude before confession, yea, as soon as he hath committed sin, the interest he hath in Christ, and the love of Christ embracing him." These dangerous sentiments, and others of a similar bearing, have been fully answered by many writers, but by none more ably than by the Rev. John Fletcher, in his "Checks to Antinomianism." —Buck, *Theol. Dict.* s. v.; Orme,

Life of Baxter, ii, 292; Bogue and Bennett, *Hist. of Dissenders*, i, 400. See ANTIOMLIANISM.

Crispin and Crispinian, two brothers who, during the reign of Diocletian, went as missionaries from Rome to Gaul, and settled at Soissons. In order to support themselves and to have access to the people, they became shoemakers. Thus they worked for some time for the propagation of Christianity, until 287, when, by order of the emperor Maximianus, they were beheaded. They are commemorated in the Church of Rome on Oct. 25, and are commonly venerated as the special patrons of the shoemakers. There is a legend (for which, however, there seems to be no foundation) about these saints to the effect that they stole from rich persons the leather to make gratuitously shoes for the poor.—Wetzer u. Welte, *Kirchen-Lex.* ii, 918.

Crisping-pin (צריפין, *charit'*, something *chiselled*; the Sept. translates undistinguishably, Isa. iii, 22). This word properly signifies a *casnet* or *pouch*, and is elsewhere rendered a "bag" for money (2 Kings v, 23, where the Arabic gives a *leather money-bag*); but in the passage in Isaiah it is to be understood as some kind of female ornament; probably, like our modern *reticule*, it was a richly ornamented purse or small bag, which the women wore attached to their girdles. They are usually described as made of silk, and wrought with gold and silver; but Jahn thinks that this purse was made of solid metal, sometimes of pure gold, and fashioned like a cone, with a border of rich cloth at the top. See ORNAMENT.

Crispus (Κρίσπος, for Lat. *Crispus*, *curled*; found also in the Talmudists under the forms כריסוס and כריסוס), chief of the Jewish synagogue at Corinth (Acts xviii, 8), converted and baptized by the apostle Paul (1 Cor. i, 14) A.D. 50. According to tradition (*Constitut. Apost.* vii, 46) he was afterwards bishop of *Egina*. The Greek Church observe his festival on the 4th of October.

Critici Sacri, a very useful work in Biblical literature, undertaken and published by Cornelius Bee, bookseller (London, 1660, 9 vols. fol.), as an appendage to Walton's Polyglot, under the direction of bishop Pearson, John Pearson, Anthony Scattergood, and Francis Gouldman. It was reprinted at Frankfurt, under the care of Gurtler, in 1695, in 7 vols. In 1698 it reappeared at Amsterdam in 9 vols.; and a supplement of 2 vols. more was published in 1700 and 1701; and a second supplement appeared in 2 vols. fol., Amst. 1732. This collection contains all, or most of the books of the O. T., the entire annotations of Munster, Vatablus, Castalio, Clarius, Drusius, and Grotius; brief annotations of Fagius on the Chaldaic paraphrase of the Pentateuch, and his larger exposition of the first four chapters of Genesis; the commentaries of Masius on Joshua; the annotations of Codurcus on Job; of Pricæus on the Psalms, and of Bayne on the Proverbs; the commentary of Forerius on Isaiah, that of Lively on Hosea, Joel, Amos, Obadiah, and Jonah; of Badwell on the Apocrypha, and Hoeschel on Ecclesiastes, etc. On the N. T. it contains the collations of Valla, with the animadversions of Revins; the annotations of Erasmus, Vatablus, Castalio, Clarius, Zegerus, and Grotius; on particular places and subjects of the N. T., Munster, Drusius, Scaliger, Casaubon, Cameron, Lud. Capellus, Gualperius, Schultetus, and Pricæus. There are also a number of philological tracts and dissertations, such as John Gregory's Notes and Observations; Fagius's Comparison of the principal Translations of the O. T.; Cartwright's *Melissicism Ebraicum*; Drusius on the Mandrakes; Jos. Scaliger and Amama on Tythes; Lud. Capellus on the Vow of Jephtha and Corban; Pithæus *De Latinis Bibliorum Interpretationibus*; Ursinus *De fabrica Arca Noe*; Rittershusius *De Jure Asylorum*; Allatius *De Engastrymitho*; Monta-

nus on Jewish Antiquities; Bertram and Cuneus on the Hebrew Republic; Waser on the Ancient Coins and Measures of the Hebrews, Chaldeans, and Syrians; and many others of a similar description (Orme, *Biblioth. Bibl.* p. 128). The Amsterdam edition (1698-1732, 13 vols. fol.) is the best, being well printed, with additions, and including four volumes of *Theaurus* not contained in the original edition. Poole's *Synopsis* forms an excellent abridgment of this great work. See COMMENTARY.

Criticism, BIBLICAL. This phrase is employed in two senses. Some take it to signify not only the restoration of the text of Scripture to its original state, but the principles of interpretation. This is an extensive and improper application. The science is strictly occupied with the *text* of the Bible. It is limited to those principles and operations which enable the reader to detect and remove corruptions, to decide upon the genuineness of disputed readings, and to obtain as nearly as possible the original words of inspiration.

1. There are only three or four *sources* of material for the work of Biblical criticism, both in detecting the changes made upon the original text, and in restoring genuine readings: 1. MSS. or written copies of the Bible. 2. Ancient translations into various languages. 3. The writings and remains of those early ecclesiastical writers who have quoted the Scriptures. 4. *Critical conjecture*; but this must be used with extreme caution. See OLD TEST.; NEW TEST.

Criticism employs the ample materials furnished by these sources. To attain its end, it must work upon them with skill and discrimination. They afford wide scope for acuteness, sobriety, and learning; and long experience is necessary in order that they may be used with efficiency and success. (See *Jour. Sac. Lit.*, Jan. 1864; Heinfetter, *The True Text* of the [Heb.] *Scriptures*, 2d ed. Lond. 1861.) See MANUSCRIPTS; VER-SIONS.

CANONS OF BIBLICAL CRITICISM.

I. EXTERNAL OR OBJECTIVE.

1. *Readings found in the most ancient and more carefully written MSS. should be preferred.* Hence "uncial" copies are in general more weighty than "cursive." Yet great unanimity in the latter may overbalance fluctuation in the former.

2. *Independent witnesses must chiefly be regarded.* Hence the necessity of classifying authorities, and of reckoning all that can be traced to a common origin or edition as but one, since no copy can rise higher in value than its source, and each transcription is an additional opportunity for error. On this account the critical materials of the O. T. are meagre, as all existing Heb. MSS. are of the Masoretic recension; and but for the evidence (both historical and internal) of great competency, care, and scrupulousness on the part of these editors, their work would be of much less utility than it now is. In the N. T., too, this rule greatly reduces the testimony of the earliest extant MSS., inasmuch as they all seem to belong to the Alexandrian type, and for this reason their provincialisms in orthography ought especially to be rejected.

3. *Readings found in the original text are not to be lightly set aside through deference to versions or citations.* This not only follows as a corollary from the preceding rule, but its importance is enhanced by the ignorance, prejudices, special objects, and laxity of translators and writers quoting (sometimes from memory) in doubtful cases only (either from conflict, failure, or improbability in the original readings), therefore, can these be safely resorted to. Hence is evident equally the absurdity of excluding the Septuagint as a whole above the Hebrew, and the Vulgate above the Greek Testament. When not liable to suspicion from the above causes, however, and when sufficiently exact to be verbally appreciable translations and quotations, like direct and explicit historical statements as to particular readings, are entitled to consideration in proportion to their antiquity and excellence of opportunity.

II. INTERNAL OR SUBJECTIVE.

N. B.—This whole kind of evidence is only to be used, and that but sparingly, when the foregoing rules fall short, or are opposed by some palpable inconsistency in point of exegesis or philology in the text.

1. *Purely conjectural emendation may sometimes be cautiously employed in such cases, because it is possible that some clerical errors may have existed in the original autographs themselves, and others probably crept in at the earliest date in copying; these would therefore be liable to corrupt all later testimony.* On the other hand, arbitrary corrections must never be made except where they are absolute-

ly demanded, and where they can also be shown to have been naturally displaced by the errata; nor yet unless they are such as would be likely to have eluded the diligence of earlier collators.

2. Among several various readings, which are otherwise nearly equally supported, that one is to be selected from which the others can most readily be derived. On this principle is based the famous law of critics in general, that "the most difficult reading is to be preferred," which is but partially true, however, since the hardest readings may have been the result of inadvertence in copying, and on this principle they could never be eliminated; whereas the design of criticism is the common-sense one of lessening rather than increasing the incongruities of the text. It is only meant that we should choose that reading, rather than another, which, if originally in the text, would not be so obnoxious to copyists; yet the rule must not be so construed as to come into collision with the foregoing canon.

3. When the evidences in favor of the omission or insertion of a passage, clause, or highly significant word are nearly equally divided, it is safer to reject it (if it be not already contained in the received text), or (if it be retained for the sake of convenience) to mark it as probably spurious; for the disposition of the Church, from quite an early to a comparatively recent period, has leaned towards the admission of more and more matter (whether marginal glosses or apocryphal additions) into the sacred canon, and copyists as well as editors have felt the influence of that reverent familiarity which renders it ever increasingly difficult to expunge any thing once included in Scripture. But in judging of the genuineness in such instances, little stress can be laid upon considerations drawn from doctrinal propriety or concinnity with the context, because these are greatly affected by the individual sentiments and conventional opinions of each critic.

II. The remainder of this article (which is chiefly drawn from Kitto's *Cyclop.* s. v.) will contain a brief historical sketch of Biblical criticism, or a history of the texts of the Old and New Testaments; the condition in which they have been at different periods; the evidences on which our knowledge of their purity or corruption rests, and the chief attempts that have been made to rectify or amend them. A history of criticism must describe the various stages and forms through which the texts have passed. It will be convenient to reserve an enumeration of the causes which gave rise to various readings for a future article [see VARIOUS READINGS], and in this place to detail the phases which the Hebrew and Greek texts of the Old and New Testaments have presented both in their unprinted and printed state, in connection with the labors of scholars upon them.

A. THE OLD TESTAMENT.—There are four marked periods in the history of the Hebrew text.

1. *That Period in the History of the Unprinted Text which preceded the closing of the Canon.*—Of this we know nothing except what is contained in Scripture itself. The Jews bestowed much care on their sacred books. They were accustomed to hold them in great veneration even in the darkest times of national apostasy from Jehovah. How often the separate books were transcribed, or with what degree of correctness, it is impossible to tell. Many German critics suppose that the Hebrew text met with very unfavorable treatment; that it was early subjected to the carelessness of transcribers and officious critics. Differences, however, between parallel sections show rather the genuineness and integrity of the books in which they occur. Had such paragraphs exactly harmonised, we might have suspected design or collusion; but their variations discover the artlessness of the writers. We disagree with Eichhorn, Bauer, Gesenius, De Wette, and others, who have given lists of parallel passages in some books in order to show that the text was early exposed to extensive alterations.

The most important particular in this part of the history is the Samaritan recension of the Pentateuch. See PENTATEUCH. This edition (if so it may be called) of the Pentateuch is indeed uncritical in its character. While we freely acquit the Jews of tampering with the text of the Mosaic books, the Samaritans cannot be so readily exonerated from the imputation. Additions, alterations, and transpositions are quite apparent in their copy of the Pentateuch. A close alliance between the text which lies at the basis of the

Septuagint version and that of the Samaritan Pentateuch has been always noticed. Hence some think that they flowed from a common recension. One thing is certain, that the Seventy agree with the Samaritan in about 2000 places in opposition to the Jewish text. In other books, too, of the Old Testament, besides the five books of Moses, the Seventy follow a recension of the text considerably different from the Jewish. Thus in Jeremiah and Daniel we find a different arrangement of sections, as well as a diversity in single passages. The books of Job and Proverbs present a similar disarrangement and alteration, which must be put down to the account of the Alexandrian Jews and Greek translators. Far different was the conduct of the Palestinian Jews in the treatment of the sacred books. They were very scrupulous in guarding the text from innovation, although it is impossible that they could have preserved it from all corruption. But whatever errors or mistakes had crept into different copies were rendered apparent at the time when the canon was formed. We believe with Hävernick (*Erläuterung in das Alte Testament*, p. 49) that "Esra, in union with other distinguished men of his time, completed the collection of the sacred writings." He revised the various books, corrected inaccuracies that had crept into them, and rendered the Old-Testament text perfectly free from error. Thus a correct and genuine copy was furnished under the sanction of Heaven. Esra, Nehemiah, and those with whom he was associated, were infallibly guided in the work of completing the canon. See CANON.

2. *From the Establishment of the Canon to the Completion of the Talmud*, i. e. the commencement of the sixth century after Christ.—The Targumists Onkelos and Jonathan closely agree with the Masoretic text. The Greek translations of Aquila, Symmachus, and Theodotion, belonging to the second century, deviate from the form of the text afterwards called the Masoretic much less than the Seventy. The Hebrew column of Origen's *Hexapla* presents a text allied to the Masoretic recension. Jerome's Latin version, made in the fourth century, is conformed to the same Hebrew original. In the two Gemaras, viz. the Jerusalem and the Babylonian, belonging to the fourth and sixth centuries respectively, we discern many traces of critical skill applied to the preservation of a pure text. Different readings in MSS. are mentioned, precepts are given respecting Biblical calligraphy, and true readings are restored. By far the most important fact which they present is the adducement of classes of critical corrections made at an earlier period, and which Morinus (*Exercitationes Biblicæ*, p. 406) justly calls the fragments or vestiges of recensions. These are—(1) עשירי סופרים, *Retrenchment of scribes.* (2) תקון סופרים, *Correction of scribes.* (3) Extraordinary punctuation. (4) קרי ולא כתיב, "*Keri ve-lo kethib*," read but not written. (5) כתיב ולא קרי, "*Kethib ve-lo keri*," written but not read. (6) The Talmud also mentions different readings which the Masoretes call קרי וכתוב, "*Keri u-kethib*," read and written. See KERI and KETHIB.

The writings of Jerome afford evidence that, in the fourth century, the Hebrew text was without the vowel-points, or even the diacritical signs.

3. *From the sixth Century, in which the Talmud was completed, to the Invention of Printing.*—The learned Jews, especially those at Tiberias, where there was a famous school till the eleventh century, continued to occupy themselves with the Hebrew language and the criticism of the Old Testament. The observations of preceding Rabbis were enlarged, new remarks were made, and the vowel-system was invented, the origin of which can hardly be placed earlier than the sixth century. The name *Masora* has usually been applied to that grammatico-historical tradition which, having

been handed down orally for some centuries, became afterwards so extensive as to demand its committal to writing. Much of what is contained in the Masora exists also in the Talmud. Part of it, however, is older than the Talmud, though not reduced to its present form till a much later period. The various observations comprised in the Masora were at first written in separate books, of which there are MSS. extant. Afterwards they were put into the margin of the Bible MSS.

When we speak of the *Masoretic recension* of the text, it is not meant that the Masoretes gave a certain form to the text itself, or that they undertook and executed a new revision. They made the *textus receptus* of that day the basis of their remarks, and gave their sentiments concerning it. Had the text been altered in every case where they recommend; had it been made conformable to their ideas of what it should be, it would have been appropriate to have called it the *Masoretic recension*. The designation, however, though not applicable in strictness, is customary.

The most important part of the Masora (q. v.) consists of the marginal readings or *Keris*, which the Masoretes always preferred to the textual, and which the later Jews have adopted. The *Keris* are *critical, grammatical, orthographical, explanatory, and euphemistic*. It has been a subject of dispute among scholars from what source the Masoretes derived the *Keris*. It is highly probable that they were generally taken from *MSS.* and *tradition*, though they may have been in part the offspring of conjecture. It is but reasonable to suppose that these scholars *sometimes* gave the result of their own judgment. In addition to the *Keris* the Masora contains an enlargement of critical remarks found in the Talmud. Besides, the verses, words, and consonants of the different books of the Bible are counted, a task unparalleled in point of minute labor, though comparatively unprofitable.

The application of the Masora in the criticism of the Old Testament is difficult, because its text has fallen into great disorder. It was printed for the first time in the first Rabbinical Bible of Bomberg, superintended by Felix Pratensis. In the second Rabbinical Bible of Bomberg, R. Jacob ben-Chayim bestowed considerable care upon the printing of the Masora. At the end of this second Rabbinical Bible there is a collection of *Oriental* and *Western* readings, or, in other words, *Babylonian* and *Palestinian*, communicated by the editor, and the result of an ancient revision of the text. The number is about 216. Of the sources from which the collection was drawn we are entirely ignorant. Judging by the contents, it must be older than many observations made by the Masoretes. It should probably be referred to a period anterior to the introduction of the vowel system, as it contains no allusion to the vowels. It is certainly of considerable value, and proves that the *Oriental* no less than the *Western* Jews had always attended to the state of the sacred text. In addition to this list, we meet with another in the Rabbinical Bibles of Bomberg and Buxtorf, and in the sixth volume of the London Polyglot, belonging to the eleventh century. It owes its origin to the labors of Ben-Asher and Ben-Naphtali, the respective presidents of academies in Palestine and Babylon. These readings, with a single exception, refer to the vowels and accents. The vowel system had therefore been completed when this collection was made.

Here the history of the unprinted text may be said to close. The old unvowelled copies perished. New ones furnished with points and accents came into use. But, although the ancient copies are now irrecoverably lost, there is no reason for supposing that their preservation to the present time would have had any essential influence in altering the form of the text. The text appears to have been established and settled when the punctuation system was completed. The

labors of the Masoretic doctors have been of substantial benefit in maintaining its integrity.

4. *From the Invention of Printing to the present Time.*—There are three early editions from which all others have been taken. 1. That published at Soncino (A.D. 1488), which was the first entire copy of the Hebrew Scriptures ever printed. The text is furnished with the points and accents, but we are ignorant of the MSS. employed by the editor. 2. The second great edition was that in the Complutensian Polyglot (1514-17) taken from seven MSS. 3. The third was the second Rabbinical Bible of Bomberg, superintended by R. Jacob ben-Chayim (Venice, 1526, 6 vols. fol.). The text is formed chiefly after the Masora, but Spanish MSS. were used. Almost all modern printed copies have been taken from it. The Antwerp Polyglot has a text compounded of those in the second and third recensions just mentioned.

Among the editions furnished with a critical apparatus, that of Buxtorf, published at Basle 1619, occupies a high place. It contains the commentaries of the Jewish Rabbis Jarchi, Aben-ezra, Kimchi, Levi ben-Gerson, and Saadiah Haggaon. The appendix is occupied with the Jerusalem Targum, the great Masora corrected and amended, with the various readings of Ben-Asher and Ben-Naphtali.

The other principal editions with various readings are those of Seb. Münster, Jablonski, Van der Hooght, J. H. Michaelis, C. F. Houbigant, and Benjamin Kennicott.

(1.) Münster's edition appeared at Basle in 1586, 2 vols. 4to. The text is supposed to be founded upon that of Brescia, 1494, 4to, which resolves itself into the Soncino edition of 1488.

(2.) Jablonski's edition was published at Berlin in 1699, 8vo, and again at the same place in 1712, 12mo. It is founded upon the best preceding editions, but chiefly the second edition of Leusden (1667). The editor also collated various MSS. The text is remarkably accurate.

(3.) Van der Hooght's edition appeared at Amsterdam 1706. The text is taken from Athias's (1661 and 1667). The Masoretic readings are given in the margin; and at the end are collected the various readings of the editions of Bomberg, Plantin, Athias, and others.

(4.) The edition published by J. H. Michaelis in 1720 is accompanied with the readings of twenty-four editions which the editor examined, besides those of five MSS. in the library at Erfurd. There is a want of accuracy in his collations.

(5.) In 1758, C. F. Houbigant published a new edition in folio. The text is that of Van der Hooght, without the points. In the margin of the Pentateuch the Samaritan readings are added. For it he collated, but hastily, twelve MSS. He has justly been blamed for his rash indulgence in conjectural emendation.

(6.) Dr. Kennicott's edition, which is the most important hitherto published, appeared at Oxford, in folio—the first volume in 1776, the second in 1780. The number of MSS. collated by himself and his associates, the chief of whom was Professor Bruns of Helmstadt, amounted to 694. In addition to his collation of MSS. and printed editions, he followed the example of various editors of the Greek Testament in having recourse to Rabbinical writings, especially the Talmud. The immense mass of various readings here collected is unimportant. It serves, however, to show that, under the influence of the Masora, the Hebrew text has attained a considerable degree of uniformity in all existing MSS.

(7.) In 1784-88, John Bernard de Rossi published at Parma, in 4 vols. 4to, an important supplement to Kennicott's collection. These various readings were taken from 88 MSS. used by Kennicott and collated anew by De Rossi, from 479 in his own possession and 110 in other hands, from many editions and Samaritan MSS., and also from ancient versions.

(8.) In 1793, Döderlein and Meisner published at Leipzig an edition intended in some measure to supply the want of the extensive collations of Kennicott and De Rossi. It contains the most important readings. The edition of Jahn, published at Vienna in 1806, is very valuable and convenient.

(9.) The most accurate editions of the Masoretic text are those of Van der Hooght, as lately edited by Hahn and by Theile, at Leipzig, and stereotyped. The text of Van der Hooght may now be reckoned as the *textus receptus*. (For full lists of the printed editions of the Hebrew Bible, the reader is referred to Le Long's *Bibliotheca*, edited by Masch, and to Rosenmüller's *Handbuch für die Literatur der biblischen Kritik und Exegese*, i, 189-277. See also Darling's *Cyclopaedia Bibliographica*, vol. on the "Holy Scriptures," col. 45 sq.)

Notwithstanding all these editions, something is still wanted. In the best of them there are passages requiring emendation. It is curious to observe how contradictions are allowed to remain on the face of the Old-Testament history. It may be that the Masora has produced so great a uniformity that extant MSS. do not sanction any departure from the present text, but, where passages are manifestly corrupt, it is proper that they should be rectified. The criticism of the Hebrew Bible is still behind that of the Greek Testament. The latter was earlier begun, and has been more vigorously prosecuted. We remain nearly in the same state with regard to the Old-Testament text as that in which Kennicott and De Rossi left us, and it is time that some advance should be made in this department. The only important recent work in this direction is Dr. S. Davidson's *Revision of the Heb. Text of the O. T.* (London, 1855, 8vo). See SCRIPTURES, HOLY.

B. We shall now give a brief history of THE NEW-TESTAMENT text in its *unprinted* and *printed* form. The criticism of the New Testament is rich in materials, especially in ancient MSS. But, although the history of New-Testament criticism records the industrious collection of a large amount of materials, it is not equally abundant in *well-accredited facts*, such as might be of essential benefit in enabling us to judge of the changes made in the text. History is silent respecting the period when the two parts of the New Testament, viz., the *εὐαγγέλιον* and *ἀποστόλος*, or, in other words, the four Gospels, and the Pauline and remaining epistles, were put together, so as to form *one whole*. About the beginning of the third century, it is certain that all the books of the New Testament which we now possess were acknowledged to be divine and regarded as canonical. See CANON.

1. In the middle of the same century Heyschius and Lucian undertook to amend the MSS. of the New Testament. Of their critical labors Jerome seems not to have entertained a high opinion. The MSS. they revised did not meet with general approval, and pope Gelasius issued a decree against them. It is highly probable that they were not the authors of recensions which were widely circulated or generally adopted. Origen did not revise the text of the New Testament.

At a comparatively recent period certain internal marks were observed to belong to documents containing the same text. A similarity in characteristic readings was noticed. Bengel appears to have been the first to whom the idea suggested itself of dividing the materials according to the peculiarities which he faintly perceived. It was afterwards taken up by Semler, and highly elaborated by Griesbach. Later editors and critics have endeavored to improve upon Griesbach's system. The different forms of text observed by Semler and Griesbach they called *recensions*, although the appellation of *family* is more appropriate. Perhaps the data that have been so much regarded in classifying the documents containing the New-Testament text are insufficient to establish any system.

The subject of recensions, though frequently discussed is not settled. In the history of the *unprinted text* it is the chief topic which comes before the inquirer. Reserving it for future notice (see REVISIONS), we pass to the history of the *printed text*, and the efforts made to amend it.

2. The *whole* of the New Testament was first printed (1.) in the Complutensian Polyglot, 1514, fol. (vol. v.) though not published till 1517. The first published was (2.) that of Erasmus, at Basle, in 1516, 2 vols. in 1. fol. Both were issued independently of one another, and constitute the basis of the *received text*. Yet the best materials were not employed in preparing them, and on both the Vulgate was allowed to exert an undue influence. Even critical conjecture was resorted to by Erasmus. No less than five impressions were published by Erasmus, into the *third* of which 1 John v, 7, was first put. In the last two he made great use of the Complutensian Polyglot.

(3.) The third place among the early editors of the Greek Testament has been assigned to Robert Stephens, whose first edition was printed at Paris (1546, 12mo), chiefly taken from the Complutensian, and generally styled the *Mirifica* edition, from the commencement of the preface. His second edition was published in 1549; the third in 1550, in folio. In this last he followed the fifth of Erasmus, with which he compared fifteen MSS., and the Complutensian Polyglot. In 1551 appeared another edition, accompanied by the Vulgate and the translation of Erasmus. It is remarkable for being the first into which the division of verses was introduced.

(4.) The next person that contributed to the criticism of the Greek Testament was Theodore Beza. The text of his first edition (1565, folio) was the same as that of the third of Stephens, altered in about fifty places, accompanied with the Vulgate, a Latin version of his own, and exegetical remarks. In his second edition (1582) he had the benefit of the Syriac version and two ancient codices. A third impression appeared in 1589, and a fourth in 1598. The *Elzevir* editions exhibit partly the text of the third of Stephens, and partly that of Beza. The first appeared at Leyden in 1624. The second edition of 1633 proclaims its text to be the *textus receptus*, which it afterwards became. Subsequently three other editions issued from the same press. The editor does not appear to have consulted any Greek MSS. All his readings are either in Beza or Stephens. The *Elzevir* editions are all in 12mo.

(5.) Brian Walton, the learned editor of the London Polyglot, gave a more copious collection of various readings in the sixth volume of that work than had before appeared, which was further enlarged by Dr. Fell, in his edition, published at Oxford in 1675, and reprinted by Gregory in 1703, folio. See POLYGLOTS.

(6.) Dr. John Mill, encouraged and supported by Fell, gave to the world a new edition in 1707, folio. The text is that of Stephens's third edition. In it the editor exhibited, from Gregory's MSS., a much greater number of readings than is to be found in any former edition. He revised and increased the extracts formerly made from ancient versions. Nor did he neglect quotations from the fathers. It is said that the work contains thirty thousand various readings. This important edition, so far superior to every preceding one, cost the laborious editor the toilsome study of thirty years, and excited the prejudices of many who were unable to appreciate its excellence. It constituted a new era in the criticism of the New Testament. Ludolph Kuster reprinted Mill's Greek Testament at Amsterdam in 1710, enriching it with the readings of twelve additional MSS. The first attempt to amend the *textus receptus* was made by John Albert Bengel, abbot of Alpirspach. His edition appeared at Tübingen (quarto, 1734), to which was prefixed his "Introductio in crisin Novi Testamenti." Subjoined is an *apparatus criticus*, containing his collection of

tious reading, chiefly taken from Mill, but with important additions.

7.) Dr. John James Wetstein contributed, in no all degree, to the advancement of sacred criticism, his large edition of the Greek Testament, published Amsterdam in 1751-2, 2 vols. folio. In 1780 he had published *prolegomena*. It was his desire to give a new and corrected text, but he was compelled by circumstances to exhibit the *textus receptus*. Yet he added, partly in the text itself, partly in the inner margin, such readings as he preferred. His collection of various readings, with their respective authorities, far exceeds all former works of the same kind in copiousness and value. He collated anew many important MSS. that had been superficially examined, gave extracts from many for the first time, and made use of Harclean (improperly called the Philoxenian) version, hitherto uncollated. For convenience he marked special MSS. with the letters of the alphabet, and *curssive* with numerical letters. His exegetical notes are chiefly extracts from Greek, Latin, and Jewish writers. The edition of the Greek Testament under consideration is indispensable to every critic, and will always be reckoned a marvellous monument of laborious energy and unwearied diligence. The *prolegomena* contain a treasure of sacred learning that will always be prized by the scholar. They were reissued, with valuable notes, by Semler (1774, 8vo).

(8.) The scholar who is pre-eminently distinguished in the history of New-Testament criticism is Dr. John Griesbach. He enriched the materials collected by Wetstein with new and important additions, by collating MSS., versions, and early ecclesiastical writings, particularly Origen, with great labor. The ideas recommended by Bengel and Semler, he adopted, and carried out with much acuteness and sagacity. His first edition appeared at Halle (2 vols. 8vo, 1745). The first three gospels were synoptically arranged, but in 1777 he published them in their natural order. The text is founded on a comparison of the pious materials which he possessed. Nothing was adopted from conjecture, and nothing received which did not have the sanction of codices as well as versions. A list number of readings is placed beneath the text. In his *Symbolæ Criticæ* he gave an account of his critical labors, and of the collations of new authorities he had made. Such was the commencement of Griesbach's zealous labors.

(9.) Between the years 1782-88, C. F. Matthæi published a new edition of the Greek Testament at Riga, 12 vols. 8vo. His text was founded on a collation of more than 100 Moscow MSS., which he first examined. It is accompanied with the Vulgate, *scholia*, and *varia*. He avowed himself an enemy to the ideas recommended, despised the ancient MSS. (especially codices) and the quotations of the fathers, while he unduly exalted his Moscow MSS. His chief merit lies in the careful collation he made of a number of MSS. hitherto unknown.

(10.) Before the completion of Matthæi's edition appeared that of Alter (Vindob. 1786-7, 2 vols. 8vo). His text is that of the Vienna MS., with which he collated 22 others in the Imperial library. To these he added readings from the Coptic, Slavonian, and Latin versions.

(11.) In 1788, Professor Birch, of Copenhagen, enlarged the province of sacred criticism by his splendid edition of the four Gospels in folio and quarto. The text is a reprint of Stephens's third, but the materials appended to it are highly valuable. They consist of extracts taken by himself and Moldenhauer, in their travels, from many MSS. not examined by Wetstein, and of Alter's selections from the Jerusalem-Syriac version discovered in the Vatican. Birch was the first who carefully collated the *Codex Vaticanus*. The publication of the second volume was prevented by a fire that destroyed many of the materials. In 1798 he

published his various readings on the remainder of the New Testament, except the Apocalypse. In 1800 he published those relating to this book also.

(12.) In 1796 appeared the first volume of a new and greatly-improved edition of Griesbach's New Testament. For it he made extracts from the Armenian, Slavonic, Latin, Sahidic, Coptic, and other versions, besides incorporating into his collection the results of the labors of Matthæi, Alter, and Birch. The second volume appeared in 1806, both published at Halle, in 8vo. At the end of the second volume is a dissertation on 1 John v, 7. The work was reprinted at Leipzig, 1808-7, in four splendid 4to vols.; also at London in 1809, and again in 1818, 2 vols. 8vo. The *prolegomena* are exceedingly valuable. This edition cannot be too highly rated. It is indispensable to every critic and intelligent theologian.

In 1827, many new materials having been procured since the date of Griesbach's last edition, it was thought necessary to publish a third. It appeared accordingly, under the superintendence of Dr. Schulz, at Berlin, in 8vo. The first volume contains the *prolegomena* and the Gospels. It exhibits various readings from about 20 new sources, many corrections of Griesbach's references and citations, besides considerable improvements in other respects. The second volume has not been published.

The editions of Knapp, Schott, Tittmann, Vater, Næbe, and Göschel are chiefly founded upon that of Griesbach. Of these the most esteemed is that of Knapp, which has passed through five editions, and is characterized by sound judgment, especially in the punctuation and accents.

(14.) In 1880 appeared the first volume of a large critical edition, superintended by Dr. J. Martin Augustus Scholz, professor at Bonn, containing the Gospels. The second volume, in 1886, completed the work. Both are in quarto. The editor spent twelve years of incessant labor in collecting materials for the work, and travelled into many countries for the purpose of collating MSS. The *prolegomena* prefixed to the first volume occupy 172 pages, and contain ample information respecting all the codices, versions, fathers, acts of councils, etc., which are used as authorities, together with a history of the text, and an exposition of his classification system. In the inner margin are given the general readings characteristic of the three great families. The total number of MSS. which he has added to those previously collated is 606. Little reliance, however, can be placed on the accuracy of the extracts which he has given for the first time. His researches have tended to raise the *textus receptus* higher than Griesbach placed it. In consequence of his preferring the *Constantinopolitan* family, his text comes nearer the Elzevir edition than that of Griesbach. The merits of this laborious editor are considerable. He has greatly enlarged our critical apparatus. Yet in acuteness, sagacity, and scholarship he is far inferior to Griesbach. His collations appear to have been superficial. They are not to be depended on. Hence the text can not command the confidence of Protestant critics. We can not believe, with the editor, that the Byzantine family is equal in value or authority to the Alexandrine, which is confessedly more ancient, nor can we put his junior codices on a level with the very valuable documents of the Oriental recension. His text is, on the whole, inferior to that of Griesbach. In a few important passages only it is superior.

(15.) The edition of Lachmann, though small in compass, deserves to be especially mentioned. It was published at Berlin in 1831, 12mo. The editor says that he has nowhere followed his own judgment, but the usage of the Oriental churches. The text of Lachmann has been well received in Germany, and much importance has been attached to it. From the authority it has obtained, it would appear that the Constantinopolitan text of Scholz is not very favorably regarded.

De Wette, in his *Introduction to the Bible*, shows a leaning towards the views of Lachmann. Rinck coincides, on the whole, with the same. The last-named scholar has enlarged the critical apparatus of the New Testament by collating and describing several MSS. (*Lucubratio Critica in Acta Apost. epp. Cath. et Paulin.*, etc., etc., Basel, 1830, 8vo). There is also a large edition by Lachmann (*Novum Testamentum, Græce et Latine. Carolus Lachmannus recensuit. Philippus Buttmannus Ph. F. Græca lectiois auctoritates apposuit.* Tomus prior, Berolini, 1842, 8vo; tomus alter, ib. 1850).

The editions by this critic are by far the most important that have appeared since the days of Griesbach, and must produce results highly favorable to the advancement of New Testament criticism. The principles on which Lachmann proceeds were expounded in the *Theolog. Studien. und Kritiken* for 1830, p. 817-845, and again in 1835, p. 570 sq. The path which he first pursued in his smaller edition was indicated by Bentley, who purposed to publish the Greek Testament on similar principles. In order to discover his *Oriental* text (a text which is substantially the same as the *Alexandrian*), Lachmann makes use of the following authorities: 1. A, B, C, D, as also P, Q, T, Z, in the Gospels, and in the Pauline epistles, H in addition. 2. *Latin interpretations*, viz. in the Gospels the Vercellian, Veronian, Colbertine, Cambridge; in the Acts the Cambridge and Laudian; in the Pauline epistles the Clermont, St. Germain's, Boernerian; in the Apocalypse the Primasian. In addition to these, the Vulgate, as edited by Jerome, is everywhere employed. Of the fathers, he consults Irenæus, Origen, Cyprian, Hilary, and Lucifer. The immense mass of later MSS. and fathers is entirely overlooked as useless. The authorities for the Greek readings are given below the text; and, when it is considered how few materials are employed, it will readily be supposed that the various readings noted are not numerous. They are, however, most valuable and important. In addition to the Greek text and critical apparatus, the Hieronymian Vulgate is given, in the same form, as nearly as possible, in which it proceeded from Jerome, with important readings extracted from the Fuldensian Codex, from the same corrected by Victor, bishop of Capua, and from the Laurentian Codex. The great aim of the editor has been to exhibit a text in which the most ancient authorities are entirely agreed. Wherever this cannot be done with certainty, his critical apparatus shows the degree of probability attached to the text as given by him. To the volume is prefixed a preface of 55 pages (a few of them from Buttmann), in which the learned editor expounds his mode of procedure, and the authorities consulted. Respecting the opponents of his system, he does not speak in the most courteous or becoming language, nor is his Latinity the purest. Yet the preface is instructive withal, and must be studied by him who uses Lachmann's text. Were we disposed to follow the text of any one editor absolutely, we should follow Lachmann's. But it may be doubted whether he has not confined himself to a range of authorities too circumscribed. By keeping within the fourth century he has occasionally been compelled to rest upon one or two testimonies. We should therefore like to see more authorities consulted. We are persuaded, however, that this author has entered upon a right path of investigation, which will lead to results both permanently useful and unusually successful. The correctness of these principles, in the main, has been vindicated by the fact that later eminent critics have pursued essentially the same path.

(16.) Since the appearance of Lachmann's first edition, another has been published in Germany by Dr. Tischendorf (Leipzig, 1841, 8vo), which requires notice. It exhibits a corrected text, taken from the most ancient and best MSS., with the principal various readings, together with the readings of the Elzevir, Knapp,

Scholz, and Lachmann editions. Great pains has manifestly been bestowed on the text and the critical apparatus subjected to it. The prolegomena, consisting of 86 pages, are exceedingly valuable. They treat of *recensions*, with an especial reference to Scholz's system; enumerate the readings peculiar to the third edition of Stephens and that of Mill, to the editions of Matthæi and Griesbach; and specify the critical materials employed in the elaboration of a pure text. A careful perusal of the editor's able preface, and a collation of his text and critical apparatus beneath it, have convinced us of the great candor, minute diligence, extreme accuracy, and admirable skill by which this edition of the Greek Testament is characterized.

In 1859, Tischendorf published the seventh edition of his Greek Testament (Lpz. 8vo), greatly enlarged and improved, from the materials which he had brought to light in the interim. A notable addition to the latter is the famous Sinaitic MS. (q. v.) discovered by him, and lately published, the results of the examination of which, together with those of the Codex Vaticanus recently given by cardinal Mai to the public, are embraced, with other fresh materials, in Tischendorf's eighth edition now in course of publication (Lpz. 1864, sq. 8vo).

(17.) A new and critical edition of the Greek Testament, accompanied by the old Latin version, has been begun by Dr. Tregelles, and issued in *fasciculi*, of which the Gospels have appeared (London, &c.). The editor aims at great accuracy in his authorities. His text, however, shows defective judgment, and relies too exclusively on a few ancient MSS. It will be a valuable contribution, however, to sacred criticism.

(18.) Alford's *Greek Testament* (London, 1853-61; 3 vols. 8vo) contains a revised text and a copious critical apparatus, mostly compiled, however, from Tischendorf, and marked by too great a leaning to subjective or internal evidence.

(19.) Mr. Scrivener's critical labors on the Greek Testament deserve mention in this connection for their accurate research. An account of them may be found in his *Introduction* (Cambr. 1861, 8vo).

III. The operations of sacred criticism have established the genuineness of the Old and New Testament texts in every matter of importance. All the doctrines and duties remain unaffected by its investigations. It has proved that there is no material corruption in the inspired records. It has shown that during the lapse of many centuries the Holy Scriptures have been preserved in a surprising degree of purity. The text is substantially in the same condition as that in which it was found seventeen hundred years ago. Let the plain reader take comfort to himself when he reflects that the received text which he is accustomed to read is *substantially* the same as that which men of the greatest learning and the most unwearied diligence have elicited from an immense heap of documents.

For a copious account of the various editions of the Greek Testament the reader is referred to *Le Long's Bibliotheca*, edited by Masch; or to Rosenmüller's *Handbuch für die Literatur der biblischen Kritik und Exegese*, i, p. 278-422; or to Tregelles's *Account of the printed Text of the Gr. New Test.* (Lond. 1854). A pretty full list may be found in Darling's *Cyclopædia Bibliog.* col. 61 sq. See also an article on the "Manuscripts and Editions of the New Testament," by Moses Stuart, in Robinson's *Bibliotheca Sacra*, No. 2, May, 1843. For an account of the principal authors on Biblical Criticism, see Davidson's *Lectures on Biblical Criticism* (2 vols. 8vo, Edinb. and Bos. 1852). See ERSE.

Croatia and Slavonia, a united province of the Austrian empire; area 9800 square miles; population in 1857, 865,403. The inhabitants are of Slavonian descent, and mostly belong to the Roman Catholic religion (in 1851, 770,656 Roman Catholics, and 88,331 United Greeks). There were, besides, 386 Lutherans, 4445 Reformed, 718 Greeks, 6 Unitarians, and 3911

ws. Croatia is considered a part of Hungary, but merely possessed some privileges; among others, to cede Protestants from its borders. In 1866 the roatian Diet passed resolutions in favor of religious liberation.

CROCIVS, JOHANNES, a German theologian, was born at Laaspe July 28, 1590; studied at Herborn and Marburg, and graduated in 1608. In 1612 he became court preacher of the Landgrave Moritz at Cassel, doctor of divinity in 1618, and in 1616 preacher at Ronigberg. Returning to Marburg, he became professor of Theology in the University. He was the leader of the evangelical state Church of Hesse-Cassel, and the Lutheran having overcome the Reformed Church, he fled to Cassel in 1624; but after the peace of 1653, he returned and became rector of the University. He died July 1, 1659. His principal works are, *Erronea dogmata novorum Arianorum in Polonia* (Brema, 1612, 8vo); *Paxis et concordia evangelicorum sacra defensio* (Marburg, 1628, 8vo); *Anti-Becanus i. e. controversiarum communium, quas Mart. Becanus Catholicis, Lutheri ac Calvini nomine perperam discretis, a Masualii movit examen, ex S. S. et antiquitate institutum* (Cassel, 1643, 2 vols. 4to); *Anti-Becani a Moguniorum theologorum calumniis justa vindicatio* (Marburg, 1654); *Anti-Weigelus* (Cassel, 1651).—Herzog, *Real-Encyclopädie*, iii, 187.

Crocodile, an animal doubtless referred to under the name *Leviathan* (לִיְיָתָן) in the famous description of Job xli (Heb. xl, 25–xli), of which the following is a close rendering:

Canst thou draw out Leviathan with a hook,
Or with a cord canst thou press down his
tongue?
Say, canst thou put a rush-^{rope} in his
nose,
Or with a thorn-^{hook} canst thou bore
his jaw?
Will he multiply to thee supplications;
Supposeth thou he will speak to thee soft
[things]?
Will he ratify a covenant with thee?
Wilt thou take him for a servant [for]
ever?
Wilt thou play with him as with the sparrow,
Or tie him for thy maidens?
Shall there dig [a pit] for him partners,
[And] share him between Canaanites [i.
e. merchants]?
Canst thou fill with darts his skin,
Or with a fish-spear [i. e. harpoon] his head?
Lay upon him [but] thy hand—
Thou wilt remember battle no more!
Lo! his [i. e. the assailant's] hope has been
belled:
At the very sight of him will he be prostrated?
None [so] bold that will rouse him!
(Then who [is] he [that] before Me shall take a stand?)
Who has anticipated me [in giving], that I should repay?
Under the whole heavens to me [belongs] that!
I will not pass in silence his members,
And famed strength, and beauteous armature.
Who has disclosed the surface of his covering?
In his double [row] of grinders who can enter?
The valves of his face who has opened?
The circuits of his teeth [are] frightful!
A pride [are his] strong shields [i. e. scales],
Shut [with] a close seal:
One in [the] other will they join,
And a breath cannot come between them:
Each in his fellow will adhere;
They will cling together that they cannot be parted.
[At] his sneezings a light will flash,
And his eyes [are] like the lashes of dawn:
From his mouth will flames proceed;
Sparks of fire will escape:
From his nostrils a smoke will go,
Like a pot blown with [blazing] reeds:
His breath—coals will it kindle,
And a flame from his mouth will go.
In his neck force shall lodge,
And before him terror shall run.
The flaps of his flesh have stuck [fast];
Solid upon him, it cannot be shaken:
His heart [is] solid like a stone,
Even solid like [the] under mill-stone.
From his rising [the] mighty shall fear,
From terrors they shall stray.

[One] hitting him [with the] sword, it will not at all
stand [the shock]—
Lance, dart, or mail:
He will regard as straw, iron;
As rotten wood, copper:
The bow-shot cannot make him flee,
To chaff have sling-stones been changed for him:
Like chaff clubs have been regarded [by him],
And he will laugh at the brandishing of the javelin.
Under him [are] points [as] of pottery,
He will strew [his spiked belly like] a threshing-sledge
upon [the] mud:
He will cause [the] deep to boil like the pot,
[The] sea he will make like the unguent-kettle:
Behind him he will illuminate a path;
[One] would regard [the] main as hoary.
[There is] not upon [the] dust his ruler—
The [one] made without dismay:
Everything lofty will he behold—
He, [the] king over all the sons of pride [i. e. larger beasts].

This description is in the main strikingly applicable to animals of the alligator tribe, although highly colored in the poetic style. Yet, as observed with regard to the associated animal (see ВЕНЕМОТЪ), the phraseology is perhaps rather intended generically for large amphibious monsters of the saurian or lizard family, than for any one creature distinctively; a conclusion that is confirmed by the employment of the Heb. term *leviathan* to other animals of the fishy and reptile kinds. Indeed, as in the case of the hippopotamus, despite the formidable attributes ascribed to the beast in question by the writer in Job, it appears to have been attacked without much fear by the ancients; and although held sacred in some parts of Egypt, where it is especially found, in other nomes it was hunted suc-

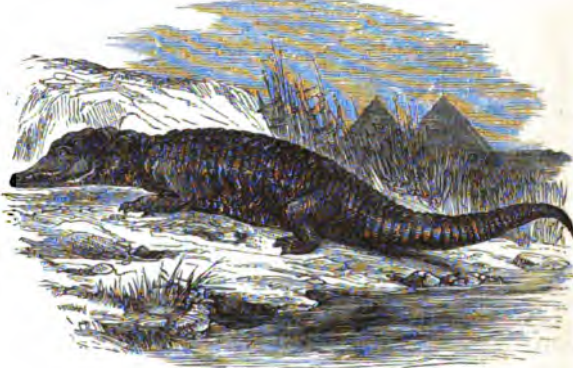

Crocodile (*Crocodylus Vulgatus*).

cessfully (Wilkinson, *Anc. Eg.* i, 241 sq.). The crocodile, however, is apparently elsewhere definitely referred to in Scripture by other names, especially as the *reed-beast* (Psa. lxxviii, 31; see Schramm, *De bestia arundineti*, F. ad O. 1718). See RAHAB.

"The crocodiles, constituting the order *Loricata* among reptiles, are distinguished pre-eminently by the character noticed in Holy Writ. They are clothed on the entire upper parts of the body with distinct series of bones, imbedded in the substance of the skin, and for the most part furnished with a ridge or crest, which greatly augments their strength, and constitutes the whole a coat of plate-mail which is able to resist the assaults of the most powerful enemy. The structure of the skull is remarkably solid, and it is surmounted by bony crests. There is a single row of teeth in each side of each jaw, locking into each other. The gape is enormous; the lips are altogether wanting, so that the teeth are visible when the mouth is closed; hence the animal, even when tranquil, seems to be grinning with rage. The tongue is fleshy, flat, but free only at the extreme edge, the inferior surface being adherent to the chin and throat; hence the crocodile has been erroneously represented as tongueless.

"All the species of this order are of huge size: not

only are they the hugest of reptiles, but they are among the most gigantic of all animals. Crocodiles have been described as attaining a length of twenty-five feet, but no specimens have been brought to Europe of nearly that size. They are probably long-lived, and perhaps their increase of dimensions is commensurate with their age. Highly carnivorous and predaceous, fierce and cunning, they are greatly dreaded in all the tropical regions which they inhabit. Lurking in the dense reeds or tangled herbage that grows rank and teeming at the edges of rivers in hot climates, or under the mangroves that interweave their myriad roots in arches above the water, or concealed among the bleaching trunks and branches of trees that have fallen into the stream, these huge reptiles watch for the approach of a living prey, or feed at leisure on the putrid carcasses with which the waters daily supply them. It is even affirmed that they prefer a condition of putrescence in their prey, and that their practice, when not pressed by immediate hunger, is, on seizing a living prey, to plunge into the stream in order to drown it, after which it is dragged away to some hole, and stored until decomposition has commenced.

"Among the decorations of the palace of Shalmaneser, M. Botta discovered a bas-relief continued over five slabs, and representing a great naval expedition against a maritime city. A fleet of ships transport timber along a coast washed by the sea, and studded with fortified islands—perhaps the siege of Tyre by this Assyrian monarch. The sea is represented as filled with various marine animals, such as fishes of various forms, turtles, turbinate shells, crabs, and crocodiles (*Mon. de Nîmèe*). This, it is true, may have been but a license of the artist; but Mr. Lyell, in his *Principles of Geology*, observes that the gavial, a larger species than the crocodile of the Nile, inhabiting the Ganges, descends beyond the brackish water of the delta to the sea. And other species of the genus *Crocodilus* (as restricted) are frequently known not only to haunt the mouths of rivers, but even to swim among islands, and pass from one to another, though separated by considerable spaces of open sea" (Fairbairn, s. v.). See the *Penny Cyclopaedia*, s. v. Compare LEVIATHAN.

"The crocodiles consist of three varieties, or perhaps species, all natives of the Nile, distinguishable by the different arrangement of the scutæ or bony studs on the neck, and the number of rows of the same processes along the back. Their general lizard-form is too well known to need particular description; but it may be remarked that of the whole family of crocodiles, comprehending the sharp-beaked gavials of India, the alligators of the West, and the crocodiles properly so called, the last are supplied with the most vigorous instruments for swimming, both from the strength and vertical breadth of their tails, and from the deeper webs of the fingers of their paws. Although all have from thirty to forty teeth in each jaw, shaped like spikes; without breadth so as to cut, or surface so as to admit of grinding, the true crocodile alone has one or more teeth on each side in both jaws, exerted, that is, not closing within, but outside the jaw. They have no external ear beyond a follicle of skin, and the eyes have a position above the plane of the head, the pupils being contractile, like those of a cat, and in some having a luminous greenish tinge, which may have suggested the comparison of the eyes of leviathan to 'the eyelids of the dawn' (Job xli, 10 [A. V. 18]). The upper jaw is not movable, but, as well as the forehead, is extremely dense and bony; the rest of the upper surface being covered with several rows of bosses, or plated ridges, which on the tail are at last reduced from two to one, each scale having a high horny crest, which acts as part of a great fin. Although destitute of a real voice, crocodiles when angry produce a snorting sound, something like a deep growl [or rather grunt]; and occasionally they open the mouth very wide, remain for a time thus exposed facing the breeze, and,

closing the jaws with a sudden snap, cause a report in the fall of a trap-door. It is an awful sound in the stillness of the night in tropical countries. The gape of the crocodile is very wide, the tongue being completely tied to the lower jaw, and beneath it are glands exuding a musky substance. On land the crocodile next to the gavial, is the most active, and in the water it is also the species that most readily frequents the open sea. Of the immense number of genera examined, none reached to 25 feet in length, and the specimen in the British Museum is believed to be one of the largest. Sheep are observed to be unmolested by these animals; but where they abound no pigs can be kept, perhaps from their frequenting the muddy shores; for we have known only one instance of crocodiles being encountered in woods not immediately close to the water's side: usually they bask on sandy islands. They rarely attack men, but women are sometimes seized by them: in Nubia they are much more dangerous than in Egypt. (See Wilkinson's *Modern Egypt and Thebes*, ii, 127.) As their teeth are long, but not fitted for cutting, they seize their prey, which they can not masticate, and swallow it nearly entire, or bury it beneath the waves to macerate. Having very small excretory organs, their digestion requires, and accordingly they are found to possess, an immense biliary apparatus. They are oviparous, burying their eggs in the sand; and the female remains in the vicinity to dig them out on the day the young have broken the shell. Crocodiles are caught with hooks, and they seldom succeed in cutting the rope when properly prepared. Though a ball fired point blank will penetrate between the scales which cover the body, the invulnerability of these great saurians is sufficiently exemplified by the following occurrence. One being brought well bound to the bazaar at Cawnpore on the Ganges, it was purchased by the British officers on the spot, and carried farther inland for the purpose of being baited. Accordingly, the ligatures, excepting those which secured the muzzle, being cut asunder, the monster, though it had been many hours exposed to the heat, and was almost suffocated with dust, fought its way through an immense crowd of assailants, soldiers and natives, armed with staves, lances, swords, and stones, and worried by numerous terriers, hounds, and curs; overturning all in its way, till, scenting the river, it escaped to the water at a distance of two miles, in spite of the most strenuous opposition!

"With the ancient Egyptians the crocodile was a sacred animal, not, however, one of those revered by the whole nation, but only locally held in honor. Of old it was found in Lower as well as Upper Egypt; now it is restricted to the latter region, never descending as low as Cairo, and usually not being seen until the traveller approaches the Thebais. In hieroglyphics it bears the name *mesu*, literally 'in the egg,' as though expressing surprise that so great an animal should issue from so small an egg. From this name the Coptic and Arabic names take their origin. The crocodile was sacred to the god Sebak, represented with the head of this animal and the body of a man, and of uncertain place in the Egyptian mythology. It was not only not worshipped throughout Egypt, but was as much hated in some as venerated in other parts of the country: thus in the Ombite nome it was worshipped, and hunted in the Apollinopolite and Tentyrite nomes. The worship of this animal is no doubt of Nigritian origin, like all the low nature-worship of Egypt. It is not certain that the crocodile was an emblem of the king with the Egyptians, but it seems probable that this was the case.

"There is evidence that the crocodile was found in Syria at the time of the Crusades. A reptile of this kind has lately been discovered in the Nahr el-Kelb, the ancient Lycus.

"The exploit of Diendoné de Bozon, knight of St. John, who, when a young man, slew the dragon of

Rhodes, an exploit which Schiller has celebrated in his *Kampf mit dem Drachen*, must be regarded as a combat with a crocodile, which had probably been carried northward by the regular current of the eastern Mediterranean; for so the picture still extant in thearem of a Turkish inhabitant represents the Haya-vân Kéber, or Great Beast—a picture necessarily painted anterior to the expulsion of the knights in 1480. La De Bozon died Grand Master of the Order at Rhodes in 1353, and the spoils of the animal long remained hung up in a church, there is not, we think, any reason to doubt the fact, though most of the recorded circumstances may be fabulous. See DRAGON. All the ancient Greek and the later Mediterranean dragons, as those of Naples, Arles, etc., where they are not allegorical or fictitious, are to be referred to the crocodile" Kitto, s. v.). See LIZARD.

Crocodilopolis (*κροκοδείλων πόλις*), the name of a town in Syria, situated near a river of the same name (*Crocodilón flumen*, between Cæsarea Palæstinae and Ptolemais (Strabo, xvi, p. 768; Pliny, v, 17, 19). Beland (*Palæst.* p. 739) thinks the latter may have been the same with the ΣΗΘΩΒ-ΛΙΒΝΑΘ (q. v.) of Josh. xix, 26. It is now identified with the *Nahr Zerka* (Rauman, *Palæst.* p. 53, 191), in which crocodiles have been found (Pococke, *Travels*, ii, 58; Thomson, *Land and Book*, ii, 244).

Croes, JOHN, D.D., Protestant Episcopal bishop of New Jersey, was born June 1, 1762, and ordained in 1790. Having previously acted as lay reader in the P. E. church of Swedesborough, N. J., he became its rector in 1792. He was a prominent member in the Convention of New Jersey for forty years. In 1801 he became rector of Christ Church, New Brunswick, and of St. Peter's Church, Spotswood. In 1811 he was made D.D. by Columbia College, and in 1815 was chosen bishop of New Jersey, having declined the episcopate of Connecticut. From the time of his consecration he observed a system of annual visitations, and his last public act was an ordination in Christ Church, New Brunswick. He died July 26, 1832. He published several charges to his clergy, and a sermon on *The Duty and the Interest of contributing liberally to the Promotion of Religious and Benevolent Institutions*.—Sprague, *Annals*, v, 378.

Croft, GEORGE, D.D., an English divine, was born at Skipton, Yorkshire, in 1747; admitted at University College, Oxford, in 1762, was elected scholar in 1768, and fellow in 1779. In the same year he became vicar of Arncliffe, Yorkshire; in 1791, lecturer of St. Martin's, Birmingham, and finally rector of Flving in 1802. He died in 1809. He wrote *Thoughts concerning the Methodists and the Established Clergy* (London, 1795, 8vo):—*Eight Sermons preached in 1786* (Oxf. 1786, 8vo):—*Sermons preached before the University of Oxford* (Birming. 1811, 2 vols. 8vo).—Darling, *Cyclopædia Bibliographica*, s. v.

Crofton, ZACHARY, a learned Nonconformist in the seventeenth century, was born and educated in Dublin. He obtained the living of Wrensbury, Cheshire, but, being a zealous Royalist during the Commonwealth, and refusing the engagement, he was deprived. He afterwards obtained the living of St. Botolph, Aldgate, London. He was ejected for nonconformity in 662, and died in 1672. He published *The Saint's Care for Church Communion* (Lond. 1671, sm. 8vo):—*Worship* (Lond. 1661, 2mo).—Darling, *Cyclopædia Bibliographica*, s. v.

Croisiers, ORDER OF. See CROSS, ORDER OF.

Croly, GEORGE, LL.D., an English divine and writer, was born in Dublin, August, 1780, and educated at Trinity College. After his ordination he went to London, and spent some years as a writer for the newspaper press. In 1835 he was appointed rector of St. Stephen's, Walbrook, and he occupied that parish

with great credit, both as preacher and pastor, up to the day of his death, Nov. 24, 1860. Dr. Croly wrote several extravagant novels and tragedies, among them *Salathiel*, *Marston*, and *Cathline*. His better reputation rests upon his fidelity and power as a preacher, after his appointment to St. Stephen's, and upon his religious writings, the more important of which are, *Divine Providence, or the three Cycles of Revelation* (Lond. 1884, 8vo):—*The Apocalypse: Prophecy of the Rise, Progress, and Fall of the Church of Rome* (3d ed., Lond. 1838, 8vo):—*The Popish Primacy*, 2 sermons (Lond. 1850, 8vo):—*Sermons* (1848, 8vo). He also wrote a *Life of Burke* and a *Life of George IV.*, both reprinted in America.

Crombie, ALEXANDER, LL.D., was born at Aberdeen in 1760, and was educated at Marischal College. He became pastor of a Presbyterian congregation in London, and kept a private school at Highgate, and afterwards at Greenwich, with distinguished success. He died in 1842. His principal works are, *Natural Theology, or Essays on the Existence of the Deity*, etc. (Lond. 1829, 2 vols. 8vo):—*Gymnasium, sive Symbola Critica*, 6th ed. 1884, 2 vols. 8vo; abridged, 1886, 12mo): *A Defence of Philosophical Necessity* (1798, 8vo).—Darling, *Cyclopædia Bibliographica*, s. v.

Cromlech, a huge flat and oblong stone, placed in a sloping position, and supported by pillars of unhewn and perpendicular stones. There were many of them at one time in Ireland, and they are supposed to have been Druidic altars for sacrifice. Their massiveness has defied the ravages of time and revolutions, while the simplicity of their structure bespeaks for them a high antiquity. There is one of them yet in Glansworth, Ireland, which forms a chamber of 25 feet long and 6 feet wide. Mr. Moore (*History of Ireland*) says that remotely they were called in Irish "Bothals, houses of God." The Druids in ancient Ireland had no temples. Instead of them, on a hill, in an oaken grove, and, if possible, near a flowing stream, they enclosed a circle, having a diameter of 70 or 100 feet, and in the centre of it raised the cromlech, around which, on certain days, the people marched; and always in the direction of the sun. See DRUIDS; ALTAR.

Crook-backed (קִרְבָּן, *gibben', gibbous*), a hunch-backed or deformed person (Lev. xxi, 21). See BLEMISH.

Crop (מַרְרָה, *marrah'*, implying full feeding), the *crow* of a bird (Lev. i, 16). See SACRIFICE.

Crosier (or **CROZIER**), properly an archbishop's staff, terminating at the top in a floriated cross, as shown in the subjoined illustration of archbishop Warham's crosier (1520) in the cathedral of Canterbury, England. It is gilt, sometimes even of gold. The term crosier is also applied to the bishop's staff, which is surmounted by a crook or curved circular head. This "pastoral staff," in the Roman Church, is carried before bishops, abbots, and abbesses as an ensign, expressive of their dignity while they are exercising the functions of their office, and the figure of which is also found in their coat of arms. The origin of the crosier is the shepherd's crook, the bishops being regarded as the pastors of their dioceses. By degrees this humble emblem became greatly adorned, and was made of costly materials. Some suppose the crosier to have been originally only a simple staff, which, from the earliest times, was given to judges, kings, etc., as an emblem of authority. St. Isidore says bishops bear the staff because it is their duty to correct the erring and to support the weak.

CROSS (σταυρός; a pointed *stake*, prob. from ἵστημι, to stand upright), in the New Test., signifies properly

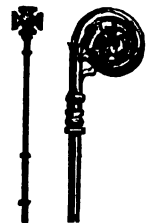

Crosiers.

the instrument of crucifixion; and hence (by metonymy) crucifixion itself, namely, that of Christ (Eph. ii, 16; Heb. xii, 2; 1 Cor. i, 17, 18; Gal. v, 11; vi, 12, 14; Phil. iii, 18). It is also put figuratively (in the phrases "take up [or bear] the cross," etc.) for any severe suffering, including the idea of exposure to contumely and death (Matt. x, 38; xvi, 24; Mark viii, 34; x, 21; Luke ix, 23; xiv, 27). (See below.)

I. *Designations.*—Except the Latin *crux* there was no word definitively and invariably applied to this instrument of punishment. The Greek word *σταυρός* properly, like *σκόλοψ*, means merely a stake (Homer, *Od.* xiv, 11; *Il.* xxiv, 458). So Eustathius and Hesychius both define it. The Greeks use the word to translate both *palm* and *crux*; e. g. *σταυρὸν προσθέν* in Dion. Cass. (xlix, 22) is exactly equivalent to the Latin *ad palmam deligare*. In Livy even *crux* means a mere stake (xxviii, 29), just as *vice versa* the fathers use *σκόλοψ*, and even *stipes*, of a cross proper. In consequence of this vagueness of meaning, impaling (Herod. ix, 76) is sometimes spoken of, loosely, as a kind of crucifixion, and *ἀνασκολοπιζέιν* is nearly equivalent to *ἀνασταυροῦν* (Seneca, *Consol. ad Marc.* xx; and *Ep.* xiv). Other words occasionally applied to the cross are *παύδουλον* and *furca*, pieces of wood in the shape of Π or Y and Δ respectively (*Dig.* 48, tit. 13; Plautus *Mil. Gl.* ii, 47; and Sallust, fr. ap. Non. iv, 355, seems clearly to imply crucifixion). After the abolition of this mode of death by Constantine, Trebonianus substituted *furcā figendos* for *crucifigendos* wherever the word occurred. More generally the cross is called *arbor infelix* (Livy, i, 26; Seneca, *Ep.* 101), or *ignium infelix* (Cicero, *pro Rab.* 8); and in Greek *ξύλον* (Sept. at Deut. xxi, 22) comp. "the accursed tree." The fathers in controversy used to quote the words *ὁ Κύριος Ἰησοῦς ἔσταυρωσεν*, "The Lord reigned" (*ἀπὸ τοῦ ξύλου*), from Ps. xlv, 10, or Ps. xcvi, as a prophecy of the cross; but these words are a gloss (*adulterina et Christianā devotione addita*), though Genebrardus thought them a prophetic addition of the Sept., and Agellius conjectures that they read *ץץ* for *שש* (Schleusner's *Thesaur.*). The Hebrews had no word for a cross more definite than *ץץ*, "wood" (Gen. xl, 19, etc.), and so they called the transverse beams *צבצב*, "warp and woof" (Pearson, *On the Creed*, art. iv), like *ξύλον διδύμου*, of the Sept. *Crux* is the root of *crucio*, and is often used proverbially for what is most painful (as Colum. i, 7; Terence, *Phorm.* iii, 3, 11), and as a nickname for villains (Plautus, *Poen.* ii, 5, 17). Rarer terms are *ἔκρον* (Eusebius, viii, 8), *σάνυς* (?), and *γαβύλα* (Varro ap. Non. ii, 373; Macrinus ap. Capitol. *Maer.* 11). This last word is derived from *ככב*, "to complete."

II. *Forms of the Cross.*—In its simplest shape, consisting of two pieces of wood, one standing erect, the other *crossing* it at right angles, the cross was known at an early age in the history of the world. Its use as an instrument of punishment was probably suggested by the form so often taken by branches of trees, which seem to have been the first crosses that were employed. It was certainly customary to hang animals on trees. Cicero (*Rabiv.* 8) appears to consider hanging on a tree and crucifixion as of the same import, and Seneca (*Ep.* 101) uses similar language. (See above.) Trees are known to have been used as crosses (Tertull. *Ap.* viii, 16), and to every kind of hanging which bore a resemblance to crucifixion, such as that of Prometheus, Andromeda, etc., the name was commonly applied. Among the Scythians, Persians, Carthaginians, Greeks, Romans, and the ancient Germans, traces are found of the cross as an instrument of punishment. The sign of the cross is found as a holy symbol among several ancient nations, who may accordingly be named, in the language of Tertullian, "crucis religiosos," devotees of the cross. Among the Indians and Egyptians the cross often appears in their ceremonies, sometimes in the shape of the letter T, at

others in this shape +. At Susa, Ker Porter saw stones cut with hieroglyphics and cruciform inscriptions, on which in one corner was the figure of a cross, thus, †. The cross, he says, is generally understood to be symbolical of the divinity or eternal life, and certainly a cross was to be seen in the temple of Serapis as the Egyptian emblem of the future life, as may be learned in Sozomen and Rufinus. Porter also states that the Egyptian priests urged its being found on the walls of their temple of Serapis as an argument with the victorious army of Theodosius to save it from destruction. From the numerous writings on this subject by La Croze, Jablonski, Zoega, Visconti, Pococki, Pluche, Petit Radel, and others, the symbol of the cross appears to have been most various in its significations. Sometimes it is the Phallus, sometimes the planet Venus, or the Nilometer, or an emblem of the four elements, or the seasons (Creuzer's *Symbolik.* p. 168-9). It is therefore not surprising that ancient and even modern Christian writers should on this subject have indulged in some degree of refinement and mysticism. Justin Martyr (*Apol.* i, § 72) says, "The sign of the cross is impressed upon the whole of Nature. There is hardly a handicraftsman but uses the figure of it among the implements of his industry. It forms a part of man himself, as may be seen when he raises his hands in prayer." In like manner Minutius Felix (c. 29): "Even Nature itself seems to have formed this figure for us. We have a natural cross on every ship whose sails are spread, in every yoke that man forms, in every outspreading of his arms in prayer. Thus is the cross found both in the arrangements of Nature and among the heathen."

We may tabulate thus the various descriptions of cross (Lipsius, *De Cruce*, i; Godwyn's *Moses and Aaron*, lib. v, cap. ix, and Carpozov's *Annotatus* thereon):

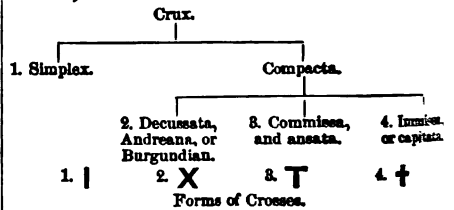

1. The *crux simplex*, or mere stake "of one single piece without transom," was probably the original of the rest. Sometimes it was merely driven through the man's chest, but at other times it was driven horizontally (Hesych. s. v. *σκόλοψ*), coming out at the mouth (Seneca, *Ep.* xiv), a method of punishment called *ἀνασκολοπιζέιν*, or *inflicio*. The *afflicio* consisted merely of *tying* the criminal to the stake (*ad palmam deligare*, Liv. xxvi, 13), from which he hung by his arms: the process is described in the little poem of Ausonius, "*Cypriō crucifictus.*" Trees were naturally convenient for this purpose, and we read of their being applied to such use in the Martyrologies. Tertullian, too, tells us (*Apol.* viii, 16) that the priests of Saturn were thus punished by Tiberius (comp. Tacit. *Germ.* xii).

2. The *crux decussata* is called St. Andrew's cross, although on no good grounds, since, according to some, he was killed with the sword; and Hippolytus says that he was crucified upright on an olive-tree. It is in the shape of the Greek letter X (Jerome, in *Jer.* xxxi; Isidor. *Orig.* i, 8). Hence Justin Martyr (*Dial.* c. *Tryph.* p. 200) quotes Plato's expression (*ἐπέαζεν ἀνδρὸν ἐν τῷ πάντι*) with reference to the cross. The fathers, with their usual luxurious imagination, discover types of this kind of cross in Jacob's blessing of Joseph's sons (*χέρων ἐνλαλαγμένους*; comp. Tert. *de Baptismo*, viii); in the anointing of priests "decussatively" (Sir T. Browne, *Garden of Cyrus*); for the

bis say that priests were distinctively thus anointed (כְּבִישׁוֹן, i. e. *ad formam X Græcorum*, Schöttgen's *r. Hebr. et Talm.* iv, ad f.); and in the crossing of hands over the head of the goat on the day of exaction (Targum *Jonath.* ad Lev. xvi, 21, etc.).

3. The *cruz commissa*, or St. Anthony's cross (so led from being embroidered on that saint's cope; s. Jameson's *Sacred Art*, i, xxxv), was in the shape a T. Hence Lucian (in his *Δίκη φωνηέντων*) jocosely derives *σταυρός* from the letter Ταυ, and makes unkind accuse it bitterly for suggesting to tyrants the instrument of torture (*Jud. Vocal.* 12). This shape is then alluded to as "the mystical Tau" (Tertullian, *tr. Marc.* iii, 22; Jerome, in *Ezech.* ix, etc.). As that letter happens to stand for 800, opportunity was given more elaborate trifling: thus the 800 cubits of the ark are considered typical (Clemens Alexand. *Strom.* ; S. Paulin. *Ep.* ii); and even Abraham's 818 servants (1); since 818 is represented by τηη (Barnabas, p. ix; Clemens Alex. *Strom.* vi; Ambrose, *Profl. in i. de Fide.*; see Pearson, *On the Creed*, art. iv).

A variety of this cross (the *cruz ansata*, "crosses with circles on their heads") is found "in the sculptures from Khorsabad and the Ivories upon Nimrud. M. Lajard (*Observations sur la voix ansée*) refers it to the Assyrian symbol of divinity, the winged figure in a circle; but Egyptian antiquaries quite reject the theory (Lajard's *Nineveh*, ii, 170, note). In the Egyptian sculptures, a similar object, called a *cruz ansata*, is constantly borne by divinities, and is variously called 'the key of the Nile' (Dr. Young in *Encycl. Britan.*), 'the character of Venus,' and more correctly (as by Lacroze) "the emblem of life." Indeed this was the old explanation (Sozomen, *Hist. Eccl.* vi, 15; so, too, Rufinus [ii, 29], who says it was one of the "*εσπαρακτικὰ ἢ sacerdotales litteræ*"). "The Egyptians thereby expressed the powers and motion of the spirit of the world, and the diffusion thereof upon the celestial and elemental nature" (Sir T. Browne, *Garden of Cyrus*). This, too, was the signification given to it by the Christian converts in the army of Theodosius, when they remarked it on the temple of Serapis, according to the story mentioned in Suidas. The same symbol has been also found among the Copts, and (perhaps accidentally) among the Indians and Persians.

4. The *cruz immissa* (or Latin cross) differed from the former by the projection of the upright post (ὄρου ἑψηλον, or *stipes*) above the transverse beam (κίρας ἐγκάρσιον, or *patibulum*, Eusebius, *de V. Constant.* i, 81). That this was the kind of cross on which our Lord died is obvious (among other reasons) from the mention of the "title" (q. v.), as placed above our Lord's head, and from the almost unanimous tradition; it is repeatedly found on the coins and columns of Constantine. Hence ancient and modern imagination has been chiefly tasked to find symbols for this sort of cross, and has been eminently successful. They find it typified, for instance, in the attitude of Moses during the battle of Rephidim (Exod. xvii, 12), saying that he was bidden to take this posture by the Spirit (Barnabas, *Ep.* 12; Justin Mart. *Dial. c. Tryph.* 89; Tertull. *adv. Marc.* iii, 18). Firmicius Maternus (*de Errore*, xxi) says (from the Talmudists?) that Moses made a cross of his rod in order to secure greater success (*ut facilius impetraret quod magnopere postularet, crucem sibi fecit ex virgâ*). He also fantastically applies to the cross expressions in Hab. iii, 8-5; Isa. ix, 6, etc. Other supposed types are Jacob's ladder (Jerome, *Com. in Ps.* xc; Augustine, *Serm. de Temp.* lxxix); the paschal lamb, pierced by transverse spits (Justin Martyr, *Dial. c. Tryph.* xl); and "the Hebrew *Tempha*, or ceremony of their oblations waved by the priest into the four quarters of the world after the form of a cross" (Vitrings, *Obs. Sacr.* ii, 9; Schöttgen, *l. c.*). A truer type (John iii, 14) is the

elevation (Chald. יָרִיבָּי) of the fiery serpent (Num. xxi, 8, 9). For some strange applications of texts to this figure, see *Cypr. Testim.* ii, 20 sq. In *Matt.* v, 18, the phrase "a single jot or tittle" is also made to represent a cross (Theophyl., ad loc., etc.). To the four *ἀκρα* or extremities of the cross they also applied the four dimensions of Eph. iii, 17 (as Gregory Nyss. and Augustine, *Ep.* 120); and another of their fancies was that there was a mystical significance in this four-angled piece of wood (Nonnius, in *Joh.* xix, 18), because it pointed to the four corners of the world (Sedul. iii). In all nature the sacred sign was found to be indispensable (Justin Mart. *Apol.* i, 72), especially in such things as involve dignity, energy, or deliverance; and the actions of digging, ploughing, etc., the human face, the *antenna* of a ship in full sail, etc. (Jerome, in *Marc.* xi; Minutius Fel. *Oct.* xxix). Similar analogies are repeated elsewhere (Firm. *Maten. de Errore*, xxi; Tertull. *adv. Nat.* i, 12; *Apok.* 16; *de Coron.* Mil. iii); and, in answer to the sneers of those to whom the cross was "foolishness," they were considered sufficient proof of the universality of this sign, both in nature and religion. The types adduced from Scripture were valuable to silence the difficulties of the Jews, to whom, in consequence of Deut. xxi, 22, the cross was an especial "stumbling-block" (Tertullian, *adv. Jud.* ix). Many such fancies (e. g. the harmlessness of cruciform flowers, the southern cross, etc.) are collected in *Communications with the Unseen World*.

Besides the four corners (*ἀκρα*, or *apices*, Tert.) of the cross was a fifth (πῆγμα), projecting out of the central stem, on which the body of the sufferer rested (Justin Mart. *Tryph.* xci, who [more suo] compares it to the horn of a rhinoceros; *sedilis excessus*, Tertull. *adv. Nat.* i, 12; Iren. *adv. Hæres.* i, 12). This was to prevent the weight of the body from tearing away the hands, since it was impossible that it "should rest upon nothing but four great wounds" (Jeremy Taylor, *Life of Christ*, iii, xv, 2). This projection is probably alluded to in the famous lines of Mæcenas (ap. Sen. *Ep.* 101). Lipsius, however, thinks otherwise (*De Cruce*, i, 6). Whether there was also a *ὑποπόδιον*, or support to the feet (as we see in pictures), is doubtful. Gregory of Tours mentions it; but he is the earliest authority, and has no weight (Voss, *Harm. Passiom.* ii, 7, 28). See LABARUM.

III. *Accessories of the Cross.*—An inscription, *titulus* or *elogium* (ἐπιγραφή, Luke xxiii; *aitia*, *Matt.* xxvii; ἡ ἐπιγραφή τῆς αἰτίας, Mark; τίτλος, John xix; *Quæ causam poenæ indicavit*, Sueton. *Cal.* 32; *πίναξ*, Euseb.; *γράμματα τὴν αἰτίαν τῆς θανατώσεως ἀγλοῦντα*, Dion Cass. liv. 8; *πυγχιὸν ἐπιγράμμα ἔχον*, Hezych.; Πῆγμα, was generally placed above the person's head, and briefly expressed his guilt (e. g. "ὄντος ἱστυν Ἀγαλλος ὁ Χριστιανός," Euseb. v, 1; "Ἰσπρίε locutus parvularius," Sueton. *Dom.* x), and generally was carried before the criminal (*precedente titulo*, Sueton.). It was covered with white gypsum, and the letters were black; hence Sozomen calls it *λευκωμα* (*Hist. Eccl.* ii, 1), and Nicephorus a *λευκὴ σάνις* (*Hist. Eccl.* viii, 29). But Nicquetus (*Tit. Sanct. Crucis*, i, 6) says it was white, with red letters. (See below.)

It is a question whether binding or absolute pinning to the cross was the more common method. In favor of the first are the expressions *ligare* and *deiligare*; the description in Anonius (*Cupido Crucis?*); the Egyptian custom (Xenoph. *Ephes.* iv, 2); the mention by Pliny (xxviii, 11) of *spartium e cruce* among magical implements; and the allusion to crucifixion noted by the fathers in John xix, 24 (Theophyl. and Tertull.). On the other side we have the expression *προσηλωθεῖσθαι*, and numberless authorities (Senec. *De Vita Beata*, xix; Artemidor. *Oneirocr.*, in several passages; Apul. *Met.* iii, 60; Plantus, *Motel.* ii, 1, 18, et passim). That our Lord was *nailed*, according to prophecy, is certain

(John xx, 25, 27, etc.; Zech. xii, 10; Psa. cxli, 16; comp. Tertull. *adv. Marc.* iii, 19, etc.; Sept. *ῥοξαν*); although the Jews maintain that in the latter text כָּאֵר, "like a lion," is the true reading; Sixt. Senesina, *Bibl. Sanct.* viii, 5, p. 640). It is, however, extremely probable that both methods were used at once (see Lucan, vi, 547 sq.; and Hilary, *De Trin.* x). We may add that in the crucifixion (as it is sometimes called, Tertull. *adv. Marc.* i, 1; comp. Manil. *de Androm.* v) of Prometheus, Æschylus, besides the nails, speaks of a girth (*μασχαλιότης*, *Prom.* 79). When either method was used alone, the tying was considered more painful (as we find in the Martyrologies), since it was a more tedious suffering (*diuturnus cruciatus*).

It is doubtful whether three or four nails were employed. The passage in Plautus (*Mos.* ii, 1, 13) is, as Lipsius (*De Cruce*, ii, 9) shows, indecisive. Nonnus speaks of the two feet (*ἄμφλοκίαι*) being fastened with one nail (*ἀξυγι γόμφω*), and Gregory Naz. (*de Christ. pat.*) calls the cross "three-nailed" (*ἔξλων τρισηλον*); hence on gold and silver crosses the nails were represented by one ruby or carbuncle at each extremity (Mrs. Jameson, l. c.). In the "invention" of the cross, Socrates (*Hist. Ev.* i, 17) only mentions the hand-nails; and that only two were found has been argued from the *τὰ μὲν, τὰ δὲ* (instead of *τοὺς μὲν*) in Theodoret (*Hist. Ev.* i, 17). Romish writers, however, generally follow Gregory of Tours (*de Glor. Mart.* vi) in maintaining four, which may indeed be implied by the plural in Cyprian (*de Passione*), who also mentions three more, used to nail on the title. Cyprian is a very good authority, because he had often been a witness of executions. (See below.)

Besides the copious monograph of Lipsius (*De Cruce*, Antwerp, 1596; Amst. 1670; Brunsw. 1640), there are works by Salmasius (*de Cruce*, Epp. 5); Kippingius (*de Cruce et Cruciaris*, Brem. 1671); Bosius (*de Cruce triumphante et gloriosâ*, Antw. 1617); Gretzer (*de Cruce Christi*); and Bartholinus (*Hypomnemata de Cruce*); very much may also be gleaned from the learned notes of bishop Pearson (*On the Creed*, art. iv).—Kitto, s. v.; Smith, s. v. See CRUCIFIXION.

IV. *The Cross as a Symbol.*—The word cross was early used in Roman literature to represent any torture, pain, or misfortune, or anything causing pain or misfortune. Christ adopted this use of the word when he says (of course before his crucifixion had taken place, or was foreseen by his followers) that they must be willing to take up their cross and follow him (*Matt.* xvi, 24), meaning that they must be willing to endure such sufferings as the service of God may bring. After the death and resurrection of Christ, the cross is spoken of, especially in the epistles of Paul, as the representative of Christ's whole sufferings from his birth to his death (*Eph.* ii, 16; *Heb.* xii, 2), and for the whole doctrines of the Gospel (*1 Cor.* i, 18; *Gal.* vi, 14). The opposers of the Gospel are spoken of as enemies of the cross (*Phil.* iii, 18). As a symbol of Christianity, its doctrines, and its duties, the cross has become a familiar figure of speech in the expression of experimental Christianity, in the preaching of Christian ministers, and in the hymns and songs of Christian poets. Very early in the history of the Church it became the custom for Christians to make the sign of the cross. See CROSS, SIGN OF. That the early Christians had a high regard for the cross is shown by the replies that Tertullian and Octavius made to the pagans who charged Christians with worshipping the cross. It is not easy, however, to fix the date at which Christians commenced to have material representations of the cross. There exist no earlier preserved examples than some rings of stone, with the cross engraved on them, the style of which seems to indicate that they were made before the time of Constantine. The martyr Procopius and a Christian

soldier named Orestes are said to have had crosses attached to their necks before going to their execution. A single example of the *crux composita*, †, is preserved, of the date A.D. 870. On tombs, no cross of any kind is found before the same century. †, *crux immissa*, †, or Greek cross, †, is found earlier than the fifth century. As far as yet examined no cross is found of very early date in the Catacombs, those existing there having been traced by pilgrims centuries later. Such signs of the cross as properly belong to the monogram of Christ (q. v.) date back far their origin to the time of Constantine. Ancient texts have often spoken of this monogram under the name of cross, giving rise to many misunderstandings. In the more distant provinces of the Roman empire, as in Carthage, marbles marked by the *crux immissa* have been found of the fourth century. Zeno of Verona, made bishop in 362, states that he placed a † cross on a basilica which he built. This same cross appears on the coins and medals of the emperor Valentinian I (died 375), and on bronzes struck by Constantine at Aquileia and at Treves, although many consider that these were Egyptian in origin, though adopted by the Christians. Constantine is stated to have placed a cross of gold on the tomb of St. Peter in the Vatican. Our Lord resting on a cross is seen on the tombstone of Probus and Proba (A.D. 355). Paulinus of Nola (died 432) had in his church paintings of crosses surrounded by crowns. Other similar ones are found in old mosaics, as in those of San Vitale of Ravenna (A.D. 547). Over the summit of an arch are two angels holding a crown, in the midst of which is a cross adorned with gems. Some diptychs of the fifth century also contain such crosses. The cross on tombstones was an attribute of a martyr, and on the early sarcophagi is specially used to designate St. Peter, as he died on the cross. After his vision of the cross in the heavens, Constantine (q. v.) changed the standard of the Roman empire to a cross. See LABARUM. From the sixth century the consuls began to have a cross on their sceptres. Valentinian III and his queen Eudoxia were the first (A.D. 445) to wear a cross on their crown. About A.D. 400 the cross called *crux stationalis* was first borne at the head of processions. A number of Christian cities and villages in the neighborhood of Antioch, Aleppo, and Apamea, which were suddenly deserted on the invasion of Syria by the Saracens, and which remain in the form in which they were left by their inhabitants, show how extremely general had become the custom at that time—in the early part of the sixth century—to paint the cross and the monogram of Christ, ✠, over the doors, windows, posts, and on the walls of the houses. It was also used on all domestic objects, as weights, vases, chairs, and all articles of furniture, and was put on ships to keep off disaster and the evil eye. After the fall of the Roman empire, when the labarum ceased to be used, the ensign of many cities became a real cross. The cross-bearer often held two lighted torches, under which were suspended by a chain the letters A and Ω. These *cross-standards* were soon decorated with great magnificence, containing scenes from the Old and New Testament, or busts of sacred or patriotic persons, either painted or sculptured, or adorned with gold and precious stones. This ensign was then borne into the thickest of the battle, being the rallying-point for the army, while a priest on the cart on which the ensign or gonfalone was placed, cheered on the soldiers to fight, or declared absolution to the dying. Many Christian kings on the eve of battle or of any great enterprise, erected a cross, and, bowing before it, offered up prayer to God for success. Oswald had a wooden cross erected before he fought with Cadwallon, his soldiers all kneeling devoutly, while he himself held the cross as the earth was stamped down around it. The stones that formed the cromlechs (q.

were sometimes placed in the form of a cross, it is known whether originally with any significance. It after the introduction of Christianity in England and Ireland these crosses were appropriated as Christian monuments, and like other crosses erected for the purpose, served as marks of the boundary of property, parishes, and sanctuaries; as monuments of battles, murder or other crimes, or disastrous events; to indicate places of public gathering to hear proclamations, sermons, and prayers; to mark the spot where the corpse of any famous person rested on its way to interment, "that passers-by might pray for his soul;" to mark the spot where some person had been delivered from great danger; to line the way to a cemetery or a church; and at cross-roads in the country, or in a market-place, to furnish protection from a passing storm. (Beggars often took their station at these crosses, asking alms in the name of Jesus, giving rise to the expression, "He begs like a cripple at a cross.") Crosses were sometimes erected on the tops of houses, tenants thus claiming the privileges of templars-hospitallers, of being free from the claims of their lords or landlords. Many of these crosses were very costly, and built in the highest architectural taste of the age. Political and religious upheavals have removed many of these crosses; time has destroyed others. Of the 360 crosses formerly existing in the small but historic island of Iona, but one now remains. Of the numerous series by the road leading from Paris to St. Denis, where the kings of France were buried, all are destroyed. Of the fifteen famous crosses that marked the resting-places of the corpse of queen Eleanor (died A.D. 1290), on its removal from Grantham to Westminster, but three now remain. Among the most famous preaching-crosses were those of St. Paul's in London and of Spitalfields, London, where the noted Spital Easter sermons were preached. Crosses are used freely on the vestments of priests, and on all parts of the interior and exterior of Greek, Armenian, and Romish houses of worship, and other ecclesiastical establishments. The Church of England and the Lutheran Church use them to crown their houses of worship; some other Protestant denominations use them thus at the discretion of the individual society; while others still, especially those who hold the views of the original Puritans, reject the use of the visible and material cross in any form or place. Those Christian bodies, that use the cross freely, place it upon the tombs of the dead. The cross we have hitherto spoken of is the passion cross—the representative of Christ's suffering. In the Catacombs, Christ is represented as coming forth from his tomb bearing a cross, the symbol of his triumph over death, and of the ultimate triumph of his doctrines. This triumphal cross, also called Cross of the Resurrection, never bearing Christ upon it as a crucifix, is used as a symbol of the authority and jurisdiction of different officials in certain branches of the Church. See CROSSIER.

V. *The Cross as a Signature*.—As early as the sixth century had it become the custom to put three crosses (‡ ‡ ‡) near the signature of important documents, these having the value of an oath on the part of the signer. Priests never omitted to add it to their signature, and bishops, as a sign of the dignity of their office, placed it before their signature. In diplomatic documents, crosses were used extensively as early as the fifth century. The appropriate use of crosses (*σταυρολογία*) was an important part in diplomatic knowledge. They were sometimes the ordinary cross, ‡, or the St. Andrew's cross, X, the stary cross, ✠, the rhomboid cross, ◆, or of other ornamental forms. They were usually made with black ink. The Byzantine emperors used red ink till they were imitated by other sovereigns, when they adopted the green color. The Anglo-Saxon kings used a golden cross, dispensing with the signature and the seal. Blue and

silver crosses are also met with. The crosses were marked with a stile or pen, or were stamped, or were sometimes made of a thin plate of ivory, bone, or metal. By tradition the cross is now used as a signature, but only by those who cannot write. Crosses were often presented to cloisters by pious visitors, and are preserved in many of their manuscripts. They were used to mark the beginning and end of books, letters, documents, of chapters, paragraphs, references, and critical remarks in books. They are especially used in many countries at the head of letters announcing a death. The cross was early adopted for the ground-plan of churches. In the later Gothic period the apsis was turned out of the line of the axis of the nave to represent the drooping of the head of Christ at his death.

CROSS, CHRIST'S. The question as to "the true cross" upon which our Saviour suffered has been much agitated, especially among Protestants, for the relics shown as such are generally credited among Romanists. (See the controversy revived in modern times by Mr. Williams, in favor of the tradition, *Holy City*, ii, 123; and against it, by Dr. Robinson, *Bibl. Res.* ii, 12 sq.) True, on this subject exact information ought to be accessible, since four ecclesiastical historians (Socrates, i, 18; Sozomen, ii, 1; Rufinus, i, 7; Theodoret, i, 18) concur in stating that the cross was found by Helena, mother of Constantine the Great. This event is assigned to the year of our Lord 326. Eusebius is silent on the discovery. The other writers state that Helena, when seventy-nine years of age, was induced by the warmth of her piety to visit the places which the Saviour had rendered sacred by his presence and sufferings. The hatred of the heathen had led them to obliterate as much as possible all traces of the memorable events which the life and death of Jesus had hallowed, and to cover Mount Calvary with stones and earth, and raise thereon a temple to the goddess Venus. A Jew, however, had treasured up what traditions he could gather, and was thus enabled to point out to Helena the spot where our Lord had been buried. The place being excavated, three crosses were found, and the title which that of Jesus bore was also found lying apart by itself. The question arose how the cross of Christ was to be distinguished from the other two. Macarius, bishop of Jerusalem, suggested that their respective efficacy should be tried as to the working of miracles. Sick persons were brought forward and touched by each separately. One only wrought the desired cures, and was accordingly acknowledged to be the true cross. A full view of all the authorities on this matter may be seen in Tillamont (*Mem. Eccles.* chapter on Helena). Having built a church over the sacred spot, Helena deposited within it the chief part of the real cross. The remainder she conveyed to Constantinople, a part of which Constantine inserted in the head of a statue of himself, and the other part was sent to Rome, and placed in the church of Sta. Croce in Gerusalemme, which was built expressly to receive the precious relic. When, subsequently, a festival to commemorate the discovery had been established, the bishop of Jerusalem, on Easter Sunday, exhibited to the grateful eyes of eager pilgrims the object to see which they had travelled so far and endured so much. Those who were persons of substance were farther gratified by obtaining, at their full price, small pieces of the cross set in gold and gems; and, that wonder might not pass into incredulity, the proper authorities gave the world an assurance that the holy wood possessed the power of self-multiplication, and, notwithstanding the innumerable pieces which had been taken from it for the pleasure and service of the faithful, remained intact and entire as at the first (Paulinus, *Ep. xi ad Sev.*). The capture of Jerusalem by the Persians, A.D. 614, placed the remains of the cross in the hands of Chosroes II, who mockingly conveyed them to his

capital. Fourteen years afterwards Heraclius recovered them, and had them carried first to Constantinople, and then to Jerusalem, in such pomp that, on his arrival before the latter city, he found the gate barred and entrance forbidden. Instructed as to the cause of this hindrance, the emperor laid aside the trappings of his greatness, and, barefooted, bore on his own shoulders the sacred relic up to the gate, which then opened of itself, and allowed him to enter, and thus placed his charge beneath the dome of the sepulchre. See CALVARY. From this time no more is heard in history of the true cross, which the advocates of its genuineness claim may have been destroyed by the Saracens on their conquest of Jerusalem, A.D. 637. Fragments only of it are now exhibited in various parts of Europe. (See below.) The whole story is justly regarded by Protestants as containing unmistakable evidence of being at best a pious fraud on the part of Helena, or a trick on the part of her guides. See HELENA. But, even if the story were not so intrinsically absurd (for, among other reasons, it was a law among the Jews that the cross was to be burned; Othonis, *Lex. Rab. s. v. Supplicium*), it would require far more probable evidence to outweigh the silence of Eusebius. It clearly was to the interest of the Church of Rome to maintain the belief and invent the story of its miraculous multiplication, because the sale of the relics was extremely profitable. To this day the supposed title, or rather fragments of it, are shown to the people once a year in the church of Sta. Croce in Gerusalemme at Rome. On the capture of the true cross by Chosroes II, and its rescue by Heraclius, with even the seals of the case unbroken, and the subsequent sale of a large fragment to Louis IX, see Gibbon, iv, 396; vi, 66. Those sufficiently interested in the annals of such imposture may see farther accounts in Baronius (*Ann. Ecc. A.D. 826, No. 42-50*), Jortin, and Schmidt (*Problem. de Crucis Dominica Inventione*, Helmst. 1724); and on the fate of the true cross, a paper read by Lord Mahon before the Society of Antiquaries, Feb. 1831.

According to Ambrosius (*Oratio de Obitu Theodor. p. 498*), the piece which bore the title stood on the top of the cross of our Lord (John xix, 19-22, *ἐν τοῦ ἔρραυροῦ*; comp. Matt. xxvii, 37; Mark xv, 26; Luke xviii, 18): the form then would be somewhat thus, ☩. This fact would lead to the expectation of more accurate information from those who are said to have found the cross. But the conduct of Helena in dividing the cross, setting aside one part for Jerusalem, another for Constantinople, and another as a phylacterion for her son, and the subdivisions thereof which subsequently took place, rendered it impossible to ascertain in any satisfactory manner not only whether the alleged was the real cross, but also of what wood and in what shape it had been made. This only, then, as to the shape of the Saviour's cross, can be determined, that the prevalent form was that of the *crux capitata*, and that this form is generally found on coins and in the so-called monogram (Münter's *Sinnbilder*, l. iv). The wooden title, however, is said to be still preserved in Rome—not entire, indeed, for only fragments remain of the Hebrew letters, so that they are illegible. The Greek and Latin, except the letter α , are both written after the Eastern manner, from right to left. This is said to have happened either because they were written by a Jew, following a national custom, or from a desire on the part of the writer, if a Roman, to accommodate himself to what was usual among the Jews. Nicetus (*Titulus sanct. Crucis*) holds that it is not all the work of one hand, since the Roman letters are firmly and distinctly cut, but the Greek letters very badly. He thinks that a Jew cut the Hebrew (or Aramean) and Greek, and a Roman the Latin. All that remains of the Greek is $\text{ΝΑΖΑΡΕΝΟΥ} \beta$ [i. e. $\text{ΝΑΖΑΡΗΝΟΥ} \beta$ *βασιλεύς*], of the Latin *Nasarenius Re[Rez]*, i. e. "Nazarene, King." This tablet is said to

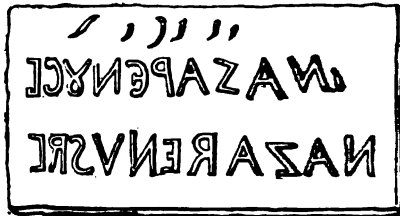

Reputed Tablet of Christ's Cross.

have been sent by Constantine to Rome, and there deposited in a leaden chest, above the vaulted dome of the church of Sta. Croce, in a little window, and then bricked into the wall, its position being recorded by a Mosaic inscription without. Time rendered the inscription almost illegible; and the window, owing to the carelessness of workmen engaged in repairing the church, was accidentally broken open, when the relic was discovered. A bull was issued by pope Alexander III commemorating the discovery and authenticating the title. The whole story is evidently of a piece with the foregoing. Monographs on the subject and relic in question have been written in Latin by Alberti (Lips. 1690; Jen. 1748), Altmann (Bern. 1738), Felter (Lips. 1725), Freiesleben (Lips. 1664), Hank (Jen. 1672), Hiller (Tubing. 1696), Nicoteti (Antw. 1770), Reichmann (Viteb. 1655), Reyper (Kilon. 1694; also in Menthenii *Diss. ii, 241 sq.*), Weselius (L. B. 1712). See TITLE.

Much time and trouble have been wasted in disputing as to whether three or four nails were used in fastening the Lord to his cross. (See above.) Nennius affirms that three only were used, in which he is followed by Gregory Nazianzen. The more general belief gives four nails, an opinion which is supported at much length and by curious arguments by Carinus (*De Clavis Dominica*). Others have carried the number of nails as high as fourteen. Of the four original nails, the empress Helena is reported (Theodoret, *Hist. Eccl. i, 17*) to have thrown one into the Adriatic when furiously raging, thereby producing an instant calm. The second is said to have been put by Constantine into either his helmet or crown, or (as Zonaras says) on the head of the statue which he intended to be the palladium of Constantinople, and which the people used to surround with lighted torches (Mosheim, *Eccl. Hist. ii, 1, 3, and notes*). This nail, however, was afterwards to be found in a mutilated state in the church of Sta. Croce. In the Duomo of Milan is a third nail, which Eutropius affirms was driven through one of Jesus's hands, and which Constantine used as a bit, intending thereby to verify the prophecy of Zechariah (xiv, 20): "In that day shall be upon the bells (margin, *bridles*) of the horses, *Holiness unto the Lord.*" Treves possesses the fourth nail, which is alleged to have been driven through the sufferer's right foot (Lipsius, *De Cruce*, ii, 9). Those who maintain the number of nails to have been more than four have had no difficulty in finding as many nails as their hypothesis in each case needed, and as many sacred places for their safe keeping. There are monographs on this subject, in Latin, by Fontanus (Amst. 1648), Frischmuth (Jen. 1663), Semler (Dress. 1741), Winer (Lips. 1845), Curtius (Monaci, 1622; Antw. 1670; also in the *Symb. lit. Brem. iii, 309*); in German, by Bähr (in Heydenreich's *Zeitschr. ii, 309*), Paulus (*Memorabil. iv, 86-64*). See NAIL.

Another dispute has been agitated relative to the existence of a *hypopodium* or tablet whereon the feet were supported. Gregory of Tours, who had seen the alleged true cross, affirms that it had such a footstool; but his dictum has been called in question. It is, however, doubted whether the hands alone, without a prop beneath, could sustain the weight of the body,

and some have supposed that a kind of seat was placed, in which the sufferer may be said to have in some way sat. The controversy is treated at length in the first of the four *Hypomnemata de Cruce* of Bartholinus Hafn. 1661, Amst. 1670, L. B. 1696).

A common tradition assigns the perpetual shiver of the aspen to the fact of the cross having been formed of its wood. Lipsius, however (*De Cruce*, iii, 18), thinks it was of oak, which was strong enough, and common in Judæa. Few will attach any consequence to his other reason, that the relics appear to be of oak. The legend to which he alludes,

“*Pes crucis est cedrus, corpus tenet alta cupressus,
Palma manus retinet, titulo letatur oliva*”

(The foot is cedar, cypress forms the shaft,
The arms are palm, the title olive bears),

hardly needs refutation. It must not be overlooked that crosses must have been of the meanest and readiest materials, because they were used, in such marvellous numbers. Thus we are told that Alexander Jannæus crucified 800 Jews (Josephus, *Ant.* xiii, 14, 2), and Varus 2000 (*ib.* xvii, 10, 10), and Hadrian 500 a day; and Titus so many that “room failed for the crosses, and crosses for the bodies” (Josephus, *War*, vi, 28, where Reland rightly notices the strange retribution, “so that they who had nothing but ‘crucify’ in their mouth were therewith paid home in their own bodies.” Sir T. Browne, *Vulg. Err.* v, 21). In Sicily, Augustus crucified 600 (Orosius, vi, 18).—Kitto, s. v.; Smith, s. v. See CRUCIFIXION.

CROSS, BULL OF THE (*Crusada*), a bull by which pope Calixtus III, in 1487, granted very extensive indulgences to all who would take up arms, under king Henry of Castile, against the infidels, or pay to that king a certain sum for defraying the expenses of the war. The indulgence was at first granted for only five years, but was from time to time renewed and enlarged, so as to include many privileges, such as exemption from the commandment of abstinence. The proceeds of the Bull of the Cross constituted a considerable portion of the public revenue. The last renewal of the bull is of the year 1758. A similar bull was issued in 1514 by pope Leo, in favor of king Sebastian of Portugal, to whom, in consideration of his endeavors for the conversion of infidels in Africa, the third part of the tithes and the tenth part of the taxes due to the churches and ecclesiastical benefices of the kingdom was conceded.—Wetzer u. Welte, *Kirchen-Lex.* vi, 265.

CROSS, EXALTATION OF THE, a festival in the Roman Catholic Church, instituted in commemoration of the exaltation of the supposed cross of Christ at Jerusalem, after its recovery from the Persians. The latter, when conquering Jerusalem in 614, carried off with them the relic which, since its “invention” [see **CROSS, CHRIST’S**] by the empress Helena, had been venerated as the “Holy Cross.” With a view to a heavy sum of ransom, they had it sealed up by the patriarch Zacharias with the patriarchal seal, and took it to a strong castle in Armenia. When, in 627, the emperor Heraclius conquered the Persians, he stipulated in the treaty of peace for the restoration of the Holy Cross, and took it with him to Constantinople. From there, in 629 (according to others in 630), he took it himself, accompanied by a large retinue, to Jerusalem, where it was again set up with great solemnities. It is this restoration of the cross to Jerusalem which is annually commemorated on Sept. 14 in the Church of Rome as the Exaltation of the Cross.—Wetzer u. Welte, *Kirchen-Lex.* vi, 268.

CROSS, INVENTION OF THE, the name given in the Roman Catholic Church to a festival which commemorates the finding of the alleged true cross of our Saviour, and which is celebrated on the 3d of May. An order of friars, founded in honor of the invention of the cross, and carrying in their hand a staff, on the top of which was a cross, received the name of *Croisiers*

(Fr. *croix*, cross), corrupted into *Crouched* or *Crutched* Friars. They came to England in the 18th century, and had monasteries in London, Oxford, and Ryegate. The festival of the Elevation of the Cross (September 14) commemorates its re-erection in Jerusalem by the emperor Heraclius, after it had been carried away by the Persians.—Chambers, *Encyclopædia*, s. v. See **CROSS, EXALTATION OF**.

CROSS, METAPHORICAL SENSE OF. This word (1), in its most comprehensive sense, as figuratively used in N. T., designates not only the whole passion of Christ, culminating in the death on the cross, but also the whole Gospel system, as a means of reconciliation with God through Christ. (2) It is also used to designate the sufferings and trials sent upon Christians for their moral improvement, and which have the effect of strengthening faith, and teaching humility, love, and submission. The command to “take up the cross” daily (Luke ix, 23) signifies that we are cheerfully to submit to all the evils of life, circumstance, and position, which God, in his wisdom, sees fit that we should encounter; we are even to rejoice at misfortune, as the discipline of suffering brings fruits of sanctification to those who patiently submit for Christ’s sake, remembering that all things work for good to them that love God (Rom. viii, 28). Four kinds of “crosses” have been recognised: 1, the cross of martyrdom, the witness unto death for Christ and the Gospel; 2, the cross of trials, for the preservation of faith, love, and hope; 3, the cross of discipline, for the purification of the heart and the subjection of sinful desires and inclinations; 4, the cross of punishment, for the chastisement of sin; though the aim of punishment also is the improvement of the sinner. God is love, and therefore lays the “cross” on every one as he needs it. He chasteneth whom he loveth. It is a sad mistake to consider suffering as the result of caprice or anger on the part of God (2 Cor. iv, 16-18; xii, 7; Heb. xii, 1-12; Gal. vi, 14; Eph. ii, 16, 17; Col. i, 19-22; 1 Cor. i, 17, 18; Gal. v, 11; Phil. iii, 18).—Krehl, *N. T. Handwörterbuch*, s. v. Kreuz.

CROSS, ORDERS OF THE, in the Roman Church. 1. *Canons Regular of the Congregation of the Holy Cross*, founded in 1211 by Theodore de Celles, a descendant of the dukes of Bretagne. It was confirmed by Innocent IV in 1248, and was exempted from the jurisdiction of the bishops by John XXII in 1318. The order spread especially in the Netherlands, Western Germany, and France, and still exists in the Netherlands and Belgium, whence in 1850 a colony was sent over to the United States, where they have an establishment in the diocese of Milwaukee. See Helyot, who calls them *Croisiers* or *Porte-Croix*; *American Catholic Almanac*. 2. *Croisiers (Cross-bearers) of Italy*, an



Cross-bearer in Italy.



Cross-bearer with the Star in Bohemia.

other congregation of the same order, the origin of which is unknown, but which was renewed by pope Alexander III in 1169, and is now extinct. 8. *Daughters of Bohemia*, see КНИГТЪ, ТЕРТОРИЯ. 4. *Daughters of the Cross*, founded by Madame de Villeneuve, in



Daughter of the Cross.



Cross-bearer in France and the Netherlands.

France, in 1640, under the direction of Vincent de Paul, and confirmed by pope Clement IX. They devote themselves principally to the instruction of girls, and have their principal establishment, with more than 100 members, at Paris. The order is rapidly increasing in France, and has one establishment in the United States, in the diocese of Natchitoches, founded in 1854.—Fehr, *Geschichte der Mönchsorden*, ii, 819. 5. Another congregation of *Daughters of the Cross* was founded in 1835 at Liege, by Habets, a Belgian priest. They teach, keep asylums for fallen women, etc., and have established several houses in Belgium and Germany.—Fehr, *Geschichte der Mönchsorden*, ii, 322. 6. *Sisters of the Cross*, also called "Sisters of St. Andrew," founded in 1806 by Mademoiselle Bechier, in the diocese of Poitiers. They devote themselves to the instruction of children, and to the nursing of the sick in the country. They are very numerous in France. 7. Another congregation of *Sisters of the Cross*, also called "Sisters of the Immaculate Heart of Mary," was founded by Abbé Moreau, at Mans, about 1834, and approved by the pope in 1857. They came to the United States in 1843, and have establishments in the dioceses of Fort Wayne, Philadelphia, and Chicago. 8. A *Congregation of Regular Clerks of the Holy Cross* was founded in 1835, together with the congregation mentioned under No. 7, by Abbé Moreau. It was afterwards united with the "Brothers of St. Joseph," founded about the same time by Very Rev. Mr. Dujarrier, and the rule of the united congregations was approved by Pius IX in 1857. They had, in 1867, 82 houses and missions, of which 58 were in France, 12 in America, 7 in Bengal, 2 in Algeria, and 1 each in Rome, Poland, and Austria.

CROSS, SIGN OF THE, a rite in the Roman Church, and in the Greek and other Eastern churches. It is used by officiating priests as a form of blessing at all liturgical actions and consecrations, and by all the members of the Church at the beginning of a prayer during divine service, on entering a church, on passing the host, and on many other occasions. It is always made with the right hand. In the 6th century it became customary to make the sign of the cross with the thumb on forehead, mouth, and chest. Since the 8th century the so-called "large" or "Latin" cross has been in common use among the laity. It is made with the palm of the hand by touching first the forehead; next, in direct line downward, the chest; next,

in horizontal line, the left and the right shoulder. The same form of cross is used in liturgical actions, if the cross is to be made over the object to be blessed without touching it. While among the Latins the cross beam is drawn from the left to the right, the reverse is the case among the Greeks and Russians. In making the sign of the cross, it is common to pronounce the words, "In the name of the Father, and the Son, and the Holy Ghost. Amen." Formerly there were also other forms in common use (Binterim enumerates eight), but all have been displaced by the above. The different ways of making the sign of the cross, and the number of fingers used, have called forth in the Church of Rome the most fanciful and mystical significations, and a special power has commonly been attributed to the sign of the cross. It is, therefore, also made over water, salt, oil, etc. In the Greek Church the sign of the cross is of even more frequent use than in the Roman Catholic. Among the Protestants it is almost universally abandoned (in the Lutheran Church of Saxony it was in use until the introduction of a new liturgy in 1812). In the Church of England and in the Protestant Episcopal Church its use in baptism is optional.

CROSS, WAY OF THE (*Via Crucis*), the collective name of a certain number of pictures or stations in or near Roman Catholic churches and sanctuaries, to represent an equal number of events in the history of the Passion of the Saviour. Generally the number of the pictures is 14 or 15, but sometimes less. The people who "walk the way of the cross" stop a little while at each picture, reciting a prayer, until they have in turn, visited every station, and thus completed the commemoration of the Passion. In some Roman Catholic countries, as in Southern Germany, the "Way of the Cross" can be met with in almost every church. This practice was invented by the Franciscan monks, who offered it to the people as a substitute for the pilgrimage to the Holy Land, and justly calculated that, by obtaining numerous indulgences from the popes for those who would adopt this peculiar kind of worship, they would achieve a great popularity for the church of their order. Their expectation was realized. The popes granted to the visitors of the "Way of the Cross" all the indulgences which had formerly been granted to the visitors of different places in the Holy Land, thus enabling the people to gain in a few minutes several "plenary" indulgences, besides a number of partial. Every "Way of the Cross" must be instituted by a Franciscan monk, and it requires a special permission from the pope if any one who is not a Franciscan is to introduce it. Many special books of devotion have been published for the *Via Crucis*.

Cross-bearer (*cruciger*). 1. In the Romish Church, the designation of the chaplain of an archbishop, or a primate, who bears a cross before him on solemn occasions. The pope has the cross borne before him everywhere; a patriarch anywhere out of Rome; and primates, metropolitans, and those who have a right to the pallium, throughout their respective jurisdictions. A prelate wears a single cross, a patriarch a double cross, and the pope a triple cross on his arms.

2. The name *cross-bearers* ("cruciferi") was also applied to the *Flagellants* in the thirteenth and fourteenth centuries. See FLAGELLANTS.

Croswell, Henry, D.D., a Protestant Episcopal minister, was born in West Hartford, Conn., June 16, 1778. While quite young he entered his brother's printing-office in Catskill, N. Y., and soon became editor of a newspaper published in that place. About 1800 he established a paper at Hudson, N. Y., called *The Balance*. He removed to Albany in 1809, where his paper attained a still wider circulation and influence. Finally he turned his attention to the Christian ministry. Though brought up among Congrega-

ionalists, he determined to unite with the Protestant Episcopal Church, and prepared to enter its ministry. In the year 1814 he was ordained deacon. After reaching a short time in Hudson, he removed to New Haven, when he took charge of Trinity Church, and in February, 1816, he was ordained priest. He remained in the same parish 48 years. It is stated that in a period of 41 years he officiated at 1844 burials, administered 2558 baptisms, and married 883 couples. He died March 18, 1858.

Croswell, William, D.D. (son of Henry), was born in Hudson, N. Y., Nov. 7, 1804, and graduated at Yale College in 1822. After studying at the General Theol. Seminary, N. Y., he was ordained in 1828, and in May, 1829, he accepted the rectorship of Christ Church, Boston. In 1840 he became rector of St. Peter's Church, Auburn, N. Y., but, after somewhat more than four years, he returned to Boston, and connected himself with a new enterprise—the Church of the Advent, which proved very successful. With this church he continued till the close of his life. In 1846 the degree of D.D. was conferred upon him by Trinity College, Hartford, and on Nov. 9, 1851, he died suddenly, after the partial delivery of a beautiful sermon, addressed to the children of his church, in connection with a baptism. His productions, especially on poetry, were published soon after his death by his father, in an extended *Memoir*, but he had strictly forbidden the publication of any of his sermons.—*Sprague, Annals*, v, 697.

Crothers, SAMUEL, D.D., a Presbyterian minister, was born near Chambersburg, Pa., October 22, 1783. His father removed to Lexington, Ky., in 1787. In February, 1798, he entered the Lexington Academy, and in 1804 placed himself under the care of the Kentucky Presbytery as a candidate for the ministry. He entered the New York Theological Seminary in 1806, and, returning to Kentucky in 1809, was there licensed to preach. He settled in Chillicothe in 1810, where he remained for three years, removing to Greenfield in 1818. At this time the Associate Reformed Church was greatly agitated with controversies respecting intercommunion and psalmody. With Dr. Mason and most of his students, Mr. Crothers opposed close communion, and the exclusive use of what has been called inspired psalmody. Troubles growing out of these things, he resigned his charge, and removed to Winchester, Ky. In 1820 he returned to Greenfield, where he remained 36 years. He died suddenly in Oswego, Ill., at the house of his son, on July 20, 1856.—*Wilson, Presbyterian Hist. Almanac*, 1864.

Crow (καρῶν), Baruch vi, 54, prob. the *jackdaw*. See RAVEN.



Oriental Jackdaw.

Crowell, Joshua, an early Methodist Episcopal minister in New England, was born in Massachusetts

in 1777, of Presbyterian parents, was converted through the agency of Methodist preaching at about 20, entered the itinerancy in 1801, located in 1809, and died at Sturbridge, Mass., July, 1858, in the fifty-seventh year of his ministry. He had a strong intellect, sound judgment, generous emotions, and an earnest love of Methodism. He was an able and successful minister. He was one of the founders of the Wesleyan Academy, Wilbraham, and in many ways was of eminent service to the Church.—*Sherman, Sketches of New-England Divines*, p. 889.

Crowell, Seth, a Methodist Episcopal minister of more than ordinary talents, was born in Tolland, Conn., in 1781, entered the New York Conference in 1801, was returned superannuated in 1813, re-entered upon work as a missionary in 1816, located in 1819, and was readmitted as superannuated in 1824. He died in 1826 in New York city.—*Minutes*, i, 542; *Stevens, Memorials of Methodism*, ii, ch. xviii.

Crowing. See COCK-CROWING.

Crowther, JONATHAN, an English Methodist minister, was born in Cornwall, July 31, 1794, and was educated at Kingswood School. He began to preach in 1814, was appointed head-master at Kingswood 1823, and afterwards at Woodhouse-Grove. He afterwards served several circuits, until he was called in 1837 to the superintendency of Wesleyan missions in India. His labors in that country brought great and lasting good to the missions, especially in Madras. In 1848 he returned to England, and in 1849 was appointed classical tutor at the Wesleyan Theological School, Didbury, where he remained until his death, Jan. 11, 1856.—*Wesleyan Minutes*, 1856, p. 21.

Crown, an ornament often mentioned in Scripture, and in such a manner as in most cases to indicate the circumstances under which and the persons by whom it was worn; for crowns were less exclusively worn by sovereigns than among modern nations. Perhaps it would be better to say that the term "crowns" was applied to other ornaments for the head than those exclusively worn by royal personages, and to which modern usage would give such distinctive names as coronet, band, mitre, tiara, garland, etc. This ornament, which is both ancient and universal, probably originated from the fillets used to prevent the hair from being dishevelled by the wind. Such fillets are still common, and they may be seen on the sculptures of Persepolis, Nineveh, and Egypt; they gradually developed into turbans (*Josephus, Ant.* iii, 7, 7), which, by the addition of ornamental or precious materials, assumed the dignity of mitres or crowns. The use of them as ornaments was probably suggested by the natural custom of encircling the head with flowers in token of joy and triumph ("Let us crown ourselves with rosebuds," *Wisd.* ii, 8; *3 Macc.* vii, 16; *Jud.* xv, 18, and the classical writers, *passim*). See WREATH. The first crown was said to have been woven for Pandora by the Graces (comp. *στέφανος Χαρίτων*, *Prov.* iv, 9). According to Pherecydes, Saturn was the first to wear a crown; Diodorus says that Jupiter was first crowned by the gods after the conquest of the Titans. Pliny, Harpocration, etc., ascribe its earliest use to Bacchus, who gave to Ariadne a crown of gold and Indian gems, and assumed the laurel after his conquest of India. *Leo Ægyptius* attributes the invention to Isis, whose wreath was cereal. These and other legends are collected by Tertullian from the elaborate treatise on crowns by Claud. Saturninus. Another tradition says that Nimrod was the first to wear a crown, the shape of which was suggested to him by a cloud (*Euty chius Alexandr. Ann.* i, p. 68). Tertullian, in his tract *De Cor. Militis* (c. vii sq.), argues against them as unnatural and idolatrous. He is, however, singularly unsuccessful in trying to disprove the countenance given to them in Scripture,

where they are constantly mentioned. See BOX-
NET.

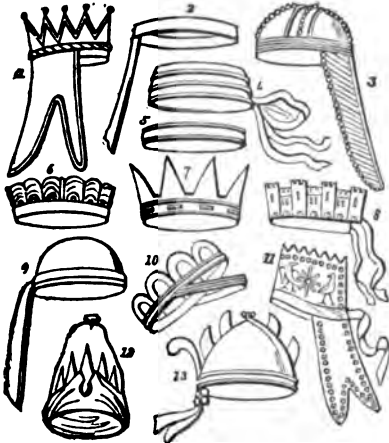

Ancient Asiatic Crowns.

I. Fig. 5. Simple *Allat*; 2, with shoulder-piece; 4, with band and ribbon; 10, with throat-latch and edging.

II. 12. Simple *cap*; 9, with pendant; 13, with crest and ribbon; 8, with bosses and shoulder-pieces.

III. 6. Simple *crown* proper; 7, with serrated edge; 8, and ribbon; 1, or *cape*; 11, with both.

1. The word מִצְרֵת , *me'ser* (lit. *consecration*; hence *consecrated hair*, as of a Nazarite, and then generally *long hair*), is supposed to denote a *diadem* (Greek *διάδημα*, Rev. xii, 8; xiii, 1; xix, 12). It is applied to the inscribed plate of gold in front of the high-priest's mitre, which was tied behind by a ribbon (Exod. xxix, 6; xxxix, 30), and which was doubtless something of the same kind that we see in figs. 8, 11. This word is also employed to denote the diadem which Saul wore in battle, and which was brought to David (2 Sam. i, 10), and also that which was used at the coronation of the young Joash (2 Kings xi, 12); and, as another word is applied elsewhere to the crown used in this ceremonial, the probability is that the Hebrew kings wore sometimes a diadem and sometimes a crown, and that the diadem only was accessible to the high-priest, by whom Joash was crowned, the crown itself being most likely in the possession of Athaliah. Both the ordinary priests and the high-priest wore head-dresses of this ornamental description. The common mitre (מִצְרֵת , Sept. *κίθαρις*, Exod. xxviii, 37; xxix, 6, etc.; Josephus, *τανία*; Hesych. *στροφίον ὃ οἱ ἱερεῖς φοροῦσι*) was a flat cap (*πίλος ἀκνός*), forming a sort of linen *tania* or crown (*στεφάνη*), Josephus, *Ant.* iii, 7. The ceremonial mitre (מִצְרֵת , Sept. *βυσσίνη γιάρα*) of the high-priest (used also of a regal crown, Ezek. xxi, 26) was much more splendid (Exod. xxviii, 36; Lev. viii, 9; "an ornament of honor, a costly work, the desire of the eyes," *Ecclus.* xlv, 12; "the *holy crown*," Lev. viii, 9, so called from the Tetragrammaton inscribed on it, *Sopranes, De re Vest. Jud.*, p. 441). It had a second fillet of blue lace (*ἐξ ὑάκινθου πεποικιλμένος*, the color being chosen as a type of heaven), and over it a golden diadem (מִצְרֵת , Exod. xxix, 6), "on which blossomed a golden calyx like the flower of the *δοσκάμωσ*," or hyoscyamus (Josephus, *Ant.* iii, 6). The gold band (רִבְבֵן , Sept. *πίραλον*; Origen, *ἰασητήριον*) was tied behind with blue lace (embroidered with flowers), and being two fingers broad, bore the inscription (not in bas-relief, as Abarbanel says) "Holiness to the Lord." (Comp. Rev. xvii, 5; Braunius, *De Vest. Sacerd.* ii, 22; Maimon. *De Apparatu Temp.* ix, 1; Roland, *Antiq.* ii, 10; Carpoz, *Appar. Cris.* p. 85; Josephus, *War.* v, 5, 7; Philo, *De Vit. Mosia*, iii, 519.) Some suppose that Josephus is describing a later crown given

by Alexander the Great to Jaddua (Jennings's *Jews' Ant.* p. 158). The use of the crown by priests and in religious services was universal, and perhaps the badge belonged at first "rather to the *pontificalia* than the *regalia*." Thus Q. Fabius Pictor says that the first crown was used by Janus *when sacrificing*. "A striped head-dress and queue," or "a short wig, on which a band was fastened, ornamented with an asp, the symbol of royalty," was used by the kings of Egypt in religious ceremonies (Wilkinson's *Anc. Egypt.* iii, 34, fig. 13). The crown worn by the kings of Assyria was "a high mitre . . . frequently adorned with feathers, etc., and arranged in bands of linen or silk. Originally there was only one band, but afterwards there were two, and the ornaments were richer" (Layard, i, 320, and the illustrations in Jahn, *Arch. Germ.* ed., p. i, vol. ii, tab. ix, 4 and 8). See MIRKE.



Ancient Assyrian Crowns.
Fig. 1, Early Kings; 2, Later.

The royal crown originated in the diadem, which was a simple *fillet* fastened round the head, and tied behind. This obviously took its rise among a people who wore long hair, and used a band to prevent it from falling over the face. The idea occurred of distinguishing kings by a fillet of different color from that usually worn; and being thus established as a regal distinction, it continued to be used as such even among nations who did not wear the hair long, or was employed to confine the head-dress. We sometimes see this diadem as a simple fillet, about two inches broad, fastened round the otherwise bare head; we then find it as a band of gold (first cut, above, fig. 2, 5). In this shape it sometimes forms the basis of raised ornamental work (figs. 6, 7, 8, 10), in which case it becomes what we should consider a crown; and, indeed, the original diadem may be traced in most ancient crowns. Fig. 10 is curious, not only from the simplicity of its form, but on account of the metallic loop to be passed under the chin—a mode of securing the crown probably adopted in war or in the chase. Then we find the diadem surrounding the head-dress

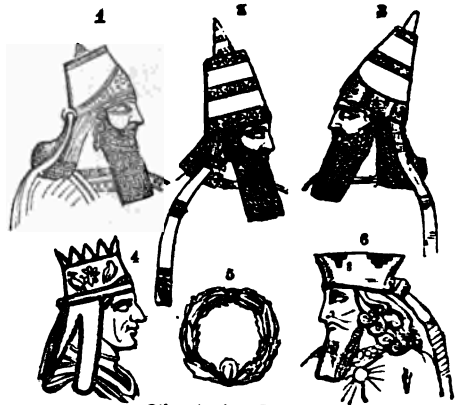

Other Ancient Crowns.

Fig. 1, Of Nineveh; 2, Sardianapolis III; 3, Sennacherib; 4, Tigranes; 5, Roman Clivis; 6, Persopolitans.

cap (figs. 3, 9, 18), and when this also is ornamented, the diadem may be considered as having become a crown. See **DIADEM**.

2. The more general word for a crown is **קִרְטָן**, *ata-ak'* (a circlet, Gr. *σφίρανος*); and it is applied to crowns and head ornaments of different sorts, including those used by the kings. When applied to their crowns, it appears to denote the state crown as distinguished from the diadem. Such was probably the crown, which, with its precious stones, weighed (or rather "was worth") a talent, taken by David from the king of Ammon at Rabbah, and used as the state crown of Judah (2 Sam. xii, 30). Some groundlessly suppose that, being too heavy to wear, it was suspended over his head. The royal crown was sometimes buried with the king (Schickard, *Jus Reg.* vi, 19, p. 21). Idolatrous nations also "made crowns for the head of their gods" (Ep. Jer. 9). The Rabbins allege that the Hebrew state-crown was of gold, set with jewels. Of its shape it is impossible to form any notion, unless by reference to the examples of ancient crowns contained in the preceding cut. These figures, however, being taken mostly from coins, are not of that very remote antiquity which we would desire to illustrate matters pertaining to the period of the Hebrew monarchies. In Egypt and Persia there are sculptures of earlier date, representing royal crowns in the shape of a distinguishing tiara, cap, or helmet, of metal, and of cloth, or partly cloth and partly metal.

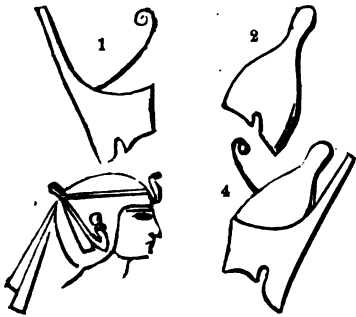

Ancient Egyptian Crowns.

Fig. 1, Lower Egypt; 2, Upper Egypt; 3, both kingdoms united; 4, Royal Fillet.

The diadem of two or three fillets (figs. 4, 5, first cut, above) may have been similarly significant of dominion over two or three countries. In Rev. xii, 8; xiii, 1; xix, 12, allusion is made to "many crowns" (*διαδημαρα*) worn in token of extended dominion. Thus the kings of Egypt used to be crowned with the "pehent," or united crowns of Upper and Lower Egypt (Wilkinson, *Anc. Egypt.* iii, 351 sq.; comp. Layard, ii, 320); and Ptolemy Philometor wore two diadems, one for Europe and one for Asia. This would, in fact, form three crowns, as his previous one was doubtless the double crown of Upper and Lower Egypt. Similarly the three crowns of the papal tiara mark various accessions of power: the first corona was added to the mitre by Alexander III in 1159; the second by Boniface VIII in 1303; and the third by Urban V in 1362. These Egyptian tiaras were worn in war and on occasions of state, but on ordinary occasions a fillet or diadem was used. It is important to observe that the *mitre* of the high-priest, which is also called a crown (Exod. xxxix, 30), was of similar construction, if not shape, with the addition of the golden fillet or diadem.

3. Similar also in construction and material, though not in form, was the ancient Persian crown, for which there is a distinct name in the book of Esther (i, 11; ii, 17; vi, 8), viz., **כִּתְרוֹן**, *ke'ther* (*chaplet*), which was doubtless the *cidaris* or *citaris* (*κίθαρις* or *κίραρις*), the high cap or tiara so often mentioned by the Greek his-

torians. From the descriptions given of it, this seems to have been a somewhat conical cap, surrounded by a wreath or fold; and this would suggest a resemblance to fig. 12 (of the first cut, above), which is, in fact, copied from a Parthian or later Persian coin. This one is worthy of very particular attention, because it forms a connecting link between the ancient and modern Oriental crowns, the latter consisting either of a cap, with a fold or turban, variously enriched with aigrettes,



Modern Oriental Crowns.

as this is; or of a stiff cap of cloth, studded with precious stones. It must often occur to the student of Biblical antiquities that the modern usages of the East have more resemblance to the most ancient than have those which prevailed during that intermediate or classical period in which its peculiar manners and institutions were subject to much extraneous influence from the domination of the Greeks and Romans. So, in the present instance, we are much impressed with the conviction that such head-tires and caps as those represented in the above cut more correctly represent the regal "crowns" of the Old Testament than those figured in the first cut, above (with the exception of fig. 12 and the simple diadems); which, however, may be taken to represent the style of the crowns which prevailed in and before the time of the New Testament. See **TURBAN**.

4. Other Heb. terms rendered "crown" are **זֶר**, *zer*, a wreath or border of gold around the edge of the ark of the covenant (Exod. xxv, 11, etc.); and **קִרְטָן**, *kedkôd'*, the scalp or crown of the human head (Gen. xlix, 26, etc.; *κορυφή*, Bel, 86). There are several words in Scripture for a crown (but not so rendered) besides those mentioned, as **פֶּסַר**, *pe'sar'*, the head-dress of bridegrooms (Isa. lxi, 10; Bar. v, 2; Ezek. xxiv, 17), and of women (Isa. iii, 20); **צִפְרֵי הַיָּהוָה**, *tsaph-iroth'*, a head-dress of great splendor (Isa. xxviii, 5); **לְבוּשׁ הַיָּהוָה**, *li'vyah'*, a wreath of flowers (Prov. i, 9; iv, 9); such wreaths were used on festal occasions (Isa. xxviii, 1); **מִצְרֵי**, *tsamph'*, a common tiara or turban (Job xxix, 14; Isa. iii, 28); **כִּרְבֵּלָה**, *karbela'* ("hat," Dan. iii, 21, rather mantle). **Σρίμμα** occurs in the N. T. only once (Acts xiv, 18) for the garlands used with victims. In the Byzantine court this word was

confined to the *imperial crown* (Du Fresne, *Gloss. Græc.* p. 1442). See GARLAND.

The Jews boast that three crowns were given to them: *קִרְיָת הַלֵּוִי*, the crown of the law; *קִרְיָת הַכֹּהֲנִים*, the crown of priesthood; and *קִרְיָת הַמְּלָכִים*, the royal crown; better than all which is *שֵׁם טוֹב*, the crown of a good name (Carpsov, *Apparat. Critic.* p. 60; Othonis *Lex. Rabb.* s. v. Corona). Crowns were so often used symbolically to express honor and power that it is not always safe to infer national usages from the passages in which they occur. Hence we would scarcely conclude from Ezek. xxiii, 42 that crowns were worn by Jewish females, although that they wore some ornament which might be so called is probable from other sources. Mr. Lane (*Arabian Nights*, i, 424) mentions that until about two centuries ago a kind of crown was worn by Arabian females of wealth and distinction. It was generally a circle of jewelled gold (the lower edge of which was straight, and the upper fancifully heightened to a mere point), surmounting the lower part of a dome-shaped cap, with a jewel or some other ornament at the summit. It is certain that "crowns" of this or some similar kind were worn at marriages (Cant. iii, 11; Isa. lxi, 10); and it would appear that at feasts and public festivals "crowns of rejoicing" were customary. These were probably garlands (Wisd. ii, 8; iv, 2; Ecclus. i, 11).

With the ancients generally the crown was the symbol of victory and reward, it being customary for conquerors to be crowned, as were also victors in the Grecian games. From ancient coins and medals we may observe that these crowns or wreaths usually consisted of leaves of trees, to which were added flowers. The crown worn by the victor in the Olympian games was made of the wild olive; in the Pythian games, of laurel; in the Nemean games, of parsley; and in the Isthmian games [see CORINTH], of the pine. Indeed, Claudius Saturninus says there was hardly any plant of which crowns had not been made. The Romans had several kinds of crowns or wreaths which were bestowed for various services; but the noblest was the civic crown, given to him who had saved the life of a citizen; it was made of oak leaves, and was presented by the person who had been saved to his preserver. These were all corruptible, for they began to wither as soon as they were separated from the trees or plucked out of the earth. In opposition to these, there is an incorruptible crown, a crown of life, laid up for those who are faithful unto death (Jas. i, 12; 1 Pet. v, 4; Rev. ii, 10; see *Am. Presb. Rev.* July, 1863). Pilate's guard platted a crown of thorns, and placed it on the head of Jesus Christ (Matt. xxvii, 29) with an intention to insult him, under the character



Isthmian Crowns.

of the king of the Jews (see below). The laurel, pine, or parsley garlands given to victors in the great games of Greece are finely alluded to by Paul (1 Cor. ix, 25; 2 Tim. ii, 5, etc.). See GAMES. They are said to have originated in the laurel-wreath assumed by Apollo on conquering the Python (Tertull. *de Cor. Mil.* 7, 15). (On the Greek and Roman honorary crowns, see Smith, *Dict. of Class. Antiq.*, s. v. Corona.) See AMARANTHINE. "Crown" is often used figuratively in the Bible as a general emblem of an exalted state

(Prov. xii, 4; xvii, 6; Isa. xxviii, 5; Phil. iv, 1, etc.) The term is also applied to the rims of altars, tables, etc. (Exod. xxv, 25, etc.; Deut. xxii, 8; comp. *Viz.* ii, 8; Q. Curt. ix, 4, 80). The ancients as well as the moderns had a coin called "a crown" (*τὸν στέφανον ὀφείλατε*, 1 Macc. xiii, 89; x, 29; A. V. "Crown-tax." v. Suid., s. v. *στέφανικὸν τίλεμα*); so called, doubtless, because coins usually bore the head of the sovereign encircled with a wreath. See COIN.

The chief writers on crowns are Gaschalin (*De Coronis*, lib. x) and Meursius (*De Coronis*, Hafnia, 1671). For others, see Fabricius, *Bibl. Ant.* xiv, 13.—Kitt. v, 7; Smith, s. v. See HEAD-DRESS.

CROWN OF THORNS (*στέφανος ἐξ ἀκανθῶν*, Matt. xxvii, 29). Our Lord was crowned with thorns in mockery by the Roman soldiers. The object seems to have been insult, and not the infliction of pain, as has generally been supposed. The Rhamnus, or Spina Christi, although abundant in the neighborhood of Jerusalem, cannot be the plant intended, because its thorns are so strong and large that it could not have been woven (*πλέξαντες*) into a wreath. The large-leaved acanthus (bear's-foot) is totally unsuited for the purpose. Had the acacia been intended, as some suppose, the phrase would have been *ἐξ ἀκανθῶν*. Obviously some small, flexile thorny shrub is meant, perhaps *capparis spinosa* (Reland's *Palæst.* ii, 525; Hasselquist (*Travels*, p. 260) says that the thorn used was the Arabian *sukk*. "It was very suitable for their purpose, as it has many sharp thorns which inflict painful wounds; and its flexible, pliant, and round branches might easily be plaited in the form of a crown." It also resembles the rich dark green of the triumphal ivy-wreath, which would give additional pungency to its ironical purpose (Rosenmüller, *Botany of Script.* p. 202, Eng. ed.). Another plant commonly fixed upon is the "southern buckthorn," which was very suitable to the purpose. See BRAMBLE. On the empress Helena's supposed discovery of the crown of thorns, and its subsequent fate, see Gibbon, ii, 306; vi, 66, ed. Milman.—Smith, s. v. Treatise on the crown in question has been written in Latin by Bartholin (Hafn. 1651), Bottier (in the *Bibl. Evæ.* viii, 942), Frenzel (Viteb. 1667, 1679), Götsch (Altaf. 1694), Gonsager (Hafn. 1718), Lüdemann (Viteb. 1678), Sagittarius (Jena, 1672), Wedel (Jena, 1696), Glauch (Lips. 1661), Hallmann (Rost. 1757), Müller (in *Meibenhii Thes.* ii, 280-283). See THORN.

Crucifix (Low Latin *crucifixum*; from *cruci*, to a cross, and *fixum*, fastened), a representation of Christ on the cross, executed in wood, ivory, metal, or other hard material.

I. *History of Crucifixes.*—Among the many symbols which the early Christians used to represent Christ as the central object of their faith, the *lamb* was among the most predominant. In the beginning of the 6th century the lamb bears a triumphal cross; then it is lying on an altar at the foot of a cross; then it appears with blood flowing from a wound in its side, as well as from its feet; and finally, by the end of this century, a lamb is painted in the centre of the cross, where the body of Christ was later placed. On the celebrated "cross of the Vatican," on which this lamb thus appears, are two busts of the Saviour: one above, holding a book in his left hand, and giving a benediction (q. v.) in the Latin manner with the right, while the one below holds a scroll in the right hand, and a little cross in the left. The sixth Œcumenical Council (A. D. 680) ordered that Christ should be represented with his proper human body rather than under the symbol of the paschal lamb, and in the following century crucifixes multiplied greatly throughout all Christendom. The way to this decision had evidently been prepared by several intermediate steps, by which the aversion and horror of the death by the cross, though abolished as a mode of execution by Constantine, were

radually overcome in the minds of the Christian world. Thus, on the vials of Monza, which Gregory the Great gave to queen Theodelinda, there is a head of Christ in a nimbus containing a cross. A mosaic of St. Etienne, of about the same period, contains in addition one of the thieves on each side of the head of Christ, with a highly ornamented cross below and in the centre of the vial, with an ornamented ediculum below, crowned by a cross, with an angel on one side, and the two women bringing spices to the tomb of Christ on the other side, indicating the resurrection of Christ. On another, Christ is represented with his arms extended—like the praying persons of the Catacombs—with the two thieves on crosses at his side, and the sun and moon, or other emblems, added to the representation. In the pictorial cross of Monza, said to be a present from Gregory the Great to the empress Theodelinda, and in others of the most ancient crucifixes, the figure of Christ was scratched in on the metal with some sharp-pointed instrument. Later, it was painted. It is in the 9th century that the figures first appeared in relief. The first crucifix used in a church, of which we have any proof, is spoken of by Gregory of Tours as being in the church of Narbonne (A.D. 593). After the council of 692 the Greek Church used painted crucifixes freely. Pope John VII, a Greek by birth (elected A.D. 705), first used the crucifix in St. Peter's Church, Rome. A single crucifix is found in the Catacombs, and this is considered to date from the 8th century. The crucifix soon assumed the most prominent place in the Romish church edifice, being placed over the centre of the high altar, over-towering the tapers, and being removed only at the elevation of the Host. This altar-crucifix is often made in the most costly and artistic way, being usually of gold or silver, and adorned with pearls or precious stones. Crucifixes are also placed at the doors of churches, in cloisters, in chapels by the roadside, and at every place where crosses (q. v.) are erected. They are constantly used by Roman Catholics, both ecclesiastics and laymen, and especially are kept in the bedchamber. The reason given for this abundant use of the crucifix is "to keep the sufferings and death of Christ, and the fact of atonement, ever before the minds of believers." Among the Protestant churches, the Lutheran has not rejected the use of the altar-crucifixes, though Protestants generally consider the use of crucifixes to lead to a worship of the material of which they are made, and to a forgetting of the true spiritual meaning of the Saviour's death; hence they reject them altogether, regarding them as only valuable, whether sculptured or painted, as marking a phase of the development of ritualistic worship, or as works of art.

II. *Details.*—Until the 11th century Christ was represented as living, and usually with his head crowned with a nimbus or other symbol of his triumphal resurrection. His head was erect, his eyes open, indicating his divine nature, which is not subject to death; or, more probably, his triumph over his death. Though Christ was crucified, in accordance with the law, in an entirely naked condition, the earliest crucifixes represent him clothed with a *colobium*, a tunic without arms, and reaching to the feet. At the close of the 8th century, this was modified to a tunic bound around the waist and extending about to the knees; and by the close of the tenth century, the tunic was almost universally contracted to a simple band of cloth around the loins. This has been universally adopted by artists till the present time. The crucifix of the church St. Genès, at Narbonne, is the only example extant of this type being adopted before the 9th century. A manuscript in the Laurentian library at Florence, dating about the year 1060, contains the first example extant of Christ being represented as dead. All the crucifixes from that time represent the head as drooping, and life as just extinct. A stream of blood is sometimes rep-

resented flowing from the wounds in the hands and the side, and falling upon the head of some of the characters represented, symbolizing thus the effects of the atonement. Nearly all of the great artists of the Middle Ages have painted the scene of the crucifixion, these being sometimes their master-pieces. Cimabue and Margaritone, in the 13th century, made the first representations extant of a crucifix with but three nails, the feet being crossed, in their paintings of the crucifixion in the church of St. Maria Novella in Florence. The Romish Church now usually prefers this type of the crucifix, though the former method, adopted by this church also till the 18th century, was without doubt the more in accordance with historical accuracy. The *suppedaneum* to support the feet is usually represented, though some later artists have placed a globe in place of this tablet or shelf. The *support for the body* has never been represented in art. The *title of the cross* was placed on a tablet which was attached to the head of the T cross. There are but one or two cases in which artists have given the full inscription in the three languages, and these are modern. Many crucifixes have no titles. In most it is indicated by a few meaningless marks. In the Greek Church the monogram of Christ, or I C . X C, or A, ω, is generally used.

III. *Accessories.*—These are either such as pertain to the literal circumstances of the crucifixion, or are symbolical figures having reference to the Atonement. The Virgin Mary and St. John are often represented as standing one on each side of the cross, with the head bent forward and resting on the hand—a posture of grief common in all antiquity. The names of the two are usually given either in Latin or Greek. The two soldiers are often given, one holding a lance, and the other the sponge filled with vinegar. The very earliest crucifixes have not these soldiers, but they became common after the 8th century. A single example exists of their drawing lots for the Saviour's garments. The sun and the moon, the former with a face surrounded by a circle, and giving out rays, and the latter in the form of a crescent, are often given, being to the right and left of the head of the Saviour. These are sometimes replaced by two human demi-figures, one with a royal diadem, and the other crowned with a crescent or holding a torch, while both have one hand supporting the head in an attitude of grief. Rays of light often stream, from both the sun and the moon, upon the figure of Christ. These heavenly bodies are considered by many to represent the darkness which suddenly came over nature, concealing the sun and moon. But a better interpretation is that they represent the divine and human nature of Christ, as the same figures do on other monuments. The redemption of man from sin by the death of Christ is symbolized in some crucifixes by a naked man rising up from the ground below the cross, while a hand above him is reached out from a cloud. Another represents a man lying on the ground, while a woman, with one knee on the ground, is taking hold of the hand in the cloud. This is to indicate Adam and Eve. A crucifix in St. John Lateran, in Rome, has a gate (of paradise) on one side, while on the other is a tree (of good and evil), showing that man, lost by partaking of the forbidden fruit, is restored by the cross to the paradise from which he was driven out. The emblems of the four evangelists and angels in adoration are often placed near the upper part of the crucifix. The skull and cross-bones at the foot of the cross is altogether a modern addition. The crucifix of a diptych of Rambona contains a wolf under the cross nourishing Romulus and Remus, supposed to symbolize the subjection of the Roman empire and the world to the cross of Christ, or to the city of Rome as the seat of the Romish Church. Other symbols relating to the truths of Christianity, or to the traditions relating to this central event in the his-

tory of the world, occur in various crucifixes. Many other modifications exist of the presentation of the crucifixion, whether given in full relief, or high or low relief, or whether painted in miniature, in mosaic, on fresco, or on canvas.

Crucifixion (prop. *σταύρωσις*, but in the N. T. the noun does not occur, the act being designated by some form of the verb *σταυρώω*, to apply the cross; once *προσπίγγνυμι*, to fasten, i. e. to the cross, Acts ii, 23; the classical writers use *σταυρούω*, *ἀνασταυρούω*, *σκολοπιζέω*, *προσηλύνω*, and, less properly, *ἀνακινυδύλειν*; *cruci* or *patibulo afficere*, *suffigere*, or simply *figere* [Tertull. *de Pat. iii.*], *cruciare* [Auson. *ad palmam alligare, crucem aliiū staturare, in crucem agere, tollere*, etc.; the sufferer was called *cruciaris*]. See **PASSION**.

I. History.—The variety of the phrases shows the extreme commonness of the punishment, the invention of which is traditionally ascribed to Semiramis. It was in use among the Egyptians (as in the case of Inarus, Thuc. i, 80; comp. Gen. xi, 19), the Carthaginians (as in the case of Hanno, etc., Val. Max. ii, 7; Polyb. i, 86; Sil. Ital. ii, 844; Plutarch, *Paral.* 24; Justin, xviii, 7; Hirt. *Bell. Afric.* 66), the Persians (Polycrates, etc.; Herod. iii, 126; iv, 43; vii, 194; Ctesias, *Excerpt.* 5; comp. Esth. vii, 10), the Assyrians (Diod. Sic. ii, 1), Scythians (id. ii, 44), Indians (id. ii, 18), Germans (possibly Tacit. *German.* 12), and very frequent from the earliest times (Livy, i, 26) among the Romans. Cicero, however, refers it, not (as Livy) to the early kings, but to Tarquinius Superbus (*pro Rab.* 4); Aurel. Victor calls it *vetus veterrimusque* (? *toterr.*) *patibulorum supplicium*. Both *κρεμῶν* and *suspendere* (Ovid, *Ibis*, 299) refer to death by crucifixion; thus, in speaking of Alexander's crucifixion of 2000 Tyrians, *ἀνεπίμασεν* in Diod. Sic. answers to the *crucibus affixus* in Q. Curt. iv, 4. The Greeks (Strabo, xiv, 647) and Macedonians (Appian, *Mithr.* 8; Curt. vii, 11, 28; ix, 8, 6) also sometimes resorted to this mode of punishment.

This accursed and awful mode of punishment was happily abolished by Constantine (Sozom. i, 8) probably towards the end of his reign (see Lipsius, *De Cruce*, iii, 15), although it is curious that we have no more definite account of the matter. Examples of it are found in the early part of that emperor's reign, but the reverence which, at a later period, he was led to feel for the cross, doubtless induced him to put an end to the inhuman practice (Aurel. Vict. *Cæs.* 41; Niceph. vii, 46; Firmic. viii, 20). "An edict so honorable to Christianity," says Gibbon, "deserved a place in the Theodosian Code, instead of the indirect mention of it which seems to result from the comparison of the 5th and 18th titles of the 9th book" (ii, 154, note). See **PUNISHMENT**.

II. As a Jewish Custom.—Whether this mode of execution was known to the ancient Jews is a matter of dispute (see Bormitius, *De Cruce num Ebraeor. supplic. fuerit*, Viteb. 1644; Chausfépé, in the *Miscell. Duitob.* ii, 401 sq.). It is asserted to have been so by Baronius (*Annal.* i, xxxiv), Sigonius (*De Rep. Hebr.* vi, 8), etc., who are refuted by Casaubon (*c. Baron. Exerc.* xvi), Carpzov (*Apparat. Crit.* p. 591). The Hebrew words said to allude to it are *תליה*, *talah'* (sometimes with the addition of *על היצץ*, "upon the tree;" hence the Jews in polemics call our Lord *תלוי*, and Christians *כורבני תלוי*, "worshippers of the crucified"), and *גלגול*, *galgal'*, both of which in the A. Vers. are generally rendered "to hang" (2 Sam. xviii, 10; Deut. xxi, 22; Num. xxv, 4; Job xxvi, 7), for which *σταυρώω* occurs in the Sept. (Esth. vii, 10), and *crucifigere* in the Vulg. (2 Sam. xxi, 6, 9). The Jewish account of the matter (in Maimonides and the Rabbis) is, that the exposure of the body tied to a stake by its hands (which might loosely be called crucifixion) took

place after death (Lightfoot, *Hor. Hebr. in Matt.* xxvii, 31; Othonis *Lex. Rabb.*, s. v. *Supplicia*; Reland, *Ant.* ii, 6; Sir T. Browne, *Vulg. Errors*, v, 21). Even the placing of a head on a single upright pole has been called crucifixion. This custom of crucifixion after death (which seems to be implied in Deut. xli, 2; 28) was by no means rare; men were first killed in mercy (Sueton. *Cæs.*; Herod. iii, 126; Plutarch, *Class.* 88). According to a strange story in Pfliny (xxvii, 15, § 24), it was adopted by Tarquin as a post-mortem disgrace, to prevent the prevalence of suicide. It seems, on the whole, that the Rabbis are correct in asserting that this exposure is intended in Scripture, since the Mosaic capital punishments were four (viz., the sword, Exod. xxi; strangling, fire, Lev. xx; and stoning, Deut. xxi). Philo, indeed, says (*De leg. spec.*) that Moses adopted crucifixion as a murderer's punishment because it was the worst he could discover; but the passage in Deut. (xxi, 28) does not prove his assertion. Probably, therefore, the Jews borrowed it from the Romans (Josephus, *Ant.* xx, 6, 2; *War.* ii, 12, 6; *Life*, 75, etc.), although there may have been a few isolated instances of it before (Josephus, *Ant.* xiii, 14, 2). See **HANGING**.

It was unanimously considered the most horrible form of death, worse even than burning, since the "cross" precedes "burning" in the law-books (Lipsius, *De Cruce*, ii, 1). Hence it is called *crudelissimum teterrimumque supplicium* (Cicero, *Verr.* v, 66), *extremum pena* (Apol. *de Aur. A sin.* x), *summum supplicium* (Paul. *Sent.* v, tit. xxi, etc.); and to a Jew it would acquire factitious horror from the curse in Deut. xxi, 23. Among the Romans also the degradation was a part of the infliction, since it was especially a *servile supplicium* (Tacitus, *Hist.* iv, 11; Juvenal, vi, 218; Horace, *Sat.* i, 8, 8, etc.; Plautus, *passim*), or "a slave's punishment" (*De Infanti quo Chr. adfectus est crux supp.* in Lange's *Observat. Sacr.* [Lubec, 1731], p. 151 sq.; also Hencke, *Opusc.* p. 137 sq.), so that even a freedman ceased to dread it (Cicero, *pro Rab.* 5); or if applied to freemen, only in the case of the vilest criminals (Joseph. *Ant.* xvii, 10, 10; *War.* v, 11, 1; Paul. *Sent.* v, tit. xxiii; Lamprid. *Alex. Sev.* 23), such as persons guilty of robbery, piracy (Seneca, *Ep. vii*; Cicero, *Patron.* 71), assassination, perjury (Firmic. vi, 26), sedition, treason, and (in the case of soldiers) desertion (Dion, v, 52; Joseph. *Ant.* xiii, 22; Apuleius, *A sin.* 3). Indeed, exemption from it was the privilege of every Roman citizen by the *jus civitatis* (Cicero, *Verr.* ii, 1, 3). Our Lord was condemned to it by the popular cry of the Jews (Matt. xxvii, 23, as often happened to the early Christians) on the charge of sedition against Cæsar (Luke xxiii, 2), although the Sanhedrim had previously condemned him on the totally distinct charge of blasphemy. Hundreds of Jews were crucified on the former charge, as by Florus (Joseph. *War.* ii, 14, 9) and Varus, who crucified 2000 at once (*Ant.* xvii, 10, 10). See **EXECUTION**.

III. Process.—The scarlet robe, crown of thorns, and other insults to which our Lord was subjected, were illegal, and arose from the spontaneous petulance of the brutal soldiery. But the punishment properly commenced with scourging, after the criminal had been stripped; hence, in the common form of sentence, we find "summove, lictor, *desposita, verbera*," etc. (Livy, i, 26). For this there is a host of authorities—Livy, xvii, 18; Q. Curt. vii, 11; Lucan, *de Piscal.* 2; Jerome, *Comment. ad Matt.* xxvii, 26, etc. It was inflicted, not with the comparatively mild *virga*, but the more terrible *flagellum* (Horace, *Sat.* i, 8; comp. 2 Cor. xi, 24, 25), which was not used by the Jews (Deut. xxv, 8). Into these scourges the soldiers often stuck nails, pieces of bone, etc., to heighten the pain (the *μάστιγις αἰσθητικῆς* mentioned by Athenæus, etc.; *flagrum pecuinis ossibus catenatum*, Apul.), which was often so intense that the sufferer died under it (Ulp. *de Penis*, l. viii). The scourging generally took

place at a column, and the one to which our Lord was bound is said to have been seen by Jerome, Prudentius, Gregory of Tours, etc., and is shown at several churches among the relics. In our Lord's case, however, this affliction seems neither to have been the legal scourging after the sentence (Val. Max. i. 7; Josephus, *War.*, i. 28; ii. 14, 9), nor yet the examination by torture (Acts xxii, 24), but rather a scourging before the sentence, to excite pity and procure immunity from further punishment (Luke xxiii, 22; John xix, 1); and if this view be correct, the reference to it (*φραγίλλω-α*) in Matt. xxvii, 26, is retrospective, as so great an anguish could hardly have been endured *twice* (see *Poli Synopsis*, ad loc.). How severe it was is indicated in prophecy (Psa. xxxv, 15; Isa. i, 6). Vossius considers that it was partly legal, partly tentative (*Harm. Pass.* v, 13). See SCOURGE.

The criminal carried his own cross, or, at any rate, a part of it (Plutarch, *De iis qui sero*, etc., 9; Artemid. *Oneirocr.* ii, 61; see John xix, 17; comp. "patibulum ferat per urbem, deinde affigatur cruci," Plaut. *Carbo-nar.*). Hence the term *furcifer*, cross-bearer (q. v.). This was prefigured by Isaac carrying the wood in Gen. xxii, 6, where even the Jews notice the parallel; and to this the fathers fantastically applied the expression in Isa. ix, 6, "the government shall be upon his shoulder." They were sometimes scourged and goaded on the way (Plaut. *Mostel.* i, 1, 52). "In some old figures we see our Lord described with a table appendent to the fringe of his garment, set full of nails and pointed iron" (Jer. Taylor, *Life of Christ*, iii, xv, 2; *Hæreas ligno quod tateras*, *Cypr. de Pas.* p. 50). See SIMON (OF CYRENE).

The place of execution was outside the city ("post urbem," Cicero, *Verr.* v, 66; "extra portam," Plaut. *Mil. Gl.* ii, 4, 6; comp. 1 Kings xxi, 13; Acts vii, 58; Heb. xiii, 12; and in camps "extra vallum"), often in some public road (Quinct. *Decl.* 275) or other conspicuous place like the Campus Martius (Cicero, *pro Rabirio*), or some spot set apart for the purpose (Tacitus, *Ann.* xv). This might sometimes be a hill (Val. Max. vi); it is, however, rather an inference to call Golgotha a hill; in the Evangelists it is called "a place" (*τόπος*). See CALVARY. Arrived at the place of execution, the sufferer was stripped naked (Artemidorus, *Oneirocr.* ii, 58), the dress being the perquisite of the soldiers (Matt. xxvii, 85; *Dig.* xlviii, 20, 6); possibly not even a cloth round the loins was allowed him; at least among the Jews the rule was "that a man should be stoned naked" (*Sanhedr.* vi, 8), where the context shows that "naked" must not be taken in its restricted sense. The cross was then driven into the ground, so that the feet of the condemned were a foot or two above the earth (in pictures of the crucifixion the cross is generally much too large and high), and he was lifted upon it (*agere, ecurrere, tollere, ascendere in crucem*; Prudent. *περί στυφ.*; Plautus, *Mostel.* "Crucisatus," *id. Bacch.* 2, 8, 128; *ἀνήγον, ἵγον, ἵγον εἰς ἄκρον τέλος*, Greg. Naz.), or else stretched upon it on the ground, and then lifted with it, to which there seems to be an allusion in a lost prophecy quoted by Barnabas (*Ep.* 12), *ὄραν ἕλον κλυθῆ καὶ ἀναστῆ* (Pearson, *On the Creed*, Acts iv). The former method was the commoner, for we often read (as in *Esth.* vii, 10, etc.) of the cross being erected beforehand in torrem. Before the nailing or binding took place, a medicated cup was given out of kindness to confuse the senses and deaden the pangs of the sufferer (Prov. xxxi, 6), usually of bitter wine (*οἶνος ἐσυρμυμμένος* or *λελιβανωμένος*), as among the Jews (Lightfoot, *Hor. Hebr. ad Matt.* xxvii), because myrrh was soporific. Other bitter herbs were also employed (Pipping, *Exercit. Acad.* p. 55). Our Lord refused it that his senses might be clear (Matt. xxvii, 34; Mark xv, 23; Maimonides, *Sanhedr.* xiii). Matthew calls it "vinegar mingled with gall" (*ὄξος μίτα χολῆς, γῆρ*), an expression used in reference to

Psa. lxxix, 21, but not strictly accurate. This mercifully intended draught must not be confounded with the spongeful of vinegar (or *posca*, the common drink of Roman soldiers, Spart. *Had.*; Plaut. *Mil. Gl.* iii, 2, 23), which was put on a hyssop-stalk and offered to our Lord in mocking and contemptuous pity (Matt. xxvii, 48; Luke xxiii, 36); this he hastened to allay the agonies of thirst (John xix, 29).

The body was affixed to the cross by nails (see Corn. Curtius, *De clavibus Domini*, Antw. 1760) driven into the hands, and more rarely into the feet; sometimes the feet were fastened by one nail driven through both (Tertull. *adv. Jud.* x; Senec. *De Vita Beat.* 19; Lactant. iv, 18). The feet were occasionally bound to the cross by cords; and Xenophon asserts that it was usual among the Egyptians to bind in this manner not only the feet, but the hands. An inscription (*titulus*) was written upon a small tablet (*σάβις*, Socrat. *Hist. Eccl.* i, 17) declaring the crime (see Alberti, *De Inscript. crucis Chr.* Lips. 1725), and placed on the top of the cross (Sueton. *Cal.* 88; *Dom.* 10; Euseb. *Hist. Eccl.* v, 1). The body of the crucified person rested on a sort of seat (*πήγμα*) (Iren. *adv. Hæc.* ii, 42). The criminal died under the most frightful sufferings—so great that even amid the raging passions of war pity was sometimes excited. Josephus (*War.* v, 11, 1) narrates of captives taken at the siege of Jerusalem that "they were first whipped, and tormented with all sorts of tortures, and then crucified before the walls of the city. The soldiers, out of the wrath and the hatred they bore the Jews, nailed those they caught one after one way and another after another to crosses, by way of jest, when their multitude was so great that room was wanting for the crosses and crosses wanting for the bodies. This miserable procedure made Titus greatly pity them." Sometimes the suffering was shortened and abated by breaking the legs of the criminal—*crura fracta* (Cicero, *Phil.* xiii, 12). The execution took place at the hands of the *carriker*, or hangman, attended by a band of soldiers, and in Rome under the supervision of the *Triumviri Capiteles* (Tacit. *Ann.* xv, 60; Lactant. iv, 26). The accounts given in the Gospels of the execution of Jesus Christ are in entire agreement with the customs and practices of the Romans in this particular (Tholuck, *Glaubwürdigkeit der evangel. Gesch.* p. 361).

Our Lord was crucified between two "thieves" (*ἄστροι, robbers*) or "malefactors" (then so common in Palestine, Josephus, *War.* ii, 6, etc.), according to prophecy (Isa. liii, 12); and was watched according to custom by a party of four soldiers (John xix, 23), with their centurion (*κοιτωρία*, Matt. xxvii, 66; *milis qui cruces asservabat*, Petr. *Sat.* iii, 6; Plutarch, *Vit. Cleom.* 88), whose express office was to prevent the surreption of the body (Seneca, *Ep.* 101). This was necessary from the lingering character of the death, which sometimes did not supervene even for three days, and was at last the result of gradual benumbing and starvation (Euseb. viii, 8; Seneca, *Prov.* 8). But for this guard, the persons might have been taken down and recovered, as was actually done in the case of a friend of Josephus, though only one survived out of three to whom the same careful nursing (*θεραπεία ἐπιμελειάρην*) was applied (*Life*, 75). Among the Convulsionnaires in the reign of Louis XV, women would be repeatedly crucified, and even remain on the cross three hours; we are told of one who underwent it twenty-three times (*Encycl. Metr.*, s. v. Cross); the pain consisted almost entirely in the *nailing*, and not more than a basinful of blood was lost. Still we cannot believe from the Martyrologies that Victorinus (crucified head downward) lived three days, or Timotheus and Maura nine days (compare Bretechnneider, in the *Studien u. Krit.*, 1832, ii, 625; Paulus, in the *Darmst. Kirchenzeit.* 1833, No. 8, 9). Fracture of the legs (Plant. *Pas.* iv, 2, 64) was especially adopted by the Jews (Deut. xxi, 22) to hasten death (John xix, 31), and it

was a mitigation of the punishment (Casaub. *Exerc. Antib.* p. 537), as observed by Origen. But the unusual rapidity of our Lord's death was due to the depth of his previous agonies (which appears from his inability to bear his own cross far), and to his mental anguish (Schöttgen, *Hor. Heb.* vi, 3; *De pass. Messie*), or it may be sufficiently accounted for simply from peculiarities of constitution. There is no need to explain the "giving up of the ghost" as a miracle (Heb. v, 7?), or say with Cyprian, *Prevento carnificis officio, spiritum sponte dimisit* (*Ado. Denetr.*). Still less can the common cavil of infidelity be thought noteworthy, since, had our Lord been in a swoon, the piercing of his pericardium (proved by the appearance of lymph and blood) would have ensured death. (See Eschenbach, *Opusc. Méd. de Servatore non apparenter sed vere mortuo*, and Gruner, *De morte Christi non synoptica*, quoted by Jahn in his *Bibl. Arch.*) (See below.) Pilate expressly satisfied himself of the actual death by questioning the centurion (Mark xv, 44); and the omission of the breaking of the legs in this case was the fulfilment of a type (Exod. xii, 46). Other modes of hastening death were by lighting fires under the cross (hence the nicknames *Sarmenitii* and *Semazii*, Tert. *Apolog.* 50), or letting loose wild beasts on the crucified (Suet. *Ner.* 49).

Generally the body was suffered to rot on the cross (Cicero, *Tusc. Q.* i, 48; Sil. Ital. viii, 486) by the action of sun and rain (Herod. iii, 12), or to be devoured by birds and beasts (Apol. *de Aur. Asia.* 6; Horace, *Ep.* i, 16, 48; Juvenal, xiv, 77). Sepulture was generally therefore forbidden (Pliny, *Hist. Nat.* xxxvi, 24), though it might be granted as a special favor or on grand occasions (Ulp. l. ix, *De off. Pascons.*). But, in consequence of Deut. xxi, 22, 23, an express national exception was made in favor of the Jews (Matt. xxvii, 58; comp. Joseph. *War.* iv, 5, 2).

IV. *Pathology.*—It only remains to speak of the manner of death, and the kind of physical suffering endured, which we shall very briefly abridge from the treatise of the physician Richter (in Jahn's *Bibl. Arch.*). These are, 1. The unnatural position and violent tension of the body, which cause a painful sensation from the least motion. 2. The nails, being driven through parts of the hands and feet which are full of nerves and tendons (and yet at a distance from the heart), create the most exquisite anguish. 3. The exposure of so many wounds and lacerations brings on inflammation, which tends to become gangrene, and every moment increases the poignancy of suffering. 4. In the distended parts of the body more blood flows through the arteries than can be carried back into the veins: hence too much blood finds its way from the aorta into the head and stomach, and the blood-vessels of the head become pressed and swollen. The general obstruction of circulation which ensues causes an internal excitement, exertion, and anxiety more intolerable than death itself. 5. The inexpressible misery of gradually increasing and lingering anguish. To all this we may add, 6. Burning and raging thirst.

Death by crucifixion (physically considered) is therefore to be attributed to the sympathetic fever which is excited by the wounds, and aggravated by exposure to the weather, privation of water, and the painfully constrained position of the body. Traumatic fever corresponds, in intensity and in character, to the local inflammation of the wound. In the first stage, while the inflammation of the wound is characterized by heat, swelling, and great pain, the fever is highly inflammatory, and the sufferer complains of heat, throbbing headache, intense thirst, restlessness, and anxiety. As soon as suppuration sets in, the fever somewhat abates, and gradually ceases as suppuration diminishes and the stage of cicatrization approaches. But if the wound be prevented from healing, and suppuration continue, the fever assumes a hectic character, and will sooner or later exhaust the powers of life. When, how-

ever, the inflammation of the wound is so intense as to produce mortification, nervous depression is the immediate consequence; and if the cause of this excessive inflammation of the wound still continues, as is the case in crucifixion, the sufferer rapidly sinks. He is no longer sensible of pain, but his anxiety and sense of prostration are excessive; hiccough supervenes, his skin is moistened with a cold clammy sweat, and death ensues. It is in this manner that death on the cross must have taken place in an ordinarily healthy constitution. The wounds in themselves were not fatal; but, as long as the nails remained in them, the inflammation must have increased in intensity until it produced gangrene. The period at which death occurred was very variable, as it depended on the constitution of the sufferer, as well as on the degree of exposure and the state of the weather. It may, however, be asserted that death would not take place until the local inflammation had run its course; and though this process may be much hastened by fatigue and the alternate exposure to the rays of the sun and the cold night air, it is not completed before forty-eight hours, under ordinary circumstances, and in healthy constitutions; so that we may consider thirty-six hours to be the earliest period at which crucifixion would occasion death in a healthy adult. It can not be objected that the heat of an Eastern climate may not have been duly considered in the above estimate, for many cases are recorded of persons having survived a much longer time than is here mentioned, even as long as eight or nine days. Eusebius (*Hist. Eccles.* iii, 8) says that many of the martyrs in Egypt, who were crucified with their heads downward, perished by hunger. The want of water was a much more important privation. It must have caused the sufferer inexpressible anguish, and have contributed in no slight degree to hasten death.—Smith, s. v.; Kitto, s. v.

Several eminent writers had occupied themselves with the physiology of our Saviour's passion, if we may so express ourselves, before the "scientific" method of treating it was resorted to; such were Scheuchzer, Mead, Bartholinus, Vogler, Triller, Richter, and Eschenbach. But a much fuller and more exact investigation has since been made by the two Gruners, father and son, the latter of whom first wrote under the direction, and by the advice of the former. These earlier authors have collected all that medical analogies could furnish towards establishing the character of our Saviour's sufferings and the reality of his death. "The pulmonary, and other veins and arteries about the heart and chest, by the abundance of blood flowing thither, and there accumulating, must have added frightful bodily suffering to the anguish of mind produced by the overpowering burden of our sins" (G. F. Richter's *Dissertationes Quatuor Medice*, Gotting. 1775, p. 57). But this general suffering must have made a relative impression upon different individuals; and, as Charles Gruner well observes, the effect it produced upon two hardy and hardened thieves, brought out fresh from prison, must naturally have been very different from that on our Saviour, whose frame and temperament were of a very opposite character; who had been previously suffering a night of tortures and restless fatigue; who had been wrestling with mental agony till one of the rarest phenomena had been caused—a bloody sweat; who must have felt to the most acute degree of intensity all the mental aggravation of his punishment—its shame and ignominy, and the distress of his pious mother, and few faithful friends (C. F. Gruner's *Commentatio Antiquaria Medica de Jezu Christi morte vera non simulata*, Halle, 1806, p. 30-45). To these he might have added other relations, as that our Saviour was evidently weakened beyond other persons in similar circumstances, seeing that he was not strong enough to carry his cross, as criminals led to execution were always able to do; and if the men whom we are answering suppose our Lord to have

ly fallen into a trance from exhaustion, they have manifestly no right to judge from other cases, for in none even this did not occur. The younger Gruner examines minutely into all the smallest circumstances of the passion, examining them as objects of medical jurisprudence, and particularly takes cognizance of the wound inflicted by the soldier's lance. He shows the great probability of the wound having been in the left arm, and from below transversely upward; he demonstrates that such a stroke, inflicted by the robust arm of a Roman soldier, with a short lance, for the cross was raised much from the ground, must, in any hypothesis, have occasioned a deadly wound. Up to this point he supposes our Saviour may have been still intently alive, because otherwise the blood would not have flowed, and because the loud cry which he uttered a symptom of a syncope from too great a congestion of blood about the heart. But this wound, which, from the flowing of blood and water, he supposes to have been in the cavity of the chest, must, according to him, have been necessarily fatal. Tirinus and other commentators, as well as many physicians, Gruner, Bartholinus, Triller, and Eschenbach, suppose this water to have been lymph from the pericardium. Vogler *Physiologia Historica Passivis*, Helmst. 1698, p. 44) supposes it to have been serum separated from the blood. But from the manner in which the apostle John mentions this mystical flow, and from the concurrent entiment of all antiquity, we must admit something more than a mere physical event. Richter observes that the abundant gush of the blood and water, "non ita in mortuis fieri solet, lentum et grumosum, sed caentem adhuc et flexilem, tamquam ex calentissimo misericordiae fonte," must be considered preternatural, and deeply symbolical. Christian Gruner goes over the same ground, and answers, step by step, the additional objections of an anonymous impugner. He shows that the words used by John to express the wound inflicted by the lance are often used to denote a mortal one; he proves that, even supposing the death of Christ to have been in the first instance apparent, the infliction of merely a slight wound would have been fatal, because, in syncope or trance arising from loss of blood, any venesection would be considered such (*Vindiciae Mortis Jesu Christi verae*, p. 67, 77, sq.); and that, in fine, so far from the spices or unguents used in embalming, or the close chamber of the tomb, being fitting restoratives to a person in a trance, they would be the most secure instruments for converting apparent into real death, by suffocation. To this we may add Eschenbach's observation (*Scripta Medici-biblica*, Rostock, 1779, p. 128) that there is no well-recorded instance of syncope lasting more than one day, whereas here it must have lasted three; and also that even this period would not have been sufficient to restore to strength and health a frame which had undergone the shattering tortures of crucifixion and the enfeebling influence of syncope from loss of blood. A consideration not noticed by any of these authors seems to decide the point of the depth of the wound, and place beyond doubt that it could not be superficial, but must have entered the cavity. Our Saviour distinguishes the wounds in his hands from that of his side by desiring Thomas to measure the former by his finger, and the latter by the insertion of his hand (John xx, 27). This, therefore, must have been of the breadth of two or three fingers on the outside. But for a lance, which tapered very gently from the point, to leave a scar or incision on the flesh of such a breadth, at least four or five inches must have penetrated into the body, a supposition quite incompatible with a superficial or flesh wound. Of course, this reasoning is with those who admit the entire history of the passion and subsequent appearance of our Saviour, but deny his real death; and such are the adversaries of the Gruners.

It is not inappropriate here to introduce a case which may confirm some of the foregoing observations. It

is an account of a crucified Mameluke, or Turkish servant, published by Kosegarten (*Chrest. Arab.* Lips. 1828, p. 68-65), from an Arabic manuscript entitled "*The Meadows of Flowers and the fragrant Odour.*" The narrative, after quoting the authorities, as is usual in Arabic histories, proceeds as follows: "It is said that he had killed his master for some cause or other, and he was crucified on the banks of the river Barada [Burada], under the castle of Damascus, with his face turned towards the east. His hands, arms, and feet were nailed, and he remained so from midday on Friday to the same hour on Sunday, when he died. He was remarkable for his strength and prowess; he had been engaged with his master in sacred war at Askelon, where he slew great numbers of the Franks; and when very young he had killed a lion. Several extraordinary things occurred at his being nailed, as that he gave himself up without resistance to the cross, and without complaint stretched out his hands, which were nailed, and after them his feet: he in the mean time looked on, and did not utter a groan, or change his countenance, or move his limbs." Thus we see a person, in the flower of his age, remarkable for his hardihood and strength, inured to military fatigue, nay, so strong that we are told, in another part of the narrative, that "he moved his feet about, though nailed, till he loosened the fastenings of the nails, so that, if they had not been well secured in the wood, he would have drawn them out;" and yet he could not endure the suffering more than eight-and-forty hours. But the most interesting circumstance in this narration, and the illustration of the scriptural narrative principally in view, is the fact, not mentioned by any ancient describer of this punishment, that the principal torture endured by this servant was that of thirst, precisely as is intimated in the Gospel history (John xix, 28). For the Arabic narrator thus proceeds: "I have heard this from one who witnessed it—and he thus remained till he died, patient and silent, without walling, but looking around him to the right and to the left, upon the people. But he begged for water, and none was given him; and the hearts of the people were melted with compassion for him, and with pity on one of God's creatures, who, yet a boy, was suffering under so grievous a trial. In the mean time, the water was flowing around him, and he gazed upon it, and longed for one drop of it . . . and he complained of thirst all the first day, after which he was silent, for God gave him strength."—Bastow, s. v.

Various theories have therefore been proposed to account for the speedy death of Christ upon the cross. That it did not occur simply and directly from the crucifixion is evident from the above statements, and from the surprise of Pilate that it had taken place so soon, when the thieves crucified at the same time had not expired. The usual theory attributes his sudden death to a voluntary surrender of his own life, which is supposed to be favored by the expression "yielded or 'gave' up the ghost," ἀφῆκε [παρέδωκε] τὸ πνεῦμα, Matt. xxvii, 50; John xix, 30), and also by his declarations concerning his "laying down his life" (τίθημι τὴν ψυχὴν, John x, 11, 15, 17). But, aside from the inappropriateness of these passages (the same terms being often used of ordinary decease and of voluntary submission to a violent death), this view is derogatory to the character of Christ (who is thus, in effect, made a suicide), and inconsistent with the expressions concerning the guilt of his murderers (who are thus made only accessories or assistants). The most probable explanation of the sudden death of Christ is that proposed and extensively argued by Dr. Stroud (*Treatise on the Physical Cause of the Death of Christ*, Lond. 1847), who attributes it to a proper rupture of the heart, a pathological accident, which he thus describes (p. 88): "The immediate cause is a sudden and violent contraction of one of the ventricles, usually the left, on the column of blood thrown into it by a similar contraction of the corresponding auricle. Prevented from returning

backward by the intervening valve, and not finding a sufficient outlet forward in the connected artery, the blood reacts against the ventricle itself, which is consequently torn open at the point of greatest distention, or least resistance, by the influence of its own reflected force. A quantity of blood is hereby discharged into the pericardium, and, having no means to escape from that capsule, stops the circulation by compressing the heart from without, and induces almost instantaneous death. In young and vigorous subjects, the blood thus collected in the pericardium soon divides into its constituent parts, namely, a pale, watery liquid called serum, and a soft clotted substance of a deep red color, called crassamentum; but, except under similar circumstances of extravasation, this distinct separation of the blood is seldom witnessed in the dead body." This explanation meets all the circumstances of Christ's passion. The violence of his emotions was sufficient to burst open the heart, as Dr. Stroud shows by a multitude of examples of immediate death from sudden mental affections; and this, as a secondary cause, is confirmed by the occurrence of the sanguineous perspiration in the garden from similar emotions. See BLOODY SWEAT. It explains the suddenness of Christ's death, so evident in all the evangelical narratives, as well as its early occurrence, so surprising to Pilate. The loud shrieks that immediately preceded dissolution were at once the expression of the mental paroxysm (Matt. xxvii, 50; Mark xv, 37), and the effort of nature to relieve the system from the sense of suffocation consequent upon the congestion of blood at the heart. This will also account for the presence of "water" (serum), as well as "blood" (crassamentum), in a commingled yet distinct state, within the pericardium, and discharged at the orifice made by the soldier's spear (John xix, 34), since no blood would flow from a wound in a corpse's veins. See BLOOD AND WATER.

V. *Literature*.—An explanation of the other circumstances attending the crucifixion belongs rather to a commentary than a dictionary. The assertion of Paulus and others, that the feet were not nailed (Curtius, *De clavis Domini*, Antw. 1670), is amply refuted by Winer (*De pedum affixione*, Lips. 1845) and others. For the detailed incidents in our Saviour's case, see JESUS; and compare Hase, *Leben Jesu*, § 115. On the types and prophecies of it, besides those adduced, see Cyp. *Testim.* ii, 20. On the resurrection of the saints, see Lightfoot, *ad. Matt.* xxvii, 52 (there is a monograph by Gebaverius—*Dissert. de Resur. sanctorum cum Christo*, in his *Comment. Miscell.* No. 6). See RESURRECTION. On other concomitant prodigies, see Schöttgen, *Hor. Hebr. et Talmud.* vi, 3, 8. See DARKNESS; EARTHQUAKE. The chief ancient authorities may be found in Lipsius, *De Cruce* (Antwerp, 1589, 1594, and since); see also in Fabric. *Bibliogr. Antiquar.* (Hamb. 1760), p. 755 sq.; and especially Friedlieb, *Archäologie der Leidensgeschichte* (Bonn, 1843). On the points in which our Lord's crucifixion differed from the ordinary Jewish customs, see Othonis *Lex. Rabbincum*, s. v. Supplicia; Bynæus, *De Morte J. Christi*; Vossius, *Harm. Passionis*; Carpov, *Apparat. Crit.* p. 591, sq. etc.; Salmasius, *De Cruce* (L. B. 1646); Bartholinus, *De latere Christi aperto* (L. B. 1646); also *De Cruce Christi* (Amst. 1670, L. B. 1698); Zobel, in the *Magaz. fur bibl. Interpret.* ii, 321 sq. See CROSS.

There are monographs in Latin on the following points connected with the subject: on the cross itself, by Baudissus (Viteb. 1673), Cellarius (Ziz. 1677), Cyprian (Helmst. 1699), Freiesleben (Jen. 1662), Germar (Thorun. 1787), Gezelius (Upsal. 1692), Gleich (Lips. 1704), Liperuis (Sedin. 1675), Ortlob (Viteb. 1655), Nihusius (Colon. 1644), Paschius (Viteb. 1686), Richter (Zittau, 1775), Verporten (Freft. ad V. 1759), Greter (Ingolst. 1598–1605), id. (ib. 1610), Lipius (Antwerp, 1595, 1606, Amst. 1670), Bosius (Antw. 1617), Bornitius (Vit. 1644), Salmasius (L. B. 1646), Lange (Vit. 1669),

Lamy (*Harm. Ev.* p. 573 sq.); on the crucifixion generally, by Buddæus (Jen. 1707), Dilher (Norimb. 1663), Gerhard (Rost. 1662), Vogler (Helmst. 1693), Versus (Traj. ad Rh. 1700), Lydius (Dortrac. 1672, Zutphen. 1701), id. (Tr. ad R. 1701), Medhurst (*Bibl. Brm.* i, 13), iii, 11), Margalitha (Freft. ad V. 1706), Mercha (Duisb. 1722), two anonymous *fasciculi* (Dusseld. 1730), Westhovius (L. B. 1738), Sturm (Hal. 1704), Hessler (Sondersh. 1770), Fremery (1788), Zobel & Germ. *Mag. fur bibl. Interpret.* i, 2), Essner (in Gem. Nürnberg. 1818), Jongh (Tr. ad Rh. 1827), Hug (in Gem. *Freib. Zeitschr.* 1831), Scharf (Leucop. 1606), Engelmann (Cygn. 1679), Haberkorn (Gress. 1656), Latholt (Kilon. 1687), Priusius (Lips. 1697), Habicht (Rost. 1681), Mieg (Heidelb. 1681), Niepenek (Est. 1700), Haferung (Viteb. 1739), Moebius (Lips. 1695), Scharf (Leucopetr. 1666), Stosch (Freft. ad V. 173), Vitringa (*Obs. sacr.* ii, 384 sq.); on the infamy of the punishment, by Henke (Helmst. 1785), Jetze (*Stup.* 1761), Lange (Lubec. 1729); on the time of Christ's crucifixion (in reconciliation of the discrepancy between Mark xv, 25, and John xix, 14), by Keil (Lips. 1778–1780), Liebknecht (Gies. 1726), Michaelis (in Germ. *Hamb. Bibl.* iii, 2), Reyper (*Theol. Diss.* ii, 211), Schwarz (Lips. 1778), Morinus (Lugd. B. 1686, 1694), Oslander (Tubingen, 1743), Pauli (Halle, 1744, 1757), Woerger (in Menethen. *Theaur.* ii, 277), Wolf (Lips. 1750), Zeibich (in German. Lpz. 1713), Zeltner (three diss., Altorf. 1720, 1721, 1724), Knttel (in German. Wolfenb. 1755), Horn (Havn. 1780), Rhein (in German. Lpz. 1832); on Christ's thirst and drink on the cross, by Bauer (Viteb. 1714), Deyling (*Obs.* i, 227), Faber (London, 1660), Hutten (Guben. 1671), Leo (Leucop. 1721), Neumann (Viteb. 1688), Pipping (Lips. 1688), Rausch (Jena, 1733), Schlegel (in German. *Heilr. Magaz.* iv, 288–291), Walch (*Obs. in Matth.* p. 121–138); on his prayer for his murderers, by Marck (*Syll. Diss.* p. 308, 328), Pfaff (Tub. 1746); on his despairing cry, by Hoepfner (Lips. 1641), Frischmann (Jen. 1668), Niemann (Jen. 1671), Scharf (Vit. 1671), Lockerwitz (Viteb. 1680), Olearius (Lips. 1683), the same (ib. 1683, 1726), Deutschmann (Viteb. 1685), Winslow (Havre, 1706), Engeström (Lund. 1760), Luger (Jena, 1789), Leucke (Lips. 1753), Weissmann (Tub. 1746), Sommel (Lund. 1774), Wickenhöfer (in Germ., Zimmermann's *Monatsch.* 1822, No. 24); on his commending his spirit to the Father, by Walk (Lips. 1726; again Gott. 1744); on his so-called "last seven words," by Froeryens (Argent. 1625), Dannhafer (ib. 1641), Lange (Lips. 1651), Mayer (Gryph. 1706), Crüger (Vit. 1726), Vincke (Tr. ad Rh. 1846); on the presence of Mary, by Zorn (*Opusc.* ii, 316–322); on the perforation of the hands and feet, by Fontanus (Amst. 1641), Stemler (Dresd. 1741); on the puncture by the spear, by Sagittarius (Jena, 1673); also in *Theol. Diss. Amst.* ii, 381–7), Bartholinus (L. B. 1646, Lips. 1664, 1683, Fröf. 1681), Faes (Helmst. 1676), Queststedt (Viterb. 1678), Wedel (Jen. 1686), Jacobi (Lips. 1686), Suantenius (Rost. 1686), Loescher (Vit. 1687), Triller (Vit. 1775); on the discharge from the wound, by Kocher (Dresd. 1597), Ritter (Vit. 1687), Escherbach (Rost. 1775), Calovius (Vit. 1679); on the medical aspects of the death, by Vogler (Helmst. 1673), Westphal (Grypesv. 1771), Richter (Gott. 1757), Kießling (Erlang. 1767), Gruner (Sen., Jen. 1800, Jun., Hal. 1805), Stroud (in English, London, 1847), Bruhier (in French, Paris, 1749), Swieten (Vien. 1778), Hufeland (Germ., Weim. 1791), Taberger (Germ., Hannov. 1829); on the attestation of the by-standers, by Dietelmair (Aldorf, 1749), Schöttgen (German, in Bidermann's *Schulsachen*, iii, 16). For other dissertations on associated incidents, see PASSOVER; PILATE; MOCKERY (OF CHRIST); CROWN (OF THORNS); THIEF (ON THE CROSS); SABACTHANI; ECLIPSE; EARTHQUAKE; VAIL; CENTURION; PRISONER, etc.

Cruciger, CASPAR, one of the most faithful and useful of Luther's coadjutors in the Reformation, was

n at Leipsic Jan. 1, 1504, of religious parents, who k pains with his education. In his sixteenth year embraced the doctrines of the Reformation, and ut 1521 he began to study theology at Wittenberg h Luther and Melancthon. He became profoundly lled in Hebrew. In 1524 he was called to Magde- rg, and there taught with great success till 1527, en he returned to Wittenberg, where he lectured on Scriptures, and aided Luther in his translation of Bible. He was very expert in shorthand writing, d to this faculty we are indebted for many of Lu- r's precious remains. He died in 1548, aged forty- r years. His letters may be found in the *Corpus formatorum*.—Middleton, *Evang. Biog.*; Adam, *Vi- Theologorum*; Piper, *Evangel. Kalender*, 1854; Pree- , *Caspar Cruciger nach gleichzeitigen Quellen* (Elber- dt, 1862).

Cruden, ALEXANDER, author of the well-known *Concordance*, was born in Aberdeen May 31, 1701, and is educated at Mareschal College with a view to the ministry, but aberration of mind caused his temporary confinement in an asylum, and prevented his entering the ecclesiastical career. In 1732 he went to Lon- n, and was employed as a classical tutor and correct- of the press. He was appointed bookseller to the teen, to whom in 1787 he dedicated his *Complete Con- cordance to the Holy Scriptures of the O. and N. Test.*, hich first appeared in that year. Pecuniary difficul- is growing out of the publication of this work now reased his insanity, and led to his temporary con- ement, but he escaped from Bethnal Green, and ough an action against the proprietor and physician ' the asylum, who of course obtained a verdict in eir favor. For the rest of his life he was permitted remain at liberty, and he returned with zeal to his arned and severe labors, manifesting his strange ec- ntricity in a thousand forms—soliciting knighthood on the king, a seat in Parliament from the people ' London, and courting the daughter of the lord ayor, but preserving unchanged his piety and bene- vance. He made a verbal index to Milton's poems, *Scripture Dictionary*, and several religious works, ntinuing to the last the emendation of his *Concord- ice*. Many editions of this work have since ap- ared. On November 1, 1770, he was found dead i his chamber in the attitude of prayer. See CON- ORDANCE.

Crumbaugh, JOHN SAMUEL, a Lutheran minis- r, was born in Frederick County, Md., November 7, 331. He graduated at Pennsylvania College, Gettys- urg, in 1851, and the same year was appointed prin- ipal of the High School, Lancaster, Pa., a position to hich he seemed specially adapted. While thus en- aged, he also pursued his theological studies under he direction of Rev. Dr. Baker, and in 1853 was li- ensed to preach the Gospel. His first and only pas- oral charge was St. John's (Lutheran) Church, Lan- aster. His health, never very vigorous, began to ail under his labors, to which he had so assiduously nd successfully devoted himself. He resigned his harge in 1857, and accepted the office of superintend- nt for common schools of Lancaster County, in the xpectation that an opportunity would be afforded, in he active exercise required, for the resuscitation of is health. His zeal and success in the discharge of is varied and difficult duties were regarded by the oard as unsurpassed. He was a man of more than rdinary ability, and as a teacher possessed peculiar ualifications. He died Jan. 13, 1859. "His brief ife," says Dr. Burrowes, "was a record of learning, usefulness, and honor." He published an address on *God in History*, delivered before the literary societies of Franklin and Marshall College in 1855.

Crusades, the name given to the religious wars carried on from the close of the eleventh to the close of the thirteenth century by the Christian coun- II.—P P

tries of Europe against the Mohammedans for the con- quest of the Holy Land. (In this article we make free use of the article in Chambers's *Encyclopædia*.) From an early period in the history of the Church it was considered a pious act to make a pilgrimage to the Holy Sepulchre, and to visit the various spots which the Saviour had consecrated by his presence. When Palestine was conquered by the Arabs in the seventh century, that fierce but generous people respected the religious spirit of the pilgrims, and allowed them to build a church and a hospital in Jerusa- lem. Under the Fatimides of Egypt, who conquered Syria about 980 A.D., the position both of the native Christian residents and of the pilgrims became less fa- vorable; but the conquest of Jerusalem in 1078, and the subjugation of the country by brutal hordes of Seljuk Turks from the Caucasus, rendered it intolerable. The news of their atrocities produced a deep sen- sation over the whole of Christendom, and kindled a general desire for the liberation of the Holy Land from the hands of the infidels. The popes encouraged this movement to the best of their ability. They saw in it an opportunity to extend the Church, to re-enforce their power, and to turn the warlike ardor of the West- ern princes, which so often led to conflicts between Church and State, against the infidels. In 1073, the Greek emperor, Manuel VII, sent to supplicate the as- sistance of the great pope, Gregory VII, against the Turks, accompanying his petition with many expres- sions of profound respect for his holiness and the Lat- in Church. Gregory cordially responded, but circum- stances prevented him from ever carrying the vast de- signs which he entertained into execution. The idea of a crusade was, however, revived by his successor, Urban II, an able and humane man, whose sympathies were kindled by the burning zeal of Peter the Hermit, a native of Amiens, in France, who had made a pil- grimage to the Holy Land, witnessed the cruelties per- petrated by the Turks, and was now traversing Euro- pe, preaching every where to crowds in the open air, and producing the most extraordinary enthusiasm by his impassioned descriptions of how pilgrims were mur- dered, robbed, or beaten, how shrines and holy places were desecrated, and how nothing but greed restrained the ruffian Turks (who made the Christians pay heavy taxes for their visits to Jerusalem) from destroying the Holy Sepulchre, and extirpating every vestige of Christianity in the land.

First Crusade, 1096-1099.—When, by the addresses of Peter the Hermit and others, the feelings of Europe had been sufficiently heated, two councils were held in 1095, one at Piacenza, in May, and the other at Cler- mont, in France, in November, to organize the war. At the second, at Clermont, a crusade was definitely resolved on. The pope himself delivered a stirring ad- dress to a vast multitude of clergy and laymen, and as he proceeded, the pent-up emotions of the crowd burst forth, and cries of *Deus vult* (God wills it) rose simultaneously from the whole audience. These words, *Deus vult*, by the injunction of Urban, were made the war-cry of the enterprise, and every one that embarked in it wore, as a badge, the sign of the cross; hence the name *Crusade* (Fr. *croisade*, from Lat. *crux*, a cross). From all parts of Europe thousands upon thousands hurried at the summons of the pope to en- gage in the holy war. In May, 1096, the crusade was actually begun by an undisciplined force of about 20,000 foot, commanded by a Burgundian gentleman, Walter the Penniless. It marched through Hungary, but was cut to pieces by the natives of Bulgaria, only a few, among whom was Walter himself, escaping to Constantinople. The second, consisting of 40,000 men, women, and children, was led by Peter the Hermit. It followed the same route as its predecessor, and reached Constantinople greatly reduced. Here the two united, crossed the Bosphorus, and were utterly defeated by the Turks at Nice, the capital of Bithynia.

A third expedition of a similar kind, composed of 15,000 Germans, led by a priest named Gottschalk, was slaughtered or dispersed in Hungary, which also proved the grave of the fourth, a terrible horde, consisting of about 200,000 wretches from France, England, Flanders, and Lorraine, who had swept along through Germany, committing horrible ravages, especially against the Jews, whom they murdered without mercy. Now, however, the real Crusaders made their appearance—the gentry, the yeomanry, and the serfs of feudal Europe, under chiefs of the first rank and renown. Six armies appeared in the field, marching separately, and at considerable intervals of time. Their respective leaders were Godfrey of Bouillon, duke of Lorraine; Hugh the Great, count of Vermandois, and brother of Philippe, king of France; and Robert Curthose, duke of Normandy, the son of William the Conqueror; count Robert of Flanders; Bohemond, prince of Tarentum, son of the famous Guiscard, under whom was Tancred, the favorite hero of all the historians of the Crusade; and, lastly, count Raymond of Toulouse. The place of rendezvous was Constantinople. The Greek emperor, Alexius, afraid that so magnificent a host—there were in all not less than 600,000 men, exclusive of women and priests—might be induced to conquer lands for themselves, cajoled all the leaders, excepting Tancred and count Raymond, into solemnly acknowledging themselves his liegemen. After some time spent in feasting, the Crusaders crossed into Asia Minor (accompanied by the unfortunate Peter the Hermit). Here their first step was the siege and capture of Nice, the capital of Sultan Soliman, June 24, 1097. This monarch was also defeated by Bohemond, Tancred, and Godfrey, at Dorylæum. Baldwin, brother of Godfrey, now crossed into Mesopotamia, where he obtained the principality of Edessa. After some time the Crusaders reached Syria, and laid siege to Antioch. For seven months the city held out, and the ranks of the besiegers were fearfully thinned by famine and disease. Many, even brave warriors, lost heart, and began to desert. Melancholy to relate, among the list of cowards was the poor enthusiast who had planned the enterprise. Peter was actually several miles on his way home when he was overtaken by the soldiers of Tancred, and brought back to undergo a public reprimand. At length, on the 8d of June, 1098, Antioch was taken, and the inhabitants were massacred by the infuriated Crusaders, who were in their turn besieged by an army of 200,000 Mohammedans sent by the Persian sultan. Once more famine and pestilence did their deadly work. Multitudes also deserted, and, escaping over the walls, carried the news of the sad condition of the Christians back to Europe. But again victory crowned the efforts of the besieged. On June 28, 1098, the Mohammedans were utterly routed, and the way to Jerusalem opened. It was on a bright summer morning (1099) that 40,000 Crusaders, the miserable remnant of that vast array which two years before had laid siege to Nice, obtained their first glimpse of Jerusalem. On July 15, after a siege of rather more than five weeks, the grand object of the expedition was realized. Jerusalem was delivered from the hands of the infidel. Eight days after the capture of the city, Godfrey of Bouillon was unanimously elected king of Jerusalem.

Second Crusade, 1047.—In 1144 the principality of Edessa was conquered by the emir of Mosul, and the Christians slaughtered. His son Nouredin advanced to destroy the Latin kingdoms of Syria and Palestine. Europe once more trembled with excitement. A second crusade was preached by the famous St. Bernard, abbot of Clairvaux, in Champagne; and early in 1147 two enormous armies, under the command of Louis VII, king of France, and Conrad III, emperor of Germany, marched for the Holy Land. Their united numbers were estimated at 1,200,000 fighting-men. The expedition, nevertheless, proved a total failure.

The Greek emperor, Manuel Comnenus, was head and through the treachery of his emissaries the army of Conrad was all but destroyed by the Turks at Iconium, while that of Louis was wrecked in the files of the Pisidian Mountains. After a vain attempt to reduce at first Damascus and subsequently Jerusalem, the relics of this mighty host returned to Europe.

Third Crusade, 1189-1192.—The death-blow to the kingdom of Jerusalem was given by Salah-Eddin, commonly called Saladin, a young Kurdish chief who had made himself sultan of Egypt, and who asserted the presidency of the Mohammedan world, in October, 1187, Jerusalem itself capitulating after a siege of fourteen days. The news of this led to a third crusade, the chiefs of which were Frederick I (Barbarossa), emperor of Germany, Philippe Auguste, king of France, and Richard *Cœur-de-Lion*, king of England. Barbarossa took the field first in the spring of 1189, but accidentally lost his life by fever caught while bathing in the Orontes. His army, much reduced, joined the forces of the other two monarchs before Acre (or Ptolemais), which important city was immediately besieged, and after a beleaguering of twenty-three months surrendered. But the Crusaders were not united among themselves. Philippe soon after returned to France; and Richard, after accomplishing prodigies of valor, which excited the admiration of the Saracens, concluded a treaty with Saladin, by which "the people of the West were to be at liberty to make pilgrimages to Jerusalem, exempt from the taxes which the Saracen princes had in former time imposed." On October 25, 1192, Richard set sail for Europe.

Fourth Crusade, 1203.—In 1203 a fourth expedition was determined upon by pope Innocent III, although the condition of the Christians was by no means such as to call for it. It assembled at Venice, the government of which republic, from political reasons, promised to support the movement by its navy. The army never went to Palestine at all, but preferred to take possession of the Byzantine empire. The leader of this host of *pseudo-Crusaders*, Baldwin, count of Flanders, was seated on the throne of the East in 1204, where he and his successors maintained themselves for fifty-six years. Some writers do not number this expedition among the regular crusades, but count as the fourth crusade another expedition, in 1217, which king Andrew II of Hungary was prevailed upon by pope Honorius III to undertake. He was supported by the kings of Jerusalem and Cyprus, conquered a fortress on Mount Tabor and some small forts, but in 1218 returned home. In the same year count William of Holland, being allied with the kings of Jerusalem and Cyprus, landed in Egypt. He conquered in 1219 Damietta, but in 1221 this town and all other conquests were lost again.

Fifth Crusade, 1228-1229.—This was commanded by Frederick II, emperor of Germany. It began in 1228, and terminated in a treaty of ten years between that monarch and the sultan of Egypt, by which Palestine was ceded to Frederick, who, after being crowned king of Jerusalem in 1229, returned to Europe, leaving his new possessions in a state of tranquillity.

Sixth Crusade, 1248.—In 1244 a new race of Turks burst into Syria, and once more the Holy Land fell into the hands of these ferocious barbarians. Jerusalem was burned and pillaged. In 1248, Louis IX of France (St. Louis) headed a crusade against them. At the head of 40,000 soldiers he embarked from Cyprus, and from there went to Egypt, conquering the coast and the town of Damietta, but when he advanced further he was utterly defeated, and taken prisoner by the sultan of Egypt. By the payment of a large ransom he obtained his liberty (1250), and that of the other prisoners. On his return to Europe he was regarded as a sort of martyr in the cause of Christ.

Seventh Crusade, 1270.—This also was primarily un-

straken by St. Louis, but he having died at Tunis in 1200, on his way to Palestine, prince Edward of England, afterwards Edward I, who had originally intended to place himself under the command of St. Louis, marched direct for Palestine, where his rank and reputation in arms gathered round him all who were willing to fight for the Cross. Nothing of consequence, however, was accomplished, and Edward soon returned to England, the last of the Crusaders. Acre, Nicosia, and Tripoli still continued in the possession of the Christians, and were defended for some time by the Templars and other military knights; but in 1291 Acre capitulated, the other towns soon followed its example, and the knights were glad to quit the country, and disperse themselves over Europe in quest of new employment, leaving Palestine in the undisturbed possession of the Saracens.

Since that time there have been no further crusades, though the popes have more than once attempted to excite the Christians to the undertaking. Some writers do not hesitate to affirm that the popes, under this evic, aimed at universal power over the kings and armies employed in their service, which were numerous, because a plenary indulgence was the reward of a crusader. The Christian princes were exhausted in the struggle, while the pope became omnipotent both over clergy and people. The people sold their property for a mere trifle, or made a gift of it to monasteries and abbeys. It is computed that nearly two millions of Christians lost their lives during the crusades by laughter, hunger, pestilence, etc.

It is impossible to overlook the fact that, in some respects, the crusades exercised a most beneficial influence on modern society. M. Guizot, in his *Lectures on European Civilization*, endeavors to show their design and function in the destinies of Christendom. "To the first chroniclers," he says, "and consequently to the first Crusaders, of whom they are but the expression, Mohammedans are objects only of hatred: it is evident that those who speak of them do not know them. The historians of the later crusades speak quite differently: it is clear that they look upon them no longer as monsters; that they have to a certain extent entered into their ideas; that they have lived with them; and that relations, and even a sort of sympathy, have been established between them." Thus the minds of both, but particularly of the Crusaders, were partly delivered from those prejudices which are the offspring of ignorance. "A step was taken towards the enfranchisement of the human mind." Secondly, the Crusaders were brought into contact with two civilizations, richer and more advanced than their own—the Greek and the Saracenic; and it is beyond all question that they were mightily struck with the wealth and comparative refinement of the East. Thirdly, the close relationship between the chief laymen of the West and the Church occasioned by the crusades enabled the former "to inspect more narrowly the policy and motives of the papal court." The result was very disastrous to that spirit of veneration and belief on which the Church lives, and in many cases an extraordinary freedom of judgment and hardihood of opinion were induced, such as Europe had never before dreamed of. Fourthly, great social changes were brought about. A commerce between the East and West sprang up, and towns—the early homes of liberty in Europe—began to grow great and powerful. The crusades, indeed, "gave maritime commerce the strongest impulse it had ever received." As the crusades were a rising of the Christian nations of Europe for the triumph of the Church under the direct control of the popes, they naturally gave a powerful influence to the hierarchical plans of the popes. The emperors and kings, by following the exhortations of the popes and taking the cross, acknowledged the claims of the popes that the ecclesiastical power was higher than the secular. As the popes did not person-

ally join the crusades, but were represented by legates, the system of papal legates was developed, which became in the hands of the popes a powerful weapon for curtailing the jurisdiction of archbishops and bishops. The origin of bishops in *partibus infidelium* can also be traced to the crusades. The raising of immense armies was a good pretext for the popes to extort large sums of money from princes and nations. The warlike enthusiasm against the Mohammedans kindled the popular fanaticism against all heretics, and stimulated the bloody persecutions of the Cathari, Waldenses, and other sects in Western Europe.

The influence of the crusades upon scientific theology was only indirect. The better acquaintance with the philosophical and theological literature of the Greek Church and the Mohammedans could but yield a favorable influence. In particular, the study of Aristotle was greatly promoted by the crusades, and several of his works were then first made known in the western countries of Europe. See Chambers, *Cyclopaedia*, s. v.; Brockhaus, *Conversations-Lex.* ix, 76; *Christian Remembrancer*, xlv, 5; Herzog, *Real-Encyclop.* viii, 68; Mosheim, *Church History*, ii, 112, 141, 238, etc.; Milman, *Latin Christianity*, vol. iv; Wilken, *Geschichte der Kreuzzüge* (Leips. 1807-26, 4 vols.); Michaud, *Histoire des Croisades* (Paris, 1825; translated by Robson, London, 8 vols. 12mo, 1854); Mills, *History of the Crusades* (Lond. 1828, 4th ed. 2 vols. 8vo); Koightley, *The Crusades* (London, 1847, 2 vols. 12mo); Hume, *History of England*, i, 226 et al.; ii, 60 et al.; Hase, *Ch. Hist.* p. 196, 220, 269; Sybel, *Geschichte des ersten Kreuzzuges* (Leipsic, 1841); Kugler, *Studien zur Geschichte des zweiten Kreuzzuges* (Stuttgart, 1866). A list of writers on the subject is given by Michaud, *Bibliothèque des Croisades* (Paris, 1830, 4 vols.).

Cruse. This now obsolete English word denotes a small vessel for holding water or other liquids. Three Hebrew words are thus translated in the A. V. See *Cup*.

1. כַּדִּיחַ, *tsappach'ath* (lit. something spread out), is applied to a utensil (usually considered a *flask*, but more probably a shallow *cup*) for holding water (1 Sam. xxvi, 11, 12, 16; 1 Kings xix, 6) or oil (1 Kings xvii, 12, 14, 16). Some clew to the nature of this vessel is perhaps afforded by its mention as being full of water at the head of Saul when on his night expedition—after David (1 Sam. xxvi, 11, 12, 16), and also of Elijah (1 Kings xix, 6). In a similar case in the present day this would be a globular vessel of blue porous clay—the ordinary Gaza pottery—about nine inches diameter, with a neck of about three inches long, a small handle below the neck, and opposite the handle a straight spout, with an orifice about the size of a straw, through which the water is drunk or sucked. The form is common also in Spain, and will be familiar to many from pictures of Spanish life. A similar globular vessel probably contained the oil of the widow of Zarephath (1 Kings xvii, 12, 14, 16). For the "box" or "horn" in which the consecrated oil was carried on special occasions, see *OIL*. Some writers have supposed that the cruse of water mentioned in the first passage (when Saul's life was spared by David) was a *clepsidra*, or one of those water-watch measures used by the ancients, by which time was



Modern Oriental Travelling Flasks.

measured by the falling of water from one vessel into another, the undermost vessel containing a piece of cork, the different altitudes of which, as it gradually rose upon the rising water, marked the progress of time. But we can hardly suppose that such time-measures were known at that early period. It is usual for persons in the East in the present day, when they travel, to take with them a flask for holding water, and also, when they sleep in the open air, to have a small vessel of water within their reach (Thomson, *Land and Book*, ii, 21). These flasks are of various forms, and are sometimes covered with a wicker-case, See DISH.

2. פִּתְיֹת, *babuk'* (from the gurgling sound in emptying), perhaps a *bottle* (as it is translated in Jer. xix, 1, 10) for holding any liquid, as honey (1 Kings xiv, 8), but more probably a *PITCHER* (q. v.).

3. צֶלֶחַיִת, *tselochith'* (lit. that into which fluids are poured out), a *platter* (2 Kings ii, 20). This was probably a flat metal saucer of the form still common in the East. It occurs in 2 Kings ii, 20, "cruse;" xxi, 18, "dish;" 2 Chron. xxxv, 13, "pan;" also Prov. xix, 24; xxvi, 15, where the figure is obscured by the choice of the word "bosom." See PAN; PLATTER, etc.

CRUSÉ, CHRISTIAN F., D.D., a minister of the Protestant Episcopal Church, was born June 27, 1794, in Philadelphia, of Lutheran parentage. He entered the University of Pennsylvania in 1812, and graduated Jan. 10, 1815, with distinguished honors. He was appointed professor in the University in 1831, and resigned in 1833. He was ordained by bishop White about 1822; became rector of Trinity Parish, Fishkill, N.Y., in April, 1846, but resigned the cure in 1851, and afterwards had no parish. He soon after removed to the General Theological Seminary, where, as librarian, he had ample opportunities for those studies in which he was so successful. In the ancient languages—Syriac, Hebrew, and Greek—Dr. Crusé was very well informed. He translated and edited Eusebius's *Church History*, and his edition is the best in English. He died in New York October 5, 1865.—*Church Review*, January, 1866.

CRUSIUS, CHRISTIAN AUGUST, a German theologian, was born at Leuna, near Merseburg, January 10, 1715. He studied at Leipzig, where he afterwards became professor of philosophy in 1744, of theology in 1750, and primarius of theology in 1757. He died October 18, 1775. Dissatisfied with the existing philosophical systems, he attempted a new one, which he sought to bring into harmony with orthodox theology. The school which he represented in Leipzig may be designated by the name of a Philosophico-Biblical Realism. As a philosopher, he was one of the most important opponents of the idealism and mechanism of the Leibnitz-Wolffian philosophy, while, as a Bible theologian, he maintained the historical and literal as opposed to an exclusively spiritualistic exegesis. In *morals* "he drew his conclusions, not from the conceptions of the intellect, but the suggestions of the will and conscience. He derived the notion of duty from moral necessity or obligation. He asserted the free-agency of the human mind (which he contemplated principally in a negative point of view, i. e. as uninfluenced by physical or material laws), and developed the formal conditions of our free-will actions and the motives of them. The principle of a moral law led him to that of a moral Governor and Legislator, and consequently to the hypothesis which ascribes all moral obligations and laws to the divine authority, deducing, as the schoolmen had done, the principles of morals from the will of God. That which is consistent with the nature of the divine perfections, and accords with the designs of God, is good, and becomes obligatory on all rational beings. God demands of his rational creation, in the first place, that they should

be good; and also wills their happiness as a consequence of virtue" (Tennemann). His principal works are: *Logik o. d. Weg s. Gewissheit u. Zuverlässigkeit des menschlichen Erkenntnis* (Lpz. 1747; 2d ed. 1762; *Erwurf d. nothwendigen Vernunftwahrheiten* (Lpz. 1748; 8d ed. 1766); *Ansicht, vernünftig z. leben* (Lpz. 1748; 3d ed. 1767); *Ableitung, u. natürliche Begebenheiten d. deutlich u. vorsichtig nachzudenken* (Lpz. 1749; 2 vol. 1772); *Begriff d. christlichen Morallehrlehre* (Lpz. 1772, 2 vols.). See *Pierer, Universal-Lexikon*, s. v.; Kuhn, *German Protestantism* (Edinb. 1856, 12mo, p. 16); Delitzsch, *Die biblisch-prophetische Theologie, ihre Entwicklung durch Chr., Erläuterung*, etc. (Lpz. 1845); Tennemann, *Manual Hist. Phil.* § 368.

Cryer, THOMAS, a Wesleyan missionary of great piety and usefulness, was born at Bingley, in Yorkshire, in 1800. At 20 he was converted, and was called to the ministry about seven years after, and labored for few months in an English circuit. He was then appointed a missionary to India, and embarked for that country in 1829. For 22 years he labored for the salvation of the heathen, and his name will be long remembered in the East. In spite of opposition and of the long delay of prosperity, which is the great and peculiar trial of the Eastern missionary—in spite of the most acute personal and family afflictions, his heart was undaunted and his faith unshaken. Few of his fellow-missionaries excelled him in power of endurance, in the adroitness and effect with which he exposed the sophisms of the Brahmin, or in searching and persuasive appeals to the conscience. He "determined to know nothing but Christ and him crucified." Such a minister could hardly fail of winning souls; and many will be the crown of his rejoicing in the day of Jesus Christ, not only from among the natives of India, but also from among the Europeans resident in that country. He died of cholera, October 5, 1852.—*Wesleyan Minutes*, 1853.

Crypt (Gr. κρυπτή, a concealed place; Lat. *crypta*; Fr. *crypte*).

I. Among the ancient Greeks and Romans a *crypt* was primarily a long, narrow gallery, above the level of the ground, surrounding a court-yard, and having walls on both of its sides, with windows in the wall facing the court. These crypts had often a portico lining them or running between them and the open court. They served as a place of promenade during the heat of a wet weather, and were finally so extensively used that they were even built for the officers near the Prætorian camps in Rome. Crypts similar in construction and location were built for storing wines, vegetables, and other articles, like the modern subterranean cellar. When all the windows were closed they were dark and cool, and hence the word was applied even by the ancients to any dark and long chamber or passage, as the dark stables where horses were kept under the amphitheatre, the *cloaca maxima* at Rome, the tunnel at Naples, and to a grotto where Quarta offered sacrifice.

II. The word *crypt* was applied by the early Christians to those subterranean burial-places which were afterwards called Catacombs (q. v.). The term was later limited to the larger chambers in the Catacombs where one or more martyrs were buried. These crypts were larger than the other rooms in the Catacombs, and were often ornamented, and devoted to divine worship. For this purpose they were double, one part serving for the men and the other for the women, with small antechambers for the catechumens. Some of these crypts had openings into the fields above.

III. When persecution ceased, and Christians built church edifices above ground, the custom was adopted of placing the remains of martyrs—later of archbishops, bishops, abbots, and other high church officials—in crypts under the intersection of the cross in the plan of the church. In the Basilican period of architecture

see crypts were often called by the name *confessio*, the Romanesque period the name crypt was remed. In the churches of this period, the crypt extended under the high altar and back under the entire choir or apsis, sometimes even including the space under the transept. This crypt formed almost a separate church, and caused the floor above it of the main body of the church to be raised higher than that of the nave, which the audience had access. Churches founded the latter part of the Romanesque period, and thereafter, had no crypts. The reason of their disappearance from church architecture is not well understood. Lübke, *Geschichte der Architektur*; Rich, *Dictionary of Greek and Roman Antiquities*.

Crypto-Calvinistic Controversy, the name given to a dispute within the Lutheran Church of Germany (1552-1574) concerning the doctrine of the Lord's supper. The followers of the Melancthonian doctrine, distinguished from the strict Lutherans, were styled *crypto-Calvinists* (also Philippists, Melancthonians).

1. Melancthon, it is well known, earnestly desired union of the Lutheran and Calvinistic divisions of the Protestant body. His tendency towards the Calvinistic view of the Lord's Supper was early shown in his difference between the Augsburg *Confessio invariata* (1530) and the *variata* (1542). In the former, art. 10, *de cena Domini*, it is stated that the "body and blood of Christ are truly present in the Lord's Supper in the form of bread and wine), and are there distributed and received (distribuuntur *vescentibus*); therefore the opposite doctrine is rejected." In the *variata* (Latin of 1540) the reading is "*cum pane et vino vere exhibetur corpus et sanguis Christi vescentibus in cena Domini*." The condemnation of the "opposite doctrine," i. e. the Zwinglian, is omitted. This alteration did not meet the approbation of Luther, who nevertheless tolerated Melancthon's change of doctrine. But many Lutherans (e. g. Flacius, q. v.) were less tolerant; and during Melancthon's lifetime he was held by many to be a concealed (crypto-) Calvinist. The truth seems to be fairly stated by Hase, as follows: "As Melancthon was convinced that neither Luther's nor Calvin's doctrine of the sacrament was an insuperable bar to saving communion with Christ, he thought he might allow both of them to continue in the Church. But when the doctrine of the omnipresence of Christ's body (ubiquity, q. v.) was proposed as the only saving basis of the Holy Supper, and made, by Brentz (see BRENTZ), the law of the Church in Württemberg, he expressed disapprobation of such novel doctrines in provincial Latin being introduced into the symbols of faith" (*Church History*, § 850). Melancthon and Luther never quarrelled on the subject; but the controversy, even during Melancthon's lifetime, began to be bitter. He did not live, however, to see the fierce strife which finally arose on the subject within the bosom of the Church (died 1560).

2. But the controversy, as such, began in the year 1552, when Joachim Westphal, a preacher in Hamburg, proclaimed the Calvinistic doctrine of the Lord's Supper heretical. The controversy was especially violent at Bremen, between Tilemann Heshusius and Albert Hardenberg, cathedral preacher, who acted for the Calvinistic doctrine, and it went on until Hardenberg was dismissed from his position. Shortly after Heshusius shared a like fate. In 1558 Heshusius was made general superintendent at Heidelberg, and he soon detected "Crypto-Calvinism" in deacon Wilhelm Kriebitz. In both cities Lutheranism was finally expelled, and Frederick III, elector of the Palatinate, went over to the Reformed Church. In Württemberg Brentz urged the ultra-Lutheran doctrine (see above); but Christoph, duke of Württemberg, endeavored to allay the strife, and finally succeeded, in 1561, at the Fürstentag (Diet of Princes) at Naumburg, in obtaining the recognition of the altered Augsburg Confession.

The elector Frederick III of the Palatinate withdrew from the controversy, and introduced, in 1563, in his dominions a mixed doctrine of Melancthonian tendency, by the incorporation of the Heidelberg Catechism into the state law.

In the Saxon electorate the Wittenberg and Leipzig theologians undertook a like combination of the doctrines. Kaspar Peucer, son-in-law of Melancthon, Cracow, Schütz, and Stössel; G. Major, P. Eber, Paul Crell, and, later, P. Cruciger, Pezel, Moller, and others, in their writings, and also in the well-known Catechism, favored the view, and these Melancthonian theologians were called Philippists. The Thuringian theologians in Jena, especially Flacius, also Wigand, Cölestrin, Kirchner, and others, were strict Lutherans, and bitterly opposed the electorate Saxons. A conference between the Wittenberg and Jena theologians was held at Altenburg (October, 1568, to March, 1569), in which very intemperate accusations were made against the Philippists. The rupture was widened. The electoral duke Augustus of Saxony called his theologians together in Dresden on the 7-10th of October, 1571. They agreed upon the *Consensus Dresdensis* and the *Wittenberg Catechism*, which opposed the doctrine of ubiquity, but used Lutheran language in moderate terms, Melancthonian in spirit; for the time it was thought that the strife was ended. But in 1574 appeared an anonymous work entitled *Exegesis perspicua et ferme integra controversiæ de sacra cena*, which strongly advocated the Calvinistic view of the Supper. (It has been shown by Heppé, *Geschichte des deutsch. Prot. II*, 468, that this work was written by the physician Joachim Cureus [died 1578], and was not originally intended for publication.) The work caused a bitter renewal of the controversy, and the elector determined to suppress Calvinism, and he deposed or imprisoned the leaders, and commanded subscription to the Confession of Torgau (May, 1574). Peucer was imprisoned for twelve years. In 1586 the elector died, and his son, Christian I, succeeded him. Chancellor Nicolas Crell (q. v.) and others influenced him to favor the Calvinistic view. After his death, the duke Frederick William of Saxe-Weimar, who was regent, put down Philippism by brute force, even executing Crell in 1601. See Löscher, *Hist. motum*, 1728; Heppé, *Geschichte des deutschen Protestantismus*, 1852, 2 vols.; *Zeitschr. f. d. hist. Theol.* 1865, iv; Gieseler, *Church History* (Smith's), iv, § 87, 88; Gass, *Geschichte d. prot. Theol.* i, 68 sq.; Hagenbach, *History of Doctrines*, § 215; Herzog, *Real-Encyclop.* viii, 127.

Crystal. There are several words which appear to have this meaning in the Bible. See ICE; PEARL.

1. קָרַח, *ke'rach* (properly *ice*, as it is rendered Job vi, 16; xxxviii, 29; "frost," Gen. xxxi, 40; Job xxxvii, 10; Jer. xxxvi, 30; Sept. κρύσταλλος), occurs in Ezek. i, 22, where the epithet "terrible" seems to be added by way of distinction from the ordinary signification of the word.

2. גַּבִּישׁ, *gabish'* (properly *ice*; Sept. γαβίς), occurs only in Job xxviii, 18, where it is rendered "pearls" in our version.

3. נְקִיבִירָה, *nekiybirah'* (lit. what is *pure* or transparent; Sept. ὕλος), occurs only in Job xviii, 17, where some regard it as denoting *glass*.

4. Κρύσταλλος (prop. *ice*) occurs in Rev. iv, 6; xxi, 11; xxii, 1, evidently in the sense of *crystal*, and in such connections as to identify it in a good degree with the preceding terms.

"Crystal was anciently held to be only pure water, congealed by great length of time into ice harder than the common (Diod. Sic. ii, 52; Plin. *Hist. Nat.* xxxvii, 2), and hence the Greek word for it, in its more proper signification, also signifies ice. From this it necessarily followed that crystal could only be produced in the regions of perpetual ice, and this was accordingly the ancient belief; but we now know that it is found

in the warmest regions. Theophrastus (54) reckons crystal among the pellucid stones used for engraved seals. In common parlance we apply the term *crystal* (as the ancients apparently did) to a glass-like transparent stone, commonly of a hexagonal form, which, from being found in rocks, is called by mineralogists rock-crystal. It is a stone of the flint family, the most refined kind of quartz" (Kitto). See GLASS.

Cubit (in Heb. *אמה*, *ammah*, lit. *mother*, i. e. of the arm, the *fore-arm*; Greek *πῦχυς*, an *el*) is a word derived immediately from the Latin *cubitus*, the lower arm. The length of the cubit has varied in different nations and at different times. Derived as the measure is from a part of the human body, and as the human stature has been of very dissimilar length, the cubit must of necessity have been various. The lower arm, moreover, may take in the entire length from the elbow to the tip of the third or longest finger, or it may be considered as extending from the elbow merely to the root of the hand at the wrist, omitting the whole length of the hand itself. If the definition of Celsus (viii, 1) is taken, and the cubit is identified with the *ulna*, the under and longer of the two bones of which the arm consists, still a fixed and invariable measure is not gained. That the cubit among the Hebrews was derived as a measure from the human body is clear from Deut. iii, 11—"after the cubit of a man"

(*אמה אמה*, see Böttcher, *Proben alttest. Schrift.* p. 288). But it is difficult to determine whether this cubit was understood as extending to the wrist or the end of the third finger. As, however, the latter seems most natural, since men, when ignorant of anatomy, and seeking in their own frames standards of measure, were likely to take both the entire foot and the entire fore-arm, the probability is that the longer was the original cubit, namely, the length from the elbow to the extremity of the longest finger. The Egyptian cubit, which it is likely the Hebrews would adopt, consisting of six hand-breadths, is found on the ruins of Memphis (*Journal des Savans*, 1822, Nov., Dec.; comp. Herod. ii, 149). The Rabbins also (Mishna, *Chelim*, xvii, 9) assign six hand-breadths to the Mosaic cubit. By comparing Josephus (*Ant.* iii, 6, 5) with Exod. xxv, 10, it will, moreover, be found that the weight of his authority is in the same scale. According to him, a cubit is equal to two spans. Now a span is equal to three hand-breadths (Schmidt, *Bibl. Mathemat.* p. 117; Eisen-Schmidt, *De Ponderibus*, p. 110); a cubit, therefore, is equal to six hand-breadths. The hand-breadth is found as a measure in 1 Kings vii, 26; comp. Jer. lii, 21. In the latter passage the finger-breadth is another measure. The span also occurs Exod. xxviii, 16. So that, it appears, measures of length were, for the most part, borrowed by the Hebrews from members of the human body. Still no absolute and invariable standard presents itself. If the question, What is a hand or finger-breadth? be asked, the answer can be only an approximation to fact. If, however, the palm or hand-breadth be taken at 8½ inches, then the cubit will amount to 21 inches. In addition to the common cubit, the Egyptians had a longer one of six palms four inches. The Hebrews also have been thought to have had a longer cubit, for in Ezek. xl, 5, we read of a cubit which seems to be an ordinary "cubit and an hand-breadth;" see also Ezek. xliii, 18, where it is expressly said, "the cubit is a cubit and an hand-breadth." The prophet has been supposed to refer here to the then current Babylonian cubit, a measure which it is thought the Jews borrowed during the period of their captivity. The Rabbins make a distinction between the common cubit of five hand-breadths and the sacred cubit of six hand-breadths—a distinction which is held to be insufficiently supported by De Wette (*Archäologie*, p. 178). Consult Lamy, *De Tabernaculo*, c. 8; Carpov, *Apparat.* p. 678.—Kitto, s. v. An ancient Egyptian cubit now in the Royal Museum of Paris

measures 20.484 inches. The Hebrew cubit, according to Bishop Cumberland and M. Pelletier, is twenty-one inches; and the Talmudists observe that the Hebrew cubit (meaning probably the longer or sacred measure) was larger by one quarter than the Roman, which would make it contain 21.843 inches. Many writers fix it at eighteen inches, confounding it with the Greek and Roman measure of a foot and a half. The most approved computation assigns each kind of Jewish cubits the same length as the corresponding Egyptian, namely, 20.24 inches for the ordinary and 21.888 for the sacred, which is confirmed by the mean length of several ancient cubits marked on Egyptian monuments (Wilkinson's *Anc. Egyptians*, 2d series, i, 30), by a comparison of the dimensions of the Pyramids with those given in ancient authorities (Vyse's *Pyramids of Gizeh*, iii, 104, 105), and which we shall find to correspond remarkably with the Talmudical statement of the circuit of the Temple. In a later edition of his *Ancient Egyptians*, however ("Papiri Account," ii, 258), Wilkinson makes the ordinary Egyptian cubit to have consisted of seven palms or twenty-eight digits, and gives nine exact computations of its length, varying from 20.4729 to 20.7484 inches, which yield an average of 20.6169 inches; and he states the cubit on the Nilometer at Elephantine, from actual measurement, to be 20.625 inches. This last is perhaps the most accurate dimension attainable for the standard cubit. (See Böckh, *Metrol. Untersach.* Berl. 1838, p. 12; Thenius, in the *Stud. u. Krit.* 1846, i, 70-ii, 299; Lepsius, *Die alt-ägyptische Elle*, Berl. 1851.) See METROLOGY.

In Judg. iii, 16, the term translated "cubit" is in the original *גומד*, *go'med* (literally, a *cut*), a rod or staff, as the measure of a cubit. In the New Testament our Lord characteristically employs the term cubit (Matt. xxvii, 6; Luke xii, 26) for the enforcement of a moral and spiritual lesson. The term also occurs in John xxi, 8, and in Rev. xxi, 17; and in the Apocrypha (2 Macc. xiii, 5). See MEASURE.

Cuculus. See KAUTZ.

Cuckoo (*קוקו*, *shach'aph*, prob. from its *loquax*: Sept. and Vulg. *sea-gull*; A. V. "cuckow") occurs only in Lev. xi, 16; Deut. xiv, 15, among birds of prey not clearly identified, but declared to be unclean. None of the various ancient or modern versions of this word give a bird possessing any affinity with the other species enumerated; and although the cuckoo is a winter and spring bird, distinctly heard, it appears, by Mr. Buckingham, early in April, while crossing the mountains between Damascus and Sidon, at that time covered with snow, it could scarcely deserve to be included in the prohibited list, for the species is everywhere scarce. The identifications proposed by late writers on the subject all equally lack a sufficient foundation. Bochart (*Hieros.* vol. ii, c. 18) thinks the *sea-gull* is meant. Upon the whole, while so much obscurity still remains on the subject, the interpretation of "cuckoo" may as well remain undisturbed. (See *Penny Cyclopædia*, s. v.) The word *shach'aph* was a



Common Cuckoo (*Cuculus Canorus*).

good imitation of the dissyllabic voice of this bird, as in our word *cuckoo*, variously repeated in all European languages, and *yakob*, which the bird is supposed by the Arabs to utter. The latter, indeed, call it *tir el-yakub*, or "Jacob's bird," on this account (Kitto, *Phys. Hist. of Palest.* p. ccccliii). The common cuckoo (*Cuculus canorus*) is a bird of considerable size, unfit for food, because habitually feeding on reptiles and large insects. It is spread over the whole of Asia and Africa as well as Europe, migrating northward in spring, and probably not breeding in Palestine, although passing the winter there. The American cuckoo (*Erythrophis Americanus*), often called "cow-bird," is a different species of the family of the *Cuculidae*, all the members of which are distinguished by laying their eggs in the nests of other birds, and rearing no young themselves.—Kitto, s. v.; Fairbairn, s. v.



Eastern Black Cuckoo (*Eudynamis Orientalis*).

Cucullus. See COWL.

Cucumber is the translation of כֶּשֶׂה, *kishshu'* (so called probably from its difficulty of digestion; Sept. *oivoc*), in our Auth. Vers., and the correctness of this rendering has been almost universally admitted. It occurs in Num. xi, 5, where the Israelites, when in the desert, express their longings for the melons and the cucumbers of Egypt. The Heb. is so similar to the Arabic *kissa* that there can be very little doubt of their both meaning the same thing. Celsus (*Hierobot.* ii, 247) gives *keta*, *kati*, and *kusaia* as different pronunciations of the same word in different Oriental languages. It does not follow that these names always indicate exactly the same species, since in the different countries they would probably be applied to the kinds of cucumber most common, or perhaps to those which were most esteemed in particular localities. Thus, in Egypt (see Prosp. Alpin, *Plant. Eg.* c. 38, p. 54), the name *kati* appears to be applied to the species which is called *Cucumis chate* by botanists, and "queen of cucumbers" by Hasselquist, who describes it as the most highly esteemed of all those cultivated in Egypt (*Trav.* p. 258). See MELON. In India the name *kissa* is applied by the Mohammedans to the *Cucumis utilisimus*, or the common *kukree* of the natives, while in Persia and Syria the same name would probably be applied only to the common cucumber, or *Cucumis sativus*, as the two preceding species are not likely to

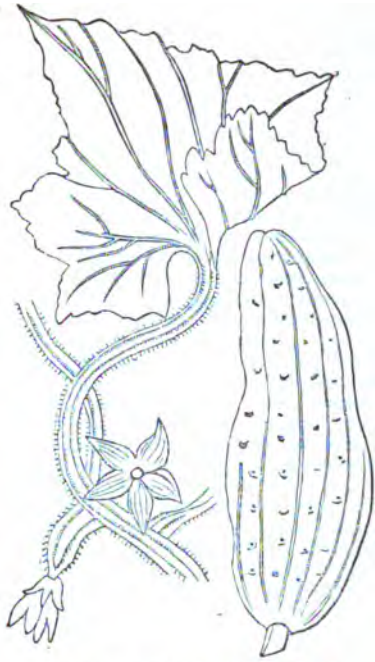

Syrian Cucumber (*Cucumis sativus*).

be much known in either country. The Talmudists (*Maaser.* i, 4; *Terumoth.* ii, 6; vi, 6; *Baba Mez.* vii, 5) have קֶשֶׂה, and the Phœnicians had the word *Kovaiμελαο* (*Diosc.* iv, 152), which is probably קֶשֶׂה רִצִּי, "cucumber of Egypt" = *oivoc ayrioc*. The same name for cucumber exists in all cognate languages. (For an account of the cucumbers of Syria and Egypt, see Forskal, *Flora Egypt.* p. 169; Celsii *Hierobot.* ii, 249.) See BOTANY.

All travellers in the East notice the extensive cultivation and consumption of cucumbers and other vegetables of the same tribe, especially where there is any moisture of soil, or the possibility of irrigation (see Burckhardt, *Arabic Proverbs*, No. 660). Thus, even in the driest parts, the neighborhood of a well is often occupied by a field of cucurbitaceous plants, generally with a man or boy set to guard it from plunder, perched up on a temporary scaffolding, with a slight protection from the sun, where he may himself be safe from the attacks of the more powerful wild animals. That such plants appear to have been similarly cultivated among the Hebrews is evident from Isa. i, 8, "The daughter of Zion is left like a cottage in a vineyard, like a lodge in a garden of cucumbers" (מִקְשָׁה, *mikshah'*, Sept. *σκυήπαρον*), as well as from Baruch vi, 70, "as a scarecrow in a garden of cucumbers (*σκυήπαρον*) keepeth nothing, so are their gods of wood."—Kitto. See GARDEN; COTTAGE.

Cud (רִיחַ, *gerah'*, *rumination*), the pellet of half-chewed food brought up from the first stomach of ruminant animals to be thoroughly masticated (*Lev.* xi, 8-7, 26; *Dent.* xiv, 6-8). See CLEAN (ANIMALS).

Cudworth, RALPH, an eminent English divine and philosopher, was born at Aller, Somersetshire, in 1617, and entered Emmanuel College, Cambridge, in 1630, became M.A. 1639, rector of N. Cadbury 1641, and master of Clare Hall 1644. In 1645 he became professor of Hebrew; in 1654, master of Christ Col-

lege; in 1662, vicar of Ashwell; and in 1678, prebendary of Gloucester. He died in 1688. Cudworth was a Platonist, of "great strength of genius and vast compass of learning." His reputation as a writer rests chiefly on his *True Intellectual System of the Universe*, which appeared in 1678 as the first part of a still greater work which he never completed. It is a defence of human liberty, and of belief in God, against fatalism and atheism. Cudworth describes three false systems or hypotheses of the universe in the preface: "Of the three fatalisms or false hypotheses of the universe mentioned in the beginning of this book, one is absolute atheism, another Immoral theism, or religion without any natural justice and morality (all just and unjust, according to this hypothesis, being mere ethical or factitious things, made by arbitrary will and command only); the third and last such a theism as acknowledges not only a God or omnipotent understanding Being, but also natural justice and morality, founded in him, and derived from him; nevertheless, no liberty from necessity anywhere, and therefore no distributive or retributive justice in the world." Before erecting the true intellectual system of the universe (the epithet *intellectual* being used, as he tells us, "to distinguish it from the other, vulgarly so called, systems of the world, that is, the visible and corporeal world, the Ptolemaic, Tychoinic, and Copernican"), it was his object to demolish these false systems. And the first of them, atheism, or the atheistic fate, is demolished in the first part of the "Intellectual System." It is a work of great learning and acuteness. In attacking the atheistic faith, Dr. Cudworth describes the atomic physiology, which, as held by Democritus, and other ancient philosophers, involved atheism. For the better confutation of other forms of atheism, to which he gives the names Hylzoic and Cosmo-plastic, he makes the hypothesis of an "artificial, regular, and plastic nature," working in complete subordination to the Deity. And to avert an argument brought against the oneness of the Deity, from its unnaturalness as shown by the general prevalence of polytheism among the pagan nations, he contends that "the pagan theologers all along acknowledged one sovereign and omnipotent Deity, from which all their other gods were generated or created," and that their polytheism was but a polyonymy of one God. The *Treatise on Eternal and Immutable Morality* corresponds to the second part of the *Intellectual System*. It is directed against Hobbes and those who, with him, "affirm justice and injustice to be only by law, and not by nature." Besides the *Intellectual System*, Cudworth published, 1. *A Discourse concerning the true Notion of the Lord's Supper*, in which he maintains, as Warburton has since maintained, that the Lord's Supper is a feast upon a sacrifice:—2. *The Union of Christ and the Church Shadowed*:—3. *A Sermon on John ii, 8, 4*, preached in 1647 before the House of Commons:—4. *A Sermon preached in 1664 at Lincoln's Inn on 1 Cor. xv, 57*:—5. *Deus Justificatus against the Assertors of absolute and unconditional Reprobation*. He left several works in MS., only one of which has yet been published, namely, the *Treatise concerning Eternal and Immutable Morality* (1781). The rest are, 1. *A Discourse of Moral Good and Evil*:—2. *A Discourse of Liberty and Necessity, in which the Grounds of the Atheistical Philosophy are confuted, and Morality vindicated and explained*:—3. *A Commentary on Daniel's Prophecy of the Seventy Weeks*:—4. *Of the Verity of the Christian Religion against the Jews*:—5. *A Discourse of the Creation of the World and Immortality of the Soul*:—6. *A Treatise on Hebrew Learning*:—7. *An Explanation of Hobbes's Notion of God, and of the Extension of Spirits*. These MSS. are now in the British Museum. In 1788 a Latin translation of the *Intellectual System* was published by Mosheim (Lugd. Bat. 2 vols. 4to). The best ed. of the English work is Harrison's (London, 1845, 8 vols. 8vo, with index). A good and cheap edi-

tion is that of Andover (1837, 2 vols. 8vo), which includes all the published writings of Cudworth, but has no index. See Birch, *Life of Cudworth* (prefixed to most editions of his works); *Engl. Cyclopaedia*; Mackintosh, *Ethical Philosophy*, p. 78.

Cujacius (properly *De Cujas*), JACQUES, a distinguished teacher of canon law, was born in 1522, at Toulouse. He became in 1554 a professor of law at Cahors, in 1555 at Bourges, in 1567 at Valence, and in 1575 again at Bourges. The civil war in France induced him shortly after to go to Paris, where he received permission to give lectures on law. In 1577 he once more returned to Bourges, where he thereafter remained, notwithstanding the most pressing offers from the University of Bologna. He died Oct. 4, 1590. Cujacius was the most famous teacher of the Roman law in the sixteenth century, and his reputation attracted large numbers of students from all countries of Europe. He corrected numerous passages of the Roman law-books from the more than 500 manuscripts which he had collected, and a great many obscure points were by him for the first time elucidated. He gained the love of the thousands of his pupils to a rare degree by the affectionate attention which he paid to the welfare of each. From the theological controversies of his time he cautiously abstained, though he was always a steadfast adherent of the cause of Henry IV. In his will he referred his wife and his daughter to the letter of the pure Bible, without note or comment, as the sole rule of their faith. He published himself a collection of his works (Paris, 1577), which, however, is not complete. The editions by Colomlet (Paris, 1617 and 1684) does likewise not contain all the works of Cujacius. A complete edition was prepared by Fabroti (Paris, 1658, 10 vols.), which has several times been reprinted, with some additions (latest edition, Prato, 18 vols. 1836). A life of Cujacius was published in 1590 by Papyrius Masson, but the best account of Cujacius is by Saint Prix (appendix to his work *Histoire du droit Romain*, Paris, 1821; an extract from this, in German, by Spangenberg, *Cujacius u. seine Zeitgenossen*, Leipz. 1822).—Brockhaus, *Conversations-Lex.* s. v.; Wetzer u. Welte, *Kirch.-Lex.* ii. 988.

Culbertson, MATTHEW SIMPSON, D.D., a Presbyterian minister and missionary, was born at Chambersburgh, Pa., Jan. 18, 1819, and was educated at the Military Academy, West Point. While serving as lieutenant of artillery he made a religious profession, and went to the Theological Seminary at Princeton, where he graduated in 1844. In that year he was licensed and ordained as missionary to China. He labored, together with Bridgeman, for several years in preparing a revised translation of the Scriptures in Chinese; and wrote *Darkness in the Flower Land, or Religious Notions and Popular Superstitions in North China* (N. Y. 1857, 12mo). He died of cholera, August, 1862.—Wilson, *Presb. Almanac*, 1863, p. 163.

Culdees. The name Culdee is variously derived and explained by several different authorities. Ehard gives "Kile De"—"man of God;" Dr. Braun, "Gille De"—"servant of God." But the latest, and perhaps best authority, gives us *Culdich* as the only name of the Culdees known among native Celts. This word means "a secluded corner;" a Culdee, therefore, is "the man of the recess." This accurately enough describes the Culdees' mode of life; though not monks, they were in a certain sense recluse.

The Scottish Church, when it first meets the eye of civilization, is not Romish, nor even prelatical. When the monk Augustine, with his forty missionaries, in the time of the Saxon Heptarchy, came over to Britain under the auspices of Gregory, the bishop of Rome, to convert the barbarian Saxons, he found the northern part of the island already well-nigh filled with Christians and Christian institutions. These Chris-

ans were the Culdees, whose chief seat was the little land of Hi or Iona, on the western coast of Scotland. An Irish presbyter, Columba, feeling himself stirred with missionary zeal, and doubtless knowing the wretched condition of the savage Scots and Picts in the year 565, took with him twelve other missionaries, and passed over to Scotland. They fixed their settlement on the little island just named, and from that point became the missionaries of all Scotland, and even penetrated into England. Before the end of the 7th century they had filled the country with their institutions, and subjected it, at least nominally, to Christ. Invited to England by Oswald, king of Northumberland, to preach the Gospel to his people, they sent Cormac, who failed because of too great austerity of behavior, and then Aidan, who, without knowing the people's language, succeeded, and proved himself one of the noblest of missionaries. The people in the south of England converted by Augustine and his assistants, and those in the north who had been won by Culdee labor, soon met, as Christian conquest advanced from both sides; and when they came together, it was soon seen that Roman and Culdee Christianity very decidedly differed in a great many respects. The Culdees, for the most part, had a simple and primitive form of Christianity, while Rome presented a vast accumulation of superstitions, and was arrayed in her well-known pomp. The result was, that in England the Culdees soon gave place to the Roman, and retired to his Northern home. Columba no doubt chose the little island of Iona as a place of safety from barbarian attack, as also because it was near to Ireland, whence he had brought his divine message. Besides, the loneliness of a small island in the sea was favorable to meditation, and accorded with the ascetic tendencies which at least touched the best men of those ages. The institution set up by Columba has been called a monastery, but, in truth, it had no claim to that name. True, the members of the community lived in cells, to which they retired for devotion and study, but this no more made them monks than a similar life makes monks of theological students of our own day. The Culdee recluses were not pledged to celibacy; many of them were married; many of them were succeeded in office by their own sons; they were not dedicated for life to their calling, but were free at any time to change it for another. Their families did not live within the sacred enclosure, but the husbands, their work within being done, passed out to spend the rest of their time with their families. Nor, indeed, was the aim of the institution at all kindred to that of monachism. The monk generally retires for his own improvement solely; he is weary of the world, and will have no more contact with it. He renounces it. The Culdee went to Iona that in quiet, with meditation, study, and prayer, he might fit himself for going out into the world as a missionary. Indeed, Iona was a great mission institute, where preachers were trained who evangelized the rude tribes of Scotland in a very short time. To have done such a work as this in less than half a century implies apostolic activity, purity, and success. With the exception of the principal men, they must have been much more out of their cells than in them. Traces of the schools and churches they established are found all over Scotland. The reason of this freedom from Romish asceticism may be found, at least in part, in the doctrines of these men. They had no dogma of purgatory, no saint worship, no works of supererogation, no auricular confession, or penance, or absolution; no mass, no transubstantiation, no "chris" in baptism, no priesthood, and no third order (bishops). They knew nothing of any authoritative rule except the Holy Scriptures. "These were held to be the one standard of truth, and were made by the missionaries a subject of close and constant study. Columba's own home work and that of his disciples was transcribing the Scriptures. These

early missionaries were thoroughly Biblical. Columba's life by Adamnan represents him in almost every page as familiar with the Word of God, and ready to quote it on all occasions as of supreme authority." . . . "The great subject of their teaching was the simple truth of the Gospel of salvation. It was '*verbum Dei*,' the Word of God. Adamnan says of Columba that from his boyhood he was instructed in the love of Christ." "The spirit of the Culdean Church may suitably and rightfully be described as an evangelical spirit, because it was free and independent of Rome; and when it and the papal Church came into contact, it always and obstinately repudiated its authority, under appeal to the single and supreme authority of holy Scripture; but, above all, because in its inner life it was penetrated throughout by the main principles of the evangelical Church. The Culdees read and understood the Scriptures in their original texts. Whenever they came they translated them orally and in writing into the language of the country, explaining them to the inhabitants, exhorting them to diligent and regular Bible reading. But the Scriptures were more to them than a codex of authoritative doctrines of faith. They were the living word of Christ. In the most earnest manner they preached the natural, inborn inability of man for good; the atoning death of Christ; justification without all merit of works; the worthlessness, especially, of all mere outward works; and the necessity of the new birth" (Ebrard). These views of life and doctrine reveal sufficiently the reason why the Culdees were missionaries rather than monks. The truths of the Gospel, pure and simple, just as they warmed the hearts of the apostles, had possession of them, and all their work was to make men feel and accept them. Their theory of Church government was very simple. The institution at Iona was under the presidency of a presbyter called a presbyter abbot, who had associated with him twelve other presbyters. In case of a vacancy in the headship, these brethren elected their abbot. That he was a presbyter simply there can be no doubt. Bede, who belonged to the Romish Church, himself mentions it as a very strange thing "that a man who is merely a presbyter should govern a diocese, and have even bishops under him." The truth is, that the missionaries sent out from these Culdee seminaries were appointed and ordained pastors of the churches they founded; and the pastor of the church was the overseer of it, i. e. the bishop. The presbyter abbot, therefore, had ordained an elder, but, by appointment to a parish, had made him a bishop. They evidently knew nothing of the distinction between the order of presbyter and that of bishop. After the success of Augustine and his monks in England, the Culdees had shut themselves up within the limits of Scotland, and had resisted for centuries all the efforts of Rome to win them over. At last, however, they were overthrown by their own rulers. Margaret, the daughter of William the Conqueror, the queen of Malcolm Canmore, devoted to the cause of Rome, notable for piety, of powerful mind and skilful in the management of others, set her heart upon exchanging the Culdee for the Romish Church in Scotland. She got the Culdee presbyters together, and for three days discussed the matter with them in person. She succeeded by persuasion and artifice. This was in the latter part of the 11th century. It was not, however, till the 18th century that Culdeeism was completely overturned and Romanism established. Nay, it is more than probable that Culdeeism, with its simple and powerful Gospel influence, continued to live in the hearts of the people long after its forms and public ministrations had been buried beneath the finery of triumphant Romanism. There was a readiness among the Scotch to embrace the Reformation when it came, which, together with their sturdy evangelical character, reminds the historical reader of Culdeeism.

Literature.—McLauchlan, *The Early Scottish Church*,

from the 1st to the 12th centuries (Edinb. 1865, 8vo); Alexander, *Iona* (Edinb. 1866); Ebrard, *Kirchen-und Dogmengeschichte* (4 vols., vol. ii); *Zeitschr. f. d. hist. Theol.* 1862, 1863; King, *The Culdees and their Remains*, 1864; *Meth. Quart. Rev.* Oct. 1861; *Brit. and For. Ev. Rev.* Jan. 1866; *Princeton Rev.* Jan. 1867; *The Church of Iona*, by the Bishop of Argyll, 1866. See IONA.

Culon (Κουλίον v. r. Κουλόμ, Jerome *Caulon*), the fifth named of the group of eleven cities added by the Septuagint to those in the mountains of Judah (between ver. 59 and 60 of Josh. xv); thought to be the modern *Kulonieh*, a trace of which appears in the notice of the Crusades (Wilken, *Gesch. der Kreuz.* iv, 509), a village with ruins about 1½ h. W. of Jerusalem towards Jaffa (Van de Velde, *Memoir*, p. 305); but, as this lay beyond the border of Judah (Schwarz, *Palest.* p. 118), the authenticity of the names in the Sept. being, moreover, dubious (Wilson, *Bible Lands*, ii, 266 n.), the place perhaps only represents some station or *Colonia* of the Romans (Robinson, *Later Res.* p. 158).

Cultus. See WORSHIP.

Culverwell, NATHANIEL, M.A., a pious and learned writer. He was fellow of Emmanuel College, Cambridge, and died about 1650. We have of him an *Elegant and learned Discourse on the Light of Nature* (on Prov. xx, 27), with several other treatises (Lond. 1661, 4to). The *Light of Nature* abounds in striking thoughts, and has passages of rare eloquence.

Cumanus, VENTIDIUS, procurator of Judæa immediately next to Alexander (a short time after Fadus), and partly in conjunction with Felix (q. v.), B.C. 49-58; under his administration the commotions broke out that led eventually to the final war with the Romans (Josephus, *Ant.* xx, 5, 2 and 3; 6, 1-3; *War*, ii, 12, 1-7).

Cumberland Presbyterian Church. See PRESBYTERIAN (CUMBERLAND) CHURCH.

Cumberland Presbyterians. See PRESBYTERIANS.

Cumberland, RICHARD, D.D., bishop of Peterborough, a learned divine and archæologist, was born in London in 1632, and was educated at St. Paul's School, and Magdalen College, Cambridge. He was made rector of Brampton, and in 1667 vicar of All Hallows, Stamford. In 1691 he was raised to the see of Peterborough without any solicitation on his part. He was previously known by his treatise *De Legibus Naturæ* (Lond. 1672, 4to), in answer to Hobbes, and by his *Essay on Jewish Weights and Measures* (London, 1696, 8vo). He was indefatigable in performing his episcopal duties. Being advised, on account of his age and infirm state, to relax a little, he replied, "It is better to wear out than rust out." After his death appeared his *Origines Gentium* (Lond. 1724, 8vo), and his translation of *Sanchoniatho's Phœnician History* (London, 1720, 8vo). At the age of eighty-three, Dr. Cumberland, having been presented by Dr. Wilkins with a copy of his Coptic Testament, then just published, commenced, like another Cato, the study of Coptic. "At this age," says Mr. Payne, "he mastered the language, and went through great part of this version, and would often give me excellent hints and remarks as he proceeded in reading of it." He died Oct. 9, 1718. Cumberland's theory of morals is set forth in his treatise *De Legibus Naturæ*. Tendency to effect the general good is made the standard of morality. To endeavor to effect the greatest amount of general good is the one great duty, or the one great "law of nature;" and we know, according to Cumberland, that it is a duty or law of nature, or law of God, because we know that an individual derives the greatest happiness from the exercise of benevolence, and that God desires the greatest possible happiness of all his creatures. Carrying out the fundamental principle that the greatest general good is to be sought, he deduces

the several particular duties or particular "laws of nature." He founds government upon, and tests it by the same principle. An abridged translation of his work was published by Tyrrel in 1701. Maxwell, an Irish clergyman, published a translation in 1727. Barbeyrac published a French version in 1744. A third English translation, by the Rev. John Towne, D.D., appeared in 1750. On Cumberland as a moralist, see Mackintosh, *Hist. of Ethical Philosophy*, p. 7. Whewell, *Hist. of Moral Philosophy*, p. 52.

Cu'mi (κούμι), a mode of Græcizing the Hebrew imperative קָמַרְ (ku'mi), signifying rise, as it is immediately explained (Mark v, 41).

Cumin (קָמַרְ, *kammôn'*, lit. a *condiment*, from its use; Greek *κύμινον*; and names of similar sound in all the Oriental dialects) is an umbelliferous plant mentioned both in the Old and New Testaments, and like the dill and the coriander, continues to be cultivated in modern as it was in ancient times in Eastern countries (Pliny, xix, 47). These are similar and used for many of the same purposes as the *smiz*



Cumin (*Cuminum Cuminum*), with enlarged view of the Flower, Capsule, and semisection of the last.

and caraway, which supply their place, and are more common in Europe. All these plants produce fruits commonly called seeds, which abound in essential oil of a more or less grateful flavor, and warm, stimulating nature; hence they were employed in ancient as in modern times both as condiments (Pliny, xix, 8; Apicius, i, 82; iii, 18; Polyæn. iv, 3, 32) and as medicines (Mishna, *Shabb.* xix, 2). A native of Upper Egypt and Ethiopia, it is still extensively cultivated in Sicily and Malta. It would appear to have been a favorite herb among the Hebrews, and as late as the last century it retained a place of some importance in pharmacy (see Ehrmann, *De cuminum*, Argent. 1735). Cumin is first mentioned in Isaiah (xxviii, 25): "When he (the ploughman) hath made plain the face thereof, doth he not cast abroad the fitches, and scatter the *cumin*?" showing that it was extensively cultivated, as it is in the present day, in Eastern countries, as far even as India. In the south of Europe it is also cultivated to some extent. In the above chapter of Isaiah (ver. 27) cumin is again mentioned: "For the fitches are not threshed with a threshing instrument, neither is a cart-wheel turned about upon the *cumin*; but the fitches are beaten out with a staff, and the *cumin* with a rod." This is most applicable to the fruit of the common cumin, which, when ripe, may be separated from the stalk with the slightest stroke, and would be completely destroyed by the turning round of a wheel, which, bruising the seed, would press out the oil on which its virtues depend (see Dioscor. iii,

68). In the New Testament, cumin is mentioned in Matt. xxiii, 23, where our Saviour denounces the Scribes and Pharisees, who paid their "tithe of mint, and anise, and *cumin*," but neglected the weightier matters of the law. In the Talmudical tract *Demai* (ii, 1) cumin is mentioned as one of the things regularly tithed.—Kitto; Fairbairn. (See *Celsii Hierob.* i, 516; *Penny Cyclop.* s. v.) See AROMATICS.

Cumming, ALEXANDER, a Congregational minister, native of Freehold, N. J., was born 1726. He entered the ministry 1747, and was made colleague pastor of the Presbyterian Church in New York, Oct. 1750. Owing to troubles in the Church, both pastors requested to be dismissed by a committee of the Synod in 1753, and Mr. Cumming was relieved Oct. 25, 1758. He was ordained collegiate pastor with Dr. Sewall, of the Old South Church, Boston, Feb. 25, 1761, where he remained until his death, Aug. 25, 1768. He published his ordination sermon at Boston (1761), and *Animadversions on Rev. Mr. Crowell's late Letter*, etc. (1768).—Sprague, *Annals*, i, 462.

Cuneiform (*wedge-shaped*) or **ARROW-HEADED INSCRIPTIONS**, is the name now generally applied to those angular letters first found engraved on Persepolitan relics (see Ker Porter's *Travels*; Rich's *Memoir*), and lately in great abundance stamped on Babylonian bricks [see BRICK], and carved on the Assyrian monuments. See ASSYRIA. The most copious collections of these legends are contained in the great works on the Ninevite antiquities by Botta and Flandin (*Monuments de Nineve*, Par. 1847, sq.), and by Layard (*Assyrian Inscriptions*, Lond. 1851), and more lately those of Loftus (*Inscriptions from the Ruins of Susa*, Lond. 1852); a considerable collection is also given by Rich (*Memoir on Bab.* Lond. 1839). The character is the simplest and earliest known, and was in common use by the Medes, Persians, Assyrians, and Chaldeans in the most ancient times. Like the Egyptian hieroglyphics, or rather *hieratic*, it seems to have been chiefly employed in monumental inscriptions, there being doubtless another form (like the *demotic*) better adapted to common use. It appears to have fallen into disuse when, on the fall of Babylon under Alexander, these mighty empires ceased to have any great national annals to record. Within the past eighty years the first specimens found their way into Europe from the fragments of Persepolis, and at length engaged the attention of several German philologists, especially Tyschen; but Dr. Grotefend, of Hanover, was the first who obtained any clew to their decipherment (see Vaux's *Nineveh and Persepolis*, p. 891 sq.). According to him, this mode of writing is formed of two radical signs, the *wedge* and the *angle*, susceptible, however, of about thirty different combinations; and consists of three varieties, the Persian, the Median, and the Assyrian, distinguished from each other by a greater or less complication of the characters, the last being the most elaborate: others make still further subdivisions, e. g. the Achæmænian, Babylonian, Medo-Assyrian, Elymæan, Scythian, Arian, etc. The whole of each alphabet, however, is obviously reducible to a single element, the wedge, which is found either singly or in groups of two, three, or more, and placed vertically, horizontally, or obliquely, in the several characters. It is evidently of Asiatic origin, is written from right to left, and is alphabetic. (See an elucidation of the process of deciphering these letters by Layard, *Nineveh*, ii, 184 sq.) The other great laborer in this field of discovery is Col. Rawlinson, of England, who has so completely succeeded in confirming and extending the results arrived at by others, that the meaning of these inscriptions, with the exception of the exact rendering of some of the proper names, may now be said to be established beyond dispute. (See his *Commentary on the Cuneiform Inscriptions*, read before the Roy. As. Soc., and published in a separate

Assyrian Cuneiform Alphabet.

Form.	Sound.	Form.	Sound.
	a		n
	a, ya		p
	b		da, z, j
	g, kh		k
	d		hu, w, y
	h		u
	hu, w, y		o
	u		w, h, a, r
	o		ch
	w, h, a, r		t
	ch		t, s
	t		i
	t, s		i, y
	i		i, ū
	i, y		y
	i, ū		kh
	y		m, w
	kh		n
	m, w		a, z
	n		nū
	a, z		wush
	nū		
	wush		

form, Lond. 1850.) Dr. Hincks has also successfully prosecuted these inquiries. (See his papers in the *Transactions of the Roy. Irish Acad.* vol. xxii.) The inscriptions are usually trilingual as well as trilateral, the alphabets and entire structure differing in each version. See BERTHUN. The language is Shemitic, but corresponds with neither the Hebrew, Chaldee, Syriac, nor Arabic, as they have come down to us. The inscriptions of various periods and at different places differ considerably in their form and diction.

The following specimens of identification of names mentioned in the Old Test. with those occurring in the

Adramelech	𐎠𐎢𐎥𐎢𐎠
Arameans (Aram)	𐎠𐎢𐎥𐎢𐎠
Ararat	𐎠𐎢𐎥𐎢𐎠
Arvad	𐎠𐎢𐎥𐎢𐎠
Ashdod	𐎠𐎢𐎥𐎢𐎠
Ashkelon	𐎠𐎢𐎥𐎢𐎠
Assyria	𐎠𐎢𐎥𐎢𐎠
Assyrians	𐎠𐎢𐎥𐎢𐎠
Babylon	𐎠𐎢𐎥𐎢𐎠
Baladan	(See Merodach-Baladan.)
Bel	𐎠𐎢𐎥𐎢𐎠
Charchemiah	𐎠𐎢𐎥𐎢𐎠
Chaldeans	𐎠𐎢𐎥𐎢𐎠
Chebar	(See Habor.)
Dagon	𐎠𐎢𐎥𐎢𐎠
Damascus	𐎠𐎢𐎥𐎢𐎠
Eden (Children of)	𐎠𐎢𐎥𐎢𐎠
Egypt	𐎠𐎢𐎥𐎢𐎠
Ekron	𐎠𐎢𐎥𐎢𐎠
Elam	𐎠𐎢𐎥𐎢𐎠
Esrhaddon	𐎠𐎢𐎥𐎢𐎠
Eufrates	𐎠𐎢𐎥𐎢𐎠
Gaza	𐎠𐎢𐎥𐎢𐎠
Gebal (people of)	𐎠𐎢𐎥𐎢𐎠
Gozan (people of)	𐎠𐎢𐎥𐎢𐎠
Habor or Chebar (river)	𐎠𐎢𐎥𐎢𐎠
Hagarenes	𐎠𐎢𐎥𐎢𐎠
Hamath	𐎠𐎢𐎥𐎢𐎠
Haran	𐎠𐎢𐎥𐎢𐎠
Hazael	𐎠𐎢𐎥𐎢𐎠
Hezekiah	𐎠𐎢𐎥𐎢𐎠
Hittites	𐎠𐎢𐎥𐎢𐎠
Javan	𐎠𐎢𐎥𐎢𐎠
Jehu	𐎠𐎢𐎥𐎢𐎠
Jerusalem	𐎠𐎢𐎥𐎢𐎠
Judea	𐎠𐎢𐎥𐎢𐎠
Lachiah	𐎠𐎢𐎥𐎢𐎠
Lebanon	𐎠𐎢𐎥𐎢𐎠
Media	𐎠𐎢𐎥𐎢𐎠
Menahem	𐎠𐎢𐎥𐎢𐎠
Merodach-Baladan	𐎠𐎢𐎥𐎢𐎠
Meshech	𐎠𐎢𐎥𐎢𐎠
Mesopotamia	𐎠𐎢𐎥𐎢𐎠
Nabthezans	𐎠𐎢𐎥𐎢𐎠
Nebo	𐎠𐎢𐎥𐎢𐎠
Nineveh	𐎠𐎢𐎥𐎢𐎠
Omri	𐎠𐎢𐎥𐎢𐎠
Persia	𐎠𐎢𐎥𐎢𐎠
Pethor	𐎠𐎢𐎥𐎢𐎠
Pharaoh	𐎠𐎢𐎥𐎢𐎠
? Pul (or Tiglath-Pileser)	𐎠𐎢𐎥𐎢𐎠
Samaria	𐎠𐎢𐎥𐎢𐎠
Sargon	𐎠𐎢𐎥𐎢𐎠
Sennacherib	𐎠𐎢𐎥𐎢𐎠
Shemeah (the sun)	𐎠𐎢𐎥𐎢𐎠
Shusan	𐎠𐎢𐎥𐎢𐎠
Sidon	𐎠𐎢𐎥𐎢𐎠
Telassar	𐎠𐎢𐎥𐎢𐎠
Tigris	𐎠𐎢𐎥𐎢𐎠
Tubal	𐎠𐎢𐎥𐎢𐎠
Tyre	𐎠𐎢𐎥𐎢𐎠
Ur	𐎠𐎢𐎥𐎢𐎠

Assyrian inscriptions are given by Layard (*Nin. and Bab.* p. 534-6). Other instances will be noted under the several kings and deities in their proper places, e. g. Artaxerxes, Asshur, Cyrus, Darius, Xerxes. See Paravey, *Ninive et Babylon expliquées* (Paris, 1845-6); Stern, *Die dritte Gattung d. Achämenideischen Keilschr.* (Gött. 1850); Anon. *Lecture lit. des hiéroglyphes et de cunéiformes* (Par. 1853); Grotefend, in the *Fundgrün des Oriens*, 1814; and in Heeren's *Ideen*, I, i (1815); *Neue Beiträge zur Erläuterung der Persepol. Keilschr.* (Hann. 1837); *N. Erläut. der Babylon. K.* (ib. 1844); *Bemerkungen üb. d. Inschr. e. Thongesäßes m. Babylon. Keilschr.* (Gött. 1848); *Erläut. d. k.-en bab. Backstein* (Hann. 1850); *Der Trib. der Obeliskens aus Niniv.* (Gött. 1852); Burnouf, *Mém. sur deux inscriptions cunéiformes* (Paris, 1836); Holzmann, *Beiträge zur Erk. der Pers. Keilschr.* (1846); Hincks, *On the three Kind of Persepolitan Writing*, etc. (Lond. 1846); *On the third Persepol. Writing* (1847); *Report to the Trustees of the Brit. Mus.*, etc. (1864); *Polyphony of the Cuneiform Writing* (Lond. 1863); Suzatto, *Sulla iscrizione cunéiforme di Behistun* (Mail. 1848); *Le Sanscritisme de la langue Assyrienne* (Pad. 1844); *Études sur les inscriptions de Persépolis*, etc. (ib. 1850); Botta, *Mém. sur l'écriture cunéiforme* (Par. 1848); De Saulcy, *Recherches sur l'écriture cun.* (ib. 1848); *Rech. analytiques*, etc. (ib. 1848 sq.); *Traduction de l'inscrip. de Behistun* (ib. 1854); Layard, *Inscrip. in the Cuneiform Character* (Lond. 1851); Norris, *Memoir on the Scythic Version of the Beh. Inscrip.* (ib. 1853); Lassen, *Altpersische Keil-Inschriften von Persepolis* (Bonn, 1836); Lichtenstein, *Palaeographia Assyro-persica* (Helmst. 1808); Col. Rawlinson, *Cuneiform Inscriptions* (Assyrian and English, with a vocabulary, 8 pts. 8vo, Lond. 1846, and later; being vol. x sq. of the *Jour. of the Roy. As. Soc.*); *Commentary on the Cuneiform Inscriptions* (London, 1850); *Memoir on the Babyl. and Assyr. Inscriptions* (ib. 1851); Ménant, *Inscriptions Assyriennes* (Par. 1859); *Notice sur les inscriptions cunéiformes* (Paris, 1859); also, *Les écrivains Cunéiformes* (Paris, 1860, 1864); Oppert, *Das Landstetm des Altpersischen* (Berl. 1847); *Mém. sur les inscrip. des Achéménides* (Paris, 1851); *Nouveaux monuments du Roi de Babylone* (Par. 1859); *Éléments de la grammaire Assyrienne* (Paris, 1860); and *Grande inscription à Khorsabad* (Par. 1866); Brandis, *Assyr. Inscrip.* (tr. in the *Bibliotheca Sacra*, April, 1857); G. R. Rawlinson, *Four Monarchies*, i; De Gobineau, *Lecture des textes Cunéiformes* (Par. 1858); Olshausen, *Prüfung der Assyrischen Keilschrift* (Herm. 1864); *Presb. Quart. Review*, April, 1861; *Br. and For. Evang. Review*, July, 1861; *Jour. Sac. Lit.* April, 1861, Oct. 1864; Morris, *Assyrian Dictionary* (Lond. 1868 sq. 8vo).

Cunigunda, wife of Henry of Bavaria, who afterwards became emperor. She was crowned with her husband by pope Benedict VIII, A.D. 1014. According to the Roman *Acts of the Saints*, she had made a vow of virginity, and her husband suspecting her fidelity, she "walked over red-hot ploughshares without being hurt," and thus vindicated her innocence! She died March 3, 1040, and was canonized in 1200 by Innocent III. The Romish legends tell of many miracles wrought at her tomb.—Butler, *Lives of Saints*, March 3.

Cunningham, D.D., Rev. WILLIAM, an eminent minister of the Free Church of Scotland, was born in October, 1805, and was fully identified with all the movements and controversies which led to the disruption of the Church of Scotland. He received at the hands of the Free Church all the honors in their gift, and was moderator of the Assembly in 1859. At the time of his death he was principal of the college of the Free Church of Scotland. After the disruption he visited America, where his eloquence and intellectual power enabled him to enlist the sympathies of a large portion of the churches, and to secure an

amount of material aid at that time greatly needed by the Free Church. He died at his house in Edinburgh, Scotland, December 14, 1861. His principal writings were collected after his death by his literary executors, as follows, viz., *The Reformers, and the Theology of the Reformation* (Edinb. 1862, 8vo); *Discussions of Church Principles* (Edinb. 1863, 8vo); *Historical Theology* (Edinb. 1864, 2 vols. 8vo). The first two works consist chiefly of Dr. Cunningham's Review articles; the last, of his lectures in the Free Church College. They manifest large learning, great grasp of theological science, both historical and doctrinal, and a thoroughly evangelical spirit. In regard to Church government, Dr. Cunningham was a Presbyterian, "believing that Christ has committed the government of his Church, not to congregations, nor to prelatial bishops, but to presbyters or elders, otherwise called bishops. But, above all, he was a Calvinist, maintaining that man is by nature helplessly lost, and is and can be saved only by the free and sovereign love of God, giving salvation to whom he will, in what manner he will, because he wills it. He will be recognised in history, not as a Free Churchman, nor as a Presbyterian, but as a great Calvinist, occupying a place in his generation such as Calvin and Turretine occupied in theirs. The Calvinistic system Dr. Cunningham holds not provisionally, as a half-way house to some more comprehensive system in posse, 'looming in the future,' but definitely, as what has been ascertained to be the system revealed in God's Word, the only possible exhibition of all the Scripture facts regarding God and man, the only scriptural description of what God actually is, and has done, and is doing, in his relation to rational creatures, and especially in order to man's salvation. He therefore immovably rests in the conviction that no new discovery can be made in theology; that any pretended novelty is either Calvinism under a new form, or some of the old errors in disguise which have been advanced against Calvinism, and which, as opposed to Calvinism, are, *ipso facto*, shown to involve a lie."—*Brit. and For. Evangelical Review*, Jan. 1863, p. 193 sq.; Wilson, *Presbyt. Almanac*, 1863, p. 163; *Lond. Quarterly Review*, April, 1863, p. 253; *N. British Review*, Feb. 1863.

Cup (usually כוס, *kos*, prop. a receptacle; N. T. ποτήριον, a drinking vessel) denotes originally a wine-cup (Gen. xl, 11-21), various forms of which, of different materials, are delineated on the Egyptian and Assyrian monuments. See WINE. The cups of the Jews, whether of metal or earthenware, were possibly borrowed, in point of shape and design, from Egypt and from the Phœnicians, who were celebrated in that branch of workmanship (*Jl. xxiii*, 743; *Od. iv*, 615, 618). Among the Egyptians the forms of cups and vases were very varied, the paintings upon the tombs representing many of most elegant design, though oth-

ers are equally deficient in the properties of form and proportion. The forms used during the fourth and other early dynasties (1700 B.C.) continued to be common to a late date (Kenrick, *Egyptians of Time of Pharaohs*, Lond. 1857, p. 48). There are not any representations of cups like the head of an animal (Bonomi, *Nineveh and its Palaces*, 3d edit. p. 215, 216). Many of the Egyptian vases, cups, and bowls were of gold (Herod. ii, 151) and silver (Gen. xlv, 2; comp. Num. vii, 84), some being richly studded with precious stones, inlaid with vitreous substances in brilliant colors, and even enamelled. In Solomon's time all his drinking-vessels were of gold, none of silver (1 Kings x, 21). Babylon is compared to a golden cup (Jer. li, 7). Assyrian cups from Khorsabad and Nimroud were of gold and bronze (Layard, *Nineveh*, ii, 236; *Nin. and Bab.* p. 161; Bonomi, *Nineveh*, p. 187), as well as of glass and pottery. They were perhaps of Phœnician workmanship, from which source both Solomon and the Assyrian monarch possibly derived both their workmen and the works themselves. The cups and other vessels brought to Babylon by Nebuchadnezzar



Ancient Assyrian Cups: 1 and 2. Lion-headed (the latter with handle); 3. Sculptured; 4. Red pottery; 5. Painted; 6, 7. Bronze.

may thus have been of Phœnician origin (Dan. v, 2). See BANQUET. On the bas-reliefs at Persepolis many figures are represented bearing cups or vases, which may fairly be taken as types of the vessels of that sort described in the book of Esther (Esth. i, 7; Niebuhr, *Travels*, ii, 106; Chardin, *Voyages*, viii, 268, pl. lviii). The great laver, or "sea," was made with a rim like the edge of a cup (*kos*), "with flowers of lilies" (1 Kings vi, 26), a form which the Persepolitan cups resemble (Jahn, *Arch.* § 144). Similar large vases have been found represented at Khorsabad (Botta, pl. lxxvi). The use of gold and silver cups was introduced into Greece after the time of Alexander (Athen. vi, 229, 230; xl, 446, 465; Birch, *Anc. Pot.* ii, 109). The cups of the N. T. (ποτήρια) were often, no doubt, formed on Greek and Roman models. (See Smith, *Dict. of Class. Antiq.* s. v. Patara.) They were sometimes of gold (Rev. xvii, 4).—Smith, s. v.; Fairbairn, s. v. The common Eastern drinking-cup is of brass, and frequently has devices and sometimes sentences from the Koran engraved on the inside (Lane, *Mod. Eg.* i, 222). As the Moslem law, however, forbids the drinking of wine to good Mohammedans, the common beverage in its place is coffee, which is invariably offered to visitors. The coffee (*kahneh*, i. e. the drink) is made very strong, and without sugar or milk. The coffee-cup (which is called *jingon*) is small, generally holding not quite an ounce and a half



Bronze Cup, with lip (from Nimroud).



Ancient Egyptian Drinking-vessels: 1, 2, 3. Vase, goblet, and cup from paintings; 4. Porcelain; 5. Green earthenware; 6. Coarse pottery; 7. Wood; 8. Arragonite; 9. Saucer of earthenware.



Drinking-cup from Pompeii.



Modern Oriental Cups.

of liquid. It is of porcelain or Dutch-ware, and, being without a handle, is placed within another cup (called *zarf*) of silver or brass, according to the circumstances of the owner, and both in shape and size nearly like an egg-cup.

In a full service there are ten *fangans* and *zarfs* of uniform kinds, and often another *fangan* and *zarf* of a superior kind for the master of the house or for a distinguished guest. In the accompanying sketch, the coffee-pot (*bekreg* or *bakrag*) and the *zarfs* and tray are of silver, and are represented on a scale of one eighth of the real size. Below this set are a similar *zarf* and *fangan*, on a scale of one fourth, and a brass *zarf*, with the *fangan* placed in it. Some *zarfs* are of plain or gilt silver filigree, and a few opulent persons have them of gold. Many Moslems, however, relig-



Ancient Assyrian Cup of Libation after a Bull-hunt.

Kalisch, *Comment.* p. 678). In Isa. xxxii, 24, the word translated "cup" is *אגגון* (*aggon*), literally a trough for washing garments), and signifies a *laver* or basin (as it is rendered in Exod. xxiv, 6; "goblet," Cant. vii, 2). The "cup of trembling" (*כוס*, *saph*, elsewhere "basin" or "bowl") signifies a broad convex *dish*, such as is easily made to rock or vibrate. The "cups" referred to in 1 Chron. xxviii, 17, were the *כוסות* (*kesavot*) or broad *bowls* for libation (elsewhere improperly rendered "covers," Exod. xxv, 29; xxxviii, 16; Num. iv, 7). Such vessels appear in the hands of the Assyrian king on the monuments, apparently in festive

or religious drinking after public exploits (Bonomi, *Nineveh*, p. 252). In the Apocrypha we find the sacred vessels of Jehovah called *σπονδία*, *goblets* (1 Esd. ii, 18. "In their cups" 1 Esd. iii, 22, is a rendering for *βραβ πινωται*, when they drink). See **BASIN**; **BOWL**; **DISH**; **VASE**; **VIAL**, etc.

"The word 'cup' is used in both Testaments in some curious metaphorical phrases. Such are the *cup of salvation* (Psa. cxvi, 13), which Grotius, after Kimchi, explains as 'poculum gratiarum actionis,' a cup of wine lifted in thanksgiving to God (comp. Matt. xxvi, 27). That it alludes to a paschal libation cannot be proved; and that it was understood by the Jews to be expressive of gratitude we may see from 3 Macc. vi, 27, where the Jews offer 'cups of salvation' in token of deliverance. In Jer. xvi, 7 we have the term '*cup of consolation*,' which is a reference to the wine drunk at the *περίδειπνα*, or funeral feasts of the Jews (2 Sam. iii, 85; Prov. xxxi, 6; Joseph. *War.* ii, 1). In 1 Cor. x, 16, we find the well-known expression '*cup of blessing*' (*ποτήριον τῆς εὐλογίας*), contrasted (ver. 21) with the '*cup of deris*.' The sacramental cup is called the cup of blessing because of the blessing pronounced over it (Matt. xxvi, 27; Luke xxii, 17; see *Lightfoot*, *Hor. Hebr.* in loc.). No doubt Paul uses the expression with a reference to the Jewish 'cup of blessing' (*כוס בְּרִיכוּת*), the third of the four cups drunk by the Jews at their Paschal feast (Schöttgen, *Hor. Hebr.* in 1 Cor.; Jahn, *Bibl. Arch.* § 853), but it is scarcely necessary to add that to this Jewish custom our Lord, in his solemn institution of the Lord's Supper, gave an infinitely nobler and diviner significance (Buxtorf, *De Sacris Ceram.* § 46, p. 810). Indeed, of itself, the Jewish custom was liable to abuse, and similar abuses arose even in Christian times (Augustine, *Serm.* cxxxii, *de tempore*; Carpzov, *App. Critic.* p. 380 sq.). See **PASSOVER**. In Psa. xi, 5; xvi, 5, 'the portion of the cup' is a general expression for the condition of life, either prosperous or miserable (Psa. xxiii, 5). A cup is also in Scripture the natural type of sensual allurements (Jer. li, 7; Prov. xxiii, 81; Rev. xvii, 4; xviii, 6). See **BARQUET**.

"But in as far for the majority of passages, the cup is a 'cup of astonishment,' a 'cup of trembling,' the full red flaming wine-cup of God's wrath and retributive



Modern Oriental Coffee-service.

iously disallow all utensils of gold and of silver (Lane, *Mod. Eg.* i, 205). See **CUP-BEARER**.

The practice of divining by means of a cup (*גב'א*, *gab' a*, Gen. xlv, 2-17; a *goblet*, distinguished from the preceding or smaller cups used in drinking; rendered "pot" in Jer. xxxv, 5; spoken of the calix-form "bowls" of the golden candlestick, Exod. xxv, 81-84; xxxviii, 17-20) was a practice of great antiquity in the East. We read in early Persian authors of the mystical cup of Jemshid (Bonomi, *Nineveh*, 3d ed. p. 806), which was imagined to display all the occurrences on the face of the globe (Tisroff, *De Scypho Josephi*, Jen. 1657; Tittel, *id.* Tor. 1727). See **DRIVINATION**. The bronze cup, with the sacred beetle engraved in the bottom, found by

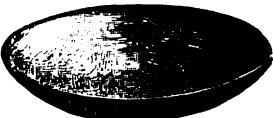

Ancient Assyrian Mystical Cup.

Layard among the ruins of Nimroud, may have been used for such a purpose (*Nineveh and Babylon*, p. 157). *Κόνδυ*, the word used in Gen. by the Sept., occurs in Hipparchus (*ap. Athen.* p. 478, A), and is curiously, like the Indian *kundi*, a sacred Indian cup (Bohlen on *Gen.* p. 403;

ignation (Psa. lxxv, 8; Isa. li, 17; Jer. xxv, 15; am. iv, 21; Ezek. xxiii, 32; Zech. xii, 2; Rev. xvi, 3, etc.). There is, in fact, in the prophets no more equent or terrific image; and it is repeated with pathetic force in the language of our Lord's agony (Matt. xvi, 28, 29; John xviii, 11; Mark x, 38). God is here represented as the master of a banquet, dealing his madness and stupor of vengeance to guilty guests Vitrings in Isa. li, 17; Wichmannshausen, *De ira et remoris Calice*, in *Theol. Nov. Theol. Philol.* i, 906 sq.). The cup thus became an obvious symbol of death (ῥοῦριον . . . σημαίνει καὶ τὸν θάνατον, Etym. M.); and hence the Oriental phrase, to 'taste of death,' so common in the N. T. (Matt. xvi, 28; Mark ix, 1; John viii, 52; Heb. ii, 9), in the Rabbis (Schöttgen, *Hor. Hebr.* in Matt. xvi), in the Arabian poem Antar, and among the Persians (Schleuser, *Lex. N. T.*, s. v. ποτήριον; Jahn, *Bibl. Arch.* § 208). The custom of giving a cup of wine and myrrh to condemned criminals (Otho, *Lex. Rabb.* s. v. Mora) is alluded to in Matt. xxvii, 34; Mark xv, 22" (Kitto, s. v.). See Wemyss, *Clavis Symbol.* s. v.; Stier, *Words of Jesus*, i, 378 sq. See CRUCIFIXION.

CUP. See LORD'S SUPPER.

CUP GIVEN TO THE LAITY. See LORD'S SUPPER.

Cup-bearer (ἄποψος, *mashekheh*), one who gives to drink; so Gr. οἰνοπόος, *wine-pourer*; Vulg. *pincerna*), an officer of high rank with Egyptian, Persian, Assyrian, as well as Jewish monarchs. The chief cup-bearer, or butler, to the king of Egypt was the means of raising Joseph to his high position (Gen. xl, 1-21; xli, 9). Rabshekeh, who was sent by Sennacherib to Hezekiah, appears from his name to have filled a like office in the Assyrian court (2 Kings xviii, 17; Gesen. *Thesaur.* p. 1225), and it seems probable, from his association with Rabsaris (*chief of the eunuchs*), and from Eastern custom in general, that he was, like him, a eunuch (Gesen. p. 978). See RABSEAKEH.



Ancient Assyrian Cup-bearer, with Fan.

bearer (Josephus, *Ant.* xvi, 8, 1). Nehemiah was cup-bearer to Artaxerxes Longimanus, king of Persia (Neh. i, 11; ii, 1). Cup-bearers are mentioned among the attendants of Solomon (1 Kings x, 5; 2 Chron. ix, 4; so Achiacharus, Tobit, i, 22).—Smith, s. v. They are frequently represented on the Assyrian monuments (Bonomi, *Nin.* p. 260), always as eunuchs (Layard, *Nin.* ii, 258).

Cupboard (κυλίκιον), a place of deposit for vases, dishes, etc. (so Athen. *Deipn.* xi, c. 2, p. 48; Zonaras, *Lex. col.* 1268), e. g. for the royal plate (1 Macc. xv, 82).

Curcellæus, STEPHANUS (*Etienne de Courcelles*), an eminent and learned divine, was born at Geneva April 30, 1586. He studied under Beza at Geneva, and afterwards at Heidelberg. In 1614 he was appointed pastor at Fontainebleau; in 1621, at Amiens; but, on his refusal to subscribe to the canons of Dort (q. v.), he was compelled to resign his pastoral charge. But, yielding to the importunity of friends, he afterwards gave a modified assent to the decrees of Dort, and became pastor at Verrez, in Piedmont, where he remained until 1634. Becoming satisfied that he could not, with a good conscience, serve in a Church

which held the doctrine of absolute predestination, he removed to Amsterdam, where he acquired a great reputation among the followers of Arminius. He read lectures in divinity, and succeeded Episcopius (1634) in the professorship of theology in the Remonstrants' College. He had great skill in Greek, as appears by his translation of Comenius's book, *Janua linguarum*, into that language. He applied himself particularly to a critical examination of the Greek of the New Testament, of which he gave a new edition, with many various readings drawn from different MSS. He prefixed a large dissertation to this edition, in which he treats of various readings in general (Amst. 1658 and 1676, 12mo). His large culture and tolerant spirit commended him to his great contemporaries in Holland, Grotius and Uitembogaert, with both of whom he was intimately connected. In the discussion between Amyraut and Du Moulin he intervened, as a sort of arbiter, by his *Advis d'un personnage désintéressé relativement à la dispute sur la prédestination* (Amst. 1638, 8vo). Later he published *Vindiciæ Arminii adv. M. Amyraldum* (1645, 8vo); *Defensio D. Blondelli adv. Marcelli Criminaciones* (Amst. 1657); *Dissertationes* (Amst. 1659, 8vo). These, and other of his writings (translated into Latin), are given, together with his *Institutio Religionis Christianæ* (an incomplete system of Theology), in *Curcellæi Opera Theologica* (Amst. 1676, fol.), with preface by Limborch, and eulogy on Curcellæus by Arnold Poeseburg. From Poeseburg's characterization of Curcellæus we extract the following passage: "He first of all directed his mind to a search after divine truth; for he thought that this treasure, descending from heaven, should be preferred to all other acquirements. Next, he had all the thoughts of his mind directed to INTEGRITY, because he believed that not even truth could be of benefit to us, unless it brought some strikingly advantageous aid to our piety. Finally, this especially he wished, and for this peculiarly he labored, to unite the Christian body, torn into many and terrible schisms; to compose and conciliate the separate, distracted feelings of various minds; and to teach that not all the doctrines which were alleged as a pretext for causing or cherishing a schism were vital for salvation, and at the same time to show that those things which had not the weight of necessity by no means sufficed for dividing the Church of Christ. To this all things were to be referred which he meditated, uttered, or performed; for this he refused to subscribe to the famous canons of the synod, because we, whose opinions ought not to be, were condemned; for this he abandoned his loved country, France, and endured many hardships for the sake of mutual toleration; and for this he determined to contest, as if for some divine palladium. He conceded to others as much as he thought should be equally granted to him; demanded that nothing should be conceded to himself from others except what justice, and right reason, and the sacred writings require should be admitted. What is more holy than this proposition, what more salutary, what more necessary for the times? For many contend concerning the truth, and so contend that they never obtain truth, but lose charity. Hence the many disputes in Christendom on slight causes. But what is more disgraceful to us as members of Christ, what more ignominious to Christ as our Head and Leader, than that his seamless coat, and his body, which ought to be united by the closest ties of love, should be torn into a thousand fragments? This, indeed, is the distinction of Remonstrantism; this our crown of glory, because we neither caused this schism, nor consented to any other, nor cherished nor approved any; but we invite and exhort all who love Christ and adhere to his Gospel alone to enter this communion of peace" (see translation of Poeseburg's eulogy in the *Methodist Quarterly Review*, January and April, 1863). The theology of Curcellæus was a modified Arminianism.

He held the Grotian view of the atonement, but (see ATONEMENT) set special emphasis upon the sacrificial character of the death of Christ in its reference to God as well as to man, asserting that Christ made satisfaction for sin, but not by enduring the whole punishment due to sinners (*Instit. lib. v. chap. xviii, xix*). As to the Trinity, he held that Christ and the Holy Spirit are divine, but that both Son and Spirit are subordinate to the Father, from whom they receive both existence and divinity (*Instit. Reliq. Christ. lib. ii, cap. xix*).—Curcellæus, *Opera* (as cited above); Hagenbach, *History of Doctrines*, ii, § 235, 268; Dorner, *Doctrine of the Person of Christ* (Edinb. transl.), div. ii, vol. ii, 860 sq.; Bull, *Defence of the Nicene Creed* (Lib. of Angl. Cath. Theology), i, 81 sq.

Curate, literally one who has the cure (Lat. *cura*, care) of souls, in which sense it is used in the Church of England Prayer-book, "all bishops and curates." In the Church of Rome it was originally appropriated to assistants and vicars appointed by the bishops. It is now generally used to denote the humblest degree of ministers in the Church of England. A curate, in this sense, is a minister employed by the incumbent of a church (rector or vicar), either as assistant to him in the same church, or else in a chapel of ease within the parish belonging to the mother church. He must be licensed and admitted by the bishop of the diocese, or by an ordinary having episcopal jurisdiction, who also usually appoints his salary. Any curate that has no fixed estate in his curacy, not being instituted and inducted, may be removed at pleasure by the bishop or incumbent. But there are *perpetual* curates as well as temporary, who are appointed where tithes are inappropriate and no vicarage was ever endowed: these are not removable, and the impropricators are obliged to maintain them. In general, the salaries of curates, certainly the hardest-worked and not the least devoted of the English clergy, are shamefully small, and reform in this matter is urgently required. "This large class of men are absolutely at the disposal of the bishops; they have no security whatever, no rights, no powers; public opinion may protect them to a certain extent, but any bishop who chooses to set public opinion at defiance is absolute over the whole class."—*Church of England Quarterly Review*, April, 1855, p. 25; Chambers, *Encyclop. s. v.*; Hook, *Church Dictionary*, s. v.

Cure, מְרַפֵּא, *marp'* (Jer. xxxvi, 6); יָצוּר (Luke xiii, 32). From the same Heb. root, מְרַפֵּא, *rapha'*, to "heal" or cure, is derived מְרַפְּוֹת, *raphuoth'*, the art of healing, curing (Prov. iii, 8); and רְפוּאוֹת, *rephuoth'*, remedies, medicines (Jer. xlvi, 11; Ezek. xxx, 21). The Scriptures make no mention of physicians before the time of Joseph, and then it is Egyptian, not Hebrew physicians that are spoken of. Indeed, it does not appear that physicians were ever much resorted to among the Hebrews, especially for internal maladies. For wounds, bruises, and external injuries, they had physicians or surgeons who understood dressing and binding them, with the application of medicaments (Jer. viii, 22; xlvi, 11; Ezek. xxx, 21); and the Levites, it seems from Lev. xiii, 14; Deut. xx, 2, had peculiar duties assigned them, which rendered it necessary they should know something of the art of medicine. The probable reason of king Asa's not seeking help from God, but from the physicians, was, that they had not recourse to the simple medicines which nature offered, but to certain superstitious rites and incantations; and this, no doubt, was the ground of the reflection cast upon him (2 Chron. xvi, 12). The balsam, or balm of Gilead, was particularly celebrated as a medicine (Gen. xxxvii, 25; xliii, 11; Jer. vii, 22; xlvi, 11; ii, 8). That mineral baths were deemed worthy of notice, and perhaps from ancient times, we know from Josephus. See CALLIRHOË. Although there can be no doubt that there were physicians in the coun-

try when our Saviour appeared in Palestine, it is evident that the people placed but little confidence in them (Mark v, 26; Luke viii, 43). The Egyptian physicians, on the other hand, were highly esteemed. The first read of them as being commanded by Joseph to embalm the body of his father Jacob (Gen. l, 2). Pliny states that, during the process of embalming, certain examinations took place, which enabled them to study the disease of which the deceased had died. Wilkinson observes (*Anc. Egypt.*, 2d ser., ii, 460 sq.), "The examinations appear to have been made in compliance with an order from the government, as, according to Pliny (xix, 5), the kings of Egypt had the bodies opened after death to ascertain the nature of their diseases, by which means alone the remedy for phtisical complaints was discovered. Indeed, it is reasonable to suppose that a people so far advanced as were the Egyptians in knowledge of all kinds, and whose medical art was so systematically arranged that they had regulated it by some of the very same laws followed by the most enlightened and skilful nations of the present day, would not have omitted so useful an inquiry, or have failed to avail themselves of the means which the process adopted for embalming the body placed at their disposal. And nothing can more clearly prove their advancement in the study of human diseases than the fact of their assigning to each his own peculiar branch, under the different heads of ophthalmists, dentists, those who cured diseases in the head, those who confined themselves to intestinal complaints, and those who attended to secret and internal maladies. Their knowledge of drugs, and of their effects, is sufficiently shown by the preservation of the mummies and the manner in which the intestines and other parts have been removed from the interior. And such is the skill evinced in the embalming process, that every medical man of the present day, who witnesses the evidence derived from such an examination of the mummies, willingly acquiesces in the praise due to the ability and experience of the Egyptian embalmers." See EMBALMING. There is reason to believe that the ancient Egyptians encouraged, or at least profited by, the growth of many wild plants of the desert, which were useful for medicinal purposes. Many of them are still known to the Arabs, as the *Salsadora Persica*, *Heterotropium inebrians*, *Lycium Europæum*, *Scilla maritima*, *Cassia Senna*, *Ochradenus baccatus*, *Ocimum Zatarakêh*, *Linaria Egyptiaca*, *Spartium monospermium*, *Hedysarum Althagi*, *Santolina fragrantissima*, *Artemisia Judæica* (*monosperma* and *inculta*), *Inula undulata* and *crispâ*, *Cucumis Colocynthis*, etc.; and many others have probably fallen into disuse from the ignorance of the modern inhabitants of the country, who only know them from the Arabs, by whom the traditions concerning their properties are preserved. From what Homer tells us of "the infinity of drugs produced in Egypt" (*Odys.* ii, 229), the use of "many medicines," mentioned by Jeremiah, ch. xlvi, 11, and the frequent allusion by Pliny to the medicinal plants of that country, we may conclude that the productions of the desert (where those herbs mostly grew) were particularly prized. See MEDICINE. The art of medicine was very ancient in Egypt, and some writers have supposed that Moses, having been instructed in all the learning of the Egyptians, must have known the chief secrets of medicine, a fact which they also infer from his accurate diagnosis, or indications concerning diseases. Though the Arabian physicians were in the Middle Ages the most skilful of their class, medical art in the East has long sunk into mere empiricism and merited contempt. It is, indeed, in the estimation of the common people, of far less utility than the employment of charms for the recovery of health, and is never resorted to till this means has failed. Roberts informs us, "Physicians in England would be perfectly astonished at the numerous kinds of medicine which are administered to a patient in India. The people themselves are unwill-

; to take one kind for long together, and I have own a sick woman swallow ten different sorts in one 7. Should a patient, when about to take his medicine, scatter or spill the least quantity, nothing will lue him to take the rest; it is a bad omen; he must ve the nostrum changed. The people of the East re a decided preference to external applications; nce, when they are directed to 'eat' or 'drink' medicine, they ask, Can they not have something to apply taide? For almost every complaint a man will ear his body with bruised leaves or saffron, or ashes certain woods or oils, and he professes to derive ore benefit from them than from those medicines hich are taken internally; at all events, he knows ey cannot do him so much harm. It ought to be served that they do not attach any miraculous effects the being 'anointed with oil.'" See DISEASES; HYSICIAN.

Cureton, WILLIAM, D.D., an eminent English dine and Orientalist, was born in 1808, and educated ; Christ Church, Oxford. He was ordained priest in 34, and was for a time sub-librarian of the Bodleian. n 1837 he became assistant keeper of the MSS. in the ritish Museum, which post he retained till 1849, when e was appointed to a canonry of Westminster and to be attached rectorship of the parish of St. Margaret's. wo years before that date he had been appointed haplain in ordinary to the queen. He was also a Fellow of the Royal Society, an honorary D.D. of Halle, orresponding member of the Institute of France, and member of the Asiatic Society of Paris, the Oriental ociety of Germany, and many other Continental societies. These honors he owed to his great reputation as an Orientalist, and especially as a Syriac scholar. This reputation was formed by his publications while an official in the British Museum. His *Corpus Ignati-um*, an edition of an ancient Syriac version of the Epistles of St. Ignatius, with commentaries thereon, was published in 1845, and gave rise to an interesting controversy. Among his subsequent works were an edition of a palimpsest of parts of Homer found in an Eastern convent, and his *Spicilegium Syriacum*, published in 1855. He was understood to be engaged on some work connected with St. Matthew's Gospel at the time of his death, June 17, 1863.

Curia Romāna, in the narrower sense, a collective appellation of all the authorities in Rome which exercise the rights and privileges enjoyed by the pope as supreme bishop of the Roman Catholic Church; in a wider sense, the collective appellation of all officers and authorities which assist the pope both in his secular and spiritual rule, or belong in any way to his retinue. In the following article we speak only of those authorities which assist the pope as supreme bishop, and in the papal court.

I. *Judicial Authorities*.—They are the following: 1. The *Rota Romana* (Italian, *Ruota Romana*), the supreme Court of the Roman Catholic Church, and in particular the highest court of appeal. See ROTA ROMANA. 2. The *Signatura Justitię*. It decides on the admissibility of appeals to the Rota, and consists of a cardinal as president (prefectus), seven (formerly twelve) voting prelates, some referendaries who prepare the reports on law cases, and have, with regard to them, a decisive vote. An *Auditor* of the Rota decides what matter may be brought before the Rota, and decides various preliminary questions; but appeal may be taken from his decisions to the full court of the *Signatura*. The decisions of the *Signatura* are signed by the pope with the word *Fiat*, or, in the presence and by order of the pope, by a cardinal, with the formula *Concessum in presentia Domini nostri Papę*. 3. The *Signatura gratię* decides on those cases on which a decision is expected from the personal grace of the pope, and which on that account must be expedited more promptly. The pope himself presides in this

college, which consists of cardinals appointed by him. The cardinal penitentiary, the secretary of the briefs, and the prefect of the dataria, belong to it in virtue of their office. The reports are made by three referendaries. The members have only a consultative vote. The pope alone decides, and signs personally all decisions.

II. *Boards of Administration*.—These are as follows: 1. *Secretaria Apostolica*. To it belong the *cardinal secretary of memorials*, who has to receive and report on all memorials not belonging to any other board, and the *cardinal secretary of briefs* (*cardinalis a secretis brevium*), who has to draw up certain papal briefs, which he signs and seals with the fisher's ring. This office is now part of the bureau of the *cardinal secretary of state for foreign affairs*, the leading officer of the papal government, who conducts the negotiations on Church affairs with all the foreign governments. The nuncios and other diplomatic agents of the papal government are his subordinates, receive from him his instructions, and have to report to him on the condition of the Church in those states to which they have been sent. His office employs a large number of clerks. In important questions he consults extraordinary "congregations," and even the regular congregation of ecclesiastical affairs. He reports to the pope on indulgences, on dispensations from the *defectus etatis, natalium, interdictorum*, and on *holy days*. 2. The *Dataria Apostolica* was formerly a board of expedition, but in the course of time has become an independent board of administration. Its president is called *datarius*, and if he is—as is usually the case—a cardinal, *prodatarius*. It has its name from the common subscription, *Datum apud Sanctum Petrum*. Within the jurisdiction of the *Dataria* belong the granting of certain privileges, of dispensations from certain cases of consanguinity, etc. Among the officers of the *Dataria* is the *officialis ad obitum*, to whom belongs the management of those ecclesiastical benefices which become vacant in consequence of the deaths of their occupants. The *Datarius*, after obtaining the consent of the pope, signs *Annuit Sanctissimus*. 3. The *Cancellaria Apostolica* (Apostolical Chancellory) issues bulls or briefs on all important subjects which have been transacted in the Consistory or in the *Dataria*. Its chief is a *cardinal vice-chancellor*, the name *vice-chancellor* having originated in the fact that formerly (until the thirteenth century) the honorary dignity of chancellor was conferred upon some foreign prelate, and having been retained since, although from that time the presidency of the Chancellory has always been vested in a cardinal. 4. The *Camera Apostolica* (the Apostolical Chamber) has the administration of the papal revenues. Its president is a cardinal chamberlain (*camerarius* or *camerlengo*). The ecclesiastical revenues having been greatly reduced in the course of time, the chief business of the Apostolical Chamber is the administration of the finances of the papal territory. 5. The *Penitentiaria Romana* (Penitentiary) acts in all cases of absolutions and dispensations which are reserved to the pope; as regards dispensations, however, only in secret cases, or in *foro interno*. The president of the board is a cardinal, who has the title *Penitentiarius Major*.

III. *The Papal Court, or the so-called "Papal Family" (Famiglia Pontificia)*.—It comprises the officers on service who live in the papal palace (*palatini*), besides a large number of honorary members. Among them are: 1. The *cardinales palatini*; namely, the cardinal secretary of state, the cardinal secretary of briefs, and the cardinal *prodatarius*. 2. The *prolatini palatini*, embracing a court marshal, a master of ceremonies, a master of the sacred palace (always a Dominican monk, who is also censor of the books published in Rome), the sacristan of the palace (always an Augustinian monk, who assists the pope in his private chapels), an *auditor sanctissimi* (a lawyer who is consulted

by the pope), a large number of privy chamberlains and of honorary domestic prelates (*prelati domestici*), and bishops assistant of the throne (*vescovi assistenti al soglio*). These latter titles are conferred on a large number of bishops and priests in all parts of the world. Among the earlier writings on the papal curia, the best is that by the chevalier Lunadoro, *Relazione della Corte di Roma* (Padua, 1641; many edit. since; latest edition, with all the necessary additions, Rome, 1830, 2 vols.). See also Dr. O. Mejer, *Die heutige römische Curie*, in Jacobson's *Zeitschrift für das Recht der Kirche* (Leips. 1847); Wetzler und Welte, *Kirchen-Lex.* ii, 944.

Curio (or **CURION**), **CELIUS SECUNDUS**, one of the Italian Reformers of the 16th century, was born at Chirico, near Turin, in 1508. He took an active part in the reformatory efforts made in Italy, and, in consequence of his teaching, was persecuted by the Roman Catholic priesthood at Milan, Pavia, and Lucca. He finally fled to Lausanne, where he became rector. Subsequently he was appointed professor of elocution at the University of Basel, in which city he died in 1569. He wrote, among others, the following works:—*Pasquilli ecstasici* (first edit. without year; again Geneva, 1544); *Pasquillorum tomi duo* (Basel, 1544); *Christianæ religionis institutio* (Basel, 1544); *De perfecto grammatico* (Basel, 1555); *Forum Romanum* (Basel, 1561, 8 vols. fol.); *Logicis Elementa* (Basel, 1569); *De bello Melitenensi* (Basel, 1567). He also published editions of several Roman classics.—Pierer, *Univ.-Lex.* iv, 590.

Curious Arts (*τὰ περίεργα*, literally *the sedulous things*, hence the term is applied to an over-officious person, e. g. a "busy-body," 1 Tim. v. 18), prop. *overwrought*, hence *magic* (see *Iren. adv. Hæres.* i, 20; Isidor. iii, 139; comp. *curiosus*, Horace, *Epod.* xvii, 77); spoken of the black art as practised by the Ephesian conjurers (Acts xix, 19; see Kuinöl, in loc.). The appropriateness of the term is shown by Deyling (*Observatt. Sacr.* iii, 277 sq.). The allusion is doubtless to the famous *Ephesian spells* (*Ἐφίσινα γράμματα*), i. e. charms or scraps of parchment (originating or most used at Ephesus) whereon were written certain marks and formulæ, which, like amulets, were worn upon the person as a safeguard against diseases, demons, and other evils (see Wagenseil, *Tela Ignea*, preface, p. 33; Ursinus, *Analect.* ii, 46; Dietric, *Antt. Biblic.* in loc.; Cellarius, *Disputt. Academ.* p. 441; Wolburg, *Observatt. Sacr.* p. 470; Laur. Rannires, in *Pentecostarch.* p. 214). See **DIVINATION**. They are frequently referred to in ancient writings (see Wetstein, *Kype*, etc. in loc.), e. g. Eustathius (*ad Hom. Odys.* i, p. 994, 35), "Ephesian letters: some say these were incantations which were of very great assistance to Cæresus when used by him at the stake; in the Olympic games, however, it is said that a certain Milesian failed to outstrip an Ephesian till the charm worn by the latter was discovered and removed" (comp. Erasmus, *Adagg. Center.* ii, 578). The phrase appears to have been applied to any talismanic inscription (Küster, *ad Suidam*, i, 919; Gale, *ad Jamblichum*, p. 290). Ortlieb, however, in his *Dias. de Ephesiorum libris combustis* (Lips. 1708), § 9, contends that the arts in question were rather methods of promoting the worship of the patron goddess of the city (see Wolf, *Curæ*, in loc.). The other and usual view is maintained by Siber (*Disputatio de περίεργα Ephesiorum*, Vitemb. 1685; also in *Thesaur. Dissertationum super N. T.* i, 484 sq.), and Schurzleisch (*Disseratio de libris Ephesius*, Vitemb. 1698). See **EPHESUS**.

Curse (the rendering of various Heb. and Greek words). God denounced his curse against the serpent which had seduced Eve (Gen. iii, 14), and against Cain, who had imbed his hands in his brother Abel's blood (iv, 11). He also promised to bless those who should bless Abraham, and to curse those who should curse

him. The divine maledictions are not merely imprecations, nor are they impotent wishes; but they carry their effects with them, and are attended with all the miseries they denounce or foretell. (See Zachar., *Threats of Scripture*, Oxford, 1658.) Holy men sometimes prophetically cursed particular persons (Gen. i, 25; xlix, 7; Deut. xxvii, 15; Josh. vi, 26), and history informs us that these imprecations had their fulfilment, as had those of our Saviour against the barren fig-tree (Mark xi, 21). But such curses are not consequences of passion, impatience, or revenge; they are predictions, and therefore not such as God condemns. See **IMPRECATION**. No one shall presume to curse his father or his mother (see **CORBAN**), on pain of death (Exod. xxi, 17); nor the prince of his people (xxii, 28); nor one that is deaf (Lev. xix, 14); whether a man really deaf be meant here, or one who is absent, and therefore cannot hear what is said against him. Blasphemy, or cursing of God, is punished with death (Lev. xxiv, 10, 11). Our Lord pronounces blessed those disciples who are (falsely) loaded with curses, and requires his followers to bless those who curse them; to render blessing for cursing, etc. (Matt. v, 11). The Rabbins say that Barak cursed and excommunicated Meroz, who dwelt near the brook Kieba, but who came not to assist Israel against Jabin. Wherefore Barak excommunicated him by the sound of four hundred trumpets, according to Judg. v, 23. But Meroz is more probably the name of a place.—Calmet. The Jews were cursed by the Almighty for rejecting the Messiah (Mal. iv, 6; see on this the dissertation of Iken, *De Anathemate*, etc., Brem. 1749). See **ANATHEMA**; **OATH**.

On the passage in Job (ii, 9), "Curse God and die." Mr. Roberts makes the following remarks: "Some suppose this ought to be, 'Bless God and die' (the Heb. is בָּרַךְ אֱלֹהִים); but Job would not have reproved his wife for such advice, except she meant it ironically. It is a fact, that when the heathen have to pass through much suffering, they often ask, 'Shall we make an offering to the gods for this?' that is, 'Shall we offer our devotions, our gratitude for afflictions?' Job was a servant of the true God, but his wife might have been a heathen; and thus the advice, in its most liberal acceptance, might have been in character. Nothing is more common than for the heathen, under certain circumstances, to curse their gods. Hear the man who has made expensive offerings to his deity, in hope of gaining some great blessing, and who has been disappointed, and he will pour out all his imprecations on the god whose good offices have, as he believes, been prevented by some superior deity. A man in reduced circumstances says, 'Yes, yes, my god has lost his eyes; they are put out; he cannot look after my affairs.' 'What!' said an extremely rich devotee of the supreme god Siva, after he had lost his property, 'shall I serve him any more? What! make offerings to him? No, no; he is the lowest of all gods.' What these facts before us, it is not difficult to believe that Job's wife actually meant what she said." See **JOA**.

Curtain, the rendering in the Auth. Vers. of three Hebrew terms.

1. **קַרְטִיּוֹן**, *qariyôn* (from its tremulous motion, invariably thus translated), the ten "curtains" of fine linen, etc., each twenty-eight cubits long and four wide, and also the eleven of goats' hair, which covered the tabernacle of Moses (Exod. xxvi, 1-13; xxxvi, 8-17). The charge of these curtains and of the other textile fabrics of the tabernacle was laid on the Gershonites (Num. iv, 25). Having this definite meaning, the word came to be used as a synonym for the tabernacle—its transitoriness and slightness—and is so employed in the sublime speech of David, 2 Sam. vii, 2 (where "curtains" should be "the curtain"), and 1 Chron. xvii, 1. In a few later instances the word bears the more general meaning of the sides of a tent, as in the

cautiful figure of Isa. liv, 2 (where "habitations" would be "tabernacles," תִּבְרִיטִים, poetic word for tents"); Jer. iv, 20; x, 20 (here "tabernacle" and tent" are both one word, תִּבְרִיט, tent); Psa. civ, 2 where "stretch," נָשַׁן, is the word usually employed or extending a tent). Also specially of nomadic people, Jer. xlix, 29; Hab. iii, 7 (of the black hair-cloth of which the tents of the real Bedouin are still composed); but Cant. i, 5 rather refers to the hangings of the palace. See TENT.

2. מַסַּק, *masak*, the "hanging" for the doorway of the tabernacle (Exod. xxvi, 86, 87; xxxv, 15; xxxvi, 7; xxxix, 88; xl, 5; Num. iii, 25; iv, 25); and also or the gate of the court round the tabernacle (Exod. xvii, 16; xxxv, 17; xxxviii, 18; xxxix, 40; xl, 38; Num. iii, 26; iv, 26). Among these the rendering "curtain" occurs but once (Num. iii, 26), while "hanging" is shared equally between *masak* and a very different word—מַלְאֵי, *kelai*. See HANGING. Besides "curtain" and "hanging," *masak* is rendered "covering" in Exod. xxxv, 12; xxxix, 34; xl, 21; Num. iv, 1; 2 Sam. xvii, 19; Psa. cv, 39; Isa. xxii, 8. The idea in the root of *masak* seems to be of shielding or protecting (קָשַׁר, Gesenius, *Theo. Heb.* p. 951). If this be so, the object denoted may have been not a curtain or veil, but an awning to shade the entrances—a thing natural and common in the fierce sun of the East (see Fergusson's *Nineveh and Persepolis*, p. 184).—Smith, l. v. See TABERNACLE. The sacred curtain separating the holy of holies from the sanctuary is designated by an entirely different term, פֶּתִיחַ, *peru* "keth" (Exod. xxvi, 31 sq.; Lev. xvi, 2; Num. xviii, 7, etc.). See VAIL.

most beneficial influence upon the religious life of the city. He also took a prominent part in many of the theological conferences of the Lutheran Church. Thus he was present at the "convent of Brunswick" in 1557, which was to settle the adiaphoristic controversies, and in 1561 at the "convent of Luneburg," when the "Luneburg Articles" were drawn up, which were incorporated with the symbolical books of Brunswick. Curtius is also the author of the so-called "Lubeck Formula" (*Formula consensus*, etc.), which he drew up in concert with the secular authorities and the entire clergy of the city. By it the ministers pledge themselves to abide by the doctrine of the prophets and the apostles, the Apostolic Creed, the Augsburg Confession, the Apology, and the Articles of Schmalkald. It was signed by Curtius and all the other ministers of Lubeck in 1560, and afterwards by all ministers appointed in Lubeck until 1683, when the signing of it was no longer required. Curtius also drew up, in the name of the clergy, a "*Protestatio contra Synodum Tridentinam*." He died Nov. 28, 1573.—Herzog, *Real-Encycl.* xix, 873; Starke, *Lüb. Kirch-Hist.* (Hamburg, 1724, 2 vols., where both the "*Formula Consensus*" and the *Protestatio* are printed).

CUSA, NICHOLAS DE, or CUSANUS, a cardinal of great learning. His name was properly NICHOLAS KREYFFS (KREBS), but he was named *Cusanus* or *De Cusa* from Cues on the Mosel, where he was born in 1401. He was the son of a poor fisher, who wished him to learn the same trade. Rather than comply with this request, Nicholas left the paternal home, and found employment with the count of Manderscheid, who, having discovered the eminent talent of his servant, sent him to the school of the Brothers of Common Life at Deventer, and subsequently to the University

of Padua. At the age of 23 Nicholas became doctor of law, but when he lost his first lawsuit he left the profession of law for the study of theology. Possessing a thorough knowledge of the Greek, Latin, and Hebrew languages, and a rare degree of eloquence, he soon attracted attention. After holding several ecclesiastical benefices at St. Wendel and Coblenz, he was present as archdeacon of the cathedral church of Liege at the Council of Basel, where he presented to the assembled bishops the celebrated work *De Concordantia Catholica*. This is one of the ablest works published during the Middle Ages in favor of the opinion that the pope is subordinate to an oecumenical council; it attacks the pretended donation

Awning before the Throne-room at Teheran.

8. סָוּ, *sav* (prop. *fineness*), fine cloth for a garment, specially a *curtain*, apparently a tent-covering of superior fineness (Isa. xl, 22), such as the rich Orientals spread for a *screen* over their courts in summer (Henderson, in loc.). See COURT.

Curtius, VALENTIN, a prominent Lutheran minister of the sixteenth century, was born at Lebus Jan. 6, 1498. He studied at the University of Rostock, and early entered the order of Franciscans. He was one of the earliest adherents of the Reformation of Luther, and became its leader, first in the city of Rostock, and subsequently in that of Lubeck. In 1554 he was appointed superintendent of all the churches of Lubeck, and in this position exercised a

tion of Constantine, and the authority of the false decretals, and insists on the reformation of the Church and the Germanic empire. Cusa was opposed to the dissolution of the council which was attempted by Eugene IV, and showed himself favorable to the reforms which the council decreed. But soon after he left the reformatory party and became an adherent of the pope, who added him to the legation which was sent over to Constantinople to dissuade the Greeks from going to Basel, and to induce them to go to Ferrara. After the rupture between the pope and the council, Cusa accompanied the papal legate, Thomas de Sarzana, on his missions to Germany and France. When the latter became pope, under the name of Nicholas V, Cusa was made a cardinal (1449), and bishop of Brixen, in the

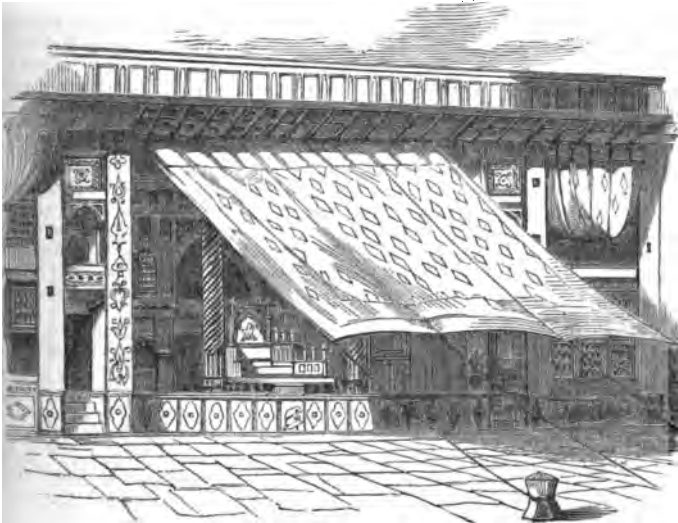

Tyrol, in 1459. He was also sent on important missions to Germany, England, and Prussia. Being charged with the re-establishment of ecclesiastical discipline in Holland, he acquitted himself of this task with great firmness. His reform measures in his own diocese involved him in a quarrel with the archduke Sigismund of Austria. Cusa excommunicated the archduke, who, in his turn, imprisoned the cardinal, and compelled him to agree to a compromise. The matter was not fully settled when the cardinal died at Todi in 1464.

The transition of Cusa from the reform party to the adherents of the court of Rome has by some writers been charged to ignoble motives; but, in view of the purity of his life, and the honesty of his purposes exhibited in all his public acts, most of the writers consider it as an honest change of opinion. It is thought that Cusa himself discovered the inconsistency of some of his views on the unity of the Church, the papal prerogatives, and the authority of the councils, as laid down in the work *De Concordantia Catholica*, and that, finding it necessary to discard the one or the other, he laid greater stress on the monarchical government of the Church than on the representative councils. This agrees with the strong attachment which Cusa shows to the monarchical principle in general. See Brockhaus, *Nicolas Cusani de concilio universalis potestate sententia explicatur* (Lpzg. 1867).

As a philosopher, Cusa was among the first to abandon the scholastic creed. "He arranged and republished the Pythagorean ideas, to which he was much inclined, in a very original manner, by the aid of his mathematical knowledge. He considered God as the unconditional Maximum, which at the same time, as *Absolute Unity*, is also the unconditional Minimum, and begets of himself and out of himself equality and the combination of equality with unity (Son and Holy Ghost). According to him, it is impossible to know directly and immediately this absolute unity (the Divinity), because we can make approaches to the knowledge of him only by the means of number or plurality. Consequently he allows us only the possession of very imperfect notions of God, and those by mathematical symbols. It must be admitted that the cardinal did not pursue this thought very consequently, and that his view of the universe, which he connected with it, and which represented the universe as the maximum condensed, and thus become finite, was very obscure. Nor was he more successful in his view of the oneness of the Creator and of creation, or in his attempt to explain the mysteries of the Trinity and Incarnation by means of this pantheistic theism. Nevertheless, numerous profound though undeveloped observations on the faculty of cognition are found in his writings, interspersed with his prevailing mysticism. For instance, he observes that the principles of knowledge possible to us are contained in our ideas of number (*ratio explicata*) and their several relations; that absolute knowledge is unattainable to us (*græcio veritatis inattingibilis*, which he styled *docta ignorantia*), and that all which is attainable to us is a *probable* knowledge (*conjectura*). With such opinions he expressed a sovereign contempt for the dogmatism of the schools." The works of Cusa were published in 1514 at Paris (3 vols. fol.), and again in 1565 at Basel (3 vols. fol.). The latter edition is the more complete. See Tennemann, *Manual Hist. Phil.* § 286; Scharpff, *Der Cardinal und Bishop Nic. von Cusa* (vol. i, Mainz, 1848; the 2d vol. has not appeared); Düx, *Der deutsche Cardinal Nic. von Cusa* (Ratisbon, 1847, 2 vols.); Clemens, *G. Bruno und N. von Cusa* (Bonn, 1847); Zimmermann, *Cusa als Vorläufer Leibnitzens* (Vienna, 1852).

Cush (Heb. *Kush*, כּוּשׁ, deriv. uncertain; A. V. "Cush," Gen. x, 6, 7, 8; 1 Chron. i, 8, 9, 10; Psa. vii, title; Isa. xl, 11; "Ethiopia," Gen. ii, 13; 2 Kings xix, 9; Eth. i, 1; viii, 9; Job xxviii, 19; Psa. lxxviii,

31; lxxxvii, 4; Isa. xviii, 1; xx, 3, 5; xxxv, 4; xliii, 8; xlv, 14; Ezek. xxix, 10; xxx, 4, 5; xxxv, 5; Nah. iii, 9; Zeph. iii, 10; "Ethiopsians," Isa. xlv, 4; Jer. xlvi, 9; Ezek. xxx, 9), the name of two lands and of the territory or territories occupied by the descendants of one of them.

1. (Sept. *Χούς*, Vulg. *Chus*.) A son (apparently the eldest) of Ham. B. C. cir. 2510. In the genealogy of Noah's children Cush seems to be an individual for it is said "Cush begat Nimrod" (Gen. x, 9; Chron. i, 10). If the name be older than his time, he may have been called after a country allotted to him. The following descendants of Cush are enumerated: his sons, Seba, Havilah, Sabtah or Sabta, Rameah and Sabtechah or Sabtecha; his grandsons, the sons of Raamah, Sheba and Dedan; and Nimrod, who, mentioned after the rest, seems to have been a more potent descendant than they, the text not necessarily proving him to have been a son. See HAM. The only direct geographical information given in this passage is with reference to Nimrod, the beginning of whose kingdom was in Babylonia, and who afterwards went, according to the reading which we prefer, into Assyria, and founded Nineveh and other cities. The reasons for our preference are: (1) that if we read "Out of that land went forth Asshur," instead of "he went forth [into] Asshur," i. e. Assyria, there is no account given but of the "beginning" of Nimrod's kingdom; and (2) that Asshur the patriarch would seem here to be quite out of place in the genealogy.—Smith, s. v. See NIMROD.

LAND OF CUSH.—From the eldest son of Ham (Gen. x, 6; 1 Chron. i, 8) seems to have been derived the name of the land of Cush, which is commonly rendered by the Sept. Αἰθιοπία, and by the Vulgate *Æthiopia*, in which they have been followed by almost all other versions, ancient and modern. The German translation of Luther has *Mohrenland*, which is equivalent to Negroland, or the Country of the Blacks. A nation was called *Cushî* (כּוּשִׁי, Αἰθίοψ, *Æthiops*, Jer. xli, 2), the feminine of which was *Cushîth* (כּוּשִׁית, Αἰθίοπισσα, *Æthiopiessa*, Num. xii, 1), and the plural, *Cushîm* (כּוּשִׁים, Αἰθίοπες, *Æthiopes*, Amos ix, 7). See ETHIOPIAN. "Of the four sons of Ham," says Josephus (*Ant.* i, 6, 2), "time has not at all hurt the name of Chus; for the Ethiopians over whom he reigned are even at this day, both by themselves and by all men in Asia, called *Chusites*." The Peshito Syriac version of Acts viii, 27, styles both queen Candace and her treasurer *Cushacoms*. See CANDACE.

The locality of the land of Cush is a question upon which eminent authorities have been divided; for while Bochart (*Phaleg*, iv, 2) maintained that it was exclusively in Arabia, Gesenius (*Lex. in voce*) held with no less pertinacity, that it is to be sought for nowhere but in Africa. In this opinion he is supported by Schultzeus of Zurich, in his *Paradies* (p. 11, 16). Others again, such as Michaelis (*Spicileg. Geogr. Bæd. Est.* cap. 2, p. 287) and Rosenmüller (*Bibl. Geogr.* by Morren, i, 80; iii, 280), have supposed that the name Cush was applied to tracts of country both in Arabia and Africa—a circumstance which would easily be accounted for on the very probable supposition that the descendants of the primitive Cushite tribes who had settled in the former country emigrated across the Red Sea to the latter region of the earth, carrying with them the name of Cush, their remote progenitor. This idea had been developed by Eichhorn (*De Cushæis*, Ohrdurf, 1774). The term Cush is generally applied in the Old Testament to the countries south of the Israelites. It was the southern limit of Egypt (Ezek. xxix, 10), and apparently the most westerly of the provinces over which the rule of Ahasuerus extended, "from India even unto Ethiopia" (Esth. i, 1; viii, 9). Egypt and Cush are associated in the majority of instances in which the word occurs (Psa. lxxviii,

; Isa. xviii, 1; Jer. xlvi, 9, etc.); but in two passages Cush stands in close juxtaposition with Elam (a. xi, 11) and Persia (Ezek. xxxviii, 5). The Cush-king, Zerah, was utterly defeated by Asa at Mareah, and pursued as far as Gerar, a town of the Philistines, on the southern border of Palestine, which is apparently under his sway (2 Chron. xiv, 9, etc.).

2 Chron. xxi, 16, the Arabians are described as dwelling "beside the Cushites," and both are mentioned in connection with the Philistines. The wife Moses, who, we learn from Exod. ii, was the daughter of a Midianite chieftain, is in Num. xii, 1, denominated a Cushite. Further, Cush and Seba (Isa. xliii, 3), Cush and the Sabaeans (Isa. xlv, 14), are associated in a manner consonant with the genealogy of the descendants of Ham (Gen. x, 7), in which Seba is the son of Cush. From all these circumstances it is evident that under the denomination Cush were included the Arabian and the country south of Egypt on the eastern coast of the Red Sea. It is possible also that the vast desert tracts west of Egypt were known to the Hebrews as the land of Cush, but of this we have no certain proof. The Targumist on Isa. xi, 11, sharing the prevailing error of his time, translates Cush by India, but that a better knowledge of the relative positions of these countries was anciently possessed is clear from Esth. i, 1.

Some have sought for another Cush in more northerly regions of Asia, as in the Persian province of *Kusistan* or *Susiana*, in *Cuthah*, a district of *Babylonia*, etc.; and as Nimrod, the youngest son (or descendant) of Cush, spread his conquests in that direction, it is no doubt possible that his father's name might be preserved in the designation of some part of the territory or people. But here again the data are not very satisfactory; indeed, the chief thing which led to the supposition is the mention, in the description of the site of Paradise (Gen. ii, 13), of a land of Cush, compassed by the river Gihon. Yet, even though the name of Cush were more variously applied in Scripture than it really is, it would not be more so than was the corresponding term Ethiopia among the Greeks and Romans, which comprised a great many nations far distant, as well as wholly distinct from each other, and having nothing in common but their swarthy, sun-burnt complexion—*Αἰθίοψ* q. d. *αἰθῆς ῥίζη ὄψιν*, i. e. "burnt-black in the face." Homer (*Odys.* i, 22) speaks of them as "a divided race—the last of men—some of them at the extreme west, and others at the extreme east." Strabo (i, 60) describes them as a "two-fold people, lying extended in a long tract from the rising to the setting sun." Herodotus (vii, 69, 70) distinguishes the eastern Ethiopians in Asia from the western Ethiopians in Africa by the straight hair of the former and the curly hair of the latter. The ancients, in short, with the usual looseness of their geographical definitions, understood by Ethiopia *the extreme south* in all the earth's longitude, and which, lying, as they thought, close upon the fiery zone, exposed the inhabitants to the sun's scorching rays, which burned them black. It is the mistaken idea of the scriptural term "Cush" being used in the same vague and indeterminate manner that has led to so much confusion on this subject; and one writer (Buttmann, *Allg. Erdk. d. Morgenl.* p. 40, note), in his desire to carry out the parallel between Ethiopia and Cush, derives the latter word from the root כָּוַח (*kavh*, *kaw*, *ku*), "to burn;" but that is opposed to all the rules of etymological analogy in the formation of Hebrew proper names (comp. Ritter's *Erdkunde*, i, 222; Heeren's *African Nations*, Engl. transl. i, 289). See CUTH.

1. The existence of an African Cush cannot reasonably be questioned, though the term is employed in Scripture with great latitude, sometimes denoting an extensive but undefined country (Ethiopia), and at

other times one particular kingdom (Meroë). It is expressly described by Ezekiel as lying to the south of Egypt beyond Syene (xxix, 10; comp. xxx, 4-6.—Strabo, xvii, 817; Pliny, *Hist. Nat.* vi, 35; Josephus, *War*, iv, 10, 5). Its limits on the west and south were undefined; but it was probably regarded as extending eastward as far as the Red Sea, if not as including some of the islands in that sea, such as the famous Topaz Isle (Job xxviii, 19; Pliny, *Hist. Nat.* vi, 29; xxxvii, 8; Strabo, xvi, 4, 6; Diod. Sic. iii, 89). It thus corresponded, though only in a vague and general sense, to the countries known to us as Nubia and Abyssinia, so famous for the Nile and other great rivers. Hence the allusions in Scripture (Isa. xviii, 1; Zeph. iii, 11) to the far-distant "rivers of Ethiopia," a country which is also spoken of (Isa. xviii, 2) in our version as the land "which the rivers have spoiled," there being a supposed reference to the ravages committed by inundations (Bruce's *Travels*, iii, 158, and Taylor's *Calmet*, iii, 598-4); but recent translators prefer to render נִינְיָ by "divide," q. d. "a land intersected by streams." Isaiah likewise takes notice (in the above passage) of the "bulrush"-boats, or vessels of papyrus, which the Ethiopians employed upon the waters, a fact which is confirmed by Heliodorus in his *Ethiopia* (x, 460), and also by Bruce, who states that the only kind of boat in Abyssinia is that called *tancoa*, which is made of reeds, "a piece of the acacia-tree being put in the bottom to serve as a keel, to which the plants are joined, being first sewed together, then gathered up at stem and stern, and the ends of the plants tied fast there." It is to the swiftness of these papyrus vessels that Job (ix, 26) compares the rapid speed of his days. From its proximity to Egypt we find Mizraim and Cush (i. e. Egypt and Ethiopia) so often classed together by the prophets (e. g. Psa. lxxviii, 31; Isa. xi, 11; xx, 4; xliii, 8; xlv, 14; Nah. iii, 9). The inhabitants are elsewhere spoken of in connection with the Lubim and Sukkiim (2 Chron. xii, 8; xvi, 8; Jer. xlvi, 7; Dan. xi, 48), supposed to be the Libyans and Ethiopic Troglodytes, and certainly nations of Africa, for they belonged to the vast army with which Shishak, king of Egypt, "came out" of that country against Rehoboam, king of Judah. In these, and indeed in most other passages where "Cush" occurs, Arabia is not to be thought of; the Ethiopia of Africa is beyond all doubt exclusively intended. See ETHIOPIA.

In the ancient Egyptian inscriptions Ethiopia above Egypt is termed *Kesh* or *Kesh*, and this territory probably corresponds perfectly to the African Cush of the Bible (Wilkinson, *Anc. Eg.* i, 404, abridgment). The Cushites, however, had clearly a wider extension, like the Ethiopians of the Greeks, but apparently with a more definite ethnic relation. The settlements of the sons and descendants of Cush mentioned in Gen. x, may be traced from Meroë to Babylon, and probably on to Nineveh. Thus the Cushites appear to have spread along tracts extending from the higher Nile to the Euphrates and Tigris. Philological and ethnological data lead to the same conclusion. There are strong reasons for deriving the non-Shemitic primitive language of Babylonia, variously called by scholars Cushite and Scythic, from an ante-Shemitic dialect of Ethiopia, and for supposing two streams of migration from Africa into Asia in very remote periods; the one of Nigritians through the present Malayan region, the other and later one of Cushites, "from Ethiopia properly so called, through Arabia, Babylonia, and Persia, to Western India" (Poole, *Genesis of the Earth*, p. 214 sq.). Sir H. Rawlinson has brought forward remarkable evidence tending to trace the early Babylonians to Ethiopia, particularly the similarity of their mode of writing to the Egyptian, and the indication in the traditions of Babylonia and Assyria of "a connection in very early times between Ethiopia, Southern Arabia

and the cities on the Lower Euphrates," the Cushite name of Nimrod himself as a deified hero being the same as that by which Meroë is called in the Assyrian inscriptions (Rawlinson's *Herod.* i, 353 n.). History affords many traces of this relation of Babylonia, Arabia, and Ethiopia. Zerah the Cushite (A. V. "Ethiopian"), who was defeated by Aas, was most probably a king of Egypt, certainly the leader of an Egyptian army; the dynasty then ruling (the 22d) bears names that have caused it to be supposed to have had a Babylonian or Assyrian origin, as Sheehonk, Shishak, Sheshak; Namuret, Nimrod; Tekrut, Teklut, Tiglath. The early spread of the Mizraites illustrates that of the Cushites [see CAPHTOR]; it may be considered as a part of one great system of migrations. On these grounds we suppose that these Hamite races, very soon after their arrival in Africa, began to spread to the east, to the north, and to the west; the Cushites establishing settlements along the southern Arabian coast, on the Arabian shore of the Persian Gulf and in Babylonia, and thence onward to the Indus, and probably northward to Nineveh; and the Mizraites spreading along the south and east shores of the Mediterranean, on part of the north shore, and in the great islands. These must have been seafaring peoples, not wholly unlike the modern Malays, who have similarly spread on the shores of the Indian Ocean. They may be always traced where very massive architectural remains are seen, where the native language is partly Turanian and partly Shemitic, and where the native religion is partly cosmic or high-nature worship, and partly fetishism or low-nature worship. These indications do not fail in any settlement of Cushites or Mizraites with which we are well acquainted. See ETYMOLOGY.

But that part of this vast region of Cush which seems chiefly intended in these and most other passages of Scripture is the tract of country in Upper Nubia which became famous in antiquity as the *kingdom of Ethiopia*, or the state of Meroë. The Ethiopian nations generally ranked low in the scale of civilization; "nevertheless," says Heeren, "there did exist a better cultivated, and, to a certain degree, a civilized Ethiopian people, who dwelt in cities; who erected temples and other edifices; who, though without letters, had hieroglyphics; who had government and laws; and the fame of whose progress in knowledge and the social arts spread in the earliest ages over a considerable part of the earth." Meroë Proper lay between the river Astaboras (now the Atbara or Tacazzé) on the east, and the Nile on the west. Though not completely enclosed with rivers, it was called an island, because, as Pliny observes, the various streams which flowed around it were all considered as branches of the Nile, so that to it the above description of a "country of rivers" was peculiarly appropriate. Its surface exceeded that of Sicily more than a half, and it corresponded pretty nearly to the present province of Atbara, between 18° and 18° N. lat. In modern times it formed a great part of the kingdom of Sennaar, and the southern portion belongs to Abyssinia. Upon the island of Meroë lay a city of the same name, the metropolis of the kingdom, the site of which has been discovered near a place called Assur, about twenty miles north of the town of Shendy, under 17° N. lat. The splendid ruins of temples, pyramids, and other edifices found here and throughout the district have been described by Caillaud, Gau, Ruppell, Belzoni, Waddington, Hoskins, and other travellers, and attest the high degree of civilization and art among the ancient Ethiopians. See MEROË.

Josephus, in his account of the expedition of Moses when commander of the Egyptian army against the Ethiopians, says that the latter "at length retired to Saba, a royal city of Ethiopia which Cambyses afterwards called Meroë, after the name of his own sister" (*Ant.* ii, 10, 2). The same origin of the name is given both by Strabo and Diodorus Siculus, but see Man-

ner's *Geog. of the Greeks and Romans*, x, 199. This is still a place called *Meroë* considerably north of the island and near Mount Berkal, where Heeren thinks there may have been a settlement of the parent race called by the same name. The opinion of Josephus that Meroë was identical with Seba accords well with the statement in Gen. x, 7, that Seba was the eldest son of Cush, whose name (שֶׁבַע) is not to be confounded with either of the Shebas (שֶׁבַשׁ), who are mentioned as descendants of Shem (Gen. x, 28; xxi, 1). Now this country of African Seba is classed with Arabian Seba as a rich but far-distant land (*Fa.* lxxii, 10). In Isa. xliii, 3, God says to Israel, "I have given Egypt for thy ransom; Cush and Seba in thy stead;" and in Isa. xlv, 14, "The wealth of Egypt, and the merchandise of Cush and of the Sebalim, men of stature, shall pass over to thee, and shall be thine." Charles Taylor, the ingenious but fanciful editor of *Calmet*, had the singular notion that by the expression "men of stature" in that passage is meant men of short measure, or dwarfs; and hence he identifies the Ethiopians with the pygmies of antiquity (*Progress to Calmet*, ccxxii). But the Hebrew phrase plainly denotes "tallness of stature" (comp. 1 Chron. xi, 25), and the Ethiopians are described by Herodotus as of gigantic stature (*ἀνθρώπων μέγιστος*, iii, 114; *μέγιστος ἀνθρώπων*, iii, 20); and Solinus affirms that they were twelve feet in height (*Polyhist.* cap. xxx). In common with the other Cushite tribes of Africa the skin was black, to which there is an obvious allusion in Jer. xiii, 23: "Can the Cushite change his skin?" Bruce finds Seba in Azab, a sea-port on the east coast of Africa, near the entrance to the Red Sea, and in this it is followed by Heeren, while others think of a place called Subah, about lat. 15° N., where are some of the most remarkable ruins of Nubian grandeur; but both opinions are merely conjectural. See SEBA.

Among other tribes of Africa said to have been in alliance with Egypt, the prophet Ezekiel (xxx) mentions along with Ethiopia the name of *Chub*, which Michaelis connects with *Kobé*, a trading town described by Ptolemy as on the west coast of the Red Sea. But in the Arabic translation made from the Septuagint, instead of *Chub* we find "the people of Nubia," a name easily interchanged for the other, and in some Heb. MSS. actually read there. There are still two districts adjoining Meroë on the south-west, called *Cuba* and *Nuba*, which are said to abound in gold. The *Sukkim*, who, along with the Cushites and Lubim or Libyans, formed part of the host of Shishak (2 Chron. xii, 8), are in the Sept. designated as *Trochodytes*, i. e. cave-dwellers, and were no doubt the people known to the Greeks by the same name as inhabiting the mountain caverns on the west coast of the Red Sea (*Diod. Sic.* iii, 82; *Strabo*, xvii, p. 786). They were noted for swiftness of foot and expertness in the use of the sling, and hence were employed, as Herodotus informs us (*Æthiopia*, viii, 16), as light troops. Pliny makes mention of a town of *Sucke* in that region (*Hist. Nat.* vi, 29, 84), and there is still on the same coast a place called Suakim, described by Burckhardt in his *Travels in Nubia*. If, however, the term *Sukkim* be of Hebrew derivation, it would specially denote those who lived in booths, i. e. tabernacles made of the boughs of trees; and it deserves remark that the Shangallas who inhabit that country still dwell during the good season in arbors fitted up for tents, repairing in winter to their rocky caves. See CHUB.

In the age of Herodotus, the countries known to us as Nubia and Sennaar were occupied by two different races, one of whom he includes under the general appellation of Ethiopians, the other an immigratory Arabian race leading, for the most part, a nomadic life. This distinction has continued down to the present day. Among the original inhabitants the first place is due to the Nubians, who are well-formed, strong, and mus-

lar, and with nothing whatever of the negro physiognomy. They go armed with spear, sword, and a shield of the skin of the hippopotamus. South of Angola is the country of the Scheygias, whose warriors are horsemen, also armed with a double-pointed spear, a sword, and a large shield (comp. Jer. xli, 9, the "Cushites who handle the shield"). They were completely independent till subdued by Mehemet Ali, Pasha of Egypt. It is in their country that the pyramidal monuments which adorned the ancient Meroë were first met with, and even its name has been preserved in that of their chief place, Merawé, though the original Meroë must be sought farther south. Next comes the territory of the Berbers, strictly so called, who, though speaking Arabic, evidently belong to the Nubian race. Above these regions, beyond the Tazazzé, and along the Nile, the great mass of the inhabitants, though sometimes with a mixture of other blood, may be regarded as of Arab origin. But between the valley of the Nile and the Red Sea there is still, as of old, a variety of scattered aboriginal tribes, among whom the Arabic is much less common; they are, doubtless, partly the descendants of the above-mentioned Sukkiim, or Troglodytes, and of the Ichthyophagi, or fish-eaters. Some of them spread themselves over the plains of the Astaboras, or Tacazzé, being compelled to remove their encampments, sometimes by the inundations of the river, at other times by the attacks of the dreaded simé, or gad-fly, described by Bruce, and which he supposes to be the "fly which is in the utmost part of the rivers of Egypt" (Isa. vii, 18). Another remarkable Ethiopic race in ancient times was the *Macrobians*, so called from their supposed longevity. They were represented by the ambassadors of Cambyses as a very tall race, who elected the highest in stature as king: gold was so abundant that they bound their prisoners with golden fetters—circumstances which again remind us of Isaiah's description of Ethiopia and Seba in ch. xlv, 14. (See Ludolf, *Hist. Ethiopica*, F. ad M. 1681; with his *Commentaries* thereon, ib. 1691; and his *Hodiern. Habes. status*, ib. 1698). See AFRICA.

2. That some of the posterity of Cush settled in the south of Arabia may readily be granted; but that he gave a permanent name to any portion either of the country or people is by no means so evident: it is, at least, more a matter of inferential conjecture than of historical certainty. Almost all the passages usually cited in support of the averment are susceptible of a different interpretation. (1.) For example, in Num. i, 21, Miriam and Aaron are said to have taken offence at Moses for having married "a Cushitea;" and upon the presumption that this was the same person as Zipporah, daughter of the priest of Midian (Exod. ii, 16, 21), it is inferred that Midian was in Cush. But, to say nothing of Zipporah's high rank, or of the services of her family to Israel, there would have been something so grossly incongruous and absurd in Moses's brother and sister complaining for the first time of his selection of a wife, after the marriage had subsisted for more than forty years, that it is evident Zipporah was now dead, and this second wife, though doubtless a proselyte to Judaism, was (whether born in Asia or Africa) a descendant of Cush, and therefore a *Hamite*, and not one of the Midianites, who were of *Semitic* origin, being the children of Abraham by Keturah. But, admitting that it is a second marriage which is thus referred to, the case is not materially altered, for still Cush must be sought near the place of Israel's encampment, as it cannot be supposed that Moses would go to Ethiopia to fetch a wife. See ZIPPORAH. (2.) Others discover a connection between Cush and Midian, because in Hab. iii, 7, the clause, "I saw the tents of Cushan in affliction," finds a parallelism in "the curtains of the land of Midian did tremble"—Cushan being held to be the poetical and high-sounding form of Cush. But this idea is met by another

identification; for while it is acknowledged that part of the sublime description in that chapter refers to the Exodus and the transactions at Sinai, other portions (such as the passage of the Jordan, verse 8, and the standing still of the sun, verse 11) have plainly a reference to incidents in the books of Joshua and Judges. Now in the latter book (iii, 10; viii, 12) we find a record of signal victories successively obtained by Othniel over *Cushan* Rishathaim, king of Mesopotamia, and by Gideon over the princes of *Midian*. See CUSHAN. (3.) But perhaps a stronger argument is the mention of Arabians as contiguous to the Cushites. Thus, in 2 Chron. xxi, 16, among those who were stirred up against the Hebrews are mentioned the Philistines, and "Arabs that were near the Cushites," and the expression "near" (רַב לַצֵּד) in this connection can scarcely apply to any but dwellers in the Arabian peninsula. Other arguments adduced by Michaelis (*Spicileg. Geograph. Hebr.* i, 149) in favor of the Arabian Cush are not decisive, and the passages on which he relies apply with greater probability to the African Cush. Thus the retreat of Sennacherib from Judæa in order to meet Tirhakah (2 Kings xix, 9; Isa. xxxvii, 9) does not necessarily imply that the latter passed through Palestine, since the Egyptians had reached Carchemish on the Euphrates without doing so (2 Chron. xxxv, 20), and Tirhakah was undoubtedly an African prince. See TIRHAKAH. Again, it has been rashly concluded that Zerah the Cushite, who attacked Asa, king of Judah, with so immense a host (2 Chron. xiv, 9), could not have been an Ethiopian of Africa, and yet the fact of his army having included Libyans (xvi, 8) as well as Ethiopians, seems decisive of the fact that the latter were of African origin. Their ancestors may have belonged to the "people without number" whom Shishak had led forth against Asa's grandfather, Rehoboam (xii, 8), and these their descendants may have retained possession of the north of Arabia Petrea, between Palestine and Egypt (see Bruce's *Travels*, i, 30). See ZERAH.

Yet, though there is a great lack of evidence to show that the name of Cush was ever applied to any part of Arabia, there seems no reason to doubt that a portion of the Cushite race did early settle there. According to the ethnographic table in the 10th chapter of Genesis, Cush was the father of Seba, Havilah, Sabta, Raamah (whose sons were Sheba and Dedan), Sabtechah, and also of Nimrod (Gen. x, 7, 8; 1 Chron. i, 9, 10). The last mentioned appears to have moved northward, first into Babylonia and then into Assyria, but the others seem to have migrated to the south, though it is impossible accurately to trace out their settlements. Yet, even if we give Seba to Africa, and pass over as doubtful the names of Havilah, Sheba, and Dedan (for these were also the names of Semitic tribes, Gen. x, 28, 29; xxv, 8), still, in Ezek. xxvii, 22, Raamah is plainly classed with the tribes of Arabia, and nowhere are any traces of Sabtah and Sabtechah to be found but in the same country. By referring, however, to the relative geographical positions of the south-west coast of Arabia and the east coast of Africa, it will be seen that nothing separates them but the Red Sea, and it is not unlikely that while a part of the Cushite population immigrated to Africa, others remained behind, and were occasionally called by the same name. In the fifth century of our era, the Himarites, in the south of Arabia, were styled by Syrian writers Cushæans and Ethiopians (Assemani, *Bibl. Orient.* i, 360; iii, 568). The Chaldee paraphrast Jonathan, at Gen. 6, and another paraphrast at 1 Chron. i, 8, explain "Cush" by Arabia. Niebuhr (*Beschr.* p. 289) found in Yemen a tribe called *Bens Chusi*. The book of Job (xxviii, 19) speaks of the topaz of Cush, and there was a Topaz Island in the Red Sea (Diod. Sic. iii, 89; Pliny, *Hist. Nat.* xxxvii, 8; Strabo, xvi, 4, 6). Yet most of these are circumstances

upon which we can lay but little stress; and the passage in 2 Chron. xxi, 16, is the only direct evidence we possess of the name "Cush" being applied in Scripture to any part of Arabia, and even that does not amount to absolute demonstration. See ARABIA.

3. Cush, as a country, therefore appears to be African or Arabian in all passages except Gen. ii, 18. We may thus distinguish a primeval and a post-diluvian Cush. The former was encompassed by Gihon, the second river of Paradise: it would seem, therefore, to have been somewhere to the northward of Assyria. See GIHON. From etymological considerations, Huët was induced to place Cush in Chusistan (called Cutha, 2 Kings xvii, 24), Leclerc in Cassiotis in Syria, and Reland in the "regio Cosæorum." Bochart identified it with Susiana, Link with the country about the Caucasus, and Hartmann with Bactria or Bálkh, the site of Paradise being, in this case, in the celebrated vale of Kashmir. It is possible that Cush is in this case a name of a period later than that to which the history relates, but it seems more probable that it was of the earliest age, and that the African Cush was named from this older country. Most ancient nations thus connected their own lands with Paradise, or with primeval seats. In this manner the future Paradise of the Egyptians was a sacred Egypt watered by a sacred Nile; the Arabs have told of the terrestrial paradise of Sheddad the son of Ad (q. v.) as sometimes seen in their deserts; the Greeks located the all-destroying floods of Ogyges and Deucalion in Greece; and the Mexicans seem to have placed a similar deluge in America—all carrying with them their traditions, and fixing them in the territories where they established themselves. We are told that, in the Hindoo mythology, the gardens and metropolis of Indra are placed around the mountain Méru, the celestial north pole; that, among the Babylonians and Medo-Persians, the gods' mountain, Alborj, "the mount of the congregation," was believed to be "in the sides of the north" (Isa. xiv, 13); that the oldest Greek traditions point northwards to the birthplace of gods and men; and that, for all these reasons, the Paradise of the Hebrews must be sought for in some far-distant hyperborean region. Guided by such unerring indications, Hassé (*Entdeckungen*, p. 49, 50, n.) scrupled not to gratify his national feeling by placing the Garden of Eden on the coast of the Baltic; Rudbeck, a Swede, found it in Scandinavia; and the inhospitable Siberia has not been without its advocates (Morren, Rosenmüller's *Geog.* i, 96). But, with all this predilection in favor of the north, the Greeks placed the gardens of the Hesperides in the extreme west, and there are strong indications in the Puráns "of a terrestrial paradise, different from that of the general Hindu system, in the southern parts of Africa" (*As. Res.* iii, 300). Even Méru was no further north than the Himalayan range, which the Aryan race crossed in their migrations.—Kitto, s. v.; Smith, s. v. See EDEN.

2. (Sept. *Xovoi*, Vulg. *Chusi*.) A Benjamite, apparently at the court of Saul, by the name of Cush is mentioned in the title of Psalm vii, respecting whom nothing more is known than that the psalm is there said to have been composed "concerning his words" (or affairs). B.C. 1061. "There is every reason to believe this title to be of great antiquity (Ewald, *Psalmen*, p. 9). Cush was probably a follower of Saul, the head of his tribe, and had sought the friendship of David for the purpose of 'rewarding evil to him who was at peace with him'—an act in which no Oriental of ancient or modern times would see any shame, but, if successful, the reverse. Happily, however, we may gather from ver. 15 that he had not succeeded." By some (see Poole's *Synopsis*, in loc.) he is believed to have been Saul himself (see Hengstenberg, in loc.); by others he is identified with Shimei (see Pfeiffer, *Dict. Vexata*, in *Opp.* i, 297), who treated David so scurrilously on his retreat from Absalom (2 Sam. xvi, 5-8).

A recent view (Kitto's *Daily Illustrations*, in loc.) that this was the name of some treacherous informant in David's corps, through fear of whose intrigues he fled the second time to Achish (1 Sam. xxvii, 1); (see Calmet's *Comment.* in loc.), most probably, and of Saul's malicious courtiers, as no good reason can be given for calling so well-known characters as either Saul or Shimei by so fanciful a title as Cush.—Smith. See DAVID.

Cu'shan (Heb. *Kushan'*, קוּשָׁן; Sept. *Aithiops*; Vulg. *Ethiopia*), usually regarded as a prolonged poetic form (Hab. iii, 7) of the name of the land CUSH (q. v.), but perhaps rather the same as *Cushan-rihathaim* (A. V. "Chushan-"), king of Mesopotamia (Judg. iii, 8, 10). The order of events alluded to in the prophet seems to favor this supposition. First it appears to refer to former acts of divine favor (ver. 1), he then speaks of the wonders at the giving of the Law, "God came from Teman, and the Holy One from Mount Paran;" and he adds, "I saw the tent of Cushan in affliction: [and] the tent-curtains of the land of Midian did tremble," as though referring to the fear of the enemies of Israel at the manifestation of God's favor for his people. *Chushan-rihathaim* the first recorded oppressor of the days of the Judges may have been already reigning at the time of the entrance into Palestine. The Midianites, certainly allied with the Moabites at that time, feared the Israelites and plotted against them (Num. xxii, xxiii, xxiv, xxv); and it is noticeable that Balaam was sent for from Aram (xxiii, 7), perhaps the Aram-naharaim of the oppressor. Habakkuk afterwards alludes to the crossing of Jordan or the Red Sea, or both (ver. 8-14, 15), to the standing still of the sun and moon (11); and apparently to the destruction of the Canaanites (12, 13, 14).—Smith, s. v. There is, however, good reason for the supposition that *Cushan* here stands for an Asiatic Cush (see *Meth. Quar. Rev.* Jan. 1861, p. 81); as it is named in connection with Midian (q. v.). Delitzsch (*Der Prophet Habakuk*, Leips. 1848, p. 159), who admits only the African Cush, holds that its mention along with Midian is intended to show how places so far removed from each other were equally affected by the theophany; but this is exceedingly strained, and at variance with the parallelism of the passage. See CHUSHAN-RIHATHAIM.

Cu'shi (Heb. *Kushi'*, קוּשִׁי, q. d. *Cushite* or *Ethiopian*; Sept. *Xovoi*; Vulg. *Chusi*), a name of three men in the Old Test. See CUSH.

1. (With the article, קוּשִׁי, i. e. "the Cushite," "the Ethiopian;" Sept. *ὁ Χοῦσι*; Vulg. *Chusi*.) The messenger sent by Joab to announce to David the success of the battle against Absalom and the death of the young prince (2 Sam. xviii, 21, 22, 23, 31, 32). B.C. 1023. He was apparently attached to Joab's person, but unknown and unaccustomed to the king, as may be inferred from his not being recognised by the watchman, and also from the abrupt manner in which he breaks his evil tidings to David—unlike Ahimaaz, who was well aware of the effect they were sure to produce. See DAVID. That *Cushi* was a foreigner—as we should infer from his name—is also slightly corroborated by his ignorance of the ground in the Jordan valley—"the way of the 'Ciccar'" (q. v.)—by knowing which Ahimaaz was enabled to outrun him. Ewald, however, conjectures that a mode of running is here referred to peculiar to Ahimaaz, and by which he was recognised a long distance off by the watchman.—Smith, s. v.

2. The father of Shelemiah, and great grandfather of Jehudi, which last was sent by the Jewish magnates to invite Baruch to read his roll to them (Jer. xxxvi, 14). B.C. long ante 605.

3. The son of Gedaliah, and father of the prophet Zephaniah (Zeph. i, 1). B.C. ante 635.

Cushion. See BED; PILLOW.

Cushman, ELISHA, a Baptist minister, was born Kingston, Mass., May 2, 1788. He was ordained pastor of the First Baptist Church of Hartford, June, 1813. In 1824 he was made M.A. (honorary) by Yale College. In 1825 he resigned his charge in Hartford, and became pastor of the New Market Street Baptist Church of Philadelphia. In September, 1829, he returned to Connecticut, and, after preaching some time at Stratfield, was, in April, 1831, called to the pastoral charge of the Baptist church in New Haven. In 1835 he removed to Plymouth, Mass., but returned to Hartford in 1838, and resumed the editorship of *The Christian Secretary*, a religious paper of which he had been the original editor in 1822. He died October 26, 1838. Mr. Cushman's preaching was simple, instructive, and often eloquent. He published a number of occasional sermons and addresses.—*Sprague Annals*, i, 562.

Cuspius. See FADUS.

Custom (Chald. חָלָה, *halah*, a way-tax, i. e. toll, Ezra iv, 13, 20; vii, 24; Gr. τῆλος, a tax, 1 Macc. xi, 15; Matt. xvii, 25; Rom. xiii, 7; φόρος, tribute, 2 Macc. iv, 28; τιμή, price, 1 Macc. x, 29), RECEIPT OF ΤΕΛΩΝΙΟΥ, collector's office, i. e. toll-house, Matt. ix, 9; Mark ii, 14; Luke v, 27). See TOLL. Under the Persian and Syrian supremacy, imposts of various kinds were collected by local agents. Under the Romans, the management of the provincial revenues was generally committed to the Roman knights, who were thence denominated *chief publicans*, or chief collectors of the taxes; the tax-gatherers or exactors whom they employed were termed *publicans*. It was different in Judæa, for there the management of the revenues was committed to the Jews themselves, and those who held this office eventually obtained an equal rank with the knights of Rome (Luke xix, 2; Josephus, *War*, ii, 14, 9). The subordinate agents, or *publicans*, in collecting the revenues, took their position at the gates of cities and in the public ways, and, at the place appointed for that purpose, called the "receipt of custom," examined the goods that passed, and received the moneys that were to be paid (Matt. ix, 2; Mark ii, 14; Luke v, 27, 29). These tax-gatherers, if we may believe Cicero (*Pro Flacc.* 28), were more inclined to exact too much than to forget the promise which they had made to their masters; and were, accordingly, in consequence of their extortions, everywhere, more particularly in Judæa, objects of hatred, and were placed in the same class with notorious sinners (Mark ii, 15, 16; Luke iii, 12, 13). The Pharisees held no communication with them; and one ground of their reproaches against the Saviour was, that he did not refuse to sit at meat with persons of such a character (Matt. v, 46, 47; ix, 10, 11; xi, 19; xviii, 17; xxi, 81, 82). The *half-shekel tax* was a tax or tribute to be paid annually by every adult Jew at the Temple. It was introduced after the captivity in consequence of a wrong interpretation of certain expressions in the Pentateuch, and differed from the revenue which accrued to the kings, tetrarchs, and ethnarchs, and from the general tax that was assessed for the Roman Cæsars. It was required that this tax should be paid in Jewish coin (Matt. xxii, 17-19; Mark xii, 14, 15). The prominent object of the temple money-changers (q. v.) was their own personal emolument; but the acquisition of property in this way was contrary to the spirit of the law in Deut. xxiii, 20, 21. It was for this reason that Jesus drove them from the temple (Matt. xxi, 22; Mark xi, 15; John ii, 15). Messengers were sent into other cities for the purpose of collecting this tax (Matt. xvii, 25). The Jews who collected this tax from their countrymen dwelling in foreign nations transmitted the sums collected every year to Jerusalem. This accounts for the immense

amount of the treasures which flowed into the Temple (Josephus, *Ant.* xiv, 7, 2). See TAX.

Cut the flesh; CUT OFF FROM THE PEOPLE. See CUTTING, etc.; EXCOMMUNICATION.

Cuth (Hebrew, *Kuth*, כּוּת, signif. unknown; Sept. Κούθ, 2 Kings xvii, 30) or *Cu'thah* (Heb. *Kuthah*, כּוּתָּה, fem. of same; Sept. Κουθά, ver. 24), one of the districts in Asia whence Shalmaneser transported certain colonists into the land of Israel, which he had desolated. See SAMARIA. From the intermixture of these colonists with the remaining natives sprung the Samaritans (q. v.), who are called Cuthites (כּוּתִיָּה) in the Chaldee and the Talmud (see Buxtorf, *Lex. Talm.* col. 1027), and for the same reason a number of non-Shemitic words which occur in the Samaritan dialect are called Cuthian (compare *Κουθῆται*, Josephus, *Ant.* ix, 14, 8; comp. xiii, 9, 1). Josephus places Cuthah in central Persia (comp. Zonar. i, p. 77), and finds there a river of the same name (*Κούθος*, *Ant.* ix, 14, 8; x, 9, 7). Rosenmüller and others incline to seek it in the Arabian Irak, where Abulfeda and other Arabic and Persian writers place a town of the name of *Kutha*, in the tract near the Nahr-Malka, or royal canal (the fourth in Xenophon, *Anab.* i, 7), which connected the Euphrates and Tigris to the south of the present Bagdad. The site has been identified with the ruins of *Towbah*, immediately adjacent to Babylon (Ainsworth's *Assyria*, p. 165; Knobel, *Völkertafel*, p. 252); the canal may be the river to which Josephus refers. Others prefer the conjecture of Stephen Morin (in Ugolini *Thes.* vii) and Le Clerc, which identifies the Cuthites with the *Cossæ* in Susiana (Arrian, *Indic.* xi; Plin. *Hist. Nat.* vi, 31; Diod. Sic. xvii, 111; Mannert, ii, 498), a warlike tribe who occupied the mountain ranges dividing those two countries, and whose lawless habits made them a terror even to the Persian emperors (Strab. xi, 524; xvi, 744). They were never wholly subdued until Alexander's expedition, and it therefore appears doubtful whether Shalmaneser could have gained sufficient authority over them to effect the removal of any considerable number; their habits would have made such a step highly expedient, if practicable. Fürst (*Heb. Handwört.* s. v.) identifies this district with the modern *Khusistan* of Susiana, the province *Jutija* of the cuneiform inscriptions of Behistun (Benfey, *Die Pers. Keilschr.* p. 13, 82). All these conjectures refer essentially to the same quarter, and any of them is preferable to the one suggested by Michaelis (*Spicil.* i, 104), that the Cuthites were Phœnicians from the neighborhood of Sidon; founding it upon the connection between the Samaritans and the Sidonians, as stated in their letter to Alexander the Great (Joseph. *Ant.* 8, 6; xii, 5, 5), and between the Sidonians and the Cuthæans, as expressed in the version of the Chaldee Paraphrast Pseudo-Jonathan in Gen. x, 19, who substitutes כּוּתִיָּה for צָרְרִי, and in the Targum, 1 Chron. i, 13, where a similar change is made; this is without doubt to be referred to the traditional belief that the original seat of the Phœnicians was on the shores of the Persian Gulf (Herod. i, 1). Rawlinson is confident that the ancient Cuth is identical with the modern ruined site *Ibrahim*, about twelve miles from Babylon (*Herod.* i, 243, 515; *Hist. Ev.* p. 340 sq.). See NERGAL. After all, it is possible that there is some historical and etymological connection (ω changed to ρ) between *Cuth* and the *Cush* of Gen. ii, 13, which must have lain somewhere in the same quarter. See CUSH.

Cuthbert, St., an eminent monk, born in the north of England in the beginning of the 6th century. His life, written by Bede, is full of marvellous stories; but it is clear that he was an earnest and faithful minister. He was educated by the Scottish monks at Icolmkill. After being for some time a monk in the monastery of

Mailros, he became prior of the monastery of Lindisfarne. In 676 he withdrew to the island of Farne, where he lived a life of most rigorous asceticism as a hermit, and enjoyed the reputation of working many miracles. In 685 he yielded to the entreaties of king Egbert, and accepted the episcopal see of Hexham. When he felt the approach of death he returned to his hermitage on Farne, and there died, March 20, 686. He is commemorated in the Roman Church March 20. "The fame of St. Cuthbert had been great during his life; it became far greater after his death. Churches were dedicated to him throughout all the country between the Trent and Mersey on the south, and the Forth and Clyde on the north. When his tomb was opened at the end of eleven years, it was believed that his body was found incorrupt, and so for more than 800 years it was believed still to continue. It remained at Lindisfarne till 875, when the monks, bearing it on their shoulders, fled inland from the fury of the Danes. After many wanderings through the south of Scotland and the north of England, it found a resting-place at Chester-le-Street in 882. It was transferred to Ripon in 995, and in the same year it was removed to Durham. Here, enclosed in a costly shrine, and believed to work daily miracles, it remained till the Reformation, when it was buried under the pavement of the cathedral. The grave was opened in 1827, when a coffin, ascertained to have been made in 1541—when the body was committed to the earth—was found to enclose another, which there was reason to suppose had been made in 1104; and this again enclosed a third, which answered the description of one made in 698, when the saint was raised from his first grave. This innermost case contained, not, indeed, the incorruptible body of St. Cuthbert, but his skeleton, still entire, wrapped in five robes of embroidered silk. Fragments of these, and of the episcopal vestments, together with a comb and other relics, found beside the bones, are to be seen in the cathedral library. The asceticism which distinguished St. Cuthbert in life long lingered round his tomb. Until the Reformation, no woman was suffered to approach his shrine; the cross of blue marble still remains in the cathedral floor which marked the limits beyond which female footsteps were forbidden to pass, under pain of instant and signal punishment from the offended saint. His wrath, it was believed, was equally prompt to avenge every injury to the honor or possessions of his church. It was told that William the Conqueror, anxious to see the incorrupt body of the saint, ordered the shrine to be broken up; but scarcely had a stroke been struck, when such sickness and terror fell upon the king that he rushed from the cathedral, and, mounting his horse, never drew bridle till he had crossed the Tees! A cloth, said to have been used by St. Cuthbert in celebrating mass, was fashioned into a standard, which was believed to insure victory to the army in whose ranks it was carried. Flodden was only one of many fields in which the defeat of the Scots was ascribed to the banner of St. Cuthbert. It hung beside his shrine until the Reformation, when it is said to have been burnt by Calvin's sister, the wife of the first Protestant dean of the cathedral. The life of St. Cuthbert was twice written by the Venerable Bede—briefly in vigorous hexameters in his *Liber de Miraculis Sancti Cuthberti Episcopi*; at greater length in prose, in his *Liber de Vita et Miraculis Sancti Cuthberti Lindisfarrensis Episcopi*. In this latter work he made use of an earlier life by a monk of Lindisfarne, which is still preserved. Besides these lives—all of which have been printed more than once—and what is told of St. Cuthbert in Bede's *Historia Ecclesiastica Gentis Anglorum*, the chief ancient authorities are the *Historia Translationis S. Cuthberti*, published by the Bollandists in the *Acta Sanctorum, mens. Martii*, vol. iii; the *Libellus de Exordio Dunelmensis Ecclesie*, by Symeon of Durham; the *Libellus de Nativitate S. Cuth-*

berti de Historiis Hybernensium excerptus, and the *Libellus de Admirandis B. Cuthberti Virtutibus*, by Eadmund of Durham, both published by the Surtees Society. There are two modern memoirs of St. Cuthbert—the late Rev. James Raine's *St. Cuthbert* (Durham, 1828), and the Very Rev. Monsignor C. Eyre's *History of St. Cuthbert* (Lond. 1849).—Chambers, *Encyclopædia*, s. v.; Butler, *Lives of Saints*, March 20; Herzog, *Real-Encyklop.* xix, 874.

Cuthites. See CURT.

Cutler, Benjamin Clarke, D.D., a minister of the Protestant Episcopal Church, was born in Roxbury, Mass., Feb. 6, 1798, and died in Brooklyn, N.Y., Feb. 10, 1868. On his mother's side he was descended from the Huguenots. His religious character developed early; it was marked by no epoch of sudden transition, but at the age of eighteen, two years after his confirmation, he became a decided Christian. He immediately began to study for the ministry, and graduated with high honor at Brown University in 1820. He discharged the functions of the ministry seven years in Quincy, Mass.; one year in Leesburg, Va.; two years in New York as a city missionary, and three years as rector of St. Ann's Church, Brooklyn. As a preacher he was pre-eminently evangelical, and as a pastor remarkably successful. He was one of the originators and most active promoters of the missionary work of the Protestant Episcopal Church. He was a Low-Churchman, and was deeply grieved by the rise of Puseyism, and its introduction into this country. He wrote of it as "the reigning heresy of incipient Romanism." In 1848 he visited England for the sake of his health. On his return the vessel struck a shoal in the harbor of New York, and for twelve hours it labored heavily in a storm. Always after he observed the anniversary of that day as an occasion of special thanksgiving. Dr. Cutler was a chronic invalid. Before he went to college he was thought to be in a decline, and his life was one long battle with disease. His final illness was protracted and very distressing. He would often say, "the under-currents are all peace." He left no published works except a few occasional discourses and a volume of sermons, which are good specimens of direct, fervent Gospel preaching.

Cutler, Manasseh, LL.D., a Congregational minister, was born in Killingly, Conn., May 28, 1757, graduated at Yale 1785, studied law, and was admitted to the bar, but in a short time devoted himself to the study of theology. He was installed pastor in Hamilton, Mass., Sept. 11, 1771. After the Revolution the Ohio Company chose him agent for the purchase of land in the West, and Washington offered him the honorable position of judge of the U. S. Court in the North-west Territory, but he declined. He was elected to Congress in 1800. Dr. Cutler devoted himself largely to botany, and to the study and practice of medicine, but retained his pastoral relation until his death, July 28, 1828. He was made LL.D. by Yale in 1789. He published a number of articles on scientific subjects and a few occasional sermons.—Sprague, *Annals*, ii, 16.

Cutler, Timothy, D.D., minister of the English Church in America, was born at Charlestown, Mass., in the year 1683, and graduated at Harvard in 1701. He was educated and ordained for the Presbyterian ministry, and in 1710 was installed pastor of the Congregational church in Stratford, Conn. He became president of Yale College in 1719, at the request of the trustees; but on the day after Commencement in 1772, a paper was presented to the clergy and others assembled in the college library, signed by the rector and one of the tutors, together with several of the neighboring ministers, in which they say: "Some of us doubt of the validity, and the rest are fully persuaded of the invalidity, of Presbyterian ordination in opposition to Episcopal." In October following a dis-

tion took place in the college library, the principal actors being the rector and Mr. Samuel Johnson towards Dr. Johnson, of Hartford) on the one side, and governor Saltonstall on the other. The result is that the rector declared himself confirmed in his iscoproclivities, and in October following the stees voted "to excuse the Rev. Mr. Cutler from all other service as rector of Yale College." He went England in July, 1722, to procure Episcopal ordination, which he received the following year, with the degree of D.D. from both Oxford and Cambridge. In 23, on his return, he was appointed missionary to the Society for the Propagation of the Gospel, and became rector of Christ Church, Boston. In that station he died, Aug. 17, 1765. He published several occasional sermons.—Sprague, *Annals*, v, 50.

Cutting (IN THE FLESH), expressed technically by *קָטַעַת*, *as ret* (Lev. xix, 28), or *קָטַעַת*, *as ret* (Lev. xi, 5, where the cognate verb *קָטַעַת*, *saral'*, is used in the same connection), a *gash* or incision (Sept. *ἐκτομή*, Vulg. *incisura*) in the flesh (*קָטַעַת*); also by *קָטַעַת*, *gedud'* (Jer. xvii, 37), a *cut* in the skin (e. g. the hand, as there; the verb *קָטַעַת*, *gadad'*, occurs in the same sense, with reference to the ceremonies of mourning, Jer. xvi, 6; xlii, 5; xlvii, 5, or as a part of idol worship, Deut. xiv, 1; 1 Kings xviii, 28); and by *קָטַעַת*, *kaaka'*, a "mark" punctured on the person (Lev. xix, 28); compare the *dæmoniac* in Mark v, 5, *αγαρόπυον ἑαυτὸν*, "cutting himself" with stones. Among the prohibitory laws which God gave the Israelites there was one that expressly forbade the practice embraced in those words, viz. "Ye shall not make any cuttings in your flesh for the dead" (Lev. xix, 28). (It is evident from this law that such a species of self-inflicted torture obtained among the nations of Canaan; and it was doubtless to guard his people against the adoption of so barbarous a habit, in its idolatrous form, as well as to restrain desperate grief (comp. 1 Thess. iv, 13; see Macdonald, *Introd. to the Pentateuch*, Edinb. 1861, p. 113), that God led Moses to reiterate the prohibition: "They shall not make baldness upon their heads, neither shall they shave off the corner of their beards, nor make any cuttings in their flesh" (Lev. xxi, 5; Deut. xiv, 1). (See J. G. Michaelis, *De incisura propter mortuos*, F. ad O. 1738.) See CORNER.

1. The ancients were very violent in their expressions of sorrow. Virgil represents the sister of Dido as tearing her face with her nails, and beating her breasts with her fists (*Æn.* iv, 672). Some of the learned think that that law of Solon's which was transferred by the Romans into the Twelve Tables (Cicero, *De Leg.* ii, 23), that *women in mourning should not scratch their cheeks* (*Corp. Jur. Civ.* v, 66, 67, ed. Godofredus, 1583), derived its origin from this law of Moses (Lev. xix, 28). But, however this opinion may be questioned, it would appear that the simple tearing of the flesh out of grief and anguish of spirit is taken in other parts of Scripture as a *mark of affection*: thus (Jer. xlviii, 37), "Every head shall be bald, every beard clipped, and upon all cuttings." Again (ch. xvi, 6): "Both the great and the small shall die in the land: they shall not be buried, neither shall men lament for them, nor cut themselves." So (ch. xlii, 5): "There came from Samaria fourscore men having their heads shaven and their clothes rent, and having cut themselves, with offerings to the house of the Lord." A notion apparently existed that self-inflicted baldness or mutilation had a propitiatory efficacy with respect to the manes of the dead, perhaps as representing, in a modified degree, the solemnity of human or animal sacrifices. Herodotus (iv, 71) describes the Scythian usage in the case of a deceased king, for whose obsequies not fewer than six human victims, besides offerings of animals and other effects, were considered necessary. An extreme case of funeral

bloodshed is represented on the occasion of the burial of Patroclus, when four horses, two dogs, and twelve Trojan captives are offered up (*Il.* xxiii, 171, 176). Originally used with human or animal sacrifices at funerals, after these had gone out of use, the minor propitiatory acts of self-laceration and depilation continued alone (*Il.* xxiii, 141; *Od.* iv, 197; *Virg. Æn.* iii, 67, with Servius ad loc. xii, 605; Eurip. *Alc.* p. 425; Seneca, *Hippol.* v, 1176, 1193; Ovid, *Eleg.* I, iii, 8; Tibullus, *Eleg.* I, i, 1). Plutarch says that some barbarians mutilate themselves (*De Consol. ad Apollon.* p. 118, vol. vi, Reiske). He also says that Solon, by the advice of Epimenides, curtailed the Athenian practice in this respect (*Solon.* 12-21, i, 184, 194). Such being the ancient heathen practice, it is not surprising that the law should forbid similar practices in every case in which they might be used or misconstrued in a propitiatory sense. "Ye shall not make cuttings for (propter) the dead," *קָטַעַת* (Lev. xix, 28; see Gesenius, *Thes. Heb.* p. 781; Spencer, *De Leg. Hebr.* II, xix, 404, 405). See GRATER.

2. But the practice of self-mutilation as an act of worship belonged also to heathen religious ceremonies not funeral. The priests of Baal, a Syrian and also an Assyrian deity, cut themselves with knives to propitiate the god "after their manner" (1 Kings xviii, 28). Herodotus says that the Carians, who resided in Europe, cut their foreheads with knives at festivals of Isis; in this respect exceeding the Egyptians, who beat themselves on those occasions (Herod. ii, 61). This shows that the practice was not then at least an Egyptian one. Lucian, speaking of the Syrian priestly attendants of this mock deity, says that, using violent gestures, they cut their arms and tongues with swords (Lucian, *Assius*, c. 37, vol. ii, 102, Amst.; *De Dea Syr.* ii, 658, 681; comp. Ezek. viii, 14). Similar practices in the worship of Bellona are mentioned by Lucan (*Phars.* i, 560), and alluded to by Ælius Lampridius (*Comm.* p. 209), by Tertullian (*Apol.* 9), and Lactantius (*Div. Institut.* i, c. 21, 29, Paris). Herodotus, speaking of means used for allaying a storm, uses the words *ἑτομα ποσειδῶντος*, which may mean cutting the flesh, but more probably offering human sacrifices (Herod. vii, 191; ii, 119, with Schweighäuser's note; see also Virg. *Æn.* ii, 116; Lucr. i, 85). Agreeably to the inference which all this furnishes, we find Tacitus declare (*Hist.* i, 4) that "the gods care, not for our safety, but punishment." In fact, it was a current opinion among the ancient heathen that the gods were *jealous* of human happiness; and in no part of the heathen world did this opinion more prevail, according to Sanchoiathon's account, than among the inhabitants of those very countries which surrounded that land where God designed to place his people Israel. The prohibition, therefore, is directed against practices prevailing, not among the Egyptians whom the Israelites were leaving, but among the Syrians, to whom they were about to become neighbors (Selden, *De Diis Syris*, lib. ii, c. 1). The spirit of Islam is less favorable than that of heathenism to displays of this kind; yet examples of them are not of rare occurrence even in the Moslem countries of Western Asia, including Palestine itself. The annexed figure is copied from one which is represented in many of the books of travel in Egypt and Palestine that were printed in the seventeenth century. It is described by the missionary Eugene Roger (*La Terre Sainte*, etc., 1646, p. 252) as representing "one of those calenders or devotees whom the Arabs name Balhoana," and whom the simple people honor as holy martyrs. He appears in public with a



Modern Oriental Self-torture.

clmter stuck through the fleshy part of his side, with three heavy iron spikes thrust through the muscles of his arm, and with a feather inserted into a cut in his forehead. He moves about with great composure, and endures all these sufferings, hoping for recompense in the Paradise of Mohammed. Add to this, the common accounts of the gashes which the Persian devotees inflict upon themselves, in the frenzy of their love and grief, during the annual mourning for Hassan and Hossein (see Mrs. Postans, in the *Jour. Sac. Lit.*, July, 1848, p. 107). The Mexicans and Peruvians offered human sacrifices both at funerals and festivals. The Gossyens of India, a class of Brahminical friars, endeavor in some cases to extort alms by gashing their limbs with knives. Among the native negro African tribes also the practice appears to prevail of offering human sacrifices at the death of chiefs. (See Chardin, *Voyages*, vi, 492; ix, 58, 490; Olearius, *Travels*, p. 287; Lane, *Mod. Eg.* ii, 59; Prescott, *Mexico*, i, 53, 63; Peru, i, 86; Elphinstone, *Hist. of India*, i, 116; Strabo, xv, 711 et sq.; Niebuhr, *Voyages*, ii, 54; Livingstone, *Travels*, p. 318, 588; *Col. Ch. Chron.* No. cxxxi, 179; Muratori, *Anecd.* iv, 99, 100). See SACRIFICE.

8. But there is another usage contemplated more remotely by the prohibition, viz., that of printing marks (*otiyuara*), tattooing, to indicate allegiance to a deity, in the same manner as soldiers and slaves bore tattooed marks to indicate allegiance or adscription. (See Biedermann, *De Charact. corpori impressis*, Frieb. 1755.) This is evidently alluded to in the Revelation of John (xiii, 16; xix, 20; xvii, 5), though in a contrary direction, by Ezekiel (ix, 4), by Paul (Gal. vi, 17), in the Revelation (vii, 3), and perhaps by Isaiah (xliv, 5) and Zechariah (xiii, 6). Lucian, speaking of the priests of the Syrian deity, says that they, and, in fact, the Assyrians generally, bear such marks on some part of their body (*De Dea Syr.* ii, 684). A tradition, mentioned by Jerome, was current among the Jews, that king Jehoiakim bore on his body marks of this kind which were discovered after his death (Spencer, *De Leg. Hebr.* II, xx, 410). Philo, quoted by Spencer, describes the marks of tattooing impressed on those who submitted to the process in their besotted love for idol-worship, as being made by branding (*σθηρω περιρωμίνω*, Philo, *de Monarch.* i, 819; Spencer, p. 416). The Arabs, both men and women, are in the habit of tattooing their faces, and other parts of the body, and the members of Brahminical sects in India are distinguished by marks on the forehead, often erroneously supposed by Europeans to be marks of caste (Niebuhr, *Descr. de l'Ar.* p. 68; *Voyages*, i, 242; Wallstedt, *Ara-bia*, ii, 206, 445; Olearius, *Travels*, p. 299; Elphinstone, *India*, i, 195).—Kitto, s. v.; Smith, s. v. See MARK (ON THE PERSON).

CUTTING OFF (FROM THE PEOPLE). See EX-COMMUNICATION.

Cutty-stool, the stool or seat of repentance in the Scotch kirks, placed near the roof and painted black, on which offenders against chastity sit during service, professing repentance and receiving the minister's rebukes. It is somewhat remarkable that a breach of the seventh commandment should be the only sin subjecting the offender in the Scotch Church to this sort of discipline.—Buck, *Theol. Dict.* s. v.

Cuyler, CORNELIUS C., D. D., born at Albany, N. Y., February, 1783; graduated at Union College 1806; studied theology under Rev. Drs. Livingston and Bassett; licensed 1808 in the Reformed Dutch Church; settled in Poughkeepsie 1808-1833, and from that year until his decease in 1850 was pastor of the Second Presbyterian Church, Philadelphia. Dr. Cuyler is represented as "an excellent model of diligence, fidelity, and wisdom," a man of strong and well-furnished mind, an earnest and effective preacher, an adept in the management of ecclesiastical business. His ministry was characterized by several powerful revivals

of religion, in which his wisdom, zeal, and success were very conspicuous. His printed works consist of a number of occasional sermons, tracts, pamphlets, articles for periodicals and essays upon special topics, e. g. the subjects of Baptism, the Atonement, the Privilege of the Ministry, Capital Punishment, etc.—*Spang. Annals*, iv, 432.

Cyamón (*Κυαμών*; Vulgate, *Chelmon*), a plain named only in Judith vii, 3, as lying in the plain (*ἐλάωv*, A. V. "valley") over against (*ἀπέναντι*) Esdrelom. If by "Esdrelom" we may understand Jemal, this description answers to the situation of the modern village Tell *Kaimón*, on the eastern slopes of Carmel on a conspicuous position overlooking the Kishon and the great plain (Robinson, *Later Res.* p. 114; Van de Velde, *Narrative*, i, 390). The place was known to Eusebius (*Καμμωνά*) and Jerome (*Chelmona*), and is mentioned by them in the *Onomasticon* (s. v. *Καμμων*), where they identify it with CAMON, the biblical-place of Jair the Gileadite (Judg. x, 5).—Smith, s. v. Schultz assumes Cyamon to be identical with the modern *Kumieh*, south-east of Little Hermon (*Zeitsch. d. morg. Ges.* iii, 48); but Dr. Robinson (*ut sup.* p. 38) thinks this inconsistent with the true position (according to his location) of Bethulia (q. v.), and suggests that "Cyamon" may be only the Greek rendering (*κύαμος*) of the Heb. name *כַּיִם*, *pol.* a beam) corresponding to the present *Fuleh*, on the east side of the plain of Esdraelon, a trace of which appears in the notices of the Crusaders (Wilken, *Gesch. der Kreuzk.* III, ii, 281, 267). But see JORNEAM.

Cyaxäres (*Κυαξάρης*, Græcised for the Old Per. *Uvakhshatara*, "beautiful-eyed," Rawlinson, *Herod.* ii, 455), the name of two Median kings. See MEDIA.

1. **CYAXARES I** was, according to Herodotus, the third king of Media, being the son of Phraortes, and grandson of Dejeos. His father having been killed while besieging Ninus (Nineveh), he, immediately on his accession, B. C. 634, collected all the military resources of the empire to revenge his father's death; but he was called away from the siege of Ninus by an attack of the Scythians, by whom he was defeated, and reduced to a tributary condition of great rigor for many years, B. C. 634-607 (Herod. i, 108). Herodotus elsewhere (i, 78 sq.) gives a different account of this war, as having originated in the treachery of Alivates of Syria, who had sheltered some fugitive Scythians that had served up to Cyaxares as a banquet one of his own sons whom they had killed. The war, carried on for five years against the Lydians by the Median monarch, who evidently still retained his throne, was terminated by the mutual awe inspired by an eclipse, which has been variously calculated, but probably was that of Sept. 80, B. C. 610 (Baily, *Philos. Transact.* 1811; Oltmann, *Schrift. der Berl. Acad.* 1812-13; Hale, *Anal. of Chronology*, i, 74-78; Ideler, *Handbuch der Chronologie*, i, 209 sq.; Fischer, *Griech. Zeitaf.* s. 2, 610). Cyaxares after this expelled the Scythians, B. C. 607, and in the following year, with the aid of the king of Babylon, he took and destroyed the Assyrian capital, at that time governed by Sardanapalus. This event is referred to in the Apocrypha (Tob. xiv, 15), where the Median king is styled "Ahasuerus" (q. v.), and his Babylonian ally is called Nabuchodonosor, doubtless referring to Nabopolassar, the father of Nebuchadnezzar. See BABYLONIA. The result of this campaign, according to Herodotus, was, that the Medes made the Assyrians their subjects, except the district of Babylon, probably meaning that the king of Babylon now obtained complete deliverance from the yoke of Assyria. The league between Cyaxares and the king of Babylon is said by Polyhistor and Abydenus (ap. Euseb. *Chron. Arm.* and *Syncecl.* p. 210 b) to have been cemented by the betrothal of Anysis or Anytia, the daughter of Cyaxares, to Nabuchadrossar or Nabuchadonosor (i. e. Nebuchadnezzar), the son of the

ylonian king. They have, however, by mistake, the name of his son Asdapaqes (Astyages) for Cyres (Clinton, i, 271, 279). Cyaxares was a brave energetic, but violent and cruel prince, and died 594, after a reign of 44 years, leaving the throne to Astyages (Herod. i, 73, 74, 103-106; iv, 11, 12; vii, —Smith, *Dict. of Class. Biog.* s. v.

1. CYAXARES II, the son of Astyages and grand-son of the preceding, succeeded his father at the age of forty-nine years; but, being of a gentle disposition, left the government principally in the hands of his nephew and son-in-law Cyrus. This account is given by Xenophon (in his *Cyropædia*), with which, however, the statements of Herodotus and Ctesias materially disagree. See CYRUS. This Cyaxares is believed to be the "Darius the Mede" (q. v.) referred to in the book of Daniel (ix, 1).

Cycle, a certain number of years in civil and ecclesiastical chronology. The *Lunar Cycle* (*cyculus lunaris* or *decemnovalis*) embraces nineteen years, after the expiration of which the days of the new and full moon generally fall again upon the same day of the month. The Greek astronomer Meton is the inventor of this cycle. Anatolius, bishop of Laodicea, in Syria, toward the close of the third century, first used it for calculating Easter (q. v.). When the Council of Nice terminated the Easter controversy, and established uniformity in the celebration of Easter, the bishops of Alexandria and Antioch were commissioned to calculate annually the time of Easter, and to communicate it to the other metropolitans. At first the bishops of Alexandria made astronomical calculations, but subsequently they finally adopted the lunar cycle, and by means of it calculated Easter for a number of cycles in advance. The patriarch Theophilus of Alexandria prepared an Easter cycle for 480 years, or 22 lunar cycles, beginning with the year 380. This cycle was, however, never received in the Western churches, and the patriarch Cyril consequently reduced it to 95 years, or five lunar cycles. This new Easter cycle extended from 437 to 531. When it approached its termination, Dionysius Exiguus (q. v.), in 525, proposed a new Easter cycle, which embraced 16 lunar cycles, or 304 (Julian) years. The defects of this cycle resulted from the inaccuracy of the Julian year, and were not remedied until the introduction of the Gregorian calendar. The cycle nearly connected with the lunar cycle is the *Golden Number* (q. v.), which indicates what place a given year occupies in the lunar cycle. The *Cycle of the Sun* (or of the dominical letter) embraces 28 years, after the expiration of which the Sundays, and consequently also the days of the week, fall again upon the same days of the month. In Christian chronology it became early customary to use the first seven letters of the alphabet for designating the seven days of the week. *A* was always used for the 1st of January, and the letter upon which fell the first Sunday of the year was called the *Dominical Letter*, which, in ordinary years, designated every Sunday of the year. But in every fourth year the 25th of February was intercalated, and as it had the same letter as the 24th of February, the intercalary year had two dominical letters, the first applying from Jan. 1 to Feb. 24, and the second from Feb. 25 to the close of the year. As an ordinary year consists of 52 weeks and 1 day, the dominical letter of the new year is generally the one preceding the dominical letter of the year past; and if all years were ordinary years of 365 days, the same dominical letter would revert every seventh year. As there is, however, a change of one day every fourth year by the intercalation of one day, and the consequent advance of the dominical letter, it takes four times seven, or 28 years, before the cycle is completed, and the same series of dominical letters recommences. Another slight disturbance is, however, produced by the omission of the intercalary day three times in every 400 years (thus, in the years 1700, 1800, 1900).

To find the dominical letter of a particular year, it is first necessary to find the place of the year in the cycle of the sun. As, according to the chronology of Dionysius, Christ is said to have been born in the ninth year of the cycle of the sun, the place of a particular year in the cycle of the sun is found by adding 9 to the given year, and dividing the whole by 28, the remainder indicating the place of the year in the cycle. For instance, to find the dominical letter for the year 1868, we add 9 and divide by 28; thus, $\frac{1868+9}{28} = \frac{1877}{28}$

which leaves a remainder of 1. The year 1868, therefore, is the first of the cycle of the sun for the present century (the omission of the intercalary day in the year 1800, as stated above, interrupting the regular order of the cycle). The cycle of the dominical letter is as follows:

Year.	Dom. L.	Year.	Dom. L.	Year.	Dom. L.	Year.	Dom. L.
1st	ed	8th	c	15th	a	22d	f
2d	c	9th	ba	16th	g	23d	e
3d	b	10th	g	17th	fe	24th	d
4th	a	11th	f	18th	d	25th	cb
5th	gf	12th	e	19th	e	26th	a
6th	d	13th	dc	20th	b	27th	g
7th	e	14th	b	21st	ag	28th	f

The intercalary year 1868, as the first of a new cycle, has therefore the two dominical letters e d, e from Jan. 1 to Feb. 24, and d from Feb. 25 to Dec. 31. After thus ascertaining the dominical letter of the year, it is easy to find what days of every month are Sundays. For that purpose the initial letters of the several words in the following two hexameters are used:

**Astra Dabit Dominus Gratiasque Beabit Egenos
Gratia Christicolæ Feret Aurea Dona Fidell.**

The initial letters of the words of these two verses are the letters designating the first days of every month. *A* being the 1st of January, and *E* being the dominical letter of the year 1868 from Jan. 1 to Feb. 24, the Sundays of 1868 are the 5th, 12th, 19th, and 26th of January. The initial *D* of the second word shows that the first dominical letter (*E*) of February falls on the 2d of February. For March and the following months, the dominical letter of the year 1868 is *D*; consequently, the first Sundays of the following months are, March 1, April 5, May 3, June 7, July 5, August 2, September 6, October 4, November 1, and December 6.

Finally, in order to ascertain upon which day of the month and the week full and new moons occur, the *Ephacts* are used.—Wetzer und Welte, *Kirchen-Lex.* ii, 960. See EPACTS; CHRONOLOGY, CHRISTIAN.

Cymbal (כִּמְבָלָא, *tselalsal*, in the plur. 2 Sam. vi, 5; Psa. cl, 5; or כִּמְבָלָא, *metse'leth*, in the dual, 1 Chron. xiii, 8; xv, 16, 19, 28; xvi, 5, 42; xxv, 1, 6; 2 Chron. v, 12, 13; xxix, 25; Ezra iii, 10; Neh. xii, 27; both from כִּמְבָלָא, *tsalal*, to *tinkle*; *κύμβαλον*, in the plur. 1 Esdr. iv, 9; Judith xvi, 2; 1 Macc. iv, 54; 1 Cor. xiii, 1), a musical instrument consisting of two convex pieces of brass, which are struck together to make the rhythm or time, and produce a loud clanging sound. They are generally employed in connection with the drum in out-door orchestras. Josephus (*Ant.* vii, 12, 3) describes in like manner the cymbals (*κύμβαλα*) used in the Temple services as "large plates of brass." They were used from the most ancient times in the East as a part of a martial band in public religious occasions (1 Chron. xiii, 8), and also by females in connection with dancing (Lucian, *Sollat.* c. 68; comp. Chrysost. in *Gen. XXIV*, hom. 48; Clem. Al. *Protag.* ii, 4); also along with the drum (Pliny, v, i). Niebuhr (*Reis.* i, 181, pl. 27) learned that in Arabia two kinds of *castanets* were employed in a similar manner; one of small metal clappers held between the thumb and fingers, especially by females, as with the dancing-girls of Egypt (Lane, *Mod. Eg.* ii, 106); the other consisting of larger pieces of metal, like our cymbals. Pfeiffer (*Musik der Hebr.* p. 56) thinks this distinction



Dancing Figures, with Castanets.—From Herculaneum.

is intended between the two kinds of cymbals mentioned in Psa. cl, 5, צלצלי "loud cymbals," and צלצלי חריצור, "high-sounding cymbals." "The

Asaph, Heman, and Jeduthun, the renowned composers of the music of the sanctuary, employed the cymbals' possibly to beat time, and to give the sign to the choir when it was to take part in the sacred chant" (Smith). The ancient Egyptians likewise used cymbals and cylindrical maces (*crochala*, or clappers) two of which were struck together, and probably emitted a sharp metallic sound. The cymbals were of mixed metal, apparently brass, or a compound of brass and silver, and of a form exactly resembling those of modern times, though smaller, being only seven or five inches and a half in diameter. The handle was also of brass, bound with leather, string, or any similar substance, and being inserted in a small hole at the summit, was secured by bending back the two ends. The same kind of instrument is used by the modern inhabitants of the country, and from them have been borrowed the very small cymbals played with the finger and thumb, which supply the place of castanets in the *almeh* dance. These were the origin of the Spanish castanet, having been introduced into that country by the Moors, and afterwards altered in form, and made of chestnut (*castaña*) and other wood, instead of metal. The cymbals of modern Egypt (*Descr. de l'Egypte*, xiii, 496 sq.) are chiefly used by the attendants of sheiks' tombs, who travel through the country at certain periods of the year to exact charitable donations from the credulous or the devout among the Moslems by the promise of some blessing from the indulgent saint. Drums and some other noisy instru-

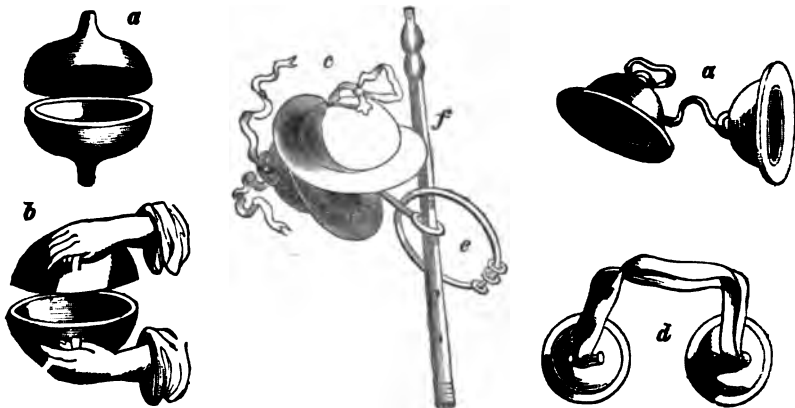

Ancient Cymbals.—From Herculaneum.

former probably consisted of four small plates of brass or of some other hard metal; two plates were attached to each hand of the performer, and were smitten together to produce a loud noise. The latter consisted of two larger plates, one held in each hand, and struck together as an accompaniment to other instruments.

ments, which are used at marriages and some other occasions, accompany the cymbals, but these last are more peculiarly appropriated to the service of the sheiks, and the external ceremonies of religion as among the ancient Egyptians; and a female whose coffin contained a pair of cymbals, was described in the hieroglyphics of the exterior as the minstrel of a deity. The cylindrical maces, or clappers, were also admitted among the instruments used on solemn occasions, and they frequently formed part of the military band, or regulated the dance. They varied slightly in form, and some were of wood or of shells; others of brass, or some sonorous metal having a straight handle, surmounted by a head or other ornamental device. Sometimes the handle was slightly curved, and double, with two heads at the upper extremity; but in all cases the performer held one in

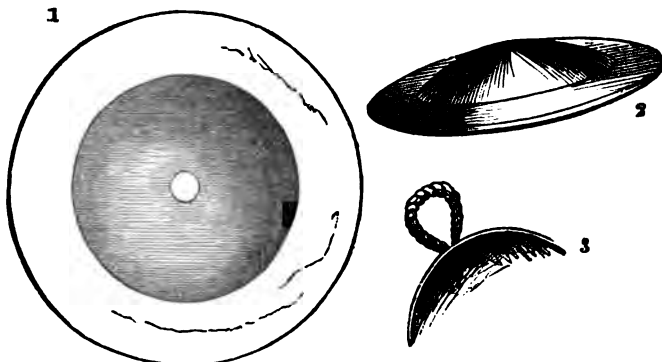

Ancient Egyptian Cymbals (5 1/4 inches in diameter).—From the British Museum.

in hand; and the sound depended on their size, and the material of which they were made. When of wood they corresponded to the *crotala* of the Greeks, supposed invention of the Sicilians, and reported to have been used for frightening away the fabulous birds *Stymphalus*; and the paintings of the Etruscans show that they were adopted by them, as by the Egyptians, in the dance (Wilkinson, *Anc. Egypt.* i, 99 sq.). Among the Greeks and Romans cymbals of a similar description were anciently used in the worship of Cybele, Bacchus, Juno, and other earlier deities. They were probably derived from the East. At Rome they were first mentioned in Livy's account (xxxix, 9) of the bacchic orgies introduced from Etruria (Smith, *Dict. of Class. Antiq.*, s. v. Cymbalum). See Mendelssohn's preface to *Book of Psalms*; Kimchi; Lewis, *Origines Hebrææ* (Lond. 1724, 176-7); Forkel, *Gesch. der Musik*; Ahn, *Archæology*, Am. ed., cap. v, § 96, 2; Munk, *Palæstine*, p. 456; Esendier, *Dict. of Music*, i, 112. Lampe has an excellent dissertation, *De Cymbalis veterum* (Traj. d Rh. 1703; also in Ugolini *Thes.* xxxii). Monographs on the subject have also been written in Latin by Ellis (*Fortuita Sacra*, Rotterd. 1727, p. 257-378), Magius (Amst. 1664), Zorn (*Opusc.* i, 111-163). See MUSICAL INSTRUMENTS.

Cypress (צִפְרִי, *tirzah'*, from its hardness; Sept. *ἄγριοβάλανος*, but most copies omit; Vulg. *ilex*) is mentioned only in Isa. xlv, 14: "He (i. e. the carver, ver. 18) heweth him down cedars, and taketh the cypress," for the purpose of making an idol. There is no doubt that the wood must have been of a texture fit to be worked, as well as to retain the shape given to it. Though translated "cypress," we have no proof that this tree was intended, but it is well suited for the purpose indicated. See FIR. The Greek translators, Aquila and Theodotion, have employed a word which denotes the wild or forest oak (*ἄγριοβάλανος*). The oldest Latin version renders the Heb. word by *ilex*, "the evergreen oak" (Rosenmüller, p. 317). As the wood of this species is well fitted for being worked into images, and was so employed by the ancients, it is possible that it may be that intended, though we have no satisfactory proof of its being so. Celsius (*Hierob.* ii, 269, 70) defends the rendering of the Vulg. in Isa. xlv, 14, but the etymology of the word from צִפְרִי, to be hard (as in Latin we get *robur*, an oak), equally well suits the cypress, and there is great probability that the tree mentioned by Isaiah with the cedar and the oak is identical with the "cypress" (*κυπάρισσος*) of the Apocrypha. In Ecclus. xxiv, 13, it is described as growing upon the mountains of Hermon; and it has been observed by Kitto (*Phys. Hist. of Palest.* p. cccxiv) that if this be understood of the great Hermon, it is illustrated by Po-

cocke, who tells us that it is the only tree which grows towards the summit of Lebanon. In Ecclus. i, 10, the high-priest is compared to a "cypress towering to the cloud," on account of his tall and noble figure. It is usually supposed that the words translated "fir," "gopher-wood," and "thyine-wood," in our version of the Bible indicate varieties of the juniper or cypress. (See each in its alphabetical order.)

Cypress, the *κυπάρισσος* of the Greeks and the *suroo* of the Arabs, called also by them *shujrut-alhyat*, or tree of life, is the *Cupressus sempervirens*, or the evergreen cypress of botanists. This tree is well known as being tapering in form, in consequence of its branches growing upright and close to the stem, and also that in its general appearance it resembles the Lombardy poplar, so that the one is often mistaken for the other when seen in Oriental drawings. In southern latitudes it usually grows to a height of fifty or sixty feet. Its branches are closely covered with



Cypress Branch and Cones.

very small imbricated leaves, which remain on the trees five or six years. Du Hamel states that he has observed on the bark of young cypresses small particles of a substance resembling gum tragacanth, and that he has seen bees taking great pains to detach these particles, probably to supply some of the matter required for forming their combs. This cypress is a native of the Grecian Archipelago, particularly of Candia (the ancient Crete) and Cyprus, and also of Asia Minor, Syria, and Persia. It may be seen on the coast of Palestine, as well as in the interior, as the Mohammedans plant it in their cemeteries. That it is found on the mountains of Syria is evident from the quotations by Celsius (*Hierobot.* i, 138), from Cyril of Alexandria (in *Esaiam*, p. 848), Jerome (*Comment. in Hos.* xiv, 6), and others. See CEDAR. The wood of the cypress is hard, fragrant, and of a remarkably fine close grain, very durable, and of a beautiful reddish hue, which Pliny says it never loses (*Hist. Nat.* xvi, 38). As to the opinion respecting the durability of the cypress-wood entertained by the ancients, it may be sufficient to adduce the authority of Pliny, who says that "the statue of Jupiter, in the Capitol, which was formed of cypress, had existed above 600 years without showing the slightest symptom of decay, and that the doors of the temple of Diana at Ephesus, which were also of cypress, and were 400 years old, had the appearance of being quite new." This wood was used for a variety of purposes, as for wine-presses, poles, rafters, and joists, and was an especial favorite for funereal grounds. Horace says (*Carm.* ii, 14, 23) that whatever was thought worthy of being handed down to remote posterity was preserved in cypress or cedar wood; and Virgil refers to it in similar terms (*Georg.* ii, 442; *Æn.* v, 64).—Kitto, s. v. (See *Penny Cyclopædia*, s. v. *Cupressus*.) See BOTANY.



The Cypress (*Cupressus Sempervirens*).

Cyp'rian (Κύπριος), a Cypriot or inhabitant (2 Macc. iv, 29) of the island of Cyprus (q. v.).

Cyprian Manuscript (Codex Cyprius, so called

105
 ΤΕΝΤΗΝ ΠΑΡΑΒΟΛΗΝ ΤΑΥΤΗΝ ΔΝΟΕ ΦΥΤΕΥ
 ΚΕΝΑΜΠΕΛΩΝ ΑΙΣΜΕΣΑ ΤΟΥΛΥ ΤΟΝΤΕΣΟΡΤΙΟΙΣ

Specimen of the Codex Cyprius (Luke xx, 9, with the large chapter-mark O or 70 in the margin: Γεν την παραβολην ταυτην ανοε φυτευσεν κεναμπελων αι σμεσα του λυ τοντεςορτιοις).

from its place of discovery), usually designated as K of the Gospels, one of the important uncial MSS. of the N. T., containing the four Gospels complete, was brought into the Colbert collection from Cyprus in 1678, and is now in the Royal or Imperial Library at Paris, where it is No. 63. It is an oblong quarto, written in a single column of about twenty-one lines on each page, in large upright and compressed characters, somewhat irregular. A single point of interpunction often standing where the sense does not require it, seems to indicate that it was copied from a text arranged in *στίχοι*. The subscriptions, *τις*, *λοι*, Ammonian sections, and indices of the *κεφάλαια* of the last three Gospels, are believed to be the work of a later hand; the Eusebian canons are absent. The breathings and accents are by the first hand, but often incorrectly placed. The writing, etc., may be taken as proof that the MS. is not older than the middle of the ninth century. Wetstein used readings from it for his N. T., and Scholz also collated it, but not accurately. This has been done more thoroughly by Tischendorf and Tregelles. The MS. yields many valuable readings.—Scribener, *Introduc.* p. 101 sq.; Tregelles, in Horne's *Introduc.* iv, 201 sq. See MANUSCRIPTS, BIBLICAL.

Cyprian, THASCIVS CAECILIUS, a bishop and martyr, was born in North Africa, probably in Carthage, about the beginning of the third century. His father was wealthy, and one of the principal senators of Carthage. His noble parentage insured him a good

education, by which his natural endowments, which were of a high order, were duly developed, both intellectually and morally, according to the heathen type of training. The representation he gives, after his conversion to Christianity, of his earlier immoral life, is generally regarded as an exaggeration springing from humility, and the legend to the effect that he had given himself to the practice of sorcery is not accredited. His life, while he still stood in heathenism, is very much buried in obscurity, even as to the precise time and place of his birth. His biographer, the deacon Pontius, regarded all this as unworthy of mention "in view of that spiritual greatness" which characterized his subsequent life. It seems, however, that he was an earnest student, and that, having enjoyed all the advantages furnished in his time, he excelled in the study of oratory and eloquence, and devoted himself to the teaching of law and rhetoric in his native city, where he was greatly admired, became wealthy, and

lived in affluence and grandeur. His life seems to have received new impetus, concentrated purpose, and meaning from the time of his conversion and baptism, which occurred A. D. 246, when he was not far short of fifty years old. He had been won to Christianity by the presbyter, Caecilius, who also instructed and prepared him for baptism, at which time Cyprian added the name that of Caecilius, out of gratitude to his Christian teacher. Before his conversion he was exercised to deep sense of the vanity of heathenism. In his tract *Gratia Dei*, addressed to his friend Donatus soon after his conversion, speaking of his spiritual state while in heathenism, he says: "I lay in darkness, and floated on the world's boisterous sea, with no resting-place for my feet, ignorant of my proper life, and estranged from truth and light." God's mercy in his behalf he ever praises as being a marked epoch in his life. He felt himself to be a new man, having received "the means of the regenerating wave" the "second life" by the Spirit derived from on high." As a new man he now devoted himself fully to the study of the Holy Scriptures, and also to a life of celibacy and voluntary poverty. He studied the holy Scriptures earnestly and also the best ecclesiastical writers known, among whom Tertullian was his favorite, with whom he continued in mind every day, calling for him, as Jerome relates, with the simple word, "Hand me the *Master*." He sold his estate, and gave the proceeds, together with almost all else that he possessed, for the support of the poor. This he did with the double end in view of renouncing and despising all secular influences, and at the same time fulfilling the law of charity, which he believed God prefers to all sacrifices. Besides the above-mentioned letter, *ad Donatum*, he about this time wrote several works, in which he unfolded his own principles and convictions, as, for instance, *De idolis vanitate* and his *Libri III testimoniorum adv. Iudeos*. So wonderfully grew his Christian reputation that on the death of Donatus, the bishop of Carthage there was a pressing cry from both clergy and laity the Cyprian might be ordained as his successor. He modestly declined the nomination, but the people would not be put off. They so besieged him with their importunities that he fled into retirement to avoid the popular pressure; but the place of his concealment was discovered, and the people surrounded his house, closed every avenue of escape, and refused to withdraw until he should yield to their wishes. He at length humbly bowed to what seemed to him now a necessity imposed on him by the providence of God. Thus, in perhaps not more than two years after his baptism, with the unanimous approbation of the bishops of the province, he was consecrated bishop of Carthage A. D. 248. His elevation to this place of dignity and power, though effected under such wide circumstances, was for him the beginning of long and severe conflicts. Opposition to him arose among some presbyters. Some of the more aged, among whom were Fortunatus and Donatus, who had themselves aspired to the vacant office, with some of their friends among the laity, opposed his elevation as being still only a novice in the Church. See DONATISTS. These gave him much trouble. He treated them with kindness, but at the same time maintained the authority and dignity of his office with decision. In the time of peace which had preceded his official term, luxurious extravagance and immorality had gotten the upper hand in society. Cyprian pushed earnestly for reform and discipline. This became the occasion of increased opposition, his strictness having been attributed to a spirit of hierarchical assumption of power, though he did nothing, especially in the beginning of his episcopate, without first gathering in the views of the presbyters, whom he calls his *co-presbyters* (comp. Ep. 14). Still worse troubles came with the persecution under Decius, which broke out not much more than a year after he had been raised to the episcopal office, in which the heathen populace

h. violence demanded his death, crying *Cyprianum leonem!* The cruel edict came to Carthage about beginning of A.D. 250. The heathen hailed it as giving loose their rage upon one who, having but a few years before stood so prominent in heathenism, occupied the front rank in the Christian Church. accordingly was their first mark. He, however, saved himself by flight, which was made the occasion for fresh reproaches from those in the Church to still bore the old grudge against him. Some saw wardice in this self-exile, but many praised it from considerations of prudence, and as a course which would still preserve his great worth and influence to the Church after peace should be restored. He kept himself in constant correspondence with the Church, and in the deepest sympathy with the trials of the confessors and martyrs. He longed to be with them, and looked upon himself as deprived of all this by a necessarily painful to his heart. He himself seems to have assessed the consciousness of having been in the path of duty, and he gave abundant evidence in his later life, in times of pestilence and in the persecution of Valerian, that he possessed the firmest Christian courage, and knew no fear of death in the path of duty. The strict and severe manner in which, after his return from flight, he dealt with those who had denied the faith under trial was not favorably regarded even by those who had faithfully endured the persecution, and was viewed as coming with less charity and grace from him who had himself withdrawn from the fire. The effects of the persecution had been terribly disastrous. Multitudes were driven from the faith like chaff before the wind. Cyprian looked upon this as a providential sifting of the Church made necessary by its previous worldly and immoral state, and hence was concerned that the lapsed should not be restored without the strictest care. Of the havoc and confusion thus produced in the Church, and the troubles of restoration, he gives a sad picture in his work *de lapsis*. His strictness with the lapsed gave rise to new troubles. The faction of disaffected presbyters was headed now by Felicissimus, with whom were joined Novatian and four others who refused to acknowledge his authority in the form he exercised in the case of the lapsed. They undertook to establish an independent church, into which the lapsed were to be allowed to enter without further delay. Many of the impatient among the lapsed were charmed by his open door for speedy restoration. The result was a serious schism. Cyprian maintains his position firmly, and in a letter warns all against this mare of the devil (Epistle 43). An important series of controversies ensues relating to the unity of the Church, the nature of schism, the validity of baptism by heretics, and affiliated points, which became the occasion of one of the most important works of Cyprian on *The Unity of the Church*. This controversy also gradually involved the question of the independency of the episcopate, and the merits of the claims of Stephanus, the bishop of Rome, as over against the bishop of Carthage. (See Herzog's *Real-Encyclopædie*, iii, 219, 220; also four articles on Cyprian by Dr. Nevin in the *Mercersburg Review*, vol. iv, 1852, particularly p. 527-536.) In this Novatian controversy Cyprian showed great bitterness as well as great firmness, and his statements as to his adversaries are to be taken with many grains of allowance. Hagenbach, in Herzog's *Real-Encyclopædie*, briefly sums up the closing scene of his life, and gives an estimate of his character, which we translate. "At length the time came when he should have opportunity to wipe out the stain which was supposed to rest on his name in consequence of his flight by the blood of his own martyrdom. It took place in the Valerian persecution. On the 30th of August, 257, it was demanded of him by the Roman consul, Aspasius Paternus, to offer to the gods. Having refused, he was banished to Carbis, a day's journey from Car-

thage. From this place he comforted the Church through letters. In a dream he saw foreshadowed the bloody fate which should in a year befall him. Having been called back from exile, he withdrew for a brief season to his country home. Under the consul Galerius Maximus, the successor of Aspasius Paternus, he received his final hearing. With serene composure and the words 'God be praised,' he welcomed the sentence, which was that he should be executed by the sword. Followed by a large crowd of spectators, he was led out beyond the city to a spot planted with trees. Here he laid off his over-clothes, knelt down, prayed, and received the stroke of death, on the 14th of September, A.D. 258. To the executioner he gave twenty-five pieces of gold. The Christians buried him near the spot on which he suffered martyrdom. Over his grave, as well as over the place where he suffered death, churches were afterwards erected, which were, however, demolished at the invasion of the Vandals under Genseric. According to a legend, Charlemagne conveyed his bones to France, where they were preserved, first at Lyons and afterwards at Arles." Other churches also (Venice, Compiègne, and Rosnay in Flanders) claim to be in possession of his remains.

The character of Cyprian and his acts, in the various circumstances of his life, have been variously estimated. While some admire and praise his exalted views and shining virtues as a Church dignitary, others charge him with pride and despotism. The holy earnestness with which he honored his calling, the high degree of self-denial he manifested in life and in death, can as little be denied him as his extraordinary qualifications and activity as a leader in the Church. Herein we must seek his peculiar greatness. Speculative thinking was not his forte. In this respect he is excelled not only by the Alexandrians, but also by Tertullian, to whose theology he conformed his own. Prominent among his doctrinal presentations is that of the Church, the unity of which he develops, not so much dialectically and theoretically as he apprehends it in actual life, and sets it forth in telling pictures in a concrete and energetic way. (Comp. his work, *De unitate ecclesie*.) Cyprian may be regarded as the father of the Roman episcopal system. "In consequence of confounding the ideas of the visible and invisible Church, he referred all Christian life to communion with a definite external Body. In his view the Church was an outward organism founded by Christ, of which the bishops were the pillars; to them the Holy Spirit was communicated through the ordination of the apostles, and hence they were the indispensable links for connecting the Church with Christ. Only through them could the Holy Spirit be imparted, and out of the Church no one could be saved. *Extra ecclesiam hanc visibilem nulla salus*. It is of no avail, says Cyprian, what any man teaches; it is enough that he teaches out of the Church. It can be only human outrageous wilfulness to substitute anything for a divine institution, to erect a human altar instead of the divine" (Neander). Nor can it be denied that Cyprian laid the foundations of the primacy of the see of Rome. He placed the unity of the Church in the episcopate, making the bishops representatives of the apostles; and further, he made the chair of St. Peter the centre of episcopal unity, and the Church at Rome the root of all (*radix et matrix ecclesie Catholice*, Epist. 45). Practically, in his quarrel with pope Stephen (see above), he denied this primacy; but the doctrine lay in his own writings, and, after he had passed away, the legitimate inferences from his doctrines were drawn by his successors. But, while the writings of Cyprian afforded undoubtedly a basis, on the one hand, for Roman and prelatical claims, they have unquestionable merit, on the other, of setting forth Scripture as the sole ground of faith. During his controversy with pope Stephen, who was continually talking of

tradition, Cyprian uttered the sharp and pregnant aphorism, "Custom without truth is only ancient error." As an interpreter of Scripture, Cyprian occupies altogether a practical stand-point, and hence does not despise allegory wherever it forces itself upon his fancy. (See Herzog, *Real-Encyclop.* iii, 220-221.) His life has been written by the African presbyter Pontius, *De vita Cypriani* (in Ruinart, *Acta Martyrum*, ii, and in the editions of the works of Cyprian). With this, compare *Acta Proconsularia Martyris Cypriani* (in Ruinart, 216 sq.); Lactant. *Div. Inst.* v, 1; Eusebius, *H. E.* vii, 8; also later works of Pearson, *Annales Cypriaci* (Oxf. 1682); P. Maran, *Vita Cypriani*; H. Dodwell, *Diss. Cypriacæ* (Oxon. 1684); Tillemont, *Memoires*, iv, 76 sq.; (Gervaise), *La vie de S. Cyprien* (Paris, 1717, 4 vols.); Freppel, *St. Cyrien, et l'église d'Afrique en troisième siècle* (Paris, 1865, 8vo); *Quart. Review*, London, July, 1858, art. iv; Cooper, *Free Church of ancient Christendom*, p. 297 sq. (Lond. 1844, 18mo); Cunningham, *Historical Theology*, ch. vi, § 6.

The best editions of Cyprian's works (*Opera Omnia*) are those of Oxf. 1682, fol., ed. Fell; Amst. 1700; Par., Benedictine ed., 1726, fol., and Ven. 1728, fol. Translation: *The genuine Works of St. Cyprian*, with his Life, by Pontius, by Nathaniel Marshall, LL.B. (London, 1717, fol.); also in French by Lombert (1682). Translations of separate tracts: *On Mortality*, with others, by Elyot (1584), by Brende (1558), by Story (1556), and by Lupset (1560); on *The Lord's Prayer*, by Payne (1539); on *Virgins*, by Barksdale (1675); on *The Unity of the Church*, by bishop Fell (1681, 4to); and by Horsburgh (1815). The *Epistles* translated, *Library of the Fathers*, vol. xvii (Oxf. 1844); the *Treatises, Lib. of Fathers*, vol. iii (Oxford, 1840). The life and martyrdom of Cyprian, by Pontius, his intimate friend, is still extant, and printed in several editions of the *Opera Omnia*, but the style is too rhetorical for simple truth. A compact edition of Cyprian for practical use is *Cypriani Opera Genuina*, ed. Goldhorn (Leips. 1838-9, 2 parts). A new *Life of Cyprian*, by Poole, was published in 1840 (Oxf. 8vo); another, by Rettberg, in 1831 (Göttingen, 8vo); another in *Saint Cyprien, Œuvres complètes*, traduct. Guillon (Par. 1836, 2 vols. 8vo). New editions of several of the epistles were published by Krabinger (Tubing. 1853-1858, sq.).

Cyprarch (Κυπρίάρχης, "governor of Cyprus"),

the title of Nicanor (q. v.) as Syrian viceroy of the island of Cyprus (2 Mac. xii, 2).

Cyprus (Κύπρος, i. e. *Cyprus*), the name of several females of the Herodian family. See HEROD.

1. An Idumean (or Arabian) of noble family, viz of Antipater the elder, by whom he had four sons, Phasaelus, Herod (the Great), Joseph, and Phana, and a daughter, Salome (Joseph. *Ant.* xiv, 7, 3; *War* i, 9, 9).

2. The second of the two daughters of Herod the Great by Mariamne; she was married to her own Antipater, the son of Salome, Herod's sister (Joseph. *Ant.* xviii, 5, 4).

3. The second of the two daughters of Phanaeus (Herod the Great's brother) by his niece Salome; she was married to Agrippa I, the son of Aristion, by whom she had two sons and three daughters: Joseph. *Ant.* xviii, 5, 4; *War*, ii, 11, 6). She overthrew her husband from his purpose of suicide (*Ant.* xviii, 6, 2).

4. The daughter of the above (No. 2) wife of Antipater; she was married to Alexas Selcias (Joseph. *Ant.* xviii, 5, 4).

5. A daughter by the marriage preceding (4).

Cyprus (Κύπρος), the modern *Kebria*, one of the largest islands in the Mediterranean, and next to Sicily in importance. It is about 140 miles in length and varies in breadth from 50 to 5 miles. The interior of the island is mountainous, a ridge being drawn across the entire length, attaining its highest elevation near the central region anciently called Olympos. It had several names in early ages, mostly local. From its numerous headlands and promontories it was called *Kepaoricæ*, *Cerastia*, or *the Horned*; and from its exuberant fertility, *Maxapia*, *Macaria*, or *the Esmi* (Horace, *Carv.* iii, 26, 9). Its proximity to Asia Minor, Phœnicia, and Egypt, and its numerous havens made it a general rendezvous for merchants. "Cere, wine, and oil," which are so often mentioned in the Old Testament as the choicest productions of Palestine (Deut. xii, 17; 1 Chron. ix, 29; Neh. x, 89; Jer. xiii, 12), were found here in the highest perfection. The forests also furnished large supplies of timber for ship-building, which rendered the conquest of the island a favorite project of the Egyptian kings. It was the

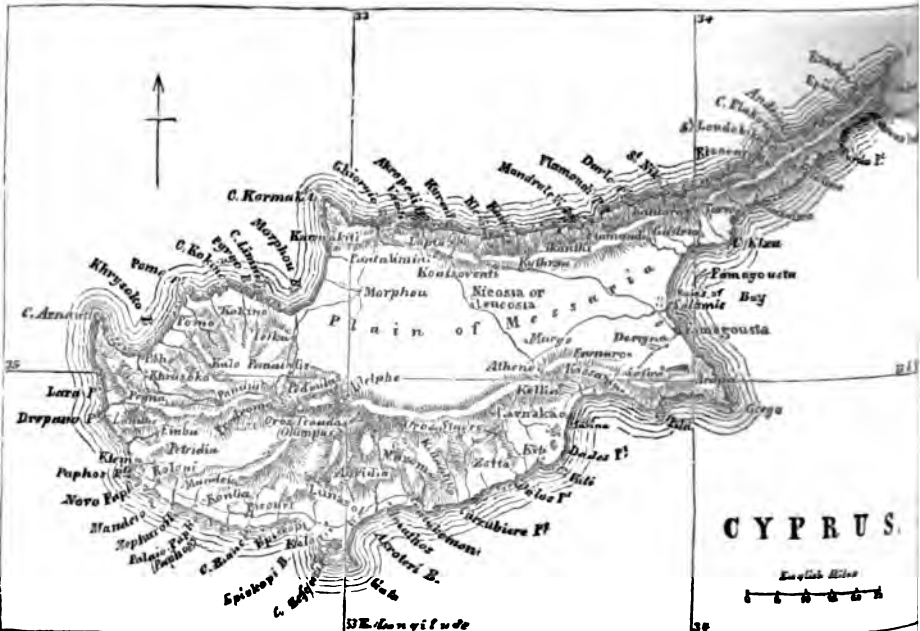

east of the Cyprians that they could build and com-
 ste their vessels without any aid from foreign coun-
 ces (Arrian. Marcell. xiv, 8, § 14). Among the
 neral products were diamonds, emeralds, and other
 ecious stones, alum, and asbestos; besides iron, lead,
 c, with a portion of silver, and, above all, copper,
 e far-famed as *Cyprium*. The principal mines were
 the neighborhood of Tamassus (Strabo, xiv, 6; iii,
 5, ed. Tauchn.). Pliny ascribes the invention of
 ass to this island (*Nat. Hist.* xxiv, 2). Cyprus is a
 mous place in mythological history. The presiding
 vinity of the island was Venus, who had a celebrated
 mple at Paphos, and is hence often called the Paphi-
 goddess. The inhabitants were luxurious and ef-
 minate (Herod. i, 199; Athen. 12, p. 516; Clearch.
pod Athen. 6, p. 255). Nevertheless, literature and
 e arts flourished here to a considerable extent, even
 t an early period, as the name of the *Cypria Carmina*,
 scribed by some to Homer, sufficiently attests (Herod.
 , 118; Athen. 15, p. 682). Situated in the extreme
 astern corner of the Mediterranean, with the range
 f Lebanon on the east and that of Taurus on the north
 istinctly visible, it never became a thoroughly Greek
 land. Its religious rites were half Oriental, and its
 olitical history has almost always been associated
 with Asia and Africa.—Smith's *Dict. of Class. Geog.*
 . v. See PAPHOS.

Cyprus was originally peopled from Phœnicia (Ge-
 nensis, *Mon. Phœn.* p. 122). Amasis I, king of Egypt,
 subdued the whole island (Herod. ii, 182). In the
 ime of Herodotus the population consisted of Athen-
 ans, Arcadians, Phœnicians, and Ethiopians (vii, 90);
 and for a long time the whole island was divided into
 nine petty sovereignties (Xenoph. *Cyrop.* viii, 6, 21;
 Pliny, v, 85; Diod. Sic. xvi, 42). It became a part
 of the Persian empire (Herod. iii, 19, 91), and furnish-
 ed ships against Greece in the expedition of Xerxes
 (ib. vii, 90). For a time it was subject to Greek in-
 fluence, but again became tributary to Persia. After
 the battle of Issus it joined Alexander, and after his
 death fell to the share of Ptolemy. In a desperate
 sea-fight off Salamis (q. v.), at the east end of Cyprus
 (B.C. 306), the victory was won by Demetrius Polior-
 cetes; but the island was recovered by his rival, and
 afterwards it remained in the power of the Ptolemies,
 and was regarded as one of their most cherished pos-
 sessions (Livy, xiv, 12; Josephus, *Ant.* xiii, 10, 4;
 Strabo, xiv, 684; Diod. Sic. xix, 59, 79; xx, 21, 47).
 It became a Roman province (B.C. 58) under circum-
 stances discreditable to Rome (Strabo, xiv, 684; Flor.
 iii, 9; Vell. Pat. ii, 88; Dion Cass. xxxviii, 31; xxxix,
 22). At first its administration was joined with that of
 Cilicia, but after the battle of Actium it was separately
 governed. In the first division it was made an im-
 perial province (Dion Cass. liii, 12). From this passage
 and from Strabo (xiv, p. 683) it has been supposed by
 some, as by Baronius, that Luke (Acts xiii, 7) used the
 word ἀνθύπατος (*proconsul*, "deputy"), because the
 island was still connected with Cilicia; by others, as
 by Grotius and Hammond, that the evangelist em-
 ploys the word in a loose and general manner. But,
 in fact, Dion Cassius himself distinctly tells us (ib. and
 liv, 4) that the emperor afterwards made this island a
 senatorial province, so that Luke's language is in
 the strictest sense correct. Further confirmation is
 supplied by coins and inscriptions, which mention oth-
 er *proconsuls* of Cyprus not very remote from the time
 of Sergius (q. v.) Paulus. The governor appears to
 have resided at Paphos, on the west of the island.
 Under the Roman empire a road connected the two
 towns of Paphos and Salamis, as appears from the
Peut. Table. One of the most remarkable events in
 this part of the history of Cyprus was a terrible insur-
 rection of the Jews in the reign of Trajan, which led
 to a massacre, first of the Greek inhabitants, and then
 of the insurgents themselves (Milman, *History of the
 Jews*, iii, 111, 112). When the empire was divided it



Copper Proconsular Coin of Cyprus, with the head and title
 (in Latin) of *Claudius Cæsar*, and the legend (in Greek),
 "Under Arminius Proclus, Proconsul [ἀντιπρόξενος] of the
 Cyprians."

fell to the share of the Byzantine emperors. Richard
 I of England conquered it in 1191, and gave it to Guy
 Lusignan, by whose family it was retained for nearly
 three centuries. In 1473 the republic of Venice ob-
 tained possession of it; but in 1571 it was taken by
 Selim II, and ever since has been under the dominion
 of the Turks. Cyprus was famed among the ancients
 for its beauty and fertility, and all modern travellers
 agree that in the hands of an industrious race it would
 be one of the most productive countries in the world,
 but Turkish tyranny and barbarism have reduced it
 to a deplorable condition. Through the neglect of
 drainage, the streams that descend from the mountain
 range form marshes, and render the island particu-
 larly unhealthy. Imperfectly as it is cultivated, how-
 ever, it still abounds in every production of nature,
 and bears great quantities of corn, figs, olives, oranges,
 lemons, dates, and, indeed, of every fruit seen in these
 climates; it nourishes great numbers of goats, sheep,
 pigs, and oxen, of the latter of which it has at times
 exported supplies to Malta. The most valuable prod-
 uct at present is cotton. The majority of the popula-
 tion belong to the Greek Church; the archbishop re-
 sides at Leikosia.—*Penny Cyclopædia*, s. v.; *M'Cul-
 loch's Gazetteer*, s. v.

"This island was in early times in close commercial
 connection with Phœnicia, and there is little doubt
 that it is referred to in such passages of the O. T. as
 Ezek. xxvii, 6. See CHITTIM. Josephus makes this
 identification in the most express terms (*Ant.* i, 6, 1;
 so Epiphani. *Haer.* xxx, 25). Possibly Jews may have
 settled in Cyprus before the time of Alexander. Soon
 after his time they were numerous in the island, as is
 distinctly implied in 1 Macc. xv, 23 (comp. Josephus,
Ant. xiii, 10, 4; Philo, *Opp.* ii, 587). The name also
 occurs 2 Macc. x, 13; xii, 2. The copper mines were
 at one time farmed to Herod the Great (Josephus, *Ant.*
 xvi, 4, 5), and there is a Cyprian inscription (Böckh,
 No. 2628) which seems to refer to one of the Herods.
 The first notice of it in the N. T. is in Acts iv, 36,
 where it is mentioned as the native place of Barnabas.
 In Acts xi, 19, 20, it appears prominently in connec-
 tion with the earliest spreading of Christianity, first
 as receiving an impulse among its Jewish population
 from the persecution which drove the disciples from
 Jerusalem at the death of Stephen, and then, as fur-
 nishing disciples who preached the Gospel to Gentiles
 at Antioch. Thus, when Paul was sent with Barna-
 bas from Antioch on his first missionary journey, Cy-
 prus was the first scene of their labors (Acts xiii, 4-13).
 Again, when Paul and Barnabas separated and took
 different routes, the latter went to his native island,
 taking with him his relative Mark, who had also been
 there on the previous occasion (Acts xv, 39). Another
 Christian of Cyprus, Mnaon, called 'an old disci-
 ple,' and therefore probably an early convert, is men-
 tioned Acts xxi, 16. The other notices of the island
 are purely geographical. On Paul's return from the
 third missionary journey, they 'sighted' Cyprus, and
 sailed to the southward of it on the voyage from Pa-
 taras to Tyre (ib. 8). At the commencement of the
 voyage to Rome they sailed to the northward of it on
 leaving Sidon, in order to be under the lee of the land
 (Acts xxvii, 4), and also in order to obtain the advan-

tage of the current, which sets northerly along the coast of Phœnicia, and westerly with considerable force along Cilicia" (Smith s. v.). See SHIPWRECK (OF PAUL).

All the ancient notices of Cyprus are collected by Meursius (*Opera*, vol. iii, Flor. 1744). Comp. Cellarii *Notit.* ii, 266 sq.; see also Engel's *Kypros* (Berlin, 1848) and Ross's *Reisen nach der Insel Cypern* (Halle, 1852). Further accounts may be found in Mannert, *Geographia*, VI, ii, 422-454. Modern descriptions are given by Pococke, *East*, ii, 210-235; Wilson, *Lands of Bible*, ii, 174-197; Turner, *Levant*, ii, 40, 528; Martil, *Viag. in Cyper.* (Flor. 1679); Unger and Kotschy, *Die Insel Cypern* (Wien, 1866).

CYPRUS, CHRISTIANITY IN. Bishops of Cyprus are for the first time mentioned in the 4th century. Soon Constantia became the seat of a metropolitan, who asserted and maintained his independence of all the patriarchs. At the beginning of the 5th century the patriarch John of Antioch made an effort to have Cyprus incorporated with his patriarchal district, but the Œcumenical Council of Ephesus (481), before which the newly-elected metropolitan Reginus and two other Cyprian bishops pleaded their right, decided in favor of the independence of Cyprus. Ever since the churches of Cyprus have constituted an independent group of the orthodox Greek Church.—Wetzer und Welte, *Kirchen-Lex.* ii, 964 sq.

CYRAN, St. See DUVERGIER DE HAURANNE.

Cyre'nè (Κυρήνη; *Ghremna*, in modern Arabic), a city in Upper Libya, founded by a colony of Greeks from Thera (Santorini), a small island in the Ægean Sea (Thirlwall's *History of Greece*, vol. ii, ch. 12). Its name is generally supposed to be derived from a fountain (but according to Justin, *Hist.* xlii, a mountain), called *Kυρή*, *Cyre*, near its site. It was built on a table-land, 1800 feet above the level of the sea, in a region of extraordinary fertility and beauty. It was the capital of a district, called from it *Cyrenaica* (Barca), which extended from the Gulf of Platæa (Bomba) to the Great Syrtis (Gulf of Sidra). With its port Apollonia (Musa Soosa), about ten miles distant, and the cities Barca, Teuchira, and Hesperis, which at a later period were named Ptolemais, Arsinoë, and Berenice (Strabo, xvii; vol. iii, p. 496, ed. Tauchn.), it formed the Cyrenaic Pentapolis (Mel. i, 4, 8; Pliny, v, 5; Ptolem. iv, 4, 11; Amm. Marcell. xxii, 16). It is observable that the expression used in Acts ii, 10, "the parts of Libya about (*κατά*) Cyrene," exactly corresponds with a phrase used by Dion Cassius (Ἀίθιη ἢ περί Κυρήνην, liii, 12), and also with the language of Josephus (ἡ πρὸς Κυρήνην Αἰθίη; *Ant.* xvi, 6, 1). See LIBYA. Its inhabitants were very luxurious and refined, and it was, in a manner, a commercial rival of Carthage (Forbiger, *Handb. der alt. Geogr.* ii, 380 sq.; Ritter, *Erdk.* i, 946 sq.). The Greek colonization of this part of Africa under Battus began as early as B.C. 681, and it became celebrated not only for its commerce, but for its physicians, philosophers, and poets (Herod. iv, 155, 164). It would seem that the old Hellenic colonists cultivated friendly relations with the native Libyans, and to a much greater extent than usual became intermingled with them by marriage relationships (Herod. iv, 186-189). For above 180 years the form of government was monarchical; it then became republican, and at last the country became tributary to Egypt, under Ptolemy Soter. It was bequeathed to the Romans by Apion, the natural son of Ptolemy Physcon, about B.C. 97 (Tacitus, *Ann.* xiv, 18; Cicero, *De leg. Agrar.* ii, 19), and in B.C. 75 formed into a province (Strabo, xvii, 3). On the conquest of Crete (B.C. 67) the two were united in one province, and together frequently called Creta-Cyrene. See CRETE. An insurrection in the reign of Trajan led to great disasters, and to the beginning of its decay. In the 4th century it was destroyed by the natives of

the Libyan desert, and its wealth and honors were transferred to the episcopal city of Ptolemais, in a neighborhood. The Saracens completed the wide destruction, and for centuries not only the city,

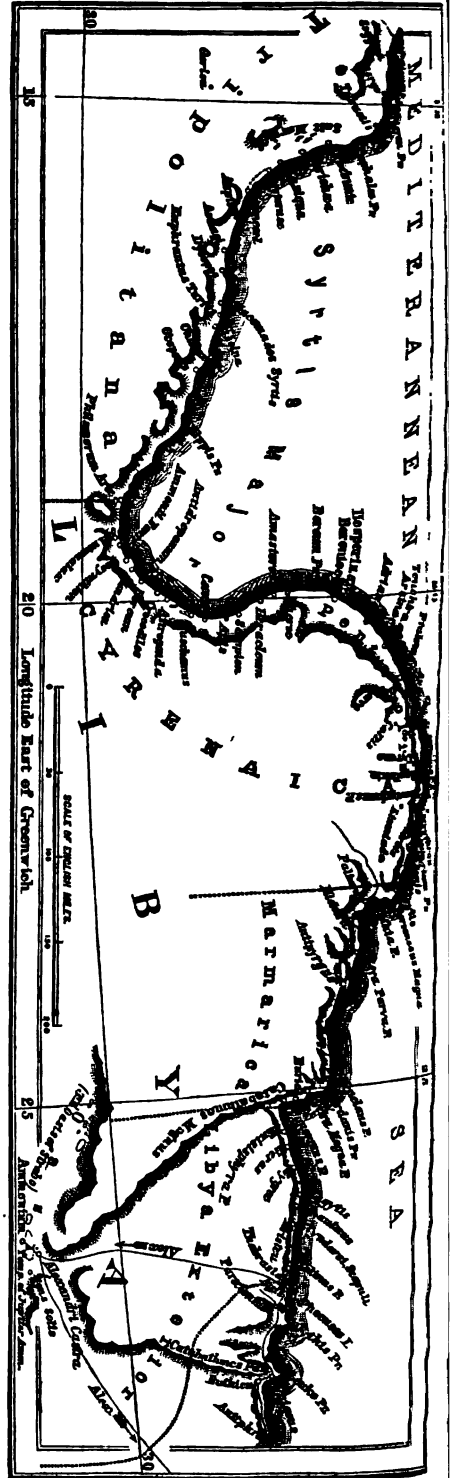

Map of the Coast of Africa adjoining Cyrene.

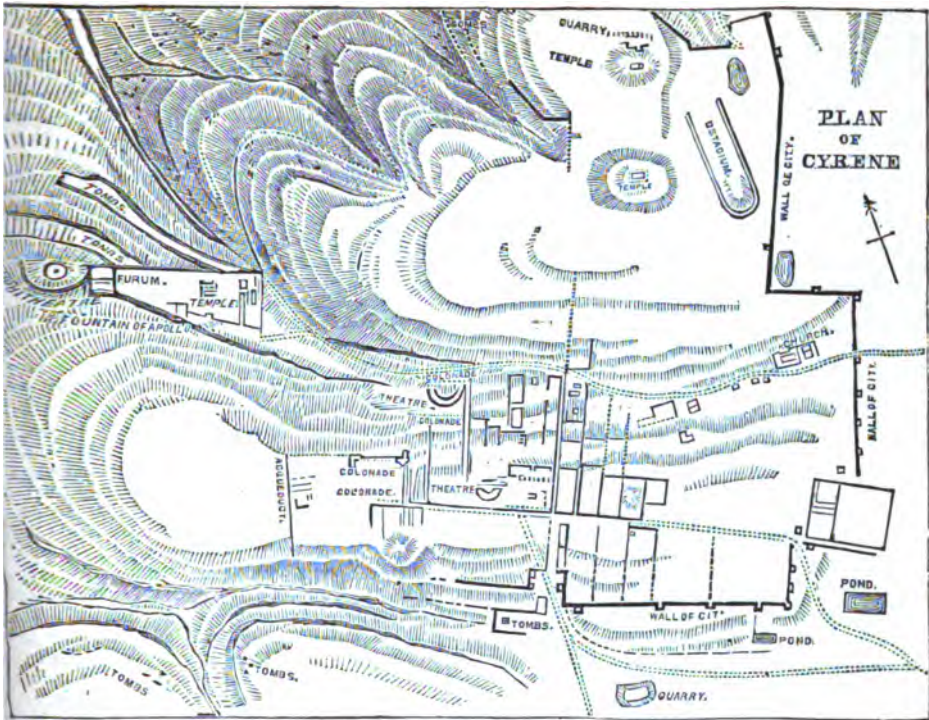

the once populous and fertile district of which it was the ornament, has been almost lost to civilization. During three parts of the year the place is tenanted by wild animals of the desert, and during the fourth part the wandering Bedouins pitch their tents on the low grounds in its neighborhood.—Smith, *Dict. of Class. Geog.* s. v.; *Penny Cyclopædia*, s. v. Cyrenaica, Cyrene; Rawlinson's *Herodotus*, iii, 108 sq.

Jews in Cyrene (confirmed by Philo, who speaks of the diffusion of the Jews southward to Ethiofia, *adv. Flacc.* p. 523) prepare us for the frequent mention of the place in the N. T. in connection with Christianity. Simon, who bore our Saviour's cross (Matt. xxvii, 32; Mark xv, 21; Luke xxiii, 26), was a native of Cyrene. Jewish dwellers in Cyrenaica were in Jerusalem at Pentecost (Acts ii, 10). They even gave their name to one of the synagogues in Jerusalem (vi, 9). Christian converts from Cyrene were among those who contributed actively to the formation of the first Gentile church at Antioch (xi, 20), and among those who are specially mentioned as laboring at Antioch, when Barnabas and Saul were sent on their missionary journey, is Lucius of Cyrene (xiii, 1), traditionally said to have been the first bishop of his native district. Other traditions connect Mark with the first establishment of Christianity in this part of Africa. See AFRICA.

See Della Cella, *Viaggio da Trpoli*, etc. (Genoa, 1819); Pacho, *Voyage dans la Marmarique, la Cyrenaïque* (Paris, 1827-29); Trige, *Res Cyrenenses* (Hafn. 1828); Beechey, *Expedition to Explore the north Coast of Africa* (London, 1828); Barth, *Wanderungen durch das Punische u. Kyrenäische Küstenland* (Berlin, 1849); Hamilton, *Wanderings in North Africa* (London, 1856), p. 78; Smith and Porcher, *Hist. of Discoveries at Cyrene* (Lond. 1865).

Cyre'nian (Κυρηναῖος, *Cyrenaean*, "of Cyrene," Matt. xxvii, 32; Acts xi, 20; xiii, 1), a native of Cyrene (q. v.) or Cyrenaica, in Africa (Mark xv, 21; Luke xxiii, 26; Acts vi, 9).

Cyre'nianus (Græcized Κυρηναῖος, Luke ii, 2; see Deyling, *Obs.* ii, 431 sq.), for the Latin *Quirinius* (prob. not *Quirinius*; see Meyer, *Comment.* in loc.). His full name was PUBLIUS SULPICIUS QUIRINUS (see Sueton. *Tiber.* 49; Tacit. *Ann.* ii, 80). He is the second of that name mentioned in Roman history (see Smith, *Dict. of Class. Biog.* s. v.), and was consul with M. Valerius Messala, B.C. 12. From the language of Tacitus (*Ann.* iii, 48), it would appear that he was of obscure origin, a supposition apparently favored by

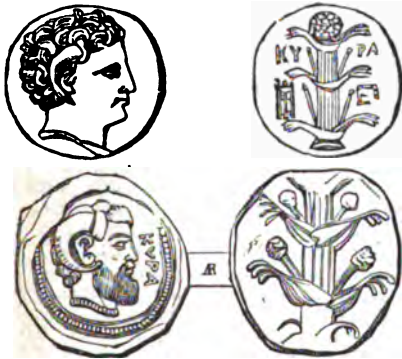

Coins of Cyrene, bearing the sacred *Sithium* Plant (which was the chief article of export).

Strabo (quoted by Josephus, *Ant.* xiv, 7) says that in Cyrene there were four classes of persons, namely, citizens, husbandmen, foreigners, and Jews, and that the latter enjoyed their own customs and laws (comp. Dio Cass. lviii, 32). Ptolemy, the son of Lagus, introduced them, because he thought they would contribute to the security of the place (Joseph. *c. Apion.* ii, 4). They became a prominent and influential class of the community (*Ant.* xiv, 7, 2), and they afterwards received much consideration from the Romans (xvi, 6, 5). See 1 Macc. xv, 28; comp. 2 Macc. ii, 28. We learn from Josephus (*Life*, 76) that soon after the Jewish war they rose against the Roman power. The notices above given of the numbers and position of the

his surname, *Quirinus*, if rendered (as it might perhaps be) the *Cyrenias*, but opposed by it if referred to the old Sabine epithet of Romulus. He is more likely to have been the son of the consul of the same name, B.C. 42. Tacitus, however, states (*ut sup.*) that he was a native of Lanuvium, near Rome, and was not a member of the ancient Sulpician family; and that it was owing to his military abilities and active services that he gained the consulship under Augustus. He was subsequently sent into Cilicia, where he was so successful in his campaign as to receive the honor of a triumph. In B.C. 1, or a year or two afterwards, Augustus appointed him to direct the counsels of his grandson C. Cæsar, then in Armenia; and on his way thither he paid a visit to Tiberius, who was at that time living at Rhodes. Some years afterwards, but not before B.C. 5, he was appointed governor of Syria, and while in this office he took a census of the Jewish people. He was a favorite with Tiberius, and on his death, A.D. 21, he was buried with public honors by the senate at the request of the emperor. (Dion Cass. liv, 28; Tacitus, *Ann.* iii, 22; Strab. xii, p. 569; Josephus, *Ant.* xiv, 1, 1.)—Smith, *Dict. of Class. Biog.* s. v.

The mention of the name of Quirinus in connection with the census which was in progress at the time of our Lord's birth presents very serious difficulties, of which, from the want of adequate data, historical and critical inquiry has not yet attained an entirely satisfactory solution. The passage is as follows: *αὕτη ἡ ἀπογραφὴ πρώτη ἐγένετο ἡγεμονεύοντος τῆς Συρίας Κυρηνίου*, translated in the Authorized Version thus: "Now this taxing was first made when Cyrenius was governor of Syria." Instead of "taxing" it is now agreed that the rendering should be "enrolment" or "registration" (of which use of the word *ἀπογράφεισθαι* many examples are adduced by Wetstein), as it is clear from Josephus that no taxing did take place till many years after this period. The whole passage, as it now stands, may be properly read, "This first enrolment took place while Cyrenius was governor of Syria." This appears very plain, and would suggest no difficulty were it not for the knowledge which we obtain from other quarters, which is to the effect, 1. That there is no historical notice of any enrolment at or near the time of our Lord's birth; and, 2d, That the enrolment which actually did take place under Cyrenius was not until ten years after that event. The difficulty begins somewhat before the text now cited; for it is said that "in those days there went out a decree from Cæsar Augustus that the whole world should be taxed" (enrolled). But since no historian mentions any such general enrolment of the whole empire, and since, if it had taken place, it is not likely to have been mentioned in connection with the governor of Syria, it is now usually admitted that *Judæa* only is meant by the phrase rendered "the whole earth" (but more properly "the whole land"), as in Luke xxi, 26; Acts xi, 28; and perhaps in xxi, 20. The real difficulties are thus reduced to the two now stated. With regard to the enrolment, it may be said that it was probably not deemed of sufficient importance by the Roman historians to deserve mention, being confined to a remote and comparatively unimportant province. Nor was it perhaps of such a nature as would lead even Josephus to take notice of it, if it should appear, as usually supposed, that no trace of it can be found in his writings.—Kitto, s. v.

Quirinus held a census in *Judæa* after the banishment of Archelaus (Joseph. *Ant.* xviii, 1, 1), which took place B.C. 6. This is what is meant by the *taxing* (*ἀπογραφὴ*) in Acts v, 37. Hence it is evident that he cannot have held a census in *Judæa* in the year of Christ's birth, as is said in Luke ii, 2, in the capacity of head of the province of Syria (the census, however, being a general one throughout the empire, according to the emperor's command, v, 1). At that time Q.

Sentius Saturninus (Tert. *adv. Marc.* iv, 19), or, if *Jem* was born after B.C. 6, P. Quintilius Varus, must have been governor of Syria (Ideler, *Chronol.* ii, 394 sq.). The interpreters have attempted various methods of reconciling the words of Luke, "This taxing was first made when Cyrenius was governor of Syria." Luke ii, 2, with the chronology of Josephus. (See *Wil. Cur.* i, 576 sq.; Zorn, *Hist.* *Fizi. Jud.* p. 91 s.; Thies, *Krit. Comment.* ii, 385 sq.; Kuinöl, *Comm.* ii, 801 sq., whose references, however, are not precise; K. Nahmacher, *De Augusto ter censum agn.* Helmst. 1758, ii, 4; Huschke, *Ueb. d. zur Zeit des Geburts. J. Chr. gehalt. Cens.* Bresl. 1840; Wieseler, *Chr. Synopse*, p. 111 sq.). Apart from these, who cut a knot by pronouncing the passage an interpolation (as Beza in his first three eds., Pfaff, Venema, Kuinöl, G. hausen, and others), we notice the following:

1. Some suppose that *πρώτη, first*, stands for *πρωια* former (comp. John i, 15, *πρωτός μου, before me*), so that the genitive *ἡγεμονεύοντος Κυρηνίου* is governed by the comparative; rendering, *this census took place before Quirinus was governor of Syria.* (So J. G. Hart, *Admir. Ethic. Theol. Myster. propal. Mosæ.* 1626, p. 188; Petavius, Bynæus, Clericus, J. Peninus, *De August. Orbis Terrar. Descrip.*, in his *Disputa de Prator.* p. 908 sq.; Zeltner, Heumann, *De Cens. Antæquir.* 1782, and in his *Dissert. Stylogæ.* i, 763 sq.; Norisius, *Cenotaph. Pisan.* ii, 16; Storr, *Opusc. Ant.* iii, 126 sq.; Stakind, *Verm. Aufsätze*, p. 63; Michaelis, *Ueber d. Geburts- und Sterb-jahr Christi*, i, 59 sq.; Tholuck, *Glaubwörter.* d. p. 182 sq., and others). But this would be strange Greek, even if *πρωτέρα* stood in the passage (comp. Fritzsche on Rom. ii, 421 sq., who also the passage of the Sept. Jer. xxix, 2, compared by Tholuck, is settled); and the possibility of writing *πρώτη* for it is not established by the reference to John, and certainly such a use would be especially avoided where, as here, every reader must naturally understand the passage as the Auth. Vera. render it. More recently, Huschke, *ut. sup.* p. 89; Wieseler, *ut. sup.* 117 sq., and an anonymous writer in Rheinwald's *Repertor.* xxxvi, 105, have discovered that Luke purposely places the superlative before the genitive to express this meaning: *this census as the first (i. e. of all Roman censuses) before Quirinus became governor*; and that there is here an abbreviated expression, as is usual with the comparative degree, which they would fill out thus: *πρὸ τῆς ἀπογραφῆς γενομένης ἡγεμονεύοντος κ. τ. λ.* Surely no one acquainted with Luke's style could suppose him to have written such jargon, and expressed this complicated idea with words which on their face mean something very different. This is the result of considering a language only in the light of one's study, not in that of living intercourse.

2. Several have tried conjectural emendation (comp. Bowyer, *Critical Conject. on the N. T.* i, 117 sq.). Heumann gives as another's suggestion *Κρονίου*, corresponding to the Latin Saturninus. Whiston, *Prim. N. T.* (Lond. 1745), reads *αὕτη ἡ ἀπογ. πρ. Σαττουίνου δευτέρα δὲ ἐγένετο ἡγεμ. τῆς Συρ. Κυρ.*, i. e. *This first census took place when Saturninus was governor of Syria, and a second under Quirinus.* But the last clause has no pertinence here. L. Capellus and Huetius, *Demonstr. Evang.* p. 781, put *Κωνσταντίου, Quintilianus*, or *Κ. Οὐάρον, Q. Varus*, instead of Quirinus. Q. Varus succeeded Saturninus B.C. 6 (see Josephus, *Ant.* xvii, 3, 2; Tacit. *Hist.* v, 9). Michaelis, *Einleit. ins N. T.* i, 71, would read *πρὸ τῆς ἀπογ. πρώτης* (i. e. *before that under Quirinus, etc.*), which might easily have dropped out (comp. R. Roullier, *Dissert. Sacr.* Amst. 1750, No. 4). H. Venema, *Selectæ e Scholis Valck.* i, 70, thought *αὕτη ἡ ἀπογ. πρώτης ἢ β* (i. e. *δευτέρα*) *ἐγένετο ἡγεμ. etc.*, i. e. *This was the first census; but the second took place when Quirinus, etc.* But again the second clause is out of place. Valelius (ad Euseb. *H. E.* i, 5) would at once write Saturninus for Quirinus. All such changes of the text, especially in the face of the un-

mity of manuscripts and versions (see Griesbach in c.), is uncritical and forced.

8. Rejecting all these methods of reconciliation, some suppose a mistake or misrecollection on Luke's part (Ammon, *Bibl. Theolog.* ii, 271; *Comm. de Censu* v. Erlangen, 1810; *Leben Jesu*, i, 201 sq.; Thies, *rit. Comm.* ii, 385; Strauss, *Leben Jesu*, p. 262 sq.; Eisele, *Evangel. Geschichte*, i, 204 sq.), it being, at the time of writing, many years since the occurrence. Winer, who still holds the census as a fact, and thinks Quirinus may have conducted it (Neander, *Leben Jesu*, p. 25; Meyer on Luke, ii, 2), the only error being in naming him governor of Syria (comp. *Altes und Neues*, 1727, p. 120). Certainly it is not to be supposed that Luke here refers to the above-mentioned census of Quirinus (Acts v, 37), and misdates it thus, or the mention of it in Acts shows that he was well acquainted with it; and even in ii, 2, the word *first* seems to imply the other.—Winer, ii, 292.

4. Another mode of getting over the difficulty is intimated by the names of Calvin, Valesius, Wetstein, Hales, and others. First, changing *αὐτῆ* into *τοῦ*, they obtain the sense: "In those days there went forth a decree from Augustus that the whole land should be enrolled; but the enrollment itself was first made when Cyrenius was governor of Syria." The supposition here is, that the census was commenced under Saturninus, but was not completed till two years after, under Quirinus. Dr. Robinson (*Addit. to Calmet*, in "Cyrenius") objects to this view the entire absence of any historical basis for it. But he must at the time have been unmindful of Hales, who, in his *Chronology* (iii, 48-58), has worked out this explanation with more than his usual care and success. Hales reminds us that a little before the birth of Christ, Herod had marched an army into Arabia to redress certain wrongs which he had received; and this proceeding had been so misrepresented to Augustus that he wrote a very harsh letter to Herod, the substance of which was, that "having hitherto treated him as a friend, he would now treat him as a subject." And when Herod sent an embassy to clear himself, the emperor repeatedly refused to hear them, and so Herod was forced to submit to all the injuries (*παραινόμενος*) offered to him (Joseph. *Ant.* xvi, 9). Now it may be collected that the chief of these injuries was the performance of his threat of treating him as a subject by the degradation of his kingdom to a Roman province. For soon after Josephus incidentally mentions that "the whole nation of the Jews took an oath of fidelity to Cæsar and the king jointly, except 6000 of the Pharisees, who, through their hostility to the regal government, refused to take it." The date of this transaction is determined by its having been shortly before the death of Pheroras, and coincides with the time of this decree of enrolment and of the birth of Christ. The oath which Josephus mentions would be administered at the same time, according to the usage of the Roman census, in which a return of persons, ages, and properties was required to be made upon oath, under penalty of confiscation of goods, as we learn from Ulpian. That Cyrenius, a Roman senator and procurator, was employed to make this enrolment, we learn not only from Luke, but by the joint testimony of Justin Martyr, Julian the Apostate, and Eusebius; and it was made while Saturninus was president of Syria (to whom it was attributed by Tertullian), in the thirty-third year of Herod's reign, corresponding to the date of Christ's birth. Cyrenius, who is described by Tacitus as "an active soldier and rigid commissioner," was well qualified for an employment so odious to Herod and his subjects, and probably came to execute the decree with an armed force. The enrolment of the inhabitants, "each in his own city," was in conformity with the wary policy of the Roman jurisprudence, to prevent insurrections and to expedite the business; and if this precaution was judged prudent

even in Italy, much more must it have appeared necessary in turbulent provinces like Judæa and Galilee. At the present juncture, however, it appears that the census proceeded no farther than the first act, namely, the enrolment of persons in the Roman register. For Herod sent his trusty minister, Nicolas of Damascus, to Rome, who, by his address and presents, found means to mollify and undeceive the emperor, so that he proceeded no farther in the design which he had entertained. The census was consequently at this time suspended; but it was afterwards carried into effect upon the deposal and banishment of Archelaus, and the settlement of Judæa as a Roman province. On this occasion the trusty Cyrenius was sent again, as president of Syria, with an armed force, to confiscate the property of Archelaus, and to complete the census for the purposes of taxation. This taxation was a poll-tax of two drachmæ a head upon males from fourteen, and females from twelve to sixty-five years of age—equal to about fifteen pence of our money. This was the "tribute money" mentioned in Matt. xvii, 24-27. The payment of it became very obnoxious to the Jews, and the imposition of it occasioned the insurrection under Judas of Galilee, which Luke himself describes as having occurred "in the days of the taxing" (Acts v, 37). By this statement, connected with the slight emendation of the text already indicated, Hales considers that "the Evangelist is critically reconciled with the varying accounts of Josephus, Justin Martyr, and Tertullian; and a historical difficulty satisfactorily solved, which has hitherto set criticism at defiance." This is perhaps saying too much, but the explanation is undoubtedly one of the best that has yet been given (Lardner's *Credibility*, i, 248-329; Wetstein, Kuinöl, and Campbell, on Luke ii, 2, etc.).—Kitto, s. v.

5. The preceding explanations all render *πρώτη*, "first," as an *adverb*, but it is clearly not susceptible of such a construction, being an *adjective* regularly qualifying *ἀπογραφὴν*, evidently for the purpose of distinguishing the present "taxing" from a subsequent one under the same authority, namely, that mentioned in the Acts. The writer of an elaborate article in the *Journal of Sacred Literature* (October, 1851) indeed urges that Luke ought to have said *ἡ ἀπογραφὴ ἢ πρώτη*, and adduces many citations to show the adverbial force of *πρώτος*; but these are inappropriate, for they would rather require the rendering "this was the first taxing that took place," etc., a sense equally difficult; and Luke's design does not appear to be to contrast so strongly the two taxings, since they were in a measure one, this the beginning, the other the completion. We are disposed, therefore, to adopt a modification of this last preceding explanation, and find the distinction between these two dates in the verb *ἐγένετο*, rendering it "effected" or "completed," the enrolment having only been *begun* in the present case. This will combine all the historical notices above cited, and obviate all the objections that have been raised to the explanations of this difficult text hitherto proposed. (See Strong's *Harmony and Exposition of the Gospels*, Append. i, p. 20.) There is the greater propriety in this solution, inasmuch as Luke himself not only elsewhere alludes to the later enforcement of the tax-roll in question, but in this very passage under discussion he clearly implies it by the use of *πρώτη*, *first*; the rendering of which as an adverb ("first occurred") makes the word itself either altogether negatory or positively inapposite, since no later census of the kind is recorded than that referred to in the Acts. There can be no good philological reason assigned for adding this distinctive term, except to throw greater stress upon *ἐγένετο*, which otherwise would not naturally bear so strong a sense as the *erection*, under the direction of Quirinus, of what had already been inaugurated (*πρώτη*) under different auspices (see Alford, *Gr. Test.* in loc.). The paren-

thetical character of the clause is probably the cause of this somewhat blended antithesis in its phraseology. We continue from Winer, s. v. Quirinus.

6. Many take *ἡγεμών* in the wider signification of *high executive officer* in general, including, for instance, the procurators. (So Casaubon, *Exercit. Antidaron*. p. 126 sq.; Grotius, B. Ch. Richard, in Iken, *Nov. Thesaur.* ii, 428 sq.; Magnani, *Probl. de Nativ. Christi*, p. 260 sq.; G. Wernsdorf, *De censu quem Cas. Oct. August. fecit*, Viteb. 1698, 1720; Deyling, *Observat.* i, 233 sq.; *Weihnachtsprog.* v. *Helmschl.* 1787; K. Nahmacher, *ut. sup.*; Volborth, *De censu Quirini*, Götting. 1785; Birch, *De censu Quirini*, Havn. 1790; Sanclemente, *De Vulg. Era Emend.* p. 413 sq.; Münter, *Stern d. Weisen*, p. 88 sq.; Neander, *Leben Jesu*, p. 25, and others.) These suppose that Quirinus held this census as an extraordinary magistrate, at the especial command of Augustus. (Comp. Usher, *Anal.* p. 580 sq.; Wedel, *De censu August.* Jena, 1703.) Münter, p. 99 sq., has shown, after others, that extraordinary legates, besides the chiefs of the provinces, were sometimes sent for such special duties, though perhaps not all the instances adduced by him are valid. If we are fully to believe Justin Martyr, *Apol.* i, 44, Quirinus must have held the census when he first became *ἐπιτροπος*, or procurator in Judæa. See Credner, *Beitrag. s. Einleit. ins N. T.* i, 280 sq. But there were no procurators in Judæa in Herod's time. We must then suppose, with Credner, that Quirinus was then sent to Palestine as procurator of Syria simply to take the census of the people, whose number Augustus wished to know. But this is simply multiplying hypotheses. Comp. also Huschke, p. 73 sq. This view appears the more probable, since Quirinus, who was a favorite with the emperor, was then in the East on his commission (*Tacit. Ann.* iii, 48; ii, 42). There is also an inscription (Muratori, *Theosour. Inscript.* i, p. 670) which states that Q. Emil. Palicanus Secundus, by order of Quirinus, held a census in Apamea (in Syria), and, likewise by his order, conquered the Ituraans in Lebnaan. But, though the word *ἡγεμών* is not limited to a permanent governor of a province, yet Luke could hardly use such a phrase as this (*ἡγεμονεύοντος τῆς Συρίας*) of an extraordinary officer. In common language this could only mean "being governor of Syria" (see besides, Huschke, p. 65 sq.). Just as little does Bengel hit the mark (*Ordo Temp.* p. 203) when he makes Quirinus to have filled, as governor, an interim between Saturninus and Varus.

7. Assuming, on the authority of Luke, that an enrolment actually did take place at the time of our Lord's birth, a modification of the last foregoing hypothesis proceeds to make out a probability that Cyrenius was then joint governor of Syria along with Saturninus. It is known that a few years previous to this date Volumnius had been joined with Saturninus as the procurator of that province, and the two, Saturninus and Volumnius, are repeatedly spoken of together by Josephus, who styles them equally governors of Syria (*Ant.* xvi, 9, 1; 9, 8). Josephus does not mention the recall of Volumnius; but there is certainly a possibility that this had taken place before the birth of Christ, and that Cyrenius, who had already distinguished himself, had been sent in his place. He would then have been under Saturninus, a *ἡγεμών*, "governor," of Syria, just as Volumnius had been before, and as Pilate was afterwards, of Judæa. That he should here be mentioned as such by Luke rather than Saturninus is very naturally accounted for by the fact that he returned, ten years afterwards, as procurator or chief governor, and then held a second and more important census for the purpose of registration and taxation, when Archelaus was deposed, and Judæa annexed to the Roman province of Syria. The only real objection to this solution is the silence of all other history. But, although profano history does not mention the fact of Cyrenius having formerly been pro-

curator of Syria, yet it does not in any way deny it, and we may therefore safely rest upon the authority of the sacred writer for the truth of this fact, just as we do for the fact of the existence of the first enrolment itself.—Kitto, s. v. See SYRIA.

A. W. Zumpt, of Berlin, in his *Commentatio de Syria Romanorum provincia a Cesare Augusto ad T. Vespasianum*, has recently shown it to be probable that Quirinus was twice governor of Syria. This he supposes by the following considerations: In B. C. 9 Senius Saturninus succeeded M. Titius in the province of Syria, and governed it three years. He was succeeded by T. Quintilius Varus (*Joseph. Ant.* xvii, 5, 2), who, as it appears, remained governor up to the end of B. C. 4. Thenceforward we lose sight of him till he is appointed to the command in Germany, in which he lost his life in A. D. 7. We also lose sight of the governors of Syria till the appointment of P. Sulpicius Quirinus in A. D. 6. Now, from the maxim acted on by Augustus (*Dion. Cass.* lii, 23), that none should hold an imperial province for less than three or more than five years, Varus cannot have been governor of Syria during the twelve years from B. C. 6 to A. D. 6. Who, then, were the missing governors? One of them has been found—L. Volusius Saturninus, whose name occurs as "legatus Syriæ" on a coin of Antioch, A. D. 4 or 5. But his proconsulate will not fill the whole time, and one or two governors must be supplied between Varus, ending B. C. 4, and Volusius, A. D. 4 or 5. Just in that interval falls the census of Luke ii, 2. Could Quirinus have been governor at any such time? From January to August, B. C. 12, he was consul. Soon after that he triumphed over the Homonadenses (*Tacit. Ann.* iii, 48). Now Zumpt applies the exhaustive process to the provinces which could by any possibility have been under Quirinus at this time, and eliminates from the inquiry Asia—Pontus and Bithynia—and Galatia. Cilicia only remains. But at this time, as he shows, that province had been reduced by successive diminutions, had been separated (*Dion. Cass.* liv, 4) from Cyprus, and—as is shown by the history of the misconduct of Piso soon afterwards, who was charged with having, as ex-governor of Syria, attempted a forcible repossession of the province (*Tacit. Ann.* iii, 12), because he had attacked Celeridæa, a part in Cilicia (ib. ii, 78–80), attached to the province of Syria. This Zumpt also confirms by the accounts in Tacitus (*Ann.* vi, 41; xii, 55) of the Cilicia, a seditious tribe of Cilicia Aspera, who on two occasions were repressed by troops sent by the governors of Syria. Quirinus then appears to have been governor of Syria at some time during this interval. But at what time? We find him in the East (*Tacit. Ann.* iii, 48) in connection with Cæsar's campaign against the Armenians; and this cannot have been during his well-known governorship of Syria, which began in A. D. 6; for Caius Cæsar died in A. D. 4. Zumpt, by arguments too long to be reproduced here, but very striking and satisfactory, fixes the time of his first governorship at from B. C. 4 to B. C. 1, when he was succeeded by M. Lollius.—Smith, s. v. This, however, still leaves a discrepancy of one or two years between his first appointment and Christ's birth, which cannot be brought down so late as B. C. 4. (See Lutheroth, *Recensement de Quirinus en Judee*, Par. 1865.) See CENSUS.

Cyria (*Κυρία*, "lady," 2 John, ver. 1, 5), a Greek term signifying *mistress*, and used as an honorary title of address to a female (so Epict. *Ench.* 40), as in English. But in 2 John it appears to be the proper name of the distinguished female to whom John directed his epistle (see Alford, *Gr. Test.* vol. v, proleg. p. 185 sq.). That *Cyria* was often a proper name of females among the Greeks there is no doubt (*Gruteri Inscript.* p. 1127). Others regard the associated term *ἐκλεκτή* ("elect") as a proper name, q. d. *Electa* (q. v.) and the word in question as a common title. See JOHN, EPISTLES OF.

Cyriacus, said to have been pope, and, according to Romish tradition, to have, for the sake of St. Ursula and her 11,000 maidens, forsaken the papal see to suffer martyrdom with them at Cologne (Aug. 8th). His existence is probably as mythical and fictitious as that of the 11,000 virgins. The church and college of St. Cyriac (formerly St. Dionysii), at Neuhausen, near Worms, claim to have possessed his relics since the beginning of the 9th century.

Cyriacus, patriarch of Constantinople at the end of the 6th century, and successor of John *Jejunator* after 595, took, like his predecessor, the title of *ἐπισκοπῶς οἰκουμένικος*, which he caused to be confirmed by council. The Romish bishop, Gregory the Great, opposed him at first without success, but by giving his support to the usurper Phocas he finally gained his aid, and Cyriacus had to renounce his title. He is said to have died of grief in 606.—Herzog, *Real-Encyclopædie*, iii, 221.

Cyril (Str.) (*Κύριλλος*), of Alexandria, was born in Alexandria towards the end of the 4th century, and was educated under his uncle Theophilus, bishop of that place. Theophilus died in 412, and Cyril was elected patriarch of Alexandria. One of his first steps, according to Socrates, was to plunder and shut up the churches of the Novatians (Socr. *Hist. Eccl.* vii, 7). He led on a furious mob, which drove out the Jews, who had enjoyed many privileges in the city for ages. His proceeding excited the anger of Orestes, the governor of the city, and made him henceforth the implacable opponent of the bishop. An attack was made on the governor in his chariot by a band of 500 monks; and one who severely wounded him having suffered death on the rack, Cyril, in his church, pronounced a eulogy over his body as that of a martyr (Socrates, .vii, c. 14). He is also charged with the murder of Hypatia, the celebrated daughter of the mathematician Theon; but his share in this atrocity was only indirect. See HYPATIA. The titles of *Doctor of the Incarnation* and *Champion of the Virgin* have been given to Cyril on account of his violent dispute with Nestorius. "The condemnation and deposition of Nestorius having been decreed by Pope Celestine, Cyril was appointed to execute the sentence, for which he presided at a council of sixty bishops at Ephesus. John, patriarch of Antioch, having a few days afterwards held a council of forty-one bishops, who supported Nestorius and excommunicated Cyril, the two parties appealed to the emperor Theodosius, who forthwith committed both Cyril and Nestorius to prison, where they remained for some time under rigorous treatment. Cyril, by the influence of Celestine, was at length liberated and restored (481) to the see of Alexandria, which he retained until his death, which occurred in 444" (*Engl. Cyclop.* s. v.). See NESTORIUS. Cyril's doctrinal writings are chiefly on topics connected with the controversies on the Trinity. The following are some of the principal treatises: *Thesaurus on the Trinity*, intended as a complete refutation of Arianism. In *Dialogues on the Incarnation*, in *Five Books against Nestorius*, and in an ample *Commentary on St. John's Gospel*, the same subject is continued. Ten books *against Julian* contain replies to that emperor's three books against the Gospels, which, if Cyril's quotations are faithful, were so weak and absurd as the answers. Seventeen books *On Worship in Spirit and Truth* show that all the Mosaic institutions were an allegory of the Gospel; "a proof," says Dr. Adam Clarke, "how Scripture may be tortured to say anything." Thirteen books on the *Pentateuch and the Prophets* are written with a similar view. Thirty paschal *Homilies* announce, as customary at Alexandria, the time of Easter. Sixty-one *Epistles* nearly all relate to the Nestorian controversy. Cyril's *Synodical Letter* contains twelve solemn curses against Nestorius, who as solemnly replied with twelve curses against Cyril. His writings abound in tergite

praises of Mary, though he did not hold her to be without sin. "The history of none among the Christian fathers is more disgraceful to the Christian character than that of St. Cyril of Alexandria—a man immoderately ambitious, violent, and headstrong; a breeder of disturbances; haughty, imperious, and as unfit for a bishop as a violent, bigoted, and unskilful theologian could possibly be—but resolved that if the meek inherit the earth, the violent should have possession of the sees" (Clarke, *Succession of Sacred Literature*, ii, 137). "But the faults of his personal character should not blind us to the merits of Cyril as a theologian. He was a man of vigorous and acute mind, and extensive learning, and is clearly to be reckoned among the most important dogmatic and polemic divines of the Greek Church. Of his contemporaries Theodoret alone was his superior. He was the last considerable representative of the Alexandrian theology and the Alexandrian Church, which, however, was already beginning to degenerate and stiffen; and thus he offsets Theodoret, who is the most learned representative of the Antiochian school. He aimed to be the same to the doctrine of the incarnation and the person of Christ that his purer and greater predecessor in the see of Alexandria had been to the doctrine of the Trinity a century before. But he overstrained the supernaturalism and mysticism of the Alexandrian theology, and in his zeal for the reality of the incarnation and the unity of the person of Christ he went to the brink of the Monophysite error, even sustaining himself by the words of Athanasius, though not by his spirit, because the Nicene age had not yet fixed beyond all interchange the theological distinction between *ὁμοία* and *ὁμοούσιος*" (Schaff, *Church History*, § 171). The best edition of the *Opera Omnia* of Cyril, in Greek and Latin (Paris, 1638), is that of Aubert (7 vols. fol.). This edition is followed by Migne, in his *Patrol. Coursus Completus* (lxxviii-lxxvii). His *Comm. in Luca Evangelium* was re-edited in Latin by R. P. Smith (Oxford, 1856); and in an English version, by the same, with notes (Oxf. 1859). See Clarke, *Succession Sac. Lit.* ii, 187; Cave, *Hist. Lit.* Anno 412; Tillemont, *Mémoires*, xiv, 272; Butler, *Lives of Saints*, Jan. 28; Neander, *Church History*, ii, 458-498; Lardner, *Works*, vol. iv; Dorner, *Person of Christ* (Edinb. trans.), div. i, vol. ii.

Cyril (Str.) (*Κύριλλος*), of Jerusalem, is supposed to have been born in that city about A.D. 815. He was ordained deacon by Macarius about 885, and priest by the patriarch Maximus about 845. On the death of Maximus, Cyril was chosen to succeed him (A.D. 850). A luminous appearance in the heavens, called the "Apparition of the Cross," is said to have marked the beginning of his episcopate (Socrates, *Hist. Eccl.* ii, 28). He soon became involved in disputes with the Arian Acacius, bishop of Cæsarea, who commenced a persecution against him, which terminated in his deposition by a council in 857. He was restored to his see, but was deposed a second time by the Arian Council of Constantinople in 860. On the accession of Julian, Cyril returned to his bishopric, but was expelled a third time (A.D. 867). Finally, under Theodosius, he was restored by the Council of Constantinople in 881, and died, cleared of all charges against his orthodoxy, May, 886. "An incident noticed by all the biographers of St. Cyril is the celebrated attempt and failure of the emperor Julian to rebuild the temple of the Jews at Jerusalem, ostensibly for the purpose of promoting their religion, but really with the sinister view of falsifying the prophecies respecting its irreparable destruction" (see Gregory Nazian. *Orat. 4 advers. Julian*; Theodoret, Socrates, Philostorgius, Sozomen, and bishop Warburton's *Dissertation* on the subject, p. 88).

"The extant writings of St. Cyril are in the Greek language, and consist of eighteen books of *Catecheses*, or sermons, delivered during Lent to the catechumens (called before baptism *Iluminati*); five similar dis-

courses delivered during Easter week to the neophytes after baptism, called *Mystagogic*, being explanatory of the mysteries of the Christian sacraments; a treatise on words, and the letter to Constantius, besides which several homilies and epistles are sometimes improperly included. Rivetus (lib. iii, c. 8, 9, 10, *De Cyrilli Catechesibus*) considers the five *Mystagogics* and the letter to Constantius as supposititious; but by Vossius, Cave, Mill, Whittaker, and bishop Bull, they are received as genuine. The books of Catecheses are crowded with quotations from Scripture, and the style is dull and tiresomely prolix; but the facts they contain relating to the doctrines and discipline of the Eastern Church in the 4th century are extremely interesting to the student of Christian antiquities. In the first Catechesis are described the effects of baptism. The fourth gives an exposition of all the Christian doctrines, and treats of numerous questions concerning the body, soul, virginity, marriage, etc. The subsequent discourses exhibit and enjoin a belief in the miraculous virtues of the relics of saints, which are represented as worthy of all veneration; in the efficacy of prayers and sacrifices for the dead; in the powers of exorcism, consecrated unction, oil, and water. Christians are exhorted to cross themselves on every occasion and action throughout the day. The enthusiastic adoration of the cross displayed by St. Cyril was probably owing to his officiating in the church of the Holy Cross in Jerusalem, where, after the 'Invention of the Cross,' it was deposited in a silver case, and shown by the archbishop to thousands of pilgrims, who each took a little chip of it without occasioning any diminution of its bulk! A description of this cross is given by Touttée at the end of his edition of Cyril's works. His chief theological work is the above-named *Κατηχήσεις φωτιστικαί*, Catecheses, delivered in preparing a class of catechumens for baptism, and it is the first example we have of a popular compend of Christian doctrine. The perpetual virginity of Mary is taught by Cyril. The state of virginity in general is extolled as equal to that of angels, with an assurance that, in the day of judgment, the noblest crowns will be carried off by the virgins. The resurrection is proved and illustrated by the story of the Phoenix" (*English Cyclopædia*). The best editions of his works are, Mille, *Opera Omnia*, Grace et Latine (fol., 1708, with notes, indices, and various readings); Touttée (Benedictine, Gr. et Lat., Paris, fol., 1720); also in Migne, *Patrologia Curs. Græc.* vol. xxxiii. The Catecheses are given in English in the *Library of the Fathers* (vol. ii), Oxford, 1889, 8vo.—See Clarke, *Succession Sac. Liter.* i, 279; Lardner, *Works*, iv; Neander, *Church History*, ii, 98; Cave, *Hist. Lit.* i, 211; Taylor, *Ancient Christianity*; Schaff, *Hist. of the Christian Church*, § 168.

Cyril, St., the apostle of the Slavi, was born in Thessalonica about 820. His original name was Constantine. He was educated at Constantinople, where he became acquainted with Photius, and gave for some time lectures on philosophy. He therefore received and always retained the name "The Philosopher." After some time he took orders, became a monk, and soon, with his brother Methodius, withdrew into solitude. He now fell out with Photius, defended the veneration of images, and wrote against the Mohammedans. About 860 he was sent by the emperor Michael III as a missionary to a Tartar tribe, the Chazari, which at that time inhabited the northern shores of the Black Sea as far as the Lower Volga. Jews and Mohammedans vied with Christian missionaries to gain an influence upon this tribe, and the selection of Constantine by the emperor for this difficult mission indicates the high reputation which he enjoyed. He first went to Kherson, acquired a knowledge of the language, and put himself in possession of some relics of Clemens Romanus, which he seems to have always carried with him from this time.

A portion of the tribe embraced Christianity, but there is no proof of a Christianization of the whole tribe and of the organization of a national Church. After his return to Constantinople he again lived with his brother Methodius in ascetic retirement until he was sent by the emperor as a missionary to the South Slavic tribes. Both Greek and Roman missionaries had for some time been at work among this people, which, anxious to preserve its independent nationality, mistrusted both. Constantine gained their confidence by convincing them that he sympathized with their national sentiments, and had in view nothing but their conversion to Christianity. He became the founder of a Slavic literature by translating into their language portions of the Scriptures and the most important liturgical books. For this purpose he used an alphabet which either had been invented by him or modified from one (the "Glagolitic") more ancient. The new alphabet, called after him the "Cyrillic," was adopted by most of the Eastern Slavi (Bulgarians, Servians, Bosnians, Slavonians, Russians, etc.) but subsequently underwent in the several countries a number of modifications. By prince Rastislav he was called as a missionary into the Slavic countries outside of the Greek empire. This Rastislav is probably the same whom the Germans call Rastice, the founder of a great Moravian empire whose exact limits cannot at present be defined. About 863 they arrived at the court of Rastislav, the seat of which we do not know, but which was probably at a point far to the south-east from the present Moravia. By disseminating the Scriptures and celebrating divine worship in the Slavic language, they soon founded a flourishing Slavic Church in the territory of Rastislav and other Pannonian princes. When pope Nicholas I heard of their successes he invited them to Rome. In 868 they followed this invitation, accompanied by many disciples. Their Slavic Bible and Slavic mass attracted great attention, and the successor of Nicholas (who in the meanwhile had died), Adrian II, received them with marks of great favor. They presented the pope with the relics of Clemens Romanus, and the pope approved their work, inclusive of the Slavic translation of the Bible and the Slavic liturgy, and declared his intention to organize the new churches in the Slavic provinces as an independent ecclesiastical province, under Constantine and Methodius as bishops. But Constantine, who felt the end of his life approaching, preferred to remain as a monk in Rome, assumed the name of Cyril, under which he has since been known in Church history, and died a few weeks later, Feb. 14, 869. The work of evangelization was continued by his brother Methodius. The works which were formerly ascribed to Cyril (*Apologi Morales*, Vienna, 1630; *Opusculum de Dictione*, Venice, 1497) are spurious.—Herzog, *Real-Encyclop.* iii, 223; Schafarik, *Slav. Alterthümer*, ii, 47; Wattenbach, *Beiträge zur Geschichte der christl. Kirche in Mähren u. Böhmen* (Vienna, 1849); *Acta Sanctorum*, Mart. ii, 14; Dobrowsky, *Cyrill und Method* (Prague, 1828); Philaret (Russian bishop of Riga), *Cyrillus und Methodius* (German transl., Mittau, 1847); McLeer, *Missions in the Middle Ages*, chap. xiii.

Cyril Lucar (CYRILLUS LUCARIS), a Greek patriarch of Constantinople, noted for his efforts to introduce into his Church the doctrines of the Reformed (Calvinistic) churches. He was born about 1568 in Candia, which at that time was under the sovereignty of Venice and the chief seat of Greek scholarship. He studied for several years in Venice and Padua, and subsequently made a journey through several European countries. In Geneva, where he staid for some time, he became acquainted with several prominent theologians of the Reformed Church. In Lithuania he was rector of a literary institution at Ostrog, and took a prominent part in opposing the projected union of the Greek

urches of Poland and Lithuania with Rome. After his return to his native land, he was soon promoted to the patriarch of Alexandria to the dignity of an archimandrite. In 1602 Cyril succeeded Meletius as patriarch of Alexandria. While holding this position he carried on an active correspondence with David le eu, de Wielm, and the Remonstrant Uytendogaert of Holland, Abbot, archbishop of Canterbury, Leger, professor of Geneva, the republic of Venice, the Swedish king Gustavus Adolphus, and his chancellor, Axel Oxenstierna. Many of these letters, written in different languages, are still extant. They show that Cyril was an earnest opponent of Rome, and a great admirer of the Protestant Reformation. He sent for all the important works, Protestant and Roman Catholic, published in the Western countries, and sent several young men to England to get a thorough theological education. The friends of Cyril in Constantinople, and among them the English, Dutch, and Swedish ambassadors, endeavored to elevate Cyril to the patriarchal see of Constantinople. They would have succeeded in 1613, after the banishment of the patriarch Timotheus, but for the unwillingness of Cyril to pay the amount demanded by the Turkish government. After the death of Timotheus in 1621, he was elected his successor by a unanimous vote of the synod. His life as patriarch was full of vicissitudes. The Jesuits, in union with the agents of France, several times procured his banishment, while his friends, supported by the ambassadors of the Protestant powers in Constantinople, obtained, by means of large sums of money, his recall. During all these troubles, Cyril, with remarkable energy, pursued the great task of his life. In 1627 he obtained a printing-press from England, and at once began to print his Confession of Faith and several catechisms. But, before these documents were ready for publication, the printing establishment was destroyed by the Turkish government at the instigation of the Jesuits. Cyril then sent his Confession of Faith to Geneva, where it appeared, in 1629, in the Latin language, under the true name of the author, and with a dedication to Cornelius de Haga. It created throughout Europe a profound sensation, and many were inclined to regard it as spurious. Cyril, however, openly confessed the authorship, published in 1633 a Greek edition of the Confession, and in 1636, in a letter to the professors of Geneva, declared his concurrence in the principal doctrines of the Reformed Church. Many opponents, however, now rose against him in the Greek Church, and in 1638 a synod convened at Constantinople to try him. But, before sentence was pronounced, the Janissaries arrested him by order of the government, carried him to a boat, strangled him, and cast the corpse into the sea. Some friends found the corpse and buried it upon an island, and ten years later a solemn funeral was held at Constantinople. Several synods condemned the innovations attempted by Cyril, but the Confession of Faith was generally treated by them as spurious.

The Confession of Cyril uses of the procession of the Holy Spirit the compromising formula *ἐκ τοῦ πατρὸς ὁ υἱὸς* (*a pater per filium*). It teaches absolute predestination, denies moral freedom prior to regeneration, declares strongly against the rights claimed by the popes, and acknowledges only two sacraments, baptism and the Lord's Supper. It recommends the reading of the Bible, distinguishes the canonical from the deuterocanonical books, and rejects the veneration of images. It has been published by Kimmel in his *Libri symbol. eccles. Græca*.—Thom. Smith, *Collectanea de Cyrillo Lucari* (Lond. 1707); Bohnstedt, *De Cyrillo Lucari* (Halle, 1724); Herzog, *Real-Encyclop.* viii, 588; Pichler, *Geschichte des Protestantismus in der Orientalischen Kirche*, etc. (Munich, 1862, 8vo); Stanley, *Eastern Church*; Princeton Review, v, 312; Murdoch's Mosheim, *Church History*, iii, 847, note 5 (N. Y. 1864).

Cy'rus (Hebraized *Ko'resh*, כִּיּוֹשׁ [twice כִּיּוֹשׁ, Ezra i, 1 lat. clause, 2], 2 Chron. xxxvi, 22, 23; Ezra i, 1, 7, 8; iii, 7; iv, 3, 5; Isa. xlv, 28; xlv, 1; Dan. i, 21; x, 1; Chald. id. Ezra v, 13, 14, 17; vi, 3, 14; Dan. vi, 28; Greek Κύρος, as in 1 Esdr. ii, 3; iv, 44, 57; v, 71, 73; vi, 17, 21; for the old Persic *Kurush*, supposed by the Greeks to mean the sun [Ctesias, *Pers. Exc.* 49; Plutarch, *Artax. I.*], but rather connected with the Sanscrit *Kuru*, of unknown signifi., Rawlinson, *Herod.* iii, 455), originally called *Agradates* (Ἀγαδάτης, Strabo, xv, 729; see Rosenmüller, *Alterth.* I, i, 367), the celebrated Persian king (כִּיּוֹשׁ מֶלֶךְ) and conqueror of Babylon, who promulgated the first edict for the restoration of the Jews to their own land (Ezra i, 1, etc.). "In consequence of a dream, Astyages, it is said, designed the death of his infant grand-



Symbolical Figure of Cyrus (from the Persepolitan Monuments), and his Name in cuneiform Characters.

son, but the child was spared by those whom he charged with the commission of the crime (Herod. i, 109 sq.), and Cyrus grew up in obscurity under the name of Agradates (Strab. xv, 729). His real parentage was discovered by the imperious spirit which he displayed while yet a boy (Herod. i, 114), and when he grew up to manhood his courage and genius placed him at the head of the Persians. The tyranny of Astyages had at that time alienated a large faction of the Medes, and Cyrus headed a revolt which ended in the defeat and capture of the Median king, B.C. 559, near Pasargade (now Murgh-Aub) (Strabo, xv, 730). After consolidating the empire which he thus gained, Cyrus entered on that career of conquest which has made him the hero of the East. In B.C. 546 (?) he defeated Croesus, and the kingdom of Lydia was the prize of his success. While his general Harpagus was engaged in completing the reduction of Asia Minor, Cyrus turned his arms against the Babylonians. Babylon fell before his army, and the ancient dominions of Assyria were added to his empire (B.C. 538). The conquest of Babylon opened the way for greater designs. It is probable that Cyrus planned an invasion of Egypt; and there are traces of campaigns in Central Asia, in which he appears to have attempted to extend his power to the Indus (Ctesias, *Pers.* c. 5 sq.). Afterwards he attacked the Massagetae, and, according to Herodotus, (i, 214; comp. Josephus, *Ant.* xi, 2, 1), he fell in a battle against them B.C. 529 (Clinton, *Fast. Hell.* ii, 801 sq.). His tomb is still shown at

Pasargadæ (Arrian, *Exp. Al. vi*, 29), the scene of his first decisive victory (Rawlinson, *Herod. i*, 278).

"It is impossible to insist upon the details of the outline thus sketched. In the time of Herodotus Cyrus was already regarded as the national hero of Persia, and his history had received various popular embellishments (Herod. *i*, 95; comp. *iii*, 18, 160; Xenoph. *Cyrop. i*, 2, 1). In the next century Xenophon chose him as the hero of his romance, and fact and fiction became thenceforth hopelessly confused in classical writers. But, in the absence of authentic details of his actions, the empire which he left is the best record of his power and plans. Like an Oriental Alexander, he aimed at universal dominion; and the influence of Persia, like that of Greece, survived the dynasty from which it sprang. In every aspect the reign of Cyrus marks an epoch in universal history. The fall of Sardis and Babylon was the starting-point of European life; and it is a singular coincidence that the beginning of Grecian art and philosophy, and the foundation of the Roman constitution, synchronize with the triumph of the Arian race in the East (Niebuhr, *Gesch. Ass. p.* 232)."—(Smith, *s. v.*) The following points demand especial consideration (our statements on which are chiefly drawn from Kitto and Smith):

1. *His Parentage.*—Herodotus (*i*, 107) and Xenophon (*Cyrop. i*, 2, 1) agree that he was son of Cambyses, prince of Persia, and of Mandane, daughter of Astyages, king of the Median empire. In an Assyrian inscription he is called the "son of Cambyses the powerful king" (Rawlinson, *Herod. i*, 193). Ctesias denies that there was any relationship at all between Cyrus and Astyages (*Pers. Exc.* 2). According to him, when Cyrus had defeated and captured Astyages, he adopted him as a grandfather, and invested Amytis, or Amyntis, the daughter of Astyages (whose name is in all probability only another form of Mandane), with all the honors of queen dowager. His object in so doing was to facilitate the submission of the more distant parts of the empire, which were not yet conquered; and he reaped excellent fruit of his policy in winning the homage of the ancient, rich, and remote province of Bactria. Ctesias adds that Cyrus afterwards married Amytis. It is easy to see that the latter account is by far the more historical, and that the story followed by Herodotus and Xenophon is that which the courtiers published in aid of the Persian prince's designs. Yet there is no reason for doubting that, on the father's side, Cyrus belonged to the Achæmenidæ, the royal clan of the military tribe of the Persians. See SARTORIUS, *De rationib. cur in expon. vita et rel. gest. Cyri, Xenophonis potius quam Herodot. sit credendum* (Lübber, 1771). A different view is taken in Smith's *Dict. of Class. Biog. s. v.* See DARIUS (THE MEDE).

2. *His Elevation to the Throne.*—It was the frequent practice of the Persian monarchs, and probably therefore of the Medes before them, to choose the provincial viceroys from the royal families of the subject nations, and thereby to leave to the vanquished much both of the semblance and of the reality of freedom. This will be sufficient to account for the first steps of Cyrus towards eminence. But as the Persian armies were at that time composed of ruder and braver men than the Medes (indeed, to this day, the men of Shirâz are proverbially braver than those of Isfahân), the account of Xenophon is credible, that in the general wars of the empire Cyrus won the attachment of the whole army by his bravery; while, as Herodotus tells, the atrocious cruelties of Astyages may have revolted the hearts of the Median nobility. See PERSIA.

3. *Transition of the Empire from the Medes to the Persians.*—Xenophon's romance omits the fact that the transference of the empire was effected by a civil war; nevertheless, the same writer, in his *Anabasis*, confesses it (*iii*, 4, 7, 12). Herodotus, Ctesias, Isocrates, Strabo, and, in fact, all who allude to the matter * all, agree that it was so. In Xenophon (*l. c.*) we

find the Upper Tigris to have been the seat of a campaign, where the cities of Larissa and Mespæ were besieged and taken by Cyrus. From Strabo we learn that the decisive battle was fought on the spot where Cyrus afterwards built Pasargadæ, in Persia for his native capital. This agrees with Herodotus' account of two armies being successively lost, which may mean that the war was ended in two campaigns. Yet Ctesias represents Astyages as finally captured in the palace of Ecbatana. Cyrus (says Herodotus) & Astyages no harm, but kept him by his side to the end of his life. Ctesias, however, states that he was first made ruler of the Barcaniana, and afterwards murdered by a eunuch sent by Cyrus to bring him home to visit his family. The date of the accession of Cyrus is fixed by the unanimous consent of the ancient chronologists as occurring in B.C. 559 (Africanus, *p. Euseb. x*, 10; Clinton, *ii*, *s. an.*).

The Medes were by no means made subject to the Persians at first. It is highly probable that, as Herodotus and Xenophon represent, many of the nobles Medes sided with Cyrus, and during his reign the most trusted generals of the armies were Medes. Yet even this hardly explains the phenomenon of a Darius the Mede, who, in the book of Daniel, for two years held the government in Babylon, after the capture of the city by the Medes and Persians. Indeed, the language used concerning the kingdom of Darius might be explained as Oriental hyperbole, and Darius be supposed to have been a mere satrap of Babylon, were it not for the fact that Cyrus is clearly put forward as a successor to Darius the Mede. Many have been the attempts to reconcile this with the current Grecian accounts; but there is one only that has the least plausibility, viz. that which, with Xenophon, teaches that Astyages had a son still living (whom Xenophon calls Cyaxares), and that this son is no other than Darius the Mede; to whom Cyrus, by a sort of nephew's piety, conceded a nominal supremacy at Babylon. See CYAXARES. In the reign of the son of Cyrus the depression of the Medes probably commenced. At his death the Magian conspiracy took place, after the defeat of which the Medes doubtless sunk lower still. At a later time they made a general insurrection against the Persian power, and its suppression seems to have brought them to a level with Hyrcanians, Bactrians, and other vassal nations which spoke the tongue of Persia; for the nations of the poetical *Irân* had only dialectal variations of language (Strabo, *xv*, 2, *p.* 811). See MEDIA.

4. *Military Career of Cyrus.*—The descriptions given us in Ctesias, and in Plutarch's *Artaxerxes* (the latter probably taken from Ctesias), concerning the Persian mode of fighting, are quite *Homeric* in their character. No skill seems to be needed by the general; no tactics are thought of: he does his duty best by behaving as the bravest of common soldiers, and by acting the part of champion, like a knight in the days of chivalry. We cannot suppose that there was any greater advance of the military art in the days of Cyrus. It is agreed by all that he subdued the Lydians, the Greeks of Asia Minor, and the Babylonians: we may doubtless add Susiana, which must have been incorporated with his empire before he commenced his war with Babylon; where also he fixed his military capital (Susa, or Shushan), as more central for the necessities of his administration than Pasargadæ. Yet the latter city continued to be the more sacred and beloved home of the Persian court, the place of coronation and of sepulture (Strabo, *xv*, 3, *p.* 318; and Plut. *Artax. int.*). All Syria and Phœnicia appear to have come over to Cyrus peaceably.

With regard to the Persian wars, the few facts from Ctesias, which the epitomator has extracted as differing from Herodotus, carry with them high probability. He states that, after receiving the submission of the Bactrians, Cyrus made war on the Sactians, a Scythian

a. a Slavonic) people, who seem to have dwelt, or haps rather roved, along the Oxus, from Bokhara Khiva; and that, after alternate successes in battle, attached the whole nation to himself in faithful alliance. Their king is called Amorges by Ctesias. ey are undoubtedly the same people that Herodotus i, 64) calls *Amyrgian Scians*; and it is highly probable that they gave to the district of Margiana its name. eir women fought in ranks as systematically as the n. Strabo has cursorily told us of a tradition (xv, p. 307) that Cyrus escaped with but seven men rough the deserts of Gedrosia, fleeing from the "Inans"—which might denote an unsuccessful war ainst Candahar, etc., a country which certainly was t reduced to the Persian empire until the reign of arius Hystaspis.

The closing scene of the career of Cyrus was in bate with a people living on one or both banks of the ver Iaxartes, now the Syr-deria. Herodotus calls e enemy the Massagetans, who roamed along the orth bank of the river: according to Ctesias it was e Derbices, who seem to have been on the south. oth may, in fact, have combined in the war. In her respects the narrative of Ctesias is beyond comparison more credible, and more agreeable with other own facts, except that he introduces the fiction of ndians with elephants aiding the enemy. Two battles ere fought on successive days, in the former of which yrus was mortally wounded, but was carried off by is people (B.C. 529, according to Clinton). In the ext, the Scian cavalry and the faithful Amorges ame to support him, and the Derbices sustained a tal and bloody defeat. Cyrus died the third day after is wound: his body was conveyed to Pasargade, and ured in the celebrated monument, which was broken pen by the Macedonians two centuries afterwards (Strabo, xv, 3). A description is given of the tomb in Arrian (vi, 29): it was a neat quadrangular edifice, with a low door leading into a little chamber, in which lay a golden sarcophagus, containing the body of Cyrus. The inscription, reported by Aristobulus, an eyewitness, is this: "O man, I am Cyrus, who acquired the empire for the Persians, and was king of Asia. Grudge me not, then, this monument." It is generally supposed to have perished, but Sir R. K. Porter has sought to identify it with an extant building known by the natives as that of "the mother of Suleiman" (*Travels*, i, 498). His name is found on monuments at Marghab, north of Persepolis (Höck, *Vet. Med. N. Pers. Monum.*).

Messiah); and the title seemed to later writers to invest him with the dignity of being in some sense a type of Christ himself (Jerome, *Comm. in Isa.* xlv, 1). His successes are connected in the prophecy with their religious issue; and if that appear to be a partial view of history which represents the restoration of a poor remnant of captive Israelites to their own land as the final cause of his victories (Isa. xlv, 28-xlv, 4), it may be answered that the permanent effects which Persia has wrought upon the world can be better traced through the Jewish people than through any other channel. The laws, the literature, the religion, the very ruins of the material grandeur of Persia have passed away, and still it is possible to distinguish the effects which they produced in preparing the Jews for the fulfilment of their last mission. In this respect, also, the parallel, which has already been hinted, holds good. Cyrus stands out clearly as the representative of the East, as Alexander afterwards of the West. The one led to the development of the idea of order, and the other to that of independence. Ecclesiastically the first crisis was signalized by the consolidation of a Church, the second by the distinction of sects. The one found its outward embodiment in "the great synagogue," the other in the dynasty of the Asmonæans.

The kings of Assyria and Babylon had carried the Jews into captivity, both to remove a disaffected nation from the frontier, and to people their new cities. By undoing this work, Cyrus attached the Jews to himself as a garrison at an important post. But we may believe that a nobler motive conspired with this. The Persian religion was primitively monotheistic, and strikingly free from idolatry; so little *pagans* in its spirit that, whatever of the mystical and obscure it may contain, not a single impure, cruel, or otherwise immoral practice was united to any of its ceremonies. It is credible, therefore, that a sincere admiration of the Jewish faith actuated the noble Persian when he exclaimed, in the words of the book of Ezra, "Go ye up and build in Jerusalem the house of Jehovah, God of Israel; *he is God!*"—and forced the Babylonian temples to disgorge their ill-gotten spoil. It is the more remarkable, since the Persians disapproved the confinement of temples. Nevertheless, impediments to the fortification of Jerusalem afterwards arose, even during the reign of Cyrus (Ezra iv, 5). See CAPTIVITY.

Perhaps no great conqueror ever left behind him a fairer fame than Cyrus the Great. His mighty achievements have been borne down to us on the voice of the nation which he elevated; his evil deeds had no historian to record them. What is more, it was his singular honor and privilege to be the first Gentile friend to the people of Jehovah in the time of their sorest trouble, and to restore them to the land whence light was to break forth for the illumination of all nations. To this high duty he is called *by name* by the prophet (Isa. xlv, 28; xlv, 1), and for performing it he seems to be entitled "the righteous



Supposed Tomb of Cyrus.

5. *Conduct and Relations of Cyrus towards the Jews.*—Hitherto the great kings, with whom the Jews had been brought into contact, had been open oppressors or seductive allies; but Cyrus was a generous liberator and a just guardian of their rights. An inspired prophet (Isa. xlv, 28) recognised in him "a shepherd of the Lord, an "anointed" king (Isa. xlv, 1; מָשִׁיחַ,

man" (xli, 2; xlv, 18). There are also important passages in Jeremiah (xxv, 12; xxxix, 10; xxxiii, 7-18) that predict the same event, without mentioning the name of Cyrus as the agent. The corresponding history is found in the books of Daniel and Ezra. The language of the proclamation in Ezra i, 2, and 2 Chron. xxxvi, 22, seems to countenance the idea that he was

that enter into men and kill them, unless they can obtain some help against them;" and he speaks of their exorcism by fumigation (as in Tob. viii, 2, 8). See also *Ant.* vi, c. 8, 2; viii, c. 5. Writing as he did with a constant view to the Gentiles, it is not likely that he would use the word in the other sense, as applied to heathen divinities.

By Philo the word appears to be used in a more general sense, as equivalent to "angels," and referring to both good and evil. See GLANT.

III. *The New-Testament writers* always use the word in a bad sense when they speak as from themselves. In the Gospels generally, in James ii, 19, and in Rev. xvi, 14, the dæmons are spoken of as spiritual beings at enmity with God, and having power to afflict man not only with disease, but, as is marked by the frequent epithet "unclean," with spiritual pollution also. In Acts xix, 12, 13, etc., they are exactly defined as "evil spirits" (*τὰ πνεύματα τὰ ἁκαθάρτα*). They "believe" the power of God "and tremble" (James ii, 19); they recognise our Lord as the Son of God (Matt. viii, 29; Luke iv, 41), and acknowledge the power of his name, used in exorcism, in the place of the name of Jehovah, by his appointed messengers (Acts xix, 15); and look forward in terror to the judgment to come (Matt. viii, 29). The description is precisely that of a nature akin to the angelic (see ANGEL) in knowledge and powers, but with the emphatic addition of the idea of positive and active wickedness. Nothing is said either to support or to contradict the common Jewish belief, that in their ranks might be numbered the spirits of the wicked dead. In support of it are often quoted the fact that the dæmoniacs sometimes haunted the tombs of the dead (Matt. viii, 28), and the supposed reference of the epithet *ἀκάθαρτα*, "unclean," to the ceremonial uncleanness of a dead body. In 1 Cor. x, 20, 21; 1 Tim. iv, 1; and Rev. ix, 20, the word *δαίμονια* is used of the objects of Gentile worship, and in the first passage it is opposed to the word *θεοί* (with a reference to Deut. xxxii, 17). So also is it used by the Athenians in Acts xvii, 18. The same identification of the heathen deities with the evil spirits is found in the description of the damsel having "a spirit of divination" (*πνεῦμα πύθωνα, or πύθωνος*) at Philippi, and the exorcism of her as a dæmoniac by Paul (Acts xvi, 16); and it is to be noticed that in 1 Cor. x, 19, 20, the apostle is arguing with those who declared an idol to be a pure nullity, and while he accepts the truth that it is so, he yet declares that all which is offered to it is offered to a "dæmon." See PYTHONES. Indeed, it has been contended that evidence is found in the Old Test. to show that dæmons who had once been souls of men were the objects of immediate worship among the heathens (Deut. xxvi, 14; Psa. cvi, 28; Isa. viii, 19), and it is in contradistinction to these that Jehovah is so frequently called "the living God" (Deut. v, 6, etc. etc.; see Farmer's *Essay on the Dæmoniacs*, passim). More particularly,

1. As to their nature, dæmons are *πνεύματα*, or spirits (comp. Matt. viii, 16; x, 1; xii, 43-45; Mark ix, 20; Luke x, 20, etc.). Hence there is ascribed to them intelligence and will (Mark i, 24; Luke iv, 34; James ii, 19; iii, 14), as well as great power (Matt. viii, 28-32; Mark ix, 26; Eph. vi, 12). Whether they are to be reckoned as belonging to the class, and as fallen from the original condition of the angels, does not clearly appear from any statement of Scripture. As the messengers and agents of Satan (q. v.), they may be either the one or the other; but the probability seems to be that they belong to the same class as himself (see Doddridge, *Family Expositor*, i, 83, London, 1799; Campbell, *Prælim. Dissert.* p. 190). He is called the Prince of the Dæmons; the dæmons whom our Lord cast out are collectively called Satan (Matt. xii, 24-29; Luke xiii, 16); and the phrase "unclean spirits," which is applied to them (Matt. x, 1; Mark iii, 11; vi, 7, etc.), is applied also to fallen angels (Rev.

xvi, 18; xviii, 2), and even in the singular to Satan himself (Mark iii, 30; comp. 22). These considerations, we think, render it probable that the *δαίμονια* of the N. T. belong to the number of those angels "who kept not their first estate;" and we conclude probably (though attempts have been made to deny the inference) that they must be the same as "the angels of the devil" (Matt. xxv, 41; Rev. xii, 7, 9), "the principalities and powers" against whom we "wrest" (Eph. vi, 12, etc.).

2. As to character, dæmons are described as *ἀκαθάρτα* (*ἁκαθάρτα*) (Matt. xii, 45; x, 1, etc.), as belonging to the kingdom of darkness, and used by Satan for his wicked designs (Matt. ix, 34; xxv, 41; Eph. vi, 12).

3. As to their abode, they are represented as "served in everlasting chains under darkness unto the judgment of the great day" (Jude 6; comp. 2 Pet. i, 4). They are said also to be in the abyss (Luke vi, 81; comp. Rev. ix, 1-11). See ABYSS. Such descriptions, however, can be understood as intimating nothing more than their being in a state of punishment and under control; for the activity which is ascribed to them is incompatible with the idea of their being in a state of confinement; and, besides, such passages as Eph. ii, 2; vi, 12, would lead to the conclusion that a sphere of extended physical freedom is assigned to these fallen spirits.

III. *The fathers* frequently refer to dæmons in their writings. By some they are represented as angels, who, originally created holy, fell into rebellion as sin (Joan. Damasc. *Expos. Fidei*, ii, 4), while others represent them as the fruit of the intercourse of angels with women (Justin M. *Apol.* ii, 5), and others that they are the souls of the giants whom the daughters of men bore to devils (*Pseudo-Clementin.* viii, 18). They also teach that they are *δαίμονια*, yet not in such a sense as to be absolutely impassable, but as *εὐαίερα* (Clem. Alex. p. 791; comp. Chrysostom, *Hom.* cxxv. Theodoret, in *Jes.* xliii). They all describe them as evil, as deceiving and destroying men, as being the object of worship to the heathen, and as employed by God to punish the wicked (Origen, *Cont. Cels.* v, 34; viii, p. 399, etc.). See the passages collected in Sicer, *Theol.* s. v. *δαίμων*, and in Usteri, *Patrist. Bibliotheca* (Anh. iii, p. 421 sq., 5th ed.); comp. also the whole subject Winzer, *de Dæmonologia in N. T. libri* (Vitæ, et Lips. 1812-22); Lindinger, *de Hebræor. or. med. de Dæmone* (Wittenb. 1774); Pisanski, *Belichtung der sogenannten biblisch. Dæmonologie* (Danz. 1778); Schmid, *De lapsu dæmonum* (Wittenberg, 1775). See DÆMONIAC.

Dæmoniac (*δαίμονιζόμενος*, rendered "possessed with a devil;" also *δαίμονα ἔχων*), a term (in the Gr.) frequently used in the New Test., and applied to persons suffering under the possession of a dæmon or evil spirit [see DÆMON], such possession generally showing itself visibly in bodily disease or mental derangement. The word *δαίμων* is used in a nearly equivalent sense in classical Greek (as in *Æsch. Chærop.* p. 566; *Sept. c. Theb.* p. 1001; Eurip. *Phæa.* p. 888, etc.), except that as the idea of spirits distinctly evil and rebellious, hardly existed, such possession was referred to the will of the gods or to the vague prevalence of an "Ary, or fury. Neither word is employed in this sense by the Sept., but in our Lord's time (as is seen, for example, constantly in Josephus) the belief in the possession of men by dæmons, who were either the souls of wicked men after death or evil angels, was thoroughly established among all the Jews, with the exception of the Sadducees alone. Demonized persons, in the N. T., are those who were spoken of as having a dæmon or dæmons occupying them, suspending the faculties of their minds, and governing the members of their bodies, so that what was said and done by the dæmoniacs was ascribed to the indwelling dæmon. Plato (*apud Clem. Alex. Strom.* i, 46.

zon.) affirms that "dæmoniacs do not use their own alect or tongue, but that of the demons who have tered into them." Lucian says "the patient is silent; the demon returns the answer to the question ked." Apollonius thus addresses a youth supposed be possessed: "I am treated contumeliously by the amon, and not by thee" (comp. Matt. viii, 28 and ; Mark v, 2; ix, 12; Luke viii, 27, 32). With reard to the frequent mention of dæmoniacs in Scripre, three main opinions have been started.

1. That of Strauss and the mythical school, which akes the whole account merely symbolic, without ais of fact. The possession of the devils is, accordg to this idea, only a lively symbol of the prevaence of evil in the world, the casting out of the devils r our Lord a corresponding symbol of his conquest ver that evil power by his doctrine and his life. This ction stands or falls with the mythical theory as a hole: with regard to this special form of it, it is suffici-ent to remark the plain, simple, and prosaic relation ' the facts as facts, which, whatever might be condved as possible in highly poetic and avowedly figu- rative passages, would make their assertion here not a ymbol or a figure, but a lie. It would be as reasona- ble to expect a myth or symbolic fable from Tacitus : Thucydides in their accounts of contemporary his- ry.

2. The second theory is, that our Lord and the vangelists, in referring to dæmoniacal possession, pake only in accommodation to the general belief of e Jews, without any assertion as to its truth or its alidity. It is concluded that, since the symptoms of e affliction were frequently those of bodily disease as dumbness, Matt. ix, 32; blindness, Matt. xii, 22; pilepsy, Mark ix, 17-27), or those seen in cases of rdinary insanity (as in Matt. viii, 28; Mark v, 1-5); ince, also, the phrase "to have a devil" is constantly sed in connection with, and as apparently equivalent o, "to be mad" (see John vii, 20; viii, 48; x, 20, and ehaps Matt. xi, 18; Luke vii, 33); and since, lastly, ases of dæmoniacal possession are not known to occur a our own days, therefore we must suppose that our ord spoke, and the evangelists wrote, in accordance ith the belief of the time, and with a view to be learly understood, especially by the sufferers them- selves, but that the dæmoniacs were merely persons uffering under unusual diseases of body and mind.

With regard to this theory also, it must be remarked hat it does not accord either with the general princies or with the particular language of Scripture. Accommodation is possible when, in things indifferent, anguage is used which, although scientifically or ety- nologically inaccurate, yet conveys a true impres- sion, or when, in things not indifferent, a declaration of truth (1 Cor. iii, 1, 2), or a moral law (Matt. xix, 8), s given, true or right as far as it goes, but imperfect, ecause of the imperfect progress of its recipients. But certainly here the matter was not indifferent. The age was one of little faith and great superstition; its haracteristic the acknowledgment of God as a distant awgiver, not an inspirer of men's hearts. This su- perstition in things of far less moment was denounced y our Lord; can it be supposed that he would sanc- tion, and the evangelists be permitted to record for ver, an idea in itself false, which has constantly been he very stronghold of superstition? Nor was the anguage used such as can be paralleled with mere onventional expression. There is no harm in our "speaking of certain forms of madness as lunacy, not hereby implying that we believe the moon to have or to have had any influence upon them; . . . but if we began to describe the cure of such as the moon's ceas- ing to afflict them, or if a physician were solemnly to address the moon, bidding it abstain from injuring his patient, there would be here a passing over to quite a different region, . . . there would be that gulf be- tween our thoughts and words in which the essence of a

lie consists. Now Christ does everywhere speak such language as this" (Trench, *On Miracles*, p. 153, where the whole question is most ably treated). Nor is there, in the whole of the N. T., the least indication that any "economy" of teaching was employed on account of the "hardness" of the Jews' "hearts." Possession and its cure are recorded plainly and simply; dæmoni- acs are frequently distinguished from those afflicted with bodily sickness (see Mark i, 32; xvi, 17, 18; Luke vi, 17, 18); even, it would seem, from the epileptic (*σκληροκέφαλοι*, Matt. iv, 24); the same outward signs are sometimes referred to possession, sometimes merely to disease (comp. Matt. iv, 24, with xvii, 15; Matt. xii, 22, with Mark vii, 32, etc.); the demons are represented as speaking in their own persons with superhuman knowledge, and acknowledging our Lord to be, not, as the Jews generally called him, son of David, but Son of God (Matt. viii, 29; Mark i, 24; v, 7; Luke iv, 41, etc.). All these things speak of a personal power of evil, and, if in any case they refer to what we might call mere disease, they at any rate tell us of something in it more than a morbid state of bodily organs or self-caused derangement of mind. Nor does our Lord speak of dæmons as personal spirits of evil to the multitude alone, but in his secret conversa- tions with his disciples, declaring the means and condi- tions by which power over them could be exercised (Matt. xvii, 21). Twice also he distinctly connects dæmoniacal possession with the power of the evil one; once in Luke x, 18, to the seventy disciples, where he speaks of his power and theirs over dæmoniacs as a "fall of Satan," and again in Matt. xii, 28-30, when he was accused of casting out demons through Beelze- bub, and, instead of giving any hint that the possessed were not really under any direct and personal power of evil, he uses an argument, as to the division of Sa- tan against himself, which, if possession be unreal, becomes inconclusive and almost insincere. Lastly, the single fact recorded of the entrance of the dæmons at Gadara (Mark v, 10-14) into the herd of swine, and the effect which that entrance caused, is sufficient to overthrow the notion that our Lord and the evangeli- sts do not assert or imply any objective reality of pos- session. In the face of this mass of evidence, it seems difficult to conceive how the theory can be reconciled with anything like truth of Scripture.

But, besides this, it must be added that, to say of a case that it is one of disease or insanity, gives no real explanation of it at all; it merely refers it to a class of cases which we know to exist, but gives no answer to the further question, how did the disease or insanity arise? Even in disease, whenever the mind acts upon the body (as e. g. in nervous disorders, epilepsy, etc.), the mere derangement of the physical organs is not the whole cause of the evil; there is a deeper one lying in the mind. Insanity may indeed arise, in some cases, from the physical injury or derangement of those bodily organs through which the mind exercises its powers, but far oftener it appears to be due to met- aphysical causes, acting upon and disordering the mind itself. In all cases where the evil lies not in the body, but in the mind, to call it "only disease or insanity" is merely to state the fact of the disorder, and give up all explanation of its cause. It is an assumption, therefore, which requires proof, that, amid the many inexplicable phenomena of mental and physical disease in our own days, there are none in which one gifted with "discernment of spirits" might see signs of what the Scripture calls "possession."

The truth is, that here, as in many other instances, the Bible, without contradicting ordinary experience, yet advances to a region where human science cannot follow. As generally it connects the existence of mental and bodily suffering in the world with the in- troduction of moral corruption by the Fall, and refers the power of moral evil to a spiritual and personal source, so also it asserts the existence of inferior spir-

its of evil, and it refers certain cases of bodily and mental disease to the influence which they are permitted to exercise directly over the soul and indirectly over the body. Inexplicable to us this influence certainly is, as all action of spirit on spirit is found to be; but no one can pronounce *à priori* whether it be impossible or improbable, and no one has a right to eviscerate the strong expressions of Scripture in order to reduce its declarations to a level with our own ignorance. See CONDESCENSION.

8. We are led, therefore, to the ordinary and literal interpretation of these passages, that there are evil spirits (see DÆMON), subjects of the Evil One, who, in the days of the Lord himself and his apostles especially, were permitted by God to exercise a direct influence over the souls and bodies of certain men. This influence is clearly distinguished from the ordinary power of corruption and temptation wielded by Satan through the permission of God. Its relation to it, indeed, appears to be exactly that of a miracle to God's ordinary Providence, or of special prophetic inspiration to the ordinary gifts of the Holy Spirit. Both (that is) are actuated by the same general principles, and tend to the same general object; but the former is a special and direct manifestation of that which is worked out in the latter by a long course of indirect action. The distinguishing feature of possession is the complete or incomplete loss of the sufferer's reason or power of will; his actions, his words, and almost his thoughts are mastered by the evil spirit (Mark i, 24; v, 7; Acts xix, 15), till his personality seems to be destroyed, or, if not destroyed, so overborne as to produce the consciousness of a twofold will within him, like that sometimes felt in a dream. In the ordinary temptations and assaults of Satan, the will itself yields consciously, and by yielding gradually assumes, without losing its apparent freedom of action, the characteristics of the Satanic nature. It is solicited, urged, and persuaded against the strivings of grace, but not overborne.

Such possession, however, is only the special and, as it were, miraculous form of the "law of sin in the members," the power of Satan over the heart itself, recognised by Paul as an indwelling and struggling power (Rom. vii, 21-24). Nor can it be doubted that it was rendered possible in the first instance by the consent of the sufferer to temptation and to sin. That it would be most probable in those who yielded to sensual temptations may easily be conjectured from general observation of the tyranny of a habit of sensual indulgence. The cases of the habitually lustful, the opium-eater, and the drunkard (especially when struggling in the last extremity of delirium tremens) bear, as has often been noticed, many marks very similar to those of the scriptural possession. There is in them physical disease, but there is often something more. It is also to be noticed that the state of possession, although so awful in its wretched sense of dæmoniacal tyranny, yet, from the very fact of that consciousness, might be less hopeless and more capable of instant cure than the deliberate hardness of wilful sin. The spirit might still retain marks of its original purity, although through the flesh and the dæmoniac power acting by the flesh it was enslaved. Here, also, the observation of the suddenness and completeness of conversion seen in cases of sensualism, compared with the greater difficulty in cases of more refined and spiritual sin, tends to confirm the record of Scripture.

It was but natural that the power of evil should show itself, in more open and direct hostility than ever, in the age of our Lord and his apostles, when its time was short. It was natural also that it should take the special form of possession in an age of such unprecedented and brutal sensuality as that which preceded his coming, and continued till the leaven of Christianity was felt. Nor was it less natural that it should have died away gradually before the great di-

rect, and still greater indirect influence of Christ's kingdom. Accordingly we find early fathers (as *Jes. Mart. Dial. c. Tryph. p. 811 B.*; Tertullian, *Apoc. 37, 48*) alluding to its existence as a common thing, mentioning the attempts of Jewish exorcism in its name of Jehovah as occasionally successful (see *Mat. xii, 27*; *Acts xix, 18*), but especially dwelling on its power of Christian exorcism to cast it out from the country as a test of the truth of the Gospel, and as a well-known benefit which it already conferred on its empire. By degrees the mention is less and less frequent, till the very idea is lost or perverted. See EXORCISER.

Such is a brief sketch of the scriptural notices of possession. That round the Jewish notion of it then grew up, in that noted age of superstition, many Jewish and evil practices, and much superstition as to fumigations, etc. (comp. *Tob. viii, 1-8*; *Joseph. Ant. vi, 2, 5*), of the "vagabond exorcists" (see *Acts xix, 13*) is obvious, and would be inevitable. It is clear the Scripture does not in the least sanction or even condescend to notice such things; but it is certain that in the Old Testament (see *Lev. xix, 81*; *1 Sam. xxvii, 7, etc.*; *2 Kings xxi, 6*; *xxiii, 24, etc.*), as well as in the New, it recognises possession as a real and direct power of evil spirits upon the heart.—*Smith, Dict. of Bible, s. v. See POSSESSED (with a devil).*

Dagan. See CORN; AGRICULTURE.

Dagger (דָּבָר, *che' reb*, usually "sword"), a sharp instrument, especially a military weapon (*Jac. iii, 16, 21, 22*). See SWORD.

Daggett, Herman, a Congregational minister, was born at Walpole, Mass., Sept. 11, 1766, and graduated at Brown University, 1788. He entered the ministry Oct. 1789, and after preaching a year in Southhold, L. I., was ordained pastor in Southampton, April 12, 1792. In 1796 he removed to West Hampton, N. Y. In 1801 he was ordained pastor over the churches of Five Place and Middle Island, which he resigned in 1804. In 1818 he became principal of the For. Miss. School at Cornwall. This position he resigned in 1834, and died May 19, 1882.—*Sprague, Annals, ii, 291.*

Daggett, Naphtali, D. D., a Congregational minister, was born at Attleborough, Mass., Sept. 8, 1757; graduated at Yale 1788, and was ordained pastor in Smithtown, L. I., 1781. He was elected Professor of Divinity in Yale College, 1786, and remained there until his death, Nov. 25, 1780. He occupied the presidential chair of the college *pro tempore* from 1766 until 1777. When the British landed at West Haven, 1779, his patriotic ardor led him to take up arms, and he was very rudely treated by the enemy. His death was hastened by his sufferings. He published a few sermons.—*Sprague, Annals, i, 479.*

Dagobert. See DAIMBERT.

Dag'on (Heb. דָּגוֹן, *Dagon*; Sept. and Josephus, *Δαγών*), the national god of the Philistines. Some have derived the name from דָּג, *grain* (*Sanchoniathon, Fragm. ed. Orelli, p. 26, 32*; *Bochart, Hieros. i, 881*; *Beyer, ad Seld. p. 265*); but the derivation from דָּג, a *fish*, with the diminutive (i. e. endearing) termination *on* (*Gesenius, Thes. p. 820*), is not only more in accordance with the principles of Hebrew derivation (*Ewald, Heb. Gram. § 312, 341*), but is most decisively established by the terms employed in *1 Sam. v, 4*. It is there said that Dagon fell to the earth before the ark, that his head and the palms of his hands were broken off, and that "only Dagon was left on him." If Dagon is derived from דָּג, *fish*, and if the idol, as there is every reason to believe, had the body of a fish with the head and hands of a man, it is easy to understand why a part of the statue is there called *Dagon* in contradistinction to the head and hands, but not otherwise. That such was the figure of the idol is asserted

Kimchi, and is admitted by most modern scholars. is also supported by the analogies of other fish deities among the Syro-Arabians (see Herod. ii, 72; *Æli-*, *Assen.* x, 46; xii, 2; *Xenoph. Anab.* i, 4, 9; Strabo, ii, 812; Diod. Sic. ii, 4; Cicero, *Nat. Deor.* iii, 15; *cap. Münster, Rel. d. Karth.* p. 102; *Movers, Phöniz.* 491 sq.; *Cruzer, Symbol.* ii, 78 sq.). Besides the **ATERGATIS** (q. v.) of the Phœnicians (which was the female counterpart of Dagon), the Babylonians had a tradition, according to Berossus (*Historia Quæ exægyptiaca*, ed. *Richter*, p. 48, 54), that at the very beginning of their history an extraordinary being, called *Oannes*, having the entire body of a fish, but the head, hands, feet, and voice of a man, emerged from the Euxine Sea, appeared in



Representation of a Fish-god.—From the Assyrian Monuments at Khorsabad.

the Euxine Sea, appeared in Babylonia, and taught the rude inhabitants the use of letters, arts, religion, law, and agriculture; that, after long intervals between, other similar beings appeared and communicated the same precious lore in detail, and that the last of these was called *Odakon* (*Ὀδάκων*). Selden is persuaded that this *Odakon* is the Philistine god Dagon (*De Diis Syris*, p. 265), a conclusion in which Niebuhr coincides (*Gesch. Assur.* p. 77), but from which Rawlinson dissents (*Herod.* i, 82). The resemblance between Dagon and Atergatis (q. d. *אֶתְרַגַּיִת* and *גַּי*, *great fish*) or *Derketo* (which is but an abbreviation of the last name) is so great in other respects that Selden accounts for the only important difference between them—that of sex—by referring to the androgynous nature of many heathen gods. It is certain, however, that the Hebrew text, the Sept., and Philo Byblinus (in Euseb. *Præp. Ev.* i, 10) make Dagon masculine (*ὁ Δαγών*). The fish-like form was a natural emblem of fruitfulness, and as such was likely to be adopted by seafaring tribes in



Fish-god on Gems in British Museum.

the representation of their gods. (See *Götze, Dissert. de ἱερολυπολίτῃς*, Lips. 1725.)

The most famous temples of Dagon were at Gaza (*Judg.* xvi, 21–30) and Ashdod (1 Sam. v, 5, 6; 1 Chron. x, 10). The former was employed as a theatre (see *Faber, Archæol.* i, 444, 436), and was once overthrown by Samsen (*Judg.* xvi). The latter temple was destroyed by Jonathan in the Maccabæan wars (1 Macc. x, 84; xi, 4; *Josephus, Ant.* xiii, 4, 5). There would also seem to have been a third in the vicinity of Jericho, which was demolished by Ptolemy (*Joseph. War.* i, 2, 8); and the site of which Schwarz claims (*Palest.* p. 168) to have discovered in a stream still bearing the name of *Duga*, or fish-river: it is but a relic of the ancient *Doch*, or *Docus* (q. v.). Traces of the worship of Dagon likewise appear in the names Caphar-Dagon (near Jamnia), and Beth-Dagon in Judah (*Josh.* xv, 41), and Asher (*Josh.* xix, 27). See **BETH-DAGON**.

Besides the female figure of Atergates, there have lately been discovered among the Assyrian ruins (*Botta, pl.* 32–35) figures of a male fish-god, not only of the forms given above (*Layard, Nineveh*, ii, 358), but occasionally with a human form and feet, the fish only covering the back like a cloak (*Layard, Babylon*, p. 301). Colonel Rawlinson has also deciphered the name *dagon* on the cuneiform inscriptions (q. v.). See **Ro-**

ser, De Dagon, in *Ugolini, Thesaur.* xxiii; *Sharpe* in *Bonomi's Nineveh*, 3d ed. p. 169.



Figure of Fish-god at entrance of a small Temple, Nimrod.

DAGON'S HOUSE (1 Sam. v, 5), or the **TEMPLE OF DAGON** (1 Chron. x, 10), *בֵּית־דָּגוֹן*, i. e. *Beth-Dagon*, as it is elsewhere rendered (*Josh.* xv, 41; xix, 27; so *Βηθδαγών*, 1 Macc. x, 88), or the sanctuary of Dagon, the god of the Philistines, mentioned in *Judg.* xvi, 23, and other places. See this etymology defended against the older one (which Fürst retains, *Heb. Lex.* p. 286) in *Genesius, Monument. Phœn.* p. 387, and *Thesaur.* p. 204. In the first two (and possibly also the third) of the above passages, the temple of Dagon, situated in or near Ashdod (as stated under the foregoing article **DAGON**), is evidently intended; the other collocations of these words [see **BETH-**] require a fuller elucidation than could well be given in the article **BETH-DAGON** (q. v.).

1. **BETH-DAGON**, in *Josh.* xv, 41, was one of the second group of "sixteen cities with their villages," which the sacred writer places in the lowlands (*שְׁפֵלָה*) of the tribe of Judah, apparently on the actual plain which stretches westward towards the Philistine coast from "the hill country" so often mentioned. This does not (as in *Reland, Palestina*, p. 636) designate a *Gederoth-Bethdagon*, as the name Gederoth occurs alone in 2 Chron. xxviii, 18, with the same description as it has in this place, as one of the cities of the lowlands of Judah. Genesius and Fürst identify this Beth-dagon with the Caphar-dagon, which in the time of Eusebius was a very large village (*κώμη μεγάλη*, *Inter Jamniam et Diospollin*) in the neighborhood of Joppa; but modern research has shown that this latter place, of which still remain some traces in *Beit-Dejan*, a village between Yâfa and Ludd, is considerably above the northern boundary of Judah. Our Beth-dagon, indeed, no longer exists by the same name (*Van de Velde's Map of Palestine and Memoir*, p. 294). The same must be said of

2. **BETH-DAGON**, mentioned in *Josh.* xix, 27, as one of the border cities of the tribe of Asher. Though, however, no modern landmark points out the site of

this north Beth-dagon, it is not difficult to discover, from the precise topographical statement of the sacred writer, that this city was situated at the point where the boundary-line of the tribe, after crossing the ridge south of the promontory of Carmel towards the east, intersects the stream of the Kishon, on the confines of Zebulun. It is remarkable that, as there is a modern *Beit-Dejan* in the south which yet cannot be identified with, but is far to the north-west of, the southern Beth-dagon, so there is still, in the central district of the Holy Land, a second *Beit-Dejan*, which is equally far distant from our northern Beth-dagon, only in the opposite direction of south-east. In the fertile and beautiful plain of Sâlim, a little to the east of Nâbulus (Shechem), Dr. Robinson described at the east end of it, on some low hills, a village called *Beit-Dejan* (*Bibl. Researches*, iii, 102; *Later Researches*, p. 298). This *Beit-Dejan*, Robinson thinks, has no counterpart in the Beth-dagons of the Bible. The French traveller, De Sauley, is not of this opinion, but identifies the village near Nâbulus with the Beth-dagon of Chron. x, 10; because "this village is only one day's march from Jilboun, the locality in the mountain to the north-east of Jenin, which was unquestionably the scene of Saul's disaster" (*Dead Sea*, i, 101). If his conjecture be right, we must indicate this as the

3. BETH-DAGON of 1 Chron. x, 10 (Sept. οἶκος Δαγών), in the western half-tribe of Manasseh (some distance from Mount Gilboa), where the Philistines, after their victory, placed Saul's head in the temple of their god—his body and those of his sons having been carried (the same distance north-east) to Bethshan, whence the Jabesh-Gileadites afterwards rescued them. It no doubt aids this view that we are not otherwise informed where the temple was in which they deposited their ghastly trophy; moreover, the phrase (in ver. 9) *בְּמִצְרַיִם*, denoting a *circus* of the adjacent country, which had been evacuated by Israel, and was then occupied by the enemy (ver. 7), very well suits the relative positions of this *Beit-Dejan* and Bethshan, equally distant from the fatal field, and in different directions.

4. With regard to the Beth-dagon of 1 Macc. x, 88, Gesenius (*Thes.* p. 194) expresses a doubt whether this passage means only Dagon's temple at Azotus, or a Beth-dagon, a town so called in the neighborhood. In that case we might regard this as a city in the vicinity of Azotus (or Ashdod), answering probably to Dr. Robinson's western *Beit-Dejan*, and Eusebius's Caphardagon, already mentioned. It will be observed that in the 84th verse Beth-dagon occurs as a proper name, as it also does in the original, *Βηθδαγών*, whereas, in the next verse, the temple of the Philistine god is described by the appellation *τὸ ἱερόν Δαγών*. On the whole, however, there does not appear to be sufficient reason for the distinction.—Kitto, *Cyclop.* s. v.

Dailey, DAVID, a Methodist Episcopal minister, was born in Gloucester County, N. J., March 1, 1792, was converted in 1805, entered the itinerancy in 1812, became superannuated in 1856, and died May 4, 1856. For more than forty years he was a useful minister and presiding elder, and was especially "proficient in the theology of the plan of salvation." He filled many important stations with uniform and excellent success. He was one of the editors of the revised *Hymn-book* of the Methodist Episcopal Church now in use.—*Minutes of Conference*, vi, 219.

Dailé, JEAN, minister of the French Reformed Church, and one of the most learned theologians of his age. He was born at Châtelleraut Jan. 6, 1694; became tutor in the family of Duplessis-Mornay (q. v.) in 1612, and was ordained in 1628. Most of the remainder of his life was spent as minister of Charenton. He died April 15, 1670. In theology Dailé belonged to the moderate school of Saumur (q. v.). "His discourses are characterized by a heart-stirring eloquence,

and it has been remarked of him that he had all the eloquence of Saurin without any approach to hisigid and bombastic style. The work by which Dailé is best known is his treatise *De usu Patrum*, was designed to check or moderate the excessive reverence which is felt in many quarters for the writers of ecclesiastical antiquity. It rendered an important service to the Protestant cause in his own country and time, and may still be consulted with great advantage." It was published in 1632; in Latin in 1636 (Genev. 4to); and a translation into English in 1651, under the title of *A Treatise concerning the right Use of the Fathers in the Decision of Controversies that are at this Day in Religion* (new ed. by Jekyll, Lond. 1841, 12mo; Amer. ed. Phila. 1842, 12mo). We have translation also of his *Exposition of the Philippicæ*, by Sherman (Lond. 1841, imp. 8vo); *Exposition of Colossians*, by Sherman (Lond. 1841, imp. 8vo). Among his other writings are *De Cultibus Latinorum* (Genev. 1671, 4to); *De Pœnis et Satisfactionibus humanis* (Amst. 4to); *De la Créance des Pères sur le fait des Images* (8vo); *La Confirmation et est. unctione* (Genev. 1659, 4to); *La Auriculari Confessione* (Genev. 1661, 4to); *De Periepigraphis Apostolicis* (1658, 8vo); and 20 volumes of sermons.—See Haag, *La France Protestante*, iv, 181; Rich, *Biog. Dictionary*, s. v.; *Life of Dailé*, prefixed to his *Right Use of the Fathers*; Chase, in *Bibliotheca Sacra*, iv, 5 sq.; Bayle, *Dictionary*, s. v.; Hoeda, *Nov. Biog. Générale*, xii, 790.

D'Ailly. See AILLY.

Daily occurs in the Engl. version of our Lord's Prayer as the rendering of *ἐπιτοσίος* (Matt. vi, 1; Luke xi, 8), which literally means *for subsistence*, i. e. *needful*, as it probably should have been translated. The same Greek word occurs nowhere else, although several Heb. and Greek words are thus translated in other passages. Conant, however (*Revised Version of Matthew*, N. Y. 1860, p. 30), maintains the correctness of the Auth. Vers., as does also Schaff (in Lange's *Matthew*, p. 121). But this involves a palpable tautology. See DAY. Treatises on the phrase "daily bread" have been written in Latin by Kirchmaier (Viteb. 1711), Kortholt (Kil. 1677), Stolberg (Viteb. 1688), Pfeiffer (Regiom. 1689), Zorn (*Opusc.* i, 465-505). See LORD'S PRAYER.

DAILY OFFERING or SACRIFICE (תָּמִיד וְזָבַח, the continual offering; Josephus ἄλλοτενερῶς ἐνδελ. χρυσῶν, ἐνδελ. χρυσῶς, War, vii, 2, 1), in Daniel (viii, 12 sq.; xi, 81; xii, 11) and the Talmud (simply תָּמִיד וְזָבַח, "the continual," *sacrificium jure*), was a burnt-offering of two year-old lambs, which were daily immolated in the name of the whole Israelitish people (*ἐκ τοῦ δημοσίου ἀναλώματος*, Joseph. Ant. iii, 10, 1) upon the great altar; the first lamb early (as soon as it became light, Mishna, *Tamid*, iii, 2; no reliance is to be placed upon Zorn's treatise *De certis temp. in juri sacrificii ap. Ebr. offendo*, in the *Miscell. Lips. No.* ii, 1 sq.), the other (תָּמִיד וְזָבַח, "the evening oblation," Dan. ix, 21) at evening (more definitely תָּמִיד וְזָבַח, between the two evenings [see PASSOVER]; according to *Peacock*, v, 1, the eve-offering was sacrificed as a rule between the eighth-and-a-half and the ninth-and-a-half hour [2½ to 8¼ o'clock P.M.], but on Sabbath-eve and Passover-eve [14th Nisan] one hour earlier; Josephus, Ant. xiv, 4, 8, designates "about the ninth hour" as the time; comp., however, Jonathan's *Targum*, Gen. xlix, 27. This was the usual termination of a fast [q. v.], Dan. ix, 21; Acts iii, 1; x, 8, 30), each with one tenth of an ephah of fine wheat-flour as a meat offering, and a quarter of a hin of wine as a drink offering (Exod. xxix, 38-42; Num. xxviii, 8-8; Ezra iii, 5). It was not superseded by the Sabbath or festival offerings (Num. xxviii, 9 sq., 15 sq.; not even by those of the Passover, *Peacock*, v, 1). The regulations concerning the preparation of

priests for this annual religious service, the allotment of the several operations, and the ritual of the sacrifice itself, were eventually proscribed in the tract *Tamid* (Mishna, v, 10), which Iken has illustrated with a lucid explanation (Brem. 1786, and in *Ugolini Theor.* xix); comp. also Loecan, *De Sacrificio Quotid.* (ips. 1718). In the (last) Temple there was a lamb-ambition in the north-west corner for the special purpose of this offering (*Tamid*, lii, 8).—Winer, *Reale*. li, 7. See SACRIFICE.

DAILY SERVICE or PRAYERS. In the ancient church, wherever it was practicable, daily service was established, at which every clergyman was compelled to attend, under pain of suspension or deprivation, whether it was his duty to officiate or not. This subject is determined by several councils, by the first council of Toledo, and by that of Agde: the law of Justinian unites the neglect of this duty with degradation, because of the scandal it gives to the laity. In some churches a daily celebration of the Lord's Supper seems to have been recommended, and to some extent practiced. There are found testimonies on this subject in Tertullian, Cyprian, and Irenaeus; the last of whom says, "It is the will of our Lord that we should make our offering at his altar frequently, and without intermission." But there was no fixed and express rule as to the time of celebration. The rubric of the Church of England declares that all "priests and deacons are to say daily the morning and evening prayer, either privately or openly, not being let by sickness or some other urgent cause. And the curate that ministereth in every parish church or chapel, being at home, and not being otherwise reasonably hindered, shall say the same in the parish church or chapel where he ministereth, and shall cause a bell to be tolled thereunto a convenient time before he begin, that the people may come to hear God's word and to pray with him." But this rule is now a dead book.—*Prayer-book*, Preface; *Bingham, Orig. Eccl.* bk. vi, chap. iii, § 5, 6; Procter, *On Common Prayer*, p. 195-197.

Daimbert or Dagobert, the first Latin patriarch of Jerusalem. While he was bishop of Pisa, pope Urban II conferred upon him the sovereignty of Corsica for an annual tribute of fifty livres, and appointed him papal legate in the East. In Nov. 1095, Daimbert was present at the Council of Clermont when Urban II preached the first crusade, and he joined the crusade at the head of troops from Pisa and Genoa. When Daimbert arrived in Palestine, Godfrey of Bouillon was already master of Jerusalem. At a general meeting of the Christian chiefs, held on Christmas, 1099, Daimbert was elected patriarch of Jerusalem, in the place of one Arnulphus who was deposed. Godfrey had to leave to Daimbert the sovereignty of Jaffa, and of that quarter of Jerusalem in which the Church of the Resurrection was situated. On the death of Godfrey, Daimbert aspired to the throne of Jerusalem, but finally had to yield to Baldwin, and to crown the new king. Falling out with Baldwin, he was expelled by the latter, and Arnulphus returned to the patriarchate. Daimbert went to Italy, and prevailed upon pope Paschal II to decide in his favor. He intended to return to Jerusalem and to enforce the papal decision, but died on his way at Palermo, in 1107.—*Hoefler, Biographie Générale*, xii, 792.

Dal'san (Δαϊσάν v. r. Δεϊσάν, Vulg. *Deacon*), the head of one of the families of temple-servants that returned from Babylon (1 Eadr. v, 31); evidently a corruption (ד being mistaken for ד) for the REZIN (q. v.) of the Heb. texts (Ezra ii, 48; Neh. vii, 60).

Dal'yah. See VULTURE.

Dalal'ah (1 Chron. iii, 24), the same name elsewhere more correctly Anglicized DELALAH (q. v.).

Dalberg, KARL THEODOR, baron of Dalberg, was

born Feb. 8, 1744, at Hershheim, near Worms; he studied at Göttingen and Heidelberg; became, while yet very young, prebendary of Mayence, and canon of Worms and Würzburg. In 1772, as governor of Erfurt, he gave a great impulse to agriculture, commerce, and industry. In 1787 he became coadjutor of the elector of Mayence and the bishop of Worms; was made bishop of Constance in 1788, and soon after archbishop of Tarsus. The last elector of Mayence died in 1802, and as, by the treaty of Lunéville, the electorate of Mayence on the one side of the Rhine had been abolished and on the other secularized, Dalberg became arch-chancellor, which position he held with great credit; but by suppressing the convents he incurred the hatred of the clergy, and by sympathy for France that of Germany. In 1804 he was present at the coronation of the emperor at Paris. When the confederacy of the Rhine was formed he had to resign his office, but, in exchange, was made prince-primate of the confederacy, and was Napoleon's adviser in spiritual and ecclesiastical matters. He afterwards became grand-duke of Frankfurt, and appointed Eugène Beauharnais as his successor. In 1819 he renounced his title, went first to Constance, where he protected the vicar general Wessenberg from the enmity of the pope, and afterwards returned to Regensburg, where he lived in retirement on a pension of 100,000 florins, and died Feb. 10, 1817. His principal works are, *Betrachtungen ü. d. Unioerum* (Frankf. 1777; 6th ed. 1819); *Verhältnisse zwischen Moral und Staatskunst* (Frankf. 1786); *Grundsätze d. Aesthetik* (Erf. 1791); *Von d. Bewusstseyn als allem. Grunde d. Weltweisheit* (Erf. 1798); *Betrachtungen ueber d. Charakter Karls d. Gr.* (Erfurt, 1806); *Perikles* (Rome, 1811). See KRÄMER, *Gedächtniss-schrift auf K. von Dalberg* (Gotha, 1817).—*Hoefler, Nouv. Biographie Générale*, xii, 802.

Dale, THE KING'S (דָּלַיִם הַמֶּלֶךְ, *valley of the king*), the name of a valley apparently near the Dead Sea, where Melchizedek met Abraham (Gen. xiv, 17); otherwise called the *Valley of Shaveh* (q. v.), but identified by some with another of the same name (the modern Valley of Jehoshaphat, or, rather, its southern part, opening into the plot used for the king's garden, about the well of Job and the pool of Siloam), in which Absalom reared his family monument (2 Sam. xviii, 18). See ABSALOM'S TOMB.

Dale, or **DALEN**, ANTONIUS VAN, was born Nov. 8, 1688, in Haarlem. He was brought up to business against his will. At the age of thirty he applied himself to the study of the ancient languages, and at the same time to that of medicine. He became a practicing physician, and attained distinction in his profession. His faithful and disinterested attention to his poor patients secured him high praise. He also exercised for a time his preaching gift among the Mennonites; but his sermons were overloaded with learned citations, and hence were hardly acceptable to the people. His European reputation rests, however, on the learned works which he wrote against what he regarded as superstition. In 1688 he published *De oraculis Ethnicorum dissertationes duas, quarum prior de ipsorum duratione ac defectu, posterior de eorumdem auctoribus* (Amst. 8vo). In this work he combated the opinion that demoniac influence was exerted in connection with the oracles of the ancients, and that sorcery is to be ascribed to Satan. The work produced a great sensation. Fontenelle made free use of it in the composition of his *Histoire des Oracles* (Paris, 1707, 12mo). He wrote several other works in Latin, and one in his native tongue, on the same subject, discrediting belief in Satanic agency, especially when applied to the interpretation of Scripture. He also published a *Dissert. super Aristeæ de LXX interpretibus*, with a history of ceremonies of baptism among the Jews, and among the various Christian communions (Amst. 1704, 4to). He died Nov. 28, 1708, deeply la-

mented. I. Clericus, T. Janssonius, and Prof. Morris were among his friends.

Daleites, followers of David Dale, pastor of an independent congregation at Glasgow. Since the death of Mr. Dale they have formed a connection with the Inghamites (q. v.).

Dalmanutha (*Δαλμανουθά*, deriv. unknown, unless [as suggested by Lightfoot, *Hor. Hebr.* p. 555; comp. Simonis *Onom.* p. 51] for the *Zalmou*, זלמו, a town mentioned in the Talmud as lying near Tiberias), a place mentioned only in Mark viii, 10, where we read that Jesus, after feeding the multitude in the Decapolis, east of the Sea of Galilee, took a boat and "came into the regions (*εις τα μέρη*) of Dalmanutha;" while the parallel passage (Matt. xv, 39) states that he "came into the borders of Magdala." From this we may conclude that Dalmanutha was a town on the west side of the lake near Magdala. The latter stood close upon the shore, at the southern end of the little plain of Gennesaret, at the present Mejdal. See **MAGDALA**. Immediately south of it a precipitous hill juts out into the sea. Beyond this, about a mile from Magdala, a narrow glen breaks down from the west. At its mouth are some cultivated fields and gardens, amid which, just by the beach, are several copious fountains, surrounded by heavy ancient walls and the ruins of a village. The place is called *'Ain el-Bârideh*, "the cold fountain" (Robinson, *Res. iii*, 27), and has, with great probability, been thought to be the site of Dalmanutha (Porter, in Smith and Kitto, s. v.; Tristram, *Land of Israel*, p. 429). See **CAPERNAUM**. Thomson thinks it may be the present ruined site called *Dalmania*, on the river south of the lake, although he admits this seems too far from Magdala (*Land and Book*, ii, 60). Schwarz (*Palest.* p. 189) finds it in the "cave of *Téli-man*" (תלמן), mentioned in the Talmud, situated probably in the cliffs above Mejdal (Van de Velde, *Memoir*, p. 334), which, he learns, was also called *Talmanuta*.

Dalmatia (*Δαλμαρία*, deriv. unknown), a mountainous country on the eastern shore of the Adriatic Sea (Pliny, iii, 28; Strabo, vii, 815), between the rivers Titius and Drinus, and the Bebian and Scordian hills, south of Laburnia (Pliny, iii, 26), which, together with it, formed, after the expedition of Tiberius, A. D. 9, the Roman province of Illyricum, for which, indeed, it was often spoken of synonymously (Conybeare and Howson's *St. Paul*, ii, 126). Its principal towns were Salona, Epidaurus, Lissus, etc. (Ptolemy, ii, 17, 4). It derived its name from the Dalmata, a barbarous but valiant race, supposed to be of Thracian origin, and who were very skillful in navigating the sea along their coasts, and extremely bold in their piracies. The capital, Dalminium, was taken and destroyed by the Romans, B. C. 157; the country, however, was not completely subdued till the time of Augustus. The modern name of the country is the same as the ancient. Education and morality are here at a lower ebb than in any other part of the Austrian empire (see the *Penny Cyclopædia*, s. v.; Smith's *Dict. of Class. Geog.* s. v., and the travellers there referred to). See **ILLYRICUM**.

During Paul's second imprisonment at Rome, Titus left him to visit Dalmatia (2 Tim. iv, 10), but for what purpose is not stated, unless we may conjecture that it was to regulate the affairs of the Church in that region (Cellarii *Notit.* i, 614 sq.), in the vicinity of which Paul had formerly preached (Rom. xv, 19). See **TIRRUS**.

At present Dalmatia is a crown-land of the Austrian emperor, the emperor bearing among his other titles that of king of Dalmatia. According to the last census of 1857, the population amounted to 404,499, mostly Slavi. Of these, 387,800 were Roman Catholics, under the archbishop of Zara and five bishops (Sebenico, Spalato, Lesina, Ragusa, and Cattaro); 341 United

Greeks (in three congregations, belonging to the diocese of Kreuz, in Croatia; 77,144 members of the orthodox (non-United) Greek Church, under one bishop, who formerly resided at Sebenico, and since 1843 at Zara; 17 Lutherans; 8 Reformed; and 818 Israelites. The Roman Catholics have 297 parishes, 122 chaplaincies, and 69 monasteries; the orthodox Greeks, 97 parishes, 9 chaplaincies, and 11 monasteries.—*Albany Real-Encyclop.* iii, 78.

Dalmatic, the characteristic dress of the clergy in the administration of the Eucharist, so called from being first worn in Dalmatia, or first used by the Dalmatian clergy (Durandus, *Rat.* iii, 1). It is a robe reaching down to the knees, and open at one side for a distance varying at different periods. It is not marked at the back with a cross like the chasuble, but in the Latin Church with two narrow stripes, the remains of the *angusti clavi* worn on the old Roman dress. In the Greek Church it is called *colobium*, and is covered with a multitude of small crosses. The dalmatic is seen, in some old brasses, worn over the stole and the stole, the fringed extremities of which reach just below it. It was adopted at a later period by the higher clergy. The chasuble (q. v.) was sometimes worn over the dalmatic. Its symbolical meaning is thus explained by the ritualists: "The deacon's robe of white with purple stripes, with the right sleeve plain and very full, but the left fringed or tasseled, is the image of bountifulness towards the poor. It is the robe given to deacons and sub-deacons, because they were chosen by the apostles to serve the tables, and a deacon should have a dalmatic with broader sleeves than a sub-deacon, because he should have a larger generosity, while a bishop should have one with sleeves much broader and wider than the deacon's because of the same reason in an ascending ratio. A dalmatic signifies an immaculate life as well as hospitality, and it has two stripes before and behind to show that a bishop should exercise his charity to all, both in prosperity and adversity. The transverse line, which forms a cross behind, is, of course, in allusion to the cross which the great Bishop of our souls bore when on his way to Calvary."—Bingham, *Orig. Eccl.* bk. vi, ch. iv, § 20; Rock, *Hierurgia*, ii, 647; *Heck Church Dictionary*, s. v.; Palmer, *Orig. Liturgic.* i, 814.

Dal'phon (Heb. *Dalphon*, דלפון, prob. Persian; Sept. *Δελφών* v. r. *καὶ ἀδελφών*; Vulg. *Delfon*), the second of the ten sons of Haman; killed by the Jews on the 13th of Adar (Esth. ix, 7), B. C. 478.

Dam (דָּם, *mother*), the female parent of young birds (Deut. xxii, 6, 7), or lambs (Exod. xxii, 3; Lev. xxii, 27). With the Mosaic regulations of merciful treatment toward these creatures spoken of in these passages, compare the similar ordinance respecting boiling a kid in its own mother's milk (Exod. xxiii, 19), and the treatise of Heumann, *De legis paradice* (Gött. 1748, and in his *Sylog. Diss.* ii, 262 sq.). See **BEAST**.

Damages, whether to person or property, according to the Mosaic statutes. See also **FINE**.

1. Injury to limb, in the case of a free Israelite, entailed an equal infliction (*jus talionis*) upon the same part of the body of the aggressor (Exod. xxi, 23-25; Lev. xxiv, 19 sq.; Deut. xix, 21; comp. Matt. v, 38); in the case of a slave it effected his freedom (Exod. xxi, 26 sq.; comp. Philo, *Opp.* ii, 332). Pecuniary satisfaction, however, in the former case, was a well-established custom (Josephus, *Ant.* iv, 8, 35), so that retaliation was probably resorted to only in cases of intentional or malicious injury (comp. Exod. xxii, 2 sq.; see Michaelis, *Mos. Recht.*, v, 55 sq.). Greek legislation also (Diod. Sic. xii, 17; Diog. Laert. i, 57), as well as the law of the Roman Twelve Tables (see Gel. xx, 1; comp. Heinecc. *Anst. Jur. Rom.* iv, 18, 8, and *Opusc. min.* p. 213 sq.; on the Germanic usages, see

rodtmann, *Deutsche Alterthümer*, p. 46), sanctioned a natural and simple judicial observance of "like" (comp. Douglai, *Analect.* i, 92, 11; Danz, *Menschen's N. Test. Talm.* p. 488 sq.). Among the raelites, however, it does not seem to have often been forced (comp. Lightfoot, *Hor. Hebr.* p. 282), and corporal injuries, at least under the monarchy, were almost always compromised by a sum of money (so generally among the Turks; see Hammer, *Oman. Reich*, i, 6 sq.). The Talmudical interpretation growing out of this enactment may be seen in *Baba Kamma*, viii, See RETALIATION.

2. Wounding a free person in an affray (where both parties might be presumed to be pretty nearly equally blame, the injury, however, must have been inflicted with a stone or the fist, רִיבָה; comp. Philo, ii, 17, τῷ χροί; not with a proper weapon, Josephus, *Ant.* iv, 8, 33; also in a suddenly outbursting quarrel between them that gave no evidence of long-medicated harm), which rendered the individual unfit for work, required compensation for the loss through sickness and the expense of cure (Exod. xxi, 18 sq.; ver. 9 prescribes that this mulct should cease when the wounded person became able to go about again); should he die afterwards no further penalty was to be exacted (Philo, *Opp.* ii, 817; comp. *Baba Kamma*, viii,). More severe exaction followed when in a fray a pregnant woman was so injured as to suffer abortion, or when the law of life for life prevailed in full (Exod. xxi, 22; according to Josephus, however, *Ant.* iv, 8, 33, and Philo, *Opp.* ii, 817, pecuniary reparation was allowed in such cases likewise). See РУНИЖЕНІЕ.

3. Damage to one's property by cattle (Exod. xxii, 5), or accidental spread of fire in the field (ver. 6), called for full remuneration of the loss (as also among the Romans; see Walter, *Geach. d. Rom. Rechts*, p. 812), and was to be paid for in kind, although a commutation in money certainly might obtain (Philo, *Opp.* ii, 839). For fuller details, see the Talmudic treatise *Baba Kamma*, iv, 1. When a hired animal or article was injured no special restitution was required (Exod. xxii, 15). It was otherwise, however, with property placed in trust. See DEPOSIT. On the jurisdiction of all cases, see ELDER.—Winer, *Realw.* i, 155.

Dam'aris (Δάμαρις), an Athenian woman converted to Christianity by Paul's preaching (Acts xvii, 84), A. D. 48. Chrysostom (*de Sacerdotio*, iv, 7) and others held her to have been the wife of Dionysius the Areopagite, but apparently for no other reason than that she is mentioned together with him in this passage. Grotius and Hemsterhuis think the name should be *Damalis*, Δάμαλις (signifying *heifer*), which is frequently found as a woman's name; but the permutation of λ and ρ was not uncommon both in pronunciation and writing (Lobeck on Phrynichus, p. 652).—Smith, s. v.

Damascene' (Δαμασσηνός), an inhabitant (2 Cor. xi, 32) of the city of Damascus (q. v.).

Damascenus, JOANNES. See JOHN OF DAMASCUS.

Damas'cus (Heb. *Damme'sek*, דַּמְסֵק [sometimes *Darme'sek*, דַּרְמְסֵק, by resolution of the Dagesh, 1 Chron. xviii, 5, 6; once *Dumme'sek*, דִּמְסֵק, probably by erroneous transcription for the last, 2 Kings xvi, 10], signifying *activity* [Gesenius, *Theos.* p. 845 sq.], from its commerce; Arab. *Dimeshik*; Gr. Δαμασκός), one of the most ancient, and at all times one of the most important of Oriental cities. It is called by the natives *Es-Sham*, and is capital of an important pashalic of this latter name, and indeed is the chief or capital city of Syria. It was sometimes spoken of by the ancients as an Arabian city, but in reality it belongs to Syria (Coele-Syria, Strabo xvi, 766; Ptolemy, v, 15, 22). In 2 Sam. viii, 5, 6, "the Syrians of Damascus" are spoken of, and the words "Syria of Da-

mascus" are found in Isa. vii, 8. It is expressly said, "the head of Syria is Damascus;" also, Isa. xvii, 8, "the kingdom" is to cease "from Damascus;" so that this place was obviously the metropolis of a Syrian empire. It gave name (Syria Damascena, Plin. *Hist. Natural.* v, 13) to a district of Syria, which, in 1 Chron. xix, 6, is distinguished as "Syria-Maschah" in the A. V. The city is even mentioned in the cuneiform inscriptions (q. v.). The following account is chiefly from Kitto and Smith, s. v.

1. *Situation*.—Damascus occupies the most beautiful site in Syria, or perhaps in all Western Asia. At the eastern base of Anti-Libanus lies a vast plain, having an elevation of about 2200 feet above the level of the sea. It is bounded on the south by the river Awaj, with its branches, which separates it from Ituræa. On the east a little group of conical hills divides it from the great Arabian desert. Its form is triangular, and its area about 500 square miles. Only about one half of this is now inhabited, or indeed habitable; but in richness and beauty this half is unsurpassed. It owes all its advantages to its rivers (2 Kings v, 12). The plain is about 400 stadia from the Mediterranean, and from six to eight days' journey from Jerusalem. Its celebrity is of early date. Strabo (xvi, p. 766) speaks of it in eulogistic terms. In a religious point of view, also, its repute was great. Julian (*Ep.* 24) terms it "the great and sacred Damascus, surpassing every city both in the beauty of its temples and the magnitude of its shrines, as well as the timeliness of its seasons, the limpidness of its fountains, the volume of its waters, and the richness of its soil." The Abana (q. v.), now called Barada, rising high up on the western flank of Anti-Libanus, forces its way through the chain, running for some time among the mountains, till suddenly it bursts through a narrow cleft upon the open country east of the hills, and diffuses fertility far and wide. "From the edge of the mountain-range," says a modern traveller, "you look down on the plain of Damascus. It is here seen in its widest and fullest perfection, with the visible explanation of the whole secret of its great and enduring charm, that which it must have had when it was the solitary seat of civilization in Syria, and which it will have as long as the world lasts. The river is visible at the bottom, with its green banks, rushing through the cleft; it bursts forth, and as if in a moment scatters over the plain, through a circle of thirty miles, the same verdure which had hitherto been confined to its single channel. . . . Far and wide in front extends the level plain, its horizon bare, its lines of surrounding hills bare, all bare far away on the road to Palmyra and Bagdad. In the midst of this plain lies at your feet the vast lake or island of deep verdure, walnuts and apricots waving above, corn and grass below; and in the midst of this mass of foliage rises, striking out its white arms of streets hither and thither, and its white minarets above the trees which embosom them, the city of Damascus. On the right towers the snowy height of Hermon, overlooking the whole scene. Close behind are the sterile limestone mountains—so that you stand literally between the living and the dead" (Stanley, *Palestine*, p. 402). Another writer mentions among the produce of the plain in question "walnuts, pomegranates, figs, plums, apricots, citrons, pears, and apples" (Addison's *Dam. and Palmyra*, ii, 92). Olive-trees are also a principal feature of the scene. Besides the main stream of the Barada, which runs directly through the town, supplying its public cisterns, baths, and fountains, a number of branches are given off to the right and to the left, which irrigate the meadows and corn-fields, turning what would otherwise be a desert into a garden. These various streams, although greatly weakened in volume, flow on towards the east for about twenty miles, when they pour their waters into two small and shallow lakes, which lie upon the verge of the desert. Two other streams, the



Map of the Vicinity of Damascus.

Wady Helbon upon the north, and the Awaj upon the south, which flows direct from Hermon, increase the fertility of the Damascene plain, and contend for the honor of representing the "Pharpar" (q. v.) of Scripture. The city stands on the banks of the main stream, about two miles distant from, and 500 feet below the pass through which it emerges into the plain. The modern Oriental architecture does not bear close inspection, but when seen from a distance it is singularly imposing. Tapering minarets and swelling domes, tipped with golden crescents, rise up in every direction from the confused mass of white terraced roofs, while in some places their tops gleam like diamonds amid the deep green foliage. In the centre of the city stands the great mosque, and near it the massive towers of the castle.

2. *History.*—According to Josephus (*Ant.* i, 6) Damascus was founded by Uz, the son of Aram, and grandson of Shem. It is first mentioned in Scripture in connection with Abraham, whose steward was a native of the place (*Gen.* xv, 2). We may gather from the name of this person, as well as from the statement of Josephus, which connects the city with the Arameans, that it was a Shemitic settlement. According to a tradition preserved in the native writer Nicolaüs, Abraham staid for some time at Damascus after leaving Charran and before entering the promised land, and during his stay was king of the place. "Abraham's name was," he says, "even in his own day, familiar in the mouths of the Damascenes, and a village was shown where he dwelt, which was called after him" (*Fragm.* 80). This last circumstance would seem, however, to conflict with the notion of Abraham having been king, since in that case he would have dwelt in the capital. In the village of Buseh, three miles north of the city, is a highly venerated shrine, called for the last eight centuries "the house of Abraham." (On these fables, see Julian, *Epist.* 24, p. 892; Collarii *Notitia*, ii, 442 sq.; Mannert, VI, i, 407 sq.; Justin, xxxvi, 2; Isidorus, *Orig.* xv, 1; D'Herbelot, *Biblioth. Or.* i, 70.) See ABRAHAM.

Nothing more is known of Damascus until the time of David, when "the Syrians of Damascus came to succor Hadadezer, king of Zobah," with whom David was at war (2 Sam. viii, 5; 1 Chron. xviii, 5). On this occasion David "slew of the Syrians 22,000 men," and in consequence of this victory became completely

master of the whole territory, which he garrisoned with Israelites. "David put garrisons in Syria of Damascus; and the Syrians became servants to David, and brought gifts" (2 Sam. viii, 6). Nicolaüs of Damascus said that the name of the king who reigned at this time was Hadad; and he ascribes to him a dominion not only over Damascus, but "over all Syria except Phœnicia" (*Fragm.* 81). He noticed his *stad* upon David, and related that many battles were fought between them, the last, wherein he suffered defeat, being "upon the Euphrates." According to this writer, Hadad the first was succeeded by a son, who took the same name, as did his descendants for ten generations. But this is irreconcilable with Scripture (see Müller, *Origo regni Damasc.* Lips. 1714; also in *Ikenii Theaur.* i, 721 sq.). It appears that in the reign of Solomon a certain Rezon, who had been a subject of Hadadezer, king of Zobah, and had escaped when David conquered Zobah, made himself master of Damascus, and established his own rule there (1 Kings xi, 28-5). He was "an adversary to Israel all the days of Solomon . . . and he abhorred Israel, and reigned over Syria" (Joseph. *Ant.* viii, 7, 6). Afterwards the family of Hadad appears to have recovered the throne, and a Benhadad, who is probably Hadad III of Nicolaüs, a grandson of the antagonist of David, is found in league with Baasha, king of Israel, against Ass (1 Kings xv, 19; 2 Chron. xvi, 8), and afterwards in league with Ass against Baasha (1 Kings xv, 20). He made a successful invasion of the Israelitish territory in the reign of that king; and in the reign of Omri he not only captured a number of Israelitish cities, which he added to his own dominions, but even seems to have exercised a species of lordship over Samaria itself, in which he acquired the right of "making himself streets" (1 Kings xx, 84; comp. Nic. D. *Fragm.* 81, ad fin.). He was succeeded by his son, Hadad IV (the Benhadad II of Scripture, and the Ben-idri of the Assyrian inscriptions), who came at the head of thirty-two subject kings against Ahab, and laid siege to Samaria (1 Kings xx, 1). The attack was unsuccessful, and was followed by wars, in which victory declared itself unmistakably on the side of the Israelites; and at last Benhadad was taken prisoner, and forced to submit to a treaty whereby he gave up all that his father had gained, and submitted in his turn to the suzerainty of Ahab (*ib.* xx, 18-34). The terms of the

ty were perhaps not observed. At any rate, three years afterwards war broke out afresh, through the man of Ahab to the city of Ramoth-Gilead (1 Kings i, 1-4). The defeat and death of Ahab at that time (ib. 15-37) seems to have enabled the Syrians to resume the offensive. Their bands ravaged the lands of Israel during the reign of Jehoram; they even undertook at this time a second siege of Samaria, which was frustrated miraculously (2 Kings vi, 24; vii, 6-7). After this, we do not hear any more attempts against the Israelitish capital. The cuneiform inscriptions show that towards the close of his reign Benhadad was exposed to the assaults of a great conqueror, who was bent on extending the dominion of Assyria over Syria and Palestine. Several attacks appear to have been made by a prince upon Benhadad, who, though he had the support of the Phœnicians, the Hittites, and the Hittites, was unable to offer any effectual opposition to the Assyrian arms. His troops were worsted in several engagements, and in one of them he lost as many as 20,000 men. It may have been these circumstances which encouraged Hazael, the servant of Benhadad, to murder him and seize the throne, which Hazael had declared would certainly one day be his (2 Kings viii, 15). He may have thought that the Syrians would willingly acquiesce in the removal of a ruler under whom they had suffered so many disasters. The change of rulers was not at first productive of any advantage to the Syrians. Shortly after the accession of Hazael (about B.C. 884), he was in his turn attacked by the Assyrians, who defeated him with great loss and the fastnesses of Anti-Libanus. However, in his later wars he was more fortunate. He repulsed an attack on Ramoth-Gilead, made by Abaziah, king of Judah, and Jehoram, king of Israel, in conjunction (2 Kings xviii, 28-9); ravaged the whole Israelitish territory east of Jordan (ib. x, 32-3); besieged and took Damascus (ib. xii, 17; compare Amos vi, 2); threatened Jerusalem, which only escaped by paying a heavy ransom (2 Kings xvii, 18); and established a species of suzerainty over Israel, which he maintained to the day of his death, and handed down to Benhadad, his son (2 Kings xiii, 8-7, and 2). This prince, in the earlier part of his reign, had the same good fortune as his father. Like him, he "oppressed Israel," and added various cities of the Israelites to his own dominion (2 Kings xiii, 25); but at last a deliverer appeared (ver. 5), and Joash, the son of Jehoahaz, "beat Hazael thrice, and recovered the cities of Israel" (ver. 25).

In the next reign still further advantages were gained by the Israelites. Jeroboam II (B.C. cir. 886) is said to have "recovered Damascus" (ib. xiv, 28), and though this may not mean that he captured the city, it at least implies that he obtained a certain influence over it. The mention of this circumstance is followed by a long pause, during which we hear nothing of the Syrians, and must therefore conclude that their relations with the Israelites continued peaceable. See BENHADAD. When they reappear, nearly a cen-

tury later (B.C. cir. 742), it is as allies of Israel against Judah (2 Kings xv, 37). We may suspect that the chief cause of the union now established between two powers which had been so long hostile was the necessity of combining to resist the Assyrians, who at the time were steadily pursuing a policy of encroachment in this quarter. Scripture mentions the invasions of Pul (2 Kings xv, 19; 1 Chron. v, 26), and Tiglath-Pileser (2 Kings xv, 29; 1 Chron. v, 26); and there is reason to believe that almost every Assyrian monarch of the period made war in this direction. It seems to have been during a pause in the struggle that Rezin, king of Damascus, and Pekah, king of Israel, resolved conjointly to attack Jerusalem, intending to depose Ahaz and set up as king a creature of their own (Isa. vii, 1-6; 2 Kings xvi, 5). Ahaz may have already been suspected of a friendly feeling towards Assyria, or the object may simply have been to consolidate a power capable of effectually opposing the arms of that country. In either case the attempt signally failed, and only brought about more rapidly the evil against which the two kings wished to guard. Jerusalem successfully maintained itself against the combined attack; but Elath, which had formerly been built by Azariah, king of Judah, in territory regarded as Syrian (2 Kings xiv, 22), having been taken and retained by Rezin (ib. xvi, 6), Ahaz was induced to throw himself into the arms of Tiglath-Pileser, to ask aid from him, and to accept voluntarily the position of an Assyrian feudatory (ib. xvi, 7-8). The aid sought was given, with the important result that Rezin was slain, the kingdom of Damascus brought to an end, and the city itself destroyed, the inhabitants being carried captive into Assyria (ib. ver. 9; comp. Isa. vii, 8, and Amos i, 5). Among the sculptures lately discovered on the site of Nineveh are thought to be delineations of this siege and capture of Damascus. Rawlinson even reads the name of the city on an obelisk connected with them (Bonomi, *Nineveh*, p. 284 sq.). Assyrian remains have lately been discovered in a mound near Damascus (*Journal of Sa-*



Final Assault of Damascus. From the Assyrian Monuments.



Captivity of the Inhabitants. From the same.

It was long before Damascus recovered from this serious blow. As Isaiah and Amos had prophesied in the day of her prosperity that Damascus should be "taken away from being a city and be a ruinous heap" (Isa. xvii, 1), that "a fire should be sent into the house of Hazael which should devour the palaces of Benhadad" (Amos i, 4), so Jeremiah, writing about B.C. 600, declares "Damascus is waxed feeble and turneth herself to flee, and fear hath seized on her; anguish and sorrows have taken her as a woman in travail. How is the city of praise not left, the city of my joy!" (Jer. xlix, 24-5). Damascus remained a province of Assyria until the capture of Nineveh by the Medes (B.C. 625), when it submitted to the conquerors. Its wealth and commercial prosperity appear to have declined for a considerable period, probably on account of the ravages of Tiglath-Pileser, and the captivity of the most influential and enterprising of its people. The city was afterwards held in succession by the Egyptians, Babylonians, and Persians. We have no particulars of its history for a period of three centuries. Under the rule of the Persians it was the capital of the province of Syria, and the residence of the satrap. We do not know at what time Damascus was rebuilt, but Strabo says that it was the most famous place in Syria during the Persian period (xvi, 2, § 19). When Darius, the last king of Persia, made his great effort to repress the rising power, and bar the progress of Alexander of Macedon, it was in this city he deposited his family and treasures (Arrian, *Exp. Al.* ii, 11). The fate of Damascus, with that of all Western Asia, was decided by the battle of Issus, in which the Persian army was almost annihilated. Damascus now became the capital of a province which Alexander gave to his general Laomedon (Plut. *Vit. Alexandri*). During the long wars which raged between the Seleucids and the Ptolemies, Damascus had no separate history: it sometimes fell to the one, and sometimes to the other. Antioch was founded, and became their favorite residence, and the capital of the Seleucids; but when the Syrian kingdom was divided in B.C. 126, Damascus was made the second capital. Its territory embraced Cœle-Syria, Phœnicia, and the country east of the Jordan, and it was afterwards governed in succession by four princes of the family of Seleucus. Damascus and Antioch thus became the seats of rival factions, and aspirants after complete sovereignty (Joseph. *Ant.* xiii, 18, 4, and 15, 1). The last of these princes, Antiochus Dionysus, was killed in battle against Aretas, king of Arabia, and the Damascenes forth with elected Aretas his successor (Josephus, *Ant.* xiii, 15, 1), B.C. 84. In the year B.C. 64, the Romans, under Pompey, invaded and captured Syria, constituted it a province of the empire, and made Damascus the seat of government (*ib.* xiv, 2, 3, and 4, 5; Moe. Choren. i, 14; Appian, *Bell. Mithrid.* p. 224). From Josephus (*War*, i, 2; xxv, 2; xx, 2; comp. Acts ix, 2) it appears that its population contained great numbers of Jews.



Coin of Damascus.

For twenty years Damascus continued to be the residence of the Roman procurators. The city prospered under their firm and equitable rule, and even after their removal to Antioch did not decline. Strabo, who flourished at this period, describes it as one of the most magnificent cities of the East. Nicolaus, the famous historian and philosopher, the friend of Herod

the Great and Augustus, was now one of its citizens (Strabo, *Geogr.* xvi; Josephus, *Ant.* xvi, 16, 6). The strong arm of Rome was not sufficient to quell the fiery spirit of the Syrians. The whole country went into factions, and embroiled by the unceasing rivalries and wars of petty princes. About the year A.D. 37, a family quarrel led to a war between Antipater, king of Arabia, and Herod Antipas. The Roman governor, Vitellius, was instructed to interfere in favor of the latter; but when he was ready to attack Antipater, who had already driven back Herod, news arrived of the death of the emperor Tiberius. The government of Syria was thus thrown into confusion, and Vitellius returned to Antioch (Joseph. *Ant.* xviii, 5, 1-5). It appears that now Aretas, taking advantage of this state of affairs, followed up his successes, advanced upon Damascus, and seized the city. It was during his brief rule (or some earlier one) that Paul visited Damascus on his return from Arabia (Gal. i, 17). See ARETAS. His zeal as a missionary, and the energy with which he opposed every form of idolatry, had probably attracted the notice and excited the enmity of Aretas; and consequently, when informed by the Jews that the apostle had returned to the city, he was anxious to secure him, and gave orders to the governor to watch the gates day and night for that purpose (Acts ix, 24; 2 Cor. xi, 32. See *Narrative of the Planting and Training of the Christian Church*, i, 101). The Romans adorned Damascus with many splendid buildings, the ruins of which still exist. Some of them were probably designed by Apollodorus, a native of the city, and one of the most celebrated architects of his age, to whose genius we are indebted for one of the most beautiful monuments of ancient Rome, the Column of Trajan (Dion Cass. lxxix). A little later it was reckoned to Decapolis (Plin. *Hist. Nat.* v, 16), after which it became a part of the province known as Phœnicia-Libanesia (Hierocl. *Syneccl.* p. 717).

Christianity was planted in Damascus by Paul himself (Acts ix, 20 sq.; Gal. i, 12), and obtained a firm footing in the apostolic age. It spread so rapidly among the population that in the time of Constantine the great temple, one of the noblest buildings in Syria, was converted into a cathedral church and dedicated to John the Baptist. When the first general council assembled at Nice, Magnus, the metropolitan of Damascus, was present with seven of his suffragans. But the Roman empire was now waxing feeble, and the religion which, by its establishment as a national institute, ought to have infused the germ of a new life into the declining state, was itself losing its purity and its power. Damascus felt, like other places, the demoralizing tendencies of a corrupt faith. In the beginning of the 7th century a new and terrible power appeared upon the stage of the world's history, destined, in the hands of an all-wise though mysterious Providence, to overthrow a degenerate empire and chastise an erring Church. In A.D. 634 Damascus opened its gates to the Mohammedans, and thirty years later the first caliph of the Omeiads transferred the seat of his government to that city. It now became for a brief period the capital of a vast empire, including Syria, Mesopotamia, Persia, Northern Africa, and Spain (Elmacin, *Hist. Sarac.* xiii). In A.D. 750 the Omeiads were supplanted by the dynasty of Abbases, and the court was removed to Bagdad. A stormy period of four centuries now passed over the old city without leaving a single incident worthy of special note. An attack of the Crusaders (A.D. 1148), under the three chiefs, Baldwin, Conrad, and Louis VII. might have claimed a place here had it not been so disgraceful to the Christian arms. It is enough to say that the cross never displaced the crescent on the battlements of Damascus. The reigns of Nureddin and his more distinguished successor Saladin form bright epochs in the city's history. Two centuries later came Timur, who literally swept Damascus with "the beam

struction." Arab writers sometimes call him *el-ash*, "the wild beast," and he fully earned that name. Never had Damascus so fearfully experienced horrors of conquest. Its wealth, its famed manufactures, and its well-filled libraries, were all dissipated in a single day. It soon regained its opulence. A century later it fell into the hands of the Turks, and, with the exception of the brief rule of Ibrahim sha, it has ever since remained nominally subject to sultan.

The Mohammedan population of Damascus have long been known as the greatest fanatics in the East. The steady advance of the Christian community in wealth and influence during the last thirty years has led to excite their bitter enmity. In July, 1860, taking advantage of the war between the Druses and ironites, and encouraged also by the Turkish authorities, they suddenly rose against the poor defenceless Christians, massacred about 6000 of them in cold blood, and left their whole quarter in ashes! Such is the last act in the long history of Damascus. (There is a work by Pieritz on the *Persecution of the Jews at Damascus*, Lond. 1840.) Damascus is still the largest city in Asiatic Turkey. It contained in 1859 a population of about 150,000. Of these, 6000 were Jews and 10,000 Christians. The Christian community has since been almost exterminated by the above massacre of the greater portion of the males. The pasha ranks with the first officers of the empire, and the city is the head-quarters of the Syrian army.

3. *Commerce*.—Damascus has always been a great centre for trade. The difficulties and dangers of the mountain passes to the west of Anti-Libanus made the line of traffic between Egypt and Upper Syria follow the circuitous route by Damascus rather than the direct one through Cœle-Syria, while the trade of Tyre with Assyria and the East generally passed naturally through Damascus on its way to Palmyra and the Euphrates. Ezekiel, speaking of Tyre, says, "Damascus was thy merchant in the multitude of the wares of thy making, for the multitude of all riches; in the wine of Helbon and white wool." It would appear from this that Damascus took manufactured goods from the Phœnicians, and supplied them in exchange with wool and wine. The former would be produced in abundance in Cœle-Syria and the valleys of the Anti-Libanus range, while the latter seems to have been grown in the vicinity of HELBON, a village still famous for the produce of its vines, ten or twelve miles from Damascus to the north-west (*Geograph. Jour.* xxvi, 44). But the passage-trade of Damascus has probably been at all times more important than its direct commerce. Its merchants must have profited largely by the caravans which continually passed through it on their way to distant countries. It is uncertain whether in early times it had any important manufactures of its own. According to some expositors, the passage in Amos iii, 12, which we translate "in Damascus on a couch" (בִּדְמֶשֶׁק עַל כִּסֵּי), means really "on the *damaak* couch," which would indicate that the Syrian city had become famous for a textile fabric as early as the eighth century B.C. There is no doubt that such a fabric gave rise to our own word, which has its counterpart in Arabic as well as in most of the languages of modern Europe; but it is questionable whether either this, or the peculiar method of working in steel, which has impressed itself in a similar way upon the speech of the world, was invented by the Damascenes before the Mohammedan era. In ancient times they were probably rather a consuming than a producing people, as the passage in Ezekiel clearly indicates. It afterwards became famous for its sword-blades and cutlery; but its best workmen were carried off by Timur to Ispahan. Its chief manufactures are, at present, silks, coarse woollen stuffs, cottons, gold and silver ornaments, and arms. The bazaars are stocked with the

products of nearly all nations—Indian mudlins, Manchester prints, Persian carpets, Lyons' silks, Birmingham cutlery, Cashmere shawls, Mocha coffee, and Dutch sugar.

4. *Topography, Antiquities, etc.*—The old city, the nucleus of Damascus, stands on the south bank of the river, and is surrounded by a tottering wall, the foundations of which are Roman, and the superstructure a patchwork of all succeeding ages. It is of an irregular oval form. Its greatest diameter is marked by the "street called *Straight*," which intersects it from east to west, and is about a mile long. This street was anciently divided into three avenues by Corinthian colonnades, and at each end were triple Roman gateways, still in a great measure entire. In the old city were the Christian and Jewish quarters, and the principal buildings and bazaars. On the north, west, and south are extensive suburbs. The internal aspect of the city is not prepossessing, and great is the disappointment of the stranger when he leaves the delicious environs and enters the gates. Without, nature smiles joyously, the orchards seem to blush at their own beauty, and the breeze is laden with perfumes. Within, all is different. The works of man show sad signs of neglect and decay. The houses are rudely built; the lanes are paved with big rough stones, and partially roofed with ragged mats and withered branches; long-bearded, fanatical-visaged men squat in rows on dirty stalls, telling their beads, and mingling, with muttered prayers to Allah and his prophet, curses deep and terrible on all infidels. The bazaars are among the best in the East. See BAZAAR. They are narrow covered lanes, with long ranges of open stalls on each side; in these their owners sit as stiff and statue-like as if they had been placed there for show. See MERCHANT. Each trade has its own quarter. Every group in the bazaars would form a lively picture. All the costumes of Asia are there, strangely grouped with panniered donkeys, gayly-caparisoned mules, and dreamy-looking camels. The principal *khans* or caravansaries are spacious buildings. They are now used as stores and shops for the principal merchants. The great *khan*, Asad Pasha, is among the finest in Turkey. A noble Saracenic portal opens on a large quadrangle, ornamented with a marble fountain, and covered by a series of domes supported on square pillars. Many of the *mosques* are fine specimens of Saracenic architecture. Their deeply-moulded gateways are very beautiful, and the interlaced stone-work around doors and windows is unique. They are mostly built of alternate layers of white and black stone, with string courses of marble arranged in chaste patterns. But they are all badly kept, and many of them are now ruinous.

The *private houses* of Damascus share, with the plain, the admiration of all visitors. No contrast could be greater than that between the outside and inside. The rough mud-walls and mean doors give poor promise of taste or beauty within. The entrance is always through a narrow winding passage—sometimes even a stable-yard—to the "outer court," where the master has his reception-room, and to which alone male visitors are admitted. Another winding passage leads to the *harem* (q. v.), which is the principal part of the house. Here is a spacious court, with tessellated pavement, a marble basin in the centre, *jets d'eau* around it, orange, lemon, and citron trees, flowering shrubs, jessamines and vines trained over trellis-work for shade. The rooms all open on this court, intercommunication between room and room being almost unknown. On the south side is an open alcove, with marble floor and cushioned dais. The decorations of some of the rooms is gorgeous. The walls of the older houses are wainscoted, carved, and gilt, and the ceilings are covered with arabesque ornaments. In the new houses painting and marble fretwork are taking the place of arabesque and wainscoting.

The principal building of Damascus is the *Great Mosque*, the domes and minarets of which are everywhere conspicuous. It occupies one side of a large quadrangular court, flagged with marble, arranged in patterns, and ornamented with some beautiful fountains. Within the mosque are double ranges of Corinthian columns supporting the roof, in the style of the old basilicas. The walls were once covered with mosaic, representing the holy places of Islam; but this is nearly all gone. In the centre is a spacious dome. The building was anciently a temple, with a large cloistered court, like the Temple of the Sun at Palmyra. In the time of Constantine it was made a church and dedicated to John the Baptist, whose head was said to be deposited in a silver casket in one of the crypts. In the 7th century the Moslems took possession of it, and it has since remained the most venerated of their mosques. It is a singular fact, however, that though it has now been for twelve centuries in possession of the enemies of our faith, though during the whole of that period no Christian has ever been permitted to enter its precincts, yet over its principal door is an inscription embodying one of the grandest and most cheering of Christian truths (Psa. cxlv, 18).

The *Castle* is a large quadrangular structure, with high walls and massive flanking towers. It is now a mere shell, the whole interior being a heap of ruins. The foundations are at least as old as the Roman age. It stands at the north-west angle of the ancient wall.

The *traditional sacred places* of Damascus are the following: A "long, wide thoroughfare"—leading direct from one of the gates to the castle or palace of the pasha—is "called by the guides 'Straight'" (Acts ix, 11); but the natives know it among themselves as "the Street of Bazaars" (Stanley, p. 404). The house of Judas is shown, but it is not in the street "Straight" (Pococke, ii, 119). That of Ananias is also pointed out. The scene of the conversion is confidently said to be "an open green spot, surrounded by trees," and used as the Christian burial-ground; but this spot is on the eastern side of the city, whereas Paul must have approached from the south or west. Again it appears to be certain that "four distinct spots have been pointed out at different times" (Stanley, p. 403) as the place where the "great light suddenly shined from heaven" (Acts ix, 8). The point of the walls at which St. Paul was let down by a basket (Acts ix, 25; 2 Cor. xi, 33) is also shown; and it is a fact that houses are still constructed in Damascus in like manner overhanging the wall. In the vicinity of Damascus certain places are shown traditionally connected with the prophet Elisha; but these local legends are necessarily even more doubtful than those which have reference to the comparatively recent age of the apostles. There are even spots pointed out as the scene of events in the life of Abraham (Stanley, p. 404).

The climate of Damascus is healthful except during July, August, and September, when fevers and ophthalmia are prevalent, engendered by filth and unwholesome food. The thermometer ranges from 80° to 87° Fahr. during the summer, and seldom falls below 45° in winter. There is usually a little snow each year. The rain begins about the middle of October, and continues at intervals till May. The rest of the year is dry and cloudless.

A full description of Damascus, with notices, plans, and drawings, is given in *Porter's Five Years in Damascus* (Lond. 1855, 2 vols. 8vo); and in the *Jour. Sac. Lit.* July, 1858, p. 245 sq.; Oct. 1858, p. 45 sq.; see also Addison's *Damascus and Palmyra* (ii, 92-196); Walch, *Antiquitates Damasc. illustrata* (Jen. 1757 [a copious treatise, giving all facts known in his day]; also in his *Acta Apostol.* ii, 81 sq.); Kelly, *Syria* (chap. xv), and travellers in Palestine generally. See SYRIA.

Damascus, JOHN OF. See JOHN OF DAMASCUS.

Damaskios, one of the last eclectic philosophers,

was a native of Damascus, studied in Alexandria, Athens, and taught the Neo-Platonic philosophy in the latter city. In consequence of the persecuting paganism by the emperor Justinian, Damaskios, 529, emigrated to Persia, where he was well received by Khosroes, who, at the treaty of peace in 532, obtained for him permission to return and freedom of his religious belief. He is the author of a number of works, the most important of which is entitled, *Ἀρχαῖα* (edited by J. Kopp, Frankfurt, 1826). On his life and opinions, see Kopp, preface to the above; and Jules Simon in *Dictionnaire des Sciences Philosophiques*.—Hoefler, *Biog. Générale*, xii, 842.

Damasus I, pope, born in Spain (others say Rome) A.D. 306, succeeded Liberius as bishop of Rome A.D. 366. He was opposed by Ursicinus, who had obtained the election, and in their disgraceful strife many people were murdered. He was a man of vigorous intellect, and extended the power of the see of Rome very greatly. The emperor Gratian conferred upon him, in 378, the right to pass judgment upon the clergymen of the other party who had been expelled from Rome, and, at the request of a Roman synod in the same year, instructed the secular authorities to give to him the necessary support. Damasus was a vigorous opponent of Arianism; a synod held by him in 368 condemned the two Illyrian bishops Ursacius and Valens, and another, held in 370, passed sentences against Auxentius of Milan. He also exerted himself for putting an end to the Antioch schism, and took part in the Ecumenical Council of Constantinople in 381. One of his best acts was to make Jerome secretary, and to aid him in his version of the Bible. He died in 384, and after his death was soon enrolled in the catalogue of saints, being commemorated Dec. 11. See *Damasi Opera*, edited by Merdani (Rome, 1754, fol.; Paris, 1840, 8vo); Mosheim, *Ch. Hist.* iii, cent. iv, pt. ii, ch. ii, note 40; Milman, *Hist. of Lat. Christianity*, i, 108 sq.; *Christian Remembrancer*, Oct. 1854, 288 sq.

Damasus II, pope, originally Poppo, a native of Bavaria. He was bishop of Brixen when he was elected pope in 1048, upon the recommendation of the emperor Henry III, on the day of the abdication of Benedict IX, and died twenty-three days after his election, 1048.

Damian (DAMIANS or DAMIANI), PETER, an eminent cardinal and reformer in the Roman Church, born at Ravenna about 1007. His parents appear to have taken much pains with his education, for he early excelled as much in piety as he did in learning. When he had completed his studies, he entered the monastery of the "Holy Cross" at Avellana, in Umbria. So high was his reputation that pope Stephen IX created him cardinal bishop of Ostia. In A.D. 1061 he resigned all his preferments, which at the first he had been forced upon him, being unable to live with such a dissolute, debauched, and unholy crew as the clergy of those parts and times were. In the year 1069 he was sent as legate to prevent the emperor Henry from being divorced from his wife Bertha. His last public employment was in A.D. 1072, when he was commissioned to dissolve the excommunication under which his natal city Ravenna had lain for several years. He died of a fever at Faenza on February 23, 1072, aged 66 years. His acts and his writings, which are numerous, tended much to the enlargement and consolidation of the papal power; yet he does not seem to have been at all a party man, but to have proceeded in a direct and honest course, which led him, on the whole, to the support of that doctrine which then prevailed. Not one of his least merits with the Romish Church would be that he was the first who required his monks to recite the Office of the Virgin; but that Church should also recollect that he strongly deprecates the use of temporal weapons for the

ease of spiritual power. Altogether Damian was among the foremost men of his age, both morally and intellectually. His works were collected by Cajetan me, 1606-1615, 3 vols. fol.), and have been several times reprinted; the best edition is that of Bassani 18, 4 vols. fol.). His life is given in the first vol. of his works; also in *Vita P. Damiani*, by Valleri (Rome, 1702, 4to); and in the *Acta Sanctorum*, .iii, 406 sq. See Dupin, *Eccles. History*, vol. ix, ch. 4; Mosheim, *Ch. Hist.*, bk. iii, c. xi, pt. ii, chap. ii, n. Bayle, *Dictionary*, s. v.; Clarke, *Succ. of Sacred Nature*, ii, 608; Schröckh, *Kirchengeschichte*, xxii, sq.; Lea, *Sacerdotal Celibacy* (1867), chap. xii.

Damianists or Damianites. The followers of Paganus of Alexandria (q. v.) were so called.

Damiānus, Monophysite patriarch of Alexandria 501, expressed himself on the doctrine of the Trinity in a sense similar to that of Sabellius. He maintained that the divinity (θεότης) of the Father, the Son, and the Holy Ghost is an essential characteristic (αὐξίς) divided among the three, so that they are only in their unity, not each one in himself (καθ' ἑαυτὸν), and that in this unity they constitute the one divine essence (μία οὐσίαν καὶ φύσιν). His followers were called Damianites, after him, or Angelists, or Angelium, the place where they held their assemblies in Alexandria; their adversaries were called Teists (Τεοδῖται), as, going still further than the theists, they acknowledged four gods, namely, the Father, the Son, the Holy Ghost, and the higher Being; which, in his nature (φύσει) and in himself (καθ' ἑαυτὸν), is God.—Herzog, *Real-Encyclopädie*, iii, 268; Rhein, *Ch. History*, bk. ii, ch. vi, pt. ii, § 4; Hagenh., *Hist. of Doctrines*, § 96.

Damianus, St. See COSMAS.

Damin. See ADAMI.

Dammim. See EPHES-DAMMIM.

Damnation, condemnation. This word is used to denote the final loss of the soul, but it is not always understood in this sense in the sacred Scripture. As it is said in Rom. xiii, 2, "They that resist shall receive to themselves damnation," i. e. condemnation, from the rulers, who are not a terror to good works, but to the evil." Again, in 1 Cor. xi, 29, "He that eateth and drinketh unworthily, eateth and drinketh damnation to himself," i. e. condemnation; exposes himself to severe temporal judgments from God, and the judgment and censure of the wise and good man, Rom. xiv, 23, "He that doubteth is damned if he eat," i. e. is condemned both by his own conscience and the word of God, because he is far from being satisfied that he is right in so doing.—Buck, *Theol. Dictionary*, s. v.

Dan (Heb. דָּן, a judge; Sept. Δάν), the name of a man and his tribe and of two towns. See MAHARDAN; DAN-JAAN.

1. (Josephus translates θεόκριτος, *Ant.* i, 19, 8.) the fifth son of Jacob, and the first of Bilhah, Rachel's maid (Gen. xxx, 6), born B.C. 1916. The origin of his name is there given in the exclamation of Rachel "God hath judged me (דָּן, דָּנָא) . . . and given me a son," therefore she called his name Dan," i. e. "judge." In the blessing of Jacob (Gen. xlix, 1) this play on the name is repeated—"Dan shall judge (דָּן, דָּנָא) his people." Dan was own brother to Naphtali; and, as the son of Rachel's maid, a closer relation with Rachel's sons, Joseph and Benjamin, than with the other members of the family. It may be noticed that there is a close affinity between his name and that of DINAH, the only daughter of Jacob. See JACOB.

TRIBE OF DAN.—Only one son is attributed to this patriarch (Gen. xli, 23); but it may be observed that Hushim is a plural form, as if the name, not of an

individual, but of a family; and it is remarkable—whether as indicating that some of the descendants of Dan are omitted in these lists, or from other causes—that when the people were numbered in the wilderness of Sinai, this was, with the exception of Judah, the most numerous of all the tribes, containing 62,700 men able to serve. The position of Dan during the march through the desert was on the north side of the tabernacle (Num. ii, 25). Here, with his brother Naphtali, and Asher, the son of Zilpah, before him, was his station, the hindmost of the long procession (ii, 31; x, 25). The names of the "captain" (נָשִׂיף) of the tribe at this time, and of the "ruler" (the Hebrew word is the same as before), who was one of the spies (xiii, 12), are preserved. So also is the name of one who played a prominent part at that time, "Aholiab, the son of Ahisamach, of the tribe of Dan," associated with Bezaleel in the design and construction of the fittings of the tabernacle (Exod. xxxi, 6, etc.). The numbers of this tribe were not subject to the violent fluctuations which increased or diminished some of its brethren (comp. the figures given in Num. i and xxvi), and it arrived at the threshold of the Promised Land, and passed the ordeal of the rites of Baal-peor (Num. xxv) with an increase of 1700 on the earlier census. The remaining notices of the tribe before the passage of the Jordan are unimportant. It furnished a "prince" (נָשִׂיף, as before) to the apportionment of the land; and it was appointed to stand on Mount Ebal, still in company with Naphtali (but opposite to the other related tribes), at the ceremony of blessing and cursing (Deut. xxvii, 18).

After this nothing is heard of Dan till the specification of the inheritance allotted to him (Josh. xix, 48). He was the last of the tribes to receive his portion, and that portion, according to the record of Joshua—strange as it appears in the face of the numbers just quoted—was the smallest of the twelve. But, notwithstanding its smallness, it had eminent natural advantages. On the north and east it was completely embraced by its two brother tribes Ephraim and Benjamin, while on the south-east and south it joined Judah, and was thus surrounded by the three most powerful states of the whole confederacy. Of the towns enumerated as forming "the border" of its inheritance, the most easterly which can now be identified are Ajalon, Zorah (Zareah), and Ir-Shemesh (or Beth-shemesh, q. v.). These places are on the slopes of the lower ranges of hills by which the highlands of Benjamin and Judah descend to the broad maritime plain, that plain which on the south bore the distinctive name of "the Shefelah," and more to the north, of "Sharon." From Japho—afterwards Joppa, and now Yāfa—on the north, to Ekron and Gathrimmon on the south—a length of at least fourteen miles—that noble tract, one of the most fertile in the whole of Palestine, was allotted to this tribe. By Josephus (*Ant.* v, 1, 22, and 8, 1) this is extended to Ashdod on the south, and Dor, at the foot of Carmel, on the north, so as to embrace the whole, or nearly the whole, of the great plain, including Jamnia and Gath. (This discrepancy may be accounted for by supposing that the Danites at some period may have overrun the country thus far, when the Philistines were humbled by the powerful Ephraimites and the still more powerful David.) But this rich district, the corn-field and the garden of the whole south of Palestine, which was the richest prize of Phœnician conquest many centuries later, and which, even in the now degenerate state of the country, is enormously productive, was too valuable to be given up without a struggle by its original possessors. The Amorites accordingly "forced the children of Dan into the mountain, for they would not suffer them to come down into the valley" (Judg. i, 34)—forced them up from the corn-fields of the plain, with their deep black soil, to the villages whose ruins

still crown the hills that skirt the lowland. True, the help of the great tribe so closely connected with Dan was not wanting at this juncture, and "the hand of the children of Joseph," i. e. Ephraim, "prevailed against the Amorites" for the time. But the same thing soon occurred again, and in the glimpse with which we are afterwards favored into the interior of the tribe, in the history of its great hero, the Philistines have taken the place of the Amorites, and with the same result. Although Samson "comes down" to the "vineyards of Timnath" and the valley of Sorek, yet it is from Mahaneh-Dan—the fortified camp of Dan, between Zorah and Eshtaol, behind Kirjath-jearim—that he descends, and it is to that natural fastness, the residence of his father, that he "goes up" again after his encounters, and that he is at last borne to his family sepulchre, the burying-place of Manoah (Judg. xiv, 1, 5, 19; xiii, 25; xvi, 4; comp. xviii, 12; xvi, 31). It appears from that history that there was an under-current of private and social intercourse between the Philistines and the Danites, notwithstanding the public enmity between Israel and the former (Judg. xiii-xvi).

These considerations enable us to understand how it happened that long after the partition of the land "all the inheritance of the Danites had not fallen to them among the tribes of Israel" (Judg. xviii, 1). They perhaps furnish a reason for the absence of Dan from the great gathering of the tribes against Sisera (Judg. v, 17). They also explain the warlike and independent character of the tribe betokened in the name of their head-quarters, as just quoted—Mahaneh-Dan, "the camp, or host, of Dan"—in the fact specially insisted on and reiterated (xviii, 11, 16, 17) of the complete equipment of their 600 warriors "appointed with weapons of war," and the lawless freebooting style of their behavior to Micah. There is something very characteristic in the whole of that most fresh and interesting story preserved to us in Judg. xviii—a narrative without a parallel for the vivid glance it affords into the manners of that distant time—characteristic of boldness and sagacity, with a vein of grim sardonic humor, but undeformed by any unnecessary bloodshed.

In the "security" and "quiet" (Judg. xviii, 7, 10) of their rich northern possession the Danites enjoyed the leisure and repose which had been denied them in their original seat. But of the fate of the city to which they gave "the name of their father" (Josh. xix, 47), we know scarcely anything. The strong religious feeling which made the Danites so anxious to ask counsel of God from Micah's Levite at the commencement of their expedition (Judg. xviii, 5), and afterwards take him away with them to be "a priest unto a tribe and a family in Israel," may have pointed out their settlement to the notice of Jeroboam as a fit place for his northern sanctuary. But beyond the exceedingly obscure notice in Judg. xviii, 80, we have no information on this subject. From 2 Chron. ii, 14, it would appear that the Danites had not kept their purity of lineage, but had intermarried with the Phenicians of the country. (See an elaboration of this in *Blunt, Coincidences*, pt. ii, ch. iv.)

In the time of David Dan still kept its place among the tribes (1 Chron. xii, 35). Asher is omitted, but the "prince of the tribe of Dan" is mentioned in the list of 1 Chron. xxvii, 22. But from this time forward the name as applied to the tribe vanishes; it is kept alive only by the northern city. In the genealogies of 1 Chron. ii to xii Dan is omitted entirely, which is remarkable when the great fame of Samson and the warlike character of the tribe are considered, and can only be accounted for by supposing that its genealogies had perished. It is perhaps allowable to suppose that little care would be taken to preserve the records of a tribe which had left its original seat near the head-quarters of the nation, and given its name to

a distant city notorious only as the seat of a rival and a forbidden worship. Lastly, Dan is omitted from the list of those who were sealed by the angel in the vision of John (Rev. vii, 5-7).—Smith, *Dict. of Bible*. Perhaps the portion of the tribe which remained was in time amalgamated with the tribe of Judah, as appears in the cities enumerated after the exile (Ezra xi, 35), while the northern section united with the northern confederacy, and shared in its dispersion.



Map of the Tribe of Dan.

The following is a list of all the places in the Bible of Dan mentioned in Scripture, with their probable identification:

Ajalon.	Town.	Yalo.
Allon.	do.	See ELON.
Arimathaea.	do.	Ramath?
Ataroth-Joab.	do.	Deir-Ayub?
Baalath.	do.	Deir Bala.
Bene-barak.	do.	Buraba.
Beth-car.	Hill.	Beit Far?
Beth-shemesh.	Town.	Ain Shems.
Charashim.	Valley.	[Wady Mazraeh?]
Ekron.	Town.	Akir.
Elon.	do.	[Beit Susia?]
Eltekon.	do.	[El-Mansurah?]
Eshtaol.	do.	Yeshua?
Gath-rimmon.	do.	[Rayfa?]
Gibbethon.	do.	[Sardon?]
Gimzo.	do.	Jimzu.
Gittaim.	do.	See ARIMATHAEA.
Hadid.	do.	El-Hadidhah.
Hera.	Mountain.	See JEARIM.
Ir-shemesh.	Town.	See BETH-SHEMESH.
Jabnial, or Jabneh.	do.	Yebna.
Japho.	do.	Yafa.
Jearim.	Mountain.	[Hills W. of Wady Ghur?]
Jehud.	Town.	El-Yehudiyeh.
Jethlah.	do.	[Rufah N. of Latrun?]
Joppa.	do.	See JAFFO.
Lod, or Lydda.	do.	Ludd.
Mahaneh-dan.	Plain.	W. of Kirjath-jearim?
Makar.	District.	E. of Ekron?
Me-jarkon.	Town.	[Danzig?]
Neballat.	do.	Beit Nebala.
Ono.	do.	Kafz-Auz.
Rakkon.	do.	[Khebeh?]
Selr [or Segrath?].	Mountain.	Sarta.
Shaalbin.	Town.	[Beit Stru?]
Sharon.	Plain.	Vicinity of Ludd.
Shicron.	Town.	[Beit Skir?]
Timnath, or Timnath.	do.	Sibmah.
Zorah, or Zorah.	do.	Sura.

The mention of this tribe in the "blessings" of Jacob and Moses must not be overlooked, but it is difficult to extract any satisfactory meaning from them. According to Jewish tradition, Jacob's blessing on Dan is a prophetic allusion to Samson, the great "judge" of the tribe; and the ejaculation with which it closes was that actually uttered by Samson when brought

the temple at Gaza. (See the Targum Ps. Jona-
on Gen. xlix, 16, 17; and the quotations in Ka-
l's *Genesis* ad loc.) Modern critics likewise see
illusion to Samson in the terms of the blessings
ch they presume on that account to have been
tan after the days of the Judges (Ewald, *Gesch.* i,

Jerome's observations (*Qu. in Gen.*) on this pas-
sage are very interesting. Herder's interpretation as
given by Stanley (*Palestine*, p. 888) is as follows: "It
is doubtful whether the delineation of Dan in Jacob's
blessing relates to the original settlement on the west-
outskirts of Judah, or to the northern outpost.
Herder's explanation will apply almost equally to both.
Dan, 'the judge, 'shall judge his people;' he the son
he concubine no less than the sons of Leah; he the
tribe no less than those in the places of honor
will be 'as one of the tribes of Israel.' 'Dan shall
be a serpent by the way, an adder in the path,' that is,
the invading enemy by the north or by the west,
at the heels of the horse,' the indigenous ser-
pent biting the foreign horse unknown to Israelite
rider, 'so that his rider shall fall backwards.' And
the war-cry as from the frontier fortresses shall be,
or Thy salvation, O Lord, I have waited!' In the
blessing of Moses the southern Dan is lost sight of.
The northern Dan alone appears, with the same char-
acteristics, though under a different image; 'a lion's
paw' in the far north, as Judah in the far south:
he shall leap from Bashan—from the slopes of Her-
mon, where he is couched watching for his prey."

2. (Josephus *τὸ Δάνιον*.) The city so familiar as
the most northern landmark of Palestine in the com-
mon expression "from Dan even to Beersheba." The
name of the place was originally LAISH or LESHEM
(Josh. xix, 47). Its inhabitants lived "after the man-
ner of the Zidonians," i. e. engaged in commerce, and
without defence. But it is nowhere said that they
were Phœnicians, though this may perhaps be inferred
from the parentage of Huram—his mother "of the
daughters of Dan," his father "a man of Tyre" (2
Chron. ii, 14). They seem to have derived their secu-
rity from the absence of any adverse powers in their
neighborhood, and from confidence in the protection
of Sidon, which was, however, too far off to render aid
in the case of such a sudden assault as that by which
they were overpowered. This distance of Sidon was
repeatedly noted by the Danite spies as a circumstance
favorable to the enterprise; and it does not appear
that Sidon ever made any effort to dispossess the in-
vaders. Living thus "quiet and secure," they fell
in easy prey to the active and practised freebooters of
the Danites. These conferred upon their new acqui-
sition the name of their own tribe, "after the name of
their father who was born unto Israel" (Judg. xviii,
19; Josh. xix, 47), and Laish became Dan. The grav-
est image which the wandering Danites had stolen from
Micah they set up in their new home, and a line of
priests was established, which, though belonging to
the tribe of Levi and even descended from Moses, was
not of the family of Aaron, and therefore not belong-
ing to the regular priesthood. To the form of this im-
age and the nature of the idolatry we have no clew,
nor to the special relation which existed between it
and the calf-worship afterwards instituted there by
Jeroboam (1 Kings xii, 29, 30). It only appears that
Jeroboam took advantage of the confirmed idolatry of
the Danites (Judg. xviii, 30), erected a temple in their
city, and set up there one of his golden calves for the
benefit of those to whom a pilgrimage to Jerusalem
would not have been politic, and a pilgrimage to Beth-
el might have been irksome (1 Kings xii, 28). The
latter worship is alluded to by Amos (viii, 14) in a pas-
sage which possibly preserves a formula of invocation
or adjuration in use among the worshippers; but the
passage is very obscure. The worship of the calf may
be traced to this day in the secret rites of the Nosai-
rian Druse saints of the vicinity (Newbold, *Jour. As.*

Soc. xvi, 27). After the establishment of the Danites
at Dan it became the acknowledged extremity of the
country, and the formula "from Dan even to Beershe-
ba" is frequent throughout the historical books (Judg.
xx, 1; 1 Sam. iii, 20; 2 Sam. iii, 10; xvii, 11; xxiv,
2, 16; 1 Kings iv, 25). In the later records the form
is reversed, and becomes "from Beersheba even to
Dan" (1 Chron. xxi, 2; 2 Chron. xxx, 5). It is occa-
sionally employed alone in a somewhat similar mean-
ing; thus, in Jer. vii, 16, "The snorting of his horses
was heard from Dan; the whole land trembled at the
sound of the neighing of his strong ones" (also iv, 15).
Dan was, with other northern cities, laid waste by
Benhadad (1 Kings xv, 20; 2 Chron. xvi, 4), and this
is the last mention of the place.

Various considerations would incline us to the suspi-
cion that Dan was a holy place of note from a far ear-
lier date than its conquest by the Danites. These are:
(1.) The extreme reluctance of the Orientals—apparent
in numerous cases in the Bible—to initiate a sanc-
tuary, or to adopt for worship any place which had not
enjoyed a reputation for holiness from pre-historic
times. (2.) The correspondence of Dan with Beer-
sheba in connection with the life of Abraham—the or-
igin of Beersheba also being, as has been noticed, en-
veloped in some diversity of statement. (3.) More
particularly its incidental mention in the very clear
and circumstantial narrative of Gen. xiv, 14, as if well-
known even at that very early period. Its mention
in Deut. xxxiv, 1, is also before the events related in
Judg. xviii, though still many centuries later than the
time of Abraham. But the subject is very difficult,
and we can hardly hope to arrive at more than con-
jecture upon it. With regard to Gen. xiv, 14, three
explanations suggest themselves. *a.* That another
place of the same name is intended. (See Kalisch,
ad loc. for an ingenious suggestion of Dan-jaan).
Against this may be put the belief of Josephus (comp.
Ant. i, 10, 1, with v, 8, 1) and of Jerome (*Onomast.* s. v.
Laiza, comp. with *Quæst. Hebr. in Genesis*, xiv, 14),
who both unhesitatingly identify the Dan near Pane-
as with the Dan of Abraham. *b.* That it is a prophetic
anticipation by the sacred historian of a name which
was not to exist till centuries later, just as Samson
has been held to be alluded to in the blessing of Dan
by Jacob. *c.* That the passage originally contained
an older name, as Laish; and that, when that was su-
perseded by Dan, the new name was inserted in the
MSS. This last is Ewald's (*Gesch.* i, 78), and of the
three is the most feasible, especially when we consid-
er the characteristic genuine air of the story in Judges,
which fixes the origin of the name so circumstantially.
Josephus (*Ant.* v, 8, 1) speaks positively of the situa-
tion of Laish as "not far from Mount Libanus and the
springs of the lesser Jordan, near (*καρὰ*) the great
plain of the city of Sidon" (compare also *Ant.* viii, 8,
4); and this, as just said, he identifies with the Dan in
Gen. xiv, 14 (*Ant.* i, 10, 1). In consonance with this
are the notices of Jerome, who derives the word "Jor-
dan" from the names of its two sources. In Deut.
xxxiv, 1, also, we find the phrase "all the land of
Gilead unto Dan" employed by Moses some fifty years
before the conquest of Laish. The locality of the
town is specified with some minuteness. It was "far
from Zidon," and "in the valley (*בְּעֵמֶק*, *Emek*) that is
by (*בְּ*) Beth-rehob;" but as this latter place has not
been identified with certainty, the position of Dan
must be ascertained by other means. Josephus says
that it stood at the "lesser" fountain of the Jordan
... in the plain of Sidon, a day's journey from that
city, and that the plain around it was of extraordinary
fertility (*Ant.* i, 10, 1; v, 8, 1; viii, 8, 4; *War.* iv, 1, 1).
Eusebius and Jerome are still more explicit—"A vil-
lage, four miles distant from Paneas, on the road lead-
ing to Tyre; it was the boundary of Judæa (*ὄριον τῆς*
Ιουδαίας), and at it the Jordan took its rise." Jerome

adds, "De quo et Jordanis flumen erumpens à loco sortitus est nomen. *Jor* quippe *βειθρον*, id est, fluvium sive rivum Hebræi vocant" (*Onomast.* s. v. Dan). Some writers, both ancient and modern, have confounded Dan with Paneas or Cæsarea Philippi (Philostorgius, *History*, vii, 8; Theodoret in *Genes.*; Sanson, *Geog. Sac.* s. v.; Alford on *Matt.* xvi, 18). This error appears to have arisen chiefly from indefinite remarks of Jerome in his commentary on Ezek. xlviii, 18: "Dan . . . ubi hodie Paneas, quæ quondam Cæsarea Philippi vocabatur;" and on Amos viii, "Dan in terminis terræ Judaicæ, ubi nunc Paneas est." It is plain from Jerome's words in the *Onomasticon* that he knew the true site of Dan, and therefore these notices must be understood as meaning that Cæsarea Philippi was in his days the principal town in the locality where Dan was situated, and that both were upon the border of Palestine. The Jerusalem Targum calls it "Dan of Cæsarea," intimating its vicinity to the latter (*on Gen.* xiv, 14; see Reland, *Palæst.* p. 919-21). In perfect agreement with this is the position of *Tell el-Kadi*, a mound from the foot of which gushes out "one of the largest fountains in the world," the main source of the Jordan (Robinson, *Later Res.* iii, 390-393). The tell itself, rising from the plain by somewhat steep terraces, has its long, level top strewed with ruins, and is very probably the site of the town and citadel of Dan. The spring is called *el-Leiddân*, possibly a corruption of Dan (Robinson, iii, 392), and the stream from the spring *Nahr ed-Dhan* (Wilson, ii, 178), while the name, *Tell el-Kadi*, "the Judge's mound," agrees in signification with the ancient name. Those who have visited it give the exact agreement of the spot with the requirements of the story in *Judg.* xviii—"a good land and a large, where there is no want of anything that is on the earth" (Thomson, *Land and Book*, ii, 320). *Tell el-Kady* is cup-shaped, resembling an extinct crater, and is covered with a dense jungle of thorns, thistles, and rank weeds. Its circumference is about half a mile, and its greatest elevation above the plain eighty feet. There are some traces of old foundations, and heaps of large stones on the top and sides of the southern part of the rim, where perhaps the citadel or a temple may have stood. There are also ruins in the plain a short distance north of the tell. There are doubtless other remains, but they are now covered with grass and jungle. At the western base of the tell is the great fountain, and there is a smaller one within the cup, shaded by noble oak-trees (Porter, *Damascus*, i, 308). About a quarter of an hour north, Burckhardt noticed ruins of ancient habitations; and the hill which overhangs the fountains appears to have been built upon, though nothing is now visible (Burckhardt, *Syria*, p. 42; Robinson, *Researches*, iii, 351-358).—Kitto, s. v.; Smith, s. v.

3. "Dan also" stands in the A. V. as the rendering of דָּן (*Vedan*, lit. *and Dan*; Sept. translates undistinguishably) an Arabian city mentioned in Ezek. xxvii, 19 as a place from which cloths, wrought iron, cassia, and other spices were brought to Tyre. By it is probably meant the city and mart of *Aden*, in connection with which Edrisi enumerates these very wares: "The town of Aden is small, but celebrated for its seaport, from which vessels sail bound for India, China, and neighboring countries, returning with cargoes of iron, Damascus sword-blades . . . cardamom, cinnamon . . . myrobalan . . . and various kinds of rich figured and velvet stuffs" (i, 51). (See McCulloch's *Geographer*, s. v. Aden). See *VEDAN*.

Dana, Daniel, D.D., a Presbyterian minister, was born at Ipswich, Mass., July 24, 1771, and was educated at Dartmouth College, where he graduated in 1788. For several years he was employed as a tutor. In 1793 he was licensed "as a qualified candidate preacher of the Gospel of Christ." In 1794 he was ordained pastor of the Presbyterian church in Newburyport,

and after a successful ministry of twenty-six years was transferred to Hanover, New Hampshire, and then to the position of president of Dartmouth College. He soon withdrew from that position as uncongenial with his feelings, and settled in Londonderry as pastor of the church, where he remained four years and a half. In 1826 he became pastor of the Second Presbyterian church at Newburyport, which position he resigned in 1845, in the sixty-fifth year of his age. Dr. Dana was regarded "one of the most able, devoted, and useful ministers of the period in which he lived." He died August 18, 1859. He edited Gibbon's *Memoirs of Pious Fathers* (1802), and Flavel's *Works*, and published several tracts and sermons.—Wilson, *Presbyterian Alliance*, 1861, p. 84; *Princeton Review*, Jan. 1867; Sprague, *Life of Daniel Dana*, D.D. (Boston, 1866).

Dana, James, D.D., a Congregational minister, was born in Cambridge 1785, graduated at Harvard 1783, and in 1788 was installed pastor at Wallingford, Conn. He became pastor of the First Church, New Haven, 1789; was dismissed July 30, 1805; and died Aug. 18, 1812. He was made D.D. by the University of Edinburgh, 1768. Dr. Dana published "*An Examination of Edwards on the Will*" (anon. 1770); "*Examination of the Same, continued*" (1773); and a number of occasional sermons. In his writings in reply to Edwards, he held "that men themselves are the only efficient causes of their own volitions; and that they always determine according to the greatest apparent good; the affections do not follow the judgment; men sin against light, with the wisest choice; the greater good full in their view. Through the impetuosity of their passions, they determine against the greatest apparent good. This is the case with every sinner who resolves to delay repentance to a future time. Self-determination is the characteristic of every moral agent. The absence of liberty he deemed inconsistent with moral agency; and by liberty he meant, not merely liberty in regard to the external action, but liberty of volition; an exemption from all circumstances and causes having a controlling influence over the will—a self-determining power of man as a real agent, in respect to his own volitions. In the whole, he regarded the scheme of Edwards as acquitting the creature of blame, and impeaching the truth and justice of the Creator" (Allen, *Am. Biog. Dict.* s. v.).—Sprague, *Annals*, i, 565.

Dannaba (*Δάναβα*), a small town placed by Ptolemy (v, 15, 24) in Palmyrene, a subdivision of his Cœle-Syria; also mentioned under the name *Dannaba* in the war between the emperor Julian and the Persians (Zozim. *Hist.* iii, 27, 7). It does not appear to correspond to any of the three places of a similar name mentioned by Eusebius (*Δαναβά, Δανβία*) and Jerome (*Onomast.* s. v. *Dannaba*), lying in the region of Mesopotamia. It was the seat of a bishopric (*Notit. Eccl.*) and has lately been identified by Porter (*Damascus*, i, 346)—from an Arabic MS. written in the 7th century by Macarius—with *Saidiyya*, now a large village at the foot of Anti-Lebanon, with a convent and extensive ruins (Van de Velde, *Memoir*, p. 306).

Daneus, or Daneau, Lambert, an eminent French Protestant divine, was born at Orleans, 1537. He first studied law, afterwards theology, and became minister at Geneva, and subsequently at Leyden; finally at Orthez, in Navarre, where he died in 1586. He was the first writer who treated Christian ethics separately from theology (*Ethices Christianæ lib. iii* Genev. 1577). He was a strong Calvinist, as shown in his *Loci Communes*. He edited portions of Augustine, and wrote largely in controversy. We have in English his *Commentary on the Minor Prophets*, translated by Stockwood (Lond. 1594, 4to). See Haag, *La France Protestante*, iv, 192; *Theol. Stud. u. Krit.* 1854, p. 22.

Dance. This act is usually denoted in Heb. by the form of **לָדַח**, *chul*, which literally signifies to *st* (and is often applied to *writhing* under pain, as of *th*, or *trembling* under fear), and hence probably refers to the *whirling* motions of the Oriental sacred dances (Judg. xxi, 21, 23; Psa. xxx, 11; cxlix, 3; cl, Jer. xxxi, 4, 13; Lam. v, 15; Exod. xv, 20; xxxii, 17; Judg. xi, 84; 1 Sam. xviii, 6; xxi, 21; xxix, 5; nt. vi, 13). A similar idea of *moving in a circle* is literally contained in the word **חָגַג**, *chagag*, translated "dancing" in 1 Sam. xxx, 16. Another term thus derived (Eccles. iii, 4, Job xxi, 11; Isa. xlii, 21; 1 Iron. xv, 29) is **רָקַד**, *rakad*, which simply means *skip* or *leap* for joy, as it is elsewhere rendered, and nearly equivalent to a fourth term thus translated Sam. vi, 14, 16), **קָרַר**, *karar*, which means to *jump* spring. In the New Test. the terms translated *dance*" are **χορός** (radically expressive of the same idea of *circular* motion), applied to a festive occasion connection with music (Luke xv, 25), and **ὀρχήσασθαι**, literally to *leap up* and down, but conventionally used later times to denote a regular dance according to rule, either in concert (Matt. xi, 17; Luke vii, 32) or by a single person, especially in the elaborate *pantomime* dance of Roman times (Matt. xiv, 6; Mark vi, 1). (See Smith's *Dict. of Class. Antiq.* s. v. *Saltatio*, *antomimus*.)

As emotions of joy and sorrow universally express themselves in movements and gestures of the body, sports have been made among all nations, but especially among those of the South and East, in proportion as they seem to be more demonstrative, to reduce measure and to strengthen by unison the more measurable—those of joy. The dance is spoken of in Holy Scripture universally as symbolical of some rejoicing, and is often coupled for the sake of contrast with mourning, as in Eccles. iii, 4, "a time to mourn and a time to dance" (comp. Psa. xx, 11; Matt. xi, 17). Children dance spontaneously (Job xi, 11; Matt. xi, 17; Luke vii, 32).

1. At a very early period, dancing was enlisted into the service of religion among the heathen; the dance, enlivened by vocal and instrumental music, was a usual accompaniment in all the recessions and festivals of the gods (Strabo, x); and, indeed, so indispensable was this species of violent merriment, that no ceremonial was considered duly accomplished—no triumph rightly celebrated, without the aid of dancing. The Hebrews, in common with other nations, had their sacred dances, which were performed on their solemn anniversaries, and other occasions of commemorating some special token of the divine goodness and favor, as means of drawing forth, in the liveliest manner, their expressions of joy and thanksgiving. The performers were usually a band of females, who, in cases of public rejoicing, volunteered their services (Exod. xv, 20; 1 Sam. xviii, 6), and who, in the case of religious observances, composed the regular choruses of the temple (Psa. cxlix, 3; cl, 4), although there are not wanting instances of men also joining in the dance on these seasons of religious festivity. Thus David deemed it no way derogatory to his royal dignity to *dance* on the auspicious occasion of the ark being brought up to Jerusalem (2 Sam. vi, 14, 16). The word used to describe his attitude is significant of violent efforts

of leaping (**מִצְעָה וּמְקַרְבַּר מְקַרְבַּר בְּבִלְעֵז**); and, from the apparent impropriety and indecency of a man advanced in life, above all a king, exhibiting such freaks, with no other covering than a linen ephod, many learned men have declared themselves at a loss to account for so strange a spectacle. It was, unquestionably, done as an act of religious homage; and when it is remembered that the ancient Asiatics were accustomed, in many of their religious festivals, to throw off their garments even to perfect nudity, as a symbol sometimes of penitence, sometimes of joy, and that this, together with many other observances that bear the stamp of a remote antiquity, was adopted by Mohammed, who has enjoined the pilgrims of Mecca to encompass the Kaaba clothed only with the *ihram*, we may perhaps consider the linen *ephod*, which David put on when he threw off his garments and danced before the ark, to be symbolic of the same objects as the *ihram* of the Mohammedans (see Foster's *Mohammedanism Unveiled*). The conduct of David was imitated by the later Jews, and the dance was incorporated among their favorite usages as an appropriate close of the joyous occasion of the feast of Tabernacles. "The members of the Sanhedrim, the rulers of the synagogues, doctors of schools, and all who were eminent for rank or piety, accompanied the sacred music with their voices, and leaped and danced with torches in their hands for a great part of the night, while the women and common people looked on." This strange and riotous kind of festivity was kept up till exhaustion and sleep dismissed them to their homes (Buxtorf, *De Synag. Jud.* cap. 21).

The character of the ancient dance was very different from that of ours, as appears from the conduct of Miriam, who "took a timbrel in her hand, and all the women went out after her with timbrels and with dances." Precisely similar is the Oriental dance of the present day, which, accompanied of course with



Arab Dance.

music, is led by the principal person of the company, the rest imitating the steps. The evolutions, as well as the songs, are extemporaneous—not confined to a fixed rule, but varied at the pleasure of the leading dancer; and yet they are generally executed with so much grace, and the time so well kept with the simple notes of the music, that the group of attendants show wonderful address and propriety in following the variations of the leader's feet. The missionary Wolf describes a festival of some Eastern Christians, where one eminent individual, who led the song as well as the dance, conducted through the streets of the city a numerous band of people, who leaped and danced in

imitation of the gestures used by him. When the late deputation of the Church of Scotland were on their way through Palestine, their young Arab guides, to relieve the tedium of the journey, sometimes "commenced a native song and dance; one of them, advancing a little before the rest, began the song, dancing forward as he repeated the words; when the rest, following him in regular order, joined in the chorus, keeping time by a simultaneous clapping of hands. They sang several Arabian songs, responding to one another, dancing and clapping their hands." In their "dancing dervishes" the Turks seem to have adopted into their system the enthusiastic raptures, at once martial and sacred, which (e. g. in the Roman *Sabbi*) seem indigenous in many Southern and Eastern races from the earliest times.

In the earlier period dancing is found combined with some song or *refrain* (Exod. xv, 20; xxxii, 18, 19; 1 Sam. xxi, 11); and with the *ἄρρα*, or tambourine (A. V. "timbral"), more especially in those impulsive outbursts of popular feeling which cannot find sufficient vent in voice or in gesture singly. Nor is there any more strongly popular element traceable in the religion of the ancient Jews than the opportunity so given to a prophet or prophets to kindle enthusiasm for Jehovah on momentous crises of national joy, and thus root the theocracy in their deepest feelings, more especially in those of the women, themselves most easily stirred, and most capable of exciting others. The dance was regarded even by the Romans as the worship of the body, and thus had a place among sacred things (Servius ad Virg. *Bucol.* v, 78). A similar sentiment is conveyed in Psa. xxxv, 10: "All my bones shall say, Lord, who is like unto thee?" So the "tongue" is the best member among many, the "glory" (Psa. lvii, 8) of the whole frame of flesh, every part of which is to have a share in the praises of God. Similarly among the Greeks is ascribed by Athenæus to Socrates a fragment in praise of dancing (Athen. xiv, 627; comp. Arrian, *Alex.* iv, 11). Plato certainly (*Leg.* vii, 6) reckons dancing (*ᾠροποιία*) as part of gymnastics (*γυμναστική*). So far was the feeling of the purest period of antiquity from attaching the notion of effeminacy to dancing, that the ideas of this and of warlike exercise are mutually interwoven, and their terms almost correspond as synonyms (Homer, *Il.* xvi, 617; comp. Creuzer, *Symb.* ii, 367; iv, 474; and see especially Lucian, *De Salt.*, passim). Women, however, among the Hebrews made the dance their especial means of expressing their feelings; and when their husbands or friends returned from a battle on behalf of life and home, they felt that they too ought to have some share in the event, and found that share in the dance of triumph welcoming them back. The "eating, and drinking, and dancing" of the Amalekites is recorded, as is the people's "rising up to play" (פִּתְיוֹן, including a revelling dance), with a tacit censure; the one seems to mark the lower civilization of the Amalekites, the other the looseness of conduct into which idolatry led the Israelites (Exod. xxxii, 6; 1 Cor. x, 7; 1 Sam. xxx, 16). So, among the Bedonins, native dances of men are mentioned (Lynch, *Dead Sea*, p. 295), and are probably an ancient custom. The Hebrews, however, save in such moments of temptation, seem to have left dancing to the women. But, more especially, on such occasions of triumph, any woman, whose nearness of kin to the champion of the moment gave her a public character among her own sex, seems to have felt that it was her part to lead such a demonstration of triumph or of welcome; so Miriam (Exod. xv, 20), and so Jephthah's daughter (Judg. xi, 34), and similarly there no doubt was, though none is mentioned, a chorus and dance of women led by Deborah, as the song of the men by Barak (comp. Judg. v, 1 with Exod. xv, 1, 20). Similarly, too, Judith (xv, 12, 18) leads her own song and dance of triumph over

Holofernes. There was no such leader of the women mentioned in the case of David and Saul. Hence, whereas Miriam "answered" the entire chorus (Exod. xv, 21), the women in the latter case "answered one another as they played" (1 Sam. xviii, 7), the "answer" embodying the sentiment of the occasion and forming the burden of the song. The "coming out" of the women to do this (Judg. xi, 34; 1 Sam. xviii, 6; comp. "went out," Exod. xv, 20) is a feature worthy of note, and implies the object of singing, attending upon, and conducting home. So, when Jephthah's daughter met her father, the "women of the cities" came to meet and celebrate Saul and David and their host, but Miriam in the same way "went out" before "Jehovah" the "man of war," whose presence seems implied. This marks the peculiarity of David's conduct when, on the return of the ark, God from its long sojourn among strangers and deriders, he (2 Sam. vi, 5-22) was himself *choreus*: here, too, the women, with their timbrels (see especially ver. 5, 19, 20, 22), took an important share. The fact brings out more markedly the feelings of Saul's daughter Michal, keeping aloof from the occasion, and "looking through a window" at the scene. She should, in accordance with the examples of Miriam, etc., have herself led the female choir, and so come out to meet the ark and her lord. She stays within the "household" (ver. 20), and "comes out to meet" him with reproaches, perhaps feeling that his real rebuke to her apathy. It was before "the handmaids," i. e. in leading that choir which she should have led, that he had "uncovered" himself; as a king's exposure as she thought it, which was rendered necessary—the wearing merely the epithet-linen tunic. The occasion was meant to be popular, viewed in connection with David's subjugation of various enemies and accession to the throne of Israel (see 1 Chron. xii, 23-xiii, 8); he accordingly took only of the honor of God who had so advanced him and in that forgets self (comp. Müller, *De David*, c. Arc. Ugolini, xxxii). From the mention of "timbrels," "timbrels," and "dances" (Psa. lxxv, 5 cxlix, 8; cl, 4) as elements of religious worship it may perhaps be inferred that David's feeling led him to incorporate in its rites that popular mode of festive celebration. This does not seem to have survived him, for as Saalschütz remarks (*Archäol. der Hebr.* i, 299), in the mention of religious revivals under Hezekiah and Josiah, no notice of them occurs; and although the "words," the "writing," and the "commandment of David" on such subjects are distinctly alluded to (2 Chron. xxix, 30; xxxv, 4, 15). It is possible that the banishing of this popular element which found its vent no doubt in the idolatrous rites of Baal and Astarte (as it certainly did in those of the golden calf, Exod. xxxii, 19), made those efforts take a less firm hold on the people than they might have done, and that David's more comprehensive scheme might have retained some ties of feeling which were thus lost. On the other hand was doubtless the peril of the loose morality which commonly attended festive dances at heathen shrines. Certainly in later Judaism the dance was included among some religious festivities, e. g. the feast of tabernacles (Mishna, *Seraḥ* v, 3, 4), where, however, the performers were men. This was probably a mere following the example of David in the letter. Also in the earlier period of the Judges the dances of the virgins in Shiloh (Judg. xxi, 19-23) were certainly part of a religious festivity. It seems also from this last instance clear, and from others probable, that such dances were performed by maidens apart from men, which gives an additional point to the reproach of Michal. What the fashion or figure of the dance was is a doubtful question, but it is likely to have lacked such variety as would adapt it to the various occasions of its use. The terms employed, however, all point to dancing in a ring. It

an Oriental dances a woman leads off the dance, others then follow her with exact imitation of her



Oriental Dancing-girl.

stic and graceful attitudes. A parallelism of movement is also incident to it (Saalschütz, *ib.* p. 801). Posing Miriam so led her countrywomen. The same writer thinks that in Cant. vi, 18, the words מְדַבְּרוֹתַי (A. V. "company of two armies") imply two sets of dancing girls, and that the address in the singular number, "return, return," and again in vii, 1, alludes to the movements of the individual performer a kind of *contre-danse*. This interpretation, however, does not remove the obscurities of the passage. From being exclusively, or at least principally, reserved for occasions of religious worship and festivity, dancing came gradually to be practised in common on any remarkable seasons of mirth and rejoicing (Ex. xxxi, 4; Psa. xxx, 11). In early times, indeed, those who perverted the exercise from a sacred use to purposes of amusement were considered profane and famous; and hence Job introduces it as a distinguishing feature in the character of the ungodly rich, at they encouraged a taste for dancing in their families (Job xxi, 11). During the classic ages of Greece and Rome society underwent a complete revolution of sentiment on this subject, inasmuch that the Grecian poets represent the gods themselves as passionately fond of the diversion (Potter's *Grec. Antiq.* ii, 400), and that not only at Rome, but through all the provinces of the empire it was a favorite pastime, resorted to not only to enliven feasts, but in the celebration of domestic joy (Luke xv, 25; Matt. xiv, 6). Notwithstanding, however, the strong partiality cherished for this inspiring amusement, it was considered beneath the dignity of persons of rank and character to practise it. The well-known words of Cicero, that "no one dances unless he is either drunk or mad," express

the prevailing sense as to the impropriety of respectable individuals taking part in it; and hence the gay circles of Rome and its provinces derived all their entertainment, as is done in the East to this day, from the exhibitions of professional dancers. Under the patronage of the emperors, and of their luxurious tributaries, like Herod, the art was carried to the utmost perfection, the favorite mode being pantomime, which, like that of the modern Almahs or Arab women, was often of the most licentious description (see Lane's *Mod. Eg.* ii, 105-9; St. John's *Nubia*, p. 268 sq.). A story of love was chosen—generally an adventure of the gods—as the plan of the dance, and the address of the performer consisted in representing, by the waving of his hands, the agility of his limbs, and the innumerable attitudes into which he threw himself, all the various passions of love, jealousy, disgust, that sway the human breast. (See at large Lucian's *Treatise on Dancing.*)

Amateur dancing in high life was, as that writer informs us, by no means uncommon in the voluptuous times of the later emperors. But in the age of Herod it was exceedingly rare and almost unheard of, and therefore the condescension of Salome, who volunteered, in honor of the anniversary of that monarch's birthday, to exhibit her handsome person as she led the mazy dance in the saloons of Machærus—for, though she was a child at this time, as some suppose (Michaelis, *Introd.*), she was still a princess—was felt to be a compliment that merited the highest reward. The folly and rashness of Herod in giving her an unlimited promise, great as they were, have been equalled and even surpassed by the munificence which many other Eastern monarchs have lavished upon favorite dancers. Shah Abbas (to mention only one anecdote of the kind), having been on a particular occasion extremely gratified with a woman who danced before him, and being at the time much intoxicated, made her a present of a magnificent khan that yielded him a considerable revenue. Next morning his minister reminded him of his extravagant liberality, whereupon, being now cool and ashamed of his folly, he sent for the dancer, and obliged her to be contented with a sum of money (Thevenot's *Trav. in Persia*, p. 100). It is by no means improbable that Herod too was flushed with wine, and that it was from fear he should retract his promise if she delayed till the morning that Herodias sent *immediately* for the head of the Baptist.

It remains to notice further that the Jewish dance was performed by the sexes separately. There is no evidence from sacred history that the diversion was promiscuously enjoyed, except it might be at the erection of the defiled calf, when, in imitation of the Egyptian festival of Apis, all classes of the Hebrews intermingled in the frantic revelry. In the sacred dances,



Female Sacred Dance.—From the Egyptian Monuments.

although both sexes seem to have frequently borne a part in the procession or chorus, they remained in distinct and separate companies (Psa. lxxviii, 25; Jer. xxxi, 13).

Dancing formed a part of the religious ceremonies of the Egyptians, and was also common in private entertainments (see Wilkinson's *Anc. Eg.* abridgment, i, 133 sq.). Many representations of dances both of men and women are found in the Egyptian paintings. The "feast unto the Lord," which Moses proposed to Pharaoh to hold, was really a dance (37; see above).—Kitto, s. v.; Smith s. v.

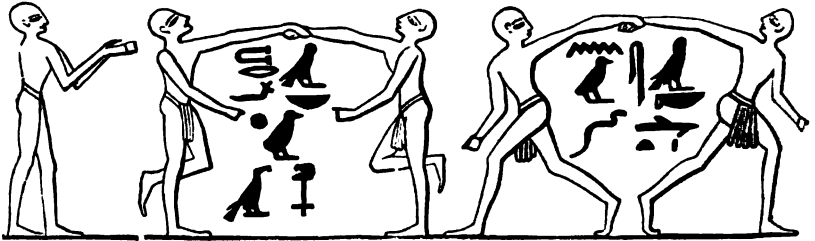

Male Dance in Figures among the ancient Egyptians.

A modern Oriental dancing-party is thus described by Layard (*Nineveh*, i, 119): "The dance of the Arabs, the *Debké*, as it is called, resembles in some respects that of the Albanians, and those who perform in it are scarcely less vehement in their gestures or less extravagant in their excitement than those wild mountaineers. They form a circle, holding one another by the hand, and, moving slowly round at first, go through a shuffling step with their feet, twisting their bodies into various attitudes. As the music quickens their movements are more active; they stamp with their feet, yell their war-cry, and jump as they hurry round the musicians. The motions of the women are not without grace; but as they insist on wrapping themselves in their coarse cloaks before they join in the dance, their forms, which the simple Arab shirt so well displays, are entirely concealed. When those who formed the *debké* were completely exhausted by their exertions, they joined the lookers-on, and seated themselves on the ground. Two warriors of different tribes, furnished with shields and naked cimeters, then entered the circle, and went through the sword-dance. As the music quickened the excitement of the performers increased. The by-standers at length were obliged to interfere and to deprive the combatants of their weapons, which were replaced by stout staves. With these they belabored one another unmercifully, to the great enjoyment of the crowd. On every successful hit, the tribe to which the one who dealt it belonged set up their war-cry and shouts of applause, while the women deafened us with the shrill *tahlehl*, a noise made by a combined motion of the tongue, throat, and hand vibrated rapidly over the mouth. When an Arab or a Kurd hears this *tahlehl* he almost loses his senses through excitement, and is ready to commit any desperate act. A party of Kurdish jesters from the mountains entertained the Arabs with performances and imitations more amusing than refined. They were received with shouts of laughter. The dances were kept up by the light of the moon the greater part of the night."

See Renz, *De saltationibus Jud. vet. relig.* (Lips. 1738); Danov, *De choreis sacris Ebr.* (Gryph. 1766); Spencer, *De saltat. vet. Hebr.* (in Ugolini *Thesaur.* xxx); Zeltner, *De choreis vet. Hebr.* (Altorf. 1726); Altenon, *De choreis Paulo interdicitis* (Misen. 1744); Brömel, *Festtänze der ersten Christen* (Jen. 1701); Grünenberg, *De saltatione Christiano licita* (Rost. 1704, 1719, 1730); Purmann, *De saltatione* (Froft. 1785); Burette (in the *Mém. de l'Acad. des Inscri.*, i, 93 sq.); Bonnet,

Hist. de la Danse (Par. 1724); Hecker, *Die Tanz* (Berl. 1832). See MUSICAL INSTRUMENTS.

Dancers, a sect which appeared on the Rhine in the Netherlands about 1374. They paraded the streets, entered houses and churches half naked, crowned with garlands, dancing and singing, using unknown names, falling senseless on the ground, exhibiting other marks of demoniacal agitation. It was customary for persons of both sexes, in the public worship, to begin dancing; and, holding each other's hands, to continue their extraordinary views till they fell down on the ground breathless. *De*

affirmed that during these intervals of vehement exaltation they were favored with wonderful visions. They evinced open contempt for the authority, rites and doctrines of the Roman Church, and were considered as possessed with devils. The same phenomena appeared at Strasburg in 1418.—Moesheim, *Ch. Hist.* i, 416; Gieselser, *Ch. History*, § 121.

Dancing. A form of religious dancing sometimes made part of the public worship of the early Christians. The custom was borrowed from the Jews, in whose solemn processions choirs of young men and maidens moving in time with solemn music, always bore a part. It must not be supposed that the "religious dances" had any similarity to modern amusements; they were rather processions in which all who took part marched in time with the hymns which they sung. The custom was very early laid aside, probably because it might have led to the adoption of all objectionable dances as were employed in honor of the pagan deities. Prohibitions of dancing, as an amusement, abound in the Church fathers and in the decrees of the councils. See Bingham, *Orig. Eccl.* bk. xvi, ch. xi, § 15. On dancing as an amusement, see Crane, *On Dancing*, N. Y. 12mo.

Dandini, GIROLAMO, a Roman theologian and papal legate, was born at Cesena in 1554. After being professor of philosophy at the University of Paris, and professor of theology at the University of Padua, he entered the order of Jesuits, and became its provincial in Poland and at Milan. In 1596 he was sent by Clement XI as nuncio to the Maronites in order to effect their union with the Church of Rome, but in this mission he was not successful. He died at Forti Nov. 23, 1634. He is the author of a work on *Ethica Sacra* (Cesena, 1651; Antw. 1676, fol.). He also published a report on his mission to the Maronites (*Missionis Apostolicæ al Patriarcha e Maronitæ del Monte Libano* (Cesena, 1656; Paris, 1675; English, 1698). According to the French translator, Richard Simon, Dandini gave an incorrect account of the creed of the Maronites.—Pierer, *Univers.* lex. iv, 686; Hoefler, *Biog. Gen.* i, 910.

Danforth, Calvin, a Methodist Episcopal minister, was born at Fort Covington, Franklin Co., N. Y. Nov. 28, 1809, was licensed to exhort in 1828, entered the Oneida Conference in 1830, was superannuated in 1834, went South for his health, and took a situation in an academy at Warrenton, Ga., still retaining his connection with the Church in the North. In 185

erved for a time as professor of mathematics in ngton Manual Labor School, but his health soon 1. By medical advice he went to St. Augustine, where he died in great peace in May, 1889. Mr. forth endeared himself to thousands by his piety, for education, love for souls, and eloquence.— *Notes of Conferences*, ii, 675; Gorrie, *Black River*; *Memorial*.

Danforth, Joshua Noble, D.D., a Presbyterian minister, was born in Pittsfield, Mass., in 1792. He educated at Williams College, and in his last year e determined to devote himself to the ministry. r three years' study in the Princeton Theological inary (1818-21), he took his first pastoral charge ewcastle, Del.; his second was at the City of hington. After a short time spent in the service he American Colonization Society, he became pas- of a Congregational Church at Lee, Mass., and af- wards of the Second Presbyterian Church at Alex- ria, Va., where he remained fifteen years. Every- re his ministry was productive of abundant fruit. was also a frequent writer in the periodical press. ally he re-entered the service of the Colonization iety, and remained in it till a short time before his th, which occurred Nov. 14, 1861, at Washington. Wilson, *Presbyterian Almanac*, 1863, p. 298.

Danforth, Samuel, a Congregational minister, s born at Framingham, Suffolk Co., England, Sep- ber, 1626, and came with his father to New Eng- d in 1634. He graduated at Harvard in 1643, and s chosen tutor and fellow. In 1650 he was installed league pastor in Roxbury, where he labored during life, which ended Nov. 19, 1674. He studied as- nomy carefully, and published several almanacs, d astronomical and theological remarks upon the net (1664).—Sprague, *Annals*, i, 138.

Danforth, Samuel, son of the preceding, was rn Dec. 18, 1666, and graduated at Harvard College 1688. He was one of the most learned and emi- nt ministers of his day. In the beginning of the ar 1705, through his labors, a deep impression was ide upon the minds of his people, and a revival oc- curred, of which an account is given in some letters Mr. Danforth, preserved in Prince's *Christian His- ry*. He published a eulogy on Thomas Leonard, 13, and the election sermon, 1714. He left behind m a manuscript Indian dictionary, a part of which now in the library of the Massachusetts Historical ociety. It seems to have been formed from Elliot's idian Bible, as there is a reference under every word a passage of Scripture. He died Nov. 14, 1727.—Al- n, *American Biography*, s. v.

Dan'iel (Heb. and Chald. *Daniyel*, דַּנְיֵאל; also Ezek. xiv, 14, 20; xxviii, 8] in the shorter form *daniel*, דַּנְיֵל; see below), the name of at least three ten.

1. (Sept. Δανιήλ v. r. Δαλωία, Vulg. Daniel.) King David's second son, "born unto him in Hebron," of Abigail the Carmelitess" (1 Chron. iii, 1), B.C. ir. 1061. In the parallel passage, 2 Sam. iii, 8, he is alled CHILEAB. For the Jewish explanation of the rigin of the two names, see Bochart, *Hierozoic*. ii, 55, s. 663.

2. (Sept. and N. T. Δανιήλ, Josephus Δανιήλος.) The celebrated prophet and minister at the court of Babylon, whose life and prophecies are contained in he book bearing his name. The exact meaning of he name is disputed. The full form (דַּנְיֵאל) is prob- ibly more correct, and in this the *god* appears to be ot merely formative, but a pronominal suffix (as אֱלֹהֵי דַּנְיֵאל, צַדִּיקֵי דַּנְיֵאל), so that the sense will be *God* is *my Judge* (C. B. Michaelis ap. Rosenmüller, *Schol.* § 1). Others interpret the word as the *Judge of God*, and the use of a *god* formative is justified by the parallel of Melchizedek, etc. (Hitzig, § 2). This interpretation

is favored by the Chaldean name, Belteshazzar (בֵּלְשַׁצְצָר, i, 7, i. e. *the prince of Bel*; Sept. [Theod.]; Βαλτασαρ; Vulg. *Baltassar*), which was given to Dan- iel at Babylon (Dan. i, 7), and contains a clear refer- ence to his former name. Hitzig's interpretation ("Pála tschâçara = *Ermähler und Verzehrer*") has nothing to recommend it. Such changes have been common at all times; and for the simple assumption of a foreign name, compare Gen. xli, 45; Ezek i, 11; v, 14 (Sheshbazzar). See NAME.

Daniel was descended from one of the highest fam- ilies in Judah, if not even of royal blood (Dan. i, 3; comp. Josephus, *Ant.* x, 10, 1; of Zedekiah, according to Epiphan. *Opp.* ii, 242). Jerusalem was thus prob- ibly his birth-place, though the passage (Dan. ix, 24) quoted in favor of that opinion is considered by many commentators as not at all conclusive. He appears to have possessed considerable personal endowments (Dan. i, 4). He was taken to Babylon (while yet a boy, according to Jerome, *adv. Jovin.* i, 276, ed. Ven.; of twelve years, says Ignatius, *ad Magnes.* p. 56, ed. Cotel.), together with three other Hebrew youths of rank, Ananiah, Mishaël, and Azariah, at the first de- portation of the people of Judah in the fourth year of Jehoiakim, B.C. 606. He and his companions were obliged to enter the service of the royal court of Bab- ylon, on which occasion he received the Chaldean name BELTESHAZZAR (q. v.), according to Eastern custom when a change takes place in one's condition of life, and more especially if his personal liberty is thereby affected (comp. 2 Kings xxiii, 84; xxiv, 17; Esth. ii, 7; Ezra v, 14). In this his new career, Daniel received that thorough polish of education which Oriental etiquette renders indispensable in a courtier (comp. iii, 6; Plato, *Alcib.* § 87), and was more espe- cially instructed "in the writing and speaking Chal- dean" (Dan. i, 4), that is, in the dialect peculiar to the Chaldeans. See CHALDEE LANGUAGE. In this dialect were composed all the writings of the ecclesi- astical order, containing the substance of all the wis- dom and learning of the time, and in the knowledge of which certainly but few favored laymen were ini- tiated. That Daniel had distinguished himself, and already at an early period acquired renown for high wisdom, piety, and strict observance of the Mosaic law (comp. Ezek. xiv, 14, 20; xxviii, 8; Dan. i, 8-16), is too evident from passages in the truly authentic Scriptures to require any additional support from the ill-warranted apocryphal stories concerning the deliv- ery of Susannah by the wisdom of the lad Daniel, etc. A proper opportunity for evincing both the acuteness of his mind and his religious notions soon presented itself in the custom of the Eastern courts to entertain the officers attached to them from the royal table (Athenæus, iv, 10, p. 145, ed. Casaub.). Daniel was thus exposed to the temptation of partaking of un- clean food, and of participating in the idolatrous cere- monies attendant on heathen banquets. Like Joseph in earlier times, he gained the favor of his guardian, and was divinely supported in his resolve to abstain from the "king's meat" for fear of defilement (Dan. i, 8-16). His prudent proceedings, wise bearing, and absolute refusal to comply with such customs, were crowned with the divine blessing, and had the most important results. Another reason of a sanitary na- ture may also be assigned for this temperance, as it is probable he was at this time undergoing the curative process after emasculation, in accordance with the bar- barous custom of Oriental courts. See EUNUCH.

At the close of his three years' discipline (Dan. i, 5, 18), Daniel had an opportunity of exercising his pe- culiar gift (Dan. i, 17) of interpreting dreams (comp. Herod. i, 84; Diod. Sic. ii, 29) on the occasion of Neb- uchadnezzar's decree against the Magi (Dan. ii, 14 sq.). In consequence of his success, by the divine aid —like Joseph of old in Egypt—he rose into high fa-

vor with the king, and was intrusted with two important offices—the governorship of the province of Babylon, and the head-inspectorship of the sacerdotal caste (Dan. ii). See *MAGI*. Considerably later in the reign of Nebuchadnezzar we find Daniel interpreting another dream of the king's, to the effect that, in punishment of his pride, he was to lose for a time his throne, but to be again restored to it after his humiliation had been completed (Dan. iv). Here he displays not only the most touching anxiety, love, loyalty, and concern for his princely benefactor, but also the energy and solemnity becoming his position, pointing out with vigor and power the only course left for the monarch to pursue for his peace and welfare. Under the unworthy successors of Nebuchadnezzar, Daniel and his merits seem to have been forgotten, and he was removed from his high posts. His situation at court appears to have been confined to a very inferior office (comp. Dan. viii, 27); neither is it likely that he should have retained his rank as head inspector of the order of the Magians in a country where these were the principal actors in effecting changes in the administration whenever a new succession to the throne took place. We thus lose sight of Daniel until the first year of king Belshazzar (Dan. v, 7, 8), when he was both alarmed and comforted by two remarkable visions (Dan. vii, viii), which disclosed to him the future course of events, and the ultimate fate of the most powerful empires in the world, but in particular their relations to the kingdom of God, and its development to the great consummation. He afterwards interpreted the handwriting on the wall which disturbed the feast of Belshazzar (v, 10-28), though he no longer held his official position among the magi (Dan. v, 7, 8, 12), and probably lived at Susa (Dan. viii, 2; comp. Joseph. *Ant.* x, 11, 7; Bochart, *Geogr. Sacr.* iii, 14). After the conquest of Babylon by the united powers of Media and Persia, Daniel, being made first of the "three presidents" of the empire (comp. 1 Esdr. iii, 9), seriously busied himself under the short reign (two years) of Darius the Mede or Cyaxares II with the affairs of his people and their possible return from exile, the term of which was fast approaching, according to the prophecies of Jeremiah. In deep humility and prostration of spirit he then prayed to the Almighty, in the name of his people, for forgiveness of their sins, and for the Divine mercy in their behalf; and the answering promises which he received far exceeded the tenor of his prayer, for the visions of the seer were extended to the end of Judaism (Dan. ix). In a practical point of view, also, Daniel appeared at that time a highly-favored instrument of Jehovah. Occupying, as he did, one of the highest posts of honor in the state, the strictness and scrupulousness with which he fulfilled his official duties could not fail to rouse envy and jealousy in the breasts of his colleagues, who well knew how to win the weak monarch, whom they at last induced to issue a decree imposing certain acts, the performance of which they well knew was altogether at variance with the creed of which Daniel was a zealous professor (comp. the apocryphal Bel and the Dragon). For his disobedience the prophet suffered the penalty specified in the decree; he was thrown into a den (q. v.) of lions, but was miraculously saved by the mercy of God—a circumstance which enhanced his reputation, and again raised him to the highest posts of honor. He had at last the happiness to see his most ardent wishes accomplished—to behold his people restored to their own land. Though his advanced age would not allow him to be among those who returned to Palestine, yet did he never for a moment cease to occupy his mind and heart with his people and their concerns (Dan. x, 12). At the accession of Cyrus he still retained his prosperity (vi, 28; comp. i, 21; Bel and Dr. 2), though he does not appear to have remained at Babylon (comp. Dan. i, 21). In the third year of Cyrus he had a series of visions, in which he was inform-

ed of the minutest details respecting the future history and sufferings of his nation, to the period of its true redemption through Christ, as also a command to himself to proceed calmly and peacefully to the end of his days, and then await patiently the resurrection of the dead at the end of time.

From that period the accounts respecting Daniel are vague and confused (see Prideaux, *Connections*, i, 36). According to the Mohammedan tradition (*D'Hercus, Bibl. Or.* i, 561) he returned to Judea, held the government of Syria, and finally died at Susa (Lam-müller, *Schol.* p. 5, n.), where his tomb is still shewn (*Ouseley's Trav. in Persia*, i, 422; iii, 564), and is venerated by crowds of pilgrims (see Loftus, *Trav. in Chaldee*, p. 320 sq.). Ezekiel mentions Daniel as a pattern of righteousness (xiv, 14, 20) and wisdom (xxviii, 3); and since Daniel was still young at that time, some have thought that another prophet of the name must have lived at some earlier time (Bleek), perhaps during the captivity of Nineveh (Ewald, *Die Propheten*, ii, 37), whose fame was transferred to his later namesake. Hitzig imagines (*Vorbemerk.* § 3) that the Daniel of Ezekiel was purely a mythical personage, whose prototype is to be sought in Melchizedek, and that the character was borrowed by the author of the book of Daniel as suited to his design. These suppositions are favored by no internal probability, and are unsupported by any direct evidence. The order of the name "Noah, Daniel, and Job" (Ezek. xiv, 14) seems to suggest the idea that they represent the first and last historic types of righteousness before the law and under it, combined with the ideal type (comp. Delitzsch, i, 271). On the other hand, the narrative in Dan. i, ii, implies that Daniel was conspicuously distinguished for purity and knowledge at a very early age (comp. the apocryphal Hist. of Susan. 45), and he may have been nearly forty years old at the time of Ezekiel's prophecy (B. C. 592). See Alexander, *De Danieles*; his *Hist. Eccles.* iii, 566; Robinson, *Script. Char.* i, M'Gavin, *Life of Daniel* (1832); Evans, *Script. Char.* ii, 174; Williams, *Char. of O. T.* p. 301; Kennet, *Daniel, his Life and its Lessons* (Lond. 1858); EMI, *Reflections on Daniel's Life and Character* (Lond. 1861). See *PROPHET*.

Allusion has been made above to the comparison which may be instituted between Daniel and Joseph, who stand at the beginning and the close of the divine history of the Jews as representatives of the true God in heathen courts (Auberlen, *Daniel*, p. 32, 33). In this respect the position of Daniel must have exercised a powerful influence upon the form of the revelations conveyed through him; and in turn the authority which he enjoyed renders the course of the exile and the return clearly intelligible. By station, by education, and by character, he was peculiarly fitted to fulfil the work assigned to him. He was not only a resident in a foreign land, like Jeremiah or Ezekiel, but the minister of a foreign empire, and of successive dynasties (Dan. ii, 48; vi, 28). His political experience would naturally qualify him to give distinct expression to the characteristics of nations in themselves, and not only in their relation to God's people. His intellectual advantages were as remarkable as his civil dignity. Like the great lawgiver who was "trained in all the wisdom of the Egyptians," the great seer was trained in the secrets of Chaldean wisdom, and placed at the head of the school of the Magi (Dan. ii, 48). He was thus enabled to preserve whatever was true in the traditional teaching of the East, and to cast his revelations into a form suited to their special character. But, though engaged in the service of a heathen prince and familiar with Oriental learning, Daniel was from the first distinguished by his strict observance of the Mosaic law (i, 8-16; comp. vi, 10, 11). In this way the third outward condition for his work was satisfied, and at the close of the exile he offered a pattern of holiness for the instruction of the Dispensa-

after times (comp. Auberlen, *Daniel*, p. 24, etc.).
 See DANIEL, BOOK OF.

Various apocryphal fragments attributed to Daniel are collected by Fabricius (*Cod. Pseud. V. T. i*, 1124), and his wisdom is extravagantly lauded by the Rabbins (emara, *Foma*); but it is surprising that his fame in later times seems to have been obscured (Hottinger, *ist. Orient.* 92). Comp. Epiph. *Vit. Dom.* ii, p. 243, ed. etav.; *Vit. Dom.* ap. Fabric.; Josephus, *Ant.* x, 11, 7. Kitto, s. v.; Smith, s. v. See DANIEL, APOCRYPHAL ADDITIONS TO.

DANIEL, BOOK OF. This important and in many respects remarkable book takes its name not only from the principal person in it, but also and chiefly from him as its real author, there being no just cause of doubt that, as the book itself testifies, it was composed by Daniel (comp. vii, 1, 28; viii, 2; ix, 2). It occupies, however, but a third rank in the Hebrew canon; not among the *Prophets*, but in the *Hagiographa*, owing apparently to the correct view of the compilers of the canon, that Daniel did not exercise his prophetic office in the more restricted and proper sense of the term "prophecy," but stood to the theocracy in a different relation from those real prophets whose calling and profession consisted exclusively in declaring the messages they received, and in the communion which they held with God. These latter are termed, in the ancient Hebrew idiom, נְבִיאִים, *prophets*, in contradistinction to זִמְרִים, *seers*, who, though they were equally favored with divine revelations, were nevertheless not prophets by profession, a calling that claimed the entire service of a man's whole life. See CANON. The Babylonian exile supplied the outward training and the inward necessity for this last form of divine teaching; and the prophetic visions of Ezekiel form the connecting link between the characteristic types of revelation and prophecy (comp. Lucke, *Versuch*, i, 17 sq.; Hitzig, *Daniel, Vorbem.* § 9; Hilgenfeld, *Die Jud. Apok.* 1 sq.). The following account of this book is in part compiled from the articles of Kitto and Smith. See DANIEL.

1. The book of Daniel divides itself into two parts, *historical* (ch. i-vi) and *prophetic* (ch. vii-xii), arranged respectively in chronological order. In the first seven chapters, accordingly, Daniel is spoken of *historically* (i, 8-21; ii, 14-49; iv, 8-27; v, 18-29; vi, 2-28; vii, 1, 2); in the last five he appears *personally* as the writer (vii, 15-28; viii, 1-ix, 22; x, 1-19; xii, 5). Its object is by no means to give a summary historical account of the period of the exile, or of the life of Daniel himself, since it contains only a few isolated points both as to historical facts and prophetic revelations. But the plan or tendency which so consistently runs through the whole book is of a far different character; it is to show the extraordinary and wonderful means which the Lord made use of, in a period of the deepest misery, when the theocracy seemed dissolved and fast approaching its extinction, to afford assistance to his people, proving to them that he had not entirely forsaken them, and making them sensible of the fact that his merciful presence still continued to dwell with them, even without the Temple and beyond the Land of Promise.

The wonders related in Daniel (ch. i-vi) are thus mostly of a peculiar, prominent, and striking character, and resemble in many respects those performed of old time in Egypt. Their divine tendency was, on the one hand, to lead the heathen power, which proudly fancied itself to be the conqueror of the theocracy, to the acknowledgment that there was an essential difference between the *world* and the *kingdom of God*; and, on the other, to impress degenerate and callous Israel with the full conviction that the power of God was still the same as it was of old in Egypt.

The following are the essential features of the prophetic tenor of the book of Daniel, while the visions in

ch. ii and vii, together with their different symbols, may be considered as embodying the leading notion of the whole. The development of the whole of the heathen power, until the completion and glorification of the kingdom of God, appeared to the prophet in the shape of four powers of the world, each successive power always surpassing the preceding in might and strength, namely, the Babylonian, Medo-Persian, Greek, and Syrian (otherwise Roman). The kingdom of God proves itself conqueror of them all; a power which alone is everlasting, and showing itself in its utmost glorification in the appearance of the Messiah, as Judge and Lord of the world. Until the coming of the Messiah, the people of God have yet to go through a period of heavy trials. That period is particularly described, ch. viii and xi, in the struggles of the Maccabean time, illustrative of the last and heaviest combats which the kingdom of God would have to endure. The period until the appearance of the Messiah is a fixed and sacred number—seventy weeks of years (ch. ix). After the lapse of that period ensues the death of the Messiah; the expiation of the people is realized; true justice is revealed, but Jerusalem and the Temple are in punishment given up to destruction. The true rise from this fall and corruption ensues only at the end of time, in the general resurrection (ch. xii).

The interpretation of Daniel has hitherto proved an inexhaustible field for the ingenuity of commentators, and the certain results are comparatively few. According to the traditional view, which appears as early as the fourth book of Ezra [see *ESDRAS*] and the epistle of Barnabas (ch. iv), the four empires described in ch. ii and vii are the Babylonian, the Medo-Persian, the Greek, and the Roman. With nearly equal consent it has been supposed that there is a change of subject in the eleventh chapter (xi, 81 sq.), by which the seer passes from the persecutions of Antiochus to the times of Antichrist. A careful comparison of the language of the prophecy with the history of the Syrian kings must, however, convince every candid student of the text that the latter hypothesis is wholly unfounded and arbitrary. The whole of the eleventh chapter forms a history of the struggles of the Jewish Church with the Greek powers up to the death of its great adversary (xi, 45). This conflict, indeed, has a typical import, and foreshows in its characteristic outlines the abiding and final conflict of the people of God and the powers of evil, so that the true work of the interpreter must be to determine historically the nature of each event signalized in the prophetic picture, that he may draw from the past the lesson of the future. The traditional interpretation of "the four empires" seems to spring from the same error as the other, though it still finds numerous advocates (Hofmann, Auberlen, Keil, Hävernick, Hengstenberg, and most English commentators). It originated at a time when the triumphant advent of Messiah was the object of immediate expectation, and the Roman empire appeared to be the last in the series of earthly kingdoms. The long interval of conflict which has followed the first Advent formed no place in the anticipations of the first Christians, and in succeeding ages the Roman period has been unnaturally prolonged to meet the requirements of a theory that took its rise in a state of thought which experience has proved false. See HORN, LITTLE.

The parallel character and striking fulfilment of Daniel's predictions, many of which are carried out with a detail elsewhere unknown, may be seen from the following synoptical table. Those relating to the seventy weeks (ch. ix, 24-27) will be treated separately under that head.

2. The language of the book is partly Chaldee (ii, 4; vii, 28) and partly Hebrew. The latter is not unlike that of Ezekiel, though less impure and corrupt, and not so replete with anomalous grammatical forms. The Chaldee is noways that of the Chaldeans proper,

HARMONY OF DANIEL'S PROPHECIES OF THE

HISTORY.

I. *Babylonian Empire.*

This is depicted at its acme under Nebuchadnezzar, who attained the universal sovereignty of Western Asia and Egypt. Griffins or winged lions are a common emblem on the Assy-

rian sculptures. The empire subsequently degenerated, and, at the same time, became more civilized.

II. *Persian Empire.*

The original element was Media, where bears abound. Persia was the higher horn and more elevated side. The three ribs are probably Lydia, Assyria, and Bablyonia, which were successively absorbed by Cyrus. He was victorious in every direction except eastward. The kings following him were: 1. Cambyses; 2. Smerdis; 3. Darius Hytaspis; 4. Xerxes, who first exerted all his resources against Greece.

III. *Macedonian Empire.*

Copper denotes the mercenary Greeks. The leopard represents their slyness and perversity. The four wings are indicative of double velocity. Alexander marched with unexampled rapidity. He was the sole ruler of his dynasty. His do-

minions were divided, shortly after his premature death, between, 1. Ptolemy, in Egypt and the Mediterranean coast; 2. Seleucus, in Asia; 3. Lysimachus, in Thrace; 4. Cassander, in Greece.

IV. *Syrian Monarchy.*

This was of a mongrel character, the native Oriental element corresponding to the clay, and the foreign Greek to the iron. These were combined in all sorts of affinities. The ten toes may symbolize the numerous satrapies which fell to the share of Seleucus. This dynasty is depicted as fierce, from contrast with the lenient governments preceding, and especially from its intolerance towards the Jewish religion.

1. *Seleucus Nicator* was originally Ptolemy's general at Babylon, but soon managed to secure not only the entire East, but also the province of Syria (including Palestine). 2. *Antiochus Soter* was engrossed with subduing the Gauls. 3. *Antiochus Theos* made peace with Ptolemy Philadelphus by marrying Berenice, his daughter; but soon repudiated her in favor of Laodice, his former wife, who revenged herself by poisoning him and killing her rival with her infant.

Berenice's brother, Ptolemy Euergetes, avenged her death by invading Syria, carrying away immense spoil.

4. *Seleucus Callinicus* attempted to retaliate by attacking the Egyptian provinces (translate, ver. 9, "And he (the king of the north) shall come into the kingdom of the king of the south"), but was forced to retire with defeat. 5. *Seleucus Ceryanus*, his son, renewed the attempt, but was slain; and his brother, 6. *Antiochus the Great*, pushed the campaign to the border of Egypt.

This roused Ptolemy Philopator, who assembled an army, with which he totally routed Antiochus at Gaza; but he then concluded a truce with him.

Fourteen years afterwards, Antiochus returned with the spoils of his Eastern campaigns to renew his designs against

CHAP. II.

31 Then, O king, sawest, and beheld a great image, whose brightness was excellent, stood before thee; and the four thereof were terrible.

32 This image's head was of fine gold,

his breast and his arms of silver,

his belly and his thighs of brass,

33 His legs of iron, his feet part of iron and part of clay.

CHAP. II.

37 Then, O king, saw a kingdom of kings: for the God of heaven hath given thee a kingdom, power, and strength, and glory.

38 And whosoever the children of men dwell, the beasts of the field and the fowls of the heaven hath he given into thine hand, and hath made thee ruler over them all. Thou art the head of gold.

39 And after thee shall arise another kingdom inferior to thee,

and another third kingdom of brass, which shall bear rule over all the earth.

40 And the fourth kingdom shall be strong as iron: forasmuch as iron breaketh in pieces, and subverteth all things: and as iron that breaketh all these, shall it break in pieces and bruise.

41 And whereas thou sawest the feet and toes, part of potters' clay, and part of iron, the kingdom shall be divided: but there shall be in it of the strength of the iron, forasmuch as thou sawest the iron mixed with miry clay.

42 And as the toes of the feet were part of iron and part of clay, so the kingdom shall be partly strong and partly broken.

43 And whereas thou sawest iron mixed with miry clay, they shall mingle themselves with the seed of men: but they shall not cleave one to another, even as iron is not mixed with clay.

CHAP. VII.

2 Daniel speak and saw, and beheld, the four corners of the heaven stood open upon a great sea. Four great winds came up from the sea, and one from another.

4 The first was like a lion and had eagle's wings:

I beheld till the wings thereof were plucked, and it was lifted up from the earth, and made stand upon its feet as a man, and a man's lot was given to it.

5 And behold another bear, a second, like to a first, and it raised up itself on one side, and it had three ribs in its mouth of it between those of it: and they said thus of it, Arise, devour much flesh.

6 After this I beheld, and, lo, a fourth, which had upon the back of it four wings of a fowl; the bear had also four heads; and dominion was given to it.

7 After this I saw in the night visions, and beheld a fourth beast, dreadful and terrible, and strong exceedingly; and it had great horns: it devoured and brake in pieces, and stamped its residue with the feet of it; and it was diverse from all the beasts that were before it;

and it had ten horns.

FOUR GREAT ORIENTAL KINGDOMS.

CHAP. VII.

CHAP. VII.

CHAP. VIII.

CHAP. VIII.

CHAP. XI.

1 These great
beasts, which are
four, are
four kings,
and shall arise
of the earth.

1 Then I would
know the truth of
the fourth beast,
which was diverse
from all the others,
whose teeth were of
iron, and his nails
like brass; which
devoured and brake
in pieces, and stamped
his residue with his
feet.

10 And of the ten
horns that were in
his head,

23 Thus he said,
The fourth beast
shall be the fourth
kingdom upon
earth, which shall
be diverse from all
kingdoms, and shall
devour the whole
earth, and shall
brake it down, and
break it in pieces.

14 And the ten
horns out of this
kingdom are ten
kings: and shall
arise:

3 Then I lifted up mine eyes, and saw, and behold, there stood before the river a ram which had two horns: and the two horns were high; but one was higher than the other, and the higher came up last.

4 I saw the ram pushing westward, and northward, and southward; so that no beasts might stand before him, neither was there any that could deliver out of his hand; but he did according to his will, and became great.

5 And as I was considering, behold, a he-goat came from the west on the face of the whole earth, and touched not the ground: and the goat had a notable horn between his eyes.

6 And he came to the ram that had two horns, which I had seen standing before the river, and ran unto him in the fury of his power.

7 And I saw him come close unto the ram, and he was moved with choler against him, and smote the ram, and brake his two horns: and there was no power in the ram to stand before him, but he cast him down to the ground, and stamped upon him: and there was none that could deliver the ram out of his hand.

8 Therefore the he-goat waxed very great: and when he was strong, the great horn was broken; and for it there came up four notable ones toward the four winds of heaven.

20 The ram which thou sawest having two horns are the kings of Media and Persia.

21 And the rough goat is the king of Grecia: and the great horn that is between his eyes is the first king.

22 Now that being broken, whereas four stood up for it, four kingdoms shall stand up out of the nation, but not in his power.

9 And now will I shew thee the truth. Behold, there shall stand up yet three kings in Persia; and the fourth shall be far richer than they all:

and by his strength through his riches he shall stir up all against the realm of Grecia.

10 And a mighty king shall stand up, that shall rule with great dominion, and do according to his will.

4 And when he shall stand up, his kingdom shall be broken, and shall be divided toward the four winds of heaven; and not to his posterity; nor according to his dominion which he ruled: for his kingdom shall be plucked up, even for others besides those.

5 And the king of the south shall be strong, and one of his princes; and he shall be strong above him, and have dominion; his dominion shall be a great dominion.

6 And in the end of years they shall join themselves together; for the king's daughter of the south shall come to the king of the north to make an agreement: but she shall not retain the power of the arm; neither shall he stand, nor his arm: but she shall be given up, and they that brought her, and he that begat her, and he that strengthened her in these times.

7 But out of a branch of her roots shall one stand up in his estate, which shall come with an army, and shall enter into the fortress of the king of the north, and shall deal against them, and shall prevail.

8 And shall also carry captives into Egypt their gods, with their princes, and with their precious vessels of silver and of gold; and he shall continue more years than the king of the north.

9 So the king of the south shall come into his kingdom, and shall return into his own land.

10 But his sons shall be stirred up, and shall assemble a multitude of great forces: and one shall certainly come, and overflow, and pass through: then shall he return, and be stirred up, even to his fortress.

11 And the king of the south shall be moved with choler, and shall come forth and fight with him, even with the king of the north: and he shall set forth a great multitude; but the multitude shall be given into his hand.

12 And when he hath taken away the multitude, his heart shall be lifted up; and he shall cast down many ten thousands: but he shall not be strengthened by it.

13 For the king of the north shall return, and shall set forth a multitude greater than the former, and shall certainly come after certain years with a great army and with much riches.

HARMONY OF DANIEL'S PROPHECIES OF THE

the Egyptian provinces, and, with the assistance of a party of the Jews, he defeated the Egyptian general at the sources of the Jordan, besieged and captured the remainder of the Egyptian force in Zidon, and got full possession of Palestine. He now concluded a hollow alliance with Ptolemy Epiphanes, giving him his daughter Cleopatra, with the Palestinian provinces as a dowry, hoping that she would favor his purposes, an expectation in which he was ultimately disappointed. He then

turned his arms against the Greek colonies of Asia Minor and the Aegean till checked by the Romans under Scipio, who compelled him to sue for peace on the most humiliating terms. He was killed while attempting to plunder a temple in his own dominions. 7. *Seleucus Philopator* was engrossed with efforts to raise the enormous fine imposed by the Romans upon his father as the price of peace, and was at length assassinated by his minister, 8. *Heliodorus*, who held the throne a short time, although, 9. *Demetrius Soter*, son of the last king, was rightfully heir, and, 10. *Ptolemy Philometor* was entitled to the Palestinian provinces by virtue of his mother's dowry right.

11. *Antiochus Epiphanes*, brother of Seleucus, artfully and quietly secured the succession, expelling Heliodorus, and ignoring the claims of his nephews Demetrius and Ptolemy. (Daniel styles him "vile," in contrast with his surname "illustrious," and notes the Hellenizing corruptions of his reign in Judaea, as detailed below.) The guardians of the latter

prince resenting this, a struggle ensued, in which Antiochus twice defeated the Egyptians in a pitched battle on their own borders. He then pretended to make a truce with them, but only used it as a cover for entering Egypt with a small force, and seizing quietly upon the capital and other points. On his

return from his second campaign into Egypt, he endeavored to carry out the scheme of introducing Greek customs among the Jews. In a third campaign he continued his successes, and in a fourth he was likely to capture Alexandria and reduce the whole Egyptian power, when he was peremptorily ordered to desist by the Romans. On his way home he vented his cha-

grin at this interference upon the unhappy Jews, in whose quarrels he meddled, deposing the high-priest, abolishing the sacrificial offerings, interdicting the ritual, and bitterly persecuting all who refused to apostatize to paganism. The Temple remained closed to all but heathen victims for three years and a half (1290 days), and was shortly afterwards rededicated on Dec. 25, B. C. 165 (making 1335 days), six and a half years (2300 days) from the first act of profanation in the removal of the legitimate pontiff. Antiochus's disregard for even the native deities is evident from his renewal of his father's attempt to plunder the temple of the Syrian Venus. Yet he made the most violent efforts to introduce the worship of Jupiter Capitolinus.

The remainder of his reign is obscure, owing to the nearly total loss of the ancient records concerning it. We have therefore but slight intimations of the final expedition against Egypt, etc., referred to by Daniel as being so successful. It is certain, however, that the last act of his reign was a campaign in the north-eastern provinces, and that he perished miserably (one account says as a raving maniac) as he was hastening to the support of his generals, who had been defeated by the Jewish patriots and zealots. The Maccabees had raised the standard of civil and religious liberty in Judaea, and, after a long and severe struggle, the Jews secured their independence. This they retained for a century, a period of great political and spiritual prosperity in general, which Daniel and the other prophets speak of in such glowing terms as being introductory to the Messianic times, the Gospel "kingdom of Heaven," never to end.

CHAP. II.

CHAP. II.

CHAP. VIII.

CHAP. VII.

24 Thou sawest till that a stone was cut out without hands, which smote the image upon his feet that were of iron and clay, and brake them to pieces. 25 Then was the iron, the clay, the brass, the silver, and the gold, broken to pieces together, and became like the chaff of the summer threshing-floors; and the wind carried them away, that no place was found for them:

44 And in the days of these kings shall the God of heaven set up a kingdom which shall never be destroyed: and the kingdom shall not be left to other people, but it shall break in pieces and consume all these kingdoms, and it shall stand forever. 45 Forasmuch as thou sawest that the stone was cut out of the mountain without hands, and that it brake in pieces the iron, the brass, the clay, the silver, and the gold, the great God hath made known to the king what shall come to pass hereafter: and the dream is certain, and the interpretation thereof sure.

8 I considered the horns, and, behold, there came up among them another little horn, the fire whereof these were three of the first horns plucked up by the roots: and, behold, in this horn were eyes like the eyes of man, and a mouth speaking great things.

9 I beheld till the thrones were cast down, and the Ancient of days did sit, whose garment was white as snow, and the hair of his head like the pure wool: his throne was like the fiery flame, and his wheels as burning fire. 10 A fiery stream issued and came forth from before him: thousands multiplied toward him, and ten thousand times ten thousand stood before him: the judgment was set, and the books were opened. 11 I saw in the night visions, and, behold, one like the Son of man came with the clouds of heaven, and came to the Ancient of days, and they brought him near before him. 12 And there was given him dominion, and glory, and a kingdom, that all people, nations, and languages should serve him: his dominion is an everlasting dominion, which shall not pass away, and his kingdom that which shall not be destroyed.

and of the eye which was upon his forehead; and he fell; and we bore that he said, and a month he spoke very great things, which we were unwilling to follow.

11 I beheld also because of the wrath of the great one, which he was speaking.

I beheld see, the best result, and the hair of his beard, they in their dominion set away, yet the throne was granted for a seat of thine.

and the stone that smote the image became a great mountain, and filled the whole earth.

12 But the end of the Most High shall take down the kingdom of the living, and shall give it to the living God, and shall give it to the living God.

CHAP. VII.

CHAP. VIII.

CHAP. VIII.

CHAP. XI.

CHAP. XII.

CHAP. XII.

and another shall rise over them; and he shall be diverse from the first, and he shall subdue three kings.

9 And out of one of them came forth a little horn, which waxed exceeding great, toward the south, and toward the east, and toward the pleasant land.

11 And it waxed great, even to the host of heaven; and it cast down some of the stars to the ground, and stamped upon them.

31 I beheld, and the same horn made war with the saints, and prevailed against them; 35 And he shall speak great words against the Most High, and shall wear out the saints of the Most High, and think to change the times and laws: and they shall be given into his hand until a time, and the dividing of time.

39 Until the Ancient of days came, and judgment was given to the saints of the Most High; and the time came that the saints possessed the kingdom.

41 But the judgment shall sit, and they shall take away his dominion, to consume and to destroy it unto the end.

37 And the kingdom and dominion, and the greatness of the kingdom under the whole heaven, shall be given to the people of the saints of the Most High, whose kingdom is an everlasting kingdom, and all dominions shall serve and obey him.

11 Yes, he magnified himself even to the prince of the host, and by him the daily sacrifice was taken away, and the sanctuary was cast down.

12 And a host was given him against the daily sacrifice, by reason of transgression, and it cast down the truth to the ground; and it practised and prospered.

13 Then I heard one saint speaking, and another said unto that certain, *tain unto which shall be the vision concerning the daily sacrifice, and the transgression of the sanctuary, and the host to be trodden under foot.*

14 And he said unto me, Unto two thousand and three hundred days; then shall the sanctuary be cleansed.

32 And in the latter time of their kingdom, when the transgressors are come to the full, a king of fierce countenance, and understanding dark sentences, shall stand up.

34 And his power shall be mighty, but not by his own power; and he shall destroy wonderfully, and shall prosper, and practise, and shall destroy the mighty and the holy people.

35 And through his policy also he shall cause craft to prosper in his hand; and he shall magnify himself in his heart, and by peace shall destroy many: he shall also stand against the Prince of princes;

36 And the vision of the evening and the morning which was told is true: wherefore thou shalt fear: for it shall come to pass in many days.

14 And in those times there shall many stand up against the king of the south: also the robbers of thy people shall exalt themselves to establish the vision; but they shall fall.

15 So the king of the north shall come, and cast up a mound, and shall take the most fenced cities: and the arms of the south shall not withstand, neither his chosen people, neither shall there be any strength to withstand.

16 But he that cometh against him shall do according to his own will, and none shall stand before him: and he shall stand in the glorious land, which by his hand shall be consumed.

17 He shall also set his face to enter with the strength of his whole kingdom, and upright ones with him; thus shall he do: and he shall give him the daughter of women, compelling her: but she shall not stand on his side, neither be for him.

18 After this shall he turn his face unto the isles, and shall take many: but a prince for his own behalf shall cause the reproach offered by him to cease; without his own reproach he shall cause it to turn upon him.

19 Then he shall turn his face toward the fort of his own land: but he shall stumble and fall, and not be found.

20 Then shall stand up in his estate a raiser of taxes in the glory of the kingdom: but within few days he shall be destroyed, neither in anger, nor in battle.

21 And in his estate shall stand up a vile person, to whom they shall not give the honor of the kingdom: for he shall come in peaceably, and obtain the kingdom by flatteries.

22 And with the arms of a flood shall they be overflowed from before him, and shall be broken; yea, also the prince of the covenant.

23 And after the league made with him he shall work deceitfully: for he shall come up, and shall become strong with a small people.

24 He shall enter peaceably even upon the fattest places of the province; and he shall do that which his fathers have not done, nor his fathers' fathers; he shall scatter among them the prey, and spoil, and riches; yea, and he shall forecast his devices against the strong holds, even for a time.

25 And he shall stir up his power and his courage against the king of the south with a great army; and the king of the south shall be stirred up to battle with a very great and mighty army; but he shall not stand; for they shall forecast devices against him.

26 Yea, they that feed of the portion of his meat shall destroy him, and his army shall overflow: and many shall fall down slain.

27 And both these kings' hearts shall be to do mischief, and they shall speak lies at one table; but it shall not prosper: for yet the end shall be at the time appointed.

28 Then shall he return into his land with great riches; and his heart shall be against the holy covenant; and he shall do exploits, and return to his own land.

29 At the time appointed he shall return, and come toward the south; but it shall not be as the former, or as the latter.

30 For the ships of Chittim shall come against him: therefore he shall be grieved, and return, and have indignation against the holy covenant: so shall he do; he shall even return, and have intelligence with them that forsake the holy covenant.

31 And arms shall stand on his part, and they shall pollute the sanctuary of strength, and shall take away the daily sacrifice, and they shall place the abomination that maketh desolate.

32 And such as do wickedly against the covenant shall be corrupt by flatteries: but the people that do know their God shall be strong, and do exploits.

33 And they that understand among the people shall instruct many: yet they shall fall by the sword, and by flame, by captivity, and by spoil, many days.

34 Now when they shall fall, they shall be helped with a little help: but many shall cleave to them with flatteries.

35 And some of them of understanding shall fall, to tread them, and to purge, and to make them white, even to the time of the end: because it is yet for a time appointed.

36 And the king shall do according to his will; and he shall exalt himself, and magnify himself above every god, and shall speak marvellous things against the God of gods, and shall prosper till the indignation be accomplished: for that that is determined shall be done.

37 Neither shall he regard the god of his fathers, nor the desire of women, nor regard any god: for he shall magnify himself above all.

38 But in his estate shall he honor the God of forces: and a god whom his fathers knew not shall he honor with gold, and silver, and with precious stones, and with gold images.

39 Thus shall he do in the most strong holds with a strange god, whom he shall acknowledge and increase with glory: and he shall cause them to rule over many, and shall divide the land for gain.

40 And at the time of the end shall the king of the south push at him: and the king of the north shall come against him like a whirlwind, with chariots, and with horsemen, and with many ships; and he shall enter into the countries, and shall overflow and pass over.

41 He shall enter also into the glorious land, and many countries shall be overthrown: but these shall escape out of his hand, even Edom, and Moab, and the chief of the children of Ammon.

42 He shall stretch forth his hand also upon the countries: and the land of Egypt shall not escape.

43 But he shall have power over the treasures of gold and of silver, and over all the precious things of Egypt; and the Libyans and the Ethiopians shall be at his steps.

44 And he shall utter out of the east, and out of the north shall trouble him: therefore he shall go forth with great fury to destroy, and utterly to make away many.

45 And he shall plant the tabernacles of his palace between the seas in the glorious holy mountain; yet he shall come to his end, and none shall help him.

10 Many shall be purified, and made white, and tried; but the wicked shall do wickedly: and none of the wicked shall understand.

7 And I heard the man clothed in linen, which was upon the waters of the time that the daily river, when he held sacrifice shall be up his right hand taken away, and his left hand the abomination unto heaven, and that maketh desolate by him that late set up, *there liveth forever, that shall be a thousand times, and a half ninety days.* and when he shall have accomplished that, and to scatter the power of the holy people, all these things and five and thirty days shall be finished.

but a corrupt vernacular dialect, a mixture of Hebrew and Aramaic, formed during the period of the exile. It resembles mostly the Chaldee pieces in Ezra, but differs greatly from the dialect of the later Targums (see Hilgenfeld, *Ezra u. Dan. und ihre neuesten Bearbeitungen*, Halle, 1863). See CHALDEE LANGUAGE.

The style is, even in the prophetic parts, more prosaic than poetical, as Lowth has already observed. The historical descriptions are usually very broad and prolix in details; but the prophecies have a more rhetorical character, and their delivery is frequently somewhat abrupt; their style is descriptive, painting with the most lively colors the still fresh impression which the vision has made on the mental eye.

3. The unity of the book has been disputed by several critics, and more especially by Eichhorn and Bertholdt, who conceived it to have been written by more than one author, on account of some contradictions which they thought they had discovered in it, such as in i, 21, compared with x, 1; and in i, 5-18, compared with ii, 1. With regard to the first supposed contradiction, we consider the meaning of i, 21, to be that Daniel had lived to see the first year of the reign of Cyrus, as a particularly memorable, and, for the exiled people, a very important year. This does by no means exclude the possibility of his having lived still longer than up to that period.

Respecting the second presumed contradiction, the matter in ch. i, 5-18, belongs properly to the co-regency of Nebuchadnezzar, which term is there added to his period of government, while in ch. ii, 1, his reign is counted only from the year of his actual accession to the throne. These attempts to disturb the harmony of the work are also discountenanced by the connecting thread which evidently runs through the whole of the book, setting the single parts continually in mutual relation to each other. Indeed, most critics have now given up that hypothesis, and look at the book as a closely connected and complete work in itself.

4. Much greater is the difference of opinion respecting the *authenticity* of the book. The oldest known opponent of it is the heathen philosopher Porphyry, in the third century of the Christian era. The greater the authority in which the book of Daniel was held at that time by both Jews and Christians in their various controversies, the more was he anxious to dispute that authority, and he did not disdain to devote one whole book (the twelfth)—out of the fifteen which he had composed against the Christians—to that subject alone. He there maintains that the author of the book of Daniel was a Palestinian Jew of the time of Antiochus Epiphanes, that he wrote it in Greek, and fraudulently gave to *past* events the form of prophecies. Porphyry was answered by Eusebius of Cæsarea, Methodius of Tyre, and Apollinaris of Laodicea. But their works, as well as that of Porphyry himself, are lost; and we know the latter only from the numerous quotations and refutations in the Commentary of Jerome.

Porphyry found no successor in his views until the time of the English deists, when Collins attempted to attack the authenticity of Daniel, as was done by Semler in Germany. After this a few critics, such as J. D. Michaelis and Eichhorn, disputed the authenticity of the first six chapters. The learned Swiss, Corrodi (*Freimüth. Versuch*, etc., Berlin, 1783), went still further, and, reviving the views of Porphyry, questioned the genuineness of the *whole* book. The question of the authenticity of the book is discussed in most of the later commentaries, and specially by Hengstenberg (*Die Authentizität des Dan. erwiesen*, 1831, translated by Ryland, Edinb. 1847, 8vo), Hävernick (*Neue krit. Untersuch.* Hamb. 1838, 8vo), Delitzsch (in Herzog's *Encyklopädie*, s. v. 1854), Keil (*Lehrb. der Einl. in der A. T.* Frank. 1853, 8vo), Davidson (*Introduction to the O. T.* ii, Lond. 1846, 8vo), who maintain the affirmance; and by Bleek (*Berl. theolog. Zeitschr.* iii, 1822),

Bertholdt (*Einleit.* Erlang. 1814), Lücke (*Versuch der vollst. Einl.* 2d ed. Bonn. 1852), and De Wette (*Einleit.* 7th ed. Berl. 1852), who deny its authenticity. See Ewald (*Die Proph. d. Alt. Bund.* ii, 569 sq.).

The real grounds on which most modern critics rely in rejecting the book are the "fabulousness of its narratives" and "the minuteness of its prophetic history." "The contents of the book," it is said, "is irrational and impossible" (Hitzig, § 5). It is obvious that it is impossible to answer such a statement without entering into general views of the providential government of the world. It is admitted that the contents of the book are exceptional and surprising; its revelation is itself a miracle, however it be given, as essentially as inconceivable as any miracle. There are times, perhaps, when it is required that extraordinary signs should arrest the attention of men, and fix their minds upon that Divine Presence which is ever working around them. Prodiges may become a guide to nature. Special circumstances may, and, according to the Bible, usually do determine, the peculiar form which the miraculous working of God will assume in a particular time; so that the question is, whether there is any discernible relation between the outward wonders and the moral condition of an epoch. Now it is impossible to apply this remark to the case of Daniel. The position which he occupied was as exceptional as the book which bears his name. He survived the exile and the disappointment which attended the first hopes of the Jews. The glories which had been connected with the return in the foreshortened vision of earlier prophets were now felt to be far off, and a more special revelation may have been necessary as a preparation for a period of silence and conflict. The very character of the Babylonian exile seems to have called for some signal exhibition of divine power. As the first exodus was distinguished by great marvels, it might appear natural that the second should be the same (comp. Mic. vii, 15; Delitzsch, p. 272, etc.). National miracles, so to speak, formed the beginning of the theocracy; personal miracles, the beginning of the Church. To speak of an "aimless and lavish display of wonders" is to disregard the representative significance of the different acts, and the relation which they bore to the future fortunes of the people. A new era was inaugurated by fresh signs. The Jews, now that they were left among the nations of the world, looked for some sure token that God was able to deliver them and work out his own purposes. The persecution of Antiochus completed the teaching of Daniel; and the people no longer sought without what at length they had found within. They had withstood the assault of one typical enemy, and now they were prepared to meet all. The close of special predictions coincided with the consolidation of the national faith. See ANTIQCHUS EPIPHANES.

The following are the more important of the arguments which evidence the genuineness of the book (see the works on the *Authenticity of Daniel*, by Boyle [Lond. 1863] and Waters [ib. eod.]).

(1.) The existence and authority of the book are most decidedly testified by the New Testament. Christ himself refers to it (Matt. xxiv, 15), and gives to himself (in virtue of the expression in Dan. vii, 13) the name of *Son of Man*; while the apostles repeatedly appeal to it as an authority (1 Cor. vi, 2; 2 Thes. ii, 3). Apart from the general type of apocalyptic composition which the apostolic writers derived from Daniel (Rev. *passim*; comp. Matt. xxvi, 64; xxi, 44), the New Testament incidentally acknowledges each of the characteristic elements of the book, its miracles (Heb. xi, 33, 34), its predictions (Matt. xxiv, 15), and its doctrine of angels (Luke i, 19, 26). To the objection that Christ and the writers of the New Testament are here no *real* authority, inasmuch as they accommodate themselves to the Jewish notions and views, we reply that the genuineness of the book of Daniel is

closely connected with the truth of its contents—in her words, that the *authenticity* of the book is so immediately connected with its *authority*—that it is impossible to doubt its *genuineness* without suspecting at the same time a wilful cheat in its contents; so that its *accommodation* in this case to national views would be tantamount to wilfully confirming and sanctioning an unpardonable fraud.

(2.) The period of the exile would be altogether incomprehensible without the existence of a man like Daniel, exercising great influence upon his own people, and effecting their return to Palestine by means of his high station in the state, as well as through the peculiar assistance of God with which he was favored. Without this assumption, it is impossible to explain the continued state of independence of the people of God during that period, or to account for the interest which Cyrus took in their affairs. The exile and its termination are indicative of uncommon acts of God towards highly-gifted and favored men; and the appearance of such a man as Daniel is described in that book as having been, is an indispensable requisite for the right understanding of this portion of the Jewish history.

(3.) An important hint of the existence of the book in the time of Alexander is found in Josephus (*Ant.* xi, 8, 4), according to which the prophecies of Daniel had been pointed out to that king on his entrance into Jerusalem. It is true that the fact may have been somewhat embellished in its details by Josephus, yet it is historically undeniable that Alexander did bestow great favors on the Jews, a circumstance which is not easily explained without granting the fact recorded by Josephus to be true in the main. See ALEXANDER (THE GREAT).

(4.) The first book of the Maccabees, which is almost contemporary with the events related in it, not only presupposes the existence of the book of Daniel, but actually betrays acquaintance with the Alexandrian version of the same (1 Macc. i, 54; comp. Dan. ix, 27; ii, 59; comp. Dan. iii), a proof that the book must have been written long before that period.

(5.) If the book had been written in the Maccabean period, there would probably have been produced in that period some similar prophetic and apocalyptic productions, composed by Palestinian Jews. Of such, however, not the slightest notice can anywhere be found; so that our book—if of the Maccabean time—forms an isolated enigmatical phenomenon in the later Jewish literature.

(6.) The reception of the book into the canon is also an evidence of its authenticity. In the Maccabean age the canon had long been completed and closed; but, even doubting that point, it is not likely that, at a time when so much scrupulous adherence was shown towards all that was hallowed by time and *old* usage, and when scriptural literature was already flourishing—it is not probable, we say, that a production then recent should have been raised to the rank of a canonical book.

(7.) We have an important testimony for the authenticity of the book in Ezek. xiv, 14, 20; xxviii, 3. Daniel is there represented as an unusual character, as a model of justice and wisdom, to whom had been allotted superior divine insight and revelation. This sketch perfectly agrees with that contained in our book.

(8.) The book betrays such an intimate acquaintance with Chaldean manners, customs, history, and religion as none but a contemporary writer can fairly be supposed to possess. Thus, e. g. the description of the Chaldean magicians and their regulations perfectly agrees with the accounts of the classics respecting them. The account of the illness and insanity of Nebuchadnezzar is confirmed by Berossus (in Joseph. *c. Apion.* i, 20). The edict of Darius the Mede (Dan. v) may be satisfactorily explained from the notions

peculiar to the Medo-Persian religion, and the importance attached in it to the king, who was considered a sort of incarnate deity. The scene and characters of the book are *Oriental*. The colossal image (דָּגָל, iii, 1, not necessarily a human figure; the term is applied familiarly to the cross, Buxtorf, *Lex. Rab.* s. v.), the fiery furnace, the martyr-like boldness of the three confessors (iii, 16), the decree of Darius (vi, 7), the lions' den (vi, 7, 19, זֶבֶד), the demand of Nebuchadnezzar (ii, 5), his obeisance before Daniel (ii, 46), his sudden fall (iv, 33; comp. Eusebius, *Præp. Ev.* ix, 41; Joseph. *c. Ap.* i, 20), are not only consistent with the nature of Eastern life, but in many instances directly confirmed by other evidence. (See DARIUS THE MEDE for the difficulties of i, 1; ii, 1; v, 31.)

(9.) The religious views, the ardent belief in the Messiah, the purity of that belief, the absence of all the notions and ceremonial practices of later Judaism, etc., the agreement of the book in these respects with the genuine prophetic books, and more especially with the prophets in and after the exile—all this testifies to the genuineness of Daniel. In doctrine the book is closely connected with the writings of the exile, and forms a last step in the development of the ideas of Messiah (vii, 13, etc.), of the resurrection (xii, 2, 3), of the ministry of angels (viii, 16; xii, 1, etc.), of personal devotion (vi, 10, 11; i, 8), which formed the basis of later speculations, but received no essential addition in the interval before the coming of our Lord.

(10.) The linguistic character of the book is most decisive for its authenticity. In the first instance, the language in it, by turns Hebrew and Aramaean, is particularly remarkable. In that respect the book bears a close analogy to that of Ezra. The author must certainly have been equally conversant with both languages—an attainment exactly suited to a Hebrew living in the exile, but not in the least so to an author in the Maccabean age; when the Hebrew had long since ceased to be a living language, and had been supplanted by the Aramaean vernacular dialect. The Hebrew in Daniel bears, moreover, a very great affinity to that in the other later books of the Old Testament, and has, in particular, idioms in common with Ezekiel. The Aramaic, also, in the book differs materially from the prevailing dialect of the later Chaldaean paraphrastic versions of the Old Testament, and has much more relation to the idiom of the book of Ezra. Nor is the mention of Greek musical instruments (iii, 5, 7, 10, קִיָּרִים, *κithara*; סַמְבֻּכִּים, *sambuki*; חֲבִיבִּימִים, *συμφωνία*; פְּסַלְטִיּוֹן, *ψαλτήριον*), for these words only can be shown to be derived from the Greek (De Wetze, *Eint.* p. 255 b.), other than suitable to a time when the intercourse of the East and West was already considerable, and when a brother of Alcæus (B. C. 600-500) had gained distinction "at the farthest end of the world, aiding the Babylonians" (*Alc. Frag.* 33, Bergk.; Brandis, in Delitzsch, p. 274). (For a full view of the criticism, history, and literature of the book of Daniel, see Stuart's *Commentary*, p. 373-496.)

5. There is no Chaldee translation of Daniel, and the deficiency is generally accounted for, as in the parallel case of Ezra, by the danger which would have existed in such a case of confounding the original text with the paraphrase; but, on the other hand, the whole book has been published in Hebrew. Kennicott prepared a special commentary on the Chaldee portions (ed. Schulze, Hal. 1782, 8vo); comp. Bird (*Lectures*, Lond. 1845).

The Greek version has undergone singular changes. At an early time the Sept. translation was supplanted in the Greek Bibles by that of Theodotion, which in the time of Jerome was generally "read by the churches" (*c. Rufin.* ii, 33; *Præf. in Comm.*). This change, for which Jerome was unable to account (*Præf. in Vers. Dan.*), may have been made in consequence of

the objections which were urged against the corrupt Sept. text in controversy with Jews and heathen. The Sept. version was certainly very unfaithful (Jerome, l. c.); and the influence of Origen, who preferred the translation of Theodotion (Jerome in *Dan.* iv, 6), was probably effectual in bringing about the substitution (comp. Credner, *Beitr.* ii, 256 sq.). In the course of time, however, the version of Theodotion was interpolated from the Sept., so that it is now impossible to recover the original text. Comp. Wald, *Cura in hist. textus Dan.* (Lips. 1788). See DANIEL, APOCRYPHAL ADDITIONS TO. Meanwhile the original Sept. translation passed entirely out of use, and it was supposed to have been lost till the last century, when it was published at Rome from a *Codex Chisianus* (*Daniel secundum LXX.* . . . Romæ, 1772, ed. P. de Magistris), together with that of Theodotion, and several illustrative essays. It has since been published several times (ed. Michaelis, Gotting. 1774; ed. Segaar, Utrecht, 1775; ed. Hahn, Lpz. 1845), and lastly by Tischendorf in the second edition of his *Septuagint* (Lips. 1866). Another recension of the text is contained in the Syro-Hexaplaric version at Milan (ed. Bugatus, 1788); but a critical comparison of the several recensions is still required. See SEPTUAGINT.

On other ancient versions, see Münster, *Spec. versio-nis Dan. Copticarum.* etc. (Rom. 1786); Wald, *Ueb. d. Arab. Uebers. d. Dan.* (in Eichhorn's *Repertor.* xiv, 206 sq.). See VERSIONS.

6. The commentaries on Daniel are very numerous. Those in Hebrew by R. Saadiah Haggaon († 942), Rashe († c. 1105), and Aben Ezra († c. 1167), are printed in the great Rabbinic Bibles of Bomberg and others. That of Abarbanel († c. 1507) has been printed separately several times (Amst. 1647, 4to), and others are enumerated below. Among the patristic commentaries the most important is that of Jerome (vol. v, ed. Migne), who noticed especially the objections of Porphyry; also those of Chrysostom (*Op.* vi, 228), Theodoret (ii, 1053 sq., ed. Schulze; *Interp.* Gabio, Rom. 1562, fol.), and Ephraem Syrus (*Op. Syr.* ii, Romæ, 1740). There are also annotations by Rupert Tuitiensis (*Opera*, i, 520), Thos. Aquinas [rather Thos. Walen-lensis] (*Commentarii*, etc., Paris, 1641, fol.), Albertus Magnus (*Opera*, viii), and Peter the Archdeacon (Martene and Durand's *Collectio*, ix, 275). Considerable fragments remain of the commentaries of Hippolytus (collected in Migne's edition, Paris, 1857) and Polychronius (*Mai, Script. Vet. Nov. Coll.* vol. i); and Mai has published (*ib.*) a catena on Daniel, containing fragments of Apollinaris, Athanasius, Basil, Eusebius, and many others. The chief reformers, Luther (*Auslegung d. Proph. Dan.* 1530-1546; *Op.* Germ. vi, ed. Walch), Æcolampadius (*In Dan. libri duo*, Basil. 1530), Melancthon (*Comm. in Dan. proph.* Vitemb. 1543), and Calvin (*Prælect. in Dan.* Genevæ, 1568, etc.; in French, 1565; in English, Lond. 1852-3), wrote on Daniel; also Joachim the Abbot (Ven. 1519, 4to). A comparison of the prophecies of Daniel with the visions of the Apocalypse (Newton, *On the Prophecies*, London, 1783, 4to) opened the way to a true understanding of Daniel. Auberlen (*Der Proph. Dan. u. d. Offenbarung Joh.* etc. 2d ed. Basel, 1857, translated into English from the 1st ed. by Saphir, 1856, 12mo) has thrown considerable light upon the general construction and relations of the book. Comp. Hofmann, *Weissag. u. Erfüllung*, i, 276 sq.; Burton, *Numbers of Daniel and John* (Norw. 1766-8); Anon., *Seven prophetic Periods* (Lond. 1790); Birks, *The four prophetic Empires* (London, 1844), and *The two later Visions of Daniel* (ib. 1846); Elliott, *Horæ Apocalypticæ* (Lond. 1844); Tregelles, *Remarks on the prophetic Visions of Daniel* (Lond. 1852); Stuart, *Hints on Prophecy* (Andov. 1844); Desprez, *Daniel the Apocalypse of the O. T.* (Lond. 1865, 8vo). See REVELATION. Among subsidiary works additional to the above may be named Bleek, *Weissag. in D.* (in the *Jahrb. f. Deutsche Theol.* 1860, v); Wal-

ter, *Genuineness of Daniel* (Lond. 1862); Barman, in the *Stud. u. Krit.* 1863, iv; Fuller, *Authenticity of Daniel* (Camb. 1864); Bosanquet, *Inspiration of Daniel* (Lond. 1866); Harman, in the *Met. Quart. Rev.* etc., 1854.

Other special exegetical works on the entire book or principal portions of it, are the following, of which the most important are designated by an asterisk; prefixed: Bañolas, פְּרָשׁוֹת (s. l. ante 1480, 4to; and in the Rabb. Bibles); Alsheich, פְּרָשׁוֹת לְיְהוֹנָתָן (Sedl. 1568, 4to, and since); Teitsak, פְּרָשׁוֹת לְיְהוֹנָתָן (Ven. 1608, 4to); Joy, *Exposition* (Genev. 1545, 16mo; Lond. 1550, 8vo); Draconites, *Commentarius* (Marb. 1548, 8vo); *Suaniungis, *Commentarii* (Havn. 1554-66, 12mo, 1688, 2 vols. fol.); Strigelius, *Concio* (Lips. 1565, 12mo, 1572, 8vo); Selnecker, *Erklärung* (Jen. 1567, 1608, 8vo); Wigand, *Explicatio* (Jen. 1571, Erf. 1581, 8vo); Bellingier, *Homilia* (Tigur. 1576, fol.); Pinta, *Commentarii* (Conimb. 1582, 8vo; Ven. 1583, 4to; Colon. 1585, 8vo); Pererius, *Commentarii* (Rom. 1585, fol.; Lugd. 1588, 4to; 1591, 1602, 8vo; Antw. 1594, 4to); Heilbrunner, *Loci communes* (Lauring. 1587, 8vo); Marcellinus, *Commentarius* (Ven. 1568, 4to); Rollock, *Commentarius* (Edinburgh, 1591, 8vo; Basil. 1594, 4to; Genev. 1598, 8vo; 1670, 4to); Junius, *Expositio* (Heldelb. 1598, Genev. 1594, 4to); Broughton, *Annotationes* (in *Works*, p. 164, 261; in Lat. ed. Boreel, Basil. 1599, 4to); Polanus, *Commentarius* (Basil. 1599, 4to; 1607, 8vo); Gesner, *Disputationes* (Viteb. 1601, 4to; 1611, 1638, 8vo); *Elucidarius* (ib. 1658, 8vo); Veldius, *Commentarius* (Antw. 1602, 8vo); Leyser, *Commentarius* (in 6 parts, Darmst. and Francof. 1609-10, 4to); Willet, *Hexapla* (Cantuar. 1610, fol.); Veld, *Commentarius* (Antwerp, 1611, 4to); Sanctius, *Commentarius* (Lugd. 1612, fol.); Rhumelius, *Paraphrasis* (Norim. 1616, 8vo); Angelocrator, *Erklärung* (Cassel, 1628, 4to); Alsted, *Trifolium* (Herb. 1640, 4to); Huit, *Paraphrasis* (London, 1643, 4to); Brightman, *Exposition* (ib. 1644, 4to); Parker, *Exposition* (ib. 1646, 4to); *Geier, *Prelectiones* (Lips. 1667, 1684, 1697, 1702, 4to); Varenia, *Animadversio* (Rost. 1667, 4to); Wingendorp, *Paraphrasis* (Leyd. 1674, 1680, 8vo); Jungmann, *Commentarius* (Cass. 1681, 4to); Moore, *Exposition* (Lond. 1682, 4to); *Answers* (ib. 1684, 4to); *Supplement* (ib. 1685, 4to); *Notes* (ib. 1685, 4to); Bekker, *Völegginge* (Amst. 1688, 1698, 4to); Meisener, *Anmerkungen* (Hamb. 1688, 12mo); Anon., *Explanation* (Lond. 1700, 12mo); Keihedere, *Prodromus* (Lovani. 1710, 8vo); Wells, *Harmonia* etc. (Lond. 1716, 8vo); Friderici, *Daniel et ejus ratiōnia* (Lpz. 1716, 4to); Musson, *Scholæ* (Quedlinb. 1719, 4to); Michaelis, *Adnotationes* (Hal. 1720, 4to); Petersen, *Sinn.* etc. (F. ad M. 1720, 4to); Koch, *Anfänger* (Lemg. 1740, 4to); Venema, *Dissertationes* (Leid. 1745, 1752, 1768, 4to); Petri, *Zahlen Daniels* (Offenb. 1768, 8vo); Roos, *Auslegung* (Lpz. 1771, 8vo; tr. into Engl. Edinb. 1811, 8vo); Harenberg, *Aufklärung* (Blankenb. and Quedlinb. 1778, 4to); Scharfenberg, *Animadversiones* (Lips. 1774, 8vo); Segaar, *Animadversiones* (Utr. 1775, 8vo); Amner, *Essay.* etc. (Lond. 1776, 8vo); Zeh, *Erklärung* (Dresd. 1777, 8vo); Holber, *D. Zeiten in d. Danielschen Weissag.* (Frkf. and Lps. 1777, 8vo); Wald, *Cura* (Lips. 1783, 4to); Müller, *Animadversiones* (Heldelb. 1786, 4to); Lüderwald, *Prüfung* (Helmst. 1787, 8vo); Volborth, *Anmerkungen* (Hanover, 1788, 8vo); Anon., *Briefe in Beyträge zum Denken in d. Bd. p. ix*); Kemmerich, *Uebers.* etc. (Helmst. 1791, 2 vols. 8vo); *Wintle, *Notes.* etc. (Oxf. 1792, 4to; Lond. 1807, 4to; 1836, 8vo); Thube, *Erklärung* (Schwerin and Wism. 1797, 8vo); *Bertholdt, *Erklärung.* etc. (Erlang. 1806, 8vo); Ben-Jachajah, פְּרָשׁוֹת (ed. Philippsohn, etc. Dessau, 1808, 4to and 8vo); Menken, *Monarchiæ* (Lond. 1815, 8vo); Griesinger, *Ansicht* (Stuttg. and Tüb. 1815, 8vo); Girdlestone, *Observations* (Oxford, 1820, 8vo); Bleek, *Verfasser u. Zweck* (in the *Theolog. Zeitschr.* Berl.

2, iii); Wilson, *Dissertations* (Oundle, 1824, 8vo); King, *Discourse* (Glasg. 1826, 2 vols. 12mo); Kirman, *amentatio* (Jen. 1828, 4to); *Rosenmüller, *Scholæia* ps. 1832, 8vo); *Hävernick, *Commentar* (Hamburg, 2, 8vo); Jetteles, *בְּנֵי יִשְׂרָאֵל*, etc. (Vienna, 1835, 8vo); t, *Lectures* (Lond. 1834, N. Y. 1836, 12mo); *Lenke, *Auslegung* (Königsb. 1835, 8vo); Tyso, *Eluciation* (London, 1838, 8vo); Farquharson, *Illustrations* (London, 1838, 8vo); Gausson, *Lectures* (London, 1840, 12mo); Miles, *Lectures* (ib. 1840-1, 2 vols. 12mo); Folsa, *Interpretation* (Boston, 1842, 12mo); Chase, *Notes* (ib. 1844, 8vo); George (Duke of Manchester), *Notes of Daniel* (Lond. 1846, 8vo); Wood, *Lectures* (ib. 17, 12mo); Jacobi, vol. 1 of *Kirchliche Lehre*, etc. Erl. 1847, 8vo); Harrison, *Outlines* (Warbur. Lect. London, 1849, 8vo); *Stuart, *Commentary* (Bost. 1850, 12mo); *Barnea, *Notes* (N. Y. 1850, 12mo); *Hitzig, *Klärung* (Lpz. 1850, 8vo); Cumming, *Lectures* (Lond. 50, 8vo); Ramsay, *Exposition* (London, 1853, 12mo); ibon, *Daniel Verified* (N. Y. 1856, 12mo); Magnin, *Notes sur D.* (Par. 1861, 8vo); Zündel, *Untersuchungen* (Lond. 1861, 8vo); Bellamy, *Translation* (Lond. 1863, 12mo); Pusey, *Lectures* (new edition, London, 1865, 4to); Irebury, *Notes* (Edinb. 1865, 8vo); Cowles, *Commentary* (N. Y. 1867, 12mo); Kranichfeld, *Erklärung* (Lond. 1868, 8vo). See PROPHETS.

DANIEL, APOCRYPHAL ADDITIONS TO, i. e. pieces found in the Greek translations, but not in the Hebrew text. See DEUTERO-CANONICAL. The most important of these additions are contained in the Apocrypha of the English Bible under the titles of *The Song of the three holy Children* (Dan. iii), *The History of Susanna* (Dan. xiii), and *The History of . . . Bel and the Dragon* (Dan. xiv). See APOCRYPHA.

I. *Their Character*.—1. The first of these pieces is incorporated into the narrative of Daniel. After the three confessors were thrown into the furnace (Dan. ii, 23), Azarias is represented as praying to God for deliverance (Song of the three Children, 8-22); and in answer the angel of the Lord shields them from the fire which consumes their enemies (23-27), whereupon 'the three, as out of one mouth,' raise a triumphant song (29-68), of which a chief part (35-66) has been used as a hymn (*Benedicite*) in the Christian Church since the fourth century (*Rufin. Apol.* ii, 85; comp. *Concil. Tolet.* iv, Can. 14). Like several similar fragments, the chief parts of this composition are given at the end of the Psalter in the Alexandrine MS. as separate psalms, under the titles of "The Prayer of Azarias" and "The Hymn of our Fathers;" and a similar arrangement occurs in other Greek and Latin psalters.

2. The two other pieces appear more distinctly as appendices, and offer no semblance of forming part of the original text. *The History of Susannah* (or *The Judgment of Daniel*) is generally found at the beginning of the book (Gr. MSS. Vet. Lat.), though it also occurs after the 12th chapter (Vulg. ed. Compl.). *The History of Bel and the Dragon* is placed at the end of the book, and in the Sept. version it bears a special heading as "*Part of the Prophecy of Habakkuk*" (*ἡ προφητεία Ἀμβακού υἱοῦ Ἰσηού ἐκ τῆς φυλῆς Λευί*).

II. *Their Currency*.—The additions are found in both the Greek texts—the Sept. and Theodotion—in the Old Latin and Vulgate, and in the existing Syriac and Arabic versions. On the other hand, there is no evidence that they ever formed part of the Hebrew text, and they were originally wanting in the Syriac (Polychronius ap. Mai, *Script. Vet. Nov. Coll.* i, p. 118, says of the hymn expressly *ὄχι κείραι ἐν τοῖς Ἑβραϊκοῖς ἢ ἐν τοῖς Συριακοῖς βιβλίοις*). From the Sept. and Vulgate the fragments passed into common use, and they are commonly quoted by Greek and Latin fathers as parts of Daniel (Clem. Alex. *Ecl. proph.* i; Origen, *Ep. ad Afric.*; Tertull. *de Pudic.* 17, etc.), but rejected by those who adhered to the Hebrew canon. Jerome, in particular, called attention to their absence from the

Hebrew Bible (*Præf. in Dan.*), and, instead of any commentary of his own, adds shortly Origen's remarks "on the fables of Bel and Susanna" (*Comm. in Dan.* xiii, 1). In a similar manner, he notices shortly the Song of the three Children, "lest he should seem to have overlooked it" (*Comm. in Dan.* iii, 23).

III. *Their Derivation*.—Various conjectures have been made as to the origin of the additions. It has been supposed that they were derived from Aramaic originals (De Wette, *Einl.* ii, 2, Kap. 8, gives the arguments at length), but the intricate evidence is wholly insufficient to establish the point. The character of the additions themselves indicates rather the hand of an Alexandrine writer; and it is not unlikely that the translator of Daniel wrought up traditions which were already current, and appended them to his work (comp. Fritzsche, *Ereg. Handb. zu den Apok.* i, 121). The abruptness of the narrative in Daniel furnished an occasion for the introduction of the prayer and hymn; and the story of the Dragon seems like a strange exaggeration of the record of the deliverance of Daniel (Dan. vi), which may naturally have formed the basis of different legends. Nor is it difficult to see in the history of Susanna a pointed allusion to the name of the prophet, though the narrative may not be wholly fictitious.

The Sept. appears to be the original source from which all the existing recensions of the fragments were derived (comp. Hody, *De Bibl. text.* p. 588). Theodotion seems to have done little more than transcribe the Sept. text, with improvements in style and language, which are considerably greater in the appended narratives than in the Song incorporated into the canonical text. Thus, while the history of Susanna and Bel and the Dragon contain large additions which complete and embellish the story (e. g. Hist. Sus. 15-18; 20, 21; 24-27; 46, 47, 49, 50; Bel and Dr. i, 9-13; Eichhorn, p. 431 sq.), the text of the Song is little more than a repetition of that of the Sept. (comp. De Magistria, *Daniel*, etc. p. 264 sq.; Eichhorn, *Einleit. in der Apokryph. Schrift.* p. 422 sq.). The Polyglot-Syriac, Arabic, and Latin versions are derived from Theodotion, and the Hexaplar-Syriac from the Sept. (Eichhorn, p. 430, etc.).

The stories of Bel and Susanna received various embellishments in later times, which throw some light upon the manner in which they were originally composed (comp. Origen, *Ep. ad Afric.* § 7, 8; Bochart, *Hieroz.* iii, 8; Eichhorn, p. 446, etc.), just as the change which Theodotion introduced into the narrative of Bel, to give some consistency to the facts, illustrates the rationalizing process through which the legends passed (comp. Deltzsch, *De Habacuci vitæ et etate*, 1844). It is thus useless to institute any inquiry into the historic foundation which lies below the popular traditions; for, though the stories cannot be regarded as mere fables, it is evident that a moral purpose determined the shape which they assumed. A later age found in them traces of a deeper wisdom, and to Christian commentators Susanna appeared as a type of the true Church tempted to infidelity by Jewish and pagan adversaries, and lifting up her voice to God in the midst of persecution (Hippol. *In Susann.* p. 689 sq., ed. Migne).—Smith, s. v.

V. *Their Spuriousness*.—These addenda are regarded as canonical by the Roman Church, but the only evidence that can be adduced for this authority being attached to them is the fact of their existence in the Sept., Vulg., and other versions, and their quotation by the early Church fathers. On the other hand, these arguments are more than counterbalanced by the fact of their non-existence in the Heb. text and the earliest Syriac, the weak authority of the Sept. (especially in the book of Daniel), and consequently of the Vulg., which is based upon it, and the general manner in which these fathers refer to them. Jerome, indeed, frequently and openly ridicules their ab-

surd legends; and their own contradictions are sufficient to stamp them as spurious upon their very face.

See *Josippon ben Gorion* (ed. Breithaupt, Goth. et Lips. 1710), p. 34; Whitaker, *Disputation on Scripture* (Parker Society ed.), p. 76 sq.; Du Pin, *History of the Canon* (London, 1699), p. 14 sq., 117 sq.; Arnold, *Commentary on Apocrypha*; Zunz, *Gottesdienstlichen Vorträge*, p. 122; Herzfeld, *Geschichte der Israel*, p. 317; Grätz, *Gesch. der Juden*, iii, 308; Ewald, *Gesch. Israel*, iv, 557 sq.; Fritzsche, *Exeg. Handb.* i, 111; Davidson, *Text of the O. T.* p. 976. See SONG OF THE THREE HOLY CHILDREN; SUSANNA, HISTORY OF; DESTRUCTION OF BEL AND THE DRAGON, HISTORY OF.

3. (Sept. *Δαυιάλ*.) A priest of the family of Ithamar, who returned from the exile in the time of "Artaxerxes" (Ezra viii, 2), B.C. 459. He is probably the same with the priest Daniel who joined in the covenant drawn up by Nehemiah (Neh. x, 6), B.C. 410. He has been confounded with the prophet in the apocryphal addenda to the Sept. (Dan. xiv, 1, Sept., not Theodotion), where he is called "a priest by the name of Daniel, the son of Abda" (Jerome, *Prefat. in Daniel*).

Daniel the Stylite was born near Samosata about A.D. 410, and died near Constantinople about 490. He entered a monastery at twelve, and determined in middle life to imitate Simeon the Stylite (q. v.). In 461 he fixed himself on a pillar on the height called Anapla, near Constantinople, and exposed himself there day and night. It is said that he had the gift of prophecy, and was at last escorted to heaven by the angels! He is celebrated as a saint in the Greek and Roman churches, Dec. 11.—Butler, *Lives of the Saints*, Dec. 11.

Daniel, bishop of Winchester, a monk in the convent of Malmesbury, was raised to the see of Winchester in 705. The convent from whence came Boniface, the apostle of Germany, was situated in his diocese, and Daniel himself strongly encouraged Boniface in his resolution of preaching the Gospel on the Continent. He gave him, on the occasion of his first journey to Rome, two letters of introduction, one addressed to all Christians, kings, and bishops (*epist. B. ed. Würdtwein*, ep. 1), and another to Gregory II, which has been lost. He remained in relation with Boniface, and sustained him by his advice, instructions, and sympathy (*ep. B. ep. 12-14*). In 721 he undertook a pilgrimage to Rome, and on his return furnished to Bede the sources of his history of the kingdom of Wessex, as the latter himself states in his Ecclesiastical History of the Anglo-Saxons. Having become blind, he renounced his charge, and returned to the convent of Malmesbury, where he died in 745 or 746. The four letters mentioned above are all that remains of his writings; the ep. 14, by Würdtwein, is also to be found in Baronius A.D. 724.—Herzog, *Real-Encyclop.* s. v.; Wright, *Bibliographia Literaria* (Anglo-Saxon Period), p. 292 sq.

Dan'ite (Heb. always with the article *had-Dani'*, דַּנְיָאִי; Sept. *ὁ Δάν, Δάνας, οἱ Δανῖται*; A. V. "Danites," Judg. xiii, 2; xviii, 1, 11; 1 Chron. xii, 35; "of Dan," Judg. xviii, 30), a member of the tribe of DAN (q. v.).

Dan-ja'an (Heb. but once and with 7 local appended, *Da'nah Ya'an*, דַּנְיָאֵן; Sept. *Δανιδαν και Ουδαν* v. r. *Δανυαπν και Ιουδαν*; Vulg. *Dan silvestria*), a place named only in 2 Sam. xxiv, 6 as one of the points visited by Joab in taking the census of the people. It occurs after Gilead, between "the land of Tahtim-hodshi" and Zidon, and therefore may have been somewhere in the direction of Dan (Laish), at the sources of the Jordan. The reading of the Alexandrian Sept. and of the Vulg. was evidently דַּנְיָאֵן, *Dan-jaar*, the nearest translation of which is "Dan in the wood." This reading is approved by Gesenius (*Thes. Heb.* p. 336), and agrees with the well-wooded

character of the country about *Tel el-Kok* & DAPHNE. Fürst (*Heb. Handsörterbuch*, p. 368) compares Dan-jaan with Baal-jaan, a Phœnician town whose name is found on coins. Theunis suggests that Jaan was originally Laish, the 7 having fallen off, and 77 having been substituted for 77 (*Exeg. Handb.* on Sam. p. 257). There seems no reason for doubting that the well-known DAN, of Leshem, is intended. We have no record of any other Dan in the north, even if this were not the case, Dan, as the southern limit of the nation, was too important a point to escape mention in such a list as that in the text. Dr. Schultz, however, the late Prussian consul at Jerusalem, discovered an ancient site called *Danayal*, in the mountains above Khan ef-Nah south of Tyre, which he proposes to identify with Baal-jaan (Van de Velde, *Memoir*, p. 306).—Smith, v. v.

Dan'nah (Heb. *Dannah'*, דַּנְנָה, prob. *מננה*), but Fürst thinks *lowly*; Sept. *Παννά* v. r. *Παννα*, evidently by mistake of 7 for 7; Vulg. *Danna*), a city in the mountains of Judah, mentioned between Seba and Kirjath-sannah (Josh. xv, 49), and evidently high in the group south-west of Hebron (Keil, *Comment.* loc.); possibly the modern *ed-Dhoberiyeh*, a considerable village on the hills west of Wady el-Khulil, consisting of stone hovels with remains of older structures, and surrounded by a fine grazing region (Bainson, *Researches*, i, 308, 311). Knobel (*Exeg. Handb.* in loc.) suggests the site *Tanada*, but this is probably that of the ancient Tanoah.

Dannbauer, CONRAD, a Lutheran divine, was born in the Breisgau 1603, and studied at the universities of Marburg, Altdorf, and Jena. In 1628 he became professor of eloquence, and later of theology at Strassburg, where also in 1638 he became pastor of the cathedral church. He died in 1666. Dannbauer was a learned theologian, and an earnest Lutheran convertist against Romanism and Syncretism (q. v.). Is an account of his numerous writings, see Tholuck *Akademisches Leben d. 17 Jahrhundert*, sec. xvii, p. 274; and Tholuck's article in Herzog, *Real-Encyclop.* xix, 386.

Dante (properly DURANTE) Alighieri, one of the greatest Christian poets of all times, and, on account of his views of religion and the Church, generally counted among the forerunners of the Reformation of the sixteenth century. He was born at Florence May 8, 1265; according to others, May 27, 1268. He studied philosophy at the universities of Bologna and Padua; later, when an exile, he devoted himself to the study of philosophy at Paris. According to a statement of Boccaccio, he also visited England. In his youth Dante took an active part in the politics of his native city, and in 1300 was for two months one of its two *Priors*. In the party strife between the *Neri* (Blacks), the unconditional adherents of the pope, and the *Bianchi* (Whites), who rather sympathized with the Ghibellines, Dante was one of the leading men of the latter. His party sent him to Rome to counteract the plans of the *Neri*, who had implored the aid of Boniface VIII. The pope induced Charles of Valois, brother of Philip IV of France, to go to Florence to make peace. Charles recalled the exiled chiefs of the Bianchi, and gave up the houses and the property of the *Neri* to plundering. Many of the prominent men of the party, among them Dante, were banished. Dante never saw his native city again, and his subsequent life was very unsettled. After the last unsuccessful attempt of the "Whites" to re-enter Florence, he probably left Italy for Paris. When emperor Henry VII marched against Rome, Dante wrote enthusiastic letters in favor of the emperor against the pope. It is thought that his work *De monarchia* was compiled at the same time. The death of the emperor disappointed his last hope. The last years of his life

re spent at Ravenna, where prince Guido Novello Polenta was his patron.

The first powerful influence which awakened in him poetical inspiration was the love which at the age nine years he conceived for Beatrice Portinari, then thirteen years old, the daughter of a rich citizen. How pure, chaste, and tender this love was is testified by his first work, the *Vita Nuova*, which was published about 1300, and consists of a collection of poems, all referring to his first love (best edition by Marsilio Trivulzio, Milan, 1827). Beatrice died early in 1300 as the wife of the knight Simone de Bardi, and few years after her death Dante married a lady named Gemma, of the powerful house of Donati, by whom he had five or six children. A fruit of the philosophical studies in which he sought consolation for the death of Beatrice was the *Convivio* (Banquet), which is to consist of 15 *trattati* and 14 *canzone*, of which, however, only 4 *trattati* and three *canzone* were finished (best edition by Trivulzio, Milan, 1826).

But the great work, which has settled for all times the reputation of Dante as one of the greatest Christian poets, is his immortal *Commedia*, or, as it is subsequently called, the *Divina Commedia*, written in *terze rime*, and consisting of 100 *cantos*, of which the first is introductory to the following visions, and the last is devoted to Hell (*Inferno*), Purgatory (*Purgatorio*), and Paradise (*Paradiso*) each. "The poet is conducted first by Virgil, the representative of human reason, through hell and purgatory, and then by Beatrice, the representative of revelation, and finally by St. Bernard, through the several heavens, where he beholds the triune God. Hell is represented in the poem as a funnel-shaped hollow, formed of gradually contracting circles, the lowest and narrowest of which is at the earth's centre. Purgatory is a mountain rising solitary from the ocean on that side of the earth that is opposite to us: it is divided into terraces, and the top is the terrestrial paradise, the first abode of man. From this the poet ascends through the seven planetary heavens, the heaven of the fixed stars, and the 'primum mobile,' to the empyrean, or fixed seat of God. In all parts of the region thus traversed there rise conversations with noted personages, for the most part recently deceased. At one time the reader is filled with the deepest sorrow, at another with horror and aversion; or the deepest questions of the then philosophy and theology are discussed and solved; and the social and moral condition of Italy, with the corruptions of Church and State, are depicted with a noble indignation" (Chambers). The conversations contained in the *Divina Commedia* give a full exposé of most of the fundamental doctrines of the Christian religion. The creation of the world, the fall of angels and man, and the atonement, are treated of with great fulness. The doctrine that salvation can be found in faith in Christ alone is repeatedly insisted on. The poet in many places complains of the moral, social, and political degeneracy of the time, and of the corruption of the Church and the papal see. He violently inveighs against indulgences and the false veneration of saints, against the preference given to the decretals of the popes over the holy Scriptures, and thrusts three popes in succession into hell. A thorough reformation of the Church in head and members is expected, not from the popes, but from the emperors. "Fifty-two years after the poet's death, the republic of Florence, at the instigation of Boccaccio, set apart an annual sum for public lectures to explain the *Divine Comedy* to the people in one of the churches, and Boccaccio himself was appointed first lecturer. The example was imitated in several other places in Italy. The works of these men are among the earliest commentaries on Dante that we possess. The number of editions of the work amounts by this time to about 800. Only a few deserve notice. They are, that printed at Fuligno in 1472—the earliest of all; the Nidobesine

edition at Milan (1478); the first Aldine edition (1502); the first Cruscan edition (1695); that of Volpi (1727); of Venturi (1782); of Lombardi (1791), and with additions and illustrations in 1815, 1821, and 1822; of Dionisi (1795); of Ugo Foscolo (Lond. 1842-1848). A reprint of the Fuligno edition above mentioned, together with those printed at Jesi (1472), at Mantua (1472), and at Naples by Francesco del Tuppo (about 1478), appeared at London in 1858 under the superintendence of Mr. Panizzi, and at the expense of Lord Vernon" (Chambers). Among the most recent editions are those by Bianchi (Florence, 5th ed. 1857) and Karl Witte (Berlin, 1862, 4to and 8vo). The last is regarded as the best from a critical point of view. "The *Divina Commedia* has been translated into almost all European languages. Two translations of the whole into Latin have been printed, one by Carlo d'Aquino (1728), and lately by Piazza (1848). In French there are a number of translations both in prose and verse. The earliest, by Grangier, in 1596, is still the nearest to the original in form, but none is good. The German translations are numerous, and such as no other modern language can equal in faithfulness. Kannegiesser has translated the whole in the measure and rhyme of the original (Leipsic, 1843, 4th ed.); since [subsequently king] John of Saxony's translation is said by some to be the best. The chief English translations are Boyd's (1785) and Cary's (1814), in blank verse; Wright's (1838), in triple rhymes; Cayley's, in the original ternary rhyme (the *Inferno*, 1861; the *Purgatorio*, 1858; the *Paradiso* in 1854, with a volume of notes in 1855); Dr. John Carlyle's, the *Inferno*, in prose, with a judicious commentary (1849); Fred. Pollock's, in blank verse (1854)" (Chambers). The first complete American translation is by Longfellow (*The Divine Comedy of Dante*, Boston, 1867, 3 vols.).

Of the other works of Dante, his Latin work, *De Monarchia*, written in the interest of the emperor against the temporal power claimed by pope Boniface VIII over all secular rulers, is the most important. Dante takes the ground that both powers, like two swords, have been directly ordained by God to support each other. This book became a powerful weapon in the hands of the opponents of the papacy. Pope John XXII forbade it, and ordered it to be burned. The *Rime sacre*, containing the seven penitential psalms and the *Credo* in *terze rime*, were for the first time published in 1752, and their genuineness is still doubted by some.

The religious and ecclesiastical views of Dante have been for centuries, and still are, the subject of an animated controversy. Matthias Flacius placed him in his *Catalogus testium veritatis evangelicæ* (1556), and since then Protestant writers generally have claimed him as a forerunner of the Reformation, or, at least, as an ardent opponent of many of the worst corruptions prevalent in the Papal Church during the Middle Ages. The Jesuit Harduin, in order to save Dante from the charge of heresy, ascribed the *Divina Commedia* to a disciple of Wickliffe; but most of the Roman Catholic writers (in particular the Frenchmen Ozanam and Artaud de Montor) maintain that Dante, in spite of his opposition to some abuses in the Church, was, in point of doctrine, a faithful adherent of the Church of Rome. See Baumgarten-Crusius, *De Doctrina Dantis Algerii theologica* (1836); Aroux, *Dante hérétique, révolutionnaire et socialiste* (Par. 1854); Boissard, *Dante révolutionnaire et socialiste, mais non hérétique* (Paris, 1854).

The literature on the life and the works of Dante is immense. The first who wrote a critical life was Pelli (1758), after whom the Italians Dionisi, Orelli, and Misserini wrote valuable works. Among the numerous works of Germany on the subject we mention Aberken, *Beiträge für das Studium der göttlichen Komödie Dante's* (Berlin, 1826); Schlosser, *Dante-Studien* (Lpz. 1855); Ruth, *Studien über Dante* (Tüb. 1858); Wegele,

Dante's Leben und Werke (Jena, 1852); Floto, *Dante Alighieri; sein Leben und seine Werke* (Stutt. 1858); Paur, *Ueber die Quellen zur Lebensgeschichte Dante's* (Görlitz, 1862). The best among recent Italian works is Balbo's *Vita di Dante* (2 vols. Turin, 1839). A list of all editions, translations, and commentaries on the *Divina Commedia* is given in Colomb de Batine's *Bibliografia Dantesca* (2 vols. Prato, 1845-1848). The best illustrations of the chief works of Dante are from Flaxman (*Alfante Dantesco*, Milan, 1822), Genelli, and Doré. In 1865, from the 14th to the 16th of May, the sixth centenary of the birth of Dante was celebrated at Florence with immense enthusiasm, and his statue (by Enrico Pazzi in Ravenna) erected at the Piazza della Croce. See Brockhaus, *Conversations-Lexicon*, and Chambers (chiefly a condensed translation of Brockhaus), s. v.; Herzog, *Real-Encyclop.* iii, 286.

Danz, Johann Andreas, a Lutheran theologian and distinguished Hebrew scholar, was born in 1654 at Sundhausen, near Gotha. He became professor at the University of Jena, first in the philosophical, and subsequently (1718) in the theological faculty, remaining, however, at the same time professor of the Oriental languages. He was the founder of a new school of Oriental philologists, and had the reputation of being the greatest Hebrew scholar of the age. He was intimate with Spener and Francke, but yet his private life was not beyond reproach. He died Dec. 22, 1727. The most important of his works are *Compendium grammaticæ hebr. et chald.* (8d edition, 1706); *Rabbinismus enucleatus* (Frankf. 1761); *Literatur Ebraeo-Chaldæus* (Jena, 1696; the first edit. had been published under the title *Nutzfruchtbrum* [nut-cracker], Jena, 1686).—Herzog, *Real-Encyclop.* xix, 388; Pierer, *Univ.-Lex.* iv, 785.

Danz, Johann Traugott Leberecht, a Protestant theologian of Germany, was born May 31, 1769, at Weimar. He studied at the universities of Jena and Göttingen, became in 1807 professor of theology at Jena, which position he retained until 1837, and died at Jena May 16, 1851. He was a man of immense learning in all departments of literature, an interesting writer on a number of subjects, and a popular professor. In his theological views he was a representative of the school of Biblical Rationalists, advocating the mutual toleration of Rationalists and Supernaturalists in the same church, and opposing the views both of Schleiermacher and Strauss. Among his theological works the following are the most important: *Lehrbuch der Kirchengeschichte* (Jena, 1824); *Die Wissenschaften des geistlichen Berufs* (Jena, 1824); *Theolog. Encyclopædia* (Weimar, 1832); *Universal-Wörterbuch der theolog. und religionsgeschichtl. Literatur* (Leipzig, 1837, sq.); *Initia Doctrina Patristica* (Jena, 1839); *Geschichte des Tridentiner Concils* (Jena, 1846), according to Paul Sarpi. His edition of the *Libri Symbolici ecclesie Romano-Catholicae* (Vimar, 1835) was dedicated to Gregorio XVI, Pontifici Maximo, *ecclesie Romano-Catholicae præsuli*, with some good Protestant advice. He also published a biography of his deceased (1835) friend and colleague, H. A. Schott (Jena, 1836), and edited a posthumous work of the latter on the authenticity of the Gospel according to Matthew (Leips. 1837). One of his last works was "Two Conversations" on the Life of Jesus by Strauss (*Zwei Gespräche*, 1839).—Herzog, *Real-Encyclop.* xix, 389 sq.

Daph'nè (Δάφνη, the laurel; so called from the verdure of the place, or because this tree was sacred to Apollo), the name of several localities mentioned in later writers.

1. A celebrated grove and sanctuary of Apollo near Antioch (q. v.), in Syria. Its establishment, like that of the city, was due to Seleucus Nicator. The distance between the two places was about five miles (Strabo, xvi, 750), and in history they are associated most intimately together (Antioch being frequently

called 'Α. ἱεὶ Δάφνη, and ἡ πρὸς Δάφνη, and conversely Daphne entitled Δ. ἡ πρὸς Ἀντιόχεια, Josephus, War, i, 12, 5; comp. *Ant.* xiv, 15, 11; xvi, 1). The situation was of extreme natural beauty, with perennial fountains and abundant wood. Seleucus civilized here, and appropriated to himself and his family the fables of Apollo and the river Peneus, and the nymph Daphne. Here he erected a magnificent temple and colossal statue of the god (Libanius, *De Seleuco Templo*, iii, 834). The succeeding Seleucid monarchs, especially Antiochus Epiphanes, embellished the place still further. Among other honors, it possessed the privileges of an asylum. It is in this character that the place is mentioned, 2 Macc. iv, 88. In the reign of Antiochus Epiphanes (B. C. 171), the aged patriotic high-priest Onias, having rebuked Menelaus for his sacrilege at Jerusalem, took refuge at Daphne, whence he was treacherously brought out, at the instance of Menelaus, and murdered by Andronicus, who was governor of Antioch during the king's absence on a campaign. Josephus does not give this account of the death of Onias (*Ant.* xii, 5, 1). When Syria became Roman, Daphne continued to be famous as a place of pilgrimage and vice. "*Daphnicæ moris*" was a proverb (see Gibbon's 23d chapter). The beginning of the decay of Daphne must be dated from the time of Julian, when Christianity in the empire began to triumph over heathenism. The site has been well identified by Pococke and other travellers at Beit el-Ma "the House of the Water," on the left bank of the Orontes, to the south-west of Antioch, and on higher ground, where the fountains and the wild fragrant vegetation are in harmony with all that we read of the natural characteristics of Apollo's sanctuary.—Smith, s. v. It is a small natural amphitheatre on the declivity of the mountains, where the springs burst with a loud noise from the earth, and running in a variety of directions for a distance of about two hundred paces terminate in two beautiful cascades, which fall into the valley of the Orontes. The largest of the fountains rises from under a vertical rock, forming a small abyss or concavity, on the top and sides of which are the massive remains of an ancient edifice, perhaps those of the Temple of Apollo (Kelly's *Syria*, p. 251). For a translation of an ancient inscription recently discovered on the site, see the *Jour. Asiat. Or.* Soc. vi, 558. See Müller, *Antiq. Antiochene*, p. 64; Smith's *Dict. of Class. Geogr.* s. v. See ANTIOCH.

2. A town or village (χῆρον) near the fountain of the little Jordan (Josephus, War, iv, 1, sec. 1). Be-land (*Palestina*, p. 263) and others have considered this as identical with Dan, proposing to read Δάφνη for Δάφνης, and referring in support to Josephus, *Ant.* viii, 8, 4. Recent explorers have shown this to be an error, and have discovered the site of the Daphne of Josephus in the present *Dafneh*, two miles to the south of Tell el-Kady, the site of Dan (Van de Velde, *Memoir*, p. 806; *Syria and Palestine*, ii, 419; Robinson, *Later Researches*, p. 898; Wilson, *Bible Lands*, ii, 173; Thomson, *Land and Book*, i, 888).—Kitto, s. v.

3. In Num. xxxiv, 11, the clause rendered in the A. V. "on the east side of Ain" (q. v.), and by the Sept. "on the east to (of) the fountain," is given in the Vulgate "contra fontem Daphnim." The word *Daphnim* is most probably a marginal gloss, and may perhaps refer to No. 2. Jerome, in his commentary on Ezekiel (c. 47), refers to the passage in Numbers, and gives reasons for concluding that "the fountain" is Daphne No. 1. The Targums of Jonathan and of Jerusalem give Daphne or Dophne as the equivalent of Eshbal (q. v.) in Num. xxxiv, 11 (q. v.). The error into which Jerome and the Targums have fallen appears to have arisen either from a confusion between Daphne on the Jordan with Daphne on the Orontes, or from mistaking the fountains near the mouth of the Orontes for those at its source.—Kitto, s. v.

4. A fortified town on the Pelusiac branch of the

He (Δάρδα; Herod. ii, 80, 107), the ΤΑΡΧΕΝΕΣ (q. v.) of Scripture, distant from Pelusium sixteen Roman miles (*Itin. Ant. Iter a Pelusio Memphim*).—Kitto, s. v.

Dar. See MARBLE.

Da'ra (Heb. *Dara'*, דָּרָא; Sept. Δαρά v. r. Δα-ιδ, Δαράδῆ), a contracted or corrupt form (1 Chron. 6) of the name DARDA (q. v.).

Darbyites. See PLYMOUTH BRETHREN.

Daromonim. See DARIC.

Dar'da (Heb. *Darda'*, דָּרְדָּא, *pearl of knowledge*; ept. Δαρδάλα v. r. τὸν δάρδα; Josephus, Δάρδαρος . r. Δάρδαρος, *Ant.* viii, 2, 5; Vulg. *Dorda*), a son of Mahol, one of four men of great fame for their wisdom, but who were excelled by Solomon (1 Kings iv, 1). B. C. ante 1010. Ethan, the first of the four, is called "the Ezrachte," but it is uncertain whether the designation extends to others. In 1 Chron. ii, 6, however, the same four names occur again as "sons of Zerach," of the great family of Pharez, in the tribe of Judah, with the slight difference that "Darda" appears as "Dara." The identity of these persons with those in 1 Kings iv has been greatly debated (see the arguments on both sides in Burrington, i, 206-8); but here cannot be much reasonable doubt that they are the same (Mövers, *Krikk. Unters.* p. 287); although Keil argues that nothing can be proved from the mere identity of the names (*Versuch üb. der Chron.* p. 164). There is nothing to support the Jewish tradition (in the *Seder Olam Rabba*) that they prophesied during the Egyptian bondage. See ETHAN.

(1.) A great number of Hebr. MSS. read Darda in Chron. (Davidson, *Hebr. Text*, p. 210), in which they are followed by the Targum and the Syriac and Arabic versions. See DARA.

(2.) The son of Zerach would without difficulty be included in Hebrew the Ezrachte, the change depending merely on the position of a vowel point. And further, the change is actually made by the Targum Jonathan, which in Kings has "son of Zerach." See EZRAHITE.

(3.) The word "son" is used in Hebrew so often to denote a descendant beyond the first generation that no stress can be laid on the "son of Mahol" as compared with the "son of Zerach." For instance, of the five "sons of Judah" in 1 Chron. iv, 1, the first was really Judah's son, the second his grandson, the third his great grandson, and the fourth and fifth still later descendants. Besides, there is some plausibility in the conjecture that "*Bene Mahol*" means "sons of the choir" (comp. "daughters of music," Eccles. xii, 4), in which case the men in question were the famous musicians, two of whom are named in the titles to Psalms lxxxviii and lxxxix.—Smith, s. v. See MAHOL.

Dardar. See THISTLE.

Dario (דָּרְקִמְוִן, *darkemon'*, or דָּרְקִמְוִן, *adarkon'*, only in plur.; Talm. דָּרְקוֹן, *darkon'*; Sept. χρυσοῦς; Vulg. *solidus, drachma*; rendered "dram" [q. v.], Ezra ii, 69; viii, 27; Neh. vii, 70, 71, 72; 1 Chron. xxix, 7), a gold coin (Xenoph. *Anab.* i, 7, 18; i, 1, 9; vii, 6, 1; *Cyrop.* v, 2, 7; *Ælian*, i, 22; Plutarch, *Artax.* 22) current in Palestine in the period after the return from Babylon, and used even for the Temple tax (Mishna, *Shekal.* ii, 4). That the Hebrew word is, in the Bible, the name of a coin and not of a weight, appears from its similarity to the Greek appellation of the only piece to which it could refer (Lysias in Eratosth. 11; Athen. xii, 694). The mentions in Ezra and Neh. show that the coin was current in Palestine under Cyrus and Artaxerxes Longimanus. At these times there was no large issue of gold money except by the Persian kings, who struck the coin known to the Greeks as the *στανήρη Δαρικεύς*, or simply *δαρικεύς*. The darics which have been discovered are thick pieces of pure gold (see Wurm, *De ponder. et mensur.* p. 58 sq.), of archaic style, bearing on the obverse the figure of a king with bow

and javelin, or bow and dagger (Plutarch, *Artax.* 20; Agesilaus, *Lac. Apoph.* 40), and on the reverse an irregular incuse square. Their full weight is about 128 grains troy,



Persian Gold and Silver Darics.—From the British Museum. Actual size.

or a little less than that of an Attic *stater*, and is most probably that of an early didrachm of the Phœnician talent (see Böckh, *Metrolog. Untersuch.* p. 180). They must have been the common gold pieces of the Persian empire. The oldest that are often seen cannot be referred to an earlier period than about the time of Cyrus, Cambyses, or Darius Hystaspis, and it is more probable that they are not anterior to the reign of Xerxes, or even to that of Artaxerxes Longimanus. There are, however, gold pieces of about the same weight, but of an older style, found about Sardis, which cannot be doubted to be either of Croesus or of an earlier Lydian king, in the former case the *Κροισίος (στανήρης)* of the Greeks (Rawlinson, *Herod.* i, 561). It is therefore probable, as these followed a Persian standard, that darics were struck under Cyrus or his nearer successors. The origin of this coin is attributed by the Greeks to a Darius, supposed by the moderns to be either Darius the Mede or Darius Hystaspis (see Schol. ad Aristoph. *Eccles.* p. 741; Hengstenberg, *Authentic Dan.* p. 51). That the Greeks derived their distinctive appellation of the coin from this proper name cannot be doubted; but the difference of the Hebrew forms of the former from that of the latter דָּרְקִמְוִן, renders this a questionable derivation. Gesenius suggests the ancient Persian word *Dara* (*Lex.* s. v.), "king;" but (in his *Thesaur.* s. v.) inclines to connect the Hebrew names of the coin and that of Darius. In favor of the derivation from *Dara*, it must be noted that the figure borne by these coins is not that of any one king, but of the king of Persia in an abstract sense, and that on the same principle the coins would rather be called regal coins than darics. The silver darics mentioned by Plutarch (*Cim.* 10) are probably the Persian silver pieces similar in type to the gold darics, but weighing a drachm and a third of the same standard.—Smith, s. v. (See Harenberg, in Ugolini *Thesaur.* xxviii; Eckhel, *Doctrin. num.* I, iii, 551 sq.; Boden, *De daricis*, Vitab. 1779; Wesseling, *Observv. var.* Amst. 1729, p. 241 sq.) See MONEY; DRACHMA.

Dari'us (Hebrew *Dareya'vash*, דָּרְיֹוֹשׁ, Ezra iv, 4; Neh. xii, 22; Dan. ix, 1; xi, 1; Hag. i, 1, 16; ii, 10; Zech. i, 1, 7; vii, 1; Chald. the same, Ezra iv, 24; v, 5-15; Dan. v, 81; vi, 1-28; Gr. Δαρῖος, 1 Esdr. ii, 80; iii, 1-8; iv, 47; v, 2, 6, 78; vi, 1, 6, 7, 28, 34; vii, 1, 4, 5; 1 Macc. i, 1; xii, 7; Strabo *Δαρεϊστής*, xvi, p. 785; Ctesias *Δαριαῖος*), the name of several kings of Persia, three of whom are mentioned in the O. T. and the Apocrypha. The original form of the name, to which the Hebrew and Greek words are only approximations, has been read by Grotefend, in the cuneiform inscriptions of Persepolis, as *Darheush* or *Darjeush* (Heeren's *Ideen*, ii, 850), and by Beer as *Daryawush* (*Allg. Lit. Zeit.* 1838, No. 5). Herodotus assigns to the name the sense of ἐπέτης, or, according to another reading, ἐπέτης (vi, 98); probably meaning

coercer or conservator. The former accords with *holding fast*, which is the sense of *Dārā*, the modern Persian name of Darius, the latter with the derivation (according to Lassen, *Inscripfionen*, p. 89, 158) from Sanscrit *darī*, to preserve. (See Gesenius, *Theas. Heb.* p. 350.) According to Rawlinson (*Herod.* iii, 455), "It does not appear to mean either *ἰρξίτης*, 'the worker,' as Herodotus states, or *φρόνιμος*, 'the wise,' as Hesychius, or *πολιμικός*, 'the warrior,' as the author of the *Etymologicum* says. The root appears to be the Old Persian *dar*, 'to hold' or 'possess,' which is *dere* in Zend, *dāri* in Sanscrit, and *dar* in Modern Persian. The remainder of the word is thought to be a mere appellative suffix, elongated on euphonic grounds; but no very satisfactory account can be given of it." The name occurs both in the Assyrian and Egyptian in-



d a r y u s a w a h .



n t r o t o u s h .

Cuneiform and Hieroglyphical Forms of "Darius."

scriptions. This title appears to have been the proper name of the son of Hystaspes, who first won it, but was assumed as a throne-name by Ochus (i. e. Darius Nothus), son and successor of Artaxerxes Longimanus (Ctesias, *Perz.* xviii, 57), in like manner as Arsaces, successor of this Darius (*ib.* liii, 57) and Bessus (Curt. vi, 6), both took the royal name of "Artaxerxes" (q. v.). See Smith's *Dict. of Class. Biog.* s. v. See PERSIA.

1. "DARIUS THE MEDE" (דָּרְיוֹשׁ בֶּן הַמֵּדֵי, Dan. xi, 1, Sept. δ Κύρος; Chald. דָּרְיוֹשׁ בֶּן הַמֵּדֵי, Sept. Δαρειός δ Μηδός), "the son of Abasuerus of the seed of the Medes" (ix, 1, Sept. Δαρειός δ υἱός Ἀσασύρου), who succeeded to (𐎠𐎡𐎴) the Babylonian kingdom on the death of Belshazzar, being then sixty-two years old (Dan. v, 31; ix, 1), B.C. 538. Only one year of his reign is mentioned (Dan. ix, 1; xi, 1), but that was of great importance for the Jews. Daniel was advanced by the king to the highest dignity (Dan. vi, 1 sq.), probably in consequence of his former services (compare Dan. v, 17); and after his miraculous deliverance, Darius issued a decree enjoining throughout his dominions "reverence for the God of Daniel" (Dan. vi, 25 sq.). See MEDE.

The statement (Dan. vi, 28) that "Daniel prospered in the reign of Darius, and in the reign of Cyrus the Persian," seems to represent him as the immediate predecessor of Cyrus. No Darius occupying this place, nor indeed any Darius anterior to the son of Hystaspes, is found either in profane history or (hitherto) on monuments. See AHASUERUS. Only the Scholiast on Aristoph. (*Ecol.* 602), followed by Suidas (s. v. Δαρειός), and Harpocration, says that the daric took its name from "another Darius, earlier than the father of Xerxes" (D. Hystaspis). Herodotus and Ctesias, differing widely in other respects, agree in making Astyages last king of the Median dynasty, with no male heir, conquered and deposed by Cyrus, first king of the Medo-Persian dynasty at Babylon. Xenophon, however, in the *Cyropædia* (i, 5, 2) introduces, as son and successor of Astyages, and uncle (mother's brother) of Cyrus, a second Cyaxares, acting under whose orders Cyrus takes Babylon, and receives in marriage his daughter, unnamed, with Media as her portion. Josephus (*Ant.* x, 11, 1) clearly means the Cyaxares II of Xenophon when he says that "Darius was the son of Astyages, but known to the Greeks by a different name;" and the statement of Aben Ezra, who reports from "a book of the kings of Persia" that this Darius was Cyrus's father-in-law, probably rests at last on the supposed authority of Xenophon. See CY-

rus. Under these circumstances, the extreme obscurity of the Babylonian annals has given occasion to three different hypotheses as to the name under which Darius the Mede is known in history.

1. The first of these, which identifies him with Darius Hystaspis, rests on no plausible evidence, and may be dismissed at once (Lengerke, *Dan.* p. 219 sq.). See below, No. 2.

2. Another identification is that maintained by Kevs von Niebuhr (*Geach. Ass. u. Bab.* p. 45), by which Darius is represented as the personal name of "Astyages," the last king of the Medes. It is contended that the name "Astyages" was national and not personal, and that Ahasuerus represents the name (Xerxes, borne by the father of "Astyages" (Tob. xiv, 11). On the contrary, however, Ahasuerus (Heb. *Ἀχασεרוש*) is Xerxes (cuneiform *Khshayarsha*), and not King *Ἐσθῆρ* (cuneiform *Ushathra*). The description of the unnamed king in *Æschylus* (*Perz.* 763 sq.) as whose "feelings were guided by wisdom," is more assumed, on this view, to be applicable to the Darius of Scripture and the Astyages of Herodotus. Assuming the immediate fulfilment of the announcement of Dan. v, 28, in the catastrophe of vi, 1, Niebuhr (*ib.* p. 45 sq.) determines that Belshazzar is Evil-merodach, and successor of Nebuchadnezzar; that, on his death (slain by Neriglassar, his sister's husband), B.C. 538, Astyages, who is Daniel's Darius the Mede, reigned one year at Babylon, which year in the Canon is 1 Neriglassar; in the following year he was conquered by Cyrus, B.C. 538, in exact accordance with the apparent incompleteness of the political arrangements which Darius "purposed" to make (Dan. vi, 3, 𐎠𐎡𐎴). For the short duration of his supreme power may have caused his division of the empire (Dan. vi, 1)—a view congenial to his character—to fall into abeyance; so that it was not carried out till the time of his successor Darius Hystaspis: a supposition that may go for what it is worth. Daniel himself passed from the service of Darius to that of Cyrus, and did not again return to Babylon; so Dan. vi, 28 is explained. The mention, Dan. viii, 1, of the third year of Belshazzar makes a difficulty—not as Von Niebuhr puts it, because Evil-merodach has but two years in the Canon, for the actual reign may very well have reached its third year, but from the mention of Susa as the scene of the vision; for Susa, being Median, was not subject to any Chaldean king. The explanation gravely proposed by Niebuhr is, that Daniel, while at Susa in the service of Darius the Mede, continued to date by years of Belshazzar's reign, and this though he is related to have been present in Babylon the night in which Belshazzar was slain. The difficulty is not confined to Niebuhr's scheme: Belshazzar, whoever he was, was a Chaldean; and the explanation may be, that the prophet is at Susa, not in bodily presence, but transported in spirit to the city which was to be the metropolis of the Persian monarchy, the fate of which under the emblem of the ram, is portrayed in the ensuing vision. See DANIEL. After the fall of this Darius Astyages, Babylon recovered its independence under Nabonned, to fall finally under the arms of Cyrus, B.C. 538. See BABYLON.

The chronological difficulties which have been raised (Rawlinson, *Herodotus*, i 881) against the identifications of Darius with Astyages on the assumption that the events in Dan. v relate to the taking of Babylon by Cyrus (B.C. 538), in which case he would have ascended the throne at seven years of age, are indeed set aside by the view of Niebuhr; but it is clogged with other objections (in addition to those already alluded to), which render it as untenable as it is ingenious and intricate, to say nothing of the fact that it is made up of a series of assumptions throughout. In the first place, the supposition that Belshazzar was Evil-merodach is inadmissible; for it is now pretty well deter-

ined that he was the son of Nabonned, the actually king of the Babylonian line. See BELSHAZZAR. Secondly, this hypothesis sets up a Medo-Persian reign at Babylon during the very time assigned by well-approved history to a native sovereign, and even leaves a blank of eighteen years between him and Cyrus, whom Daniel's history and prophecies evidently make immediately contiguous. See ASTYAGES.

3. There remains, therefore, but one other view, which was adopted by Josephus (*Ant.* x, 11, 4), and as been supported by many recent critics (Bertholdt, Lengerke, Hävernick, Hengstenberg, Auberlen, and others). According to this, the "Darius" in question was *Cyaxares II*, the son and successor of *Astyages*, who is commonly regarded as the last king of Media. It is supposed that the reign of this *Cyaxares* has been neglected by historians from the fact that through his indolence and luxury he yielded the real exercise of power to his nephew Cyrus, who married his daughter, and so after his death received the crown by direct succession (*Xen. Cyrop.* i, 5, 2; iv, 5, 8; viii, 5, 19). It is true that the only direct evidence or the existence of a second *Cyaxares* is that of Xenophon's pædagogic romance. The title "Cyrus [Silius] Cyaxaris," which has been quoted from an inscription (Auberlen, *Daniel u. d. Offenbarung*, p. 18), is either a false reading or certainly a false translation (Niebuhr, *Gesch. Ass. u. Bab.* p. 214, n. 4); and the passage of Æschylus (*Pers.* p. 766) is not very consistent with the character assigned to *Cyaxares II*. On the other hand, Herodotus expressly states that "*Astyages*" was the last king of the Medes, that he was conquered by Cyrus, and that he died without leaving any male issue (Herod. i, 78, 109, 127 sq.); and Cyrus appears as the immediate successor of "*Astyages*" in the Chronicle of Eusebius (*Chron.* ad Ol. 54; Syncell. p. 188; comp. Bel and Dragon, i). These objections, however, are not insuperable, and must give way before the manifest exigencies of the case (see Bertholdt's able excursus on the subject in his *Commentar zu Dan.*). We may add that an important chronological difficulty is best adjusted by assuming the existence and reign of this *Cyaxares* (Clinton's *Fasts Hellenici*, p. 301 sq.). See CYAXARES.

2. "Darius, king of Persia," in whose second year the building of the Temple was resumed, and completed in his sixth (Ezra iv, 5, 24; vi, 15), under the prophesying of Haggai and Zechariah, is understood by most writers, ancient and modern, to be Darius son of Hystaspes, whose reign in the Canon extends from B.C. 521 to 485. Scaliger, however, makes him Darius Nothus (B.C. 424-405), and this view has been advocated by the late Dr. Mill (*The Evangelical Accounts of the Birth and Parentage of our Saviour*, etc., 1842, p. 153-165), who refers for further arguments to Hottinger (*Pentateuch Dissertationum*, p. 107-114). Before we examine the grounds on which this conclusion rests, it will be convenient to consider the difficulties with which it is attended.

Zerubbabel, son of Shealtiel, as prince of the house of David, and Jeshua, son of Jozadak, as high-priest, headed the first colony of exiles from Babylon in the first year of Cyrus (Ezra iii, 2), at which time neither can have been less than twenty years old. By these same two persons the work of rebuilding the Temple was resumed and completed after its suspension. Now from the first year of Cyrus, in the Biblical reckoning (B.C. 536), to the second of Darius Nothus (B.C. 428), are 113 years; so that, if he be the Darius of this history, both Zerubbabel and Jeshua must then have reached the age of 130 years at least. This is incredible, if not in itself, certainly under the entire silence of the history and the contemporary prophets as to a fact so extraordinary. Moreover, that the work of rebuilding the Temple should have been abandoned for a century and more is scarcely conceivable. Its suspension during fifteen or sixteen years is sufficient-

ly accounted for by the history and the representations of the prophets. The adversaries "weakened the hands of the people of Judah, and troubled them in building, and hired counsellors against them to frustrate their purpose all the days of Cyrus, even until the reign of Darius" (Ezra iv, 4, 5). Besides molesting the builders in their work, they prevailed by their machinations at the court of Cyrus, or of his viceroy, to bring it to a stand-still, by interposing official obstacles, stopping the grants from the royal treasury (vi, 4), and the supply of materials from the forest and the quarry (iii, 7). So the people were discouraged: they said, "The time is not come for the house of the Lord to be built," and turned to the completion of their own houses and the tilling of their lands (Hagg. i, 8). This is intelligible on the supposition of an interval of fifteen or sixteen years, during which, there having been no decree issued to stop it, the work was nominally in progress, only deferred, as the builders could allege at the time of its resumption, "Since that time (2d of Cyrus), even until now, hath it been in building, and yet it is not finished" (Ezra v, 16). But in no sense could the Temple be said to have "been in building" through the entire reigns of Cambyses, Darius, Xerxes, and Artaxerxes I: there is no testimony to the fact, nor any means of accounting for it. Again, the persons addressed by Haggai are "the residue of the people" who came from Babylon with Zerubbabel and Jeshua, some of whom had seen the first house in its glory (ii, 2, 8), i. e. who might be some 80 years old on the usual view, but on the other must have been 170 at the least. The prophet further admonishes his countrymen that the blights, droughts, and mildews which year by year disappointed their labors in the fields were the chastisement of their want of faith in letting the house of God lie waste, while they dwelt in their "ceiled houses" (i, 4-17); so long as they had been guilty of this neglect, so long had they been visited with this punishment. On the one supposition, this state of things had lasted from twelve to fifteen years at most; on the other, we are required to imagine that the curse had been on the land for three successive generations, an entire century. Lastly, in the same second year of Darius, Zechariah distinctly intimates what length of time had elapsed from the destruction of the first Temple—"threescore and ten years" (i, 12). So in vii, 5, mention is made of a period of 70 years, during which the people had "fasted and mourned in the fifth and seventh month." The events commemorated by those fasts were the destruction of the Temple in the fifth, and the murder of Gedaliah in the seventh month of the same year. From that year to the second of Darius I are almost, if not exactly, 70 years. To the corresponding year of Darius II the interval is more than 160 years, and the mention of "those 70 years" is quite unintelligible, if that be the epoch of Zechariah's prophesying. Certainly, if the prophecies of Haggai and Zechariah, and the first five chapters of Ezra, are worth anything as testimony, "the second year of Darius" must lie within one generation from the decree of Cyrus, and not more than 70 years from the destruction of the first Temple.

The reasons alleged on the other side may be thus stated: 1. In Ezra iv, between the edict of Cyrus for the return of the exiles and rebuilding of the Temple, and that of Darius for the completion of the work after its discontinuance, two Persian kings are named, Achashverosh and Artachshasta, "which the names on the Zendic monuments will not permit us to apply to other kings than Xerxes and his son" (Dr. Mill, u. s. 153, note). The Persian history, as related by the Greeks and the Astronomical Canon, give three names in succession, Xerxes, Artaxerxes I, Darius II; Ezra, in like manner, three, Achashverosh, Artachshasta, and Dareyavesh. By those who hold this last to be Darius, son of Hystaspes, the first two are commonly

supposed to be Cambyses and the impostor Smerdis, whom Justin (i, 9) calls Oropasta, Ctesias (*de reb. Pers.* 10) Sphendadates, who reigned under the name of Cambyses's younger brother Tany-oxarcus (see Ewald, *Gesch. des V. J.* iv, 81 and 118). But nowhere on monuments is Cambyses called Khshyarsha, or Smerdis Artakshasha; the former is constantly Kabujiya (Pers.), Kambudsiya (Bab.), Kembath (hierogl.); the latter, Bart'ya (Pers.), Bardsiya (Bab.). Moreover, as Artakshasha (or —shaht) elsewhere in Ezra and Neh. is constantly Artaxerxes, and it scarcely admits of a doubt that Achashverosh in Esther is Xerxes, it would be strange if these two names were here applied to other quite different kings.

The true explanation of this difficulty, proposed long ago by Mr. Howe, and adopted by Dr. Hales, has been recently put forward by Bertheau (in the *Kursgef. fast. eaeget. Hdb.* on Ezra, Neh., and Esther, 1862, p. 69-78). This writer had formerly upheld the more usual view (*Beiträge zu der Gesch. der Ier.* p. 896); so had Valhinger (in the *Studien u. Kritiken*, 1854, p. 124), who (*ib.* 1857, p. 87) abandons it for the other. (See also Schultz, *Cyrus der Grosse*, in the *Stud. u. Krit.* 1853, p. 624, and Bunsen, *Bibelswerk*.) It is clear that, as in iv, 24, the narrative returns to the point at which it stood in verse 5; in the interposed portion it either goes back to times before Darius, for the purpose of supplying omitted matter, or goes forward to record the successful machinations of the people of the land under subsequent kings, Xerxes and Artaxerxes I. But nothing in the contents of ver. 6-23 intimates a reverting to an earlier time. After reading of Darius we naturally take for granted that Ahasuerus and Artaxerxes are later than he. It appears that the adversaries had succeeded in hindering the building of the Temple till the second year of Darius. In the beginning of the next reign (Xerxes) they "wrote an accusation," the purport and issue of which are not recorded. In the following reign mention is made of another letter addressed to Artaxerxes, its contents not specified; but a second letter to the same king is given *in extenso*, together with the royal rescript. It is represented to the king that the Jews are building the city, and have "set up the walls thereof, and joined (excavated) the foundations." The rescript orders that this work be made to cease. Not a word is said of the Temple. It may indeed be alleged that the "walls" are part of it, intended for its defence; but with their straitened resources the builders would hardly attempt more than was essential to the fabric itself. Besides, in the representations given by Hag. and Zech. from their own observation, nothing implies that quite recently the people had been actively engaged in the work of rebuilding either city walls or Temple, as according to these documents they had been, if Artakshasha be the impostor Smerdis with his brief reign of a few months; nor, again, is it possible to reconcile the statement in Ezra v, 16, "Since that time even until now (2 Darius) hath it (the Temple) been in building, and yet it is not finished," with the assumption that the work had been peremptorily stopped by command of Smerdis. But it is certain that at some time between the 7th and the 20th year of Artaxerxes some great reverse befel the colonists, in consequence of which "the wall of Jerusalem was broken down, and the gate thereof burned with fire," Neh. i, 3 (for it is absurd to imagine that this can relate to the desolation effected by Nebuchadnezzar a hundred and forty years before), and the documents under consideration show what that reverse was. It was the result of that rescript of Artaxerxes, in virtue of which "Rehum and Shimshai and their companions went up to Jerusalem to the Jews," and made them to cease by force and power" (Ezra iv, 28); to cease from walling the city (ver. 21), not from building the Temple, which was finished long before. So far, all is plain and consistent. But at ver. 24, with the word

וַיִּנְדָּב, "at that time," prop. "at the same time" arises the difficulty. Were the last clause of ver. 24 "until the reign of Darius," absent, the obvious import would be, that at the time when the order for Artaxerxes caused the building of the wall to cease the work of rebuilding the Temple ceased also. It consequently that Darius (ver. 24) reigned after Ahasuerus and Artaxerxes. But as this view is beset with insuperable difficulties, in whichever way it is taken, i. e. alike whether Darius be supposed to be the first or the second of that name, we are forced by the necessity of the case to conclude that ver. 24 refers not to what immediately precedes, but to the time spoken of above ver. 4, 5, and that the whole passage from ver. 6 to 23 is digression. Having shown how the machinations of "the people of the land" prevailed for a time to delay the rebuilding of the Temple, the narrative breaks off at that point to notice their subsequent success for a while successful, plottings against the builders of the city and its walls. If the וַיִּנְדָּב can only refer to the matter immediately preceding, we must either accept the consequences, part incredible and absurd, part directly opposed to statements of the contemporary prophets, or charge it as an error upon the scribe of this book, that he inserted ver. 6-23 in the wrong place (so Kleinert in the Dorpat *Beiträge zu der bibl. Wissensch.* 1832). Considered as a prolepsis, it is a Bertheau remarks, less striking than that which occurs in vi, 14: "and they builded and finished the Temple, viz. in 6 Darius) . . . according to the commandment of Cyrus and Darius, and Artaxerxes, King of Persia."

2. A second reason alleged by Dr. Mill (u. s. p. 16 note) is "the circumstance that, in the next ascent from Babylon, that of Ezra himself, . . . the chief of David's house was removed from Zorobabel by at least six generations . . . thus proving . . . the impossibility of the descendant's ascent from Babylon being earlier than the reign next to that of Darius. Notwithstanding, viz. that of Artaxerxes II." This argument is derived from the Davidic genealogy, 1 Chron. iii, 19-22 compared with Ezra viii, 2. It is assumed that Hattush in both places is the same person; now, in the genealogy, it is alleged there are at least six generations between his ancestor Zerubbabel and him, yet he accompanied Ezra from Babylon; of course this is impossible, if between the ascent of Zerubbabel and that of Ezra are but eighty years (1 Cyrus to 7 Artaxerxes-Longimanus). Dr. Mill (p. 152, note) mentions "four ways of exhibiting the offspring of Hananiah, son of Zerubbabel;" the first, that of the common Hebrew text and our version, which, "if intelligible, yet leaves the number of generations undetermined;" and three others, followed by ancient interpreters, and various which result severally in making Hattush sixth, eighth, and ninth from Zerubbabel. There is no absolute necessity for departing from the Hebrew text, which is both "intelligible" and consistent with customary chronology. The genealogy, perhaps, proceeds thus: 1. Zerubbabel; 2. his children, Meshullam, Hananiah, Shelomith (sister), and five others; 3. the sons of this Hananiah are Pelatiah and Jeshaiah; and there the pedigree of Zerubbabel ends, i. e. with the two grandsons. Then, "the sons of Rephaiah, the sons of Arnan, the sons of Obadiah, the sons of Shechaniah; and the sons of Shechaniah, Shemaiah; and the sons of Shemaiah, Hattush" and five others. That is to say, the genealogist, having deduced the Davidic line through Solomon, and the regal succession down to the grandsons of Zerubbabel, proceeds to mention four other branches of the house of David, and gives a particular account of the fourth, namely, of Shemaiah, the father of that Hattush who went up from Babylon with Ezra, and was in his generation the representative of the Davidic house of Shechaniah. (See likewise Movers, *Ueber die biblische Chronik*, p. 25.)

[Kävernick, *Handb. der Einleit. in das A. T.* ii, 1, 266; Herzfeld, *Gesch. des V. I. von der Zerstörung des ersten Tempels an*, i, 879; Keil, *Apolog. Versuch über die Bücher der Chronik*, p. 48. On the other hand, Ewald, *Gesch. des V. I.* i, 219, note, makes Shechaniah son of Iananiah and father of Shebemaiah, so that Hattush is youth from Zerubbabel; and so Bertheau in the *Kgf. veget. Hdb.* on 1 Chron. iii, 21; which view is consistent with the usual chronology, as of course it is quite possible that a grandson of Zerubbabel's grandson may have been adult at the time of Ezra's mission, eighty years after the 1st of Cyrus. See, however, a different explanation in Strong's *Harm. and Expos. of the Gospels*, p. 17, note m.) See ZERUBBABEL. So, in fact, the Hattush who accompanied Ezra is described according to the reading, proposed by some, of the passage, viii, 2, 8), "of the sons of David, Hattush, of the sons of Shechaniah;" for the last clause is out of place as is prefixed to the following enumeration "of the sons of Parosh," etc. So the Sept. read it (*ἀπὸ υἱῶν Δαυὶδ, Ἀρροῦς ἀπὸ υἱῶν Σαχαΐα*); and the apocryphal version more plainly still (1 Esdras viii, 29, *ἐκ υἱῶν Δαυὶδ, Ἀρροῦς ὁ Σαχειῖου*). But still more probably a different Hattush (q. v.) is meant.

3. The concluding argument on the same side is derived from "the circumstance that in the next ascent from Babylon after that of Ezra, and in the same reign, the principal opponent of Nehemiah in his work of rebuilding Jerusalem was a man [Sanballat] who can be demonstrated to have continued an active chief of the Samaritans till the time of Alexander the Great, and to have then founded the temple on Mount Gerizim, Joseph. *Ant.* xi, 8, 2-4" (Dr. Mill, *u. s.*). Josephus's story is that Sanballat, satrap in Samaria of Darius III, had given his daughter in marriage to a brother of the high-priest Jaddua, named Manasses, who, refusing to put her away, took refuge with his father-in-law, and became the first high-priest of the rival temple built on Mount Gerizim by permission of Alexander, then engaged in the siege of Tyre. All this, with perhaps the marvellous romance that follows about Alexander's reception by the high-priest Jaddua, needs a better voucher than Josephus before it can be accepted as history. The story about Manasses and Sanballat is clearly derived from the last recorded act of Nehemiah, his expulsion of a son of Joiada, and grandson of the then high-priest Eliashib, who was son-in-law to Sanballat the Horonite. It is remarkable that Josephus, in his account of Nehemiah, makes no mention of this act, and does not even name Sanballat: the reason of which may be that, after referring the mission of Nehemiah, as also of Ezra, to the reign of Xerxes, to extend the life of this active chief of the Samaritans from that time to the time of Alexander, full 180 years later, would have been too absurd. See SANBALLAT. So is the assumption of Petermann (s. v. "Samaria," in Herzog's *Real-Encyclop.* xiii, 1, p. 367) that there were two Sanballats, one contemporary with Nehemiah, the other with Alexander, and that both had daughters married into the family of the high-priest (Eliashib and Jaddua), whose husbands were therefore expelled. As to Jaddua, the fact may be, as Josephus represents it, that he was still high-priest in the time of Alexander. The six who are named in lineal succession in Neh. xii, 10, 11; Jeshua, Joiakim, Eliashib, Joiada, Johanan, and Jaddua, will fill up the interval of 200 years from Cyrus to Alexander. Of these, Eliashib was still high-priest in the thirty-second year of Nehemiah's Artachshasta, and later (xiii, 6, 28); it is scarcely possible that this could be Artaxerxes Mnemon, whose thirty-second year is removed from the first of Cyrus by more than 160 years, which is far too much for a succession of three high-priests. It does not follow from the mention of the successors of Eliashib down to Jaddua in xii, 10 sq., that Nehemiah lived to see any of them in the office of high-priest, but only that

these genealogies and lists were brought down to his own times by the compiler or last redactor of this book (see under No. 3 below).—Kitto, *Cyclop.* s. v. See NEHEMIAH.

DARIUS HYSTASPIS (i. e. son of Hystaspes or Vastaspas), the fifth in descent from Achemenes, the founder of the Perso-Arian dynasty, or ninth in the succession of the Archemenids (comp. Herod. vii, 11), as he styles himself in the *Behistun* (q. v.) *Inscription* (Rawlinson, *Herod.* ii, 491), being third descendant from the younger brother of Cambyses, father of Cyrus, was, according to the popular legend (Herod. i, 209, 210), already marked out for empire during the reign of Cyrus. Cambyses having died without issue, and no other son of Cyrus surviving, Darius was hereditary successor to the throne, to which, as Herodotus relates, he was elected on the death of the pretended Smerdis by his fellow-conspirators. In the Canon, the date of his accession is B.C. 521, and the length of his reign 36 years, both points confirmed by Herodotus (vii, 1-4), according to whom he died five years after the battle of Marathon (therefore B.C. 485), after a reign of thirty-six years (also attested by an Egyptian inscription, Rosellini, *Mon. Storici*, ii, 164). He devoted himself to the internal organization of his kingdom, which had been impeded by the wars of Cyrus and Cambyses, and the confusion of the reign of Smerdis. His designs of foreign conquest were interrupted by a revolt of the Babylonians, under a pretender who bore the royal name of Nabukdrassar (Niebuhr, *Gesch. Ass. und Bab.* p. 94), which was at length put down, and punished with great severity (B.C. cir. 516). After the subjugation of Balyon, Darius turned his arms against Scythia, Libya (Herod. iv, 145 sq.), and India (Herod. iv, 44). Thrace and Macedonia acknowledged his supremacy, and some of the islands of the *Ægean* were added to his dominion in Asia Minor and the seaboard of Thrace (B.C. 518-506). Shortly afterwards he came into collision with Greece, and the defeat of Marathon (B.C. 490) only roused him to prepare vigorously for that decisive struggle with the West which was now inevitable. His plans were again thwarted by rebellion. Domestic quarrels (Herod. vii, 2) followed on the rising in Egypt, and he died (B.C. 485) before his preparations were completed (Herod. vii, 4).

With regard to the Jews, Darius Hystaspis pursued the same policy as Cyrus, and restored to them the privileges which they had lost. For the usurpation of Smerdis involved a religious as well as a political revolution, and the restorer of the Magian faith willingly listened to the enemies of a people who had welcomed Cyrus as their deliverer (Ezra iv, 17 sq.). But in the second year of Darius, B.C. 520, as soon as his power had assumed some solidity, Haggai (Hag. i, 1; ii, 1, 10) and Zechariah encouraged their countrymen to resume the work of restoration (Ezra v, 1 sq.), and when their proceedings came to the king's knowledge he confirmed the decree of Cyrus by a new edict, and the Temple was finished in four years (B.C. 516; Ezra vi, 15), though it was apparently used before that time (Zech. vii, 2, 8). The benefits conferred by Darius upon the Jews are not mentioned in his inscriptions. Of the satrapies, twenty in number, into which he formed the empire, Palestine would be part of the fourth, including Syria, Phœnicia, and Cyprus. The fourth king of Persia, who should "be far richer than they all, and by his strength, through his riches, should stir up all against the realm of Grecia" (Dan. xi, 2), may be Darius, if the pseudo-Smerdis is reckoned, but the description better suits Xerxes (see Hitzig in the *Kgf. exeget. Hdb.* in loc.).—Kitto, s. v.; Smith, s. v.

3. "Darius the Persian" (דָּרְיֹוֹס הַפָּרְסִי) 'Ἡ. Sept. Δαρείος ὁ Πέρσης) occurs (Neh. xii, 22) in a passage which merely states that the succession of priests was registered up to his reign. The question as to the person

here intended bears chiefly on the authorship of the passage. It may be briefly stated thus: If, as is more commonly believed, this king be Darius Nothus (originally Ochus), who came to the throne in B.C. 424, and reigned nineteen years, we must (assuming that the Jaddua here mentioned is the high-priest who went out to meet Alexander the Great [q. v.] on his entry into Jerusalem, Josephus, *Ant.* xi, 8) conceive either that Jaddua reached an age exceeding a century—for so long he must have lived, if he was already high-priest in the reign of Darius Nothus, and saw Alexander's entry; or that the Jaddua of Nehemiah and of Josephus was not the same person. Carpov has tried to show, from this very chapter, that the Jaddua of ver. 22 was a Levite, and not the high-priest (*Introduct. ad Libr. Vet. Test.* p. 347). See JADDUA. If, however, the register was continued to a later time, as is not improbable, the occurrence of the name Jaddua (ver. 11, 22), who was high-priest at the time of the invasion of Alexander (q. v.), points to Darius III Codomannus, the antagonist of Alexander, and last king of Persia, B.C. 336-330 (1 Macc. i, 1). Compare Jahn, *Archäol.* II, i, 272 sq.; Keil, *Lehrb. d. Einleit.* § 152, 7, who defends at length the integrity of the passage. On this latter view, we must either assume that Nehemiah himself attained the age of 130 years at least, or that this passage is an interpolation by a later hand (Bertholdt, *Einleit.* iii, 1081). Perhaps the meaning of the verses in question only is, that the priests enumerated were those included in the genealogical records down to the time of the return from Babylon, i. e. as finally made out by Nehemiah and Ezra (ver. 26); and therefore containing those prospectively high-priests, although at the time but children. Supposing that Jaddua was five years of age at the time of the closing of the O. T. canon [see EZRA], in B.C. 406 (to which date Nehemiah undoubtedly lived), he would have been but about fifty years old on his accession as high-priest (q. v.), B.C. cir. 359. The king referred to in Neh. xii, 22, would then be Darius Nothus. This explanation is consistent with all the circumstances, and leaves the authenticity of the passage unaffected.

DARIUS II was named OCHUS (Ὀχός), but on his accession he was distinguished by the epithet NORXUS (Νόξος), from his being one of the seventeen illegitimate sons of Artaxerxes I or Longimanus, who made him satrap of Hyrcania. He rebelled against Sogdianus, another brother, who had murdered their father, and, with the aid of several of the provincial satraps, succeeded in gaining supreme power, putting the usurper to death. He was a weak prince, completely under the control of his favorites, and especially of his wife Parysatis; and his reign was distinguished by continual insurrections, particularly that of the Egyptians, who succeeded in gaining for a while their independence (B.C. 414). Darius died in B.C. 405-4, and was succeeded by his oldest son Artaxerxes II (Ctesias, *Pers.* xlv-lvi; Diod. Sic. xii, 71; xiii, 86, 70, 108; Xenoph. *Hell.* i, 2, 19; ii, 1, 8; *Anab.* i, 1, 1).

Darkemon. See DARIC.

Darkness (properly $\tau\acute{\omega}\nu\tau\eta\varsigma$, *chaó's shek*; $\sigma\acute{\kappa}\omicron\tau\omicron\varsigma$), the absence of light; the state of chaos as represented by the sacred writer in Genesis i, 2. See CREATION.

The plague of darkness in Egypt (Exod. x, 21) was one so thick and intense as to seem almost palpable. The "palpable obscure" of Milton appears to express the idea in a forcible manner. The Tamil translation gives "darkness which causeth to feel, or so dark that a man is obliged to feel his way, and until he shall have so felt he cannot proceed. Some expositors are disposed to contend for the literal palpableness of this darkness by supposing that the agency employed was a wind, densely filling the air with particles of dust and sand. Such winds are not unknown in the Eastern deserts, and they are always very ap-

palling and destructive in their effects. Others think that a dense fog was spread over the land; but a denseness consisting of thick clammy fogs and exhalations, so condensed as to be perceived by the organs of touch, might have extinguished animal life in a few hours. Whether the darkness was exhibited in these or any other forms, the miracle must have struck the Egyptians with astonishment and horror, as the sun was one of their principal deities, and was supposed to be the source of life and the soul of the world, and with the moon to rule all things. See PLAGUES OF EGYPT.

In the Gospels of Matthew (xxvii, 45) and Luke (xxiii, 44) we read that, while Jesus hung upon the cross, "from the sixth hour there was darkness over all the land unto the ninth hour." Most of the ancient commentators believed that this darkness extended to the whole world. But their arguments are now seldom regarded as satisfactory, and their proof even less so. Of the latter the strongest is the mention of an eclipse of the sun, which is referred to at the time by Phlegon Trallianus, and, after him, by Theodorus (ap. Africanum). But even an eclipse of the sun could not be visible to the whole world; and neither of these writers names the place of the eclipse. Some think it was Rome; but it is impossible that an eclipse could have happened from the sixth to the ninth hour both at Rome and Jerusalem. It is, therefore, highly probable that the statement of Phlegon, which in the course of time has come to be quoted as independent authority, was taken from the relation of the Christians or from the Scriptures. That the darkness could not have proceeded from an eclipse of the sun is further placed beyond all doubt by the fact that, if then the time of the Passover, the moon was at its full. This darkness may therefore be ascribed to an extraordinary and preternatural obscuration of the solar light, which might precede and accompany the earthquake that took place on the same occasion; for it has been noticed that often before an earthquake such a mist arises from sulphureous vapors as to occasion a darkness almost nocturnal (see the authorities in Kuinöl *ad Matt.* xxiv, 29, and compare Joel iii, 1: Rev. vi, 12 sq.). See EARTHQUAKE. Such a darkness might extend over Judea, or that division of Palestine in which Jerusalem stood, to which the best authorities agree that here, as in some other places, it is necessary to limit the phrase $\pi\acute{\alpha}\sigma\alpha\nu\ \tau\eta\nu\ \gamma\eta\nu$, rendered "all the land." In the "Acts of Pilate" (q. v.), which have been quoted by Justin Martyr and Tertullian, we find the following document, in which this preternatural darkness is referred to. See ECLIPSE.

"Pilato to Tiberius, etc.

"I have at length been forced to consent to the crucifixion of Jesus Christ, to prevent a tumult among the Jews, though it was very much against my will. For the world never saw, and probably never will see, a man of such extraordinary piety and uprightness. But the high-priests and Sanhedrin fulfilled in it the oracles of their prophets and of our *scriptures*. While he hung on the cross, a horrid darkness, which covered the earth, seemed to threaten its final end. His followers, who profess to have seen him rise from the dead and ascend into heaven, and acknowledge him for their God, do still subsist, and, by their excellent lives, show themselves the worthy disciples of so extraordinary a master. I did all I could to save him from the malice of the Jews, but the fear of a total insurrection made me sacrifice him to the peace and interest of your empire," etc.

The "thick darkness" in which God is said to have been (Exod. xx, 21), was doubtless the "thick cloud upon the mount" mentioned chap. xix, 16; and the "thick darkness" in which "the Lord said that he would dwell" (1 Kings viii, 12), has reference to the cloud upon the mercy-seat, in which he promised to "appear" to Aaron, and which seems to have been rather a cloud of glory and light than of darkness. See CLOUD. When it is said (Psa. xcvi, 3) "clouds and darkness are round about him," the reference is apparently to the inscrutability of the divine nature and working. The darkness which is frequently (Isa. xlii, 9, 10; Joel ii, 31; iii, 15; Matt. xxiv, 29, etc.) con-

ected with the coming of the Lord has reference to the judgments attendant on his advent.

"Darkness is often used symbolically in the Scriptures as opposed to light, which is the symbol of joy and safety, to express misery and adversity (Job xviii, 1; Psa. cvii, 10; cxliii, 8; Isa. viii, 22; ix, 1; lix, 9, 0; Ezek. xxx, 18; xxxii, 7, 8; xxxiv, 12); hence also captivity (Isa. xlvii, 6; Lam. iii, 6). 'He . . . that maketh the morning darkness,' in Amos iv, 13, is supposed to be an allusion to the dense black clouds and mists attending earthquakes. 'The day of darkness' in Joel ii, 2, alludes to the obscurity occasioned by the flight of locusts in compact masses. See Loewstr. In Ezek. viii, 12, darkness is described as the accompaniment of idolatrous rites. Darkness of the sun, moon, and stars is used figuratively to denote a general darkness or deficiency in the government or body politic (Isa. xlii, 10; Ezek. xxxii, 7; Joel ii, 10-11). In Eph. v, 11, the expression 'works of darkness' is applied to the heathen mysteries on account of the impure actions which the initiated performed in them. 'Outer darkness' in Matt. viii, 12, and elsewhere, refers to the darkness outside, in the streets or open country, as contrasted with the blaze of cheerful light in the house, especially when a convivial party is held in the night time. And it may be observed that the streets in the East are utterly dark after night-fall, there being no shops with lighted windows, nor even public or private lamps to impart to them the light and cheerfulness to which we are accustomed. This gives the more force to the contrast of the 'outer darkness' with the inner light. Darkness is used to represent the state of the dead (Job x, 21; xvii, 13). It is also employed as the proper and significant emblem of ignorance (Isa. ix, 2; lx, 2; Matt. vi, 23; John iii, 9; 2 Cor. iv. 1-6)" (Kitto). See Wemyss, *Symbol. Dict.* s. v.

Dar'kon (Heb. *Darkon'*, דַּרְקוֹן; according to Gesenius, *streuer*; according to Fürst, *porter*; Sept. *Δαρκων*, *Δορκων*; Vulg. *Deron*), a person whose "children" or descendants were among "Solomon's servants" that returned from Babylon with Zerubbabel (Ezra ii, 56; Neh. vii, 58). B.C. ante 536.

Darling (דַּרְלִיךְ, *gachid'*, only, hence beloved) stands (Psa. xxii, 21; xxxv, 17) for *life* (as a thing not to be replaced); hence *self* (like עַצְמִי, *soul*; comp. "dear me").

Darom (דַּרְוֹם; Sept. *λίψ*, and *Δαρόμ*). This word is generally used in Scripture to denote "the south" (Ezek. xl, 24; Job xxxvii, 17). Its meaning in Deut. xxxiii, 23 is doubtful. Moses in blessing Naphtali says, "Possess thou the sea and *Darom*." The A. V. renders it "the west and the south;" the Septuagint, *θάλασσαν και λιβα*; the old Latin, "mare et Africum;" and the Vulgate, "mare et meridiem." The territory of Naphtali lay on the north-east of Palestine. It did not touch or go near the Mediterranean; consequently "the sea" cannot mean the Mediterranean. The sea of Galilee is doubtless referred to, the whole western shore of which belonged to Naphtali. The Septuagint rendering of Darom in this passage (*λιψ*, i. e. Africa) must be wrong. Naphtali never had any connection with Africa, or with that region on its northern frontier afterwards called Darom. The word seems here to denote a district near Tiberias, and probably the sunny plain of Genesareth, which surpassed all the rest of Palestine in fertility (Joseph. *War*, iii, 10, 8). With this agrees the probable etymology of the word, which, according to Gesenius, signifies *bright*, according to Fürst, *glowing*.

In Ezek. xx, 46 (xxi, 2), Darom appears to be a proper name. "Son of man, set thy face towards Teman, and drop the word towards *Darom*." The A. V. translates both words "south," but the Septuagint more correctly *Θαιμάν* and *Δαρόμ*. Instead of *Δαρόμ*

Symmachus gives *Λίβα*. We learn from Jerome and other ancient writers that the plain which lies along the southern border of Palestine and extends towards Egypt was formerly called Darom. Thus, Jerome says, Duma "is a large village in Darom—that is, in the south country in the region of Eleutheropolis, seventeen miles distant from that city" (*Onomast.* s. v. Darom); and Eusebius describes Gerar as situated *ὑπὲρ τὸν Δαρωμῶν* (ib. s. v. *Γέραρα*). The name appears to have been applied to the whole plain from the Mediterranean to the Arabah, and southern shore of the Dead Sea (Reiland, *Palæst.* p. 185 sq.). In the early ages of Christianity a Greek convent was erected near the coast, about seven miles south of Gaza, and named *Daron*. During the crusades it was converted into a fortress, and was the scene of many a hard struggle between the Christians and Saracens (Will. Tyr. in *Gesta Dei per Francos*, p. 988; Marinus Sanutus, p. 88, 246; Bohadin, *Vita Saladini*, p. 72, and *Index Geog.* s. v. Darounum; Robinson, *Bib. Res.* ii, 375). The site is now marked by a small village called *Deir el-Balah*, "the convent of the dates" (Porter, *Handbook for S. and P.* p. 266).—Kitto, s. v.

Dart (in Prov. vii, 23, דָּרְחָה, *chets*, an arrow, as elsewhere; in Job xli, 26, מַסְסָה, *massa'*, an arrow; in 2 Sam. xvii, 14, מַדְבָּח, *she'bet*, a rod or staff, as elsewhere; in 2 Chron. xxxii, 5, מַדְבָּח, *she'lach*, any missile weapon; in Job xli, 29, מַדְבָּח, *tothack'*, a bludgeon; in the New Test. βίλος, Eph. vi, 16, or βολίς, Heb. xii, 20, a javelin), an instrument of war similar to an arrow or light spear. It is thought that the Hebrews were in the habit of discharging darts from the bow while on fire. These fiery darts were made of the shrub *rothem* or Spanish broom (the *Spartium junceum* of Linn.), which grows abundantly in the Arabian desert. It is probably in reference to this fact that arrows are sometimes compared to lightnings (Deut. xxxii, 23, 42; Psa. vii, 18; cxx, 4; Zech. ix, 14). The fiery darts among the Romans, according to Ammianus Marcellinus, consisted of a hollow reed, to the lower part of which, under the point or barb, was fastened a round receptacle, made of iron, for combustible materials, so that such an arrow had the form of a distaff. This was filled with burning naphtha, and when the arrow or dart was shot from a slack bow (for if discharged from a tight bow the fire went out) it struck the enemies' ranks and remained fixed, the flame consuming whatever it met with; water poured on it increased its violence, and there were no other means to extinguish it but by throwing earth upon it. Similar darts or arrows, which were twined round with tar and pitch and set fire to, are described by Livy as having been made use of by the inhabitants of the city of Saguntum when besieged by the Romans (*Hist.* xxi, 9). The apostle alludes to these fiery darts in Eph. vi, 11-16. See ARMS.

Datarius (*datary*), a chancellor in the papal court. His title is derived from *datum*, usually prefixed to the date of the documents issued (e. g. datum, given, August 20). He is always a prelate, and sometimes a cardinal, and receives his name from his office, which is to *date* certain petitions for benefices that have been presented and registered: he writes upon them *Datum Romæ apud*, etc. He is empowered to grant, without acquainting the pope therewith, all benefices which do not produce upwards of twenty-four ducats annually; for such as amount to more he is obliged to get the provisions signed by the pope, who admits him to audience every day. If there be several candidates for the same benefice, he has the liberty of bestowing it on any whom he may select. His salary is two thousand crowns, exclusive of perquisites. When the pope's consent has been obtained, the datary subscribes the petition with the words *Annuit sanctionibus*. The pope's assent is subscribed in these words,

Fiat ut petitur, "Be it according to the petition." The pope's bull granting the benefice is then dispatched by the datary, and passes through the hands of many persons, belonging to different offices, who have all their stated fees. It is very expensive to procure the pope's bull for a benefice, and very large sums go into the office of the datary, especially when the provisions are for bishoprics, or other rich benefices.—Buck, *Theol. Dict.* s. v.; Farrar, s. v.

Dathe, JOHANN AUGUST, an eminent Oriental scholar and Biblical critic, was born at Weissenfels July 4, 1731, became professor of Oriental literature at Leipsic in 1762, and died March 17, 1791, at Leipsic. His chief work is *Libri Vet. Test. ex recensione textus Heb. notisque philolog. et crit. illustrati* (Hale, 1791, 6 vols. 8vo). He also edited Glassius, *Philologia Sacra*, and the *Prolegomena* to Walton's Polyglot (Lips. 1777); a *Syriac Psalter*, with the translation and notes of Erpenius (Halle, 1768); and (posthumous) *Opuscula ad Crisim et interp. Vet. Test. spectantia* (ed. by Rosenmüller, jun., Lips. 1795).

Date (2 Chron. xxxi, 5, margin, for דַּבְּשָׁן, *debash*, "honey," Sept. μέλι, Vulg. mel), the fruit of one species of the palm (דַּבְּשָׁן [Talm. דַּבְּשָׁן, comp. δάστυλος, date], φοίνικ, *Phoenix dactylifera* of Linn.). This tree formerly grew abundantly in Palestine (Joel i, 12; Neh. viii, 15; Judg. iv, 5; Mishna, *Biccuring*, i, 10; comp. Pliny, xiii, 6; Tacitus, *Hist.* v, 6, 2; Theoph. *Plant.* ii, 8; Pausan. ix, 19, 5), especially in certain warm localities (Schubert, *Reisen*, p. 105), namely, around Jericho (which hence was called the Palm City, Josephus, *Ant.* xv, 4, 2; Pliny, v, 15; xiii, 9; Strabo, xvi, 768; Philostr. *Apollon.* vi, 89), En-gedi (Solin. xxxviii, 12), and the Dead Sea (Diod. Sic. ii, 48; xix, 98); also at the Sea of Galilee (Josephus, *War*, iii, 10, 8); as a stately tree (especially fine at Jericho, Strabo xvii, 800; Galen, *Facult. alim.* ii, 26; Buxtorf, *Lex. Chald.* col. 1109; Pliny, xiii, 9), so that on Jewish and Roman coins (also Phœnician, Spanheim, *Præstant. et us. num.* p. 272) it was even employed as the symbol of the country (Froelich, *Ann. Syr. tab.* 18; see the praises of Idumæan palms in Virgil, *Georg.* iii, 12; Sil. Ital. iii, 600; vii, 456; Lucan, iii, 216; Martial, x, 50, 1). At present it is seldom to be met with there (Shaw, *Travels*, p. 297; Schubert, iii, 114; at Jericho there exists but a solitary one, Robinson, *Researches*, ii, 587; at En-gedi none whatever, Robinson, ii, 441); they are abundant, however, and even grow wild in Arabia (in Arabia Petræa they were anciently found here and there, Exod. xv, 27; Num. xxxiii, 9; comp. Burckhardt, *Reisen*, ii, 815; Robinson, i, 256, 264), in Egypt (Strabo, xvii, p. 818; Gellius, vii, 16, 5; Prosp. Alpin. *Plant. Eg.* c. 7) and Persia (Kämpfer, *Amoen.* p. 669; on the extent of the date-palm, see Link, *Urwelt*, i, 847 sq.; Arago, in the *Annuaire du Bureau des Longitudes*, 1834), in which countries it has from antiquity been regarded as the choicest of fruit-trees (Strabo, xvi, 742; Plato, *Sympos.* viii, 4-5; compare Hasselquist, p. 541). It loves a light, sandy, warm soil (Josephus, *War*, iii, 10, 8), yet not one deficient in moisture (Sirach xxiv, 14; Strabo, xvi, 776; Pallad. *R. R.* xi, 12), attains a height of 30 to 40 (in some instances 60 and even 100) feet, and lives till about 200 years old (Pliny, xvi, 89; Plutarch, *Sympos.* viii, 4, 2; Shaw, p. 128; comp. [in the Sept.] Job xxix, 18); it has a slim (Cant. vii, 7), straight, single trunk of 10 to 18 inches' diameter, covered rather with the scaly remains of the boughs that have fallen or broken off than with a proper bark. At its summit only the palm bears a large number (40 to 80) slender branches, which, growing shorter and shorter towards the top (the bottom ones being some 20 feet long), and bending at the ends in a curve towards the ground, inclose a considerable extent of shade (Wellsted, i, 70). The boughs generally surround the body in a circle six in

number, and put forth rush-like, sword-shaped, evergreen (Psa. xcii, 13; comp. Shaw, p. 128) leaves, about 2 inches broad, and 8 to 12 feet long. In the mid of the topmost and youngest branches is found a pointed, pithy heart (ἀγχιφάλοι, or head), nearly two feet in length, which contains the buds of new twigs and leaves (this, when cut off, was relished as a dainty article of food from the taste of the drupes, Theop. *Plant.* ii, 8; Pliny, xiii, 9; Mishna, *Oleam*, iii, 7; Martini, *Trav.* p. 407). Staminate and pistillate leaves are upon separate stems. This renders an artificial fertilization necessary in order to insure the probe (see Mishna, *Peacah*, iv, 8; Ammian. Marc. xxiv, 1; 18, Bip.), for which the right time must be very exactly observed. For in February there appear on the stem, at the joints of the lowest branches, long (two one yard) capsules, inclosed in a leathery skin (which in May shoot up into male blossoms and female catkins. The former are now plucked off (about March), slit through the length, and inserted upon the female germs (Kämpfer, *Amoen.* p. 707; Hasselquist, p. 12, 228 sq.; Shaw, p. 127; Thevenot, ii, 170). See Botta



Cluster of Date-palm Fruit.

The fruit (Talm. דַּבְּשָׁן, Surenhusius, *Mischk.* i, 258; vi, 91), which comes to maturity in about five months (August and September, or October), hangs in clusters (Cant. vii, 7) together, in form like the same but mostly larger, and with a fine ruddy (Diod. Sic.



Ancient Egyptian Cake of preserved Dates, found by Wilkinson at Thebes. At a is a Date-stone.

ii, 53) or white skin. The best kind is called *jeu*. They were sometimes used in a fresh state (Hesiod. *Æth.* ii, 23; comp. Hasselquist, p. 540) as a very common article of food (Burckhardt, *Arab.* p. 45, 57; Harmar, iii, 415), sometimes dried as a *desert-fruit* (Xenoph. *Anab.* ii, 3, 15), and sometimes their juice was pressed out (comp. Jonathan's *Targum* on Deut. viii, 8), which, as *date-wine* (οἶνος φοινίκων), was in use of from ancient times (Herod. i, 136; iii, 86; Xenoph. *Anab.* ii, 8, 14; Pliny, xiii, 9; xiv, 29; Philostr. *Apol.* ii, 6, 1; Athen. xiv, 651; Strabo, xvi, p. 72; Dioscor. v, 40; Wilkinson, iii, 174 sq.), or occasionally:

oiled down into a kind of *palm-honey* (*Targ. Jon.* and *Jerus.* on Deut. viii, 8; *Strabo*, xi, 742; *Pliny*, xiii, 9; *Amnian. Marcel.* xxiii, 10; *Josephus, War.* iv, 8, 3; *Ihaw*, p. 128; *Heeren, Ideen*, I, ii, 46). See **WINE**; **IOKEY**. The dates (*caryota*, φοινικιαβάλανοι) left by this last operation of squeezing, being still further subjected to the action of hot water, and thus *saccerated*, are made into an inferior but palatable vine. The ripe dates are also at the present day pressed into large, firm, caky masses, which serve the ravelers in caravans as a satisfying and refreshing diment (*Sonnini*, ii, 26; *Burckhardt, Arab.* p. 45). This is the form, similar to that of raisins or figs, in which they appear in modern commerce. From the wigs (ribs of the leaves) baskets are made (*Mishna, Thel.* xxvi, 1), also bird-cages and other wicker-ware; their fibres are twisted into ropes and thread, but the leaves themselves are manufactured into baskets, mats, and brooms (*Horace, Sat.* ii, 4, 83; *Mishna, Oken*, i, 8; *Pococke, East*, i, 306; *Döbel, Wander.* ii, 194; hence the palm-twigs were called κάλλυπτήρια or κάλλυπτρα; compare *Sept.* at Lev. xxiii, 42 sq., פְּטוֹר תְּמָרִים; accordingly, in *Cant. vii*, 8, by פְּטוֹרֵי תְּמָרִים, boughs, we are to understand the crown of the palm; ascetics used the leaves for clothing, *Jerome, Opp.* ii, 10; they are now made into fans). The Jews employed palm-branches on the Feast of Tabernacles (*Lev.* xxiii, 40; *Neh.* viii, 15; like the Egyptians in honor of Osiris, *Minutoli*, p. 16), and on festive occasions they carried them before princes and distinguished personages, and waved them in token of joy and triumph (*Rev.* vii, 9; comp. *Virgil, Egek.* ii, 47; *Æn.* v, 111; *Plutarch, Sympos.* viii, 4, 1; *1 Macc.* xiii, 51; *John* xii, 13; *Philo, Opp.* i, 101; *Minutoli, Trav.* tab. 13). Even the kernels of the dates are made use of at the present day as fodder for cattle (*Burckhardt, Arab.* p. 542). The seed of the male tree, which sheds a fragrant odor, is greedily eaten by the modern Arabs (*Wellsted*, i, 200). The wood is very spongy, but it lasts pretty well as building material for inside beams (*Xenophon, Cyrop.* vii, 5, 11; *Strabo*, xv, 731; xvi, 739; xvii, 822. See generally *Theophr. Plant.* ii, 6 (*Sprenkel, Erläut.* ii, 73 sq.); *Plin.* xiii, 6 sq.; *Descr. de l'Egypte*, xvii, 108 sq.; *Celsius*, ii, 445 sq.; *Oken, Lehrb. d. Botanik*, II, i, 1003 sq.—*Winer*, i, 252. See **PALM-TREE**.

Da'than (Heb. *Dathan*, דָּתָן, *welled*, q. d. *Fontanus*; *Sept.* Δαθάν; *Joseph. Dathanos*, *Ant.* iv, 2, 2), a Reubenite chieftain, son of Eliab, who joined the conspiracy of Korah (q. v.) the Levite, and with his accomplices was swallowed up by an earthquake (*Num.* xvi, 1; xxvi, 9; *Deut.* xi, 6; *Psa.* cvi, 17; comp. *Ecclus.* xlv, 18). B. C. cir. 1618. See **EXODE**.

Dath'ema (Λιάθημα; *Alex.* and *Josephus, Dathema*; other MSS. Δάθημα; *Vulg. Dathema*), a fortress (τὸ ὄχυρωμα; *Joseph. φρούριον*) in which the Jews of Gilead took refuge from the heathen (*1 Macc.* v, 9; *Joseph. Ant.* xii, 8, 1). Here they were relieved by Judas and Jonathan (*1 Macc.* v, 24). They marched from Bozora to Dathema (ver. 28, 29), and left it for Maspha (Mizpeh) (ver. 35). The reading of the Peshito, *Ramtha*, points to Ramoth-Gilead, which can hardly fail to be the correct identification. Ewald, however (*Gesch. Isr.* iii, 2, p. 359, note), would correct this to *Damtha*, which he compares with *Dhami*, a place reported by *Burckhardt (Syr.* p. 196).—*Smith*, s. v.

Dathenus, ΠΑΤΕΡ, one of the Dutch Reformers, was born at Yperen, in Flanders. At an early age he entered the Carmelite monastery at Poperingen. Here he became acquainted with the doctrine of the Reformation, and was so captivated by it that he soon resolved to leave the monastery and repair to England. In London he followed the occupation of a printer. Enjoying liberty of conscience under the reign of Ed-

ward VI, he applied himself diligently to the study of the Scriptures, in the knowledge of which he made such proficiency that he was soon admitted to the service of the Church. He soon left England, and entered on the work of the ministry at Frankfort. He subsequently sojourned in the Palatinate. Here he seems to have been held in high esteem. He was one of the five Reformed preachers who, in the presence of the elector and the duke of Würtemberg, held a disputation with five Lutheran ministers on the ubiquity of Christ's body. In 1566 he returned to his native land. West Flanders was at first the scene of his labors. He soon became known as one of the most zealous of the Reformed preachers. His enthusiasm, the cogency of his reasoning, and his rude but captivating eloquence, attracted multitudes. His audience sometimes amounted to more than fifteen thousand. His labors were not confined to Flanders, but extended to Zealand and other parts of Holland. Obligated to flee for his life, he again sought refuge in the Palatinate, and at Frankenthal, whither many Dutch, French, and Walloons had fled, he exercised his ministry. From here he went to Heidelberg, where he became court-preacher to John Casimir. In 1578 he was sent as delegate from Ghent to the General Synod at Dort, over whose deliberations he presided. He preached in various cities of Holland, but made Ghent the place of his permanent abode. Here he became involved in political affairs. His harangues so inflamed the populace that the Romanists were driven out of the city, and great excesses were committed in and around Ghent. As a consequence he was again obliged to flee, and again he sought and found refuge with his former protector, John Casimir. In the midst of his active and troublous life he still found time for literary pursuits. His translation of the Heidelberg Catechism into Dutch was adopted, and has, with slight modifications, continued in use to the present time. He also gave a Dutch versification of the Book of Psalms, according to the French of Beza and Marot. This was also adopted by the Reformed Church, and was used in public worship till 1773, when it was superseded by a version of higher poetic merit. His burning zeal and abundant labors contributed much to advance the cause of the Reformation in Holland.

Daub, KARL, a German theologian of the Hegelian school, was born at Cassel March 20, 1766. In 1791 he became tutor in the academy of Marburg, where he had been studying since 1786. He was afterwards professor of philosophy in Hanau, and finally, in 1794, became professor of theology at Heidelberg. He died Nov. 22, 1836. Daub was one of the representatives of the new speculative theology. At first, especially in his *Predigten nach Kantischen Grundsätzen* (1794), and in his *Katechetik* (Heidelb. 1801), he was a Kantian; he afterwards inclined to Fichte; and in his *Theologoumena* (Heidelb. 1806), and *Einleitung in d. Studium d. Dogmatik* (Heidelb. 1810), he applied Schelling's doctrine to theology. As the latter ended with theosophic dualism, so Daub, in his *Judas Iscariot* (Heidelb. 1816; 2d ed. 1818), displayed a speculation almost bordering on Manicheism. This work bears witness to his struggle with Hegel's phenomenology and logic, but Hegel finally prevailed. Daub was a man of old German simplicity, great moral energy, and warm faith; yet, with a great talent for teaching, he was too abstract in his literary productions to influence a large circle. This is especially the case with his last work, *Die dogmatische Theologie jetziger Zeit* (Heidelb. 1833). He was associated with Creuzer in publishing a periodical entitled *Studien* (Heidelb. 1805-10, 6 vols.). His works have been published by Marheineke and Dittenberger (Berl. 1838-44, 7 vols.).—*Pierer, Univ.-Lexikon*, s. v.; *Kahn's, German Protestantism* (Edinb. 1856, 12mo, p. 243); *Rosenkranz, Erinnerungen an Carl Daub* (Berl. 1837); *Strauss, Charakteristiken u. Kritiken*; *Herzog, Real-Encyclop.* xix, 391.

Daubeny, CHARLES, a divine of the Church of England, was born in Bristol 1744, and was educated at Winchester School and at New College, Oxford. He became vicar of North Bradley 1778; obtained a prebend in Salisbury Cathedral in 1784; was appointed archdeacon of Sarum in 1804; and died in 1827. Besides numerous sermons and charges, he is the author of *A Guide to the Church* (Lond., royal 8vo, 1830); *Vindiciae Ecclesie Anglicanæ* (Lond. 1803, 8vo); *Remarks on the Unitarian Method of interpreting the Scriptures*; *Discourses* (3 vols. 8vo, Lond. 1802-16); and of minor works. At North Bradley he built almshouses for twelve poor persons, an asylum, and a school-room; and the church at Rode was erected partly at his expense.—*Christian Journal and Lit. Register*, xii, 177.

Daubuz, CHARLES, a French Protestant divine, was born in 1670, came to England on the revocation of the Edict of Nantes, and became vicar of Brotherton, Cheshire. He died in 1740. His *Commentary on the Book of Revelation* (Lond. 1720, folio) is a most elaborate work, to which later writers have been much indebted, and which is one of the most learned books written on the Apocalypse. The abridgment by Lancaster (Lond. 1780, 4to) forms a good analysis of its contents. Both works are rare. He also wrote *Protestatione Flavii Josephi de Jesu Christo*, libri duo, cum præfatione J. E. Grave (Lond. 1706, 8vo).—*Darling, Cyclopædia Bibliographica*, s. v.; *Rose, Biog. Dict.* vii, 26; *Elliott, Horæ Apoclypticas*, iv, 457; *Horne, Introduction*, v, 388, 9th ed.

Daughter (דַּוְרָה, *bath*, for דַּוְרָה, fem. of דָּר, *son*; *Συγαρίη*), a word used in Scripture in a variety of senses, some of which are unknown to our own language, or have only become known through familiarity with scriptural forms of speech. See **BEN-**. Besides its usual and proper sense of (1.) a daughter, born or adopted, we find it used to designate (2.) a uterine sister, niece, or any female descendant (*Gen.* xx, 12; xxiv, 48; xxviii, 6; xxxvi, 2; *Num.* xxv, 1; *Deut.* xxiii, 17). (3.) Women, as natives, residents, or professing the religion of certain places, as "the daughter of Zion" (*Isa.* iii, 16); "daughters of the Philistines" (2 *Sam.* i, 20); "daughter of a strange god" (*Mal.* ii, 11); "daughters of men," i. e. carnal women (*Gen.* vi, 2), etc. (4.) Metaphorically small towns are called daughters of neighboring large cities—metropolises, or mother cities—to which they belonged or from which they were derived, as "Heathbon and all the daughters [Auth. Vers. *villages*] thereof" (*Num.* xxi, 25); so Tyre is called the daughter of Sidon (*Isa.* xxii, 12), as having been originally a colony from thence; and hence also the town of Abel is called "a mother in Israel" (2 *Sam.* xx, 19); and Gath is in one place (*comp.* 2 *Sam.* vii, 1; 1 *Chron.* xviii, 1) called Gath-Ammah, or Gath the mother town, *metropolis*, to distinguish it from its own dependencies, or from another place called Gath. See **VILLAGE**. *Comp.* other instances in *Num.* xxi, 32; *Judg.* xi, 26; *Josh.* xv, 45, etc. (5.) The people collectively of any place, the name of which is given, as "the daughter (i. e. the people) of Jerusalem hath shaken her head at thee" (*Isa.* xxxvii, 22; see also *Psa.* xlv, 18; cxxxvii, 8; *Isa.* x, 30; *Jer.* xlvi, 19; *Lam.* iv, 22; *Zech.* ix, 9). This metaphor is illustrated by the almost universal custom of representing towns under the figure of a woman. (6.) The word "daughter," followed by a numeral, indicates a woman of the age indicated by the numeral, as when Sarah (in the original) is called "the daughter of ninety years" (*Gen.* xvii, 17). (7.) The word "daughter" is also applied to the produce of animals, trees, or plants. Thus, "daughter of the she-ostrich," (supposed for "female ostrich" (*Lev.* xi, 16); Joseph is called "a fruitful bough whose daughters (branches) run over the wall" (*Gen.* xlix, 22).—*Kitto*, s. v. See further in Gesenius and Fürst, s. v. דַּוְרָה.

The condition of daughters, that is, of young women, in the East, their employments, duties, etc., may be gathered from various parts of Scripture, and seem to have borne but little resemblance to that of young women of respectable parentage among ourselves. Rebekah drew and fetched water; Rachel kept sheep as did the daughters of Jethro, though he was a priest or a prince, of Midian. They superintended and performed domestic services for the family; Tamar, though a king's daughter, baked bread; and the sons of others. We have the same occupations for the daughters of princes in the ancient poets, of whom Homer is an unquestionable evidence.—*Calmet*, s. v. See **CHILD**; **EDUCATION**; **WOMAN**; **MARRIAGE**.

The original terms rendered "daughter-in-law" are in the Heb. כַּלְיָהּ, *kallah*; Sept. and New Test. νύμφη, both literally meaning a *bride* (as elsewhere rendered and applied to a *son's wife*).

Davenant, JOHN, D.D., bishop of Salisbury, was born in London about 1570, and was educated at Queen's College, Cambridge. In 1594 a fellowship was offered him, which he accepted after his father's death in 1597. In 1609 he was elected Lady Margaret professor of divinity. In 1614 he was chosen master of his college, and in 1618 was one of the four divines sent to the Synod of Dort by James I. See **DORT**. He returned to England in May, 1619, after having visited the most eminent cities in the Netherlands. In 1621 he was appointed to the see of Salisbury; but in 1630-81 he incurred the displeasure of the court by a sermon on predestination, "all curious search into which" the king, in his declaration prefixed to the Thirty-nine Articles in 1628, had strictly enjoined "to be laid aside." The bishop died of consumption in 1641. He was a man of great learning. He published *Expositio Epistolæ D. Pauli ad Colossenses* (Cambridge, 1630, 2d edition, fol.; translated by Alport, Lond. 1831, 2 vols. 8vo), *Prælectiones de dubiis in theologia cont. capitibus* (Cantab. 1631, fol.); *Determinationes questionum theologiarum* (Cantab. 2d edition, 1639, fol.); *Dissert. II de Mortæ Christi et de Predestinatione* (Camb. 1690). A translation of one of the *Prælectiones* appeared under the title *A Treatise on Justification, etc., translated from the original Latin* (Lond. 1844-46, 2 vols. 8vo). After bishop Davenant's return from the Synod of Dort, he published an earnest appeal for fraternal union among the Reformed churches, under the title *Ad fraternam communionem inter Evangelicæ Ecclesiæ restaurandam adhortatio* (Camb. 1640; transl. into English, 1641, 8vo).—*Biographia Britannica*, iv, 629.

Davenport, Christopher, an English Romanist divine, was born at Coventry about 1598, and was sent to Merton College, Oxford, at 15, but was persuaded at 17 by a priest to go to the Romanist college at Douai, France, and thence to Ypres. Here he became a Romanist and a Franciscan. Under the name of Franciscus a Sancta Clara he came as a missionary to England, and was made chaplain to Henrietta Maria, consort of Charles I. Davenport was a man of learning and of good address, and he labored zealously and successfully for the cause of Rome. On the death of Charles I he went abroad, and only appeared in England in disguise until the restoration of Charles II, when he became chaplain of queen Catharine and provincial of the English Franciscans. He died May 31, 1680. Among his writings are, *Paraphrastica Explicatio Articulorum Conf. Anglicanæ* (1635; new transl. Lond. 1865); *Deus, Natura, Gratia* (1635); both works aiming to show that the English Articles are not really hostile to Rome.—*New Gen. Biog. Dict.* iv, 324.

Davenport, John (elder brother of Christopher), an eminent Congregational minister, was born at Coventry, England, 1597. He was sent to Merton College, Oxford, 1613, and, after passing B.A., he entered the ministry at nineteen. Having served a short time

Hilton Castle as chaplain, he became rector of St. Stephen's Church, London. After an interview with r. John Cotton he became a Nonconformist, and, to cape bishop Laud, he fled to Holland in 1638. In 1635 he returned to London, and sailed for Boston, Mass., where he arrived June 26, 1637. With a number of others he sailed on March 30, 1638, for Quinipiac, New Haven. In 1639 a Church was formed, and on August 22 Mr. Davenport was installed pastor. He was ordained, with Mr. James Allen as colleague, pastor of the First Church, Boston, Dec. 9, 1668, and died May 15, 1672. He published *Instructions to the Elders of the English Church* (1634); *Report of some Proceedings against John Paget* (1634); *Allegations of Scripture against the Baptizing of some kind of Infants* (1634); *Atheism concerning the chief Heads of the Christian Religion* (Lond. 1659); and a number of occasional sermons.—*Sprague, Annals*, i, 94; *New Gen. Biog. Dict.*, v, 325.

David (Heb. *David'*, דָּוִד [in the full form, דָּוִדָּי, 1 Kings iii, 14, and in Chron., Ezra, Neh., Cant., Jos., Amos, Ezek. xxxiv, 28, and Zech.], affectionate name beloved; Arab. in common use *Dauid*; Sept. *Δαυΐδ*, I. T. Δαβίδ, older MSS. *Δαυειδ*; Joseph. *Δαυιδης*), the second but most prominent of the line of Jewish Kings. The following biography is chiefly compiled from the articles in Kitto's *Cyclop.* and Smith's *Dict. of the Bible*.

A. Personal Biography.—The authorities for the life of David may be divided into the following classes: I.) The original Hebrew authorities: (1.) The narrative of 1 Sam. xvi, to 1 Kings ii, 10; with the supple-

(3.) The Rabbinical traditions reported in *Basnage, Hist. des Juifs*, lib. v, c. 2; *Calmet's Dictionary*, s. v. David. (V.) The Mussulman traditions, chiefly remarkable for their extravagance, are contained in the Koran, ii, 250-252; xxxviii, 20-24; xxi, 79-82; xxii, 15, and explained in Lane's *Selections from the Koran*, p. 228-242; or amplified in Well's *Legends*, Eng. tr. p. 152-170. (VI.) In modern times his life has been often treated, both in separate treatises and in histories of Israel. Many of the monographs on almost every point in his life will be found referred to below. In English, the best known are, Delany's *Hist. Account* (Lond. 1741-2, 8 vols.), Chandler's *Life* (Lond. 1766, 2 vols.; new edit. Lond. 1853), and Blaikie, *David King of Israel* (London, 1856); in French, De Choisi's, and that in Bayle's *Dictionary*. One of the most recent, and, in some respects, the best treatment, is that in Ewald's *Geschichte des Volkes Israel*, iii, 71-267. See also Kitto, *Daily Bible Illustrations*, vol. ii. Other treatises on his life as a whole, or on the several incidents of it, are referred to in Darling's *Cyclopaedia*, iii, 290 sq.

David's life may be divided into the three following portions, more or less corresponding to the three old lost biographies by Samuel, Gad, and Nathan: I. His youth before his introduction to the court of Saul. II. His relations with Saul. III. His reign.

I. *The early life of David* contains in many important respects the antecedents of his after history. 1. His family are mostly well known to us by name, and are not without bearing on his subsequent career. For an extended view of David's lineage, see **GENEALOGY OF CHRIST**.

David's Family Register.

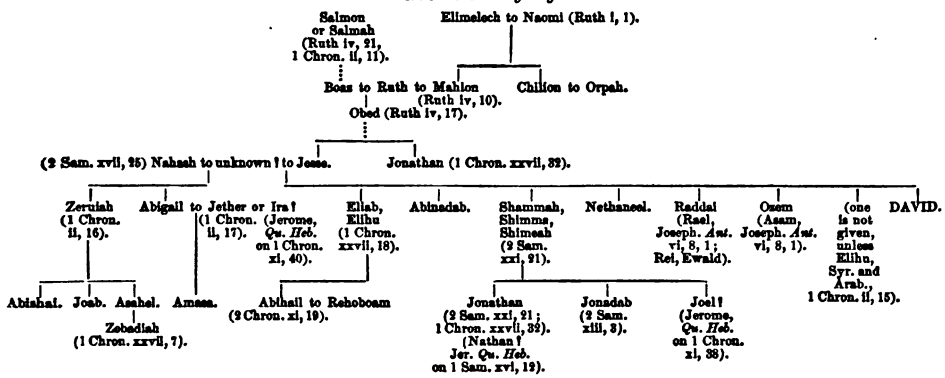

mentary notices contained in 1 Chron. xi, 1 to xxix, 30. (2.) The "Chronicles" or State-papers of David (1 Chron. xxvii, 24), and the original biographies of David by Samuel, Gad, and Nathan (1 Chron. xxix, 29). These are lost, but portions of them no doubt are preserved in the foregoing. (3.) The Davidic portion of the Psalms, including such fragments as are preserved to us from other sources, viz., 2 Sam. i, 19-27; iii, 33, 34; xxii, 1-51; xxiii, 1-7. See **PSALMS**. (II.) The two slight notices in the heathen historians, Nicolaus of Damascus in his *Universal History* (Josephus, *Ant.* vii, 5, 2), and Eupolemus in his *History of the Kings of Judah* (Euseb. *Præp. Ev.* lx, 80). (III.) David's apocryphal writings, contained in Fabricius, *Codex Apocryphus V. Test.* p. 906-1006. (1.) *Psa. cii*, on his victory over Goliath. (2.) *Colloquies with God*, on madness, on his temptation, and on the building of the Temple. (3.) *A charm against fire*. Of these the first alone deserves any attention. (IV.) The Jewish traditions, which may be divided into three classes: (1.) The additions to the Biblical narrative contained in Josephus, *Ant.* vi, 8-vii, 15. (2.) The Hebrew traditions preserved in Jerome's *Quæstiones Hebraicæ in Libros Regum et Paralipomenon* (vol. iii, Venice edit.).

It thus appears that David (born B.C. 1083) was the youngest son, probably the youngest child, of a family of ten. His mother's name is unknown. See **NAHASE**. We can only conjecture her character from one or two brief allusions to her in the poetry of her son, from which we may gather that she was a godly woman, whose devotion to God's service her son commemorates as at once a token of God's favor to himself, and a stimulus to him to consecrate himself to God's service (*Psa. lxxxvi, 16*; and perhaps *cxvi, 16*). His father, Jesse, was of a great age when David was still young (1 Sam. xvii, 12). His parents both lived till after his final rupture with Saul (1 Sam. xxii, 8). Certain points with regard to his birth and lineage deserve special mention.

(a) His connection with Moab through his ancestress Ruth. This he kept up when he escaped to Moab and intrusted his aged parents to the care of the king (1 Sam. xxii, 8). This connection possibly gave greater breadth to his views, and even to his history, than if he had been of purely Jewish descent. Such is probably the significance of the express mention of Ruth in the genealogy in *Matt. i, 5*.

(b) His birthplace, Bethlehem (q. v.). His recol-

lection of the well of Bethlehem is one of the most touching incidents of his later life (1 Chron. xi, 17). From the territory of Bethlehem, as from his own patrimony, he gave a piece of property as a reward to Chimham, son of Barzillai (2 Sam. xix, 37, 38; Jer. xli, 17). It is this connection of David with Bethlehem that gave importance to the place again in later times, when Joseph went up to Bethlehem, "because he was of the house and lineage of David" (Luke ii, 4).

(c) His general connection with the tribe of Judah, in which the tribal feeling appears to have been stronger than in any of the others. This connection must be borne in mind throughout the story both of David's security among the hills of Judah during his flight from Saul, and of the early period of his reign at Hebron, as well as of the jealousy of the tribe at having lost their exclusive possession of him, which broke out in the revolt of Absalom.

(d) His relations to Zeruah and Abigail. Though called in 1 Chron. ii, 16, sisters of David, they are not expressly called the daughters of Jesse; and Abigail, in 2 Sam. xvii, 25, is called the daughter of Nahash. Is it too much to suppose that David's mother had been the wife or concubine of Nahash, and then married by Jesse? This would agree with the difference of age between David and his sisters, and also (if Nahash was the same as the king of Ammon) with the kindnesses which David received first from Nahash (2 Sam. x, 2), and then from Shobi, son of Nahash (xvii, 27).

2. As the youngest of the family, he may possibly have received from his parents the name, which first appears in him, of *David*, the *darling*. But, perhaps for this same reason, he was never intimate with his brethren. The eldest brother, who alone is mentioned in connection with him, and who was afterwards made by him head of the tribe of Judah (1 Chron. xxvii, 18), treated him scornfully and imperiously (1 Sam. xvii, 28), as the eldest brothers of large families are apt to act; his command was regarded in the family as law (xx, 29); and the father looked upon the youngest son as hardly one of the family at all (xvi, 11), and as a mere attendant on the rest (xvii, 17). The familiarity which he lost with his brothers, he gained with his nephews. The three sons of his sister Zerulah, and the one son of his sister Abigail, seemingly from the fact that their mothers were the eldest of the whole family, were probably of the same age as David himself, and they accordingly were to him—especially the three sons of Zerulah—throughout life in the relation usually occupied by brothers and cousins. In them we see the rougher qualities of the family, which David shared with them, while he was distinguished from them by qualities peculiar to himself. The two sons of his brother Shimeah are both connected with his after history, and both seem to have been endowed with the sagacity in which David himself excelled. One was Jonadab, the friend and adviser of his eldest son Amnon (2 Sam. xiii, 8); the other was Jonathan (2 Sam. xxi, 21), who afterwards became the counsellor of David himself (1 Chron. xxvii, 32). It is a conjecture or tradition of the Jews preserved by Jerome (*Qu. Heb.* on 1 Sam. xvii, 12) that this was no other than *Nathan* the prophet, who, being adopted into Jesse's family, makes up the eighth son, not named in 1 Chron. ii, 13-15. But this is hardly probable.

The first record of David's appearance in history at once admits us to the whole family circle. B.C. 1068. There was a practice once a year at Bethlehem, probably at the first new moon of the year, of holding a sacrificial feast, at which Jesse, as the chief proprietor of the place, would preside (1 Sam. xx, 6), with the elders of the town. At this or such like feast (xvi, 1) suddenly appeared the great prophet Samuel, driving a heifer before him, and having in his hand a horn of the consecrated oil of the Tabernacle. The elders of the little town were terrified at this apparition, but

were reassured by the august visitor, and invited by him to the ceremony of sacrificing the heifer. The heifer was killed. The party were waiting to begin the feast. Samuel stood with his horn to pour forth the oil, as if for an invitation to begin (*comp.* ix, 27). He was restrained by divine intimation as soon after son passed by. Eliab, the eldest, by "his height" and "his countenance," seemed the natural counterpart of Saul, whose rival, unknown to them, the prophet came to select. But the day had gone by when kings were chosen because they were head and shoulders taller than the rest. "Samuel said unto Jesse. Are these all thy children? And he said, There yet remaineth the youngest, and behold he keepeth the sheep." The boy was brought in. We are enabled to fix his appearance at once in our minds. He was of short stature, thus contrasting with his tall brother Eliab, with his rival Saul, and with his gigantic enemy of Gath. He had red or Auburn hair, as is occasional in the East; or at least a rufous complexion and sanguineous temperament. See RUDDY. Later in life he wore a beard. His bright eyes are especially mentioned (xvii, 12), and generally he was remarkable for the grace of his figure and countenance ("fair of eyes," "comely," "goodly," xvi, 12, 18; xvii, 42), well made, and of great strength and agility. His swiftness and activity made him (like his nephew Asahel) like a wild gazelle, his feet like harts' feet, and his arms strong enough to break a bow of steel (Psa. xviii, 33, 34). He was pursuing the occupation allotted in Eastern countries usually to the slaves, the females, or the despised of the family (*comp.* the case of Moses, of Jacob, of Zipporah, and of Rachel, and in later times of Mohammed; Sprenger, p. 8). The pastures of Bethlehem are famous throughout the sacred history. The Tower of Shepherds (*Gen.* xxxv, 21) was there; and there too the shepherds abode with their flocks by night (Luke ii). He usually carried a switch or wand in his hand (1 Sam. xvii, 40), such as would be used for his dogs (xvii, 48), and a scrip or wallet round his neck to carry anything that was needed for his shepherd's life (xvii, 40). Such was the outer life of David when (as the later Psalmists described his call) he was "taken from the sheepfolds, from following the ewes great with young, to feed Israel according to the integrity of his heart, and to guide them by the skilfulness of his hands" (Psa. lxxviii, 70-72). The recollection of the sudden and great elevation from this humble station is deeply impressed on his after life. "The man who was raised up on high" (2 Sam. xxii, 1)—"I have exalted one chosen out of the people" (Psa. lxxxix, 19)—"I took thee from the sheepcote" (2 Sam. vii, 8). The event itself prepared him to do that in which Saul had so eminently failed, viz. to reconcile his own military government with a filial respect for the prophets and an honorable patronage of the priesthood. Besides this, he became knit into a bond of brotherhood with his heroic comrades, to whom he was eminently endeared by his personal self-denial and liberality (1 Sam. xxx, 21-31; 1 Chron. xi, 15).

3. But there was another preparation still more needed for his office, which probably had made him already known to Samuel, and which, at any rate, is his next introduction to the history. When the body-guard of Saul were discussing with their master where the best minstrel could be found to chase away his madness by music, one of the young men in the guard suggested David. Saul, with the absolute control inherent in the idea of an Oriental king, instantly sent for him, and in the successful effort of David's harp we have the first glimpse into that genius for music and poetry which was afterwards consecrated in the Psalms. It is impossible not to connect the early display of this gift with the schools of the prophets, who exercised their vocation with tabret, psaltery, pipe, and harp (1 Sam. x, 5), in the pastures (*Naioth*; *comp.* Psa. xxiii, 2), to which he afterwards returned as to

natural home (1 Sam. xix, 18). Whether any of the existing Psalms can be referred to this epoch of David's life is uncertain. The 28d, from its subject the shepherd, and from its extreme simplicity (though placed by Ewald somewhat later), may well have been suggested by this time. The 8th, 19th, and 29th, which are universally recognised as David's, describe the phenomena of nature, and, as such (at least at the two former), may more naturally be referred to this tranquil period of his life than to any other. The imagery of danger from wild beasts, lions, wild asses, etc. (Psa. vii, 2; xxii, 20, 21), may be reminiscences of this time. And now, at any rate, he must have first acquired the art which gave him one of his chief claims to mention in after times—"the sweet singer of Israel" (2 Sam. xxiii, 1), "the inventor of instruments of music" (Amos vi, 5); "with his whole art he sung songs and loved him that made him" (Ecclus. xlvii, 8).

4. One incident alone of his solitary shepherd life comes down to us—his conflict with the lion and a bear in defence of his father's flocks (1 Sam. xvii, 35). But it did not stand alone. He was already known to Saul's guards for his martial exploits, probably against the Philistines (xvi, 18), and when he suddenly appeared in the camp his elder brother immediately guessed that he had left the sheep in his charge to see the battle (xvii, 28). To this new aspect of his character we are next introduced. B.C. 1068. The scene of the battle is at Ephes-dammim (q. v.), the frontier hills of Judah, called probably from this similar encounter "the bound of blood." Saul's army is encamped on one side of the ravine, the Philistines on the other; the watercourse of Elah, or "the erebith," runs between them. A Philistine of gigantic stature, and clothed in complete armor, insults the comparatively defenceless Israelites, among whom the king alone appears to be well armed (xvii, 38; comp. xiii, 20). No one can be found to take up the challenge. At this juncture David appears in the camp, sent by his father with ten loaves and ten slices of cheese to his three eldest brothers, fresh from the sheepfolds. Just as he comes to the circle of wagons which formed, as in Arab settlements, a rude fortification round the Israelite camp (xvii, 28), he hears the well-known shout of the Israelite war-cry (comp. Num. xiii, 21). The martial spirit of the boy is stirred at the sound; he leaves his provisions with the baggage-master, and darts to join his brothers (like one of the royal messengers) into the midst of the lines. Then he hears the challenge, now made for the fortieth time—sees the dismay of his countrymen—hears of the reward proposed by the king—goes with the impetuosity of youth from soldier to soldier talking of the event, in spite of his brother's rebuke—he is introduced to Saul—undertakes the combat. His victory over the gigantic Philistine is rendered more conspicuous by his own diminutive stature, and by the simple weapons with which it was accomplished—not the armor of Saul, which he naturally found too large, but the shepherd's sling, which he always carried about with him, and the five polished pebbles which he picked up as he went from the watercourse of the valley, and put in his shepherd's wallet. Two trophies long remained of the battle—one, the huge sword of the Philistine, which was hung up behind the ephod in the Tabernacle at Nob (1 Sam. xxi, 9); the other the head, which he bore away himself, and which was either laid up at Nob, or subsequently at Jerusalem. See Nos. Psalm cxlv, though by its contents of a much later date, is by the title in the Sept. "against Goliath." But there is also a psalm, preserved in the Sept. at the end of the Psalter, and which, though probably a mere adaptation from the history, well sums up this early period of his life:

"This is the psalm of David's own writing (?) (ἰδιόγραφος εἰς Δαυὶδ), and outside the number, when he fought the single

combat with Goliath." "I was small amongst my brethren, and the youngest in my father's house. I was feeding my father's sheep. My hands made a harp, and my fingers fitted a psaltery. And who shall tell it to my Lord? He is the Lord, he heareth. He sent his messenger (angel?), and took me from my father's flocks, and anointed me with the oil of his anointing. My brethren were beautiful and tall, but the Lord was not well pleased with them. I went out to meet the Philistines, and he cursed me by his idols. But I drew his own sword and beheaded him, and took away the reproach from the children of Israel."

David's susceptible temperament, joined to his devotional tendencies, must, at a very early age, have made him a favorite pupil of the prophets, whose peculiar mark was the harp and the psalm (1 Sam. x, 1-12, and xix, 20-24; see also 2 Kings iii, 15).

There is no small difficulty in reconciling the recommendation of David to Saul as a skilful player and warrior in 1 Sam. xvi, 14-23, with the account in the following chapter of David's appearance in the camp of Saul, and his introduction to that monarch in consequence of his victory over Goliath. Both narratives apparently give the account of David's first introduction to Saul, and yet it is not possible to combine them into one. Some would transpose the latter part of the 16th chap. so as to make it follow after xvii, 9 (Horsley, *Bib. Crit.* i, 332); but it is not easy to see what is gained by this; for if David was known to Saul, and accepted into Saul's service as there narrated, how could Saul send for him to his father's house, and receive him as a perfect stranger, as narrated in xvi, 14-20? On the other hand, if David came before the notice of Saul under the circumstances mentioned in this 16th chapter, and was received into his favor and service as there narrated (21-28), how could the facts recorded in the 17th chapter, especially those in verses 31-37, and 55-58, have occurred? The Vatican MS. of the Sept. rejects xvii, 12-31, 55-58, and xviii, 1-5, as spurious; and this Kennicott approves as the true solution of the difficulty (see his discussion of the question, *Dissert. on the Hebrew Text*, p. 418-482, 554-558). What gives some plausibility to this is, that ver. 53 naturally connects with ver. 11, and all between has very much the aspect of an interpolation. At the same time, it can hardly be permitted on such grounds to reject a portion of Scripture which has all other evidence, external and internal, in its favor. The old solution of the difficulty, that as David, after his first introduction to Saul, did not abide constantly with him, but went and came between Saul and his father's house (xvii, 15), he may have been at home when the war with the Philistines broke out; and as Saul's disposition was of the nature of mania, he very probably retained no recollection of David's visits to him while under it, but at each new interview regarded and spoke of him as a stranger—still leaves unexplained the fact of Abner's ignorance of David's person, which appears to have been as complete as that of the king, and the fact of David's professing ignorance of warlike weapons, though he had been for some time Saul's armor-bearer. This last difficulty may be alleviated by the consideration that the statement in xvi, 21 may be proleptical; or David, though Saul's armor-bearer, may have had so little practice in the use of armor as to prefer, in such a crisis, trusting to the weapons with which he was familiar. The best adjustment of these passages, however, is to transpose the account in xvi, 14-23, so as to bring it in between xviii, 4 and 5, and to regard the statement in xviii, 2, of David's permanent residence at court after Goliath's slaughter as referring merely to an attachment to the royal person as a general thing and for the present. On the breaking out of Saul's hypochondria, David may naturally have returned home.

II. *David's History in connection with Saul.*—The victory over Goliath had been a turning-point of his career. Saul inquired his parentage, and took him finally to his court. Jonathan was inspired by the romantic friendship which bound the two youths together to

the end of their lives. The triumphant songs of the Israelitish women announced that they felt that in him Israel had now found a deliverer mightier even than Saul; and in those songs, and in the fame which David thus acquired, was laid the foundation of that unhappy jealousy of Saul towards him which, mingling with the king's constitutional malady, poisoned his whole later relations to David. Three new qualities now began to develop themselves in David's character. The first was his prudence. It had already been glanced at on the first mention of him to Saul (1 Sam. xvi, 18), as "prudent in matters;" but it was the marked feature of the beginning of his public career. Thrice over it is emphatically said, "he behaved himself wisely," and evidently with the meaning that it was the wisdom called forth by the necessities of his delicate and difficult situation. It was that peculiar Jewish caution which has been compared to the sagacity of a hunted animal, such as is remarked in Jacob, and afterwards in the persecuted Israelites of the Middle Ages. One instance of it appears immediately, in his answer to the trap laid for him by Saul's servants, "Seemeth it to you a light thing to be the king's son-in-law, seeing that I am a poor man and lightly esteemed?" (xviii, 23). Secondly, we now see his magnanimous forbearance called forth, in the first instance, towards Saul, but displaying itself (with a few painful exceptions) in the rest of his life. He is the first example of the virtue of chivalry. Thirdly, his hairbreadth escapes, continued through so many years, impressed upon him a sense of dependence on the Divine help, clearly derived from this epoch. His usual oath or asseveration in later times was, "As the Lord liveth who hath redeemed my soul out of adversity" (2 Sam. iv, 9; 1 Kings i, 29); and the Psalms are filled with imagery taken even literally from shelter against pursuers, slipping down precipices (Psa. xviii, 36), hiding-places in rocks and caves, leafy coverts (xxxiii, 20), strong fastnesses (xviii, 2). This part of David's life may be subdivided into four portions:

1. *His Life at the Court of Saul till his final Escape* (1 Sam. xviii, 2-xix, 18).—His office is not exactly defined. But it would seem that, having been first armor-bearer (xvi, 21; xviii, 2), then made captain over a thousand—the subdivision of a tribe—(xviii, 18), he finally, on his marriage with Michal, the king's second daughter, was raised to the high office of captain of the king's body-guard, second only, if not equal, to Abner, the captain of the host, and Jonathan, the heir apparent. These three formed the usual companions of the king at his meals (xx, 25). David was now chiefly known for his successful exploits against the Philistines, by one of which he won his wife, and drove back the Philistine power with a blow from which it only rallied at the disastrous close of Saul's reign. He also still performed from time to time the office of minstrel. But the successive snares laid by Saul to entrap him, and the open violence into which the king's madness twice broke out, at last convinced him that his life was no longer safe. He had two faithful allies, however, in the court—the son of Saul, his friend Jonathan—the daughter of Saul, his wife Michal. Warned by the one and assisted by the other, he escaped by night, and was from that time forward a fugitive. B.C. 1062. Jonathan he never saw again except by stealth. Michal was given in marriage to another (Phaltiel), and he saw her no more till long after her father's death. See MICHAL. To this escape the traditional title assigns Psa. lix. Internal evidence (according to Ewald) gives Psa. vi and vii to this period. In the former he is first beginning to contemplate the necessity of flight; in the latter he is moved by the plots of a person not named in the history (perhaps those alluded to in 1 Chron. xii, 17)—according to the title of the psalm, Cush, a Benjamite, and therefore of Saul's tribe. See CUSH, 2.

2. *His Escape* (1 Sam. xix, 18-xxi, 15).—He first

fled to Naloth (or the pastures) of Ramah, to Samuel. This is the first recorded occasion of his meeting with Samuel since the original interview during his childhood at Bethlehem. It might almost seem as if he had intended to devote himself with his musical and poetical gifts to the prophetic office, and give up his cares and dangers of public life. But he had a higher destiny still. Up to this time both the king and himself had thought that a reunion was possible (as in 5, 26). But the madness of Saul now became as settled and ferocious in character, and David's danger proportionately greater. The secret interview with Jonathan, of which the recollection was probably handed down through Jonathan's descendants when he came to David's court, confirmed the alarm already excited by Saul's endeavor to seize him at Ramah; and he now determined to leave his country, and take refuge, like Coriolanus, or Themistocles in like circumstances, in the court of his enemy. Before this he resolved he visited Nob (q. v.), the seat of the tabernacle (1 Sam. xxi), partly to obtain a final interview with the high-priest Ahimelech (1 Sam. xxii, 9, 10), partly to procure food and weapons. On the pretext of a secret mission from Saul, he obtained from Ahimelech some of the sacred loaves of shew-bread (q. v.) and the consecrated sword of Goliath, of which he said, "There is none like that; give it me." The incident was of double importance in David's career. First, it established a connection between him and the only survivor of the massacre in which David's life it involved the house of Ahimelech. Secondly, from Ahimelech's surrender of the sacred bread to David's hunger (see Oslander, *De Davide panes propositionis recipiente*, Tabing, 1751) our Lord drew the interest of the superiority of the moral to the ceremonial law, which is the only allusion made to David's life in the N. T. (Matt. xii, 3; Mark ii, 25; Luke vi, 4, 5). It is also commemorated by the traditional title of Ps. liii. His hospitable reception, when in distress, by Ahimelech the priest, and the atrocious massacre incessantly brought by him on Nob, the city of the priests (1 Sam. xxi and xxii, 9-19), must have deeply affected his generous nature, and laid the foundation of his cordial affection for the whole priestly order, whose ministrations he himself helped to elevate by his devotional melodies. See AHIMELECH, 1.

His stay at the court of Achish (q. v.) was short. Discovered possibly by "the sword of Goliath," his presence revived the national enmity of the Philistines against their former conqueror; and he only escaped by feigning madness, by violent gestures, playing on the gates of the city, or on a drum or cymbal, letting his beard grow, and foaming at the mouth (1 Sam. xxi, 18, Sept.). (See Ortlieb, *De Davide dicitur*, Lips. 1706; Hebenstreit, *De Dav. furorem simulacrum*, Vit. 1711; Krafft, *De Dav. in aula Gethsemani*, Erlang. 1768.) The 56th and 84th Psalms are both referred by their titles to this event, and the titles state (what does not appear in the narrative) that he had been seized as a prisoner by the Philistines, and that he was, in consequence of this stratagem, set free by Achish, or (as he is twice called) Abimelech. See ACHISH, 1.

3. *His Life as an independent Outlaw* (xxii, 1-xxiii, 25).—(1.) His first retreat was the cave of Adullam, probably the large cavern (the only very large one in Palestine), not far from Bethlehem, now called Kbr-reitûn (see Bonar's *Land of Promise*, p. 244). From its vicinity to Bethlehem, he was joined there by his whole family, now feeling themselves in danger from Saul's fury (xxii, 1). This was probably the foundation of his intimate connection with his nephews, the sons of Zeruiah. B.C. 1061. Of these, Abishai, with two other companions, was among the earliest (1 Chron. xi, 15, 20; 1 Sam. xxvi, 6; 2 Sam. xxiii, 18, 18). Besides these were outlaws and debtors from every part, including, doubtless, some of the original

sanites, of whom the name of one, at least, has a preserved, Ahimelech the Hittite (1 Sam. xxvi, See ADULLAM.

2.) His next move was to a stronghold, either the untain afterwards called Herodium, close to Adullam, or the fastness called by Josephus (*Wars*, vii, 8, Masada, the Græcised form of the Hebrew word *ʿadah* (1 Sam. xxii, 4, 5; 1 Chron. xii, 16), in the neighborhood of En-gedi. While there, he had deeded his aged parents, for the sake of greater security, beyond the Jordan, with their ancestral kinsman Moab (ib. 8). The neighboring king, Nabash of mon, also treated him kindly (2 Sam. x, 2). Here another companion appears for the first time, a school-boy, if we may use the word, from the schools of nuel, the prophet Gad, his subsequent biographer Sam. xxii, 5; and while he was there occurred the valurous exploit of the three heroes just mentioned procure water from the well of Bethlehem, and David's chivalrous answer, like that of Alexander in the ert of Gedrosia (1 Chron. xi, 16-19; 2 Sam. xxiii, 17). He was joined here by two separate bands: a little body of eleven fierce Gadite mountaineers, o swam the Jordan in flood-time to reach him (1 ron. xii, 8); the other, a detachment of men from dah and Benjamin, under his nephew Amasai, who neceforth attached himself to David's fortunes (1 ron. xii, 16-18).

(3.) At the warning of Gad, he fled next to the forest Hareth (somewhere in the hills of Judah), and then ain fell in with the Philistines, and again, apparent- advised by Gad (xxiii, 4), made a descent on their raging parties, and relieved Keilah (q. v.), in which took up his abode. While there, now for the first ne in a fortified town of his own (xxiii, 7), he was ined by a new and most important ally—Abiathar, e last survivor of the house of Ithamar, who came ith the high-priest's ephod, and henceforth gave the acles, which David had hitherto received from Gad xiii, 6, 9; xxii, 28). By this time the 400 who had ined him at Adullam (xxii, 2) had swelled to 600 xiii, 18).

(4.) The situation of David was now changed by the pearance of Saul himself on the scene. Apparently e danger was too great for the little army to keep gether. They escaped from Keilah, and dispersed, whithersoever they could go," among the fastnesses f Judah. Henceforth it becomes difficult to follow e movements with exactness, partly from ignorance f the localities, partly because the same event seems o be twice narrated (1 Sam. xxiii, 19-24; xxvi, 1-4, nd perhaps 1 Sam. xxiv, 1-22; xxvi, 5-25). But thus uch we discern. He is in the wilderness of Ziph. nce (or twice) the Ziphites betray his movements to Saul, who literally hunts him like a partridge; the reacherous Ziphites beating the bushes before him, nd 3000 men being stationed by Saul to catch even he print of his footsteps on the hills (1 Sam. xxiii, 14, 2 [Heb.], 24 [Sept.]; xxiv, 11; xxvi, 2, 20). David inds himself driven to the extreme south of Judah, in he wilderness of Maon. On two, if not three occa- sions, the pursuer and pursued catch sight of each other. Of the first of these escapes, the memory was ong preserved in the name of the "Cliff of Divisions," given to the cliff down one side of which David climbed, while Saul was surrounding the hill on the other side (xxiii, 25-29), when he was suddenly called away by the cry of a Philistine invasion. On another occasion David took refuge in a cave "by the spring of the wild goats" (En-gedi), immediately above the Dead Sea (1 Sam. xxiv, 1, 2). The rocks were covered with the pursuers. Saul entered, as is the cus- tom in Oriental countries, for a natural necessity. The followers of David, seated in the dark recesses of the cave, seeing, yet not seen, suggest to him the chance thus thrown in their way. David, with a characteristic mixture of humor and generosity, de-

scends and silently cuts off the skirt of the long robe spread, as is usual in the East on such occasions, be- fore and behind the person so occupied—and then en- sued the pathetic scene of remonstrance and forgive- ness (xxiv, 8-22). The third was in the wilderness further south. There was a regular camp, formed with its usual fortification of wagon and baggage. Into this inclosure David penetrated by night, and carried off the cruse of water, and the well-known royal spear of Saul, which twice had so nearly trans- fixed him to the wall in former days (xxvi, 7, 11, 22). The same scene is repeated as at En-gedi—and this is the last interview between Saul and David (xxvi, 26). B.C. 1055. David had already parted with Jonathan in the forest of Ziph (xxiii, 18).

To this period are annexed by their traditional titles Psalm liv ("When the Ziphim came and said, Doth not David hide himself with us?"); lvii ("When he fled from Saul in the cave," though this may refer also to Adullam); lxiii, "When he was in the wilderness of Judah" (or Idumæa, Sept.); cxlii ("A prayer when he was in the cave").

While he was in the wilderness of Maon occurred David's adventure with Nabal (q. v.), instructive as showing his mode of carrying on the freebooter's life, and his marriage with Abigail. His marriage with Ahinoam from Jezreel, also in the same neighborhood (Josh. xv, 56), seems to have taken place a short time before (1 Sam. xxv, 43; xxvii, 8; 2 Sam. iii, 2).

4. *His Service under Achish* (1 Sam. xxvii, 1; 2 Sam. i, 27).—Wearied with his wandering life, he at last crosses the Philistine frontier, not, as before, as a fugitive, but the chief of a powerful band—his 600 men now grown into an organized force, with their wives and families around them (xxvii, 8-4). After the manner of Eastern potentates, Achish gave him for his support a city—Ziklag, on the frontier of Philistia—and it was long remembered that to this curious arrangement the kings of Judah owed this part of their possessions (xxvii, 6). Here we meet with the first note of time in David's life. He was settled there for a year and four months (xxvii, 7), and his increasing importance is indicated by the fact that a body of Benjamite archers and slingers, twenty-two of whom are specially named, joined him from the very tribe of his rival (1 Chron. xii, 1-7). Possibly during this stay he may have acquired the knowl- edge of military organization and weapons of war (1 Sam. xiii, 19-23), in which the Philistines surpassed the Israelites, and in which he surpassed all the pre- ceding rulers of Israel. During his outlawry, David had also become acquainted in turn not only with all the wild country in the land, but with the strongholds of the enemy all around. The celebrity acquired in successful guerilla warfare, even in modern days, turns many eyes on a chieftain; and in an age which regarded personal heroism as the first qualification of a general (1 Chron. xi, 6) and of a king, to triumph over the persecutions of Saul gave David the fairest prospects of a kingdom. That he was able to escape the malice of his enemy was due in part to the direct help given him by the nations around, who were glad to keep a thorn rankling in Saul's side; in part also to the indirect results of their invasions (1 Sam. xxiii, 27).

He deceived Achish into confidence by attacking the old nomadic inhabitants of the desert frontier, and representing the plunder to be of portions of the south- ern tribes or the nomadic allied tribes of Israel. But this confidence was not shared by the Philistine nobles, and accordingly David was sent back by Achish from the last victorious campaign against Saul. In this manner David escaped the difficulty of being present at the battle of Gilboa, but found that during his absence the Bedouin Amalekites, whom he had plundered during the previous year, had made a descent upon Ziklag, burnt it to the ground, and carried off

the wives and children of the new settlement. A wild scene of frantic grief and recrimination ensued between David and his followers. It was calmed by an oracle of assurance from Abiathar. It happened that an important accession had just been made to David's force. On his march with the Philistines northward to Gilboa, he had been joined by some chiefs of the Manassites, through whose territory he was passing. Urgent as must have been the need for them at home, yet David's fascination carried them off, and they now assisted him against the plunderers (1 Chron. xii, 19-21). They overtook the invaders in the desert, and recovered the spoil. These were the gifts with which David was now able for the first time to requite the friendly inhabitants of the scene of his wanderings (1 Sam. xxx, 26-31). A more lasting memorial was the law which traced its origin to the arrangement made by him, formerly in the attack on Nabal, but now again, more completely, for the equal division of the plunder among the two thirds who followed to the field, and the one third who remained to guard the baggage (1 Sam. xxx, 25; xxv, 13). Two days after this victory a Bedouin arrived from the north with the fatal news of the defeat of Gilboa. The reception of the tidings of the death of his rival and of his friend, the solemn mourning, the vent of his indignation against the bearer of the message, the pathetic lamentation that followed, well close the second period of David's life (2 Sam. i, 1-27). B.C. 1058.

III. *David's Reign.*—(I.) *As King of Judah at Hebron*, 7½ years (2 Sam. ii, 1-v, 5).—Hebron was selected, doubtless, because it was the ancient sacred city of the tribe of Judah, the burial-place of the patriarchs and the inheritance of Caleb. Here David was first formally anointed king—by whom it is not stated; but the expression seems to limit the inauguration to the tribe of Judah, and therefore to exclude any intervention of Abiathar (2 Sam. ii, 4). To Judah his dominion was nominally confined. But probably for the first five years of the time the dominion of the house of Saul, whose seat was now at Mahanaim, did not extend to the west of the Jordan, and consequently David would be the only Israelite potentate among the western tribes. He then strengthened himself by a marriage with Maacah, daughter of Talmai, king of Geshur (2 Sam. iii, 3), a petty monarch whose dominions were near the sources of the Jordan, and whose influence at the opposite end of the land must have added a great weight into David's scale. From Abigail, widow of the churlish Nabal, David seems to have received a large private fortune. Concerning his other wives we know nothing in particular, only it is mentioned that he had six sons by six different mothers in Hebron. The chief jealousy was between the two tribes of Benjamin and Judah, as Saul had belonged to the former; and a tournament was turned by mutual ill-will into a battle, in which Abner unwillingly slew young Asahel, brother of Joab. "Long war," after this, was carried on between "the house of Saul and the house of David." We may infer that the rest of Israel took little part in the contest; and although the nominal possession of the kingdom enabled the little tribe of Benjamin to struggle for some time against Judah, the skill and age of Abner could not prevail against the vigor and popular fame of David. Gradually David's power increased, and during the two years which followed the elevation of Ishbosheth, a series of skirmishes took place between the two kingdoms. First came a successful inroad into the territory of Ishbosheth (2 Sam. ii, 28). Next occurred the defection of Abner (2 Sam. iii, 12). A quarrel between Abner and Ishbosheth decided the former to bring the kingdom over to David (see Ortlob, *De pacto Davidis et Abneri*, Lips. 1709). The latter refused to treat unless, as a preliminary proof of Abner's sincerity, Michal, daughter of Saul, was restored to David. The possession of such a wife was valuable to one who was aspiring to

the kingdom; and although David had now several wives, he appears not to have lost his affection for his earliest bride. She, too, seems to have acceded in his claim as being greater than that of the man to whom her father had arbitrarily bestowed her, with sincere kindness of her new husband had probably effaced her former attachment to David, although afterwards find her betrayed into an unworthy and her pride of position. After giving her back, he proceeded to win the elders of Israel over to him, but Joab discerned that if this should be so brass about, Abner of necessity would displace him from a post of chief captain. He therefore seized the opportunity of murdering him when he had come on a peaceful embassy, and covered the atrocity by pleading a duty of revenging his brother's blood. This decision perhaps David's first taste of the miseries of royal power. He dared not proceed actively against his ruthless nephew, but he vented his abhorrence in a solemn curse on Joab and his posterity, and followed him to the grave with weeping. See ABNER. ANXIOUS to purge himself of the guilt, he ordered a public wearing of sackcloth, and refused to touch food all the day. His sincere expressions of grief won the heart of Israel. The feeble Ishbosheth (q. v.) left alone and unequal to the government, and shortly suffered the same fate of assassination. David, following the universal policy of sovereigns (Tacit. *Hist.* i, 44), and his own profound sense of the sacredness of royalty, took vengeance on the murderers, and buried Ishbosheth in Abner's tomb at Hebron. During this period, it is stated against what people his marauding excursions were directed. It is distinctly alleged (2 Sam. iii, 2) that his men brought in a great spoil at the very time at which he had a truce with Abner; possibly it may have been won from his old enemies the Amalekites (1 Sam. xxx). The throne, so long waiting for him, was now vacant, and the united voice of the whole people at once called him to occupy it. B.C. 1046. A solemn league was made between him and his people (1 Sam. v, 8). For the third time David was anointed king, and a festival of three days celebrated the joyful event (1 Chron. xii, 39). His little band had now swelled into "a great host, like the host of God" (1 Chron. xii, 22). The command of it, which had formerly rested on David alone, he now devolved on his nephew Joab (2 Sam. ii, 28). It was formed by contingents from every tribe of Israel. Two are specially mentioned as bringing a weight of authority above the others. The sons of Issachar had "understanding of the times to know what Israel ought to do," and with the adjacent tribes contributed to the common feast the peculiar products of their rich territory (1 Chron. xii, 32, 40). The Levitical tribe, formerly represented in David's being followed only by the solitary fugitive Abiathar, now came in strength, represented by the head of the rival branch of Eleazar, the high-priest the aged Jehoiada and his youthful and warlike kinsman Zadok (1 Chron. xii, 27, 28; xxvii, 5). The kingdom was not at first a despotic, but a constitutional one; for it is stated, "David made a league with the elders of Israel in Hebron before Jehovah; and they anointed David king over Israel" (2 Sam. v, 3). This is marked out as the era which determined the Philistines to hostility (ver. 17), and may confirm our idea that their policy was to hinder Israel from becoming united under a single king.

Underneath this show of outward prosperity, the cankers, incident to the royal state which David now assumed, had first made themselves apparent at Hebron, and affected all the rest of his career. The first was the formation of a harem, according to the usage of Oriental kings. To the two wives of his wandering life he had now added four, and including Michal five (2 Sam. ii, 2; iii, 2-5, 15). The second was the increasing power of his kinsmen and chief officers, which the king strove to restrain within the limits

ight; and thus, of all the incidents of this part of career, the most plaintive and characteristic is his entation over his powerlessness to prevent the murder of Abner (2 Sam. iii, 31-36).

II.) *Reign over all Israel*, 83 years (2 Sam. v, 5, to 1 Kgs ii, 11).—The reign of David is the great critical in the history of the Hebrews. It decided that y were to have for nearly five centuries a national narchy, a fixed line of priesthood, and a solemn gious worship by music and psalms of exquisite uty; it finally separated Israel from the surround- heathen, and gave room for producing those noble numents of sacred writ, to the influence of which r the whole world no end can be seen. His prede- sor, Saul, had many successes against the Philis- es, but it is clear that he made little impression on ir real power; for he died fighting against them, on their own border, but at the opposite side of his gdom, in Mount Gilboa. As for all the other "en- ies on every side"—Moabites, Ammonites, Edoms, and the kings of Zobah—however much he may ve "vexed them" (1 Sam. xiv, 47), they, as well as e Amalekites, remained unsubdued, if weakened. e real work of establishing Israel as lord over the ole soil of Canaan was left for David.

1. *The Foundation of Jerusalem*.—It must have been th no ordinary interest that the surrounding nations tched for the prey on which the Lion of Judah, now out to issue from his native lair, and establish him- lf in a new home, would make his first spring. One stness alone in the centre of the land had hitherto sified the arms of Israel. On this, with a singular escience, perceiving that so southerly a position as ebron was no longer suitable, David fixed as his fu- re capital. By one sudden assault Jebus was taken, id became henceforth known by the names (whether rne by it before or not we cannot tell) of Jerusalem id Zion. B.C. 1044. See JERUSALEM. Of all the ties of Palestine great in former ages, Jerusalem one has vindicated by its long permanence the choice f its founder. The importance of the capture was arked at the time. The reward bestowed on the ccessful scaler of the precipice was the highest place i the army. Joab henceforward became captain of e host (1 Chron. xi, 6). The royal residence was stantly fixed there, fortifications were added by the ing and by Joab, and it was known by the special ame of the "city of David" (1 Chron. xi, 7; 2 Sam. , 9).

In the account of this siege, some have imagined he Chronicles to contradict the book of Samuel, but here is no real incompatibility in the two narratives. oab was, it is true, *already* David's chief captain; ut David was heartily disgusted with him, and may ave sought a pretence for superseding him by offer- ng the post to the man who should first scale the vall. Joab would be animated by the desire to retain is office, at least as keenly as others by the desire to et it; and it is credible that he may actually have een the successful hero of that siege also. If this was the case, it will further explain why David, even n the fulness of power, made no further effort to expel him until he had slaughtered Absalom.

The neighboring nations were partly enraged and partly awestruck. The Philistines had already made two ineffectual attacks on the new king (2 Sam. v, 17-20), both near the valley of Rephaim; and these were probably the first battles fought by David after becoming king of all Israel. A retribution on their former victories now took place by the capture and conflagration of their own idols (1 Chron. xiv, 12). Tyre, now for the first time appearing in the sacred history, allied herself with Israel; and Hiram sent cedarwood for the buildings of the new capital (2 Sam. v, 11), especially for the palace of David himself (2 Sam. vii, 2). That the mechanical arts should have been in a very low state among the Israelites was to be expect-

ed, since, before the reign of Saul, even smiths' forges were not allowed among them by the Philistines. Nothing, however, could be more profitable for the Phœnicians than the security of cultivation enjoyed by the Israelites in the reigns of David and Solomon. The trade between Tyre and Israel became at once extremely lucrative to both, and the league between the two states was quickly very intimate. Unhallowed and profane as Jebus had been before, it was at once elevated to a sanctity which it has never lost, above any of the ancient sanctuaries of the land. The ark was now removed from its obscurity at Kirjath-jearim with marked solemnity, B.C. 1048. A temporary halt (owing to the death of Uzzah) detained it at Obed-edom's house, after which it again moved forward with great state to Jerusalem. An assembly of the nation was convened, and (according to 1 Chron. xiii, 2; xv, 2-27) especially of the Levites. The musical arts, in which David himself excelled, were now developed on a great scale (1 Chron. xv, 16-22; 2 Sam. vi, 5). Zadok and Abiathar, the representatives of the two Aaronic families, were both present (1 Chron. xv, 11). Chenaniah presided over the music (1 Chron. xv, 22, 27). Obed-edom followed his sacred charge (1 Chron. xiii, 18, 21, 24). The prophet Nathan appears for the first time as the controlling adviser of the future (2 Sam. vii, 8). A sacrifice was offered as soon as a successful start was made (1 Chron. xv, 26; 2 Sam. vi, 18). David himself was dressed in the white linen dress of the priestly order, without his royal robes, and played on stringed instruments (1 Chron. xv, 27; 2 Sam. vi, 14, 20). As in the prophetic schools where he had himself been brought up (1 Sam. x, 5), and as still in the impressive ceremonial of some Eastern dervishes, and of Seville cathedral (probably derived from the East), a wild dance was part of the religious solemnity. Into this David threw himself with unreserved enthusiasm, and thus conveyed the symbol of the presence of Jehovah into the ancient heathen fortress (see J. E. Müller, *De Davide omne arcam saltante*, in Ugolini *Theas.* xxxii). See DANCE. In the same spirit of uniting the sacerdotal with the royal functions, he offered sacrifices on a large scale, and himself gave the benediction to the people (2 Sam. vi, 17, 18; 1 Chron. xvi, 2). The scene of this inauguration was on the hill which, from David's habitation, was specially known as the "City of David." As if to mark the new era, he had not brought the ancient tabernacle from Gibeon, but had erected a new tent or tabernacle (1 Chron. xv, 1) for the reception of the ark. It was the first beginning of the great design, of which we will speak presently, afterwards carried out by his son, of erecting a permanent temple or palace for the ark, corresponding to the state in which he himself was to dwell. It was the greatest day of David's life. One incident only tarnished its splendor—the reproach of Michal, his wife, as he was finally entering his own palace, to carry to his own household the benediction which he had already pronounced on his people. See MICHAL. His act of severity towards her was an additional mark of the stress which he himself laid on the solemnity (2 Sam. vi, 20-23; 1 Chron. xv, 29).

A large number of psalms, either in their traditional titles, or in the irresistible evidence of their contents, bear traces of this great festival, besides those which may be referred either to this occasion, or to the dedication of Solomon's Temple, or even to the restoration of the sacred services on the return from Babylon. The 15th, 101st, and 118th, by their contents, express the feelings of David on his occupation of his new home. The 68th, at least in part, and the 24th, seem to have been actually composed for the entrance of the ark into the ancient gates of the heathen fortress—and the last words of the second of these two psalms may be regarded as the inauguration of the new name by which God henceforth is called, The Lord of hosts.

"Who is this king of glory?" "The Lord of hosts, he is the king of glory" (Psa. xxiv, 10; comp. 2 Sam. vi, 2). Fragments of poetry worked up into psalms (xcvi, 2-18; cv, 1, 47, 48) occur in 1 Chron. xvi, 8-36, as having been delivered by David "into the hands of Asaph and his brother" after the close of the festival. See PSALMS.

The priests or Aaronites must, for a long time, have had little occupation in their sacred office; for the ark was at Kirjath-jearim, under the care of a private family. Indeed, during the reign of Saul, we find shewbread to have been set forth at Nob (1 Sam. xxi, 4-6) by Ahimelech the priest; and it is possible that many other ceremonies were performed by them, in spite of the absence of the ark. But after the dreadful massacre perpetrated on the priestly order by Saul, few Aaronites are likely to have felt at ease in their vocation. To wear an ephod—the mark of a priest who is asking counsel of Jehovah—had almost become a crime; and even after the death of Saul, it is possible that the Aaronites, like the other Israelites, remained organized as bands of soldiers. At least Jehoiada (who, according to 1 Chron. xxvii, 5, was high-priest at this time, and joined David at Hebron with 8700 Aaronites) was father of the celebrated warrior Benaiah, afterwards captain of David's body-guard—a man whose qualities were anything but priest-like; and Zadok, afterwards high-priest, who joined David "with twenty-two captains of his father's house" at the same time as Jehoiada, is described as "a young man mighty of valor" (1 Chron. xii, 27, 28). How long Jehoiada retained the place of high-priest is uncertain. It is probable that no definite conception then existed of the need of having one high-priest; and it is certain that David's affection for Abiathar, because of his father's fate, maintained him in chief place through the greater part of his reign. Not until a later time, it would seem, was Zadok elevated to a co-ordinate position. See ABIATHAR. Any further remarks concerning the orders and courses of the priests will be better reserved for the article on that subject. It is enough here to add that the cruel slaughter ordered by Saul of the Aaronites of the line of Ithamar, whom Abiathar now represented, naturally gave a great preponderance of numbers and power to the line of Eleazar, to which Zadok belonged. We must also refer to the article LEVITES for further information concerning them. The bringing of the ark from Kirjath-jearim to Jerusalem established the line of high-priests in direct service before it; and from this time we may presume that the ceremonies of the great day of atonement began to be observed. Previously, it would appear, the connection between the priesthood and the tabernacle had been very loose. The priests fixed their abode at Nob, when the ark was at Kirjath-jearim, a very short distance; yet there is nothing to denote that they at all interfered with Abinadab in his exclusive care of the sacred deposit.

After this event, the king, contrasting his cedar palace with the curtains of the tabernacle, was desirous of building a temple for the ark; such a step, moreover, was likely to prevent any future change of its abode. This design, when imparted to the prophet Nathan, was received by him with warm encouragement. He had to learn, however, that the seemingly obvious fitness of a public measure did not excuse a prophet from the obligation of consulting the Lord before he ventured to utter an authoritative opinion; for the next day he had to return to the king with an intimation that he must abandon the intention of executing this great undertaking. The design is indeed commended; yet as he had been a warrior from his youth, and had shed much human blood, he was pronounced unfit for this sacred work, which was therefore to be reserved for the peaceful reign of his successor. Encouraged by the divine approbation, and by the high promises which were on this occasion

given to him, David henceforth made it one of the great objects of his reign to gather means and materials for this important undertaking, the credit of which he is fairly entitled to divide with his son, by whom it was actually executed. See SOLOMON.

Great as might appear the advantage of establishing the same city as the religious and civil metropolis, the effect was, in one respect, most unfortunate; it alienated the powerful and central tribe of Ephraim. They had been accustomed to regard Shiloh as the rightful abode of the ark. Against Kirjath-jearim no effort was felt, especially while the ark and its priests were in obscurity; but when so much honor attended it when it became a peculiar glory to Judah and Benjamin—tribes already too much favored; when a magnificent edifice was erected to receive it, the seeds were sown of that disaffection which ended in a seceding of the tribes apart. Nor was the argument unreasonable that a more central spot was needed for them to assemble at year by year.

2. *Foundation of the Court and Empire of Israel* (1 Sam. viii to xii).—The erection of the new capital Jerusalem introduces us to a new era in David's reign and in the history of the monarchy. Up to this time he had been a king, such as Saul had been before him, or as the kings of the neighboring tribes, each ruling over his territory, unconcerned with any foreign relations except so far as was necessary to defend his own nation. But David, and through him the Israelite monarchy, now took a wider range. He became a king on the scale of the great Oriental sovereigns of Egypt and Persia, with a regular administration and organization of court and camp; and he also founded an imperial dominion which for the first time raised the prophetic description of the bounds of the chosen people (Gen. xv, 18-21). The internal organization now established lasted till the final overthrow of the monarchy. The empire was of much shorter duration, continuing only through the reigns of David and his successor Solomon. But, for the period of its existence, it lent a peculiar character to the sacrosanctity. For once, the kings of Israel were on a level with the great potentates of the world. David was an imperial conqueror, if not of the same magnitude yet of the same kind as Ramees or Cyrus. "I have made thee a great name like unto the name of the great men that are in the earth" (2 Sam. vii, 9). "Thou hast shed blood abundantly, and hast made great wars" (1 Chron. xxii, 8). And as, on the one hand, the external relations of life, and the great incidents of war and conquest receive an elevation by their contact with the religious history, so the religious history swells into larger and broader dimensions from its contact with the course of the outer world. The enlargement of territory, the amplification of power and state, leads to a corresponding enlargement and amplification of ideas, of imagery, of sympathies, and thus (humanly speaking) the magnificent forebodings of a wider dispensation in the prophetic writing first became possible through the court and empire of David.

a. In the internal organization of the kingdom the first new element that has to be considered is the royal family, the dynasty, of which David was the founder, a position which entitled him to the name of "Patriarch" (Acts ii, 29) and (ultimately) of the ancestor of the Messiah. Once settled in Jerusalem, David proceeded to increase the number of his wives, perhaps in part from the same political motive that attracts other Oriental monarchs, viz. in order to take hostages from the chieftains round in the least offensive mode. This explanation will not apply to the concubines. We know nothing further concerning David's family relations than the names of eleven sons born in Jerusalem (2 Sam. v, 14, 15), of whom four were children of Bathsheba (1 Chron. iii, 5), and therefore much younger than the elder sons.

(I.) *Wives of the Wanderings.*
(1 Sam. xxvii, 2; 1 Chron. iii, 1.)

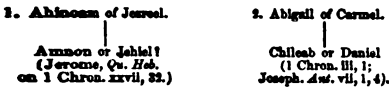

(II.) *Wives at Hebron.*

(2 Sam. iii, 2-4; 1 Chron. iii, 1-4.)

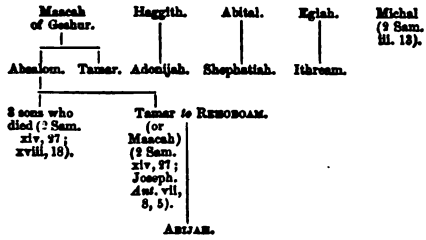

N.B.—There were, besides, 10 concubines (2 Sam. v, 13; xv, 16), whose children (1 Chron. iii, 9) are not named (but see Joseph. Ant. vii, 8, 3).

(III.) *Wives at Jerusalem.*

(2 Sam. v, 12-16; 1 Chron. iii, 5-8; xiv, 4-7.)

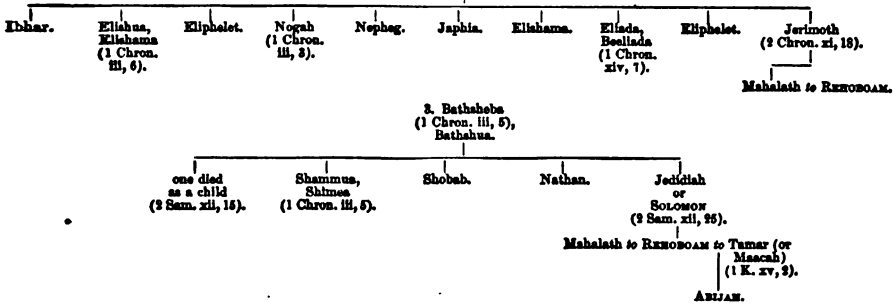

Of these, Absalom and Adonijah both inherited their father's beauty (2 Sam. xiv, 25; 1 Kings i, 6), but Solomon alone possessed any of his higher qualities. It was from a union of the children of Solomon and Absalom that the royal line was carried on (1 Kings xv, 2). The princes were under the charge of Jehiel (1 Chron. xxvii, 22), perhaps the Levite (1 Chron. xv, 21; 2 Chron. xx, 14), with the exception of Solomon, who (according at least to one rendering) was under the charge of Nathan (2 Sam. xii, 25). David's strong parental affection for all of them is very remarkable (2 Sam. xiii, 21, 28, 36; xiv, 28; xviii, 5, 23; xix, 4; 1 Kings i, 6).

b. The military organization, which was, in fact, inherited from Saul, but greatly developed by David, was as follows:

(1.) "The Host," i. e. the whole available military force of Israel, consisting of all males capable of bearing arms, and summoned only for war. This had always existed from the time of the first settlement in Canaan, and had been commanded by the chief or the judge who presided over Israel for the time. Under Saul we first find the recognised post of a captain or commander-in-chief in the person of Abner; and under David this post was given as a reward for the assault on Jerusalem to his nephew Joab (1 Chron. xi, 6; xxvii, 24), who conducted the army to battle in the absence of the king (2 Sam. xii, 26). There were 12 divisions of 24,000 each, who were held to be in duty month by month, and over each of them presided an officer selected for this purpose from the other military bodies formed by David (1 Chron. xxvii, 1-15). Besides this host, the register proceeds to recount twelve princes over the tribes of Israel, who may perhaps be compared to the governors of our own states in their military capacity. The enumeration of these great officers is remarkable, being as follows: 1, Of the Reubenites; 2, of the Simeonites; 3, of the Levites; 4, of the Aaronites; 5, of Judah; 6, of Issachar; 7, of Zebulon; 8, of Naphthali; 9, of Ephraim; 10, of Manasseh; 11, of Manasseh beyond the Jordan; 12, of Benjamin; 13, of Dan. Here the names of Gad and Asher are omitted without explanation. On the other hand, the Levites and Aaronites are recounted, as though they were tribes co-ordinate with the rest,

and Zadok is named as prince of the Aaronites. It is not to be supposed that the Levites or Aaronites were wholly shut out from civil and military duties. It has already been remarked that Zadok (here chief of the Aaronites) was described in the beginning of David's reign as "a mighty man of valor" (1 Chron. xii, 28), and the same appellation is given to the sons of Shemaiah, a Levite (xxvi, 6). Benaiah also, now captain of David's body-guard, was son of the late high-priest Jehoiada (xxvii, 5, and xii, 27). The army was still distinguished from those of surrounding nations by its primitive aspect of a force of infantry without cavalry. The only innovations as yet allowed were the introduction of a very limited number of chariots (2 Sam. viii, 4), and of mules for the princes and officers instead of asses (2 Sam. xiii, 29; xviii, 9). According to a Musulman tradition (*Koran*, xxi, 80), David invented chain armor. The usual weapons were still spears and shields, as appears from the Psalms. For the general question of the numbers and equipment of the army, see ARMS and ARMY.

(2.) The Body-guard. This also had existed in the court of Saul, and David himself had probably been its commanding officer (1 Sam. xxii, 14; Ewald). But it now assumed a peculiar organization. They were, at least in name, foreigners, as having been drawn from the Philistines, probably during David's residence at the court of Gath. They are usually called from this circumstance "Cherethites and Pelethites" (q. v.), but had also a body especially from Gath among them, of whom the name of one, Ittai, is preserved as a faithful servant of David (2 Sam. xv, 19). The captain of the force was, however, not only not a foreigner, but an Israelite of the highest distinction and purest descent, who first appears in this capacity, but who outlived David, and became the chief support of the throne of his son, namely, Benaiah, son of the chief priest Jehoiada, representative of the eldest branch of Aaron's house (2 Sam. viii, 18; xv, 18; xx, 23; 1 Kings i, 38, 44).

(3.) The most peculiar military institution in David's army was that which arose out of the peculiar circumstances of his early life. The nucleus of what afterwards became the only standing army in David's forces was the band of 600 men who had gathered

round him in his wanderings. The number of 600 was still preserved, with the name of *Gibborim*, "heroes" or "mighty men." It became yet further subdivided into three large bands of 200 each, and small bands of 20 each. The small bands were commanded by thirty officers, one for each band, who together formed "the thirty," and the three large bands by three officers, who together formed "the three," and the whole by one chief, "the captain of the mighty men" (2 Sam. xxiii, 8-39; 1 Chron. xi, 9-47). There seems to have been a second or alternate set to "the three," and in this grade, as well as among the subaltern "thirty," one is apparently named as outranking his colleagues. There is considerable difficulty in adjusting their relative position, and two or three names appear to have been omitted. The sixteen additional names given in 1 Chron. xi may be those of alternates to "the thirty." Of "the thirty," some few only are known to fame elsewhere. Asahel, David's nephew (1 Chron. xi, 26; 2 Sam. ii, 18); Elhanan, the victor of at least one Goliath (1 Chron. xi, 26; 2 Sam. xxi, 19); Joel, the brother or son (Sept.) of Nathan (1 Chron. xi, 88); Naharai, the armor-bearer of Joab (1 Chron. xi, 39; 2 Sam. xxiii, 37); Eliam, the son of Ahithophel (2 Sam. xxiii, 34); Ira, one of David's priests (1 Chron. xi, 40; 2 Sam. xxiii, 38; xx, 26); Uriah the Hittite (1 Chron. xi, 41; 2 Sam. xxiii, 39; xi, 8). See Hofmann, *Geschichte der Helden David's* (in his *Exeg. krit. Abhandlungen*, No. vi).

The following is a corrected and classified list of the noted warriors of David's veterans. See each name in its alphabetical place.

No.	Chief of all.	2 Sam. xxiii.	1 Chron. xi.	1 Chron. xvii.
1.	Jashobeam (son of Zabdiel), a descendant of Hachmon	8	11	2
<i>Principal Three.</i>				
2.	Eleazar (son of Dodo), a descendant of Ahoah	9	12	
3.	Shammah (son of Agee (Shage ?), of the mountains of Judah	11		
<i>Secondary Three.</i>				
5.	Abishai (son of Zeruiah), captain	18	20	
6.	Benaiah (son of Jehoiada)	30	23	5
<i>Subordinates Thirty.</i>				
(3.)	Ismalah of Gibeah, captain (1 Chron. xii, 4)			
9.	Asahel (brother of Joab)	24	26	7
10.	Elhanan (son of Dodo) of Bethlehem	"	"	"
11.	Shammah of Harod, of the lineage of Zarah [Elika of Harod]	25	27	8
12.	Helez of Palon, in Ephraim	26	"	10
13.	Ira (son of Ikkeah) of Tekoa	"	28	9
14.	Ablezer of Anathoth, in Benjamin	27	"	12
15.	Sibbecai, a descendant of Hushai, of the lineage of Zarah	"	29	11
16.	Zalmon, a descendant of Ahoah	28	"	"
17.	Maharai of Netophat, of the lineage of Zarah	"	30	13
18.	Heled (son of Beanah, of the lineage of Othniel) of Netophat	29	"	15
19.	Ithai (son of Ribai) of Gibeah, in Benjamin	"	31	"
20.	Benaiah of Pirathon, in Ephraim	30	"	14
21.	Hurai, of the valleys of Gashah	"	32	"
22.	Abiel of Beth-Arabah	31	"	"
23.	Azmaveth (son of Adiel) of Bahurim	"	33	25
24.	Eliabha of Shaalbin	32	"	"
25.	Jonathan (son of Shage) of the mountains of Judah, descendants of Jashen of Gizeh	"	34	"
26.	Ahiam (son of Sa-car) of Jashen of Gizeh	33	35	"
27.	Eliphelet (son of Ahsabel [Ur]) [Hepher] of Maachah	34	36	"
28.	Eliam [Ah]jah (son of Ahithophel) of Gilead (Pelon)	"	"	"
29.	Hezrai of Carmel	35	37	"
30.	Naaral (son of Ezbai) of Arab	"	"	"
31.	Joel [Igal] (brother [son] of Nathan) of Zobah	36	38	"
32.	Mibhar [Bani], a Hagarene (of the tribe of Gad)	"	"	"
33.	Zelek, an Ammonite	37	39	"
34.	Naharai (Joab's armor-bearer) of Beeroth	38	40	"
35.	Ira } descendants of Jethro	39	41	"
36.	Gareb }	"	"	"
37.	Uriah, a Hittite	39	41	"

No.	Supplementary Sixteen.	1 Chron. xvii.	1 Chron. xviii.
38.	Zabad (son of Aphlai)		
39.	Adina (son of Shiza), of the tribe of Reuben	3	
40.	Hanan (son of Maachah)	4	
41.	Jehoahaphat of Methen		
42.	Uzziah of Ashteroth	4	
43.	Shama } (sons of Hothan) of Aroer		
44.	Jehiel }		
45.	Jediel }	5	
46.	Joha }		
47.	Eliel of Mahavah	6	
48.	Jeribai } (sons of Elnaan)		
49.	Jehovah }		
50.	Ithmah, a Moabite	6	
51.	Eliel	7	
52.	Obed		
53.	Jasiel of Mesobaiah		

c. Side by side with this military organization were established social and moral institutions. Some were entirely for pastoral, agricultural, and financial purposes (1 Chron. xxvii, 25-31), others for judicial (1 Chron. xxvii, 29-32). Some few are named as consulting what would now be called the court or council of the king; the councillors, Ahithophel of Gilead, Jonathan the king's nephew (1 Chron. xxvii, 32), the companion or "friend" Hushai (1 Chron. xvii, 33; 2 Sam. xv, 37; xvi, 19); the scribe, Sheva, or Ishraiah, and at one time Jonathan (2 Sam. xx, 25; 1 Chron. xxvii, 32); Jehoahaphat, the recorder or historian (2 Sam. xx, 24); and Adoram the tax collector both of whom survived him (2 Sam. xx, 24; 1 Kings xii, 18; iv, 3, 6). The cabinet of David (if we use a modern name) is thus given (1 Chron. xxvii, 32-34) with reference to a time which preceded Absalom's revolt: 1, Jonathan, David's uncle, a counsellor, wise man, and scribe; 2, Jehiel, son of Hachmoni, tutor to the king's sons; 3, Ahithophel, the king's counsellor; 4, Hushai, the king's companion; 5, after Ahithophel, *Jehoiada, the son of Benaiah*; 6, Abiathar, priest. It is added, "and the general of the king's army was Joab."

Each tribe had its own head (1 Chron. xxvii, 16-25). Of these, the most remarkable were Elihu, David's brother (probably Eliab), prince of Judah (ver. 15) and Jaasiel, the son of Abner, of Benjamin (ver. 21). Twelve royal bailiffs are recited as a part of David's establishment (1 Chron. xxvii, 25, 31), having the following departments under their charge: 1, The treasures of gold, silver, etc.; 2, the magazines; 3, the tillage (wheat, etc.); 4, the vineyards; 5, the wine-cellar; 6, the olive and sycamore trees; 7, the oil-cellar; 8, the herds in Sharon; 9, the herds in the valleys; 10, the camels; 11, the asses; 12, the flock. The eminently prosperous state in which David led his kingdom to Solomon appears to prove that he was on the whole faithfully served, and that his own excellent intentions, patriotic spirit, and devout piety (measured, as it must be, by the standard of those ages), really made his reign beneficial to his subjects.

d. But the more peculiar of David's institutions were those directly bearing on religion. Two prophets appear as the king's constant advisers. Of these, Gad, who seems to have been the elder, had been David's companion in exile, and, from his being called "the seer," belongs probably to the earliest form of the prophetic schools. Nathan, who appears for the first time after the establishment of the kingdom at Jerusalem (2 Sam. vii, 2), is distinguished both by his title of "prophet," and by the nature of the prophecies which he utters (2 Sam. vii, 5-17; xii, 1-14), as of the purest type of prophetic dispensation, and as the hope of the new generation, which he supports in the person of Solomon (1 Kings i). Two high-priests—representatives of the two rival houses of Aaron (1 Chron. xvii, 8)—here again, as in the case of the two prophets, also appear: one, Abiathar, who attended him at Jerusalem, companion of his exile, and connected with the old time of the judges (1 Chron. xxvii, 34), joining him after the death of Saul, and becoming afterwards

support of his son; the other Zadok, who ministered at Gibeon (1 Chron. xvi, 89), and who was made the head of the Aaronic family (xxvii, 17). Besides these great religious functionaries, there were two classes of subordinates—prophets, specially instructed in singing and music, under Asaph, Heman, the grand-son of Samuel, and Jeduthun (1 Chron. xxv, 1-31); rites, or attendants on the sanctuary, who again were subdivided into the guardians of the gates and the guardians of the treasures (1 Chron. xxvi; i, 28) which had been accumulated, since the re-establishment of the sanctuary, by Samuel, Saul, Abner, Joab, and David himself (1 Chron. xxvi, 26-28).

The collection of those various ministers and representatives of worship round the capital must have given a new aspect to the history in David's time, such as had not borne under the disconnected period of the Judges. But the main peculiarity of the whole must have been that it so well harmonized with the character of him who was its centre. As his early martial career still placed him at the head of the military organization which had sprung up around him, so his early education and his natural disposition placed him at the head of his own religious institutions. Himself a prophet, a psalmist, he was one in heart with those whose advice he sought and whose arts he fostered. That was still more remarkable, though not himself a priest, he yet assumed almost all the functions usually ascribed to the priestly office. He wore, as we have seen, the priestly dress, offered the sacrifices, gave the priestly benediction (2 Sam. vi, 14, 17, 18); and, as if to include his whole court within the same sacerdotal sanctity, Benaiah, the captain of his guard, was a priest by descent (1 Chron. xxvii, 5), and joined in the sacred music (1 Chron. xvi, 6); David himself and "the captains of the host" arranged the prophetic duties (1 Chron. xxv, 1); and his sons are actually called "priests" (2 Sam. viii, 18; 1 Chron. xviii, 17, translated "chief," and ἀρχαῖοι, "chief rulers"), as well as Ira, of Manasseh (2 Sam. xii, 26, translated "chief ruler," but ἱερεὺς). Such a union was never seen before or since in the Jewish history. Even Solomon will be below it in some important points.

e. From the internal state of David's kingdom we pass to its external relations. David's further victories are narrated in the following order—Philistines, Moab, Zobah, Edom, Northern League stirred up by the Ammonites, Ammon (see Hase, *De regni David, et Salom. descriptio geogr. hist.*, Norimb. 1789, 1754). 1. The short and dry notice concerning the Philistines just gives us to understand that this is the era of their decisive, though not final subjugation. Their towns were despoiled of their wealth (2 Sam. viii, xii), and doubtless all their arms and munitions of war passed over into the service of the conqueror. 2. The Moabites were a pastoral people, whose general relations with Israel appear to have been peaceful. The slight notice of Saul's hostilities with them (1 Sam. xiv, 47) is the only breach recorded since the time of Eglon and Ehud. In the book of Ruth we see them as friendly neighbors, and much more recently (1 Sam. xxii, 8, 4) David committed his parents to the care of the king of Moab. We know no cause, except David's strength, which now drew his arms upon them. A people long accustomed to peace, in conflict with a veteran army, was struck down at once, but the fierceness of his triumph may surprise us. Two thirds of the population (if we rightly interpret the words, 2 Sam. viii, 2) were put to the sword; the rest became tributary. 3. Who are meant by the Syrians of Zobah is still a problem. See ZOBAB. We here follow the belief that it was a power of northern Syria, then aiming at extensive empire, which had not only defeated and humbled the king of Hamath, but had obtained homage beyond the Euphrates. The trans-Jordanic tribes in the time of Saul had founded a little empire for themselves by conquering their eastern neighbors,

the Hagarenes, and, perhaps, occasionally overran the district on the side of the Euphrates, which Hadadezer, king of Zobah, considered as his own. His efforts "to recover his border at the river Euphrates" first brought him into collision with David, perhaps by an attack which he made on the roaming Eastern tribes. David defeated not merely his army, but that of Damascus too, which came too late with succor, and put Israelitish garrisons into the towns of the Damascenes (see Michaelis, *Hist. bellorum Dav. c. rege Nesibeno*, in his *Commentat. Soc. Gott.* 1763, ii, 71 sq.). In this career of success, we see, for the first time in history, the uniform superiority over raw troops of a power which is always fighting; whose standing army is ever gaining experience and mutual confidence. 4. Another victory, gained "in the valley of salt," ought, perhaps, to be read, as in 1 Chron. xviii, 12, and in the superscription of Psa. lx, "over the Edomites," not "over the Syrians." The difference of the Hebrew textual letters is very slight, ארם and ארם. The verse which follows (2 Sam. viii, 14) seems to tell the result of this victory, viz. the complete subjugation and garrisoning of Edom, which, like Moab, was incorporated with David's empire. Immediately before this last conquest, as would appear, he wrote the 60th Psalm; and as that Psalm gives no hint of his achievements against the king of Zobah and the Damascenes, this is a strong ground for believing that those successes were not gained till somewhat later in time. 5. After David had become master of all Israel, of the Philistine towns, of Edom, and of Moab, while the Eastern tribes, having conquered the Hagarenes, threatened the Ammonites on the north, as did Moab on the south, the Ammonites were naturally alarmed, and called in the powers of Syria to their help against a foe who was growing dangerous even to them, and whom they had provoked by a gross insult (see Lakenmacher, *De barba legatis Dav. abrasa*, in his *Observat. Philol.* x, 145 sq.). The coalition against David is described as consisting of the Syrians of Bethrehob and of Maacah, of Zobah, and of Tob. The last country appears to have been in the district of Trachonitis, the first two immediately on the north of Israel. In this war we may believe that David enjoyed the important alliance of Toi, king of Hamath, who, having suffered from Hadadezer's hostility, courted the friendship of the Israelitish monarch (2 Sam. viii, 9, 10). We are barely informed that one division of the Israelites under Abishai was posted against the Ammonites; a second, under Joab, met the confederates from the north, 80,000 strong, and prevented their junction with the Ammonites. In both places the enemy was repelled, though, it would seem, with no decisive result. A second campaign, however, took place. The king of Zobah brought in an army of Mesopotamians, in addition to his former troops, and David found it necessary to make a levy of all Israel to meet the pressing danger. A pitched battle on a great scale was then fought at Helam—far beyond the limits of the twelve tribes—in which David was victorious. He is said to have slain, according to 2 Sam. x, 18; the men of 700 chariots, and 40,000 horsemen; or, according to 1 Chron. xix, 18, the men of 7000 chariots, and 40,000 footmen. If we had access to the court-records of Hamath, we should probably find that Toi had assembled his whole cavalry to assist David, and that to him was due the important service of disabling or destroying the enemy's horse. Such foreign aid may explain the general result, without our obtruding a miracle, for which the narrative gives us not the least warrant. The Syrians henceforth left the Ammonites to their fate, and the petty chiefs who had been in allegiance to Hadadezer hastened to do homage to David. 6. Early in the next season Joab was sent to take vengeance on the Ammonites in their own home by attacking their chief city, or Rabbah of Ammon. The

natural strength of their border could not keep out veteran troops and an experienced leader; and though the siege of the city occupied many months (if, indeed, it was not prolonged into the next year), it was at last taken. It is characteristic of Oriental despotism that Joab, when the city was nearly reduced, sent to invite David to command the final assault in person. David gathered a large force, easily captured the royal town, and despoiled it of all its wealth. His vengeance was as much more dreadful on the unfortunate inhabitants than formerly on the Moabites, as the danger in which the Ammonites had involved Israel had been more imminent. The persons captured in the city were put to death by torture; some of them being sawed in pieces, others chopped up with axes or mangled with harrows, while some were smothered in brick-kilns (2 Sam. xii, 31; 1 Chron. xx, 3). This severity was perhaps effectual in quelling future movements of revolt or war; for, until insurrections in Israel embolden them, foreign foes after this remain quiet. Others, however, understand that these prisoners of war were merely put to hard labor with the various instruments named. (See Danz, *De mitigata Davidis in Ammonitis crudelitate*, Jen. 1710; Nimptsch, *De Ammonitis a Dav. abeque crudelitate sub jugum missis*, Lips. 1781). The royal crown, or "crown of Milcom," was placed on David's head (2 Sam. xii, 30), and, according to Josephus (*Ant. vii, 5*), was always worn by him afterwards. The Hebrew tradition (Jerome, *Qu. Heb. ad 1 Chron. xx, 2*) represents it as having been the diadem of the Ammonite god Milcom, or Moloch; and that Ittai the Gittite (doing what no Israelite could have done, for fear of pollution) tore it from the idol's head and brought it to David. The general peace which followed was commemorated in the name of "the Peaceful" (Solomon), given to the son born to him at this crisis.

To these wars in general may be ascribed psalms ix and x. To the Edomitic war, both by its title and contents, must be ascribed psalm lx, 6-12 (cviii, 7-13), describing the assault on Petra. Psalm xviii (repeated in 2 Sam. xxii) is ascribed by its title, and appears from some expressions to belong to the day "when the Lord had delivered him out of the hand of all his enemies," as well as "out of the hand of Saul" (2 Sam. xxii, 1; Psa. xviii, 1). That "day" may be either at this time or at the end of his life. Psalms xx and xxi relate to the general union of religious and of military excellencies displayed at this time of his career. (Psalm xxi, 3, "Thou settest a crown of pure gold upon his head," not improbably refers to the golden crown of Ammon, 2 Sam. xii, 30.)

8. *David's subsequent History.*—Three great calamities may be selected as marking the beginning, middle, and close of David's otherwise prosperous reign, which appear to be intimated in the question of Gad (2 Sam. xxiv, 18), "a three years' famine, a three months' flight, or a three days' pestilence."

a. Of these, the first (the three years' famine) introduces us to the last notices of David's relations with the house of Saul. There has often arisen a painful suspicion in later times, as there seems to have been at the time (xvi, 7), that the oracle which gave as the cause of the famine Saul's massacre of the Gibeonites may have been connected with the desire to extinguish the last remains of the fallen dynasty. But such an explanation is not needed. The massacre was probably the most recent national crime that had left any deep impression; and the whole tenor of David's conduct towards Saul's family is of an opposite kind. It was then that he took the opportunity of removing the bodies of Saul and Jonathan to their own ancestral sepulchre at Zelah (2 Sam. xxi, 14); and it was then, or shortly before, that he gave a permanent home and restored all the property of the family to Mephibosheth, the only surviving son of Jonathan (2 Sam. ix, 1-13; xxi, 7). The seven who perished were two sons of Saul by Rizpah, and five grandsons

—sons of Michal and Adriel (2 Sam. xxi, 8), as read in the common Hebrew and Greek text, and in our received version; and Josephus imagines that they were born of her after a second divorce from David. It is certain, from 1 Sam. xviii, 19, that Michal's is a mistake for *Merab*, which name De Wette has introduced into his version. The description of the bereaved mother, Rizpah, the daughter of Aiah, who took her station upon the rock, and watched the bodies of her sons day and night, lest they should be devoured by beasts of prey or torn by the birds of the air, is deeply affecting. It touched the heart of David when he heard of it. He would not allow public decency to be any further offended to satisfy the resentment of the Gibeonites, but directed the bodies to be laid down and honorably deposited in the family sepulchre.

b. The second group of incidents contains the tragedy of David's life, which grew in all its parts out of the polygamy, with its evil consequences, into which he had plunged on becoming king. (L.) Undeveloped the splendor of his last glorious campaign against the Ammonites was a dark story, known probably at this time only to a very few, and even in later times kept as much as possible out of the view of the people. It is now recognised as one of the most instructive portions of his career—the double crime of adultery with Bathsheba, and of the virtual murder of Uriah. B.C. 1034. The crimes are undoubtedly those of a common Oriental despot. But the rebuke of Nathan, the sensible revival of the king's conscience, his grief for the sickness of the child, the gathering of his uncles and other brothers around him, his return of hope and peace, are characteristic of David, and of David only. If we add to these the two psalms, the 32d and the 51st, of which the first by its acknowledged internal evidence, the second by its title, also claim to belong to this crisis of David's life, we shall feel that the instruction drawn from the sin has more than compensated to us at least for the scandal occasioned by it. (See Bebel, *David peccans et poenitens*, Argent. 1703.) Be- though the "free spirit" and "clean heart" of David returned, and although the birth of Solomon was as auspicious as if nothing had occurred to trouble the victorious festival which succeeded it, the clouds from this time gathered over David's fortunes, and bore forward "the sword never departed from his house" (2 Sam. xii, 10). The outrage on his daughter Tamar, the murder of his eldest son Amnon, and then the revolt of his best beloved Absalom, brought on the crisis which once more sent him forth a wanderer, as in the days when he fled from Saul; and this, the heaviest trial of his life, was aggravated by the impetuosity of Joab, now, perhaps from his complicity in David's crime, more unmanageable than ever.

(2.) Of all his sons, Absalom had naturally the greatest pretensions, being, by his mother's side, grandson of Talmi, king of Geshur; while, through his personal beauty and winning manners, he was held in popular favor. It is evident, moreover, that he was the darling son of his father. When his own sister Tamar had been dishonored by her half-brother Amnon, the eldest son of David, Absalom slew him in vengeance, but, in fear of his father, then fled to his grandfather at Geshur. B.C. 1033. Joab, discerning David's longings for his son, effected his return after three years; but the conflict in the king's mind is strikingly shown by his allowing Absalom to dwell two full years in Jerusalem before he would see his face. See ABSALOM.

(3.) The insurrection of Absalom against the king was the next important event, in the course of which there was shown the general tendency of men to look favorably on young and untried princes rather than on those whom they know for better and for worse. B.C. 1028. Absalom erected his royal standard at Hebron first, and was fully prepared to slay his father outright, which might probably have been done if the

getic advice of Ahithophel had been followed. Rebellion was fostered apparently by the growing lousy of the tribe of Judah at seeing their king abode into the whole nation; and if, as appears from am. xi, 8; xxiii, 84, Ahithophel was the grandfather of Bathsheba, his main supporter was one whom David had provoked by his own crimes.

It was apparently early on the morning of the day or he had received the news of the rebellion at Hebron that the king left the city of Jerusalem on foot, was accompanied by a vast concourse, in the midst of which he and his body-guard were conspicuous. They started from a house on the outskirts of the city (2 Sam. xv, 17, Sept.), and every stage of the mourning procession was marked by some incident which led forth a proof of the deep and lasting affection which the king's peculiar character had the power of inspiring in all who knew him. The first distinct halt was by a solitary olive-tree (2 Sam. xv, 18, Sept.) that marked the road to the wilderness of the Jordan. Among his guard of Philistines and his faithful company of 600 he observed Ittai of Gath, and, with the noble nobleness of his character, entreated the Philistine chief not to peril his own or his countrymen's lives in the service of a fallen and a stranger sovereign. But Ittai declared his resolution (with a fervor which almost inevitably recalls a like profession made most on the same spot to the great descendant of David centuries afterwards) to follow him in life and death. They all passed over the ravine of the Kezon; and here, when it became apparent that the king was really bent on departure, "the whole land wept with a loud voice"—the mountain and the valley sounded with the wail of the people. At this point they were overtaken by the two priests, Zadok and Abiathar, bringing the ark from its place on the sacred hill, to accompany David in his flight—Abiathar, the elder, going forward up the mountain, as the multitude defiled past him. Again, with a spirit worthy of the king, who was prophet as well as priest, David turned them back. He had no superstitious belief in the ark as a charm; he had too much reverence for it to risk it in his personal peril. And now the whole crowd turned up the mountain pathway; all wailing, all with their heads muffled as they went; the king only distinguished from the rest by his unsandalled feet. At the top of the mountain, consecrated by an altar of worship, they were met by Hushai the Archite, "the friend," as he was officially called, of the king. The priestly garment, which he wore after the fashion, as it would seem, of David's chief officers, was torn, and his head was smeared with dust, in the bitterness of his grief. In him David saw his first gleam of hope. A moment before, the tidings had come of the treason of Ahithophel; and, to frustrate his designs, Hushai was sent back, just in time to meet Absalom arriving from Hebron. It was noon when David passed over the mountain top, and now, as Jerusalem was left behind, and the new scene opened before him, two new characters appeared, both in connection with the hostile tribe of Benjamin, whose territory they were entering. One was Ziba, servant of Mephibosheth, taking advantage of the civil war to make his own fortunes. At Bahurim, also evidently on the downward pass, came forth one of its inhabitants, Shimei, in whose furious curses broke out the long-suppressed hatred of the fallen family of Saul, as well perhaps as the popular feeling against the murderer of Uriah. With characteristic replies to both, the king descended to the Jordan valley (2 Sam. xvi, 14; and comp. xvii, 22; Joseph. Ant. vii, 9, 4), and there rested after the long and eventful day at the ford or bridge (*Abara*) of the river. At midnight they were aroused by the arrival of the two sons of the high-priests, and by break of day they had reached the opposite side in safety.

To the dawn of that morning is to be ascribed Psa.

lii, and (according to Ewald, though this seems less certain) to the previous evening Psa. iv. Psa. cxliii, by its title in the Sept., "When his son was pursuing him," belongs to this time. Also, by long popular belief, the Trans-Jordanic exile of Psa. xlii has been supposed to be David, and the complaints of Psa. lv and lxix to be levelled against Ahithophel (q. v.), who, on finding his advice disregarded, committed suicide in a fit of offended pride and despair (see Schwarz, *De morte Ahithophelis*, Wittenb. 1704).

The history of the remaining period of the rebellion is comparatively brief. Mahanaim was the capital of David's exile, as it had been of the exiled house of Saul (2 Sam. xvii, 24; comp. ii, 8, 12). Three great chiefs of that pastoral district are specially mentioned as supporting him: one, of great age, not before named, Barzillai the Gileadite; the two others, bound to him by former ties, Shobi, the son of David's ancient friend Nahash, probably put by David in his brother's place (xii, 80; x, 2), and Machir, the son of Ammiel, the former protector of the child of David's friend Jonathan (2 Sam. xvii, 27; ix, 4). Strengthened by the warlike Eastern tribes, and surrounded by his experienced captains, the king no longer hesitated to meet Absalom in the field. His forces were arranged under the three great military officers who remained faithful to his fortunes—Joab, captain of the host; Abishai, captain of "the mighty men;" and Ittai, who seems to have taken the place of Benaiah (had he wavered in his allegiance, or was he appointed afterwards?), as captain of the guard (2 Sam. xviii, 2). On Absalom's side was David's nephew, Amasa (ib. xvii, 25). The warlike spirit of the old king and of his faithful followers at this extremity of their fortunes is well depicted by Hushai, "chafed in their minds, as a bear robbed of her whelps in the 'field' (or a fierce wild boar in the Jordan valley, Sept.);" the king himself, as of old, "lodging not with the people," but "hid in some pit or some other place" (2 Sam. xvii, 8, 9). The final battle was fought in the "forest of Ephraim," resulting in a decisive victory on the part of David's forces, and terminating in the accident leading to the death of Absalom at the hand of Joab during the retreat. David was waiting the event of the battle in the gateway of Mahanaim. Two messengers, each endeavoring to outstrip the other, were seen running breathless from the field. The first who arrived was Ahimaaz, the son of Zadok, already employed as a messenger on the first day of the king's flight. He had been entreated by Joab not to make himself the bearer of tidings so mournful; and it would seem that when he came to the point his heart failed, and he spoke only of the great confusion in which he had left the army. At this moment the other messenger burst in—a stranger, perhaps an Ethiopian—and abruptly revealed the fatal news (2 Sam. xviii, 19-32). See CUSHI. The passionate burst of grief which followed is one of the best proofs of the deep affection of David's character. He wrapped himself up in his sorrow, and even at the very moment of his triumph he could not forget the hand that had slain his son. He made a solemn vow to supersede Joab by Amasa, and in this was laid the lasting breach between himself and his powerful nephew, which neither the one nor the other ever forgave (2 Sam. xix, 18). Perhaps Joab on the former occasion, when he murdered Abner, had blinded the king by pleading revenge for the blood of Asahel, but no such pretence could here avail. The king was now probably brought to his determination partly by his disgust at Joab, partly by his desire to give the insurgents confidence in his amnesty. If Amasa is the same as Amasai, David may likewise have retained a grateful remembrance of the cordial greeting with which he had led a strong band to his assistance at the critical period of his abode in Ziklag (1 Chron. xii, 18); moreover, Amasa, equally with Joab, was David's nephew, their two mothers, Abigail and Zeruah, being

sisters to David by at least one parent (2 Sam. xvii, 25; 1 Chron. ii, 13, 16). The unscrupulous Joab, however, was not so to be set aside. Before long, catching an opportunity, he assassinated his unsuspecting cousin with his own hand; and David, who had used the instrumentality of Joab to murder Uriah, did not dare to resent the deed (2 Sam. xx, 5-12).

The return was marked at every stage by rejoicing and amnesty—Shimei forgiven, Mephibosheth partially reinstated, Barzillai rewarded by the gifts long remembered, to his son Chimham (2 Sam. xix, 16-40; 1 Kings ii, 7). Judah was first reconciled. The members of the insurrection still smouldering (2 Sam. xix, 41-43) in David's hereditary enemies of the tribe of Benjamin were trampled out by the mixture of boldness and sagacity in Joab, now, after the murder of Amasa, once more in his old position. David again reigned in undisturbed peace at Jerusalem (2 Sam. xx, 1-22).

(4.) A quarrel, however, which took place between the men of Judah and those of the other tribes in bringing the king back, had encouraged a Benjamite named Sheba to raise a new insurrection, which spread with wonderful rapidity. "Every man of Israel," are the strong words of the text, "went up from after David, and followed Sheba, the son of Bichri," a man of whom nothing besides is known. This strikingly shows that the later unpatriotic features of David's reign had to a great degree exhausted the enthusiasm once kindled by his devotion and chivalry, and that his throne now rested rather on the rotten foundation of mere military superiority. Amasa was collecting troops as David's general at the time when he was treacherously assassinated by his cousin, who then, with his usual energy, pursued Sheba, and blockaded him in Beth-maachah before he could collect his partisans. Sheba's head was cut off and thrown over the wall; and so ended the new rising (2 Sam. xx, 1-22). Yet this was not the end of trouble, for the intestine war seems to have inspired the Philistines with the hope of throwing off the yoke. Four successive battles are recorded (2 Sam. xxi, 15-22), in the first of which the aged David was nigh being slain. His faithful officers kept him away from all future risks, and Philistia was once more, and finally, subdued.

c. The closing period of David's life, with the exception of one great calamity, may be considered as a gradual preparation for the reign of his successor. This calamity was the three days' pestilence which visited Jerusalem at the warning of the prophet Gad (see Blessig, *De censu Dav. pestique hunc secuta*, Argent. 1788; Becker, *Quare Deus Davidem pestilentia punierit*, Rost. 1767). The occasion which led to this warning was the census of the people taken by Joab at the king's orders (2 Sam. xxiv, 1-9; 1 Chron. xxi, 1-7, xxvii, 23, 24); an attempt not unnaturally suggested by the increase of his power, but implying a confidence and pride alien to the spirit inculcated on the kings of the chosen people. Joab's repugnance to the measure was such that he refused altogether to number Levi and Benjamin (1 Chron. xxi, 6). The king also scrupled to number those who were under twenty years of age (1 Chron. xxvii, 23), and the final result was never recorded in the "Chronicles of King David" (1 Chron. xxvii, 24). The plague, however, and its cessation were commemorated down to the latest times of the Jewish nation. Probably Psalms xxx and cxxxi have reference to this time. But a more certain memorial was preserved on the exact spot which witnessed the close of the pestilence, or, as it was called, "The Death." Outside the walls of Jerusalem, Araunah or Ornan, a wealthy Jebusite—perhaps even a descendant of the ancient king of Jebus (2 Sam. xxiv, 23)—possessed a threshing-floor; there he and his sons were engaged in threshing the corn gathered in from the harvest (1 Chron. xxi, 20). At this spot an awful vision appeared, such as is described in

the later days of Jerusalem, of the Angel of the Lord stretching out a drawn sword between earth and heaven over the devoted city. The scene of such a manifestation at such a moment was at once marked out for a sanctuary. David demanded, and Araunah willingly granted, the site; the altar was erected on the wide threshing-floor; the place was called by the name of "Moriah" (2 Chron. iii, 1); and for the first time a holy place, sanctified by a vision of the Divine presence, was recognised in Jerusalem. It was this spot which afterwards became the altar of the Temple; and therefore the centre of the national worship, with a slight interruption, for more than 1000 years, and so even contended that the same spot is the rock still regarded with almost idolatrous veneration, in the centre of the Mussulman "Dome of the Rock" (see H. Willis in Williams's *Holy City*, ii).

The selection of the site of this altar probably revived the schemes of the king for the building of a permanent edifice to receive the ark, which still remained inside his own palace in its temporary rest. Such schemes, we are told, he had entertained after the capture of Jerusalem, or at the end of his reign. Two reasons were given for their delay: one, that the ancient nomadic form of worship was not yet to be abandoned (2 Sam. vii, 6); the other, that David's wars unfitted him to be the founder of a seat of peaceful worship (1 Chron. xxii, 8). But a solemn assurance was given that his dynasty should continue "forever" to prosecute the work (2 Sam. vii, 13; 1 Chron. xxii, 9, 10). Such a founder, and the ancestor of such a dynasty, was Solomon to be, and to him, therefore, the stores and the plans of the future Temple (according to 1 Chron. xxii, 2-19; xxviii, 1-xxix, 19) were committed.

d. The last commotion recorded took place since David's end seemed nigh, and Adonijah, one of his elder sons, feared that the influence of Bathsheba might gain the kingdom for her own son Solomon. B.C. 1015. Adonijah's conspiracy was joined by Abiathar, one of the two chief priests, and by the rejected Joab; upon which David took the decisive measure of raising Solomon at once to the throne. Of two young monarchs, the younger and the less known was easily preferred, when the sanction of the existing government was thrown into his scale; and the cause of Adonijah immediately fell to the ground. Zadok, Nathan, Benaiah, Shimei, and Rei remaining firm, the plot was stifled, and Solomon's inauguration took place under his father's auspices (1 Kings i, 1-56). See ADONIJAH. Amnesty was proclaimed to the conspirators, and was faithfully observed by Solomon till a later violation of its terms. See SOLOMON.

4. By this time David's infirmities had grown upon him. The warmth of his exhausted frame was attempted to be restored by the introduction of a young Shunamite, of the name of Abishag (q. v.), mentioned apparently for the sake of an incident which grew up in connection with her out of the later events (1 Kings i, 1; ii, 17). His last song is preserved (see Pfeiffer, *Erklär. der sogenannten letzten Worte Davids*, Altdorf, 1774; De Baer, *In ultima verba Davida, in the Bibl. Hag. ii, 439-504; Trendelenburg, In verba senectutis Davidis*, Gotting. 1779)—a striking union of the ideal of a just ruler which he had placed before him, and of the difficulties which he had felt in realizing it (2 Sam. xxiii, 1-7). His last words, as recorded, to his successor are general exhortations to his duty, combined with warnings against Joab and Shimei, and charges to remember the children of Barzillai (1 Kings ii, 1-9).

He died B.C. 1013, at the age of seventy (2 Sam. v, 4), and "was buried in the city of David" (1 Kings ii, 10). After the return from the captivity, "the sepulchres of David" were still pointed out "between Siloah and the house of the 'mighty men,'" or "the guard-house" (Neh. iii, 16). His tomb, which became the general sepulchre of the kings of Judah, was possi-

at in the latest times of the Jewish people. "His Ichre is with us unto this day," says Peter at Pent (Acts ii, 29); and Josephus (*Ant. vii, 15, 8*; *xiii, xvi, 7, 1*) states that Solomon, having buried a treasure in the tomb, one of its chambers was open by Hyrcanus, and another by Herod the Great. It is said to have fallen into ruin in the time of Adrian (Dio Cassius, *lxix, 14*). In Jerome's time mad, so called, was the object of pilgrimage (*Ep. Marcell. 17, 46*), but apparently in the neighborhood of Bethlehem. The edifice shown as such from the Crusades to the present day is on the southern hill of modern Jerusalem, commonly called Mount Zion, or the so-called "Cenaculum." For the description of it, see Barclay's *City of the Great King*, p. 209. The traditions concerning it, see Williams's *Holy Land*, ii, 509-518. The so-called "tombs of the kings" of late have been claimed as the royal sepulchre by De Cy (ii, 162-215), who brought to the Louvre (where they are seen) what he believed to be the lid of David's sarcophagus. But these tombs are outside the walls, and therefore cannot be identified with the tomb of David, which was emphatically *within* the walls (Robinson, iii, p. 252, note).

The character of David has been so naturally brought in the incidents of his life that it need not be here described in detail (see Niemeyer, *Charakt.* iv, 125). In the complexity of its elements, passion, tenderness, generosity, fierceness—the soldier, the shepherd, the poet, the statesman, the priest, the prophet, king—the romantic friend, the chivalrous leader, devoted father—there is no character of the Old Testament to be compared to it. Jacob comes nearest in variety of elements included within it. But David's character stands at a higher point of the sacred story, and represents the Jewish people just at the moment of their transition from the lofty virtues of the older system to the fuller civilization and cultivation of the later. In this manner he becomes natural, if one may say so, the likeness or portrait of the grandest development of the nation and of monarchy in the person and the period of the Messiah. In a sense more than figurative, he is the type and prophecy of Jesus Christ. Christ is not called the son of Abraham, or of Jacob, or of Moses, but he is truly "the son of David."

To his own people, his was the name most dearly cherished after their first ancestor Abraham. "The house of David," "the house of David," "the throne of David," "the seed of David," "the oath sworn unto David" (the pledge of the continuance of his dynasty), expressions which pervade the whole of the Old Testament and all the figurative language of the New Testament, they serve to mark the lasting significance of his career in history.

His Psalms (whether those actually written by him, or by many or few) have been the source of consolation and instruction beyond any other part of the Hebrew Scriptures. In them appear qualities of mind and religious perceptions not before expressed in the sacred writings, but eminently characteristic of David: the love of nature, the sense of sin, and the tender, confident trust in, and communion with, God. No other part of the Old Testament comes so near to the spirit of the New. The Psalms are the only expressions of devotion which have been equally used through the whole of Christian Church—Abyssinian, Greek, Latin, Italian, Anglican.

The difficulties that attend his character are valuable as proofs of the impartiality of Scripture in recording them, and as indications of the union of natural strength and weakness which his character included. The Rabbis in former times, and critics (like Bayle) in later times, have seized on its dark features and exaggerated them to the utmost. It has often been used, both by scoffers and the serious, how the man who God's own heart could have murdered Uriah,

and seduced Bathsheba, and tortured the Ammonites to death? An extract from one who is not a too-indulgent critic of sacred characters expresses at once the common sense and the religious lesson of the whole matter. "Who is called 'the man after God's own heart?' David, the Hebrew king, had fallen into sins enough—blackest crimes—there was no want of sin. And therefore the unbelievers sneer, and ask, 'Is this your man according to God's heart?' The sneer, I must say, seems to me but a shallow one. What are faults, what are the outward details of a life, if the inner secret of it, the remorse, temptations, the often baffled, never ended struggle of it be forgotten? . . . David's life and history, as written for us in those Psalms of his, I consider to be the truest emblem ever given us of a man's moral progress and warfare here below. All earnest souls will ever discern in it the faithful struggle of an earnest human soul towards what is good and best. Struggle often baffled—sorely baffled—driven as into entire wreck; yet a struggle never ended, ever with tears, repentance, true unconquerable purpose begun anew" (Carlyle's *Heroes and Hero-Worship*, p. 72).

See generally Havercamp, *David, res gesta vindicata* (L. B. 1735); Niemeyer, *Ueber Leben und Char. Dav.* (Hal. 1779); Ewald, *Leben Dav.* (Gera, 1795); Hauser, *De Hist. Dav.* (Tub. 1780); Hosmann, *Hist. Sam. Saulis et Dav.* (Kil. 1752); Feuerlein, *Illustratio Davidis facta ex jurisprudentiâ naturalis illustrata* (Alt. 1715); Newton, *David, the King of Israel* (Lond. 1854); Shepherd, *Life of David illustrated by Psalms* (Lond. 1858); A. L. O. E., *Shepherd of Bethlehem* (1861); Hasse, *Idiognomik Davids* (Jen. 1784); Metzger, *Desiderium regis Dav. ad domum Dei* (Augsb. 1776); Serpillis, *Personalia Davidis* (vol. ix of his *Personalia*, Leipzig, 1718); Krummacher, *David the King* [from the Germ.] (Edinb. 1867, N. Y. 1868). See PSALMS.

B. *In phrases.*—The "House of David" (Isa. vii, 2, 18; Jer. xxi, 12; Zech. xiii, 1) signifies his family, posterity. "In David," that is, in the *Book of David*, the Psalms (Matt. xxii, 42-46; Heb. iv, 7; Psa. xcvi, 7). The name "David," in Ezek. xxxiv, 23, 24; xxxvii, 24; Hos. iii, 5, denotes the expected Messiah. "The Son of David" is often applied to Jesus as a title of the Messiah (Matt. i, 1; ix, 27; xii, 28; xv, 22; xx, 80, 81; Mark x, 47, 48), but not in John's writings. So the "Root of David" is used in the same sense (Rev. v, 5; xxii, 16; Isa. xi, 1, 10). Hence the kingdom or reign of the Messiah is designated by the appellations "the Kingdom of David" (Mark xi, 10); "the Throne of David" (Luke i, 32); "the Tabernacle of David" (Acts xv, 16; Amos ix, 10); "the Key of David" (Rev. iii, 7; Isa. xxii, 22; Matt. xvi, 19).

DAVID, CITY OF. This name is applied in Scripture to two different places.

1. In 2 Sam. v, we read that David, having taken Jerusalem, and stormed the citadel on Mount Zion, "dwelt in the fort, and called it the city of David" (1 Chron. xi, 7). After that time the castle and palace of Zion appear to have been called "the City of David," as contradicting alike from Jerusalem generally, and from Moriah and other sections of it (1 Kings viii, 1; iii, 1; 2 Chron. v, 2). In it David and most of his successors on the throne were buried (1 Kings ii, 10; 2 Chron. ix, 81, etc.). Mount Zion, or the City of David, is on the south-west side of Jerusalem, opposite Moriah, or the temple-mount, with which it was connected by a bridge spanning the deep valley of Tyropeon. The tomb of David on Zion is to this day one of the most honored sanctuaries of the Mohammedans; and the square keep, called the Castle of David, on the northern end of Zion, is one of the most ancient and interesting relics in the Holy City. See JERUSALEM.

2. In Luke ii, 4 and 11, Bethlehem is called the City of David. Joseph and Mary went from Nazareth "unto the city of David, which is called Bethlehem."

This was David's birthplace, and the home of his youth. We know not at what time the little mountain village began to be called by his name; but there is no trace of such a designation in the O. T. It appears, however, to have been pretty generally used in the time of our Lord.—Kitto, s. v. See BETHLEHEM.

David, or Dewid, Sr., patron saint of Wales, was, according to tradition, the son of the prince of Ceredica (Cardiganshire), and was born about the end of the 5th or beginning of the 6th century. Having resolved on a religious life, he spent, as was customary in those days, a probationary period in solitude, after which he commenced preaching to his countrymen. He built a chapel at Glastonbury, and founded twelve monasteries, the chief of which was at Menevia, in the vale of Ross. At the synod of Brevy, in Cardiganshire, held in 519, David showed himself a strong opponent of the Pelagian heresy. Subsequently he became archbishop of Caerleon-upon-Usk, but transferred his see to Menevia, now called St. David's, where he died about the year 601. His life was written by Rice-march, bishop of St. David's, who died about the year 1099. The *Historia S. Davidis*, by Giraldus Cambrensis, written about 1175, and published in Wharton's *Anglia Sacra*, is little more than an abridgment of Rice-march's work.—Chambers, *Encyclopædia*, s. v.; Butler, *Lives of Saints*, March 1.

David, CHRISTIAN, one of the founders of Herrnhut, was born Dec. 31, 1690, at Senftleben, Moravia, and was bred a carpenter. In early manhood he became a Protestant. In 1722 he was sent to find a home for the persecuted Moravians, and secured one from Count Zinzendorf, at Bertholdsdorf, Lusatia. See MORAVIANS. When the church was organized at Herrnhut (their new abode), David was elected first of the twelve elders. His subsequent life was entirely devoted to missionary and Christian labors. In 1733 he led the first Moravian mission to Greenland. In 1738 Wesley had several interviews with David at Herrnhut. The after labors of David included two additional visits to Greenland, and eleven to Moravia; with others to Denmark, Holland, Wetteravia, Livonia, and England. In the beginning of 1750 he visited all the congregations in Germany, and almost immediately returned to London. In July he re-embarked for Germany, visited the churches in Wetteravia, and assisted at the synod held at Barby. From that period he resided at the church which his hands had founded. The toils of an honored and useful life were unexpectedly closed by his death, after a short illness, February 3, 1751. See Stevens, *History of Methodism*, i, 97; *Wesleyan Magazine*, March, 1852; Wesley, *Works*, iii, 86; v, 284.

David of Dinanto (13th century) is said to have been a disciple of Amalrich of Bena (q. v.), who died A. D. 1207. The Council of Paris (A. D. 1209) not only condemned Amalrich, but also David of Dinanto. Thomas Aquinas (*Sent.* ii, Dist. xvii, qu. i, art. i) speaks of certain "modern philosophers" as adherents of David, and attributes to him a doctrine in substance pantheistic: "God is the eternal substance; all things are God, and God is everything." Albertus Magnus speaks of a treatise of his, *De Tomis*. But, in fact, little is really known of David or his writings, except that he was one of the leaders of the pantheistic tendency in the Middle Ages. Neander (*History of Dogmas*, ii, 560, Ryland's translation) gives the chief authorities for what is known of David's doctrines, viz. Concil. Paris, a. 1209, in Martene *Theaur. Anecd.* iv, 168; Albertus Magnus, *Summa P. I.* Tract. iv, Quæstio 20, Memb. ii, ed. Lugd. t. xvii, f. 76; Thomas Aquinas, in *Sent.* l. ii, Dist. xvii, qu. i, art. i, ed. Venet. t. x, p. 285. David "described God as the *principium materiale omnium rerum*, and in reference to the three departments of existence distinguished three principles:

matter, the first indivisible principle of the created world; in reference to the spiritual world—*spiritus*, an invisible *voic*; from which proceeds the soul; and reference to the ideas of God—the first indivisible eternal substances. Between these three principles no distinction could exist, for otherwise they must be referred back to a higher principle of unity. These are, therefore, three relations of the one divine being to the corporeal, the spiritual, and the ideal world." See Baur, *Vorles. üb. d. Dogmengeschichte*, 1866, vi, i, § 328; Gieseler, *Ch. Hist.* vol. ii, § 74; Krumlein, *Opuscula Amalrici a Bena equis sectatorum ac Dominici Dinanto doctrina*, Glees. 1842; Staudemann, *Piel (Christenthums)*, i, 688 sq.; Engelhardt, *Amalrich von Bena, in den kirchlich. Abhandlung.* No. 3; Krumlein, *Amalrich von Bena u. A. David von Dinanto, in Zeit. Krit.* 1847, i, 271 sq.

David (Maronite archbishop, A. D. 1063) or **MAR LIBANUS**, wrote an *Epistole* to Arsenius concerning the Melchite and Maronite sects; also a *Treatise* on the opinions of the Eastern Christians, part of which was published by Abraham Ecchelenis (a Roman Maronite), *Antiq. Orient.* p. 459 (London, 1682). In the year 1059, at the request of the abbot Joseph, he translated from Syriac into Arabic the *Constitutiones Ecclesie Maronitarum*, in seventeen chapters (see Abraham Ecchelenis, *Not. ad Catalog. Hebræorum*, n. 5)—*Christ. Succ. of Sacred Literature*, ii, 606. See MARONITES.

David of Augsburg, a Franciscan of the 13th century, was a friend of Berthold of Ratibon, who he accompanied on his missionary journey. He died in Augsburg in 1271. Three treatises of his are given in the *Bibliotheca Patrum*, vol. xiii, viz. *The New Formula for the Reformation of the outer Man, A Formula for the inner Man*, and *A Mirror of the soul of a Religious*. These tracts have been erroneously ascribed to Bonaventura. Several of his works were written in the German language, and of this class it have been published by Pfeiffer in his *Deutsche Mythen des 13ten Jahrhunderts* (Leipzig, 1845).—*Ordn. Comment. de Script. Eccles.* iii, 447.

David George, or **Joris**. See **JOHN**.

David Nicetas. See **NICETAS**.

Davidists, followers of David Joris. See **JOHN**.

David's, Sr., an episcopal city in Pembroke-shire, Wales. It has been the seat of a bishopric since about 519, when St. David (q. v.) transferred the archbishop's see to St. David's (before called Mynyw, and by the Romans Menevia) from Caerleon. It was in the Middle Ages a large city—the great resort of pilgrims to St. David's shrine; it is now a small village, with only a few good houses besides those of the clergy. It has a fine cathedral, and splendid remains of religious houses, episcopal palace, and St. Mary's College (founded by John of Gaunt), within a high embattled wall nearly a mile in circuit. The cathedral, founded in 1180, on the site of the monastery of St. David, is cruciform. Its dimensions, in the interior, are as follows: length, 290 feet; breadth, 76; nave, 12 ft. choir, 80; transept, 120; central tower, 127 feet high. Among the former bishops may be named Land, Ball, South, and Horsley. The present incumbent (1861) of the see is Connop Thirlwall, the historian of Greece. The cathedral establishment includes a bishop, a dean, four canons, five vicars choral, and other officers residential, with four archdeacons, and 12 prebendaries or honorary canons, non-resident.—Chambers, *Encyclopædia*, s. v.

Davidson, ROBERT, D. D., an eminent Presbyterian divine and scholar, was born at Elkhart, N. H. 1750, and graduated at the University of Pennsylvania 1771. In 1778 he was ordained by the Second Presbyterian of Philadelphia, and became associate pastor of the First Church and professor of history in the University. During the Revolution he was a zealous

, and when the British occupied Philadelphia he fled to Delaware. In 1784 he was appointed vice-rector and professor of belles-lettres in Dickinson College, and was also called to be pastor of the First Presbyterian Church in Carlisle. On leaving Philadelphia, he was made D.D. by the University. The duties devolving on him at Carlisle were discharged with signal ability, industry, and success. His learning embraced a wide range, including eight languages, theology, and physics. He was especially devoted to astronomy, and invented an ingenious apparatus called a *Cosmoplane*, presenting the earth and sun to view on the same axis. He was also a man of elegant tastes, skilled in music and drawing. In 1785 he was appointed by the Old Synod of New Jersey and Philadelphia, along with Drs. Alison and Mather, on a committee to prepare an improved version of the Psalms to take the place of Rouse. In 1786 he was chosen moderator of the General Assembly and in 1804 he succeeded Dr. Nisbet in the presidency of the college, which he resigned in 1809, in order to devote himself exclusively to his pastoral duties. He died at Carlisle Dec. 13, 1812. His publications are, *A Dialogue, with two Odes set to Music*, 1776; *Epitome of Geography*, 1784; *A Dialogue, in blank verse*; *Papers on Astronomy*; *Funeral Eulogium on Washington*, 1799; *The Christian's A, B, C*, 1811; *New Literal Version of the Psalms*, 1812; *Occasional Sermons*.—See Sprague, *Annals*, iii, 322.

Davies, SAMUEL, a Presbyterian minister, president of the College of New Jersey, was born near Summit Ridge, Newcastle County, Del., Nov. 3, 1728. He was educated at Fogg's Manor School, where he completed his theological studies also, and was licensed July 30, 1746. He was ordained as an evangelist in 1747, undertook a mission to Hanover County, Va., and on his arrival obtained a license from the General Court to officiate at four different places of worship. In 1748 he accepted a call to Hanover, and, having received an extension of his license, he divided his labors between five counties with great success. He subsequently claimed the privilege of the Act of toleration for Virginia, and received a letter "under authority" in England confirmatory of his views. In 1758 he went to England in behalf of the College of New Jersey, and returned to Virginia in 1755, when the Presbytery of Hanover was founded, chiefly through its instrumentality. In 1759 he became president of New Jersey College, and removed to Princeton, where he died Feb. 4, 1761. It is deserving of record that in a discourse on the occasion of Braddock's defeat he made the following prophetic remark of Washington: "I may point out to the public that heroic youth, colonel Washington, whom I cannot but hope Providence has hitherto preserved in so signal a manner for some important services to his country." "In the pulpit he was at once instructive and persuasive, full of light, and power, and love; and his manner of delivery was worthy of his fine thoughts, splendid diction, and deeply evangelical spirit." His sermons, which are strikingly eloquent, have been often reprinted; the latest editions are those of Albert Barnes, with a life of the author (New York, 1851, 3 vols. 8vo), and that of the Presbyterian Board, with memoir by Dr. Sprague (Phila. 3 vols. 8vo).—Sprague, *Annals*, iii, 140.

Davis, Charles A., a Methodist Episcopal minister, was born Oct. 7, 1802, and was admitted on trial by the Baltimore Conference in 1824. During his itinerant life he filled many important appointments. He was stationed three times in Baltimore. He served also in Philadelphia, Washington, New York, Montgomery Circuit, Md., Alexandria, D. C., Annapolis, Md., and twice in Winchester, Va. In May, 1832, he was one of the secretaries of the General Conference at its session in Philadelphia. For several years he

was clerk in one of the departments of the general government in Washington, where he was received into the Virginia Conference of the Methodist Episcopal Church South, and filled an appointment in Richmond, and also in Portsmouth, Va. While in Portsmouth he received the appointment of chaplain in the navy. When the civil war broke out he remained true to his country, and the Virginia Conference of the M. E. Church South expelled him by resolution. He united with the Virginia and North Carolina Conference of the Methodist Episcopal Church. He died in charge of the Norfolk Naval Hospital, Feb. 20, 1867.—Dr. J. S. Mitchell, in *Christ. Advocate and Journal*.

Davis, John, a Methodist Episcopal minister, was born in Northumberland County, Va., Oct. 30, 1787, was converted at 19, entered the itinerancy of the Baltimore Conference in 1810, and died in Hillsborough, Va., Aug. 18, 1858. Mr. Davis was a very important and useful minister for more than forty years. As soon as he was converted he began to exhort and preach publicly, and with great effect, even before he had become a member of the Church, and on a circuit in 1818 about one thousand souls were converted by his preaching. In person he was commanding, and his voice was excellent. His mind was well balanced and robust, and his social qualities fine. As a minister and presiding elder he had few equals, and he was always a leader in the councils of the Church. He was an able agent and trustee of Dickinson College, and a member of every General Conference, save two, from 1816 to the time of his death.—*Minutes of Conferences*, v, 329.

Davis, Noah, a Baptist minister, was born near Salisbury, Worcester County, Mass., July 28, 1802. After receiving a commercial education, he was licensed to preach July 9, 1820. After a brief ministry in Accomac, he became pastor of the Baptist church in Norfolk, Va. Having by his energy succeeded in procuring the formation of the Baptist General Tract Society in Washington, Feb. 25, 1824, he was, upon his removal soon after to Philadelphia, invited to the management of its concerns. This office he accepted, and filled with great usefulness until his death, July 18, 1880.—Sprague, *Annals*, vi, 701.

Davison, JOHN, B.D., fellow of Oriel College, Oxford, was born at Morpeth in 1777, and matriculated at Christ Church, Oxford, in 1794. He became vicar of Sutterton, Lincolnshire, in 1817, and afterwards rector of Washington; then prebendary of Worcester and rector of Upton-upon-Severn in 1826. He died in 1834. His *Discourses on Prophecy* are valuable for their practical tendency as well as critical research. They are contained in his *Remains and Occasional Publications* (Oxf. 1840, 8vo).—Darling, *Cyclopaedia Bibliographica*, i, 877.

Dawes, Sir WILLIAM, D.D., archbishop of York, was born at Lyons, near Braintree, in 1671. He was educated at St. John's College, Oxford, and Catharine Hall, Cambridge; became master of Catharine Hall in 1696, bishop of Chester in 1707, and finally archbishop of York in 1714. He died in 1724. He had a lively imagination, a strong memory, and a sound judgment. He was one of the most popular preachers of his day. Among his writings are *The Anatomy of Atheism* (1698, 4to);—*Duties of the Closet*, etc. (1707, 8vo), etc. A collection of his works was published (Lond. 1733, 3 vols. 8vo), with a preface, giving some account of his life and character.—Darling, *Cyclopaedia Bibliographica*, i, 870; *Biographia Britannica*, v, 15.

Dawn, dawn , dawn , dawn , the breathing or breeze of the cooler part of the day; prop. the evening "twilight" (as usually rendered), hence the morning twilight or "dawning" (Job vii, 4; Psa. cix, 147; "twilight," 1 Sam. xxx, 17; 2 Kings. vii, 5, 7); poet. dawn

anphappa' gim, *eye-lids* (as elsewhere rendered) of the morn, i. e. day-break (Job iii, 9); also *נִרְצָה*, to *turn*, spoken of the change of darkness into light (Judg. xix, 26); and *אֲרָצָה*, to *ascend*, of the lifting of night's shades (Josh. vi, 15). In Greek *ἐπιφώσκω*, to *grow light* (Matt. xxviii, 1; hence also of the *approaching Sabbath*, Luke xxiii, 44); and *διαναύζω*, to *become lustrous*, as through a crevice (2 Pet. i, 19). See DAY.

Day (properly *דִּיּוּם*, *yom*, *hμέρα*). The variable length of the natural day ("ab exorta ad occasum solis," Censor. *de Die Nat.* 23) at different seasons led in the very earliest times to the adoption of the civil day (or one revolution of the sun) as a standard of time. The commencement of the civil day varied in different nations: the Babylonians (like the people of Nuremberg) reckoned it from sunrise to sunrise (Isidor. *Orig.* v, 80); the Umbrians from noon to noon; the Romans from midnight to midnight (Plin. ii, 79); the Athenians and others from sunset to sunset (Macrob. *Satur.* i, 8; Gell. iii, 2). See CHRONOLOGY.

The Hebrews adopted the latter reckoning (Lev. xxiii, 32, "from even to even shall ye celebrate your Sabbath"), which appears even in Gen. i, 5, "the evening and the morning were [on] the first day" (a passage which the Jews are said to have quoted to Alexander the Great, Gemara, *Tamid*, 66, 1; Reland, *Ant. Hebr.* iv, 15). Some (as in Godwyn's *Moses and Aaron*) argue foolishly, from Matt. xxviii, 1, that they began their civil day in the morning; but the expression *ἐπιφώσκουσαν* shows that the *natural day* is there intended. Hence the expression "evening-morning" = day (Dan. viii, 14, Sept. *νυχθημερον*), the Hindoo *ahoratra* (Von Bohlen on Gen. i, 4), the Greek *νυχθημερον* (2 Cor. xi, 25). There was a similar custom among the Athenians, Arabians, and ancient Teutons (Tac. *Germ.* xi, "nec dierum numerum ut apud nos, sed noctium computant . . . nox ducere diem videtur") and Celtic nations (Cæsar, *Bell. Gall.* vi, 18, "ut noctem dies subsequatur"). This mode of reckoning was widely spread; it is found in the Roman law (Gaius, i, 112), in the Niebelungenlied, in the Salic law (*inter decem noctes*), in our own terms "fort-night," "se'n-night" (see Orelli, etc. in loc. Tac.), and even among the Siamese ("they reckon by nights," Bowring, i, 137) and New Zealanders (Taylor's *Te-Ika-Mau*, p. 20). No doubt this arose from the general notion "that the first day in Eden was 36 hours long" (Lightfoot's *Works*, ii, 884, ed. Pitman; Hesiod, *Theogon.* 123; Aristoph. *Av.* 693; Wilkinson, *Anc. Eg.* iv, 274). Kalisch plausibly refers it to the use of *lunar years* (Gen. p. 67). Sometimes, however, they reckoned from sunrise (*ἡμερονύκτιον*, comp. *Psa.* i, 2; Lev. vii, 15). The less obvious starting-points of noon and midnight, the former adopted by the Etruscans, etc., the latter by the Roman priests, Egyptians (see, however, Lepsius, *Chronol.* p. 180), and others, were chosen either as the culminating points, as it were, of light and darkness, or for astronomical purposes (Ideler, *Hb. d. Chron.* i, 29, 80, 100 sq.; comp. Tacit. *Germ.* 11; Macrob. *Sat.* xxxiii, etc.). To the Hebrews, the moon had distinctly been pointed out as the regulator of time (*Psa.* civ, 19). Nevertheless, it has always been a moot point whether the Hebrews, at all times and in all respects, began their calendar or civil day with the night. (See Felseisen, *De civili Judæorum die*, Lpz. 1702; Federreuther, *De diebus Ægyptiacis*, Altd. 1757.) It has been argued that, if this had been the case, the lawgiver could not have designated those very evenings which he wished to belong ritually to the following (15th, 10th) day, as the evenings of the previous (14th, 9th) day (Lev. i. c.). Further, that in common biblical phraseology, the day is frequently mentioned before the night (*Psa.* i, 2, etc.); and that of the fast days mentioned in Zech. viii, 19, only one begins with the previous evening. Finally—not to

mention other objections—it has been alleged that even in ritual points the Bible occasionally nears the night as following, not as preceding the day (Lev. vii, 15). There seems, in fact, no other way of reconciling these apparent inconsistencies than to assume (comp. Mishnah, *Chulin*, v, 6) that no absolute rule has been laid down with respect to the commencement of the civil day, and that usage varied somewhat in the customs of the people where the Hebrews were at the time sojourning. The prevalent method of computation, however, is evinced by the fact that the Jewish civil day still begins, not with the morning, but the evening—thus the Sabbath commences with the sunset of Friday, and ends with the sunset of the following day. That this was the case in Judæa in our Saviour's day is evident from the evangelists' account of the Passion. In New England the same mode of reckoning the Sabbath was formerly common. See FESTIVAL.

The Jews are supposed, like the modern Arabs, to have adopted from an early period minute specifications of the parts of the natural day (see *Jour. de Lit.* Jan. 1862, p. 471). Roughly, indeed, they were content to divide it into "morning, evening, and second day" (*Psa.* lv, 17); but when they wished for greater accuracy they pointed to six unequal parts, each of which was again subdivided. These are held to have been:

(I.) *Ne's sheph*, *נֶשֶׁפֶת* (from *נִשְׁפָּח*, to *blow*), and *de'ar*, *דְּאוֹר*, or the *dawn*. After their acquaintance with Persia they divided this into (a) the time when the eastern and (b) when the western horizon was illuminated, like the Greek *Leucothea*—*Ματαναύρα*; Aurora; or "the gray dawn" (Milton) and the *pre-dawn*. Hence we find the dual *Shaharaim* as a proper name (1 Chron. viii, 8). The writers of the *Jerusalem Talmud* divide the dawn into four parts, of which the first was, 1. *Ajjeleth ha-shachar* (q. v.), "the gannet of the morning," a name by which the Arabians call the sun (comp. "eyelids of the dawn," Job iii, 9; *αἴμας ἀφαιρον*, Soph. *Antig.* 109). This was the time when Christ arose (Mark xvi, 2; John xx, 1; Rev. xiii, 1; *ἡ ἐπιφώσκουσα*, Matt. xxviii, 1). The other three divisions of the dawn were, 2. "when one can distinguish blue from white" (*πρωτὸ σκοτίας ἐν ὄρει*, Matt. xx, 1; "obscurum adhuc coepta lucis," Tacit. *H. N.* 2). At this time they began to recite the *phylacteries*. 3. When the east began to grow light (*ἀφῶστος ἄρτος*, Luke xxiv, 1). 4. Twilight (*λίαν πρωτὸ ἀνατολῆς τοῦ ἡλίου*, Mark xvi, 2; Lightfoot, *Hor. Hebr.* ad loc.). See DAWN.

(II.) *Bo'ker*, *בֹּקֶר*, *sunrise*. Some suppose that the Jews, like other Oriental nations, commenced their civil day at this time until the Exodus (Jennings's *Jewish Ant.*). See MORNING.

(III.) *Chom hay-Yom*, *חֹמַי יוֹמִים*, "heat of the day" (Sept. *ἕως διετηρημένην ἡ ἡμέρα*, 1 Sam. xi, 11; see exactly elsewhere *μεσημβρία*), about 9 o'clock in the forenoon.

(IV.) *Tsohora' gim*, *צְוֹרָחִים*, "the two noons" (Gen. xliii, 16; Deut. xxviii, 29). See NOON.

(V.) *Ru' ach hay-Yom*, *רֵוּחַ יוֹמִים*, "the cool (fresh wind) of the day," before sunset (Gen. iii, 8); so called by the Persians to this day (Chardin, *Voy. en Perse*, Jahn, *Bibl. Arch.* § 29). See AFTERNOON.

(VI.) *E'reb*, *עֶרֶב*, "evening." The phrase "between the two evenings" (Exod. xvi, 12; xxx, 8) being the time marked for slaying the paschal lamb and offering the evening sacrifice (Exod. xii, 6; xxxi, 39), led to a dispute between the Karaites and Samaritans on the one hand, and the Pharisees on the other. The former took it to mean between sunset and full darkness (Deut. xvi, 6); the Rabbinites explained it as the time between the beginning (*ἐπιλην πρωτὰ*, "like

ing") and end of sunset (δ. ὄψια), or real sun- Josephus, *War*, vi, 9, 8; Gesenius, s. v.; Jahn, *Archæol.* § 101; Bochart, *Hieros.* i, 558). See **NIGHT**.

VII.) Chatsobh', צוֹחַב (from צָרַח, "to divide"), *night*. In later Hebrew also *mid-day* (Mishna, *ich.* iv, 1, 5, 6). See **MIDNIGHT**.

Since the Sabbath was reckoned from sunset to sunrise (Lev. xxiii, 32), the Sabbatarian Pharisees, in that it of scrupulous superstition which so often called forth the rebukes of our Lord, were led to settle the *most* rules for distinguishing the actual *instant* when Sabbath began (ὄψια, Matt. viii, 16 = ὄρε ἰδὺν ὁ ἡλιός, Mark i, 32). They therefore called it the time between the actual sunset and the appearance of three stars (Maimon. in *Shabb.* c. 5; comp. Neh. iv, 21, 22); and the Talmudists decided that "if on the evening before Sabbath a man did any work after *one* star had appeared, he was forgiven; if after the appearance of *two*, he must offer a sacrifice for a doubtful transgression; if after *three* stars were visible, he must offer in-offering;" the order being *reversed* for works done on the evening after the actual Sabbath (Lightfoot, *Hor. Hebr.* ad Matt. viii, 16; Otho, *Lex. Rab.* s. v. *obathum*). See **SUNSET**.

Before the Captivity the Jews divided the night into three watches (Psa. lxxii, 6; xc. 4), viz. the first watch, lasting till midnight (Lam. ii, 19, A. V. "the beginning of the watches") = ἀρχὴ νυκτός; the "mid-watch" (which proves the statement), lasting till cock-crow (Judg. vii, 19) = μίσην νυκτῶν; and the *morning* watch, lasting till sunrise (Exod. xiv, 24) = φιλίση νύξ (Homer, *Il.* vii, 488). These divisions are probably connected with the Levitical duties in the Temple service. The Jews, however, say (in spite of their own definition, "a watch is the third part of a night") that they always had *four* night-watches comp. Neh. ix, 3), but that the fourth was counted as part of the morning (Buxtorf's *Lex. Talm.* col. 2454; arzow, *Appar. Crit.* p. 347; Reland, *Antiq.* pt. iv, § 3). See **WATCH**.

In the N. T. we have allusions to four watches, a notion borrowed from the Greeks (Herod. ix, 51) and Romans (φυλακίᾳ τὸ τέταρτον μέρος τῆς νυκτός, *uid.*). These were, 1. ὄψι, ὄψια, or ὄψια ὥρα, from twilight till 9 o'clock (Mark xi, 11; John xx, 19); 2. μεσονύκτιον, midnight, from 9 till 12 o'clock (Mark iii, 35); 3. ἀλεκτροφοῦνία, till 3 in the morning (Mark xiii, 35; 3 Macc. v, 23); 4. πρωτ, till daybreak, he same as πρωία (ὥρα) (John xviii, 28; Josephus, *Ant.* v, 6, 5; xviii, 9, 6). See **NIGHT**.

The word *hour* to mean "hour" is first found in Dan. i, 15, v. 5 (ὥρῃ, *shaah*), also "a moment," iv, 19). Perhaps the Jews, like the Greeks, learned from the Babylonians the division of the day into twelve parts (Herod. ii, 109). In our Lord's time the division was common (John xi, 9). It is probable that Ahas introduced the first sun-dial from Babylon (ἡρολόγιον, ἡρολόγιον, Isa. xxxviii, 8; 2 Kings xx, 11), as Anaximenes did the first *σκιάθρον* into Greece (Jahn, *Arch.* § 101). Possibly the Jews at a later period adopted the clepsydra (Joseph. *Ant.* xi, 6). The third, sixth, and ninth hours were devoted to prayer (Dan. vi, 10; Acts ii, 15; iii, 1, etc.). See **HOUR**.

The days of the week had no proper names among the Hebrews, but were distinguished only by their numerical order from the Sabbath (see Lightfoot's *Works*, ii, 334, ed. Pfitman). See **WEEK**.

The expression ἡμεροσίον, rendered "daily" in Matt. vi, 11, is ἡπ. λεγ., and has been much disputed. It is unknown to classical Greek (ἔοικε πεπλάσθαι ὑπὸ τῶν Ἐπαγγελιστῶν, Origen, *Orat.* 16). The Vulg. has *superlativalem*, a rendering recommended by Abelard to the nuns of the Paraclete. Theophyl. explains it as equivalent to *sufficient* (ὁ ἐπὶ τῇ οὐσία καὶ συντάσει ἡμῶν ἀνταρκής), and he is followed by most

commentators (compare Chrysost. *Hom. in Or. Domin.*, Suid. and Etym. M. s. v.). Salmasius, Grotius, etc. arguing from the rendering ἡμεροσίον in the Nazarene Gospel, translate it as though it were equivalent to *tomorrow's* (τῆς ἐπιόσης ἡμέρας, or εἰς αὔριον, Sixt. Senensis Bibl. Sanct. p. 444 a). But see the question examined at length (after Tholuck) in Alford's *Greek Test.* ad loc.; Schleusner, *Lex.* s. v.; Wetstein, *N. T.* i, p. 461, etc.—Kitto, s. v.; Smith, s. v. See **DAILY**.

In Ezek. iv, 4-6, a day is put symbolically for a year. Erroneously supposing this statement to be a precedent, many interpreters of the prophecies have taken it for granted that one day stands for a year in the prophetic writings of Daniel and John. Such, however, is not the case; the word day is to be taken in its literal sense, unless the context expressly intimates the contrary. On the prophetic or year-day system (Lev. xxv, 8, 4; Num. xiv, 34), see a treatise in Elliot's *Hor. Apoc.* iii, 164, sq., and Prof. Stuart on "The Designations of Time in the Apocalypses," *Bib. Repository*, v, 83-88. See **YEAR**.

The ancients superstitiously held that certain days were lucky (*fasti*) and others unlucky (*nefasti*), and the distinction was sometimes indicated by different colors in the calendar ("red-calendar" or *rubric*). See **CALENDAR**.

The duration of the Mosaic or demiurgic days of Gen. 5-31, has been a matter of considerable dispute. The various opinions on this subject, and the difficulties in which most of them are involved, are stated under the head of **CREATION**. See also the articles **COSMOGONY**; **SABBATH**; **MILLENNIUM**; and the *Methodist Quarterly Review*, April, 1865; *Evangelical Quarterly Review*, January, 1868 (art. Geology).

The word *day* is often used by the sacred writers to denote an indefinite time (Gen. ii, 4; Isa. xxii, 5). The "day of temptation in the wilderness" was forty years (Heb. iii, 8). The "day of the Lord" signifies, generally, a time of calamity and distress (Isa. ii, 12; Joel ii, 11). It is also used of a festal day (Hos. vii, 5), a birthday (Job iii, 1), a day of ruin (Hos. i, 11; Job xviii, 20; comp. *tempus, tempora reipublice*, Cic., and *dies Canensis*), the judgment-day (Joel i, 15; 1 Thess. v, 2), the kingdom of Christ (John viii, 56; Rom. xiii, 12), and in other senses which are mostly self-explaining (see Wemyss, *Symbol. Dict.* s. v.). In 1 Cor. iv, 3, ἡμέρας ἀνθρωπίνης ἡμέρας is rendered "by man's judgment;" Jerome (*ad Algas. Quest.* x) considers this a Cilicium (Bochart, *Hieros.* ii, 471). On Rom. xiii, 12, there are two treatises—Kuinöl, *Explicatio* (Giess. 1808); Rachm, *De nocte et die* (Tubingen, 1764). See **TIME**.

The phrases "LAST DAY" (or *days*), "THAT DAY," are "the general formula of the prophets for an indefinitely left future opened up in perspective" (Stier, *Words of Jesus*, ii, 361, Am. ed.), designating the Messianic period, with its introductory age, that of the Maccabees (after the return from exile), and its consummation in the millennium. See **ESCHATOLOGY**. In a more literal and limited sense, the final judgment is designated. See **LAST DAY**.

DAY OF ATONEMENT. See **ATONEMENT**, **DAY OF**.

DAY'S JOURNEY (יום הַיָּרֵחַ, יום הַיָּרֵחַ, ὁδὸς ἡμεροσίῃ, Herod. iv, 101), a distance such as (in the East) a person might travel in a single day. Comp. **SABBATH-DAY'S JOURNEY**. According to Jonah iii, 3, the circuit of Nineveh was three days' journey. This mode of describing distances is also found in Greek, Roman, Arabian, and Persian writers (see Strabo, xvii, 885; Pliny, v, 4, 9; vi, 85; Livy, xxv, 15; xxx, 29; Athen. i, 7). It needs scarcely be remarked that in itself (if strictly taken) it would be a very vague and fluctuating measurement, the length of a day's journey depending so much on the peculiar circumstances under which each pedestrian travels

(see Casaubon *ad Strab.* i, 35; Ukert, *Geogr. d. Griech.* u. *Röm.* I, ii, 58). But the ancient writers seem to have fixed on the average of what was usually performed by foot-travellers (Herod. iii, 9; iv, 9). Herodotus in one place says (iv, 401) a day's journey amounts to 200 stadia (comp. Polyb. iii, 8; Livy, xxi, 15); in another (v, 58) to 150 (comp. Pausanias, x, 33, 2). According to Vegetius (*Mil.* i, 9), twenty Roman miles, that is, 160 stadia, were reckoned for a day's journey. In the Arabian geographers the length of a day's journey is equally variable; yet among them, as in the East at the present day (Tavernier, i, 48), it may be stated generally at about seven leagues, or from eighteen to twenty English miles, which is probably not far from the distance intended by that expression in Scripture, which occurs chiefly in the Pentateuch (Gen. xxx, 36; xxxi, 23; Exod. v, 8; viii, 27; Num. xi, 31; Deut. i, 2), but also elsewhere (1 Kings xix, 4; 2 Kings iii, 9), and even in the Apocrypha (1 Macc. v, 24, 25; vii, 45; Tobit vi, 1), in the New Test. (Luke ii, 44; Acts i, 12), often in Josephus, (*Ant.* xii, 4, 6; *Ap.* ii, 9; *Life*, 52), and in the Talmud (see Otho, *Lex. Rabb.* p. 421). See JOURNEY.

Day, JEREMIAH, D. D., president of Yale College, was born in New Preston, Conn., August 8, 1773, and was educated at Yale College, where he graduated in 1795. After some years spent as tutor at Greenfield School, Williams College, and Yale, he was licensed as a minister of the Congregational Church in 1800, and in 1801 he was elected professor of mathematics and natural philosophy in Yale College. His health failing, he spent a year or two in travel and retirement, and did not begin his labors in college until 1808. He held that office until 1817, publishing meanwhile a series of mathematical text-books well-adapted to the wants of the time, and which had great success. On the 22d of April, 1817, he was chosen president of Yale College, and held that office till 1846, when his sense of the infirmities of age induced him to resign, against the judgment and wishes of his colleagues, as his judgment and governing faculties were yet in abundant vigor. Notwithstanding chronic feebleness of constitution, his careful habits of life, formed after physiological study of his own constitution, enabled him to preserve his intellectual vigor, and a fair degree of bodily health, up to the year of his death, which occurred August 22, 1867. Besides his mathematical works, president Day wrote *An Inquiry respecting the self-determining Power of the Will* (1838; 2d ed. 1849), which was substantially a refutation of Cousin's view of the will as given in his *Psychology:—Examination of Edwards on the Will* (1841, 12mo), which is "an abstract of Edwards, made in a lucid and truth-loving spirit." He also contributed numerous articles to reviews and journals. As a college officer, his moral and intellectual qualities combined to make him a model. See an admirable sketch by president Woolsey, *New Englander*, Oct. 1867, art. v.

Daysman (מִשְׁפָּטִים, *mok's'ach*, an adjudicator), "an old English term meaning umpire or arbitrator (Job ix, 33). It is derived from *day*, in the specific sense of a day fixed for a trial (comp. 1 Cor. iv, 3, where ἀποκρινῆν ἡμῖνα—lit. *man's day*, and so given in Wycliffe's translation—is rendered 'man's judgment' in the A. V.). Similar expressions occur in German (*eine Sache tagen*—to bring a matter before a court of justice) and other Teutonic languages" (Smith). "The primitive meaning of the verb מִשְׁפָּטִים (according to Gesenius, *Thes.* p. 592) is 'to be clear or manifest;' and in Hiphil 'to make manifest;' also 'to convince, to confute, to reprove or rebuke;' by these last two words the word is rendered in nearly every passage of the A. V., including the ten instances of the Hiphil participle מִשְׁפָּטִים. It is not easy to conjecture why in Job ix, 33 alone the translators resorted to the not

then common word *daysman*. The marginal reading *umpire* seems to convey best the meaning of the passage, 'some one to compose our differences and command silence when either of us exceed our bounds' (Patrick, in loc.). Fürst's term, *Schiedsman* (*Handwörterb.* p. 309), very well expresses the idea of authoritative arbitration. As to the old English noun *daysman*, Johnson's definition, *surety*, is here borne out by his solitary quotation from Spenser (*The Ric. Queens*, ii, 8); *arbitrator* or *umpire* would best express the sense. In Holland's old translation of Livius (p. 137), *Daysmen* and *Umpires* are used as synonyms. In the Bible of 1551, 1 Sam. ii, 25 is so employed" (Kitto). In primitive times such a person appears to have been appointed to prescribe just limits to such as were immoderate in their demands, and to interpose his authority with those who exceeded the assigned bounds of their cause. The laying the hands on both may allude to some particular ceremony; but it evidently also refers to the power of coercion which the *daysman* could exercise over both parties. See MEDIATOR.

Day-spring (חֹמֶת, *shach'ar*, Job xxxvii, 2, elsewhere usually "morning;" ἀνατολή, Luke i, 32, elsewhere "east"), signifies the first streaks of daylight, the dawn, or day-break; and in the former of the above-cited passages it is used in its literal sense. This portion of time was at a later period, in imitation of the Persians, divided into two parts, the first of which began when the eastern, the second when the western division of the horizon was illuminated. See ALJELETH-SHAHAR. In the latter passage, the text of John the Baptist is beautifully compared to the next twilight preceding the rising of the great messiah, the Messiah (comp. Mal. iv, 2; Isa. lx, 1-3; 2 Cor. x, 6). See DAY.

Day-star (Φωσφόρος, *light-bearing*, whence *phosphorus*), *Lucifer*, the morning-star, put (2 Pet. i, 19) as the emblem of the dawn of spiritual light and comfort to the benighted and troubled mind. See LUCIFER.

Deacon, Anglicized from the Gr. δίακονος, *diaconus* (usually derived from *diá* and *κόνος*, q. d. 'dusty from running;' but better from an obsolete *δίκω*, or *δύκω*, "to run;" or hasten; kindred with *diakn*, to pursue; hence, strictly, a runner, i. e. messenger. Buttman, *Lexic.* i, 218-221), a servant (as often rendered), 1. properly, of those who attend on guests at a table, a waiter (John ii, 5, 9; so Polyb. xxxi, 4, 5; Xenoph. *Mem.* i, 5, 2). Among the Greeks these *δίακονοι* were a higher class than the *δοῦλοι*, or slaves (Athen. x, p. 192 b). 2. Generally, and with the name of the master or person served, a minister (as it is usually rendered in the N. T.) (Matt. xx, 26; xxiii, 11; Mark ix, 35; x, 43; so Xenoph. *Cyr.* viii, 3, 8). Also an attendant of Christ, a *disciple* (John xii, 26), of a king (Matt. xxii, 13), and hence of God (Rom. xii, 8). 3. Specially, in relation to the Gospel and the Church, a minister or teacher. (a.) of the person for whom ministers (1 Cor. iii, 5; 2 Cor. iii, 6; vi, 4; 1 Thes. iii, 2; 2 Cor. xi, 23; Col. i, 7; Eph. vi, 21; Col. iii, 7; i, 25; and, by antithesis, of Satan, 2 Cor. xi, 15). (b.) Technically, an officer of the primitive Church, a *deacon* (Phil. i, 1; 1 Tim. iii, 8, 12; iv, 6; see Acts vi, 1-6).

I. Deacons in the N. T.—1. "The office described by this title appears in the N. T. as the correlative of *ἐπίσκοπος*, bishop or presbyter (q. v.). The two are mentioned together in Phil. i, 1; 1 Tim. iii, 2, 8. The union of the two in the Sept. of Isa. lx, 17, may have suggested both as fit titles for the officers of the Christian Church, or have led to the adoption of one when the other had been chosen on independent grounds. The coincidence, at all events, soon attracted notice, and was appealed to by Clement of Rome (1 Cor. xii, 28) as prophetic. Like most words of similar import, it appears to have been first used in its generic sense.

ying subordinate activity (1 Cor. iii, 5; 2 Cor. vi, and afterwards to have gained a more defined position as applied to a distinct body of men in the Christian society" (Smith, s. v.).

The origin of the office of deacon in the Church usually supposed to be described in Acts vi, 1-6. Hellenistic Jews complained that "their widows were neglected in the daily ministrations." This neglect may be ascribed either to "the fact that their widows were not known, being as foreigners of a somewhat backward spirit, or possibly also to some jealousy existing between the proper Hebrews and their kindred from other lands. At first the apostles themselves, who had the charge also of the common funds iv, 35, 37; v, 2), superintended this service, employing intermediate agents, young men of the congregation probably (Acts v, 6, 10), who had given cause for the complaint now mentioned. In proportion, however, as the Church extended, the more impracticable it became for them to give themselves to such outward concerns without wrong to their proper spiritual work.

"It is not reason," said the twelve, "that we should leave the Word of God and serve tables"—that superintend the daily love-feasts and the distribution of alms. In order, therefore, that they might devote themselves wholly to prayer and the preaching of the Gospel, and to provide against wrong and dissatisfaction by a fixed regulation, they proposed the election of seven men of good report, full of the Holy Ghost and of prudence, for this particular service, and set them apart to it solemnly, after they had been chosen by the people, with prayer and the imposition of hands. In the Acts, indeed, these officers are styled simply of *επτά*, the seven (xxi, 8), and not deacons—at least as servants or helpers; but that this was their character we know, partly from the terms *διακονία*, *ακονείν* *πραξίαις*, used of their office (Acts vi, 1, 2), and partly from almost universal exegetical tradition. The ancient Church even held the sacred number seven in this case of obligatory force; and at Rome, for example, there were still as late as the third century only seven deacons, although the number of presbyters amounted to forty" (Schaff, *Apostolic Church*, § 44).

Some writers (e. g. Mosheim, *Comm. cent. i*, § 37) maintain that the "seven" were appointed, not to care for all the poor at Jerusalem, but only for the widows and poor of the Greeks or foreigners. This view supposes that similar officers had previously existed to discharge these functions for the general Church (so Longbeare and Howson, *Life of St. Paul*, i, 467; Whately, *Kingdom of Christ*; Hinds, *Early Christianity*). Stanley (*Apostolic Age*, p. 62 sq.) supposes that "the seven" were not deacons such as we find in the later period of the apostolic age, "though they may possibly have borne the name, and though there was in some respects a likeness between their respective duties." Compare, on the other hand, Schaff, *Apostolic Church*, § 184). Dr. W. L. Alexander, in Kitto's *Cyclopædia* s. v., asserts that it is not easy to justify the assumption that the "seven" were deacons in the later sense. "Nothing can be drawn from the meaning of the word *διακονία* as applied to their functions (ver. 1), or the word *διάκονος*, as if this title had been originally derived from such a 'serving of tables' as is here referred to, because these words are used in the N. T. with the utmost latitude of meaning, so as to include every kind of service rendered to the Church or cause of God on earth—the service of presbyters (2 Cor. xi, 23; Ephes. vi, 21; Col. i, 7, etc.), of evangelists (1 Thess. iii, 2), of apostles (Acts xx, 24; xxi, 19; Rom. xi, 13; 2 Cor. vi, 4, etc.), of prophets (1 Peter i, 12), of angels (Heb. i, 14), of Christ himself (Rom. xv, 8), as well as service in temporal matters. Nor can much weight be attached to patristic testimony on this head, because we have no clear declaration in favor of the position assumed earlier than that of the sixth General

Council (in Trullo), held A. D. 680; all the earlier witnesses speak of the diaconate in connection with spiritual services or the rites of the Church. If, moreover, this was the institution of a permanent office in the Church, it seems somewhat strange that it should disappear entirely from the history of the Church for many years, and come up again, for the first time, in the form of an incidental notice in an epistle written in the latter half of the first century. Taking the narrative in the Acts in its connection with the history of which it forms a part, the appointment of the seven brethren has all the appearance of a temporary expedient to meet a peculiar emergency."

Some writers maintain that the office of the "seven" corresponded to that of the *חזן*, *chazan*, in the Jewish Synagogue, the *ὑπηρέτης*, or "minister," of the N. T. (Luke iv, 20; John vii, 32). This is the opinion of Vitringa (*De Syn. Vet.* p. 895 sq.; Bernard's *Condensed Tr.* p. 87 sq.), whose principle, that the order of the Christian churches was constructed on the model of the synagogues, led him to press the analogy between the two in every possible way. But for this opinion there is no solid support. Vitringa's main principle is itself unsound, for nothing can be more evident than that the apostles proceeded upon no prearranged scheme of Church policy, but instituted offices and appointed usages just as circumstances required; and, as respects the deacon's office, it cannot be shown that one of the duties pertaining to the office of *chazan* in the synagogue belonged to it. As Hartmann remarks (*Engel Verhind. des A. T. seit d. N. p.* 281), the *chazan* was a mere servant whose functions resembled those of our sexton or church officer (Kitto, *Cyclopædia*, s. v.; see also Neander, *Planting and Training of the Christian Church*, Ryland's translation, i, 84 sq.). See SYNAGOGUE.

3. But, whatever view may be taken of Acts vi, it appears clear that the later church office (Phil. i; 1 Tim. iii) developed itself from the office designated in Acts vi, and may be traced back to it. The functions of the deacon were primarily secular, but soon rose into spiritual importance. Hence the "moral qualifications described in 1 Tim. iii as necessary for the office of deacon are substantially the same as those of the bishop. The deacons, however, were not required to be 'given to hospitality,' nor to be 'apt to teach.' It was enough for them to 'hold the mystery of the faith in a pure conscience.' They were not to gain their living by disreputable occupations (*μη αίσχροκτεδείς*). On offering themselves for their work they were to be subject to a strict scrutiny (1 Tim. iii, 10), and, if this ended satisfactorily, were to enter on it. It does not appear to have [necessarily] belonged to the office of a deacon to teach publicly in the church. The possession of any special *χάρισμα* (spiritual endowment) would lead naturally to a higher work and office, but the idea that the diaconate was but a probation through which a man had to pass before he could be an elder or bishop was foreign to the constitution of the Church of the first century. Whatever countenance it may receive from the common patristic interpretation of 1 Tim. iii, 18 (comp. Estius and Hammond, ad loc.), there can be little doubt (as all the higher order of expositors have felt, comp. Wiesinger and Ellicott, ad loc.) that when Paul speaks of the *καλὸς βαθμὸς*, or 'good degree,' which is gained by those who 'do the office of a deacon well,' he refers to the honor which belongs essentially to the lower work, not to that which they were to find in promotion to a higher" (Smith, s. v.). On the other side, Dr. Thomas Scott says (*Comment. on 1 Tim.* iii, 8-18), "The deacons were primarily appointed to dispense the charity of the Church, and to manage its secular concerns. Yet they preached occasionally, or taught in private, or were readers in the public assemblies, and pastors and evangelists were chosen from among them. This interpretation has been contested,

yet it seems to be the apostle's meaning; and, without advertent to modern habits and controversies, it is evident that the due discharge of the primitive office of deacon must tend to qualify men for the ministry."

II. *In the Early Post-Apostolic Church.*—That the duties of the seven deacons were not of an exclusively secular character is clear from the fact that both Philip and Stephen preached, and that one of them also baptized. It is strange, therefore, that the 18th Canon of the Council of Constantinople, in "Trullo," should declare, referring to Acts vi, that the seven deacons had no spiritual function assigned them. Eucumenius (a celebrated Greek writer of the tenth century) gives his testimony to the same effect (*In Act. Ap. vi*, p. 486). But opposed to this opinion is that of some of the fathers of the Christian Church. Ignatius, a martyr-disciple of St. John, and bishop of Antioch († 116), styles them at once "ministers of the mysteries of Christ;" adding that they are not ministers of meats and drinks, but of the Church of God (Ignat. *Ep. ad Trall. n. 2*). Again he says (*Ep. ad Trall. n. 3*), "Study to do all things in divine concord, under your bishop presiding in the place of God, and the presbyters in the place of the apostolic senate, and the deacons most dear to me, as those to whom is committed the ministry of Jesus Christ." Tertullian († 220) classes them with bishops and presbyters as guides and leaders to the laity. He asks (Tertull. *De Fuga*, c. ii): "Quum ipsi auctores, id est, ipsi Diaconi, Presbyteri, et Episcopi fugiunt, quomodo Laicus intelligere poterit?—Cum Duces fugiant quis de gregario numero sustinebit?" Cyprian, bishop of Carthage, A.D. 250 (while referring their origin to Acts vi), styles them ministers of episcopacy and of the Church (Cyp. *Ep. 65*, al. 8, *ad Rogat.*); at the same time he asserts that they were called *ad altaris ministerium*—to the ministry of the altar. Though Jerome in one place speaks of them (*Ep. ad Evang. et Com. Esck. c. 48*) as servants of tables and widows, yet again he ranks them among the guides of the people: still he distinguishes them from the priests of the second order, that is, from the presbyters, by the title of *Servites*. And so, frequently, in the Councils, the names *Sacerdos* and *Levita* are used as the distinguishing titles of presbyter and deacon. The fourth Council of Carthage expressly forbids the deacon to assume any one function peculiar to the priesthood, by declaring, "Diaconus non ad sacerdotium, sed ad ministerium consecratus." (See also 18th Can. Con. Nic.)

His ordination, moreover, differed from that of presbyter both in its form and in the powers which it conferred. For in the ordination of a presbyter, the presbyters who were present were required to join in the imposition of hands with the bishop; but the ordination of a deacon might be performed by the bishop alone, because, as the 4th Canon of the 4th Council of Carthage declares, he was ordained, not to the priesthood, but to the inferior services of the Church. *Duties.*—1. The deacon's more ordinary duty was to assist the bishop and presbyter in the service of the sanctuary; especially was he charged with the care of the utensils and ornaments appertaining to the holy table. 2. In the administration of the Eucharist, that it was the deacon's duty to hand the elements to the people, is evident from Justin Martyr (*Apol. ii*, p. 152), and from Cyprian (*Serm. v*, "De Lapsis"). Not, however, that the deacon had any authority or power to consecrate the elements; for the 15th Can. of the Council of Arles, A.D. 812, forbids this. And the 18th Can. of the Council of Nice orders the deacons not even to administer the Eucharist to priests because of their inferiority. 3. Deacons had power to administer the sacrament of baptism (Tertull. *De Bapt. c. 17*; also Hieron. *Dial. contr. Lucif. c. 4*, p. 189). The Council of Ellberis, Can. 77, plainly acknowledges this right, although the author of the *Apost. Constitutions*, and Epiphanius also, would seem to deny it. 4. The office of the deacon

was not to preach so much as to instruct and catechize the catechumens. His part was, when the bishop or presbyter did not preach, to read a homily from one of the fathers. St. Ambrose, bishop of Milan, A.D. 380, says expressly that deacons, in his time, did not preach, though he thinks that they were all originally evangelists, as were Philip and Stephen. 5. It was the deacon's business to receive the offerings of the people, and, having presented them to the bishop or presbyter, to give expression in a loud voice to the names of the offerers (see Cyp. *Ep. 10*, al. 16, p. 5; Hieron. *Com. in Esck. xviii*, p. 537). 6. Deacons were sometimes authorized, as the bishops' special delegates, to give to penitents the solemn imposition of hands, which was the sign of reconciliation (Cyp. *Ep. 13*, al. 18, *ad Eter.*). 7. Deacons had power to suspend inferior clergy; this, however, was done only when the bishop and presbyter were absent, and the case urgent (*Constit. Apost. viii*, 28). 8. The ordinary duty of deacons with regard to general Councils was to act as scribes and disputants according as they were directed by their bishops. In some instances they acted as proxies for bishops who could not attend in person, but in no instance do we find them voting in a general Council by virtue of their office. But in provincial synods the deacons were sometimes allowed to give their voice, as well as the presbyters, in their own name. 9. The *Apostolical Constitutions* (ii, 57, p. 53) inform us that one of the subordinate duties of the deacon was to provide places in the church for persons as they entered—to rebuke any that might whisper, talk laugh, etc. during divine service. This was a duty which, however, usually devolved upon the subdeacon. 10. But, besides the above, there were some other offices which the deacon was called upon to fill. One of these was to take care of the necessitous, orphans, widows, martyrs in prison, and all the poor and sick who had any claim upon the public resources of the Church. It was also his especial duty to watch the spiritual, as well as the bodily, wants of the people; and wherever he detected evils which he could not by his own power and authority cure, it was his duty to refer them for redress to the bishop.

In general, the number of deacons varied with the wants of a particular church. Sozomen (vii, 19, p. 20) informs us that the Church of Rome, after the apostolic model, never had more than seven deacons. It was not till the close of the third century that deacons were forbidden to marry. The Council of Ancyra, A.D. 344, in its 10th Can., ordains that if a deacon declined at the time of his ordination that he would marry, he should not be deprived of his function if he did marry; but that if he married without having made such a declaration, "he must fall into the rank of laic."

The qualifications required in deacons by the primitive Church were the same that were required in bishops and presbyters; and the characteristics of a deacon, given by St. Paul in his Second Epistle to Timothy, were the rule by which a candidate was judged fit for such an office. The second Council of Carthage, 4th Can., forbids the ordination of a deacon before the age of twenty-five; and both the Civil and Canon Law, as may be seen in Justinian, *Novell. 123*, c. 14, limit his age to the same period.

The Council of Laodicea, A.D. 381, forbids a deacon to sit in the presence of a presbyter, and the 11th Can. of the first Council of Carthage regulates the number of judges at ecclesiastical trials—three bishops upon a deacon, six upon a presbyter, and twelve upon a bishop. This would mark the rank of each of the parties. Originally the deacons had been the helpers of the presiding elder of a given district. When the names of the latter title were divided and the bishop presided, whether as *primus inter pares*, or with a more absolute authority over many elders, the deacons appear to have been dependent directly on him and not on the presbyters, and, as being his ministers, to

and ears of the bishop" (*Const. Apost.* ii, 44), tempted to set themselves up against the elders. The necessity of laws like those of *Conc. Nic. c. Conc. Carth.* iv, c. 87, enjoining greater humility, hence probably the strong language of Ignatius the reverence due to deacons (*Ep. ad Trall.* c. 8; *myra.* c. 8).

I. In the *Modern Church* deacons are found as a act order of the clergy.

In the *Roman Catholic Church* there are subdeacons as well as deacons, both in orders. The *subdeacon's* duties are "to prepare the altar-linen, the sacred vessels, the bread and wine necessary for the holy sacrifice—to minister water to the priest or bishop at the beginning of the hands at mass—to read the epistle—to assist at mass in the capacity of a witness, and see that the priest be not disturbed by any one during its celebration." To the *deacon* "it belongs constantly to accompany the bishop, to attend him when he preaches—to assist him and the priest also during the celebration of the holy mysteries, and at the administration of the sacraments, and to read the Gospel at the time of the mass." . . . "To the deacon also, as agent of the bishop, it belongs to inquire and ascertain who within his diocese lead lives of piety and devotion, and who do not; who attend the holy sacrifice of the mass and the instructions of their pastors, who do not—that thus the bishop, made acquainted by him with these matters, may be enabled to admonish each offender privately, or, should he deem it more conducive to their reformation, to rebuke and correct them publicly. He also calls over the names of catechumens, and presents to the bishops those who are to be promoted to orders. In the absence of the bishop and priest, he is also authorized to expound the Gospel to the people, not, however, from an elevated pulpit, to make it understood that this is not one of his ordinary functions" (*Council of Trent*, sess. xxiii, ch. 17).

There are eighteen *cardinal-deacons* in Rome, who have the charge of the temporal interests and the revenues of the church. A person, to be consecrated a deacon, must be twenty-three years of age (*Council of Trent*, sess. xxiii, c. 17).

In the *Church of England* and in the Episcopal communions in Scotland and North America, a deacon receives ordination by the imposition of hands of a bishop; in consequence of which he can preach, assist at the sacrament of the Lord's Supper, and, generally, may perform any sacred office except consecrating the elements and pronouncing absolution. By the statute of George III, c. 48, it is enacted that no person shall be admitted until he shall have attained the age of twenty-three years complete; but this act is declared to be inoperative to affect the right of granting facilities, exercised by the archbishops of Canterbury and Armagh respectively, viz. to admit at earlier ages; and by 59 George III, c. 60, sec. 1, the two archbishops of the realm, or the bishop of London, or any bishop authorized by any or either of them, may ordain as deacons any persons whom he or they shall deem duly qualified, especially for the purpose of officiating in his majesty's colonies or foreign possessions. But no person so ordained can afterwards hold any living or other benefice in the United Kingdom without the previous consent in writing, under hand and seal of the bishop in whose diocese such benefice, etc. shall be locally situated; nor without like consent of the archbishop or bishop by whose consent he was originally ordained, or of the successor of such archbishop or bishop, in case of his demise or translation; nor without producing a testimony of his good behavior during his residence abroad from the bishop in whose diocese he was officiated, or (if there be not any such bishop) from the governor in council of the colony wherein he may have resided, or from the colonial secretary of state (sec. 2). At the time when the liturgy of the Church of England was composed, it was the deacon's office,

"where provision is so made, to search for the sick, poor, and impotent people of the parish, and to intimate their estates, names, and places where they dwell, unto the curate" (that is, to the rector or vicar having the cure or care of souls), "that by his exhortations they may be relieved with the alms of the parishioners or others" (*Rubric in the form of Ordination*). This was the more ancient office of a deacon, and this rule was made in England before the establishment of the poor-laws, in pursuance of which that care has now devolved upon the churchwardens and overseers of the poor, which last office was specially created for that purpose.

In the *Methodist Episcopal Church* the deacons constitute an order in the ministry. They are ordained by the bishop, without the imposition of hands of the elders. According to the ordination service, "it appertaineth to the office of a deacon to assist the elder in divine service. And especially when he ministereth the holy communion, to help him in the distribution thereof, and to read and expound the Holy Scriptures; to instruct the youth, and, in the absence of the elder, to baptize. And furthermore, it is his office to search for the sick, poor, and impotent, that they may be visited and relieved."

In the *Presbyterian Church* of the United States the "Form of Government" states that "the Scriptures clearly point out deacons as distinct officers in the Church, whose business it is to take care of the poor, and to distribute among them the collections which may be raised for their use. To them also may be properly committed the management of the temporal affairs of the Church" (chap. vi). In some Presbyterian congregations, and in the Free Church, there are deacons regularly ordained to have charge of the funds of the Church. In other Presbyterian churches the office is merged in that of ruling elders.

In *German Protestant churches* the assistant ministers are generally called deacons. If there be two assistants, the first of them is called *archdeacon*. In the German Reformed Church in the United States, the Constitution, ch. iii, art. 2, provides as follows: "The office of the deacons is to collect the alms and other contributions which are designed for the relief of the poor, or the necessities of the congregation; to distribute the alms willingly and conscientiously; and to provide for the support of the ministry of the Gospel." See also the form of ordination in the German Reformed Church.

Among *Congregationalists*, the deacons, besides attending to the temporal concerns of the Church, assist the minister with their advice, take the lead at prayer-meetings when he is absent, etc.

Literature.—Besides the works named in the course of this article, see Neander, *Church History* (Torrey's transl.), i, 184 sq.; Bingham, *Orig. Eccles.* bk. ii, chap. xx; Siegal, *Chr.-kirch. Alterthümer*, i, 498 sq.; Sawyer, *Organic Christianity*, chap. xiii; Dexter, *On Congregationalism*, p. 184 sq.; Hooker, *Eccles. Polity*, bk. v, § 78; Howell, *The Deaconship* (Am. Bapt. Pub. Soc.), Phil. 1846, 18mo; Punched, *Congregationalism*, 1844, part iii.

Deaconess (*ἡ διάκονος; διακόνισσα, diaconissa*), the title of an office of women in the early Church; an office supposed by some to have originated under the apostles, by others to be of later origin.

I. *Deaconesses in the Apostolic Church.*—The title (usually rendered *minister* or "deacon") is found in Rom. xvi, 1, associated with a female name (Phoebe, *οὖσαν διάκονον*), and this has led to the conclusion that there existed in the apostolic age, as there undoubtedly did a little later (Pliny, *Ep. ad Traj.*), an order of women bearing that title, and exercising, in relation to their own sex, functions which were analogous to those of the deacons. On this hypothesis it has been inferred that the women mentioned in Rom. xvi, 6, 12, belonged to such an order (Herzog, *Real-*

Encycl. iii, 368). The rules given as to the conduct of women in 1 Tim. iii, 11; Titus ii, 3, have in like manner been referred to them (Chrysostom, Theophylact, Hammond, Wiesinger, ad loc.). Some writers (e. g. Rothe; Schaff, *Apost. Church*, § 135) suppose that the "widows" of 1 Tim. v, 3-10, were deaconesses. Herzog, on the other hand, holds that the passages in Timothy cannot be applied to "deaconesses." Dr. W. L. Alexander, in Kitto's *Cyclopaedia* (s. v.), maintains that Rom. xvi, 1, does not show that Phoebe held any official relation to the Church; for all that appears, she may have been simply the doorkeeper or cleaner of the place of worship. Plumtre (in Smith's *Dictionary*, s. v.), says that "it seems hardly doubtful that writers have transferred to the earliest age of the Church the organization of a later. It was of course natural that the example recorded in Luke viii, 2, 3, should be followed by others, even when the Lord was no longer with his disciples. The new life which pervaded the whole Christian society (Acts ii, 44, 45; iv, 81, 82) would lead women as well as men to devote themselves to labors of love. The strong feeling that the true *ἀφροξία*, or service of Christians, consisted in 'visiting the fatherless and the widow,' would make this the special duty of those who were best fitted to undertake it. The social relations of the sexes in the cities of the empire (comp. Grot. on Rom. xvi, 1) would make it fitting that the agency of women should be employed largely in the direct personal application of Christian truth (Titus ii, 3, 4), possibly in the preparation of female catechumens. Even the later organization implies the previous existence of the germs from which it was developed. It may be questioned, however, whether the passages referred to imply a recognised body bearing a distinct name. The 'widows' of 1 Tim. v, 3-10, were clearly, so far as the rule of ver. 9 was acted on, women who were no longer able to discharge the active duties of life, and were therefore maintained by the Church, that they might pass their remaining days in 'prayers night and day.' The conditions of ver. 10 may, however, imply that those only who had been previously active in ministering to the brethren were entitled to such a maintenance." See also Ludlow, *Woman's Work in the Church*, ch. i (Lond. 1866).

II. *Deaconesses in the early Church.*—The Apostolical Constitutions distinguish "deaconesses" from "widows" and "virgins," and prescribe their duties. A form of ordination for deaconesses is also given (bk. viii, c. 19, 20), in which the bishop prays as follows: "Eternal God, Father of our Lord Jesus Christ, Creator of man and of woman; thou who didst fill with thy Spirit Miriam, Deborah, Hannah, and Huldah; thou who didst vouchsafe to a woman the birth of thy only-begotten Son; thou who didst, in the tabernacle and in the Temple, place female keepers of thy holy gates—look down now also upon this thy handmaid, and bestow on her the Holy Ghost, that she may worthily perform the work committed to her, to thy honor, and the glory of Christ" (Chase, *Constitutions of the Apostles*, p. 225 (N. Y. 1848)).

In the Eastern Church the notices of deaconesses in the first three centuries are few and slight, although Origen († 258) speaks of the ministry of women in the Church as both existing and necessary.

In the Western Church the notices are fuller and more clear. Pliny the younger (about A.D. 104) appears to refer to deaconesses in his letter to Trajan, in speaking of the question by torture of "two maids who were called ministers" (ex duabus ancillis quas ministras dicebantur). Tertullian (220) speaks of them often, and prescribes their qualifications (see below). In the fourth and fifth centuries all the leading Eastern fathers refer to deaconesses; e. g. Basil († 379), Gregory of Nyssa († 396), Chrysostom († 407), Theodoret († 457), Sozomen (cir. 439). Theodoret (*Eclcs. Hist.* iii, 14, p. 652) calls Publia, who lived at

the time of Julian, ἡ Διάκονος—*deaconess*. The men (iv, 14, 59) speaks of a certain deaconess who had been excluded Church fellowship because of her broken her vows.

It was a rule that the deaconesses must be single. Tertullian (*ad Uxorem*, i, 7; *de Virgine velata*, c. 1) says, "The discipline of the Church and apostolic usage forbid that any widow be elected unless she has been married but one husband." *Virgines*, it is sometimes admitted, but this was the exception. Deaconesses must have borne children. This rule arose from the belief that no person but a mother could sympathize with those sympathizing affections which ought to animate the deaconess in her duties. The early Church was very strict in enforcing the rule which prohibited the election of any to be deaconesses who had been twice married, though lawfully and successively to two husbands, one after the other. Tertullian (*de Virgine velata*, c. 1) says, "The apostle requires them to be (ἀσκήσασθαι) trained to the service of one man" (*ad Uxorem*, iv, 7). Others, however, give the words of the apostle another meaning. They suppose him to exclude those widows who, having divorced themselves from their former husbands, had married again (see Suicer, *Theaurus*, i, 864, 867). It is disputed whether they were ordained by the laying on of hands, but the Apostolical Constitutions (c. 19) declare that such was the case, and the *Acts of Chalcedon* (sess. xv) forbids the ordination of a deaconess under forty. Still they were not considered to any ministerial function; so Tertullian (*Præscript*, 41, "Let no woman speak in the Church, nor teach, nor baptize, nor offer" (that is, administer the Eucharist), "nor arrogate to herself any ministerial function, lest two should claim the lot of the priest's office." Their duties were to take care of the sick and poor, and to minister to martyrs and prisoners, to whom they could more easily gain access than the deacons; to instruct catechumens, and to assist at the baptism of women; to exercise a general oversight over the female members of the Church; this not only in public, but in private, making occasional reports to the bishops and presbyters. How long this office continued is uncertain. It was, however, discontinued everywhere at once. It was first abrogated in France by the Council of Orange, A.D. 441. It continued in the Roman Church for some time after this, and gradually disappeared; but in the Greek Church it did not become extinct till the twelfth century.

III. *In the modern Church.*—It must ever be regarded as a misfortune in the Reformation that this office was not restored. "Is it not reasonable that the office, which is so well adapted to the naturally female character of the female sex, should be wholly excluded from our list of assistants in the Church?" (*Robinson's Cabinet*, p. 386.) Its restoration was, however, seriously thought of, and even attempted, in the Reformed Church at an early period of the Reformation, namely, when the Netherland "churches under the Cross" were founded through the synod at Wesel and Emden, 1568 and 1571. Its restoration in the Reformed Church was urged on the synod of Wesel as it already actually existed at the time among the Helvetic Brethren and the strict Anabaptists, at least in the large congregations. The subject came before the synod from the congregation at Wesel through the Classis of Wesel. That congregation had decided to restore it—had, in fact, restored it in its bosom, and now asked the indicators for approval. The Classis of Wesel, before which the matter first came, decided that the restoration of the office as inaugurated in the congregation at Wesel shall stand till the final decision is had, but deferred final action until their next meeting. In 1580 the same classis decided that "if this office, which had fallen into disuse and decay in the Church of God, is again to be restored, then it shall be established in the same form, and with the

character belonging to it, as described by the apostle Paul, namely, widows, and not married women shall be chosen for that purpose." Classis advised the restoration of the office, and referred the matter to the next provincial synod, that by its authority it might also be restored in other localities. Accordingly, by the proper course, it came before the General Synod at Middleburg in 1581, which synod unfortunately decided against it "on account of various inconveniences which might arise out of it; but times of pestilence, and other sicknesses, when any relief is required among sick women which would be solicited to deacons, they ought to attend to this through their wives, or others, whose services it may be proper to engage" (Max Göbel, *Geschichte des christlichen Vereins in der rhein-westphälischen Ev. Kirche*, i, 418, 419). Here this interesting movement seems to have ended, as there is no further historical trace of it.

The Puritans in England in the sixteenth century recognized deaconesses, as appears by the following tract from the "Conclusions" drawn up by Cartwright and Travers, and given by Neal, *History of the Puritans*, vol. i, ch. vi: "Touching deacons of both men, viz. men and women, the Church shall be admonished what is required by the apostle, and that they are not to choose men of custom or course for their riches, but for their faith, zeal, and integrity; and that the Church is to pray in the mean time to be directed that they may choose them that are meet. Let the names of those that are thus chosen be published by the next Lord's day, and after that their duties to the Church, and the Church's duty towards them; then let them be received into their office with the general prayers of the whole Church."

"The advantages resulting to a Christian community from such an order are too obvious to require exposition. It has been a serious misfortune to the Church at large that the office has been allowed to fall into disuse; and the wide-spread institution at the present day in the churches of Great Britain and America of ladies' district-visiting societies, Dorcas societies, etc. satisfactorily shows the necessity of practically supplying, to some extent at least, the want of this primitive office. There is a movement going on at present for the introduction of the order of deaconesses into the Church of England" (Chambers, *Encyclopædia*, s. v.). Its prospects of success would be greater but for the monastic tendencies of the so-called "sisterhoods" organized by the Puseyites, e. g. Miss Sellon's. This subject has been lately revived in the German Reformed Church in America. On Christmas, 1866, Hon. J. Dixon Roman, of Hagerstown, Md., gave to the congregation of that city \$5000, and with it sent a proposition to the Consistory that, according to his wish, "three ladies of the congregation shall be chosen and ordained to the order of deaconesses in this congregation, with absolute control of the income of said fund, for the purposes and duties as practised in the early days of the Church." This, and the action of Lebanon Classis, which in 1867 requests the synod "to take into consideration the propriety of restoring the apostolic office of deaconesses," will bring this plain question before the highest judiciary of the Church.

In the Roman Catholic Church there are various sisterhoods answering in some degree to the ancient order of deaconesses, but without ordination; such as the Beguines, the Gray Sisters, the Sisters of Charity, Sisters of Mercy, etc. (see Ludlow, *Woman's Work in the Church*, ch. iii).

The first modern reorganization of the work of deaconesses on a large scale was begun in 1835 by pastor Fliedner, of Kaiserswerth, Prussia. An infirmary was established, to be served by Christian women, unmarried or widows. He required of all who would become deaconesses that they should be "willing to be servants of Christ alone, to devote their time and faculties

entirely and exclusively to him, and not to look forward for pecuniary emoluments or honors of the world, nor yet to merit salvation by their works, but to do the work of charity and self-denial out of gratitude to him who hath redeemed their souls, and merited their salvation. After their probationary period they engage themselves to serve at least five years. But even during this time they are allowed to leave if nearer personal or family duties should make them wish for a change of situation." Many women obeyed the call, the infirmary grew rapidly into importance, and auxiliary societies were formed throughout Prussia. The institution spread into other parts of Europe, and there are now orphan-houses and hospitals under its charge at Berlin, Dresden, Frankfurt, Worms, Cologne, Elberfeld, London, and other places. In 1866 the institution had 189 stations; there were 491 sisters, viz. 311 deaconesses, and 180 probationers. The mother institution has (1) a seminary to train young females as teachers for infant and other schools; (2) an orphan asylum; (3) a training-school of nurses, and for visitors to prisons, etc. The whole expense is borne by voluntary subscriptions. A branch was established at Pittsburg, Pa., in 1849 by pastor Fliedner in person. Mrs. Fry, after a visit to Kaiserswerth, established in Bishopegate, London, an "Institution for Nursing Sisters," which still exists. A deaconesses' institute was organized at Paris in 1851, and others followed in France and Switzerland (see Ludlow's article in the *Edinburgh Review*, 1848, p. 228). For other institutions in England, and for information on the general subject, see Howson, *Deaconesses, or the official Help of Women in parochial Work* (Lond. 1862), and especially Ludlow, *Woman's Work in the Church*. See also Bingham, *Orig. Eccles.* bk. ii, ch. xxii; Siegel, *Handbuch der christl. Aelterthümer*, i, 491 sq.; Augusti, *Handb. der christl. Archaeologie*, vols. i and iii; Ferraris, *Prompta Bibliotheca*, iii, 172; Coleman, *Ancient Christianity*, ch. xxv; Neander, *Ch. Hist.* i, 156; ii, 158 (Torry's transl.); Schaff, *Apostolic History*, § 135; *ibid.*, *History of the Christian Church*, ii, § 52; *Mercersburg Review*, xiv, 190; *Am. Quart. Ch. Review*, July, 1862, art. iii.

Dead (properly some form of מֵת, *Meit*). See BURLAL. When a Hebrew died in any house or tent, all the persons and furniture in it contracted a pollution which continued seven days (Num. xix, 14-16). All who touched the body of one who died, or was killed in the open fields; all who touched men's bones, or a grave, were unclean seven days. To cleanse this pollution, they took the ashes of the red heifer, sacrificed by the high-priest on the day of solemn expiation (Num. xix, 1-22); on these they poured water in a vessel, and a person who was clean dipped a bunch of hyssop in the water, and sprinkled with it the furniture, the chamber, and the persons, on the third day and on the seventh day. It was required that the polluted person should previously bathe his whole body, and wash his clothes, after which he was clean. Since the destruction of the Temple, the Jews have ceased generally to consider themselves as polluted by a dead body. See CORPSE. On the play upon the two senses of the word in its literal and spiritual application in Matt. v, 22, see the *Dissertatio* of Schicht (Aldt. 1770). See DEATH.

The word rendered "dead" in Job xxvi, 5; Psa. lxxxviii, 10; Prov. ii, 18; ix, 18; xxi, 16; Isa. xiv, 9; xxvi, 14, 19, is מָוֶת, *meit*, 'rephaim'; derived from מָוֶת; having, according to Gesenius, the sense of *silent*, but, according to Fürst, meaning *dark*; in either case denoting the shades, names, or disembodied spirits of the under world. See SHEOL.

DEAD, BAPTISM FOR. See BAPTISM FOR THE DEAD.

Dead Sea (*mare mortuum*, Justin, xxxvi, 8, 6;

θάλασσα ἡ νεκρά, Pausan. v, 7, 8; Galen. *Simpl. Med.* iv, 20), a name applied since the second century to the *Asphaltic Lake* (ἡ Ἀσφαλτιτὶς λίμνη, as Josephus, Diodorus Siculus, and Ptolemy, v, 16, 8, call it; or simply ἡ Ἀσφαλτιτὶς, War, iv, 8, 2; more distinctly λίμνη ἀσφαλτοφόρος, Ant. xvii, 6, 5; Pliny's *Asphaltites lacus*, or simply *Asphaltites*), from its supposed noxious properties. In the Bible it is called the **SALT SEA** (הַיָּם הַמֶּלַח, Gen. xiv, 8; Num. xxxiv, 12, etc.), the *Sea of the Plain*, or Arabah (הַיָּם הַרְבֵּי הַפְּתִיחַ, Deut. iii, 17; iv, 49, etc.), or the *Front (Eastern) Sea* (הַיָּם הַרְבֵּי הַפְּתִיחַ הַיָּבֵשׁ, Ezek. xlvi, 18; comp. ver. 8; Joel ii, 20; Zech. xiv, 8). By the Arabs it is termed *Bahr Lut*, "the Sea of Lot" (Abulfeda, *Tab. Syr.* p. 156). It is the remarkable lake or internal sea formed by the filling up of the old basin of the Vale of Siddim (Gen. xiv, 8), on the south-east border of Palestine (Num. xxxiv, 8, 12; Deut. iii, 17; comp. Josh. xii, 8), especially in the same quarter of the tribe of Judah (Josh. xv, 2, 5) into which the Jordan empties (Josh. iii, 16), 800 stadia from Jerusalem (Joseph. Ant. xv, 6, 2). Josephus (War, iv, 8, 4) gives its length as 580 stadia, or 10 to 11 miles; its breadth as 160 stadia, or 2 to 8 miles; and its circumference as 6 days' journey (see Setzein in Zach's *Mo-*

natl. Corresp. xviii, 440; the estimates of Flavius and Diod. Sic. xix, 98, are erroneous). It is lake-necked or sickle-form at the southern end, with a peninsula at the eastern side. See BAY. The east-west shores are steep with naked limestone [see GORDI], but the southern shore ends in a marsh. The south-west is a range of salt hills, and on the east a considerable plain. See SALT, VALLEY. The water, which lies far below the level of the Mediterranean, is clear, but uncommonly salt and of great density (Joseph. War, iv, 8, 4; Jos. in Canisii *Lectio. Antig.* ii, 1; Pliny, v, 15). It contains no living creature, neither fish, shells, or plants, and when fishes from the Jordan get into they die and float upon the surface (Diod. Sic. xix, 98; Jerome on Ezek. xlvi, 9; Cotovic. *Itin. p. 13*). The shore is covered with a dark offensive mud, which a strong saline incrustation forms, and is occasionally interspersed with lumps of bitumen that fall off from the cliffs or disgorged from the bottom (Rehardt, ii, 664). A pretty thick fog has been observed especially in the morning, by travellers (Shaw, p. Volney, i, 240), as enveloping the lake (comp. v, x, 7; Philo, *Opp.* xxi, 143); but, situated as it is, a deep caldron-like spot, the air is usually excessively sultry, and so filled with saline effluvia as to be so detrimental to animal life (*Tact. Hist.* v, 6) and sometimes been represented (Maundrell, p. 116) as an eternal stillness reigns around, unbroken by wind, or animated cry. The marks of volcanic agency are strewn about (Felsecker, *Paläst.* ii, 853), which, with the warm springs on the shore [see CALLIRHOË], the asphaltic vapors and floating substances (Strabo vi, 764), give evidence of the plutonic catastrophe (comp. Gen. xiv, 10) which covered the guilty cities of the plain (Gen. xix); and it is popularly believed that these ruins may still be discerned beneath its vice (Joseph. War, iv, 8, 4), though now sunk below the former level (Reland, *Paläst.* p. 264 sq.). See SIDDIM. It was anciently believed that the immense volume of water poured in by the Jordan found an outlet by subterranean canals into the Mediterranean (Diod. Sic. xix, 98); but it is now ascertained that this is impossible, and that evaporation is sufficient to account for the maintenance of the usual height in the lake (Bachiene, I, i, 121). See generally Fabri, *Descr. géol.* ii, 155 sq.; Oedmann, *Samml.* iii, 125; Hamester, i, 447; Büsching, *Erdbeschr.* V, i, 322 sq.; Wähner, *Itin. Marii Asphalt.* (Helmst. 1712); Michaelis in his *Comment.* 1758-62 *oblat.* (Brem. 1774), p. 61 sq.; Manser, *Geogr.* VI, i, 332; Ritter, *Erdbeschr.* xvi, 381 sq.; Schwarz, *Paläst.* p. 41; Thomson, *Land and Book* ii, 449; Kelly's *Syria*, p. 398; J. Kempe, *De insule Marii Mortui* (Holm. 1751).—Winer, ii, 78. See SEA.



Map of the Dead Sea.

DEAD, BAPTISM OF THE. See BAPTISM, vol. i, p. 652, col. 2.

DEAD, BURIAL OF THE. See BURIAL; FUNERAL.

DEAD, PRAYERS FOR THE, a custom that arose in the Church at an early period. Tertullian (230) remarks (*De Corona Milit.* ch. iii) that it is the practice for a widow to pray for the soul of her deceased husband. He also speaks (*De Monogam.* c. x) of "obligations" made for the dead on the anniversary of their martyrdom. Origen († 254) speaks of Christians "making mention of saints in their prayers" (lib. ix in Rom. xii). Arnobius (cir. 300) says that Christians pray for pardon and peace on behalf of the living and the dead (*adv. Gentes*, iv). Cyril of Jerusalem even declares it to be a considerable advantage for the souls of the dead to be prayed for (*Cat. Mystag.* v, 6). The same custom is found in many of the ancient liturgies. Chrysostom († 407) says of the wicked dead, "they are to be succored with prayers, supplications, alms, and oblations." While this was the common practice, it had no reference to the notion of a purgatory.

of the fathers regarded such prayers as little than a thanksgiving, a commendation of souls deceased to the mercy of God, and a commendation of their spiritual excellencies. Still there is doubt that not a few of the fathers believed that souls of departed believers were not taken at to heaven, but were in some separate places or Paradise—out of which the fervent prayers of the living might help to remove them. So that ideas of purgatory sprang out of such views in long space of time. Nevertheless, it is not true, Romanists assert, that prayers for the dead necessarily imply a belief in purgatory. Almost all the Jewish writers on purgatory refute this; e. g. *Burton's 39 Articles*, art. xxii; Stillingfleet, *Defence of*, p. 648; Jeremy Taylor, *Dissuasive from Popery*; Hier., *Eccles. Hist. of Great Britain*, v, 288 sq.

In the Church of England burial service of 1549, under Edward VI, one prayer was, "We commend thy hands of mercy, most merciful Father, the soul of his our brother departed . . . that when the judgment shall come, which thou hast committed to thy beloved Son, both this our brother and we may be found acceptable in thy sight, and receive thy blessing." "Almighty God, we give thee hearty thanks for this thy servant, whom thou hast delivered from the miseries of this wicked world, from the body death and all temptation; and, as we trust, hast bought his soul, which he committed unto thy holy hands, into sure consolation and rest: Grant, we beseech thee, that at the day of judgment his soul and the souls of thy elect, departed out of this life, may rest with us, and we with them, fully receive thy promise, and be made perfect altogether, through the glorious resurrection of thy Son Jesus Christ our Lord."

And the next prayer was, "O Lord, with whom do rest the spirits of them that be dead, and in whom are souls of them that be elected, after they be delivered from the burden of the flesh, be in joy and felicity; grant unto this thy servant that the sins which he committed in this world be not imputed unto him, but that he, escaping the gates of hell, and pains of eternal darkness, may ever dwell in the region of light, with Abraham, Isaac, and Jacob, in the place where there is no weeping, sorrow, nor heaviness; and when that dreadful day of the general resurrection shall come, make him to rise also with the just and righteous, and receive this body again to glory, when made pure and incorruptible." The prayer was ultimately changed into the thanksgiving form in which it now appears in the Prayer-book: "After the offertory in the Eucharist is said, and the oblations of bread and wine, with the alms for the poor, are placed upon the table, the minister addresses this exhortation to the people: 'Let us pray for the whole state of Christ's Church militant here in earth.' The latter part of this sentence is wanting in Edward's first book. The words 'militant here in earth,' which were designed expressly to exclude prayer for the dead, were inserted in the second book, in which that part of this prayer, which contained intercession for the dead, was expunged. It was the intention of the divines who made this alteration to denote that prayers are not to be offered up for the dead, whose spiritual welfare is already accomplished; but for those only who are yet 'fighting the good fight of faith,' and are consequently in a capacity of needing our prayers" (Shepherd, cited by Hook, *Church Dictionary*, s. v.). Protestants reject prayers for the dead as having no ground either in Scripture or reason.—Bingham, *Orig. Eccles.* bk. xv, ch. iii, § 15; Riddle, *Christian Antiquities*, p. 277 sq.; Coleman, *Ancient Christianity*, ch. xxv; Browne, *On 39 Articles*, art. xxii; Palmer, *Orig. Liturgica*, ch. iv, § 10; *Theol. Studien u. Kritiken*, 1866, ii, 396.

Deaf (אָר, *cheresh*; κωφός, both, especially the latter, implying dumbness also). Moses extended the

protection of a special statute to the deaf mute: "Thou shalt not curse the deaf" (Lev. xix, 14). This enactment not only absolutely prohibited the reviling of these unfortunates, but might also be understood figuratively, as if Moses recommended that kindness and instruction should be shown to them (Isa. xxix, 18, 35; Matt. xi, 5; Mark vii, 32). See DUMB.

Deal, a word often employed by our translators in the sense of *part*, with fractional numbers ("tenth deal," Exod. xxix, 40, etc.; like "a great deal"), but having no special equivalent in the original. See NUMBER.

Dealtry, WILLIAM, D.D., F.R.S., was born in Yorkshire in 1776, educated in Catharine Hall and Trinity College, Cambridge, where he was second wrangler in 1796 and fellow in 1798. He afterwards became professor of mathematics in the East India College, rector of Clapham in 1818, chancellor and prebendary of Winchester in 1830, and finally archdeacon of Surrey in 1845. He died in 1848. His principal publications are, *A Discourse on the Duty and Policy of propagating Christianity* (Lond. 1818, 8vo); *Sermons* (Lond. 1828, 8vo); *Obligations of the national Church* (Lond. 1838, 8vo); *The Foundation of the Faith* (Lond. 1846, 8vo).—Darling, *Cyclop. Bibliographica*, i, 882.

Dean (*decanus*, from *deka*, ten), an ecclesiastical title which has had several applications. (1.) The oldest use of it was to designate an officer in the ancient monasteries, in which every ten monks were subject to one called the *decanus*, or dean, from his presiding over ten; and every hundred had another officer called *centenarius*, from his presiding over one hundred. The business of the dean was to exact every man's daily task, and to bring it to the *conomus*, or steward of the house, who himself gave a monthly account to the father of all. The word dean is occasionally used in early writers for archpresbyter. (2.) In the Church of England there are two sorts of deans: 1st, the *dean of a cathedral*, who is an ecclesiastical magistrate, next in degree to the bishop. He is chief of the chapter, and is called a dean (*decanus*) because he formerly presided over ten prebendaries or canons. He is by law a sole corporation—that is, he represents a whole succession, and is capable of taking an estate as dean and conveying it to his successors. 2d, *rural deans*, whose office is of ancient date in the Church of England, long prior to the Reformation, and which many of the bishops are now reviving. Their chief duty is to visit a certain number of parishes, and to report their condition to the bishop. There are two means of creating deans, because there are two foundations of cathedral churches in England, the old and the new. Those of the old foundation are appointed to their dignity much like bishops, the king first issuing his *commissio d'elire* to the chapter, the chapter then choosing, and the bishop confirming and giving his mandate to install them. (3.) The word *dean* is also applied in England to the chief officers of certain peculiar churches or chapels, as the dean of the king's chapel, the dean of the arches, the dean of St. George's Chapel at Windsor, and the dean of Bocking, in Essex. (4.) The *dean and chapter* constitute the governing body of a cathedral. A chapter consists of the dean, with a certain number of canons or prebendaries, heads of the church—*capita ecclesie*. They are the council of the bishop, to assist him with their advice in affairs of religion as well as in the temporal concerns of his see. When the rest of the clergy were settled in the several parishes of each diocese, these were reserved for the celebration of divine service in the bishop's own cathedral; and the chief of them, who presided over the rest, obtained the name of *decanus*, or dean, being probably at first appointed to superintend ten canons or prebendaries. The dean and chapter are the nominal electors of a bishop. (5.) The *dean* of a college faculty

is its presiding officer.—Siegel, *Handbuch d. christl. Al-terthümer*, i, 485; Hook, *Church Dictionary*, s. v. See CHAPTER.

DEAN OF THE CARDINALS. See CARDINALS.

DEAN OF THE CHAPEL ROYAL (Scotland), an office held by three clergymen of the Established Church, to which they are appointed by the crown. The duties are nominal, being limited to an occasional sermon before her majesty when in Scotland, and attendance at the election of the representative peers. Recent appointments, however, have been conferred in connection with chairs in the University of Edinburgh which are not otherwise endowed. The title of dean is somewhat out of place in the Church of Scotland, where the rule of Presbyterian parity is established. It is a remnant of Episcopacy, which the Church courts have never had occasion to challenge, as the deans do not sit or act in that capacity, and have scarcely any ecclesiastical duties to perform.—Chambers, *Encyclo-pædia*, s. v.

Dearth (usually דָּבָר, *hunger*; λιμός, *famine*; as both are elsewhere rendered; but in Jer. xiv, 1, דָּבָר, *distress*, sc. of rain, drought, as in Jer. xvii, 8), a scarcity of provisions. Although Palestine is a very fruitful land, yet a famine naturally followed a lack of crops, especially when the rain failed (1 Kings xvii; Josephus, *Ant.* xv, 9, 1), or the country was visited, among the not infrequent land-plagues (2 Sam. xxiv, 13; Psa. xxxiii, 19; Ezek. xxxv, 29; Jer. xiv, 13, 15), with swarms of locusts (q. v.); and we read of dearths in the historical narratives not only in the patriarchal period (Gen. xii, 10; xvii, 4, 13), and the era of the judges (Ruth i, 1), when the soil was not regularly farmed, but also in the time of the kings (2 Sam. xxi, 1; 1 Kings xviii, 2; 2 Kings iv, 38; Jer. xiv, 1), and, indeed, the destitution sometimes continued more than one year together (2 Sam. xxi, 1). In such cases the inhabitants availed themselves of supplies from the neighboring Egypt (Gen. xii, 10; xli, 1 sq.; xliii, 1 sq.; Josephus, *Ant.* xv, 9, 2; xx, 2, 6; 5, 2), although this region likewise suffered in like manner whenever the Nile failed to reach its usual overflow (Gen. xli, xliii). Under the Roman rule an extensive famine prevailed (Acts xi, 12) in the time of the emperor Claudius (q. v.), which occurred during several years in different provinces of the empire, and reached Palestine at the end of the fourth year of his reign (Joseph. *Ant.* xx, 2, 6; comp. iii, 15, 8). See AGABUS. Josephus mentions an earlier famine (*Ant.* xv, 9, 1), that took place in the thirteenth year of Herod the Great, which resulted from drought, and was followed by pestilence.—Winer, ii, 610. See FAMINE.

Death (properly מוֹת, *θάνατος*). No logical definition of death has been generally agreed upon. This point was much contested in the 17th century by the Cartesian and other theologians and philosophers. Since death can be regarded in various points of view, the descriptions of it must necessarily vary. If we consider the state of a dead man as it strikes the senses, death is the cessation of natural life. If we consider the cause of death, we may place it in that permanent and entire cessation of the feeling and motion of the body which results from the destruction of the body. Among theologians, death is commonly said to consist in the separation of soul and body, implying that the soul still exists when the body perishes. Among the ecclesiastical fathers, Tertullian (*De Anima*, c. 27) calls it "the disunion of the body and soul." Cicero (*Tusc. Dis.* i) defines death to be "the departure of the mind from the body." The passage Heb. iv, 12, is sometimes cited on this subject, but has nothing to do with it. Death does not consist in this separation, but this separation is the consequence of death. As soon as the body loses feeling and mo-

tion, it is henceforth useless to the soul, which is there separated from it. See DEAD.

Scriptural representations, names, and modes of respecting death.—(1.) One of the most common in O. T. is to return to the dust, or to the earth. Hence the phrase the dust of death. It is founded on the resolution in Gen. ii, 7, and iii, 19, and denotes the dissolution and destruction of the body. Hence the sentiment in Eccles. xii, 7, "The dust shall return to earth as it was, the spirit unto God, who gave it."

(2.) A withdrawing, exhalation, or removal of breath of life (Psa. civ, 29). Hence the command to "give up the ghost," etc.

(3.) A removal from the body, a being absent from the body, a departure from it, etc. This death is founded on the comparison of the body to a tabernacle in which the soul dwells during this life. Death destroys this tent or house, and commands to travel on (Job iv, 21; Isa. xxxviii, 12; Ps. lxxv, 35). Hence Paul says (2 Cor. v, 1), "our earthly habitation this tabernacle" will be destroyed; and Peter of death a "putting off of this tabernacle" (2 Pet. i, 14). Classical writers speak of the soul in the same manner. So Hippocrates and Æschines. Comp. Cor. v, 8, 9.

(4.) Paul likewise uses the term ἐκείνο, *his own self*, in reference to death (2 Cor. v, 1) because the body is represented as the garment of the soul, as Plato calls it. The soul, therefore, as before it is in the body, is clothed, and as soon as it is disembodied is naked.

(5.) The terms which denote sleep are applied in the Bible, as everywhere else, to death (2 Cor. v, 1; Psa. lxxvi, 5; Jer. li, 29; John xi, 13 sq.). Now this language used exclusively for the death of the pious, as some pretend, though this is its primary use. Homer calls sleep and death twin brothers (xvi, 672). The terms likewise which signify to lie down, to rest, also denote death.

(6.) Death is frequently compared with an exit from a departure, a going away. Hence verbs of this import signify to die (Job x, 21; Psa. xxxix, 4). The case is the same in the New Testament (Matt. xxv, 24), and even among the classics. In this context we may mention the terms ἀναλύειν and ἀπολύειν (Phil. i, 23; 2 Tim. iv, 6), which do not mean dissolution, but *dissensus* (comp. Luke xii, 36).

Death, when personified, is described as a ruler or tyrant, having vast power and a great kingdom, over which he reigns (Job xviii, 14). But the ancients also represented it under some figures which are not common among us. We represent it as a man with a scythe, or as a skeleton, etc.; but the Jews, before they went into exile, frequently represented death as a hunter who lays snares for men (Psa. xviii, 5, 6; xci, 8). Like the exile they represented him as a man, or sometimes as an angel (the angel of Death), with a cup of poison which he reaches to men. See DISTRONER. From this representation appears to have arisen the phrase, which occurs in the New Testament, to taste death (Matt. xvi, 28; Heb. ii, 9), which, however, in common speech, signifies merely to die, without reminding one of the origin of the phrase. The case is the same with the phrase to see death (Psa. lxxxix, 48; Luke ii, 26).—Kitto, s. v. See Knapp's *Christian Theology*, Dr. Wood; Walther, *De origine phrasium* "videre et gustare mortem" (Giess. 1745).

The "gates of death" (Job xxxviii, 17; Psa. li, cvii, 18) signify the grave itself; and the "shadow of death" (Jer. ii, 6) denotes the gloomy silence of the tomb. See Wemyss's *Clavis Symbolica*, s. v.; *Leibniz De vocibus*, מוֹתָם, *σκία θανάτου* (Vitemb. 1730).

Death may be considered as the effect of sin (Rom. v, 12). In Hebrews ii, 14, Satan is said to have the power of death; not that he can, at his pleasure, inflict death on mankind, but as he was the instrument of

t bringing death into the world (John viii, 44), and he may be the executioner of God's wrath on impenitent sinners where God permits him. Death is once (Heb. ix, 27), yet certain (Job xiv, 1, 2), although uncertain as to the time (Prov. xxvii, 1); universal (Gen. iii, 19); necessary, in order that God's tice may be displayed and his mercy manifested; irable to the righteous (Luke ii, 28-30). The fear death is a source of anxiety and alarm to many, l to a guilty conscience it may indeed be terrible; to a good man it should be obviated by the coneration that death is the termination of every ible; that it puts him beyond the reach of sin and aptation; that God has promised to be with the teous, even to the end (Heb. xiii, 5); that Jesus rist has taken away the sting (1 Cor. xv, 55, 56); l that it introduces him to a state of endless felicity Cor. v, 8).

Death, when applied to the animal nature, properly nifies a dissolution or failure of all its powers and ctions; so, when applied to the spiritual nature, or ls of men, it denotes a corresponding disorder there-a being spiritually dead in trespasses and sins (Rom. i, 6; Eph. ii, 1, 3; Col. ii, 13; Jude 12).

The term death is metaphorically applied to denote utter failure of customary functions, so that the ing spoken of can no longer act according to its na-re. Thus, in Amos ii, 2, "Moab shall die with tult"—that is, the king and government shall lose air power, and the nation be brought into subjection d slavery. So in Rom. vii, 8, "Without the law, a was dead"—that is, without the law, sin does not ert its power; and, on the other hand, it is said (ver. 9, "Sin revived and I died"—"Sin got strength to t, and I lost my power to resist. I was not the same an as before; sin destroyed my power."

The "second death" (Rev. ii, 11) is so called in re-ect to the natural or temporal as coming after it, and nplies everlasting punishment (Rev. xxi, 8).

DEATH, THEOLOGICAL ASPECTS OF. (On this topic we give Henderson's article in Fairbairn, *Imperi-l Bible Dictionary*, i, 418 sq., with slight modifications nd omissions.)

"Death may be defined as the *termination of life*. beyond question, it had been possible for God, if such ad been his pleasure, to have made all creatures un-ler a law of life. Scripture assures us that man at east was at first placed conditionally under this law. Here is, however, decisive evidence that, from the be-ginning, all other terrestrial life was constituted un-der the law of death. The reproductive and assimilating rgans and powers common to all living creatures, and he destructive organs, instincts, and habits of birds and beasts of prey, unmistakably contemplate, as they provide for, a system or constitution of things in which death should reign. It was long and generally held, indeed, that this law in the natural economy super-vened upon the introduction of sin. But this idea, which Scripture does nowhere assert or sanction, is hard to be reconciled with the conclusion which phys-iology and anatomy have deduced from powers and or-gans of the animal frame, with the same certainty that any final cause is inferred from any of the works of God. And it must be regarded as conclusively re-futed by the discoveries of geology, which demonstrate the prevalence of death in ages long anterior to the creation of man, or, so far as is known, to the exist-ence of sin. The earth's strata are now found to be full of the buried remains of extinct life; and it is made evident by the state in which many of these fos-sils are found, that then, as now, life was sustained by death. Nor can it well be doubted that this state of things obtained even in the days of man's primeval innocence. If we try, we shall find ourselves baffled in the attempt to conceive how even then death could be strange or unknown. Must not the revolving year have been marked by the opening and the fall of the

earth's foliage, the ripening consumption and decay of earth's fruits? Could our first parents drink of the rivers of paradise, or tread its verdant surface, or keep and dress its trees and plants, without in every draught, at every step, by every stroke quenching or cutting down myriads of animalcular or insect as well as veg-etable life? Although the flesh of animals was not yet given to man for food, is it supposable that the laws of animal life itself were all the while in abey-ance—its instincts restrained, its powers unused, its appropriate pleasure withheld or denied? We know that from the day of man's creation he had given to him the idea of death. It was set before him as the just desert and consequence of disobedience. And whence should he have derived his conception of the import of the threatened evil so readily as from death's visible domain over the fowls of the heaven and the beasts of the field?

"With regard to creatures of mere instinct or animal nature, there can be nothing judicial or of the nature of punishment in their ordination to death. It is be-yond question that for man's sake a curse had 'been brought upon the ground,' and the 'whole creation groweth and travaileth in pain together until now.' Still man himself is by this means the greatest suffer-er; and so far as it affects the other creatures, it can be only a physical evil, equally without moral cause or penal effect, of which, by their nature, they are un-susceptible. How this appointment is to be reconciled with the benevolence of the Creator is a hard ques-tion, which no light yet given to man enables him fully to resolve. So far, however, it may relieve the mystery that, as a general rule, the enjoyments of the inferior creatures greatly exceed their sufferings that death is but little, if at all, the object of their fear, or much even a cause of pain. That 'the sum of animal enjoyment quenched in death is amply compensated by the law of increase and succession, which both per-petuates life and preserves it in the vigor of its powers and the freshness of its joys, is certain;' also (as bear-ing on the physical and moral condition of man, to whose behalf, as chief in this lower world, all arrange-ments and disposals affecting the lower forms of life were subordinated), that their subjection to death has enlarged immensely the extent of man's physical re-sources, and multiplied manifold the means of his mor-al development and discipline.

"But man himself is involved in the common doom. It is appointed unto all men once to die. The reigning fact, man's death, seems to force upon us the conclusion that death is a physical necessity, or a universal law extending to all material organizations, however oth-erwise psychologically distinguished or divinely allied. And this opinion has generally obtained among men of pantheistic and materialistic views in philosophy, and of Pelagian and Socinian views in theology. But surely it is impossible, consistently with God's omni-potency, to allege the necessity or the power of this law, as existing in despite of his pleasure and purpose, to constitute our nature under a law of life. It is more than probable that the other orders of creatures who dwell in life immortal in the heavenly places are not all spirit, or without their own mode and form of organized existence. We are assured that the bodies of the risen saints are clothed with incorruption and immortality. We know that, even as now constituted, the life of these frail bodies in antediluvian age was prolonged to the verge of a millennium. And why should it be thought impossible for God, if so it had pleased him, to endure them with the powers, or pro-vide for them the means of repairing the wear and waste of life, so as to preserve their powers and sen-sibilities in unabated vigor and freshness, 'even to length of days forever and ever?' This, Scripture in-forms us, was in the beginning provisionally ordained. The threatening of death as the penalty of a breach of the covenant is rightly understood to imply the prom-

ise of deathless and incorruptible life so long as the covenant should stand. And the tree of life in the midst of the garden, if not by its physical virtue the means of perpetual renovation, was certainly the sacramental pledge of God's purpose to preserve life inviolate while man was steadfast to the covenant. Thus runs the tenor of the covenant, or the constitution under which man's life was originally given and held: 'Thou shalt not eat of the tree of knowledge of good and evil, for in the day thou eatest thereof thou shalt surely die.' And, in terms equally explicit to the transgression of the law is the entrance and reign of death over man ascribed: 'By one man sin entered into the world, and death by sin; and so death passed upon all men, for that all have sinned.' Let it be observed that this declares the cause of death as it reigns over all men only. It affirms nothing respecting the cause of death as it reigns over other orders of creatures in the present or in preceding stages of the world's existence. Whether, in any way, they may have been constituted under a law of death by anticipation, and as in keeping with a state of things in which death should reign over man, we do not venture to pronounce. That indirectly, as a consequence of their relation to man as a sinner against God, their sufferings have been increased and their lives shortened, it is impossible to doubt or deny. But if, in this view, sin be the occasion of their death, it cannot be the cause of it. They are incapable of sin, and cannot die judicially for sin. The contrary opinion, which long and generally prevailed, that the creatures were immortal until man sinned, has as little to justify it in Scripture as in science. Death, it is there said, is the law of their being; and the true doctrine of the Scripture is not that they die because man has sinned, but that man, because he has sinned, has forfeited his original and high distinction, and has become like 'the beasts that perish.' It is unnecessary here to multiply Scripture proofs of this awful and humbling truth. Every one is familiar with the frequent and equivalent testimonies that death is 'the fruit,' 'the wages,' the 'end' and consummation of sin; and the circumstances which attend and induce it impressively connect it with sin as its cause. How, if not through guilty forfeiture, should the life of man have been abbreviated in its term so much more than that of many of the inferior creatures, and in so many instances still further shortened by disease and by calamity? To how great extent is it consumed by the fire of evil passion, smitten by the stroke of vengeful violence, taken away by the arm of judicial authority? in all these cases sin visibly working death. And while embittered and burdened by manifold pain and sorrows, how irresistibly does conscience within disquiet and alarm us by the conviction of guilt and the terror of righteous judgment?

"But now what is death, or what does it import as an appointed doom? To answer this question rightly, we require to ascertain the true constitution of our nature. Obviously death must be very different in the view of the materialist, who regards man as only a higher species of animal, whose mental and moral distinctions are the result of a higher physical organization, and in the judgment of those who consider man as the possessor of a soul distinct from the body, the subject and seat of a higher nature. If the body be the whole of man, death is the end of his conscious existence. If he consist of body and spirit, death may prove but his birthday into another and more important state of being. Now this point, which till the present hour has proved too hard for man himself to clear up, Scripture decides conclusively for all who will receive its testimony. Man is both body and spirit, the first placing him in communion with the outward world, the second allying him to God and his spiritual creation. The record of his primeval state exhibits the reality and effect of this complex being.

While his earthly paradise yielded its riches and pleasures to every sense and sensibility of his animal nature, his higher life found its appropriate and eminent occupation and delight in the service and communion of the 'Father of his spirit.' These views, as they magnify the life which God gave us, may be felt to complicate the nature and effects of death. How, then, does it affect us? Does it reach the man, body and spirit? If so, how are they united and together affected by it? and in what order, and what process does it consummate its work?

"1. Death extends to the entire man, and to every part of his nature. Against himself the threatenings were directed, 'In the day thou eatest thereof thou shalt die.' Beyond doubt the outward man perishes, and surely the inner man, the subject of that part of which the body is but the instrument, cannot have escaped the force of the dread sentence. God's word assures us that the soul that sinneth it shall die. As it speaks of man as already dead who yet lives in the body; dead, therefore, spiritually. On the other hand, it speaks of men now alive through grace who shall never die, while yet the graves are ready for them. Men who walk after the course of the world are in pleasure are pronounced 'dead in sin,' dead while they live. And while whoso loveth his brother who 'passed from death unto life, he that hateth his brother abideth in death.' These Scriptures, while they distinguish between bodily and spiritual death, represent both as included in the sentence, and threatened and executed against the sinner.

"2. To what effect, then, does death exert its power upon the body and the spirit severally and together? It is not unimportant to observe that this is not a distinction of existence or annihilation either of the one or the other. For a time the body retains its form and its substance, however changed, is never so much more, may it be presumed, shall the spirit survive. Not, indeed, that spirit more than body is immortal independently of God's will, but that, while he preserves our inferior part, he will much more preserve the higher and more kindred product of his creative power. The effects of death upon the body itself are a matter of common observation; it quickly turns its comeliness into corruption, and finally reduces its form and structure into shapeless dust. The effect of bodily death on the spirit of the man whose nature is thus divided it may be more difficult to estimate. This may depend in part on the value of the earthly portion he has lost, and partly on the favor-portion on which he has entered, but it cannot be indifferent either to the child of sorrow or to the subject of grace, more than to the heir of this world, who has been stripped of his whole inheritance of good. While we look on the deserted and impassive corpse and say 'It is all over with him now,' the disembodied spirit must still find itself the subject of a maimed and imperfect nature. Consciousness belongs to its nature, and must endure while it has being. Its proper life lies in the harmony and subjection of its powers and dispositions to the nature and will of God: its death is contrariety and enmity to him. This involves the disruption of a holy and dutiful relation to the Father of spirits, and, by inevitable consequence, a deprivation of the fruits of his love and favor, on which life and blessedness depend. 'Your sins have separated between you and God.'

"3. It may tend further to clear this subject to briefly trace the order and process through which the work of death is consummated. Though incurred instantaneously on the act of transgression, its effects follow by successive stages, and at several more or less distant intervals. As caused by sin, the spiritual man, as the proper subject and source of the evil, first feels its power. Its very touch intercepts all happy intercourse with a holy God. This was felt and seen as the day that Adam sinned. His fear and flight at the

of the Lord God in the garden was the unmistakable symptom of a soul already dead in sin, which not live with God, while his expulsion from presence marked no less clearly that God had left to live with him. Thus was executed to the the word which God had spoken, 'In the day eatest thou shalt surely die.' But the work of thus begun does not stop here. The disruption of creature's relation to God, it may well be concluded, must introduce disorder into all the relations of its being; nor, unless with a view to ulterior design of signal judgment or of more mercy, must its full development and consummation be long delayed. But in subserviency to this loes man live on in the body for a season, though God 'he is dead while he liveth.' Yet it is but little time. Whatever be the result of this day rebearance, the work of death goes on; 'the body ad because of sin'—the mortal crisis which awaits y individual man in his own time. As distinguish-om spiritual, it is called temporal death, as super-og exclusion from the things of earth and time to oss of all happy interest in God. There remains ne further stage ere it reach its complete and final e, both in the individual and the race. When the gns of the divine administration in our world are hed, the bodies of all who sleep in dust shall be ganized. There shall be a resurrection of the just of the unjust. While the just, by faith through e, shall be raised to life incorruptible and glorious, unjust, impenitent, and unbelieving shall awake he resurrection of damnation. The whole man ll go away from the glory and joy of God's prese- into everlasting punishment. This is the second th." See also Fletcher, *Works* (N. Y. ed.), i, 158 ; Wesley, *Works* (N. York ed.), i, 401; ii, 84, 404; wards, *Works* (N. Y. 1848, 4 vols. 8vo), ii, 372, 390 ; Watson, *Institutes*, ii, 48, 55; Martensen, *Christian gmaties* (Edinb. 1867), § 108-112. See ESCHATOLOGY.

Death, Brothers of, a name given to the relig- of the order of St. Paul, the first hermit, on ac- unt of the figure of a death's head which they were vays to have with them, in order to keep perpetually fore them the thought of death. The order was sup- sessed by pope Urban VIII.—Buck, *Theol. Dict.* s. v.

De'bir (Heb. *Debir*, דְּבִיר, or דְּבִירָה, a *sanctuary*, en applied to the Tabernacle and Temple, the name two or three places, and also of a man.

1. (דְּבִיר, but in Judg. and Chron. דְּבִירָה; Sept. Δα- ρ [Δεβίρ in Josh. xv, 15, 49; xxi, 15; Judg. i, 1,] v. r. Δαβείρ; Vulg. *Dabir*), a town in the mount- ns of Judah (Josh. xv, 49), one of a group of eleven ties to the west of Hebron (Keil, *Comment.* in loc.), a parched region (Judg. i, 11-15). In the narra- ve it is mentioned as being the next place which shua took after Hebron (x, 38). It was the seat of Canaanitish king (x, 39; xii, 18), and was one of e towns of the Anakim, and from which they were iterly destroyed by Joshua (xi, 21). The earlier ame of Debir was KIRJATH-SEPHER (Josh. xv, 15; udg. i, 11) and KIRJATH-SANNAH (Josh. xv, 49). ee these names.) The records of its conquest vary, ough not very materially. In Josh. xv, 17, and udg. i, 13, a detailed account is given of its capture y Othniel, son of Kenaz, for love of Achsah, the aughter of Caleb, while in the general history of the onquest it is ascribed to the great commander him- self (Josh. x, 38, 39, where the name occurs with ה local affixed, *Debi'ra*, דְּבִירָה, and this even with ל prefixed). It was one of the cities given with their 'suburbs' (מְקִינֹתָם) to the priests (Josh. xxi, 15; 1 Chron. vi, 58). Debir does not appear to have been known to Jerome, nor has it been discovered with cer- tainty in modern times. About three miles to the W.

of Hebron is a deep and secluded valley called the Wady Nunkur, enclosed on the north by hills of which one bears a name certainly suggestive of Debir—*De-wir-ban*. (See the narrative of Rosen in the *Zeitsch. d. Morgenl.* 1857, p. 50-64). The subject, and indeed the whole topography of this district, requires further examination: in the mean time it is perhaps some con- firmation of Dr. Rosen's suggestion that a village or site on one of these hills is pointed out as called *Isa*, the Arabic name for Joshua. Schwarz (*Palest.* p. 86) speaks of a *Wady Dibir* in this direction. Van de Velde (*Memoir.* p. 307) finds Debir at *Dilbeh*, six miles S.W. of Hebron, where Stewart (*Tent and Khan.* p. 228, 224) mentions a spring brought down from a high to a low level by an aqueduct (comp. "the upper and the nether springs" of Judg. i, 14, 15).—Smith, s. v.

2. (דְּבִירָה; Sept. ἐν τῷ τέρματι τῆς φάραγγος Ἀχώρ; Vulg. *Debera*), a place on the north boundary of Judah, "near the "Valley of Achor" (Josh. xv, 7), and therefore somewhere in the complications of hill and ravine behind Jericho. De Saucy (*Narrat.* ii, 25) attaches the name *Thow ed-Dabour* to the ruined khan on the right of the road from Jerusalem to Jericho, at which travellers usually stop to refresh; but this is not corroborated by any other traveller, unless it be Schwarz (*Palest.* p. 95), and he is disposed to identify this site with this and the foregoing place, nor does the locality agree with the scriptural intima- tions. The name usually given to it by the Arabs is Khan Hatherurah. A *Wady Dabor* is marked in Van de Velde's map as lying close to the S. of Neby Mûsa, at the N.W. corner of the Dead Sea (see De Saucy, *Narrat.* ii, 53, 54), which probably gives a trace of the ancient town as located on the N.E. of this valley. See TRIBE.

3. The "border (גְּבוּל) of Debir" (דְּבִירָה) to *Debir*; Sept. Δεβίρ v. r. Δαβείρ and Δαβίρ; Vulg. *Dabir*) is named as forming part of the boundary of Gad (Josh. xiii, 26), and as apparently not far from Mahansaim. Reland (*Palest.* p. 784) conjectures that the name may be the same as LODEBAR (q. v.), which is written similarly לֹדְבָרָה or לֹדְבֵרָה, and lay in the same vicinity (2 Sam. ix, 4, 5). Lying in the grazing country on the high downs east of Jordan, the name is doubt- less connected with דְּבִיר, *dabir*, the same word which is the root of *Midbar*, the wilderness or pasture (see Gesenius, *Thes.* Heb. p. 818).

4. (דְּבִירָה; Sept. Δαβίρ v. r. Δαβείρ and Δαβίρ; Vulg. *Dabir*), the king of Eglon, in the low country of Judah; one of the five Canaanitish princes who joined the confederacy summoned by Adonizedek of Jerusalem, and who were defeated, confined in a cave, and at length hanged by Joshua (Josh. x, 3, 28). B. C. 1618.

Deb'ora [prop. *Debo'ra*] (Δεβώρα or Δεβώρα, from the Heb. *Deborah*), a woman of Naphtali, moth- er of Tobiel, the father of Tobit (Tob. i, 8).

Deborah. See BER.

Deb'orah (Heb. דְּבִירָה [or "defectively" דְּבִירָה Gen. xxxv, 8; Judg. iv, 14; v, 15], a *bee*, as often [comp. the names *Melissa* and *Melitilla*]; Sept. Δέ- βωρρα v. r. [in Judg.] Δεβώρα; Josephus Δεβώρα, *Ant.* v, 5, 2]), the name of two women. See DEBORA.

1. The nurse of Rebekah (Gen. xxxv, 8). Nurses held a high and honorable place in ancient times, and especially in the East (2 Kings xi, 2; Homer, *Od.* i, 429; Virgil, *Æn.* vii, 2; "Æneia nutrix;" Ovid, *Met.* xiv, 441), where they were often the principal mem- bers of the family (2 Chron. xxii, 11; Jahn, *Bibl. Arch.* § 166). Deborah accompanied Rebekah from the house of Bethuel (Gen. xxiv, 59), B. C. 2028; but she is only mentioned by name on the occasion of her burial, un- der the oak-tree of Bethel, which was called in her honor Allon-Bachuth (Gen. xxxv, 8). B. C. 1906.

Such spots were usually chosen for the purpose (Gen. xxiii, 17, 18; 1 Sam. xxxi, 13; 2 Kings xxi, 18, etc.). Many have been puzzled at finding her in *Jacob's* family; it is unlikely that she was sent to summon Jacob from Haran (as Jarchi suggests), or that she had returned during the lifetime of Rebekah, and was now coming to visit her (as Abarbanel and others say); but she may very well have returned at Rebekah's death, and that she was dead is probable from the omission of her name in Gen. xxxv, 27; and if, according to the Jewish legend, Jacob first heard of his mother's death at this spot, it will be an additional reason for the name of the tree, and may possibly be implied in the expression נִרְיָן , comforted, A. V. "blessed" (Gen. xxxv, 9; see, too, Ewald, *Gesch.* i, 390).—Smith, s. v.

2. A prophetess, "wife of Lapidoth," who judged Israel (Judg. iv, v) in connection with Barak (q. v.). B.C. 1409-1369. Her name may imply nothing whatever, being a mere appellative, derived like Rachel (a lamb), Tamar (a palm), etc., from natural objects; although she was (as Corn. a Lapide quaintly puts it) *suis mellea, hostibus aculeata*. Some, however, see in the name an official title, implying her prophetic authority. A bee was an Egyptian symbol of regal power (comp. Callim. *Joc.* 66, and *Et. Mag.* s. v. *ισσην*); and among the Greeks the term was applied not only to poets (*more apud matina*, Horace), and to those peculiarly chaste (as by the Neoplatonists), but especially to the priestesses of Delphi (*χρησμός μελισσας* $\Delta\epsilon\lambda\phi\iota\delta\omicron\varsigma$, Pind. P. iv, 106), Cybele, and Artemis (Creuzer, *Symbolik*, iii, 354, etc.), just as *ισσην* was to the priests (Liddell and Scott, s. v.). In both these senses the name suits her, since she was essentially a vates or seer, combining the functions of poetry and prophecy (see Stanley, *Jewish Church*, i, 348 sq.).

She lived, probably in a tent, under the palm-tree of Deborah, between Ramah and Bethel in Mount Ephraim (Judg. iv, 5), which, as palm-trees were rare in Palestine, is mentioned as a well-known and solitary landmark, and was probably the same spot as that called (Judg. xx, 33) Baal-Tamar, or the sanctuary of the palm (Stanley, *Palest.* p. 145). Von Bohlen (p. 384) thinks that this tree is identical with Allon-Bachuth (Gen. xxxv, 8), the name and locality being nearly the same (Ewald, *Gesch.* i, 391, 405), although it is unhistorical to say that this "may have suggested a name for the nurse" (Hävernick's *Introd.* to *Pent.* p. 201; Kalisch, *Gen.* ad loc.). Possibly it is again mentioned as "the oak of Tabor" in 1 Sam. x, 8 (where Thenius would read רִבְרִיז for רִבְרִיז). At any rate, it was a well-known tree, and she may have chosen it from its previous associations. See OAK.

She was probably a woman of Ephraim, although, from the expression in Judg. v, 15, some suppose her to have belonged to Issachar (Ewald, *Gesch.* ii, 489). The expression אֵשֶׁת לַפִּידוֹת is much disputed; it is generally thought to mean "wife of Lapidoth," as in A. V.; but other versions render it "uxor principis," or "Fœmina Lapidothana" ("that great dame of Lapidoth," Tennyson), or *mulier splendorum*, i. e. one divinely illuminated, since אֵשֶׁת לַפִּידוֹת = lightnings. But the most prosaic notion is that of the Rabbis, who take it to mean that she attended to the tabernacle lamps, from לַפִּיד , *lappid*, a lamp! The fem. termination is often found in men's names, as in Shelomith (1 Chron. xxiii, 9), Koboeth, etc. Lapidoth, then, was probably her husband, and not Barak, as some say. See LAPIDOTH.

She was not so much a judge (a title which belongs rather to Barak, Heb. xi, 32) as one gifted with prophetic command (Judg. iv, 6, 14; v, 7), and by virtue of her inspiration "a mother in Israel." Her sex would give her additional weight from the peculiarity of the circumstance, as in the instances of Miriam,

Huldah, Anna, Noadiah (2 Kings xxii, 14; Eccl. i, 14). Her official designation probably means that she was the organ of communication between God and his people, and probably, on account of the influence and authority of her character, was accounted in some way as the head of the nation, to whom questions of law and difficulty were referred for decision. See JUDG.

From the intimations which the narrative (especially her song) contains, and from other circumstances, the people would appear to have sunk into a state of total discouragement under the oppression of the Canaanites, so that it was difficult to rouse them from their despondency, and to induce them to make an exertion to burst the fetters of their bondage. In the gratitude which Deborah expresses towards the people for the effort which they finally made, we are warranted in drawing the conclusion that she had endeavored to instigate them to this step in vain. At length she summoned Barak, the son of Abimeon, son of Kedesh, a city of Naphtali, on a mountain not far from Hazor, and made known to him the will of God that he should undertake an enterprise for the deliverance of his country. But such was his disheartened state of feeling, and, at the same time, such his confidence in the superior character and authority of Deborah, that he assented to go only on the condition that she would accompany him. Jabin's tyranny was peculiarly felt in the northern tribes, who were near his capital and under her jurisdiction, viz. Zebulun, Naphtali, and Issachar; hence, when she summoned Barak to the deliverance, it was on them that the brunt of the battle fell; but they were joined by the adjacent coastal tribes, Ephraim, Manasseh, and Benjamin, though not by those of the extreme west, south, and east. Under her direction Barak encamped on "the broad ground of Tabor" (Josephus, *War*, ii, 20, 6). When asked to accompany him, she answered indignantly, "Thou, O Barak, deliverest up manly the authority which God hath given thee into the hands of a woman: what do I reject it?" (Joseph. *Ant.* v, 5, 2). The Sept. interpolates the words "because I know not the day when the Lord will escort me by his angel" as a sort of excuse for Barak's request (iv, 8; comp. 14; v, 25). Was the small band of ill-armed (Judg. v, 8) Israelites, with the dense iron chariots of the enemy, "they were so frightened that they wished to march off at once, but not Deborah detained them, and commanded them to fight the enemy that very day" (Joseph. *l. c.*). They did so, but Deborah's prophecy was fulfilled (Judg. v, 9), and the enemy's general perished among the "cave of the wanderers (Zaanaim)," in the tent of the Benouin Kenite's wife (Judg. iv, 21) in the northern mountains. For the natural phenomena which aided (Judg. v, 20, 21) the victory, and the other details (for which we have ample authority in the twofold narration in prose and poetry), see BARAK, where we have also entered on the question of the chronology (Ewald, *Gesch.* ii, 489-494). B.C. 1409. This great victory, which seems to have been followed up, broke the power of the native princes, and secured to the Israelites a repose of forty years' duration (Judg. v, 31). During part of this time Deborah probably continued to exercise her former authority; but nothing more of her history is known. See Thomson, *Land and Book*, ii, 158. Hunter, *Sacred Biog.* iv, 98; Hughes, *Female Char.* i, 296.—Kitto, s. v.; Smith, s. v.

Deborah's title of "prophetess" (נָבִיאָה) includes the notion of inspired poetry, as in Exod. xv, 20; and in this sense the glorious triumphal ode (Judg. v) which vindicates her claim to the office. This song, which was composed in consequence of the great victory over Sisera, is said to have been "sung by Deborah and Barak." See JAEL. It is usually regarded as the composition of Deborah (see Zeitner, *Deborah and prophetias eruditio*, Alt. 1708), and was probably dictated by her to be sung on the return of Barak and his

ors from the pursuit. It belongs indisputably to the first rank of Hebrew poetry, and is one of its most didactic and difficult specimens. "In the ecstasy of energy of inspiration," says Prof. Robinson (*Bib. s.* 1831, p. 569), "the prophetess pours out her soul in thanksgiving to God for his divine aid, in gratitude to the people of Israel for their patriots in rising spontaneously to throw off the yoke of oppression. Her strains are bold, varied, and sublime; she is everywhere full of abrupt and impassioned appeals and personifications; she bursts away from earth to heaven, and again returns to human things; she touches now upon the present, now dwells upon the past, and closes at length with the grand promise of the result of all prophecy, and of all the dealings of God's providence, that the wicked shall be overthrown, and the righteous shall ever triumph in Jehovah's reign." This ode has often been explained at length, especially by Hollman, *In carmen Debora* (Lips. 1818); and, *Sur le chant de Débora* (Strasb. 1838); Kalkar, *Lyric Deb.* (Copenh. 1838); Kemink, *De carm. Deb.* (r. 1840); Meier, *Uebers. u. Erklär. des Deborahs* (Tübingen, 1859); Herder, *Heb. Poesie*, ii, 235; and, *Poet. Bücher*, i, 125 sq.; Gumpach, *Akt. Stud.* 40; Böttger, in *Käuffer's Bibl. Studien*, pt. 1-8; Winson, *Bibl. Repos.* i, 568 sq. Other treatises are, Latin, by Schultens (L. B. 1745); also in his *Syll. Serit.* No. 12; Lette (L. B. 1769); Lüdewald (Helmst. 1762); Schnurrer (Tüb. 1775); also in his *Dissert.* p. 86; comp. Origen (*Opp.* ii, 470), Jerome (*Opp. Spur.* 745), Muis (*Sel. Cant.* i), Cocceius (*Opp.* i, 811); in German, by Teller (Halle, 1766); Wenck (Darmst. 1783); Köhler (in Eichhorn's *Repertor.* vi, 168 sq.), andelssohn (in *Sammler*, 1778); Bielcke (Starg. 1780); English, by Weston (London, 1788); Horsley (*Bib. ii.* ii, 424, 477); in Italian, by Hintz (ed. Brini, Rom. 1842). See JUDGES (BOOK OF).

Debt (נֶשֶׁה, *neshe'*, 2 Kings iv, 7; מַשְׁכָּחָה, *mash-kaak'*, Prov. xxii, 26; נֶשֶׁה, *neshe'*, a creditor, 1 Sam. xxii, 2; elsewhere, נָ, *hand*, Neh. x, 81; δάνον, *loan*, never *debt*, Matt. xviii, 27; δειλή, *debt*, Matt. viii, 22, a *due*, as rendered Rom. xiii, 7; δειλίγα, *something owed*, Matt. vi, 12; Rom. iv, 4). The Mosaic law very strongly recommended willingness to loan (Deut. xv, 7 sq.; comp. Psa. xxxvii, 26; Matt. v, 42). Interest (נִשְׁבָּע, "*usury*"), however, could only be exacted by capitalists from foreigners, not at all from Israelites as co-religionists (in Neh. v, 11, a percentage is mentioned; but it does not appear whether his was in money, Heineccii *Antiq. Rom.* ii, 15, 19, as generally among the Romans, or a yearly rental; comp. Appian, *Civ.* i, 54); also a vendue of loaned natural products (see, however, *Baba Metia*, v, 1) was forbidden (Exod. xxii, 25; Lev. xxv, 37 sq.; Deut. xxiii, 20). The agrarian regulation of the state secured each one, in the last resort, from the rapacity of the creditor; probably by this very arrangement moneyed men were restrained from depending upon loaned money for a subsistence, and were thus induced to turn their attention to agriculture or other useful occupations. See LAND. In this way, however, wholesale business, which was incompatible with the isolation-system of the Jewish law-giver, was rendered rare, or rather impossible (see Michaelis, *Synagm. comment.* ii, 1 sq.; *Mos. Recht*, iii, 87 sq.; Jahn, *Bibl. Archäol.* II, ii, 825 sq.; on the Talmudic prescriptions, see Selden, *Jus. Hebr.* vi, 9). Usury incurred the deepest scorn (Prov. xxviii, 8; Ezek. xviii, 8, 13, 17; xxii, 12; Jer. xv, 10; Psa. xv, 5; cix, 11), but no other civil penalty was annexed to it (according to the Talmud, it involved a forfeiture of redress; on the whole subject, see Marezoll, *De usuraria proximitate*, Lips. 1837). Written notes of obligation (χειρόγραφα, *signatures*; Gesenius, *Theaurus*, p. 921, finds such evidences of debt in the נָ נֶשֶׁה or נָ נֶשֶׁה, q. d. *note of*

hand, Deut. xv, 2: the Talmudic precepts on such paper are given in the Mishna, *Baba Bathra*, c. 10) were, at least in the post-exilian period, regularly in vogue (Tobit i, 17; Josephus, *Ant.* xvi, 10, 8; *War.* ii, 17, 6; comp. xviii, 6, 8; Luke xvi, 6 sq.). Distraint was allowed, but under certain restrictions (Exod. xxii, 16 sq.; Deut. xxiv, 6, 10 sq.). See PLEDGE. Severity against debtors being regarded as imperious among the Israelites (comp. Job xxii, 6; xxiv, 8), especially in the collection of debts, the law scarcely enjoined anything directly on the treatment of bankrupts; it is merely indicated (Lev. xv, 89) that he who was totally insolvent might be sold into temporary bondage in order to satisfy the debt by his wages. (On the rigor towards this class among the Romans, see Heineccius, *Antiq. jur. Rom.* iii, 80, 2. They were often subjected to the harshest usage as slaves, Livy, ii, 23; vi, 36; Gell. xx, 1, 19; Appul. *Ital.* ix, p. 40, ed. Schweigh. In Athens, before Solon's time, the creditor could even lay claim to the person of his debtor, Plutarch, *Vit. Sol.* c. 15; later, there prevailed a summary process of seizure, which the creditor himself was authorized to execute [see Schläger, *De delictore*, etc. Helmstadt, 1741]. Yet certain mitigations, not unlike the Mosaic, existed; see Heffter, *Athen. Gerichtsverf.* p. 455 sq. On the Egyptian legislation, see Diod. Sic. i, 79; Wilkinson, ii, 49 sq.) This rule was often still further exercised in practice with such hardheartedness as to involve wife and children in the poor debtor's fate (2 Kings iv, 1; Neh. v, 5; Isa. i, 1; Matt. xviii, 25); nay, the sureties likewise were exposed to the same mode of reparation (Prov. xx, 16; xxii, 26 sq.; xxvii, 13). Debtors were liable to punishment by imprisonment (Matt. v, 26; xviii, 30), probably a Roman usage. The Talmudic rules concerning debt are mild (*Baba Metia*, ix, 18). On the Sabbatical year (q. v.) all pecuniary obligations were cancelled (Deut. xv, 1 sq., 9). —Winer, i, 251. See LOAN; DEBTOR; USURY; CREDITOR, etc.

Debtor (דָּבָר, *chob*, *debt*, Ezek. xviii, 7; χρεωστῆτης, *ower of money*, Luke vii, 41; xvi, 5; elsewhere simply δειλίτης. See generally the prop. Hebrew words נֶשֶׁה, נִשְׁבָּע, Gesenius, *Theor. Heb.* p. 920). The Mosaic laws respecting pecuniary obligations differ in many points from those of modern nations, but this is no proof that they were not suitable to the people for whom they were designed, and it is certain that they are pervaded by a spirit of kindness to the debtor to which no parallel is to be found in the codes of antiquity. See LOAN. Though they at least tacitly allow of the sale of a debtor as a slave (Lev. xxv, 39, 40), they also direct that his treatment shall be that of "an hired servant and a sojourner," while the law of the Twelve Tables authorized putting an insolvent debtor to death, and both Grecian and Roman history abound with instances of the disturbances caused in those states by the severity with which this class was dealt with. The laws of Moses are, however, by no means regardless of the rights of creditors, as we find that persons who had property due to them might, if they chose, secure it either by means of a mortgage, or by a pledge, or by a bondsman or surety. The chief provisions in the Scripture on the subject are the following:

1. The creditor, when about to receive a pledge for a debt, was not allowed to enter the debtor's house and take what he pleased, but was to wait before the door till the debtor should deliver up the pledge with which he could most easily dispense (Deut. xxiv, 10, 11; Job xxii, 6; xxiv, 8, 7, 9).

2. When a mill, or mill-stone, or an upper garment was given as a pledge, it was not to be kept all night. These articles appear to be mentioned as examples for all other things which the debtor could not without great inconvenience dispense with (Exod. xxii, 26, 27; Deut. xxiv, 6, 12).

8. The debt which remained unpaid until the seventh or Sabbatic year (during which the soil was to be left without cultivation, and, consequently, a person was not supposed to be in a condition to make payments) could not be exacted during that period (Deut. xv, 1-11). But at other times, in case the debt was not paid, the creditors might seize, first, the hereditary land of the debtor, and enjoy its produce until the debt was paid, or at least until the year of jubilee; or, secondly, his houses. These might be sold in perpetuity, except those belonging to the Levites (Lev. xxv, 14, 32). Thirdly, in case the house or land was not sufficient to cancel the debt, or if it so happened that the debtor had none, the person of the debtor might be sold, together with his wife and children, if he had any. This is implied in Lev. xxv, 39, and this custom is alluded to in Job xxiv, 9. It existed in the time of Elisha (2 Kings iv, 1), and on the return of the Jews from the Babylonish captivity some rich persons exercised this right over their poor debtors (Neh. v, 1-18). Our Lord alludes to the same custom in Matt. xviii, 25. As the person of the debtor might thus be seized and sold, his cattle and furniture were undoubtedly liable for his debts (Prov. xxii, 27). It does not appear that imprisonment for debt existed in the age of Moses, but it seems to have prevailed in the time of our Saviour (Matt. xviii, 34).

4. If a person had become bondsman or surety for another, he was liable to be called upon for payment in the same way with the original debtor. But this practice does not appear to have obtained before the time of Solomon, when it was attended with serious consequences. It seems that the formality observed was for the person who became surety to give his hand to the debtor, and not to the creditor, to intimate that he became, in a legal sense, one with the debtor; for Solomon cautions his son against giving his hand to a stranger, to a person whose circumstances he did not know; and entreats him to go and urge the person to whom he had given his hand, or for whom he had become surety, to pay his own debt (Prov. xi, 15; xvii, 18; xxii, 26). See DEBT.

Decalogue (Δεκάλογος), the name most usually given by the Greek fathers to the law of the two tables given by God to Moses on Mount Sinai, called in Scripture "the TEN COMMANDMENTS" (עשרת הדברות, *the ten words*; Sept. *οἱ δέκα λόγοι* and *τὰ δέκα ῥήματα*; Vulg. *decem verba*; Exod. xxxiv, 28; Deut. iv, 13; x, 4); and embracing what is usually termed "the Moral Law" (Exod. xx, 8-17; Deut. v, 7-21). The Decalogue was written on two stone slabs (Exod. xxxi, 18), which, having been broken by Moses (xxxii, 19), were renewed by God (xxxiv, 1, etc.). They are said (Deut. ix, 10) to have been written by the finger of God, an expression which always implies an immediate act of the Deity. The Decalogue is five times alluded to in the New Testament, there called *ἰστολαί, commandments*, but only the latter precepts are specifically cited, which refer to our duties to each other (Matt. xvii, 18, 19, etc.; Mark x, 19; Luke xviii, 20; Rom. xiii, 9; vii, 7, 8; Matt. v; 1 Tim. i, 9, 10). Those which refer to God are supposed by some to be omitted in these enumerations, from the circumstance of their containing precepts for ceremonial observances (Jeremy Taylor's *Life of Christ*, and *Ductor Dubitantium*; Rosenmüller's *Scholæ in Exod.*).

The circumstance of these precepts being called the *ten words* has doubtless led to the belief that the two tables contained ten distinct precepts, five in each table; while some have supposed that they were called by this name to denote their perfection, *ten* being considered the most perfect of numbers: so Philo-Judæus (*ἡ δέκας παντελής . . . ἀριστὸν γέλειον, De Septem. c. 9*). This distinguished philosopher divides them into two pentads (*De Decalogo*), the first pentad ending with Exod. xx, 12, "Honor thy father and thy moth-

er," etc. or the *fifth* commandment of the Greek, formed, and Anglican churches; while the more general opinion among Christians is that the first contained our duty to God, ending with the law, "keep the Sabbath holy, and the second our duty to our neighbor. As they are not numerically equal in the Scriptures, so that we cannot positively say which is the first, which the second, etc., it may prove uninteresting to the student in Biblical literature if we here give a brief account of the differences of dividing them which have prevailed among Jews and Christians. The case cannot be more distinctly stated than in the words of St. Augustine: "It is required how the ten commandments are to be divided—whether there are four which relate to God, only with the precept concerning the Sabbath—and the other six, commencing with 'Honor thy father and thy mother,' appertaining to man—or whether the former are three only, and the latter seven? These we say that the first table contains four, separate commandments, 'Thou shalt have no other gods but I' (Exod. xx, 3; Deut. v, 7), so as to make another precept of 'Thou shalt not make to thyself an idol' (Lev. xx, 4; Deut. v, 8), in which images are forbidden to be worshipped. But they wish 'Thou shalt not covet thy neighbor's house' (Exod. xx, 17; Deut. v, 21); 'Thou shalt not covet thy neighbor's wife' (Exod. xx, 17; Deut. v, 21), and so on to the end, to be one. But those who say that there are only three in the first table, and seven in the second, make one commandment of the precept of the worship of one God, and none beside him (Exod. xx, 3; Deut. v, 7), but divide the last into two, so that one of them is 'Thou shalt not covet thy neighbor's wife,' and the other, 'Thou shalt not covet thy neighbor's house.' There is no question among either about the correctness of the number, as for this there is the testimony of Scripture" (*Questions on Exodus*, qu. 71, *Works*, iii, 443, Paris, 1672).

1. *The Talmudical Division*, or that contained in the Talmud (*Makkoth*, xxiv, a), which is also that of modern Jews. According to this division, the first commandment consists of the words "I am the Lord thy God, who brought thee out of the land of Egypt out of the house of bondage" (Exod. xx, 2; Deut. v, 6); the second (Exod. xx, 3, 4), "Thou shalt have none other gods beside me; thou shalt not make to thyself any graven image," etc. to ver. 6; the third "Thou shalt not take God's name in vain," etc. to ver. 4; the fourth, "Remember to keep holy the Sabbath day," etc.; the fifth, "Honor thy father and thy mother," etc.; the sixth, "Thou shalt not kill," etc.; the seventh, "Thou shalt not commit adultery;" the eighth, "Thou shalt not steal;" the ninth, "Thou shalt not bear false witness," etc.; and the tenth, "Thou shalt not covet," etc., to the end. This division is also supported by the Targum of the pseudo-Jonathan, a work of the sixth century, by Aben-Ezra, in his *Commentary*, and by Maimonides (*Sepher Hamisivot*). It has also been maintained by the learned Lutheran, Peter Martyr (*Loci Communes*, Basle, 1580, loc. 14, p. 684). That this was a very early mode of dividing the Decalogue is further evident from a passage in Cyril of Jerusalem's treatise against Julian, from whom he quotes the following invective: "That Decalogue, the law of Moses, is a wonderful thing: thou shalt not steal; thou shalt not kill; thou shalt not bear false witness. But let each of the precepts which he asserts to have been given by God himself be written down in the identical words, 'I am the Lord thy God, who brought thee out of the land of Egypt;' the second follows: 'Thou shalt have no strange gods beside me; thou shalt not make to thyself an idol.' He adds the reason, 'for I, the Lord thy God, am a jealous God, visiting the sins of the fathers upon the children.' 'Thou shalt not take the name of the Lord thy God in vain. Remember the Sabbath day. Honor thy father and thy mother. Thou shalt not commit adultery. The

It **not** steal. Thou shalt not bear false witness. Thou shalt not covet thy neighbor's goods.' What is there, by the gods, if you take away these, 'Thou shalt not adore other gods,' and 'Remember the Sabbath,' which does not think all the others to be kept, and which does not punish more or less severely those who violate them?"

1. *The Origenian Division*, or that approved by Origen, which is that in use in the Greek and in all the reformed churches except the Lutheran. Although Origen was acquainted with the differing opinions which existed in his time in regard to this subject, it is evident from his own words that he knew nothing of that division by which the number ten is completed, making the prohibition against coveting either the use of the wife a distinct commandment. In his eighth *Homily on Genesis*, after citing the words, "I am the Lord thy God, who brought thee out of the land of Egypt," he adds, "this is not a part of the commandment." The first commandment is, "Thou shalt have no other gods but me," and then follows, "Thou shalt not make an idol." These together are thought by me to make one commandment; but in this case the number ten will not be complete—where, then, will be the truth of the Decalogue? But if it be divided as we have done in the last sentence, the full number will be evident. The first commandment therefore is, "Thou shalt have no other gods but me," and the second, "Thou shalt not make to thyself an idol, nor a likeness," etc. Origen proceeds to make a distinction between gods, idols, and likenesses. Of gods, he says, it is written, there are gods many and lords many" (1 Cor. viii. 5); but of idols, "an idol is nothing;" an image, he says, of a quadruped, serpent, or bird, in metal, wood, or stone, set up to be worshipped, is not an idol, but a likeness. A picture made with the same view comes under the same denomination. But an idol is a representation of what does not exist, such is the figure of a man with two faces, or with the head of a dog, etc. The likeness must be of something existing in heaven, or in earth, or in the water. It is not easy to decide on the meaning of "things in heaven," unless it refers to the sun, moon, or stars. The design of Moses he conceives to have been to forbid Egyptian idolatry, such as that of Hecate, or other fancied demons" (*Opera*, ii, 158, De La Rue's ed.).

The pseudo-Athanasius, or the author of the *Synopsis Scripturæ*, who is the oracle of the Greek Church, divides the commandments in the same manner. "This book [Exodus] contains these ten commandments, on two tables: first, I am the Lord thy God. Second, Thou shalt not make to thyself an idol, nor any likeness. . . . Ninth, Thou shalt not bear false witness against thy neighbor. Tenth, Thou shalt not covet thy neighbor's wife, nor any thing that is thy neighbor's" (Athanasii *Opera*, fol. Paris, 1698).

Gregory Nazianzen, in one of his poems, inscribed "The Decalogue of Moses," gives the following division (*Opera*, ed. Caillaud, Paris, 1840):

These ten laws Moses formerly engraved on tables
Of stone; but do thou engrave them on thy heart.
Thou shalt not know another God, since worship belongs to me.
Thou shalt not make a vain statue, a lifeless image.
Thou shalt not call on the great God in vain.
Keep all sabbaths, the sublime and the shadowy.
Happy be who renders to his parents due honor.
Flee the crime of murder, and of a foreign
Bed; evil-minded theft and witness
False, and the desire of another's, the seed of death.

Jerome took the same view with Origen. In his commentary on Ephesians vi, he thus writes: "'Honor thy father and thy mother,' etc. is the *fifth* commandment in the Decalogue. How, then, are we to understand the apostle's meaning in calling it the first, when the first commandment is 'Thou shalt have no gods but me,' where some read thus, 'which is the first commandment with promise,' as if the *four* previous commandments had no promise annexed, etc. But they do not seem to me to have observed

with sufficient accuracy that in the *second* commandment there is also a promise: 'Thou shalt not make to thyself an idol, nor the likeness of any thing in heaven above, or in the earth beneath, or in the water under the earth; thou shalt not adore them, nor sacrifice to them; for I, the Lord thy God, am a jealous God, visiting the sins . . . but showing mercy unto thousands' (observe these words of promise—showing mercy unto thousands, etc.)" (Hieronymi *Opera*, vol. iv, Paris, 1698).

The pseudo-Ambrose also writes to the same effect in his *Commentary on Ephesians*: "How is this the first commandment, when the first commandment says, Thou shalt have no other gods but me? Then, Thou shalt not make a likeness of any thing in heaven above, or in the earth beneath, etc. The *third*, Thou shalt not take the name of the Lord thy God in vain; the *fourth*, Keep my sabbaths; the *fifth*, Honor thy father and thy mother. As the first four appertain to God, they are contained in the first table; the others, appertaining to men, are contained in the second, such as that of honoring parents, not committing murder, adultery, theft, false witness, or concupiscence. These six seem to be written in the second table, the first of which is called the first with promise" (Ambrosii *Opera*, vol. ii, Paris edition, Append. p. 248, 249).

To these testimonies from the fathers may be added that of Clemens Alexandrinus (*Stromata*, vi, p. 809); but this writer is so confused and contradictory in reference to the subject, that some have supposed the text to have been corrupted. "The first precept of the Decalogue," he observes, "shows that one God only is to be worshipped, who brought his people out of Egypt . . . and that men ought to abstain from the idolatry of the creature. The second, that we ought not to transfer his name to creatures; the *third* signifies that the world was made by God, who has given us the seventh day to rest; the *fifth* follows, which commands us to honor our parents; then follows the precept about adultery, after this that concerning theft; but the tenth is concerning coveting."

But the strongest evidence in favor of the Origenian division is that of the learned Jews Philo and Josephus, who speak of it as the received division of the Jewish Church. Philo, after mentioning the division into two pentads already referred to, proceeds: "The first pentad is of a higher character than the second; it treats of the monarchy whereby the whole world is governed, of statues and images (*εἰκόνων καὶ ἀγαλμάτων*), and of all corrupt representations in general (*ἀφιδρομάρων*); of not taking the name of God in vain; of the religious observance of the seventh day as a day of holy rest; of honoring both parents. So that one table begins with God the father and ruler of all things, and ends with parents who emulate him in perpetuating the human race. But the other pentad contains those commandments which forbid adultery, murder, theft, false-witness, concupiscence" (*De Decalogo*, lib. i). The *first* precept, he afterwards observes, enjoins the belief and reverent worship of one supreme God, in opposition to those who worship the sun and moon, etc. Then, after condemning the arts of sculpture and painting, as taking off the mind from admiring the natural beauty of the universe, he adds: "As I have said a good deal of the *second* commandment, I shall now proceed to the next, 'Thou shalt not take the name of God in vain.' The fourth commandment respects the Sabbath day, to be devoted to rest, the study of wisdom, and the contemplation of nature, with a revision of our lives during the past week, in order to the correction of our transgressions; the fifth speaks of honoring parents. Here ends the first, or more divine pentad. The second pentad begins with the precept respecting adultery; its second precept is against murder; its third against stealing, the next against false-witness, the last against coveting" (lib. ii). This division seems to have been followed by

Irenæus: "In quinque libris, etc.; unaqueque tabula quam accepit a Deo præcepta habet quinque." Josephus is, if possible, still more clear than Philo. "The first commandment teaches us that there is but one God, and that we ought to worship him only; the second commands us not to make the image of any living creature, to worship it; the third, that we must not swear by God in a false matter; the fourth, that we must keep the seventh day, by resting from all sorts of work; the fifth, that we must honor our parents; the sixth, that we must abstain from murder; the seventh, that we must not commit adultery; the eighth, that we must not be guilty of theft; the ninth, that we must not bear false-witness; the tenth, that we must not admit the desire of that which is another's" (*Adv. iii. 5, 5*, Whiston's translation).

This division, which appears to have been forgotten in the Western Church, was revived by Calvin in 1536, and is also received by that section of the Lutherans who followed Bucer, called the Tetrapolitan. It is adopted by Calmet (*Dict. of the Bible*, French ed., art. Loi). It is supported by Zonaras, Nicephorus, and Petrus Mogislaus among the Greeks, and is that followed in the present Russian Church, as well as by the Greeks in general (see the Catechism published by order of Peter the Great, by archbishop Resensky, London, 1758). It is at the same time maintained in this catechism that it is not forbidden to bow before the representations of the saints. This division, which appeared in the Bishops' Book in 1537, was adopted by the Anglican Church at the Reformation (1548), substituting seventh for Sabbath-day in her formularies. The same division was published with approbation by Bonner in his *Homilies* in 1556.

8. We shall next proceed to describe the two *Masoretic divisions*. (1.) The first is that in Exodus. We call it the Masoretic division, inasmuch as the commandments in the greater number of manuscripts and printed editions are separated by a D or O, which mark the divisions between the smaller sections in the Hebrew. According to this arrangement, the first two commandments (in the Origenian or Greek division), that is, the commandment concerning the worship of one God, and that concerning images, make but one; the second is, "Thou shalt not take the name of the Lord thy God in vain;" and so on until we arrive at the two last, the former of which is, "Thou shalt not covet thy neighbor's house," and the last or tenth, "Thou shalt not covet thy neighbor's wife, nor his servant," etc. to the end. This was the division approved by Luther, and it has been ever since his time received by the Lutheran Church. The correctness of this division has been at all times maintained by the most learned Lutherans, not only from its agreement with the Hebrew Bibles, but from the internal structure of the commandments, especially from the fact of the first two commandments (according to Origen's division) forming but one subject. If these form but one commandment, the necessity of dividing the precept, "thou shalt not covet," etc. into two is obvious. (For a learned defence of this division, see Pfeiffer, *Opera*, vol. i, loc. 96, p. 125). Pfeiffer considers the accentuation also of the Hebrew as equally decisive in favor of this division, notwithstanding the opposite view is taken by many others, including the learned Buxtorf. This division is also followed in the Trent Catechism, and may therefore be called the Roman Catholic division. The churches of this communion have not, however, been consistent in following uniformly the Tridentine division, having revived, as in England, the second Masoretic division, to which we shall presently allude. In the Trent Catechism the first commandment is, "Ego sum Dominus Deus tuus, qui eduxi te de terra Ægypti, de domo servitutis; non habebis Deos alienos coram me. Non facies tibi sculptile," etc. "Ego sum Dominus Deus

tuus, fortis, zelotes," etc. to "præcepta mea." The last two commandments (according to the Roman vision) are, however, in the same Catechism, combined in one, thus: "Non concupisces domum proximi tui; nec desiderabis uxorem ejus, non servum, non asinam, non bovem, non animum, nec omnia que illi sunt. In his duobus præceptis," etc. It had appeared in the same form in England in Marshall's *and* bishop Hilsley's *Præmissa*, 1534 and 1539.

Those who follow this division have been accused to give the Decalogue very generally in an abridged form: thus the first commandment in the Lutheran Shorter Catechism is simply "Thou shalt have no other gods but me;" the second, "Thou shalt not take the name of thy God in vain;" the third, "Thou shalt sanctify the Sabbath-day" (*Feiertag*). A similar practice is followed by the Roman Catholics, altho' they, as well as the Lutherans, in their *Larger Catechisms* (as the Douay) give them at full length. The practice has given rise to the charge made against those denominations of leaving out the second commandment, whereas it would have been more exact to say that they had mutilated the first, or at least that the form in which they give it has the effect of concealing a most important part of it from such as only had access to their Shorter Catechisms.

(2.) The last division is the second *Masoretic* of that of Deuteronomy, sometimes called the Augustinian. This division differs from the former simply in placing the precept "Thou shalt not covet thy neighbor's wife" before "Thou shalt not covet thy neighbor's house," etc.; and for this transposition it has the authority of Deut. v, 21. The authority of the Masoretes cannot, however, be of sufficient force to separate the earlier traditions of Philo and Josephus.

This division was that approved by Augustine, who thus expresses himself on the subject: Following up what he had said (*ut sup.* p. 588), he observes, "But to me it seems more congruous to divide them into two and seven, inasmuch as to those who diligently look into the matter, those which appertain to God seem to insinuate the Trinity. And, indeed, the command, 'Thou shalt have no other gods but me,' is more perfectly explained when images are forbidden to be worshipped. Besides, the sin of coveting another man's wife differs so much from coveting his house, that to the house was joined his field, his servant, his maid, his ox, his ass, his cattle, and all that is his. But it seems to divide the coveting of the house from the coveting of the wife when each begins thus: 'Thou shalt not covet thy neighbor's wife, thou shalt not covet thy neighbor's house,' to which it then begins to add the rest. For when he had said 'Thou shalt not covet thy neighbor's wife,' he did not add the rest to this, saying, nor his house, nor his field, nor his servant, etc. but these seem plainly to be united, which appear to be contained in one precept, and distinct from that wherein the wife is named. But when it is said 'Thou shalt have no other gods but me,' there appears a more diligent following up of this in what is subjoined. For to what pertains, 'Thou shalt not make an idol, nor a likeness; thou shalt not adore nor serve them,' unless to that which had been said, 'Thou shalt have none other gods but me.'" The division of Augustine was followed by Bede and Peter Lombard.

The learned Sonntag has entirely followed Augustine's view of this subject, and has written a dissertation in vindication of this division in the *Theologische Studien und Kritiken* (Hamb. 1836-7), to which there was a reply in the same miscellany from Zöllig, in vindication of what he terms the *Calvinistic division* of that of Origen, which is followed by a rejoinder from Sonntag. Sonntag is so convinced of the necessity of that order of the words, according to which the precept against coveting the wife precedes (as in Deuteronomy) that against coveting the house, etc. that he puts down the order of the words in Exodus as it

ght. The order in the Septuagint version in us agrees with that in Deuteronomy. The Greek follows this order. Sonntag conceives that the division of the Decalogue was lost in the exile and the birth of Christ.—, s. v. See Heinze, *De ratione præcepta Decalogi variis et vera* (Viteb. 1790); Pfütcke, *De Decalogo* (Dresden, 1788); Thornton, *Lectures on the commandments* (Lond. 1842). For a list of expositions, see Darling, *Cyclopædibibliographica*, iii, 222 sq. See LAW.

Decap'olis (ἡ Δεκάπολις, Mark v, 20, but with the art. in Matt. iv, 25, Mark vii, 3; i. e. αἱ δέκα πόλεις, the ten cities, as in Josephus, *Life*, 65), a dis-trict in Pliny, v, 16, 17, *Decapoliensis regio*), or a certain ten cities (including their adjacent vil-lages or suburbs, Josephus, *Life*, 9), which resembled other in being inhabited mostly by Gentiles (Matt. iv, 25; Opp. ii, 417), and in their civic institutions and privileges (Josephus, *Life*, 74). They were situ-ated in the neighborhood of the Sea of Gennesareth (Mark vii, 31; comp. Joseph. *War*, iii, 9, 7), near the eastern side of the Jordan, and in what was called the Roman province of Syria (Josephus, *Life*, 66). The name Decapolis does not occur in the Apocrypha, and according to Mannert, it is only found in writers of the 1st century; in later times there is scarcely an allu-sion to it (*Geographie der Griechen und Römer*, VI, 1, 2). Immediately after the conquest of Syria by the Romans (B.C. 65), ten cities appear to have been re-built, partly colonized, and endowed with peculiar privileges (Josephus, *Ant.* xv, 7, 3; xvii, 11, 4); the territory around them was hence called *Decapolis*. The limits of the territory were not very clearly defined, but probably in the course of time other neighboring cities received similar privileges. This may account for the fact that ancient geographers speak so indefi-nitely of the province, and do not even agree as to the names of the cities themselves. Pliny (*Hist. Nat.* v, 16), while admitting that there was some variation in the list, enumerates them as follows: *Damascus, Philadelpia, Raphana, Scythopolis, Gadara, Hippos, Dion, Canatha, Gerasa* (? Gerasa), and *Canatha*; he adds (v, 17), "The tetrachlies lie between and around these cit-ies . . . namely, Trachonitis, Panias, Abila," etc. These cities are scattered over a very wide region. If Canatha be, as many suppose, the same as Raphana (Josephus, it lay near Hamath (Joseph. *War*, vii, 5, 6), and from thence to Philadelphia on the south is about 200 miles, and from Scythopolis on the west to Canatha on the east is about 60. Josephus does not enumerate the cities of Decapolis; but it would seem that he excludes Damascus from the number, since he calls Scythopolis the largest of them (*War*, iii, 9, 7). He also incidentally includes most of the other cities named: e. g. Philadelphia (*War*, ii, 18, 1), Gadara and Hippos (*Life*, 65, 74); while Epiphanius (*Hær.* i, 80, 2) names Pella as belonging to this district, and in Ste-phen of Byzantium Gerasa appears in the same gen-eral connection. Cellarius thinks Cæsarea-Philippi and Gergasa ought to be substituted in Pliny's list for amarus and Raphana (*Notit.* ii, 690). Pliny is un-doubtedly the only author who extends Decapolis so far north. Ptolemy appears to include Decapolis in the southern part of Coele-Syria (*Geogr.* v, 16); he also (v, 17) makes *Capitolias* one of the ten; and an old almyrene inscription quoted by Reland (*Palæst.* p. 25) includes *Abila*, a town which, according to Euse-rius (*Onom.* s. v. Abila), was 12 Roman miles east of Gadara. Lightfoot (*Hor. Hebr.* p. 563 sq.) enumerates from Talmudical sources (Jerus. Talm. *Demai*, fol. 22, 23), as belonging to Decapolis, besides Scythopolis, Ga-dara, Hippos, and Pella, the following less-known towns and villages, which, like Scythopolis (q. v.), were gen-erally esteemed as heathen and under Gentile rule: *Cephar-Carnaim* (כפר קרניים), *Cephar-Zemach* (כפר

צמח), *Beth-Gurin* (בית גורין), *Arbo* (ערב), and *Cæsarea-Philippi*. Brocardus, a writer of the 18th cen-tury, even describes Decapolis as extending in breadth from the Sea of Galilee to Sidon, and in length from Tiberias to Damascus, including the following ten chief towns: "Tiberias, Sophet, Cedus Nephtalim, As-sor, Cæsarea-Philippi, Capernaum, Jonitara, Bethsai-da, Corazin, and Bethsan" (*Descr. Terra Sancta*, in Le Clerc's ed. of Euseb. *Onomast.* p. 175). Andronicus gives an account of the extent of the Decapolis sub-stantially the same (*Theatr. Terra Sancta*). But these statements are justly pronounced by Lightfoot (*Opp.* ii, 417 sq.) as pure suppositions. All the cities of De-capolis, with the single exception of Scythopolis, lay on the east of the Jordan; and both Eusebius and Je-rome (*Onomast.* s. v. Decapolis) say that the district was situated "beyond the Jordan, around Hippos, Pel-la, and Gadara"—that is, to the east and south-east of the Sea of Galilee. With this also agrees the state-ment in Mark v, 20, that the demoniac who was cured at Gadara "began to publish in Decapolis how great things Jesus had done to him." The phraseology in Matt. iv, 25; Mark vii, 31, implying a situation on the west of the Jordan, must therefore be understood in a popular and general sense of a district but vaguely bounded, and one of whose towns was on that side of the river. In the latter passage indeed the entire diffi-culty vanishes, if, with the latest critics, we read διὰ Σιδῶνος instead of καὶ Σιδῶνος, and place these words after ἤλαξε, thus: "And again departing from the coasts of Tyre, he came through Sidon unto the Sea of Galilee, through the midst of the coasts of Decapolis." In that case our Lord travelled from Tyre northward to Sidon; then he appears to have crossed Lebanon by the great road to Cæsarea-Philippi; and from thence he descended through Decapolis to the eastern shore of the lake, where he fed the multitude (comp. Matt. xv, 29-38; Mark viii, 1-9). It thus appears that "the region of Decapolis" was beyond the Jordan, with the exception of the little territory of Scythopolis close to the western bank, at the southern end of the Sea of Galilee. In addition to Damascus and Scythopolis, whose sites are well known, its chief towns were: Ga-dara, about six miles south-east of the lake; Pella, on the side of the range of Gilead, opposite Scythopolis; Philadelphia, the ancient Rabbath-Ammon; Gerasa, whose ruins are the most magnificent in all Palestine; and Canatha, the Kenath of the Bible, situated east-ward among the mountains of Bashan. Decapolis was not strictly a province, like Galilee, Pæras, or Trachonitis. It was rather an assemblage of little principal-ities, classed together, not because of their geographic-al position, but because they enjoyed the same privi-leges, somewhat after the manner of the Hanse Towns in Germany. This region, once so populous and pro-sperous, from which multitudes flocked to hear the Sav-our, and through which multitudes followed his foot-steps, is now almost without an inhabitant. Six out of the ten cities are completely ruined and deserted. Scythopolis, Gadara, and Canatha have still a few fam-ilies, living, more like wild beasts than human beings, amid the crumbling ruins of palaces, and in the cavern-ous recesses of old tombs. Damascus alone contin-ues to flourish, like an oasis in a desert.—Kitto, s. v.; Smith, s. v. See PERASA.

Dechant, JACOB WILLIAM, a minister of the Ger-man Reformed Church, was born at Kreuznach, in the Palatinate, Germany, Feb. 18, 1784, and emigrated to America in 1805. Having received a good prepara-tory training in Europe, he studied theology with Dr. Becker, of Baltimore, Md., and was ordained in 1808. His first pastoral charge consisted of six congregations in Lehigh County, Pa. In 1816 he was sent as a mis-sionary to Ohio, returning after some years to Penn-sylvania to take charge of congregations in Berks and Montgomery counties. Here he labored with success

till his death. He died suddenly on his way home from Synod, of cholera, Oct. 5, 1832. Three of his sons are now actively engaged in the work of the ministry in the German Reformed Church. He preached only in the German language. A number of prominent German Reformed ministers received their theological training under him.

Decimæ. See **TITHEA**.

Decision, VALLEY OF (צְרִיפְתֵי קָמָץ, *E'mek, he-Charutz*, vale of the sentence; Sept. ἡ κολλὰς τῆς δίκης, *Vallis conisionis*), a name poetically given to the Valley of **JEHOSEPHAT** (q. v.), as being the ideal scene of the signal inflictions by Jehovah upon Zion's enemies at their restoration (Joel iii, 14). In perversion of some such prediction, the Mohammedans still believe that the final judgment will take place on this spot, and have accordingly left a stone in the city wall overhanging the valley, projecting as a seat for their prophet in the capacity of judge.

Decius, C. MESSIUS QUINTUS TRAJANUS, a Roman emperor, was born at Babalis, in Lower Pannonia, towards the close of the second century. Being sent in 249 by the emperor Philippus to restore to subordination the army of Mesia, which was in a state of revolt, the troops proclaimed him emperor against his will, and forced him to march upon Italy. Philippus having been defeated and slain, Decius assumed the government of the empire in the end of the year A.D. 249, but his brief reign was one of restless warring with the Goths, fighting against whom he was killed near Abricium, in the close of the year 251. Decius was an emperor of more than ordinary ability, but his reign was stained by a bloody persecution of the Chris-



Coin of Decius Trajanus. British Museum. Actual size. Copper. Weight 308½ grains.

tians. In point of time this persecution ranks as the seventh, but in point of cruelty it was only equalled by that of Diocletian. See **PERSECUTIONS**. For about forty years prior to the accession of Decius the Christians had enjoyed peace, which only in some parts of the Roman empire was, for a short time, interrupted by a decree of the emperor Maximin. The effect of this peace upon the religious life of the Church was, in general, not favorable. Cyprian, Origen, and other ecclesiastical writers complain that worldliness, avarice, and other vices had become prevalent, and that marriages of Christians with pagans had become frequent. Soon after his accession to the throne (probably at the beginning of the year 250), Decius issued a severe decree against the Christians. The decree itself is lost, the *Edictum Decii Augusti contra Christianos*, which was published in 1664 at Toulouse by Bernard Medonius from Acts of the Martyrs, being spurious, as has been shown by Tillemont and Mosheim. The contents of the decree are, however, fully noticed by Gregory of Nyssa and other ancient writers. It ordered the civil magistrates to destroy Christianity by threatening Christians with the severest punishments, and by using against them tortures of every kind. It was sent to the governors of all the provinces, and most of them hastened to execute it. They promulgated the decree, and demanded that within a certain time every Christian should appear before the civil magistrate, and publicly declare his renunciation of

the Christian faith; in the case of refusal, he was to suffer severe punishment, even death. Dionysius of Alexandria and Cyprian have given detailed descriptions of the persecution in the region of Carthage at Alexandria. Cyprian says that at the first news of the impending persecution a majority of the brethren hastened to renounce the faith, but his accounts suspected of exaggeration. That the number of converts was very large is also reported by Eusebius. Of those who remained faithful, most left the cities and sought refuge in solitude. Among this class was many of the most celebrated bishops, as Cyprian, Irenæus of Alexandria, and Gregory Thaumaturgus. This action was generally approved by the Church. The number of those, however, who neither fled nor apostatized was so great that, as soon as the time appointed for the execution of the decree arrived, the prisons were not sufficient to contain those who were arrested. Decius wished executions to be avoided, but every conceivable torture, if necessary, to be resorted to. Most of the civil magistrates vied with each other in inventing the most cruel tortures; and a few showed a spirit of sympathy and leniency. The number of those who succumbed to the torture (especially in the East) was very large. Many procured false certificates that they had abjured the faith (*libellatici*). On the other hand, however, the number of those who died or were mutilated for the faith was considerable. In Rome, Antioch, and Jerusalem the several bishops were massacred; Origen, famous among the early fathers, was subjected to the most acute tortures. In the ancient martyrologies abound in names of those who are reported to have suffered martyrdom under Decius, and Tillemont spent much time and labor in sifting the genuine reports from the spurious (*Mém.* iii, 138-139). Fortunately, the persecution of Decius did not last long. About Easter, 251, Cyprian returned from his concealment. The war which the emperor had to carry on against the Goths, his absence from Rome, the inroads of barbarians into the African provinces, and several insurrections, greatly moderated the persecution at the beginning of the year 252. When Decius, towards the close of the year, fell in battle against the Goths, the Christians were set at liberty.—Horzog, *Real-Encyclop.* iii, 309; Wetzer u. Welte, *Kirchen-Lex.* iii, 59; Neander, *Church Hist.* (Torrey's transl.), vol. ii.

Deck, i. e. BEDECK (properly **דָּכָה**, *adakh*, to cover. Ezek. xvi, 11, 13; xxiii, 40; Job xl, 10; Jer. iv, 2; Hos. ii, 13). See **ORNAMENT**.

Declamation, a speech made in the tone and manner of an oration, uniting the expression of affect to propriety of pronunciation, in order to give the sentiment its full impression on the mind. The word is used also in a disparaging sense, as when it is said such a speech was mere declamation, it implies that it was deficient in point of reasoning, or had more sentiment than sense.—Buck, *Theol. Dictionary*, s. v. See **HOPELESSNESS**.

Declaratio Thorunensis, a confession of faith of the Reformed churches in Poland, drawn up at Thorn in 1645, for the settlement of disputed questions (*ad liquidationem controversarum*). It is given in Neumeier, *Collectio Confessionum*, p. 669 (Lips. 1846).

Decorated Style. See **ARCHITECTURE**.

De Courcy, RICHARD, a divine of the Church of England, born in Ireland, was educated at Trinity College, Dublin; became curate of Shanbury, Shropshire, in 1770; afterwards vicar of St. Alkmund in 1774; died in 1808. In his sermons his language is dignified, and his reasoning perspicuous, embellished by appropriate allusions, and ornamented by many of the gems of oratory. His principal works are, *Sermons*, which is prefixed an essay on the nature, etc. of a true and undefiled religion (Shrewsbury, 1803, 8vo); *Tr*

cified, the distinguishing Topic of the Gospel (Lond. 8, 8vo).—Darling, *Cyclopaedia Bibliographica*, s. v.; *es, Christian Biography*, p. 126 (Lond. 1829).

Decree (properly דִּקְרוּ, *dakh* [Dan. ii, 9, 13, 15, elsewhere "law"], *δύγμα* [Luke ii, 1; Acts xvi, 4; xvii, elsewhere "ordinance"], also דִּקְרוּ, *gazar* [Isth. ii, 1], *κρίνω* [1 Cor. vii, 37, elsewhere usually *idgo*]), to determine; but represented by several Heb. words), an official resolution passed by magisterial authority (see Crabbe's *Engl. Synonymes*, s. v.). Among the Orientals the enactments of the kings were claimed publicly by criers (Jer. xxxiv, 8, 9; Jonah 5-7), who are designated in Daniel (iii, 4; v, 29) by term *קְרוֹןָא*, *karosa'*, the herald. They were made own in distant provinces, towns, and cities by messengers sent for that purpose (1 Sam. xi, 7; Ezra i, Amos iv, 5). The message thus to be communicated in any town or city was publicly announced when a messenger had arrived in the gate of the city, or some other public place. At Jerusalem it was announced in the Temple, where there were always a great many persons present. It was for the same reason that the prophets were accustomed to utter their oracles in the Temple. See PROCLAMATION.

DECREES OF THE COUNCIL OF THE APOSTLES AT JERUSALEM (Acts xv). These related to the following prohibitions, "that they abstain from pollutions of idols, and from fornication, and from things strangled, and from blood" (ver. 20); or, as it is repeated ver. 29, "that ye abstain from meats offered to idols, and from blood, and from things strangled, and from fornication." These are declared (ver. 28) to be "necessary" prohibitions. This necessity (as the *γάρ*, "for," of ver. 21 intimates) lay in the fact that wherever the Jews resided the law of Moses was read, and thus the ordinances in question were so deeply impressed upon the people's mind that they could not tolerate the neglect of them by the Gentile Christians. Instead of laying upon the Gentiles the burden of the whole law, and consequently of circumcision, the convention of apostles and elders resolved to enforce upon them only the reception of certain individual precepts of easy observance. The object of this canon was plainly nothing but to meet in some measure the difficulties of the Jewish Christians, and to lead the Gentile Christians to shun whatever might prove offensive to their Jewish brethren, as otherwise, under the existing usages and prejudices of education and caste, it would be impossible for them to associate together in a mixed community and church without scandal. In all this it was clearly indicated that the prohibitions were not absolute; once let the Jewish Christians be more thoroughly freed from the O.-T. forms, and the end for which these regulations were made would no longer exist. Now the ground on which these particular points were brought into view is explained by the circumstance that they were wont to be laid upon the proselytes of the Gate in the so-called "*seven precepts of Noah*" (comp. Buxtorf, *Lex. Rab. s. v.* נִבְרָא, p. 407 sq.). See PROSELYTE. This, therefore, is the import of the arrangement, that the Gentile Christians should not be obliged to become "proselytes of righteousness" by circumcision, but only to live as "proselytes of the Gate." Those of the seven precepts of Noah (see NOAH, PRECEPTS OF), which are here omitted, viz. the ones regarding blasphemy, murder, robbery, and sedition, was of such a kind that it was self-evident to Christians that the like could have no place among them; in the present instance it was not so much precepts of a purely moral character that required to be brought forward, as precepts that referred simply to the outward life. See APOSTOLICAL COUNCIL.

1. That the "pollutions of idols" (*ἀλισθήματα τῶν εἰδωλῶν*) are thus to be understood of an outward act,

viz. the eating of the flesh of sacrifices, is quite clear from the analogous expression, "things offered to idols" (*εἰδωλόθυστα, idol-sacrifices*), in the parallel verse. The more particular distinction made by Paul in 1 Cor. x, between such flesh of sacrifices as was bought like any other in the shambles and such as was eaten in the temple at an idol festival, is not entered into by the assembly; they interdict in the widest sense all eating of sacrifices because the Jews took offence at it. See ALISGEMA.

2. The same holds good of the eating of blood, and which is the same thing, of that which was strangled, in which the blood remained coagulated. The Jews had the utmost abhorrence of blood as food, which was grounded particularly upon Lev. xvii, 10, 11, where it is not merely said that Jehovah would set his face against the perpetrator of this act, but the blood is also represented as the support of the soul (comp. Gen. ix, 4), that is, of the physical life, and it is placed in connection with the propitiation, which can only be made by the shedding of blood (Heb. ix, 22). This law appears to have been strictly observed by the primitive Church (Euseb. *Hist. Eccl.* v, 1), and even in the Middle Ages the injunction was frequently given by the spiritual authorities to avoid the eating of blood (especially in the Greek Church; see canon 67 of the second Council at Trullo in 692; in the Latin Church, Augustine already took the right view, *constr. Faustianum*, xxxii, 18). See BLOOD.

3. The mention of fornication (*πορνεία*) appears to be quite foreign to the nature of the other injunctions, and opposed to the above view of these apostolical ordinances. It blends a purely moral precept with enactments that refer only to matters of outward observance. The conjectural emendation (*πορτεία, or χορτεία, for πορνεία*, in both passages) that proposes to refer this clause to the eating of swine's flesh is negated by the fact that no such abstinence is alluded to in the Noachian precepts; and the forced explanation of the term (*πορνεία for Σωβία πορνικῆς*), as alluding to a sacrifice purchased by the hire of a harlot, is sufficiently refuted by the objection that this would refer to a state of matters so grossly sinful as could not be thought of among Christians. Undoubtedly the only proper course is to bring into view the greater freedom of intercourse between the sexes that prevailed among the Greeks and Romans, which was an abomination to the more serious Jews, and appeared to them, in fact, a refined species of harlotry. By the word in question, therefore, which comprehends not only gross violations of the seventh commandment, but also more polished sins of this kind, the assembled brethren enjoin upon the heathen Christians greater care and circumspection in their intercourse with the female sex, that they might give no offence to the Jewish Christians (Olshausen, *Comment.* in loc. iii, 336, Am. ed.). Another reason for the insertion of this rule respecting chastity probably was the shameless violation of purity that every where took place in connection with the pagan festivals, and constituted an additional reason for a total disconnection with all idolatrous rites (Conybeare and Howson, *St. Paul*, i, 217). See Schaff, *Apost. Church*, § 69; and FORNICATION.

Among special treatises on this subject are the following: Bagge, *Περὶ ἀλισθημάτων* (Jen. 1748); Benzell, *De decreto apostolico* (Lond. 1788); Dannhauer, *Διατίψεις concilii Hieros.* (Argent. 1648); Deyling, *De πορνείᾳ vetita* (in his *Obss. sacr.* ii, 469 sq.); Döderlein, *De sensu decreti apost.* (Bützov. 1769 sq.); Dornscheus, *De sanguine et suffocato* (Rostock, 1688); Hassaen, *id.* (Brem. 1708); Moebius, *id.* (Lips. 1688); Hanneken, *De sanguine escario* (Gieass. 1678); Heidegger, *In concil. Hieros.* (Tigur. 1678); *id.* *De sanguine et suffocato* (Amst. 1662); Langguth, *De concil. apost. canonem* (Erf. 1681); Leonhard, *De decreto conc. Hieros.* (Jen. 1725); Nitzsch, *De decreto apostolico* (Viteb. 1796; also in Vel-

thuseit *Comment.* vi, 885-418); Nösselt, *De conc. Hieros.* (Lips. 1678); Schöttgen, *De ritibus in synode Hieros. prohibitis* (Starg. 1723); Velthuis, *Hist. conc. Hieros.* (Jen. 1693); Wandalin, *Circa sanguinem eucarism.* (Viteb. 1678); Carpov, *De controversiis theologis* (Lips. 1695); Kripner, *De esca idolis immolatorum* (Jen. 1720); Crusius, *De lege Mosaca inter Christianos* (Lips. 1770); Weemse, *The seven Precepts of Noah* (in his *Exposition*, ii, 40); Spence, *De Legib. Hebr.* i; Barrington, *Works*, ii, 265; Nind, *Sermons*, ii, 27; Wedgwood, *Decrees of the holy Apostles* (Lond. 1851). See COUNCIL OF APOSTLES.

DECREE OF GOD. See PREDESTINATION.

Decretals, letters from the popes of Rome deciding points of ecclesiastical law. For the history and collection of the decretals, see CANON LAW; CLEMENTINES. The decretals compose the chief part of the canon law.

DECRETALS, PSEUDO-ISIDORIAN. By this name a collection of spurious letters of popes is designated. They were first brought into use in the 9th century, in connection with the so-called Spanish collection of canons and decrees. See CANONS. The author of this collection placed at its head a spurious preface of Isidore Mercator (according to some manuscripts, *Peccator*), and for this reason they were ascribed, as early as the 9th century, to Isidore of Seville (q. v.). During the Middle Ages they were generally considered genuine, but in the 15th century doubts of their genuineness were expressed by Nicholas de Cusa [see CUSA] and others, and in the 16th the Magdeburg centuriators (q. v.) and other Protestant historians so conclusively established their spuriousness that it is now admitted even by Roman Catholic writers. The birth-place, age, author, and motives of these letters are still controverted questions, and have called forth a large number of thorough investigations, by which several important points have been established with a high degree of probability. There is a large number of manuscripts (more than fifty) of this collection extant, and it is believed that a more careful study and comparison of them will lead to new results. The order of the documents, according to Codex Vaticanus (No. 680), a manuscript of the 12th century, is as follows: The preface is followed by a letter of Aurelius to Damasus, and the answer of the latter, both spurious; the *Ordo de celebrando concilio*, borrowed from the fourth Council of Toledo; a list of councils, and a spurious correspondence between Jerome and Damasus. Then begins Part I, consisting of 50 apostolic canons; 59 spurious letters of the popes, from Clement to Melchisedes (in chronological order); a treatise, *De primitiva ecclesia et synodo Nicæna*, and the spurious *Donation* of Constantine. Part II begins with a section of the preface of the genuine Spanish collection of canons, and another section of the collection of Quænel, and contains the Greek, African, Gallic, and Spanish councils, agreeing in all essential points with the Spanish collection. Part III begins likewise with a section of the preface of the genuine collection, which is followed by the decretals of the popes from Sylvester to Gregory II († 781); among them 85 spurious ones. The total number of spurious decretals in the collection is 94. Whether all of them belonged to the original collection, or whether a part were of later manufacture, is still a controverted point. The sources used by the compiler are the works of Cassiodorus and Rufinus, the *Liber Pontificalis*, the *Vulgata*, the works of the fathers, the theological literature up to the 9th century, the genuine decretals and decrees of councils, the so-called *Capitula Angilrami* (q. v.), and the Roman law collection, especially the Visigothic *Breviarium Alaricianum* (see Knust, *de fontibus et consilio Ps. Isidoriana collectionis*, Göttingen, 1832). The opinion of Rosshirt (*Zu den kirchenrechtlichen Quellen des ersten Jahrtausends und zu den pseudo-*

isidorischen Decretalen, Heidelberg, 1849) that the compilers used many more sources than are now known, and that most of the papal letters which are now generally considered as spurious were probably taken from other collections, has not met with much approval.

As this collection was used by the popes with great effect to amplify their power over the bishops, it was long a common opinion that the compilers aimed chiefly at confirming and enlarging the papal power; but this opinion is now universally abandoned. Other especially modern Roman Catholic writers, as Möhler, Walter, and Hefele, attribute to the falsifier the "wish to put an end to the confusion and servitude of the Church and the uncertainty of law in his times, by introducing a uniform code of ecclesiastical discipline, clothed with the prestige of antiquity." The most common opinion at present is that the compiler wished to fix the episcopal power from dependence on the state, and to weaken, for the same purpose, the influence of the metropolitans and provincial synods. With regard to the time of the compilation, it has been established with certainty that it falls between 829 and 857. The author is not yet known. Benedict Levita, Otgar, archbishop of Mainz, and others, have been assumed. The place where it was compiled was most probably the western part of the Frankish empire. The first mention of the collection is made in the proceedings of the Synod of Chiersy, in 857; and a few years later pope Nicholas I used it efficiently in his controversy with Hincmar, archbishop of Rheims. After the end of the 9th century numerous extracts were made, and they were received into all the large collections of canons [see CANONS] made during the Middle Ages. As regards the influence of the false decretals, it has been overrated by those who believe that the primacy of the Roman popes is mainly due to this vast fraud; and on the other hand, it is underrated by the Roman Catholic writers, who maintain that the pseudo-decretals produced no change in the discipline of the Church and were only an expression of the tendencies of these times, which, without them, would have been developed in the same manner. The truth, as has been already intimated, probably is, that the pseudo-decretals were compiled for the purpose of furthering episcopal tendencies, in opposition to the rights of metropolitans and provincial synods, but that they also greatly contributed to the development of the Roman primacy, and were unscrupulously used by the popes for this purpose.

There are two editions of the false decretals, the first in the Collection of Councils by Merlin (tom. i. Paris, 1528), and the second in Migne's *Patrologia Latina*. cxxx (Paris), which is only a reprint of the former. See Ballerini (*Opp. Leon.* tom. iii, p. cxxv. ss.); Theiner, *De pseudoisidoriana canonum collectio* (Bresl. 1836); Wassersleben, *Beiträge zur Geschichte der falschen Decretalen* (Breslau, 1844); Möhler, *as und über Pseudoisidor* (in his *Gesammelte Schriften*, Regensb. 1838, vol. i); Götfröer, *Pseudoisidor* (in *Freiburger Zeitschrift für Theologie*, vol. xvii); Weissäcker, *Hincmar und Pseudoisidor* (in *Zeitschrift für theologische Literatur*, 1858); and the *Manual of Ecclesiastical Law* by Richter, Walter, Rosshirt, Phillips, and others.

Decuriones, magistrates in the Roman provinces, who formed a body to represent the Roman Senate in free and corporate towns. Each *decursio* consisted of ten persons; and their duty was to watch over the interests of their fellow-citizens, and to increase the revenues of the commonwealth. The early Church was compelled to make laws to prevent the ordination of any man of this class as a presbyter or deacon. Instances had occurred in which presbyters had been compelled, after thirty years' service as ministers of Christ, to resume their *curial* offices. In some cases, after ordination, they were required to serve as *flamines* and were crowned as heathen priests, while they exhibited the public games and shows to the people.

law forbidding the ordination of such persons was cited to prevent this scandal.—Bingham, *Orig. Eccl.* iv, ch. iv, § 4.

De'dan (Heb. *Dedan'*, דֵּדָן, according to Gesenius, *es. Heb.* p. 822, from the Arab. signifying *sport*; according to Fürst, *Hebr. Hamw.* p. 288, by reduplication in דֵּדָן, in the sense of *deep*; in Ezek. xxv, 13, with local or paragogic, *Deda'neh*, דֵּדָן־נָה, "they of De-"), the name of one or two men or tribal progenitors. See also DODANIM.

1. (Sept. *Δαδάν, Δαυδάν*). A son of Raamah, son of Ah (Gen. x, 7; 1 Chron. i, 9, "the sons of Raamah, eba, and Dedan"). B.C. considerably post 2518. a CUSH. His descendants are perhaps mentioned in Isaiah (xxi, 18) and Ezekiel (xxvii, 15, Sept. 'Povv v. r. *Απαδων*; 20, Sept. *Δαυδάν* v. r. *Δεδάν*; xxviii, 13, Sept. *Δαυδάν*; xxv, 13, Sept. *Δεδάν* or *υδάν* v. r. *δωκόμενοι*). See below.

2. (Sept. *Δαυδάν*, v. r. in Jer. xlix, 8, *Δαυδάν*). A son of Jokshan (1 Chron. i, 82), son of Keturah (Gen. cv, 3; "Jokshan begat Sheba and Dedan; and the sons of Dedan were Asshurim, Letushim, and Leumim"). B.C. post 1988. The usual opinion respecting this and the preceding founder of tribes is that the first settled among the sons of Cush, probably on the borders of the Persian Gulf; the second on the Syrian borders, about the territory of Edom (Michaelis, *Spicileg.* i, 201 sq.). But Vater (*Comment.* i, 120, followed by Gesenius, *Theo. Heb.* p. 822) has suggested that the same may apply to one tribe, and this may be adopted as probable on the supposition that the descendants of the Keturahite Dedan intermarried with those of the Cushite Dedan. See ARABIA. The theory of this mixed descent gains weight from the fact that in each case the brother of Dedan is named Sheba. It may be supposed that the Dedanites were among the chief traders traversing the caravan-route from the head of the Persian Gulf to the south of Palestine, bearing merchandise of India, and possibly of Southern Arabia, and hence the mixture of such a tribe with another of different (and Keturahite) descent presents no impossibility. The passages in the Bible in which Dedan is mentioned (besides the genealogies above referred to) are contained in the prophecies of Isaiah, Jeremiah, and Ezekiel, and are in every case obscure. The Edomitish settlers seem to be referred to in Jer. xlix, 8, where Dedan is mentioned in the prophecy against Edom; again in xxv, 23, with Tema and Buz; in Ezek. xxv, 13, with Teman, in the prophecy against Edom; and in Isa. xxi, 13 ("The burden upon Arabia. In the forest in Arabia shall ye lodge, O ye travelling companies of Dedanim"), with Tema and Kedar. This last passage is by some understood to refer to caravans of the Cushite Dedan; and although it may only signify the wandering propensities of a nomad tribe, such as the Edomitish portion of Dedan may have been, the supposition that it means merchant-caravans is strengthened by the remarkable words of Ezekiel in the lamentation for Tyre. This chapter (xxvii) twice mentions Dedan; first in ver. 15, where, after enumerating among the traffickers with the merchant-city many Asiatic peoples, it is said, "The children of Dedan were thy merchants, many isles (יַמֹּת) were the merchandise of thine hand: they brought thee for a present horns of ivory, and ebony." Passing thence to Syria and western and northern peoples, the prophet again (in ver. 20) mentions Dedan in a manner which seems to point to the wide spread and possibly the mixed ancestry of this tribe. Ver. 15 may be presumed to allude especially to the Cushite Dedan (comp. ch. xxxviii, 18, where we find Dedan with Sheba and the merchants of Tarshish; apparently, from the context, the Dedan of chap. xxvii, 15); but the passage commencing in v. 20 appears to include the settlers on the borders of Edom (i. e. the Keturahite Dedan). The

whole of the passage is as follows: "Dedan [was] thy merchant in precious clothes for chariots. Arabia, and all the princes of Kedar, they occupied with thee in lambs, and rams, and goats; in these [were they] thy merchants. The merchants of Sheba and Raamah they [were] thy merchants: they occupied in thy fairs with chief of all spices, and with all precious stones, and gold. Haran, and Canneh, and Eden, the merchants of Sheba, Asshur, [and] Chilmad, [were] thy merchants" (Ezek. xxvii, 20-23). We have here a Dedan connected with Arabia (probably the north-western part of the peninsula) and Kedar, and also with the father and brother of the Cushite Dedan (Raamah and Sheba), and these latter with Asiatic peoples commonly placed in the regions bordering the head of the Persian gulf. This Dedan, moreover, is a merchant, not in pastoral produce, in sheep and goats, but in "precious clothes," in contradistinction to Arabia and Kedar, like the far-off Eastern nations who came with "spices, and precious stones, and gold," "blue clothes and brodered work," and "chests of rich apparel."

The probable inferences from these mentions of Dedan support the argument first stated, namely, 1. That Dedan, son of Raamah, settled on the shores of the Persian gulf, and his descendants became caravan-merchants between that coast and Palestine. 2. That Jokshan, or a son of Jokshan, by intermarriage with the Cushite Dedan, formed a tribe of the same name, which appears to have had its chief settlement in the borders of Idumæa, and perhaps to have led a pastoral life.

All traces of the name of Dedan, whether in Idumæa or on the Persian gulf, are lost in the works of Arab geographers and historians. The Greek and Roman geographers, however, throw some light on the eastern settlement; and a native indication of the name is presumed to exist in the island of *Dadan*, on the borders of the gulf (see Bochart, *Phaleg*, iv, 6; Assemani, *Bibl. Orient.* III, i, 146, 153; ii, 184, 560, 564, 604, 744; Bütsching, *Asia*, p. 562; Wahl, *Descr. Asia*, p. 689; Niebuhr, *Arabien*, p. 808 sq.; Hoeren, *Ideen*, I, ii, 227, 419; Barboea, *Ramusio raccolte*, i, 288). The identification must be taken in connection with the recovery of the name of Sheba, the other son of Raamah, on the island of Awâl, near the Arabian shore of the same gulf.—Smith, s. v. See RAAMAH.

Ded'anîm (Heb. *Dedanîm'*, דֵּדָנִים, a patril from *Dedan*; Sept. *Δαυδάν*), the descendants of the Arabian DEDAN (q. v.), spoken of (Isa. xxi, 13) as engaged in commerce. Some, however, following the various rendering of the versions (Michaelis, *Spicileg.* i, 115 sq.), have thought the *Rhodiens* to be meant, and others have even conjectured an allusion to the *Dodona*, a famous oracle of Epirus (Strabo, vii, 504-7, ed. Almelon.).

Dedicate (prop. דָּקַדַּק, *chanak'*, to initiate, Dent. xx, 5; 1 Kings viii, 63; 2 Chron. vii, 5; elsewhere דִּקְדַּקְתִּי, *hakdîsh'*, to hallow, and other Heb. terms), a religious ceremony whereby any thing is dedicated or consecrated to the service of God; and it appears to have originated in the desire to commence, with peculiar solemnity, the practical use and application of whatever had been set apart to the divine service. Thus Moses dedicated the tabernacle in the wilderness (Exod. xl; Num. vii); Solomon his Temple (1 Kings viii); the returned exiles theirs (Ezra vi, 16, 17); Herod his (Josephus, *Ant.* xv, 11, 6). The Maccabæe, having cleansed the Temple from its pollutions under Antiochus Epiphanes, again dedicated the altar (1 Macc. iv, 52-59), and an annual festival was established in commemoration of the event. This feast was celebrated not only at Jerusalem, but everywhere throughout the country, in which respect it differed from the feasts of the Passover, Pentecost, and Tabernacles, which could only be observed at Jerusalem. See below.

Not only were sacred places thus dedicated, but some kind of dedicatory solemnity was observed with respect to cities, walls, gates, and even private houses (Deut. xx, 5; Psa. xxx, title; Neh. xii, 27). We may trace the continuance of these usages in the custom of consecrating or dedicating churches and chapels, and in the ceremonies connected with the "opening" of roads, markets, bridges, etc., and with the launching of ships.—Kitto, s. v. See CONSECRATION.

DEDICATION, THE FEAST OF THE (*τὸ ἑορτασμός, the renewal*, John x, 22 [which the Sept. has in Num. vii, 10]; Vulg. *encensio*), the festival instituted to commemorate the purging of the Temple and the rebuilding of the altar after Judas Maccabæus had driven out the Syrians, B.C. 164 (1 Macc. iv, 52-59, where it is *ἑορτασμός τοῦ ὑψωτηρίου, the restoration of the altar*, because the old and profaned altar was then replaced; but in 2 Macc. x, 5, *ἡ καθάρσις τοῦ ναοῦ, the purification of the Temple*: the modern Jews call it simply *chanukah*, חנוכה [“dedication,” as occurs in Num. vii, 10, 11, 84, 88; 2 Chron. vii, 9; Neh. xii, 27; Psa. xxx, title; Ezra vi, 16, 17; Dan. iii, 2, 3], as in the *Mishna*; but Josephus, *Ant.* xii, 7, 7, styles it *φῶρα, lights*). The following account of it is chiefly from Kitto, s. v. See ANTIOCHUS EPIPHANES.

Made in which this Festival was and still is celebrated.—It commenced on the 25th of Chisleu (see CALENDAR, JEWISH), and lasted eight days, but it did not require attendance at Jerusalem. (Jesus, however, was present there during this season, *χρῆστος*, or winter, John x, 20.) It was an occasion of much festivity. The Jews assembled in the Temple or in the synagogues of the places wherein they resided (*Rosh ha-Shana*, xviii, 2), carrying branches of trees and palms in their hands, and sang psalms to the God of their salvation. No fast or mourning on account of any calamity or bereavement was permitted to commence during the festival (*Mishna*, *Taanith*, ii, 10; *Moed Katon*, iii, 9); the Temple and all private houses were lighted up within and without by lanterns and torches every evening during the eight days in token of this joy (1 Macc. iv, 52-59; 2 Macc. x, 6, etc.; *Mishna*, *Baba Kama*, v, 6), for which reasons Josephus also calls it *λύχνων ἀνακρίσις, the Feast of Lamps* (comp. *Ant.* xii, 7, 7, with *Apion*, ii, 89). Maimonides, in discouraging upon this subject, distinctly declares that “the lighting up of the lamps is a commandment from the scribes.” “The order is,” says he, “that every house should light one light, whether the inmates thereof be many or only one. He, however, who honors the injunction has as many lights as there are inmates in the house—he has a light for every man and woman. And he who respects it still more adds a light for every individual every night, so that if a house wherein are ten inmates began with ten lights, it would end with eighty” (*Mishna*, *Torah Hùchoth Megillah Ve-Chanukah*, sec. iv, p. 826, b). These lamps must be lighted immediately after sunset by the head of the family, who pronounces the three following benedictions: 1. “Blessed art thou, Lord our God, King of the world, who hast sanctified us with thy commandments, and enjoined upon us to light the lamps of the Feast of the Dedication.” 2. “Blessed art thou, Lord our God, King of the world, who hast done wonders for our forefathers in those days about this time;” and, 3. “Blessed art thou, Lord our God, King of the world, who hast preserved us in life and health, and hast permitted us to see this day!” The third benediction, however, is only pronounced on the first day of this festival. The practice of illumination in connection with this festival is, as we have seen, of very old date, and was most probably suggested by the fact that “the lamps which were upon the candlestick” were lighted by the people at the restoration of the Temple service (1 Macc. iv, 50, 51), as well as by the natural aling existing among most nations to have illumina-

tions on occasions of great joy. The Egyptians also had a similar festival (Herod. ii, 62). *Mishna* of very great antiquity, however, give another reason for this custom of lighting lamps. They tell us that “when the Maccabees went into the Temple after vanquishing the enemy, and wanted to light the candlestick, they could not find any oil, except one vial, and it was sealed with the ring of the high-priest, which assured them that it was not polluted, but was just enough to light one day. Whereupon God, whose glory dwelleth in the heavens, blessed it, so that they were able to feed the lamps therein for eight days. Wherefore the Maccabees and all the people, like one man, have ordained that these eight days should henceforth be days of joy and rejoicing like the festivals ordained in the law, and that lamps should be lighted on those days, to make known the wondrous works which the God of the heavens hath wrought for them” (*Megillah Antiochus*, p. 155 of Jellinek; Talmud, *Sabbath*, 21, b). Now, whatever we may think about the embellishments of this story, it is not at all unlikely that a vial of oil was actually discovered in the Temple just at a time when it was most wanted, and that this is one of the reasons why the lighting of lamps has been instituted.

At every morning prayer during the whole of the festival, a portion of the 7th chapter of Numbers is read in the synagogue by the preacher, in accordance with a very old custom (*Mishna*, *Megilla*, iii, 6); thus on the first day, Num. vii, 1-17, is read after the regular lesson of the Pentateuch, if it is a Sabbath at the Haphtorah, or the portion from the Prophets, *I. Zech. ii*; on the second, Num. vii, 18-23, is read beginning with “On the second day,” etc., and the same Haphtorah; on the third day, Num. vii, 24-29, is the same Haphtorah, and so on. In the Temple at Jerusalem, the “Hallel” was sung every day of the feast. Connected with this festival is the celebration of the exploits performed by Judith (q. v.) upon Habiner, because, as some suppose, she was of the stock of the Maccabees. Hence some of the *Mishna* which give the history of Judas Maccabæus mix it with it the history of Judith.

Modern Jews keep the feast of lights very strictly, but servile work is not forbidden to be done. The feast is observed as one of rejoicing for the wonders which God wrought for them. During the eight days parents and children amuse themselves in different innocent games, particularly the last night, when neighbors and friends meet together to enjoy themselves. The Karaites, however, do not observe this festival, because it is an uninspired ordinance.

There are four other dedications of the Temple recorded:

1. The dedication of the Solomonic Temple (1 Kings viii, 2; 2 Chron. v, 8), which took place in the seventh month, or in the autumn. B.C. 1008. This was coincident with the *Feast of Tabernacles* (q. v.).

2. The dedication at the time of Hezekiah, when the Temple was purified from the abominations which his father Ahaz introduced into it (2 Chron. xxxix). B.C. 726. See HEZEKIAH.

3. The dedication of Zerubbabel's Temple, built after the captivity (Ezra vi, 16), which took place in the month Adar, in the spring. B.C. 517.

4. The dedication of Herod's Temple (Josephus, *Ant.* xv, 11, 6). B.C. 22. Some of the fathers have therefore thought that Jesus is said to have gone to the celebration commemorative of the dedication of Solomon's Temple or of Zerubbabel's. The fact, however, that there was no annual festival to commemorate these dedications, and that the evangelist John distinctly says that it was in the winter, establishes it beyond doubt that our Lord went to the Feast of the Dedication instituted by Judas Maccabæus. See TEMPLE.

Literature.—Maimonides, *Mishna Torah*, or *Yad Ha-Chasaca*; *Hùchoth Megilla Ve-Chanukah*, sec. 3 and 4;

villath Antiochus, printed in Bartolucci, *Bibliotheca græca*, i, 882, etc.; Midrash, *Le-Chanukah*, and Mid-
 1, *A char le-Chanukah*, published by Dr. Adolph Jek-
 in *Beth ha-Midrash* (Leipzig, 1858), i, 182, etc.
 s volume also contains (p. 142, etc.) a reprint of
villath Antiochus. See also the volumes quoted in
 article, and in Fabricius, *Bibliog. Antiquar.* p. 419

Likewise Otho, *Lex. Rab.* p. 298 sq.; Lightfoot
 Wetstein, in loc. Joh.; Wähner, *De festo Encami-
 nis* (Helmst. 1715); Weber, *De Encamnis* (Lips. 1688);
 ans, *De jure circa Encamnia* (Erf. 1718); and the
 itises *De Encamnis templorum*, by Dannenberger
 ps. 1754), Lincke (Aldorf, 1678), Lund (Upsal.
 6), Reich (Aldorf, 1718). See FESTIVALS.

Dedication of Churches. See CONSECRATION.

De Dieu. See DIEU, DE.

De Dominis. See DOMINIS, DE.

Deep (the representative in the A. V. of several
 b. words, especially דְּפִי, *tehom*, Gen. i, 2, etc. an
 ys, often rendered "depth;" ἀβύσσος, Luke viii,
 ; Rom. x, 7, elsewhere "bottomless pit"). The
 ep, or the great deep, in its literal sense, signifies,
 efly in Scripture—1. Hell, the place of punishment,
 e bottomless pit (Luke viii, 31; Rev. ix, 1; xi, 7).
 The common receptacle of the dead; the grave, the
 ep or depths of the earth, under which the body is
 osited: the state of the soul corresponding there-
 , still more unseen, still deeper, still further dis-
 nt from human inspection, is that remote country,
 at "bourne from whence no traveller returns" (Rom.
 .7). 3. The deepest parts of the sea (Psa. lxxix, 15;
 ii, 26). 4. The chaos, which, in the beginning of
 e world, was unformed and vacant (Gen. i, 2). See
 BYSS.

Deer. Although this word occurs in the English
 ible only in the connection "FALLOW DEER" (q. v.),
 properly represents several terms in the original,
 hich are variously translated, and which denote wide-
 y different members of the antelope and cervic fami-
 es. See CHAMOIS; GOAT; OX; PYGARG; ROE, etc.
 or the proper *deer* we find the following variations
 f the same word: *ayyal* (אֵייל), an intensive of אֵיל,
 . d. a large *ram*; Sept. *ἄλαφος*, the male, always
 ended "hart" (q. v.), occurs Deut. xii, 15, 22; xiv,
 ; xv, 22; 1 Kings iv, 23; Psa. xlii, 1; Cant. ii, 9,
 7; viii, 14; Isa. xxxv, 6; Lam. i, 6: *ayyalah* (אֵיילָה),
 en. xlii, 21; 2 Sam. xxii, 34; Job xxxix, 1; Psa.
 xviii, 33; xxix, 9; Cant. ii, 7; iii, 5; Hab. iii, 19),
 r *ayyeleth* (אֵיילֶת), Prov. v, 19; Jer. xiv, 6), the fe-
 male, always rendered "hind" in our version (Sept.
 πτελεχος). Many recent writers, however, either sup-
 ose different species of antelope to be meant, or, with
 Dr. Shaw, consider the term to be generic for several
 species of deer taken together. Sir J. G. Wilkinson
 believes the *ayyal* to be the Ethiopian *oryx*, with near-
 ly straight horns. See ANTELOPE. It should be ob-
 served, however, that an Ethiopian species could not
 well be meant where the clean animals fit for the food
 of the Hebrews are indicated, nor where allusion is
 made to suffering from thirst, and to high and rocky
 places as the refuge of females, or of both, since all
 the species of *oryx* inhabit the open plains, and are
 not remarkable for their desire of drinking; nor can
 either of these propensities be properly ascribed to the
 true antelope, or gazelle, of Arabia and Syria, all be-
 ing residents of the plain and the desert; like the *or-
 yx*, often seen at immense distances from water, and
 unwilling to venture into forests, where their velocity
 of flight and delicacy of structure impede and destroy
 them. Taking the older interpretation, and review-
 ing all the texts where hart and hind are mentioned,
 we find none where these objections truly apply. An-
 imals of the stag kind prefer the security of forests,
 are always most robust in rocky mountain covers, and

seek water with considerable anxiety; for of all the
 light-footed ruminants, they alone protrude the tongue
 when hard pressed in the chase. Now, comparing
 these qualities with several texts, we find them per-
 fectly appropriate to the species of these genera alone.
Ayyal appears to be a mutation of a common name
 with *ἄλαφος*; and although no great stress should be
 laid on names which, more particularly in early times,
 were used without much attention to specific identity,
 yet we find the Chaldee *ajal* and Sarmatic *jelen* strict-
 ly applied to stag. Hence the difficulty lay in the
 modern denial that ruminants with branched decidu-
 ous horns existed in the south-west of Asia and Egypt;
 and Cuvier for some time doubted, notwithstanding
 Virgil's notice, whether they were found in any part
 of Africa; nevertheless, though not abundant where
 water is rare, their existence from Morocco to the Nile,
 and beyond it, cannot be denied; and it is likely that
 an Asiatic species still appears sometimes in Syria, and,
 no doubt, was formerly common there (see the *Penny
 Cyclopædia*, s. v. Deer).



Barbary Deer.

1. The species usually referred to by the above Heb.
 terms is probably that now known by the name of
Cervus barbarus, or Barbary stag, in size between the
 red and fallow deer, distinguished by the want of a
 bisantler, or second branch on the horns, reckoning
 from below, and by a spotted livery, which is effaced
 only in the third or fourth year. This species is fig-
 ured on Egyptian monuments, is still occasionally seen
 about the natron lakes west of the Nile, and, it seems,
 has been observed by travellers in the desert east
 of the Dead Sea, on the route from Cairo towards Da-
 mascus. We take this to be the *igial* or *ajal* of the
 Arabs, the same which they accuse of eating fish—that
 is, the ceps, lizards, and snakes, a propensity common
 to other species, and similarly ascribed to the Virginian
 and Mexican deer.

2. Another species is the Persian stag, or *maral* of
 the Tahtar nations, and *gewasen* of Armenia, larger
 than the stag of Europe, clothed with a heavy mane,
 and likewise destitute of bisantlers. We believe this
 species to be the *sodgur* of Asiatic Turkey, and *marā*
 of the Arabs, and therefore residing on the borders of
 the mountain forests of Syria and Palestine. One or
 both of these species were dedicated to the local *bona
 dea* on Mount Libanus—a presumptive proof that deer
 were found in the vicinity.

Of the *hind* it is unnecessary to say more than that
 she is the female of the stag, or hart, and that in the
 manners of these animals the males are always the last
 to hurry into cover.—Kitto, s. v. See STAG.

Deering. See DERING.

Defence. This word, besides its ordinary and
 proper use, stands in the English Bible as a mistrans-
 lation of two Heb. terms.

1. *Mator* (מָטוֹר), in connection with מַיִם, streams,

rendered in 2 Kings xix, 24, "rivers of besieged places," Sept. *ποταμοὶ συνοχής*, Vulg. *agua clausa*; in Isa. xix, 6, "brooks of defence," Sept. *ὕδατος τοῦ ποταμοῦ*, Vulg. *river aggerum*; in Isa. xxxvii, 25, "rivers of the besieged places," Sept. *ὕδατος τοῦ ποταμοῦ*, Vulg. *river aggerum*, a proper name for Egypt, alluding to its canals, i. e. the branches of the Nile. The derivation of the term is obscure; perhaps it is only another application of the Heb. word of the same form, elsewhere signifying (literally *straitness*, hence) a *mound* or *fortification*, and applied to Egypt, especially Lower Egypt, as being strongly fortified, both by nature and art. See MAZOR.

2. *Be'teer* (בַּעַתֵּר), probably something dug out of a mine, occurring only in Job, and rendered in chap. xxii, 24, "gold," Sept. *πέρρα*, Vulg. *stlex*; in ver. 25, "defence," Sept. *βοηθός ἀπὸ ἐχθρῶν*, Vulg. *contra hostes*; in chap. xxxvi, 19, "gold," Sept. *ὄψαρὸς ἐν ἀνάγκῃ*, Vulg. *tribulation*, precious ore, i. e. of gold or silver, in its native state; an interpretation evidently required by the corresponding terms in the parallel members of the hemistichs where it occurs. See GOLD.

Defence of Christianity. See APOLOGY.

Defender of the Faith (*fidei defensor*), a title belonging to the sovereign of England, as *Catholicus* does to the king of Spain, and *Christianissimus* to the king of France. It was originally conferred by Leo X on Henry VIII for his work against Martin Luther; and the bull for it bears date *quinto idus Octob.* 1521. It was afterwards confirmed by Clement VII. On Henry's suppression of the monasteries, the pope of Rome deprived him of this title, and deposed him from his throne. The English Parliament (35 Henry VIII, ch. 8) confirmed the title, and it has ever since been used by English monarchs.

Defensor matrimonii, an officer of the Roman Church in every diocese, whose duty it is, in cases where a marriage is claimed to be null, to search for and produce the proofs of its validity, and to follow the case into any court to which it may be carried by appeal, with the right of originating such an appeal himself in cases where, through some defect in the proceedings or in the testimony, a verdict of nullification has been granted upon insufficient grounds. The office was instituted by Benedict XIV by his bulls of Aug. 26, 1741, and Nov. 8, 1741 (*Bullar. Magn. tom. xvi, p. 41, 48*).

Defile (denoted by several Heb. and Gr. words, especially *טָמֵא*, *tamé*, *μαίνω*, denoting *filthiness*, but spoken chiefly in a figurative or ceremonial sense). Many were the blemishes of person and conduct which, under the Mosaic law, were esteemed defilements; some were voluntary, others involuntary; some originated with the party, others were received by him; some were inevitable and the effect of nature, others the consequences of personal transgression. Under the Gospel, defilements are those of the heart, of the mind, the temper, and the conduct. Moral defilements are as numerous, and as thoroughly prohibited under the Gospel as ever; but ceremonial defilements are superseded as requiring any religious rites, though many of them claim attention as usages of health, decency, and civility (Matt. xv, 18; Gen. xlix, 4; Rom. i, 24; James iii, 6; Ezek. xliii, 8). See POLLUTION.

Degerando. See GERANDO, DE.

Degradation, in ecclesiastical law, the act of depriving a clergyman of his orders, or the act of deposing an offender from a higher to a lower grade of office. In the case of bishops, this degradation consisted in removal from a larger and more important see to one smaller or less considerable. Presbyters were degraded to the rank of deacons, and deacons to that of subdeacons. This kind of punishment was also inflicted on bishops in Africa by superseding them in their ex-

pected succession to the office of archbishop or metropolitan. In later times, *degradation* implied privation of all authority and station. An instance of ecclesiastical degradation in the eighth century at Constantinople is recorded. The patriarch Constantine was not to ascend the *ambo*; he was stripped by the bishops of his pallium, and anathematized; he was then made to walk out of the church backwards. When Cresset, archbishop of Canterbury, was degraded by order of queen Mary, his persecutors dressed him in episcopal robes made of canvas, put the mitre on his head at the pastoral staff in his hand; and in this attire degraded him to the people. They then stripped him piecemeal. On the Roman forms of degradation, see Elliott, *Delineation of Romanism*, bk. ii, ch. xv (last edition); see also Bingham, *Orig. Eccl.* bk. xvii, c. ii; Canon 122 of *Church of England*; Augusti, *Græc. Archaeologie*, iii, 401, and the article DEPOSITION.

Degree is the rendering in the A. V. of one Heb. and one Gr. term (besides being employed as a conjunct in the phrases "man of high [or low] degree," where it has no [other] correspondent in the original. מַעְלָה מַעְלָה, *ma'alah* (2 Kings xx, 9, 10, 11; Isa. xlviii, 8, referring to the graduated scale of the dial [q. v.] of Ahas, and in the titles of the Psalms entitled "Song of Degrees" [see below]; a *step*, as elsewhere generally rendered; *βαθμὸς* (only 1 Tim. iii, 15, *graduation* or *promotion*, etc. of a deacon [q. v.] to a higher office; or perhaps rather a spiritual *stand-point* or *condition*, see Alford, in loc.), a *step* (as of a staircase: door, Eccles. vi, 36). See STAIRS.

DEGREES, SONG OF (שִׁיר דְּמַעְלָהוֹת, *song of the steps*; Sept. *ὕμνη τῶν ἀναβαθμῶν*, Vulg. *canticum graduum*), a title given to fifteen Psalms, from cxv to cxxxiv inclusive. Four of them are attributed to David, one is ascribed to the pen of Solomon, and the other ten give no indication of their author. Euborn supposes them all to be the work of one and the same bard (*Einkl. in das A. T.*), on the view adopted by many that the indications of authorship in these titles are not trustworthy, since they appear to have been added by a later hand, and in any case "the very most phraseology would be employed to denote a hymn composed in honor of David or of Solomon" (*Mark's Sermons*, i, 208-9). The most generally accepted opinion, however, is that some of these hymns were preserved from a period anterior to the Babylonish captivity; that others were composed in the same period by those who returned to Palestine, on the conquest of Babylon by Cyrus, and that a few refer even to a later date, but were all incorporated into one collection, because they had one and the same character. This view is adopted by Rosenmüller, Herder, Mendelssohn, Joel Brill, and others. With respect to the term מַעְלָה מַעְלָה, or "degrees," a great diversity of opinion prevails among Biblical critics. 1. According to some, it refers to the melody to which the Psalm was to be chanted. Bellermaun (*Metrik der Hebr.*, p. 190 sq.) calls these Psalms "trochaic songs." Luther translates the words "Ein Lied im höhern Chor," thus connecting the Psalm with the manner of its execution; and Michaelis (in Lowth, *De Sacris Poetis*, p. 311) compares מַעְלָה with the Syriac מַעְלָה (Sabl) which would likewise characterize the metre of the melody (*Assem. Bibl.* i, 62); but Gesenius (*Ephezer Hal.* 1812, No. 206) denies to the Hebrews any metrical prosody. See POETRY, HEBREW. It is thought that the poetry of the Syrians may hereafter throw some light upon this title, as of the eight species of verse which they distinguish, one is called *gradus*, *scale*, *degrees*, like these Psalms, and the name appears to refer to a particular kind of metre (see *Ephezer Hal.* 1815, No. 11); but what that metre is, and whether it exists in the Psalms bearing this title, we have not yet the means of determining. 2. On slight

nds, also, some refer the name *Shir ham-Maaloth* of degrees—to the argument of the Psalms, and slate *songs of ascent, or odes of ascension*, supposing to have been sung by the Israelites while re- ing from exile (Ezra vii, 9), or on their annual neys to Jerusalem in order to celebrate the festi- : hence some understand *sacred marches, or pilgrim s*; but this would only apply to two of them (Psa. ii, cxxvi). Such, however, is the opinion of Her- (*Geiste der hebräischer Poesie*), who interprets the "Hymns for a journey." This view is advocated engh by Hengstenberg (*Comment. on Psalms*, iii, Edinb. ed.), and has been adopted by several later ics. 8. Aben Ezra quotes an ancient authority Kimchi, Saadiah, Jarchi, etc. explain), which main- s that the *degrees* allude to the fifteen steps which, he Temple of Jerusalem, led from the court of the nen to that of the men, and on each of which steps of the fifteen songs of degrees was chanted (comp. *Midcol*, ii, 5; *Succa*, v, 4). Adam Clarke *ment.* on Psa. cxx) refers to a similar opinion as nd in the Apocryphal *Gospel of the birth of Mary*: ler parents brought her to the Temple, and set her n one of the steps. Now there are fifteen steps ut the Temple, by which they go up to it, accord- ; to the fifteen Psalms of degrees." See TEMPLE. The most probable interpretation, however, is that pted by Gesenius (*Theo. Heb.* p. 1081 sq.), that they : so called from a certain rhythm obvious in several them, by which the sense, as it were, *ascends by des- es or steps*, the first or last words of a preceding use being often repeated at the beginning of the cceeding one (see *Jour. Sac. Lit.* October, 1854, p. 89). Thus, in Psa. cxxi :

1. I will lift up mine eyes unto the hills,
From whence cometh my help.
2. My help cometh from the Lord,
Who made heaven and earth.
3. He will not suffer thy foot to be moved;
Thy keeper will not slumber.
4. Lo, not slumber nor sleep will the
keeper of Israel.
5. Jehovah is thy keeper, etc.

Compare also Psa. cxxii, 2-4; cxxiii, 3, 4; cxxiv, 1- ; cxxvi, 2, 8; cxxix, 1, 2. To the same class be- ngs also the song of Deborah (Judg. v, 8-80). This iew is followed by De Wette (*Eint. in das A. T.* p. 89) and others. See Tilling, *Disquisitio de inscriptione, וְשִׁיר הַמַּעֲלוֹת* (Brem. 1765); Clarisse, *Psalmi quinde- im Hammaälöth* (L. B. 1819); Sticht, *De Psalmis Ham- nalöth* (Altona, 1766). See PSALMS.

Degrees (French *degré*, from Lat. *gradus*, a step), titles of rank to which are annexed privileges, confer- red upon students in colleges and universities, or upon members thereof, as a testimony of their proficiency in the arts and sciences. The term "Arts," or "Lib- eral Arts," as technically applied to certain studies, came into use during the Middle Ages, and on the es- tablishment of universities, the term "Faculty of Arts" denoted those who devoted themselves to science and philosophy as distinguished from the faculty of theol- ogy, and afterwards of medicine and law. The num- ber of "arts" embraced in the full mediæval course of learning was seven: Grammar, Logic, Rhetoric (con- stituting the *Trivium*), Music, Arithmetic, Geometry, and Rhetoric (the *Quadrivium*). The terms master and doctor were originally applied synonymously to any person engaged in teaching. In process of time, the one was restricted to the liberal arts, the other to divinity, law, and medicine. When regulations were established to prevent unqualified persons from teach- ing, and an initiatory stage of discipline was prescribed, these terms became significant of a certain rank, and of the possession of certain powers, and were called *gradus*, "steps" or "degrees." The passing of the initiatory stage, said to have been first instituted by Gregory IX (1227-41), conferred the title of *bachelor* (q. v.), and an additional course of discipline and ex-

amination was necessary to obtaining that of *master*. The title of Master of Arts originally implied the right, and even the duty of publicly teaching some of the branches included in the faculty of arts; a custom which is still retained, to some extent, in the German universities, but has fallen into disuse in other coun- tries. The degrees of D.D. (*doctor divinitatis*), S.T.D. (*sacra theologia doctor*), and LL.D. (*doctor utriusque legum*), are conferred, *honoris causâ*, by colleges and universities, upon persons held to be worthy of them, whether members of the said institutions of learning or not. The see of Rome claims a universal academical power, and the Pope confers the doctor's degree at pleasure. See Kirkpatrick, *Historically received Con- ception of the University*; Newman, *Office and Work of Universities*, p. 241; Tholuck, in Herzog's *Real-Ency- clopædie*, xvi, 722; and the article DOCTOR.

Deha'vites (Chald. *Dehaye'*, דְּהַיָּוִי, or *Dehaye'*, דְּהַיָּוִי, Sept. Δαβαῖοι, Vulg. *Diesi*), one of the Assyrian tribes from which a colony was led out by Asnap- per to repopulate Samaria, and who there joined their neighbors in opposing the reconstruction of the Tem- ple at Jerusalem (Ezra iv, 9). These *Dahi* were prob- ably the Δάοι, *Dai* (Herod. i, 125), a nomade Persian tribe east of the Caspian Sea (Amman. Marc. xx, 8, p. 800, ed. Bip.), in the neighborhood of the Mardians, or Hyrcanians (Strabo, xi, 508, 511; Pliny, vi, 19; xxxvii, 88; Solin. xx), towards Margiana (Ptol. vi, 10), under the rule of Darius (Curt. iv, 126), and later of Alexander (Curt. viii, 14, 5; ix, 2, 24) and his suc- cessors (Livy, xxvii, 40). This people appears to have been widely diffused, being found as *Daha* (Δάοι) both in the country east of the Caspian (Strab. xi, 8, 2; Arrian, *Expéd. Al.* iii, 11, etc.), and in the vicinity of the Sea of Azof (Strab. xi, 9, 8); and again as *Dihâ* (Δάοι, Thucyd. ii, 96), or *Daci* (Δακοί, Strab., D. Cass., etc.), upon the Danube. Their name perhaps survives in the present district *Daghestan*. They were an Arian race, and are regarded by some as having their lineal descendants in the modern *Danes* (see Grimm's *Geschicht. der Deutsche. Sprach.* i, 192-3). The name is derived from the Persian *dah*, "a village;" Dehavites will therefore be equivalent to the Latin "Rustici." Their love of war and plunder induced them to serve as mercenaries under various princes (Arrian, iii, 11; v, 12); and their valor has immortalized them in the pages of Virgil as "indomiti Dahæ" (*Æn.* viii, 728). A band of them had doubtless entered the service of the Persian monarch, followed him to Palestine, and received for their reward grants of land in Samaria (Stephanus Byzant. s. v.; Ritter, *Erakunde*, vii, 668; Rawlinson's *Herodotus*, i, 888).

Dehon, THEODORE, D.D., bishop of the Protestant Episcopal Church in the diocese of South Carolina, was born in Boston, Mass., in Dec., 1776. His early education was obtained in the public school, where, for some years, he stood at the head of his class. In 1791 he entered Harvard University, where he gradu- ated with the highest honors in 1795. He at once commenced his preparation for the ministry, for which, from early childhood, he had evinced a strong inclina- tion. In 1797 he was ordained, and soon became the rector of Trinity Church, Newport, R. I., where he re- mained until 1810, when he was compelled, by failing health, to seek a milder climate. An invitation to the rectorship of St. Michael's Church, Charleston, S. C., was accepted. In this charge, as at Newport, he was loved and revered by all classes. In 1812 he was elected bishop of the diocese of South Carolina, to which office he was solemnly set apart, in Philadelphia, by the venerable Bishop White. He continued in the rectorship of his church, and performed its duties and those of the bishopric, with eminent zeal, discretion, and success, until he fell a victim to yellow fever in August, 1817. At the request of the vestry of St. Michael's, he was buried beneath its chancel. His

sermons, in two volumes, have passed through two editions in this country, and through three in England. They are models of practical pulpit discourse. See *Memoir by Rev. Dr. Gadsden, and Prof. to 2d edit. Sermons*, vol. i; also Sprague, *Annals*, v, 425.

Dei Gratia (Lat. *by the grace of God*) is a formula used by bishops and monarchs. "Felix of Rome (A.D. 356) styled himself *episcopus per Dei gratiam*. Afterwards it came to be appended by archbishops, bishops, abbots, abbesses, deans, monks, and even chaplains, to their titles in letters and other documents, as an expression of dependence. After the middle of the 13th century, when the sanction of the pope began to be considered necessary to ecclesiastical offices, the higher clergy wrote *Dei et Apostolicæ sedis gratiâ*, 'by the favor of God and the apostolic see.' At a later period many of them preferred to write *miseratione divinâ, permissione divinâ*, and the like; but they still continued to be styled by others *Dei gratiâ*. In the British Islands this style was generally dropped about the time of the Reformation, but it was occasionally given to the archbishops of Canterbury and York even after the beginning of the 17th century. Beginning with the times of the Carolingians, many temporal princes, earls, and barons made use of the formula *Dei Gratia*; and before the 15th century no idea of independence or of divine right seems to have attached to it. But in 1442, king Charles VII of France forbade its use by the Comte d'Armagnac, and in 1449 obliged the duke of Burgundy to declare that he used it without prejudice to the rights of the French crown. These instances show that it had now begun to be regarded as belonging exclusively to sovereigns who owed no allegiance to any other earthly potentate or power. In this way, what was originally a pious expression of humility came to be looked upon as an assertion of the doctrine of the 'divine right' of kings."—Chambers, *Encyclopædia*, s. v.

Deip̄ra, mother of God, a title applied to Mary, the mother of Christ, at the Council of Nicæa. See **THEOTOKOS**.

Deism (from *Deus*, God) properly means the belief in the existence of a supreme intelligent First Cause, in opposition to Atheism. It is now, however, applied to that form of infidelity which professes to believe the existence of a personal God, but denies his revelation. The word Deism is, at bottom, the same as *Theism* (from *θεός*, God); but a distinction in practical use has arisen between them. Des Prades calls Theism the faith of reason, which precedes all revelation; but, on the other hand, designates by Deism the faith in reason which contests revelation. In more modern times, an arbitrary distinction between the two terms mentioned has been adopted by the usage of scientific language in Germany, according to which Deism is the doctrine of God's relation to the world, which represents God as not only different, but also as separated from the world, therefore as only in an external relation to it; on the other hand, Theism would be the doctrine which represents God as holding an internal and real relation to the world. Kant makes the distinction between a deist and a theist as follows: 'the *deist*, he says, believes in a God, but the *theist* in a living God.' "About the middle of the 16th century the title was arrogantly assumed by those who professed to believe in a God, while they refused to acknowledge any revelation of his will. They set up in opposition to Christianity what they are pleased to call 'natural religion,' but never agreed upon the articles of faith which it taught, or the practical duties which it required. Deism, in effect, is a rejection of all known religions, supplying nothing in their place, but leaving the mind to doubt and darkness. But the friends of Christianity have no reason to regret the free and unreserved discussion which their religion undergoes. The cavils and objections of the de-

ists have been fairly heard and fully answered; but for their opposition we should not have had such a vast mass of Christian evidences as has been collected by the pious and learned; evidences which, while they prove the truths of Christianity, so illustrate its doctrines as to be of lasting service to the cause of genuine religion and the best interests of mankind" (Mack). The ground taken by the English deists was essentially the naturalistic, viz. that the Gospel history was the product of an invention imposed upon the world by its authors.

Lord Herbert of Cherbury (born 1581, died 1633) has been regarded as the first deistical writer in England, or at least the first who reduced Deism to a system, affirming the sufficiency of reason and natural religion, and rejecting divine revelation as unnecessary and superfluous. His system, taught in his *De Veritate* and *De Religione Laici*, embraced these five articles: 1, The being of God; 2, that he is to be worshipped; 3, that piety and moral virtues are the chief parts of worship; 4, that God will pardon our faults on repentance; and, 5, that there is a future state of rewards and punishment. See HERBERT of CHERBURY. Hobbes († 1690), deriving all knowledge from the senses, taught a lower, but more logical form of Deism than Herbert, and one less calculated to do harm, as his system obviously subverts ordinary morality. See HOBBS. Charles Blount († 1686) published a translation of Philostratus's *Life of Apollonius Tyaneus*, with the same purpose as that of Hierocles in the 4th century, viz. to contrast the character and history of Christ disadvantageously with that of Apollonius. After his death appeared his *Oracle of Beana* (1695), explaining the "Deists' Religion." John Toland († 1722), in his *Christianity not Mysteries* (1696), asserted the capacity and supremacy of reason (anticipating the modern Rationalism [q. v.]), and also in his *Amyntor* (1699), threw doubt upon the Canon. The theory that Christ was an ordinary man whose followers elevated him to the imaginary dignity of a divine being, had been started by the early opponents of Christianity—Celsus, Porphyry, and Justin. It was revived by Woolston († 1758) (q. v.), in his *Six Discourses on the Miracles* (1727), and by Tyndal (q. v.) in his *Christianity as old as the Creation* (1790). Tyndal was followed by Chubb, *The Gospel of Christ* (1748), and other writings [see **CRISTUS**]; and by Morgan, *The Moral Philosopher*, and other works. These views were disseminated among the higher classes in England by Bolingbroke and Shaftesbury, and at a later period, in the form of complex scepticism, by Hume and Gibbon. Among the liberate, Thomas Paine (q. v.) was the great propagator of Deism. The progress of vulgar Deism among the higher classes was arrested by Butler's immortal *Analogy* [see BUTLER], and among the lower, to a large extent, by the rise and progress of Methodism.

In France, the English Deism was adopted and diffused by Voltaire and the Encyclopedists (q. v.); but it soon became frivolous, immoral, and, in fact, atheistic. In Germany, the same seed sprang up in the 18th century in the theories which gave rise to the modern Rationalism (q. v.). "The deistical movement, if viewed as a whole, is obsolete. If the same deists are now repeated, they do not recur in the same form, but are connected with new forms of philosophy, and altered by contact with more recent criticism. In the present day sceptics would believe less than the deists, or believe more, both in philosophy and in criticism. In philosophy, the fact that the same difficulties occur in natural religion as well as in revealed would now throw them back from Monotheism into Atheism or Pantheism; while the mysteries of revelation, which by a rough criticism were then denied, would be now conceded and explained away as psychological peculiarities of races or individuals. In criticism, the delicate examination of the sacred liter-

would now prevent both the revival of the cold, imaginative want of appreciation of its extreme literary beauty, and the hasty imputation of the charge of literary forgery against the authors of the deocuments. In the deist controversy, the whole question ed upon the differences and respective degrees of gation of natural and revealed religion, moral and tive duties; the deist conceding the one, denying other. The permanent contribution to thought e by the controversy consisted in turning atten- from abstract theology to psychological, from met- ytical disquisitions on the nature of God to ethical sideration of the moral scheme of redemption for 1. Theology came forth from the conflict, recon- red from the psychological point of view, and re- isted to meet the doubts which the new form of losophy—psychology and ethics—might suggest. 2 attack of revealed religion by reason awoke the ance, and no period in Church history is so remark- e for works on the Christian evidences—grand mo- ents of mind and industry. The works of defend- are marked by the adoption of the same basis of on as their opponents, and hence the topics which y illustrate have a permanent philosophical value, ough their special utility as arguments be lessened the alteration in the point of view now assumed by e thought" (Farrar, *Critical History of Free Thought*, t. iv).

The aim of honest deists has professedly been to maintain the doctrine of a Personal God; and they ve asserted and assumed that this doctrine can be tter and more surely vindicated apart from what ey call the entanglements of Christian faith than in nnection with them. But the history of thought, the last century especially, shows that Deism, or elief in a Personal God apart from Christianity, gives ay steadily before the assaults of Pantheism and ostivism. No robust faith has ever sprung out of eism. The so-called spiritualistic writers of France ave contended nobly (e. g. Cousin, Saisset, and oth-) against Materialism; but their task of upholding eism in France has devolved now almost wholly pon Christian thinkers.

A succinct account of the English deists and their rinciples will be found in Van Mildert, *Boyle's Lec- ure*, sermon x; Lechler, *Geschichte d. englisch. Deis- nus* (1841). See also Leland, *View of deistical Writ- ers* (new ed. by Edmonds, Lond. 1837, 8vo); Noack, *Die Freidenker in der Religion* (Bern. 1858-56, 3 vols.; vol. i treats of the "English Deists," vol. ii of the "French Freethinkers," vol. iii of the "German En- lightenment"); Farrar, *Critical History of Free Thought* (Oxf. 1863, 8vo; repub. Boston, 1863, 12mo); Hurst, *History of Rationalism*, chap. xix; Hagenbach, *Hist. of Doctrines*, § 238; Dörner, *Geschichte d. protest. The- ologie* (1867), p. 487; Liddon, *Bampton Lecture*, 1867. Compare the articles INFIDELITY; RATIONALISM. For the writers against Deism, see APOLOGETICS; APOLOGY; EVIDENCES.

Deity, a name of the Supreme Being, from the Latin *Deus*, God. It was originally an abstract term, and thence transferred to signify, in a concrete sense, Him whom we call God.

DEITY OF JESUS CHRIST. "In the use of this phrase concerning our Lord we mean to assert that he was 'the very and eternal God.' It is a more proper expression than 'the divinity of Christ,' since this latter does not necessarily imply anything more of our Lord's nature than that it was godlike, or of heavenly origin; whereas the term 'Deity' contains in it the notion of essential Godhead. The other expression, however, has prevailed, on account of the word 'Deity' having come to be so commonly used as the concrete instead of the abstract sense, to denote a divine Being."—Eden, *Churchman's Dictionary*, s. v. See CHRISTOLOGY; TRINITY.

De'kar (Heb. *De'ker*, דַּקַּר, a thrusting through), the father of Solomon's purveyor in the second royal district (1 Kings iv, 9), from which passage it appears that his son BEN-DEKER (בֶּן־דַּקַּר; Sept. υἱὸς Δακάρ; Vulg. *Bendecar*) was the royal commissariat officer in the western part of the hill-country of Judah and Benjamin, Shaalbim and Bethshemesh. B. C. ante 1014.

De la Mennais. See LA MENNAIS.

Delai'ah (Heb. *Delayah*, דַּלַּיָהּ, freed by Jehovah; also in the prolonged form *Delaya'hu*, דַּלַּיָהּ, 1 Chron. xxiv, 18; Jer. xxxvi, 12, 25; comp. ἀπελευθερώς Κυρίου, 1 Cor. vii, 23; also the Phœnician name *Δελαϊα-σάρος*, quoted from Menander by Josephus, *Ap.* i, 18, and the modern name Godfrey = Gottesfrey), the name of several men.

1. (Sept. *Δαλαίας* v. r. Ἀββαλλαί.) The head of the twenty-third division of the priestly order in the arrangement by David (1 Chron. xxiv, 18). B. C. 1014.

2. (Sept. *Δαλαίας*, *Γοδολαίας*.) A son of Shemaiah, and one of the courtiers to whom Jeremiah's first roll of prophecy was read (Jer. xxxvi, 12): he vainly interceded for its preservation from the flames (ver. 25). B. C. 604.

3. (Sept. *Δαλαία*.) The progenitor or head of one of the parties of exiles that returned to Jerusalem with Zerubbabel from certain parts of the Assyrian dominions, but who had lost their genealogical records (Ezra ii, 60; Neh. vii, 62). B. C. 586.

4. (Sept. *Δαλαία*.) The son of Mehetabeel, and father of the Shemaiah who counselled Nehemiah to escape into the Temple from the threats of Sanballat (Neh. vi, 10). B. C. ante 410.

5. (Sept. *Δελαία* v. r. *Δαλααία*.) One of the sons of Elloenal, a descendant of the royal line of Judah from Zerubbabel (1 Chron. iii, 24, where, however, the name is Anglicized DALALIAH). He probably belongs to the tenth generation before Christ (see Strong's *Harmony and Expos. of the Gospels*, p. 17). B. C. cir. 300.

Delancey, WILLIAM HEATHCOTE, D. D., bishop of the Protestant Episcopal Church in the diocese of Western New York, was born in Westchester County, N. Y., Oct. 8, 1797; graduated at Yale College in 1817, and was ordained deacon in 1819. His first ministerial labor was given to Grace Church, New York, of which he was in charge during the vacancy of the rectorship which preceded that of the Rev. Dr. Wainwright. He then officiated for a short time in the newly-organized parish of St. Thomas's, Mamaroneck. Having been advanced to the priesthood on March 6, 1822, in Trinity Church, New York, he removed to the city of Philadelphia, where he became an assistant minister of the united churches of Christ Church, St. Peter's, and St. James's, of which bishop White was then rector. In 1828 he was appointed Provost of the University of Pennsylvania. In 1833 he became assistant minister of St. Peter's Church of Philadelphia, and in 1837 rector. When the diocese of New York was divided in 1838, Dr. Delancey was elected the first bishop of the new diocese of Western New York. His consecration took place on May 9, 1839. In 1852 he visited England as a delegate to the English House of Bishops from the Protestant Episcopal Church of America. He died at Geneva, N. Y., April 5, 1865. In all positions, as pastor, university officer, and bishop, Dr. Delancey was diligent, skilful, and successful. He instituted a system of diocesan missions sustained to the present time without incurring debt. In 1840, by his recommendation, a fund for the relief of infirm and aged clergy of the diocese was established.

Delany, PATRICK, an eminent Irish clergyman, was born in the year 1686, and was educated at Trinity College, Dublin. In 1727 lord Carteret raised him to the chancellorship of Christ Church. He distinguished himself by the publication of the first vol-

ume of a work entitled *Revelation examined with Candor* (4th edit. Lond. 1745-63, 3 vols. 8vo). The work is still held in deserved estimation. In 1738 he wrote an ingenious pamphlet, entitled *Reflections on Polygamy*. He also published (1740-42) *An historical Account of the Life and Reign of David* (3d ed. London, 1745, 2 vols. 8vo); in 1745-1763, *Revelation examined with Candor* (2 vols. 8vo); *Twenty Sermons upon social Duties and their opposite Vices* (Lond. 1750, 8vo); *Sixteen Discourses on Doctrines and Duties* (Lond. 1754, 8vo). He died at Bath, May, 1768. "He was a man of ability and learning, disposed occasionally to use his fancy, and to reason confidently on doubtful or disputed premises; his works also greatly lack evangelical sentiment. His sentiments on many doctrines of Christianity were certainly peculiar, but then his mind was original, well-informed, and capacious" (Orme, *Bibliotheca Biblica*). See Kippis, *Biographia Britannica*, v, 75.

De La Rue. See LA RUE.

Deleda, or Theleda of the Pestinger Table, is identified by Ritter (*Erdk.* xvii, 1448) with *Hasya*, a village on the Damascus-Horns road, four hours east of Riblah (Van de Velde, *Memoir*, p. 307).

Delegates, Court of. The great court of appeal in all ecclesiastical causes in England is so called because the commissioners who form the court are appointed to represent the king, under his great seal.

Delfau, DOM FRANÇOIS, a French theologian, was born at Moullet, in Auvergne, in 1637. He entered the congregation of St. Maur, and became specially known for his edition of the works of St. Augustine. He undertook this work by direction of the general of the congregation, upon whom the need of a new critical edition of the works of the great Church father had been urged by Arnaud. Delfau published in 1670 an announcement in which scholars generally were invited to support him with their advice and with manuscripts. The general of the congregation, by a circular to all the houses of the congregation, issued in the same year, requested each to co-operate with the editor in a work which promised to be of so great use to the Church. A full prospectus was published by Delfau in 1671. Great progress had been made in the preparation of the work, when suddenly Delfau was exiled to Saint Mahé, in Lower Brittany, charged with having published in 1673, under the assumed name of Bois-Franc, a work entitled *L'Abbé commendataire*, directed against the custom of giving ecclesiastical benefices in *commendam*. He perished by shipwreck Oct. 18, 1676. He is also the author of a defence (*Apologie*) of the cardinal de Furstemberg, who was arrested at Cologne by the troops of the emperor, and of an *Epi-taph* of king Casimir of Poland.—Hoefler, *Biographie Générale*, xiii, 457.

Deli'lah (Heb. *Delilah*, דלילה, prob. *languishing*, sc. with lustful desire; Sept. *Δαλιλά*, Josephus *Δαλιλά*), a woman who dwelt in the valley of Sorek, beloved by Samson (Judg. xvi, 4-18). B.C. 1165. Her connection with Samson forms the third and last of those amatory adventures which in his history are so inextricably blended with the craft and prowess of a judge in Israel. She was bribed by the "lords of the Philistines" to win from Samson the secret of his strength, and the means of overcoming it. See SAMSON. It is not stated, either in Judges or Josephus, whether she was an Israelite or a Philistine. Nor can this question be determined by reference to the geography of Sorek, since, in the time of the judges, the frontier was shifting and indefinite. The following considerations, however, supply presumptive evidence that she was a Philistine:

1. Her *occupation*, which seems to have been that of a courtesan of the higher class, a kind of political He-

(who calls her *γυνή τραυλιζομένη*, and ascribes influence over Samson with *πύρος* and *οὐρανοῦ* Judg. vi, 8, 11). He also states more clearly her relation a political agent to the "lords of the Philistines" (סִרְיָה, Joseph. *οἱ προσεπύτες, οἱ ἀρχόντες* *Ἰλαρῶνων*; Sept. *ἀρχόντες, οἱ τοῦ κορυνοῦ*; magistrates or political lords, Milton, *Sam. Ag.* 850, 1195), employed under their directions "liers in wait" (סִרְיָה, *δρόν*; comp. Josh. viii, 14). On the other hand, (1) as sustom and many of the fathers have maintained, Delilah was married to Samson (so Milton, *Sam.* 1195), natural but uncritical attempt to save the morality of the Jewish champion. See Judg. xvi, 9, 18, as if giving an exclusive command of her establishment consistent with the idea of matrimonial connection (Zwick, ad loc.). There seems to be little doubt that she was a courtesan; and her employment as a political emissary, together with the large sum which was offered for her services (1100 pieces of silver from the lord=5500 shekels; comp. Judg. iii, 8), and the fact which is attributed to her in Judges, but more especially in Josephus, indicates a position not likely to be occupied by any Israelitish woman at that period of national depression. See PHILISTINES.

2. The general tendency of the Scripture narrative of the sexual temptation represented as acting upon an Israelite from *without* (Num. xxv, 1, 6; xxxi, 16, 17). See HARLOT.

3. The special case of Samson (Judg. xiv, 1; xv, 1). In Milton Delilah appears as a Philistine, and justifies herself to Samson on the ground of patriotism (*Sam. Ag.* 850, 980).—Smith, s. v.

Dellius (Δέλλιος), ΚΥΡΙΑΚΟΣ, a favorite name of Antony, whose unprincipled officiousness came into embroiling Herod with Ventidius (Josephus, *Ant.* xv, 15, 1; xv, 2, 6; *War*, i, xv, 8). He was a Macedonian knight who was concerned in the civil war under the triumvirate, and is frequently mentioned in classical history (Smith, *Dict. of Class. Biog.* s. v.).

Delos. See DELUS.

Deluge, a term specifically applied in modern times to Noah's flood, as related in Gen. vii, viii, & Flood.

1. *Biblical History of the Flood.*—The sacred historian informs us that in the ninth generation from Adam, when the race of man had greatly multiplied on the face of the earth, wickedness of every kind had fearfully increased, that every imagination of the thoughts of the human heart was only evil continually, that the earth was filled with violence, and that such a degree of depravity had the whole race come to that "it repented the Lord that he had made man on the earth, and it grieved him at his heart." We are further told, in graphic and impressive language, that the Creator determined to purge the earth from the presence of the creature whom he had made. "I will destroy man whom I have created from the face of the earth; both man and beast, and the creeping thing, and the fowls of the air; for it repenteth me that I have made them." See ANTHROPOPHAGIA. In the midst of a world of crime and guilt there was, however, one household, that of Noah, in which the fear of God still remained. "Noah was a just man, and perfect in his generations, and walked with God. And Noah found grace in the eyes of the Lord." He was commanded to make an ark of gopher wood, three hundred cubits long, fifty broad, and thirty high. Into this large vessel he was to collect a pair of "every living thing of all flesh," fowls, cattle, and creeping things after their kind, along with a suitable amount of food. He was to enter it himself, taking with him his wife, and his three sons with their wives, but with no other human company. The reason of these preparations was made known in the solemn decree: "Hold I, even I, do bring a flood of waters upon the

to destroy all flesh, wherein is the breath of life, under heaven; and everything that is in the shall die." The ark thus commissioned was prepared by Noah. See ARK. At length, in six hundredth year of his age, the ark was finished, and all its living freight was gathered into it as place of safety. Jehovah shut him in, says the scribe, speaking of Noah. And then there ensued a pause of seven days before the threatened action was set on foot. At last the flood came; the waters were upon the earth. The narrative is vivid and forcible, though entirely wanting in that sort of description which in a modern historian or poet would occupy the largest space. We see nothing of death-struggle; we hear not the cry of despair; we are not called upon to witness the frantic agony of husband and wife, and parent and child, as they fled before the rising waters. Nor is a word said of the sadness of the one righteous man who, safe himself, looked upon the destruction which he could not prevent. But one impression is left upon the mind with peculiar vividness, from the very simplicity of the narrative, and it is that of utter desolation. This is heightened by the contrast and repetition of the two scenes. On the one hand we are reminded no less than twenty times in the narrative in chapters vi, vii, viii, who tenants of the ark were (vi, 18-21; vii, 1-3, 7-9, 16; viii, 16, 17, 18, 19), the favored and rescued; and, on the other hand, the total and absolute extinction of everything else is not less emphatically set upon (vi, 18, 17; vii, 4, 21-23). This evidently signed contrast may especially be traced in chapter vi.

First, we read in ver. 6, "And Noah was six hundred years old when the flood came—waters upon the earth." Then follows an account of Noah and his family and the animals entering into the ark. Next verses 10-12 resume the subject of ver. 7: "And it came to pass after seven days that the waters of the flood were upon the earth. In the six hundredth year of Noah's life, in the second month, on the seventeenth day of the month, on the selfsame day were all the mountains of the great deep broken up, and the windows (or floodgates) of heaven were opened. And the rain was upon the earth forty days and forty nights." Again the narrative returns to Noah and his companions, and their safety in the ark (ver. 18-16). And then in ver. 17 the words of ver. 12 are resumed, and from thence to the end of the chapter a very simple but very powerful and impressive description is given of the appalling catastrophe: "And the flood was forty days upon the earth; and the waters increased and bare up the ark, and it was lifted up from off the earth. And the waters prevailed and increased exceeding-

ly upon the earth: and the ark went on the face of the waters. And the waters prevailed very exceedingly upon the earth, and all the high mountains which [were] under the whole heaven were covered. Fifteen cubits upwards did the waters prevail, and the mountains were covered. And all flesh died which moveth upon the earth, of fowl, and of cattle, and of wild beasts, and of every creeping thing which creepeth upon the earth, and every man. All in whose nostrils was the breath of life, of all that was in the dry land, died. And every substance which was on the face of the ground was blotted out, as well man as cattle, and creeping thing and fowl of the heaven: they were blotted out from the earth, and Noah only was left, and they that were with him in the ark. And the waters prevailed on the earth a hundred and fifty days." The waters of the Flood increased, for a period of 150 days (40+150, comparing vii, 12 and 24). And then "God remembered Noah," and made a wind to pass over the earth, so that the waters were assuaged. The ark rested on the seventeenth day of the seventh

month on the mountains of Ararat. After this the waters gradually decreased till the first day of the tenth month, when the tops of the mountains were seen. It was then that Noah sent forth, first, the raven, which flew hither and thither, resting probably on the mountain-tops, but not returning to the ark; and next (? after an interval of seven days; comp. ver. 10), the dove, "to see if the waters were abated from the ground" (i. e. the lower plain country). "But the dove," it is beautifully said, "found no rest for the sole of her foot, and she returned unto him into the ark." After waiting for another seven days he again sent forth the dove, which returned this time with a fresh (תִּירָה) olive-leaf in her mouth, a sign that the waters were still lower. Once more, after another interval of seven days, he sent forth the dove, and she "returned not again unto him any more," having found a home for herself upon the earth. No picture in natural history was ever drawn with more exquisite beauty and fidelity than this: it is admirable alike for its poetry and its truth. Respecting two points, we may here remark (1) that the raven was supposed to foretell changes in the weather both by its flight and its cry (Ælian, *H. A.* vii, 7; Virg. *Georg.* i, 382, 410). According to Jewish tradition, the raven was preserved in the ark in order to be the progenitor of the birds which afterwards fed Elijah by the brook Cherith. (2) The olive-tree is an evergreen, and seems to have the power of living under water, according to Theophrastus (*Hist. Plant.* iv, 8) and Pliny (*H. N.* xiii, 50), who mention olive-trees in the Red Sea. The olive grows in Armenia, but only in the valleys on the south side of Ararat, not on the slopes of the mountain. It will not flourish at an elevation where even the mulberry, walnut, and apricot are found (Ritter, *Erdkunde*, x, 920).

According to a careful adjustment of the chronology of the Hebrew Bible, the Noachian deluge appears to have occurred (begun) in the year from the creation of Adam 1657, and before Christ 2516. It continued twelve lunar months and ten days, or exactly one solar year (Browne, *Ordo Sæclorum*, p. 825 sq.), as the following tabular exhibit of the incidents will show:

Month.	Day.	Interval.	Events.	Genesis.
II (Nov.)	11		Command to enter the ark.	vii, 1-4.
"	17	6 days.	The rain begins.	" 5-16, 17.
"	27	89 "	The rain ceases—the waters prevail.	" 18-24.
III (Dec.)	27	108 "	The ark grounds on Ararat.	viii, 1-4.
VII (Apr.)	17	13 "	Tops of the mountains visible.	" 5.
X (July)	1	89 "	Raven and dove sent out.	" 6, 9.
XI (Aug.)	11	89 "	Dove again sent out.	" 10, 11.
"	17	6 "	Dove sent out the third time.	" 12.
"	23	6 "	The ground becomes dry.	" 13.
I (Oct.)	1	37 "	Noah leaves the ark.	" 14-19.
II (Nov.)	27	56 "		
		370 "		

The word specially used to designate the Flood of Noah (מַבְּבֹל, *ham-mabbul*) occurs in only one other passage of Scripture (Psa. xxix, 10). The poet there sings of the majesty of God as seen in the storm. It is not improbable that the heavy rain accompanying the thunder and lightning had been such as to swell the torrents, and perhaps cause a partial inundation. This carried back his thoughts to the great flood of which he had often read, and he sang, "Jehovah sat as king at the Flood," and looking up at the clear face of the sky, and on the freshness and glory of nature around him, he added, "and Jehovah remaineth a king forever." In Isa. liv, 9, the Flood is spoken of as "the waters of Noah." God himself appeals to his promise made after the Flood as a pledge of his faithfulness to Israel: "For this is as the waters of Noah unto me; for as I have sworn that the waters of Noah should no more go over the earth, so have I sworn that I would not be wroth with thee nor rebuke thee."

In the N. T. our Lord gives the sanction of his own

authority to the historical truth of the narrative, Matt. xxiv, 37 (comp. Luke xvii, 26), declaring that the state of the world at his second coming shall be such as it was in the days of Noah. Peter speaks of the "long suffering of God," which "waited in the days of Noah while the ark was a preparing, wherein few, that is, eight souls, were saved by water," and sees in the waters of the flood by which the ark was borne up a type of baptism, by which the Church is separated from the world. Again, in his second Epistle (ii, 5), he cites it as an instance of the righteous judgment of God, who spared not the old world, etc.

II. *Traditions.*—The legends of many nations have preserved the memory of a great and destructive flood from which but a small part of mankind escaped. It is not always very clear whether they point back to a common centre, whence they were carried by the different families of men as they wandered east and west, or whether they were of national growth, and embody merely records of catastrophes, such as especially in mountainous countries are of no rare occurrence. In some instances, no doubt, the resemblances between the heathen and the Jewish stories are so striking as to render it morally certain that the former were borrowed from the latter. We find, indeed, a mythological element, the absence of all moral purpose, and a national and local coloring, but, discernible among these, undoubted features of the primitive history.

The account of the Flood in the Koran is apparently drawn partly from Biblical and partly from Persian sources. In the main, no doubt, it follows the narrative in Genesis, but dwells at length on the testimony of Noah to the unbelieving (Sale's *Koran*, chap. xi, p. 181). He is said to have tarried among his people one thousand save fifty years (chap. xxix, p. 327). The people scoffed at and derided him, and "thus were they employed until our sentence was put in execution and the oven poured forth water." Different explanations have been given of this oven, which may be seen in Sale's note. He suggests (after Hyde, *De Rel. Pers.*) that this idea was borrowed from the Persian Magi, who also fancied that the first waters of the Deluge gushed out of the oven of a certain old woman named Zala Cûfa. But the *tawûr* (oven), he observes, may mean only a receptacle in which waters are gathered, or the fissure from which they broke forth. Another peculiarity of this version is, that Noah calls in vain to one of his sons to enter into the ark: he refuses, in the hope of escaping to a mountain, and is drowned before his father's eyes. The ark, moreover, is said to have rested on the mountain Al Jûdi, which Sale supposes should be written Jordi or Glordi, and connects with the Gordyâi, Cardu, etc. or Kurd Mountains on the borders of Armenia and Mesopotamia (ch. xi, p. 181-183, and notes). See ARABAT.

1. The traditions which come nearest to the Biblical account are those of the nations of Western Asia. Foremost among these is the Chaldean. It is preserved in a Fragment of Berossus, and is as follows: "After the death of Ardaeus, his son Xisuthrus reigned eighteen sari. In his time happened a great Deluge, the history of which is thus described: The Deity Kronos appeared to him in a vision, and warned him that on the 15th day of the month Dæsius there would be a flood by which mankind would be destroyed. He therefore enjoined him to write a history of the beginning, course, and end of all things, and to bury it in the City of the Sun at Sippara; and to build a vessel (*σκαφος*), and to take with him into it his friends and relatives; and to put on board food and drink, together with different animals, birds, and quadrupeds; and as soon as he had made all arrangements, to commit himself to the deep. Having asked the Deity whither he was to sail, he was answered, 'To the gods, after having offered a prayer for the good of mankind,' reupon, not being disobedient (to the heavenly

vision), he built a vessel five stadia in length and in breadth. Into this he put everything which he prepared, and embarked in it his wife, his children, and his personal friends. After the flood had subsided upon the earth and was in time abated, Xisuthrus sent out some birds from the vessel, which, not finding food, nor any place where they could rest, returned thither. After an interval of some days Xisuthrus sent out the birds a second time, and now they alighted to the ship with mud on their feet. A third time he repeated the experiment, and then they came no more; whence Xisuthrus judged that the earth was visible above the waters, and accordingly he made an opening in the vessel (?), and, seeing that it was caused upon the site of a certain mountain, he quit it with his wife and daughter and the pilot. Xisuthrus then paid his adoration to the earth, and having built an altar and offered sacrifices to the gods, he departed with those who had left the vessel with him, disappeared. Those who had remained behind, when they found that Xisuthrus and his companions did not return, in their turn left the vessel and began to search for him, calling him by his name. Him they availed themselves to find, but a voice came to them from heaven bidding them lead pious lives, and so join him who was gone to live with the gods, and further informing them that his wife, his daughter, and the pilot had shared the same honor. It told them, moreover, that they should return to Babylon, and how it was ordained that they should take up the writings that had been buried at Sippara and impart them to mankind, and that in the country where they then were was the land of Armenia. The rest, having heard these words, offered sacrifices to the gods, and, taking a circuit, journeyed to Babylon. The vessel being thus stranded in Armenia, some part of it still remains in the mountains of the Corcyraans (or Cordycaans, i. e. the Kurds of Kurdistan) in Armenia, and the people scrape of bitumen from the vessel and make use of it by way of charms. Now, when those of whom we have just mentioned returned to Babylon, they dug up the writings which had been buried at Sippara; they also founded cities and built temples, and thus the country of Babylon became inhabited again" (Cory's *Ancient Fragments*, p. 26-29). Another version abridged, but substantially the same, is given from Abydenus (*ibid.* p. 33, 34). The version of Eupolemus (quoted by Eusebius, *Præp. Evang.* x, 9) is curious: "The city of Babylon," he says, "owes its foundation to those who were saved from the Deluge; they were giants, and they built the tower celebrated in history."

Other Western Asiatic notices of a Flood may be found (a) in the Phœnician mythology, where the history of Pontus (the sea) over Demarous (the earth) is mentioned (see the quotation from Sanchoianus in Cory, as above, p. 13); (b) in the *Sibylline Oracles*, partly borrowed, no doubt, from the Biblical narrative, and partly perhaps from some Babylonian story. In these mentions is made of the Deluge, after which Enos, Titan, and Japetus ruled the world, each taking a separate portion for himself, and remaining at peace till after the death of Noah, when Kronos and Zeus engaged in war with one another (*ibid.* p. 52). To these must be added (c) the Phrygian story of king Assakos or Nannakos (Enoch) in Iconium, who reached at an age of more than 300 years, foretold the Flood, and wept and prayed for his people, seeing the destruction that was coming upon them. Very curious, as showing what deep root this tradition must have taken in the country, is the fact that so late as the time of Septimius Severus a medal was struck at Apamea at which the Flood is commemorated. "The city is known to have been formerly called 'Kibotos,' or 'the Ark;' and it is also known that the coins of *Antioch* of that age exhibited some leading point in their mythological history. The medal in question represents a kind of square vessel floating in the water. Through



of Aramea in Phrygia, representing the Deluge.

, or ΝΩΕ, have been found on the vessel, as in the text cut. (See Eckhel, iii, 182, 183; Wiseman, *Stories on Science and Revealed Religion*, ii, 128, 129.) This fact is no doubt remarkable, but too much stress is not to be laid upon it; for, making full allowance for the local tradition as having occasioned it, we must not forget the influence which the Biblical account would have in modifying the native story. See APALIA.

As belonging to this cycle of tradition must be reckoned also (1) the Syrian, related by Lucian (*De Deo Syriae*, c. 18), and connected with a huge chasm in the earth near Hieropolis, into which the waters of the flood are supposed to have drained; and (2) the Armenian, quoted by Josephus (*Ant.* i, 8) from Nicolaus amasenens, who flourished about the age of Augustus. He says: "There is above Minyas, in the land of Armenia, a great mountain, which is called Baris, i. e. a ship, to which it is said that many persons fled at the time of the Deluge, and so were saved; and that one in particular was carried thither upon an ark (*ἰνὴ λίβανος*), and was landed upon its summit, and that the remains of the vessel's planks and timbers were long preserved upon the mountain. Perhaps this was the same person of whom Moses, the legislator of the Jews, wrote an account."

2. A second cycle of traditions is that of Eastern Asia. To this belong the Persian, Indian, and Chinese. The Persian is mixed up with its cosmogony, and hence loses everything like a historical aspect. "The world having been corrupted by Ahriman, it was necessary to bring over it a universal flood of water, that all impurity might be washed away. The rain came down in drops as large as the head of a bull; the earth was under water to the height of a man, and the creatures of Ahriman were destroyed."

The Chinese story is, in many respects, singularly like the Biblical, according to the Jesuit M. Martinus, who says that the Chinese computed it to have taken place 4000 years before the Christian era. Fáh-he, the reputed author of Chinese civilization, is said to have escaped from the waters of the Deluge. He reappears as the first man at the production of a renovated world, attended by seven companions—his wife, his three sons, and three daughters, by whose intermarriage the whole circle of the universe is finally completed (Hardwick, *Christ and other Masters*, iii, 16). Dr. Gutzlaff, in a paper "On Buddhism in China," communicated to the Royal Asiatic Society (*Journal*, xvi, 79), says that he saw in one of the Buddhist temples, "in beautiful stucco, the scene where Kwan-yin, the Goddess of Mercy, looks down from heaven upon the lonely Noah in his ark, amidst the raging waves of the deluge, with the dolphins swimming around as his last means of safety, and the dove with an olive-branch in its beak flying towards the vessel. Nothing could have exceeded the beauty of the execution."

The Indian tradition appears in various forms. Of these, the one which most remarkably agrees with the Biblical account is that contained in the Mahábháráta. We are there told that Brahma, having taken the form

of a fish, appeared to the pious Manu (Satya, i. e. the righteous, as Noah is also called) on the banks of the river Wirini. Thence, at his request, Manu transferred him when he grew bigger to the Ganges, and finally, when he was too large even for the Ganges, to the ocean. Brahma now announces to Manu the approach of the Deluge, and bids him build a ship and put in it all kinds of seeds, together with the seven Rishis or holy beings. The Flood begins and covers the whole earth. Brahma himself appears in the form of a horned fish, and, the vessel being made fast to him, he draws it for many years, and finally lands on the loftiest summit of Mount Himarat (i. e. the Himalaya). Then, by the command of God, the ship is made fast, and in memory of the event the mountain called Naubandhana (i. e. *ship-binding*). By the favor of Brahma, Manu, after the Flood, creates the new race of mankind, which are hence termed Manudsha, i. e. born of Manu (Bopp, *Die Sindhjuth*). The Puránic or popular version is of much later date, and is, "according to its own admission, colored and disguised by allegorical imagery." Another, and perhaps the most ancient version of all, is that contained in the Çatapataha-Bráhmána. The peculiarity of this is that its locality is manifestly north of the Himalaya range, over which Manu is supposed to have crossed into India. Both versions will be found at length in Hardwick's *Christ and other Masters*, ii, 145-152.

3. A third cycle of traditions is to be found among the American nations. These, as might be expected, show occasionally some marks of resemblance to the Asiatic legends. The one in existence among the Cherokees reminds us of the story in the Mahábháráta, except that a dog here renders the same service to his master as the fish there does to Manu. "This dog was very pertinacious in visiting the banks of a river for several days, where he stood gazing at the water and howling piteously. Being sharply spoken to by his master and ordered home, he revealed the coming evil. He concluded his prediction by saying that the escape of his master and family from drowning depended upon their throwing him into the water; that, to escape drowning himself, he must take a boat and put in it all he wished to save; that it would then rain hard a long time, and a great overflowing of the land would take place. By obeying this prediction the man and his family were saved, and from them the earth was again peopled" (Schoolcraft, *Notes on the Iroquois*, p. 868, 869).

"Of the different nations that inhabit Mexico," says A. von Humboldt, "the following had paintings resembling the deluge of Coxcox, viz. the Aztecs, the Mixtecs, the Zapotecs, the Tlascaltecs, and the Mechoacans. The Noah, Xisuthrus, or Manu of these nations is termed Coxcox, Teo-Cipactli, or Tezpi. He saved himself, with his wife Xochiquetzatl, in a bark, or, according to other traditions, on a raft. The painting represents Coxcox in the midst of the water waiting for a bark. The mountain, the summit of which rises above the waters, is the peak of Colhuacan, the Ararat of the Mexicans. At the foot of the mountain are the heads of Coxcox and his wife. The latter is known by two tresses in the form of horns, denoting the female sex. The men born after the Deluge were dumb: the dove from the top of a tree distributed among them tongues, represented under the form of small commas." Of the Mechoacan tradition he writes, that "Coxcox, whom they called Tezpi, embarked in a spacious *acatl* with his wife, his children, several animals, and grain. When the Great Spirit ordered the waters to withdraw, Tezpi sent out from his bark a vulture, the zopilote, or *vultur curra*. This bird did not return on account of the carcasses with which the earth was strewed. Tezpi sent out other birds, one of which, the humming-bird, alone returned, holding in its beak a branch clad with leaves. Tezpi, seeing that fresh verdure covered the soil, quitted his

bark near the mountain of Colhuacan" (*Vues des Cordillères et Montagnes de l'Amérique*, p. 226, 227). A peculiarity of many of these American Indian traditions must be noted, and that is, that the Flood, according to them, usually took place in the time of the First Man, who, together with his family, escape. But Müller (*Amerikanischen Urreligionen*) goes too far when he draws from this the conclusion that these traditions are consequently cosmogonic, and have no historical value. The fact seems rather to be that all memory of the age between the Creation and the Flood had perished, and that hence these two great events were brought into close juxtaposition. This is the less unlikely when we see how very meagre even the Biblical history of that age is.

It may not be amiss here to mention the legend still preserved among the inhabitants of the Fiji Islands, although not belonging to this group. They say that "after the islands had been peopled by the first man and woman, a great rain took place by which they were finally submerged; but, before the highest places were covered by the waters, two large double canoes made their appearance. In one of these was Rokora, the god of carpenters; in the other, Rokola, his head workman, who picked up some of the people, and kept them on board until the waters had subsided, after which they were again landed on the island. It is reported that in former times canoes were always kept in readiness against another inundation. The persons thus saved, eight in number, were landed at Mbenga, where the highest of their gods is said to have made his first appearance. By virtue of this tradition, the chiefs of Mbenga take rank before all others, and have always acted a conspicuous part among the Fijis. They style themselves *Ngali-dava-ki-langi*—subject to Heaven alone" (Wilkes, *Exploring Expedition*).

In the wild Scandinavian Edda the earth is allegorized as the great giant Ymir, whose bones and flesh are represented by the rocks and soil. This giant was killed by the gods, and his blood (the ocean) poured forth in such a flood that it drowned all the lesser giants—his offspring—except one, who saved himself and his wife by escaping in time to his ship.

4. Greece has two versions of a flood, one associated with Ogyges (*Jul. Afric.* as quoted by Euseb. *Præp. Ev.* x, 10), and the other, in a far more elaborate form, with Deucalion. Both, however, are of late origin—they were unknown to Homer and Hesiod. Herodotus, though he mentions Deucalion as one of the first kings of the Hellenes, says not a word about the Flood (i, 56). Pindar is the first writer who mentions it (*Olymp.* ix, 37 sq.). In Apollodorus (*Biblio.* i, 7) and Ovid (*Métam.* i, 260) the story appears in a much more definite shape. Finally, Lucian gives a narrative (*De Deâ Syr.* c. 12, 13), not very different from that of Ovid, except that he makes provision for the safety of the animals, which Ovid does not. He attributes the necessity for the Deluge to the exceeding wickedness of the existing race of men, and declares that the earth opened and sent forth waters to swallow them up, as well as that heavy rain fell upon them. Deucalion, as the one righteous man, escaped with his wives and children, and the animals he had put into the chest (*Νάρπαρα*), and landed, after nine days and nine nights, on the top of Parnassus, while the chief part of Hellas was under water, and nearly all men perished, except a few who reached the tops of the highest mountains. Plutarch (*de Sollert. Anim.* § 18) mentions the dove which Deucalion made use of to ascertain whether the flood was abated. Most of these accounts, it must be observed, localize the Flood, and confine it to Greece, or some part of Greece. Aristotle speaks of a local inundation near Dodona only (*Meteorol.* i, 14). It must also be confessed that the later narrative the more definite the form it assumes, and the more nearly it resembles the Mosaic account.

This old Greek legend of Deucalion and Pyrrha is the best known of all the traditions next to the narrative of the Bible. (See Jackson, "Noah's and Deucalion's Flood," *Works*, i, 103; "The Deluge of Ogyges and Deucalion," *Bibliotheca Sacra*, 1844, 75.) According to this version, mankind, for its impiety, were doomed to destruction. The waters accordingly broke from the earth, accompanied by a violent rain from heaven. In a short time the world was whelmed in the floods, and every human being perished save Deucalion and his wife, with his sons and their wives. They escaped in a large vessel in which they had previously placed pairs of every kind of animal. While in the ark Deucalion sent forth a dove, which in a little time returned. On being let free a second time it came not back, or, as another version has it, it alighted again on the ark, its mud-stained claws, whence Deucalion inferred that the subsidence of the waters had begun. It may be mentioned, in reference to this tradition, as a very singular coincidence, that just as, according to Greek tradition, the earth was re-peopled by Deucalion and Pyrrha throwing the bones of their mother (i. e. stones) behind their backs, so among the Tamanaki, a Creek tribe on the Orinoko, the story goes that a man and his wife, escaping from the flood to the top of the high mountain Tapanacu, threw over their heads the fronds of the Mauritius-palm, whence sprung a new race of men and women. This curious coincidence between Hellenic and American traditions seems explicit only on the hypothesis of some common centre of tradition.

It seems tolerably certain that the Egyptians had no records of the Deluge, at least if we are to credit Manetho. Nor has any such record been detected in the monuments, or preserved in the mythology of Egypt. They knew, however, of the flood of Deucalion, but seem to have been in doubt whether it was to be regarded as partial or universal, and they supposed it to have been preceded by several others.

On all these and many similar traditions in civilized and savage nations, see the works of Bryant (*Ancient Mythology*, Lond. 1774-6, 3 vols. 4to, vol. iii) and Harcourt (*Doctrine of the Deluge*, Lond. 1833, 2 vols. 8vo.) in which, after rejecting what is fanciful, enough remains to attest the wide-spread existence and mixed agreement of these traditionary recollections of a flood coextensive with the human race.

III. *Extent of the Flood.*—On this question two opinions have been entertained: one, that it was general over the whole globe; the other, that it was partial, affecting only those regions over which the human race had extended. In all inquiries into this subject, it is well to bear in mind the design to be fulfilled by the "flood of waters." That design was plainly not to destroy and remodel the surface of the earth. Although the inferior animals were involved in a like fate with the human race, it was not for their destruction that the great catastrophe came. The wickedness of man had evoked the divine anger; to sweep him and his crimes, therefore, from the face of the earth, the fountains of the great deep were broken up, and the windows of heaven were opened; hence we may reasonably infer that no greater devastation would be permitted than was unavoidable to secure the destruction of the human family. Against the first opinion there is, accordingly, this preliminary objection, that either it takes for granted that the whole world was peopled in the days of Noah, or it represents as involved in ruin large tracts of land, fair and fertile, though uninhabited by man. For the first alternative there is no evidence in Scripture. Indeed, the whole narrative of the preparation of the ark, and Noah's intercourse with his fellow-men, leads us to infer that the population of the globe at the time was not so extensive but that the warnings of the patriarch could be everywhere heard and known. It would have been

in task if his single voice had been required to
 1 in all lands. The second alternative is equally
 re to the opinion of the universality of the deluge,
 ; necessitates our belief in the destruction of large
 ons of the earth's surface where man had never
 , and which could not, therefore, have become
 ed and defiled by sin—a view that is opposed to
 own modes of God's dealings with his creatures.
 against the idea of a general flood over the whole
 e simultaneously, many arguments of much great-
 ree may be brought forward. These are derived
 a consideration of the laws by which the present
 omy of nature is regulated. If it be objected to
 e arguments that the deluge was a miracle, and
 t, accordingly, be judged apart from the operation
 w, it is sufficient to reply that, whether a miracle
 ot, it was brought about by the ordinary agencies
 ature: "the fountains of the deep were broken up"
 at is, the land was depressed and the sea rolled over
 "the windows of heaven were opened"—in other
 ds, a constant and heavy rain was sent upon the
 h; and again, when the waters were to be dried off
 land, a wind was made to blow upon them. In
 rt, from the beginning to the end of the narrative
 Genesis, we meet with no setting aside of the laws
 nature. Everything is done in strict accordance
 h those laws, as if to teach a truth which is very
 to be forgotten in the present day, that what we
 l the laws of nature is only the constant mode in
 ich the Creator acts, and that by the operation of
 ese laws, directed as he sees fit, he works out his
 poses in creation.

1. The astronomical difficulties in the way of the the-
 ry of the absolute universality of the flood over the
 rth's surface are insuperable. Granting, for an in-
 stant, that from some unknown source a vast body of
 water was introduced on the surface of our planet, we
 e led to ask what would be the result? It can be
 own that there was no general collapse of the earth's
 ust, and the water must therefore have risen five
 iles above the sea-level, so as to cover the top of the
 ghest mountain. The effect of this would be to in-
 ease the equatorial diameter of the earth by some
 n or twelve miles. The orbit round the sun would
 sequently be altered. The influence of its attrac-
 on on the planets would be increased, and thus the
 ement of disorder would reach to the remotest re-
 ions of space. But let us suppose that a change of
 is kind was permitted to extend through the unive-
 erse, what is the next step in this series of impossible
 opositions? After a period of less than a year the
 waters assuage, and the earth is once more as it used
 to be. Here, again, another change must have ex-
 tended through the firmament. The old relations of
 he heavenly bodies are re-established, and the orbits
 continue as they were before the flood. Thus we must
 opose a serious alteration to have disturbed every
 celestrial body throughout the whole universe, to have
 asted while our earth performed some three hundred
 evolutions on its axis, and then to have ceased by the
 return of everything to the original condition. And
 his stupendous system of aberration had for its object
 the destruction of a race of creatures inhabiting a
 speck among the planetary systems! No one will pre-
 tend that this hypothesis has any shadow of probabili-
 ty.

2. The geological objections to a universal deluge
 are also formidable. Many years have not elapsed
 since it was believed that the revelations of geology
 tended in a very marked manner to confirm the com-
 monly received view of the deluge. Over the greater
 part of Great Britain and Ireland, and throughout
 Central and Northern Europe as well as North Amer-
 ica, there exists immediately under the vegetable soil
 a deposit of clay, sand, or gravel, often very tumul-
 tuously arranged. This deposit, in the infancy of geo-
 logical science, was set down as the result of some

great rush of waters; and, as it was plainly one of the
 most recent formations of the globe, it came to be re-
 garded as beyond question the result of that old deluge
 by which the human race had been destroyed. It re-
 ceived, accordingly, the name *diluvium*; and, from its
 very general occurrence in both hemispheres, it was
 held to be a confirmation of the Bible narrative of the
 flood that covered "all the high hills that were under
 the whole heaven." But the identification proved too
 hasty. A more careful examination of the diluvium
 showed that it belonged to many different periods, and
 had, to a considerable extent, resulted from local
 causes, acting over limited areas. It was ascertained,
 however, that one kind of diluvium, having a wide dif-
 fusion over the northern parts of Europe and America,
 must have been produced by one great cause acting in
 the same geological period. The agency which gave
 rise to this "drift" was nevertheless shown to be not
 a rush of water, but ice coming from the north, either
 in the form of a glacier or as icebergs, and bearing
 with it enormous quantities of sand, mud, and stones.
 Thus the last hope of sustaining the doctrine of a uni-
 versal deluge by an appeal to geological facts fell to
 the ground. Not only does geology afford no evi-
 dence in favor of such a doctrine, but it tends to sup-
 port the opposite view. The notion of a simultaneous
 and universal desolation of the globe finds no counte-
 nance among those stony records in which the prime-
 val history of our planet is graven as with a pen of
 iron in the rock forever. There are, indeed, many gaps
 in the chronicle, many passages that have been blotted
 out in whole or in part, and some pages that seem never
 to have been inscribed among rocks at all, but these
 are only local. What is wanting in one place is often
 made up in another; and, though even at the best the
 record is full of imperfections, the geologist can con-
 fidently affirm that its whole tenor goes to disprove any
 universal catastrophe, and to show that the extinction
 of successive races of plants and animals has been im-
 perceptibly effected during immensely protracted peri-
 ods of time.

Another geological argument has often been ad-
 duced as bearing strongly against a general deluge.
 In Auvergne, and other districts of Central France,
 there occurs a series of volcanoes which have not been
 in action within the historical period. From the assoc-
 iation of the remains of long extinct animals among
 the products of these volcanoes, it has been inferred
 that the era of eruption must be assigned to a time
 long anterior to the appearance of man. Yet these
 volcanic cones are in many instances as perfect as
 when they were first thrown up. Travellers who have
 climbed their sides and descended into their craters
 bear testimony to the fact that they consist of dust
 and cinders still so loosely aggregated that the travel-
 ler sometimes sinks over the ankle in volcanic debris.
 Such light material has assuredly been exposed to the
 action of no large body of water, which would have
 swept it at once away, like Graham's Island, which
 arose in the Mediterranean, July, 1831, to a height of
 200 feet and a circumference of three miles, but in a
 few months was washed down to a mere shoal (*Bibli-
 otheca Sacra*, July, 1837, p. 465). Hence, since these
 volcanoes belong to a period earlier than that of man,
 the deluge cannot have extended over Central France.

Formerly, the existence of shells and corals at the
 top of high mountains was taken to be no less conclu-
 sive evidence the other way. They were constantly
 appealed to as a proof of the literal truth of the Script-
 ure narrative. So troublesome and inconvenient a
 proof did it seem to Voltaire, that he attempted to ac-
 count for the existence of fossil shells by arguing that
 either they were those of fresh-water lakes and rivers
 evaporated during dry seasons, or of land-snails devel-
 oped in unusual abundance during wet ones; or that
 they were shells that had been dropped from the hats
 of pilgrims on their way from the Holy Land to their

own homes; or, in the case of the ammonites, that they were petrified reptiles. It speaks ill for the state of science that such arguments could be advanced, on the one side for, and on the other against, the universality of the Deluge. This is the more extraordinary—and the fact shows how very slowly, where prejudices stand in the way, the soundest reasoning will be listened to—when we remember that so early as the year 1517 an Italian named Fracastoro had demonstrated the untenableness of the vulgar belief which associated these fossil remains with the Mosaic Deluge. "That inundation," he observed, "was too transient; it consisted principally of fluvial waters; and, if it had transported shells to great distances, it must have strewn them over the surface, not buried them at vast depths in the interior of mountains. . . . But the clear and philosophical views of Fracastoro were disregarded, and the talent and argumentative powers of the learned were doomed for three centuries to be wasted in the discussion of these two simple and preliminary questions: first, whether fossil remains had ever belonged to living creatures; and, secondly, whether, if this be admitted, all the phenomena could not be explained by the deluge of Noah" (Lyell, *Principles of Geology*, p. 20, 9th edit.). Even within the last thirty years geologists like Cuvier and Buckland (*Reliquiæ Diluvianæ*, Lond. 1823, 4to) have thought that the *superficial deposits* might be referred to the period of the Noachian Flood. Subsequent investigation, however, showed that if the received chronology were even approximately correct, this was out of the question, as these deposits must have taken place thousands of years before the time of Noah, and, indeed, before the creation of man. Hence the geologic diluvium is to be carefully distinguished from the historic. Although, singularly enough, the latest discoveries give some support to the opinion that man may have been in existence during the formation of the drift, yet even then that formation could not have resulted from a mere temporary submersion like that of the Mosaic Deluge, but must have been the effect of causes in operation for ages. So far, then, it is clear, there is no evidence now on the earth's surface in favor of a universal deluge. See GEOLOGY.

8. But perhaps the most startling of all the difficulties in the way of the belief in a universal deluge are presented to us in the researches of the zoologist. From him we learn that, even taking the cubit by which the ark was measured to have been of the longest, the ark was totally inadequate to contain the animals even of a single continent. It would occupy too much space to enter here into the details of this part of the subject. We refer the reader to one of the lectures of Hugh Miller (*Testimony of the Rocks*, p. 267). Sir Walter Raleigh thought he had exhausted the capabilities of the ark when, after calculating the amount of space that would be occupied by the animals known to himself at the time, he concluded that "all these two hundred and eighty beasts might be kept in one story or room of the ark, in their several cabins, their meat in the second, the birds and their provisions in the third, with space to spare for Noah and his family, and all their necessities" (*History of the World*, p. 57). Since Raleigh's time, however, the known number of terrestrial animals has been enormously increased. Of mammalia alone there are now known between 1600 and 1700 species. To these must be added upwards of 6000 birds, 650 reptiles, and 550,000 insects, all of which would require room and a provision of food in the ark. It is needless to remark that no vessel ever fashioned by man could have accommodated a tithe of these inmates. See NOAH'S ARK.

But over and above the impossibility of constructing a vessel large enough to contain all the species of terrestrial animals that inhabit the globe, it would have been equally impossible in the days of Noah,

just as it would be utterly impossible in our own times to collect all these creatures alive into one corner of the earth. No one needs to be informed that the animal tribes are not all represented in any one corner; that certain races are confined to high latitudes, and others roam among the temperate zones, while others are found only between the tropics. Nor is it necessary to do more than allude to the fact that there is a similar grouping on all high land, altitude above the sea being thus representative of recession from the equator, so that the bald head of a lofty mountain may be white with the snows of an eternal winter, its shoulders clad with the spring-like vegetation of temperate latitudes, while its feet lie rich in the varieties of a tropical summer. But besides this arrangement, according to climate and temperature, there is still further subdivision into provinces, and these again into generic and specific centres. Thus, while at some of latitude has its peculiar *faunes* of animal and vegetable life, it contains so many distinct and independent areas, in which the animals and plants, on a large extent generically or specifically different from those of contiguous areas. The evidence of these specialized groups of organisms points in part to old geological changes of sea and land, and possibly to other causes which are still far from being understood. Professor Edward Forbes treated them as *centres of creation*, that is, distinct areas in which groups of plants and animals had been created, and from which, as a common centre, they had gradually radiated, as they encroach more or less upon the neighboring sea. Hence, to collect specimens of all the species of terrestrial creatures inhabiting the earth, it would be necessary not only to visit each parallel of latitude on both sides of the equator, but to explore the whole coast of each parallel, so as to leave out none of the separate provinces. With all the appliances of modern civilization, and all the labors of explorers in the cause of science throughout every part of the world, the task of ascertaining the extent of the animal kingdom is probably still far from being accomplished. Not a year passes away without witnessing new names added to the lists of the zoologist. Surely no one can pretend that what has not yet been achieved by hundreds of laborers during many centuries could have been performed by one of the patriarchs during a few years. It was of course necessary that the animals should be brought alive. But this, owing to their vital susceptibilities, was in the case of many species impossible, and even with regard to those which might have survived the journey, the difficulties of transportation must have been altogether insuperable. Noah, moreover, was busy with his great rescue, and continued to be "a preacher of repentance" to his fellow-men—occupations which admitted of no peregrinations to the ends of the earth in search of inmates for the ark. It is indeed beyond our power to follow in the train of impossibilities which such a notion implies. Dr. J. Pye Smith remarks that the idea of a collection of all the terrestrial animals of the globe brought by Noah to the ark cannot be entertained "without bringing up the idea of miracles more expeditious than any that are recorded in Scripture, even what appear appalling in comparison; the great decisive miracle of Christianity—the resurrection of the Lord Jesus—sinks down before it."

The existence of distinct provinces of plants and animals is a fact full of the deepest interest, and opens out many wide fields of inquiry. Its bearing on the question of the deluge is of course that phase which more especially requires to be noticed here. In addition to what has just been said, it may be remarked further, that these provinces have a geological as well as a zoological significance. Laying aside as altogether impossible the idea of the representation in the ark of every terrestrial species, we may obtain some corroboratory evidence that the existing races of plants and

ials have never been interrupted by a general catastrophe. A careful study of these provinces shows some are older than others, just as some parts of earth's surface are geologically older than others. In certain cases a province is found to contain in itself the relic of an older province which once occupied the same spot. In the profound depths of maritime lochs that indent the western coast of Scotland, there exist little groups of shell-fish which not now found alive in the shallower parts. Yet they once lived even in the shallower water, and their remains are now found fossil along the shores of the Loch of Clyde and elsewhere. They have become gradually extinct in the upper part of the sea, owing probably to a change of climate, and are now confined to the very deepest zones. These and other facts of the same kind point to slow and gradual changes unknown by any great cataclysmal event. Among mountains, too, similar phenomena abound. It should not be lost sight of, that, had the whole earth been covered a year by a sheet of water, the greater part of our terrestrial plants must have perished. On the disappearance of the flood there would hence require to be a new creation, or rather re-creation, all over the world—a supposition for which there is no evidence either in Scripture or nature, and which is opposed to that which we know of the method of the divine work. Plants are grouped, like animals, in greater and lesser provinces; and these, too, differ greatly from each other in antiquity. Some assemblages of plants have spread over wide districts, and either extirpated or those which had previously occupied the ground or driven them into sheltered corners. In Great Britain and Ireland, for instance, there are five distinct groups of plants which have also corresponding suites of animals. The successive migrations of these groups can still be traced, leading us to a knowledge of certain stages which have taken place among the British islands within a comparatively recent geological period. England was still united to the Continent when the oldest group of plants began to flourish in the northern half of the island, with the whole of Scotland, was submerged beneath the sea, and again elevated before the great mass of the British plants crept eastward across the plains that united the islands with the Continent. It was after the whole of our present groups of plants and animals had become fixed in their existing habitats that the isthmus was broken through by the waves and Britain became an island. These changes could not have been brought about save during the lapse of a protracted series of ages. They give evidence of no sudden break, no temporary annihilation and subsequent creation, such as the idea of a general flood would require, but, on the contrary, show very clearly that the present races of plants and animals have gone on in unbroken succession from a time that long preceded the advent of man.

There is, however, other evidence conclusive against the hypothesis of a universal deluge, miracle apart. "The first effect of the covering of the whole globe with water would be a complete change in its climate, the general tendency being to lower and equalize the temperature of all parts of its surface. *Pari passu* with this process . . . would ensue the destruction of the great majority of marine animals. This would take place, partly by reason of the entire change in climatal conditions, too sudden and general to be escaped by migration; and, in still greater measure, in consequence of the sudden change in the depth of the water. Great multitudes of marine animals can only live between tide-marks, or at depths less than fifty fathoms; and as by the hypothesis the land had to be depressed many thousands of feet in a few months, and to be raised again with equal celerity, it follows that the animals could not possibly have accommodated themselves to such vast and rapid changes. All the littoral animals, therefore, would have been killed.

The race of acorn-shells and periwinkles would have been exterminated, and all the coral-reefs of the Pacific would at once have been converted into dead coral, never to grow again. But, so far is this from being the case, that acorn-shells, periwinkles, and coral still survive, and there is good evidence that they have continued to exist and flourish for many thousands of years. On the other hand, Noah was not directed to take marine animals of any kind into the ark, nor, indeed, is it easy to see how they could have been preserved. Again, had the whole globe been submerged, the sea-water covering the land would at once have destroyed every fresh-water fish, mollusk, and worm; and as none of these were taken into the ark, the several species would have become extinct. Nothing of the kind has occurred. Lastly, such experiments as have been made with regard to the action of sea-water upon terrestrial plants leave very little doubt that submergence in sea-water for ten or eleven months would have effectually destroyed not only the great majority of the plants, but their seeds as well. And yet it is not said that Noah took any stock of plants with him into the ark, or that the animals which issued from it had the slightest difficulty in obtaining pasture. There are, then, it must be confessed, very strong grounds for believing that no universal deluge ever occurred. Suppose the Flood, on the other hand, to have been local; suppose, for instance, the valley of the Euphrates to have been submerged; and then the necessity for preserving all the species of animals disappears. For, in the first place, there was nothing to prevent the birds and many of the large mammals from getting away; and, in the next, the number of species peculiar to that geographical area, and which would be absolutely destroyed by its being flooded, supposing they could not escape, is insignificant."

We are thus compelled to adopt the opinion that the flood of Noah was (like other deluges of which we read) a local event confined to one part of the earth's surface, and that it was "universal" only inasmuch as it effected the destruction of the whole human race, the family of Noah alone excepted. Against this opinion no objections of any weight can be urged. It is borne out by the evidence to be derived from a study of the phenomena of nature; and it is not at variance with any statement in holy Scripture. The universality of the language in which Moses describes the extent of the Deluge—"all the high hills that were under the whole heaven were covered"—has indeed been regarded as a testimony to the universality of the catastrophe. But such general expressions are of frequent occurrence in the sacred writings to denote a tract of country which, though large relatively to its inhabitants, yet formed only a very small portion of the earth's surface. No authentic traces of the action of the flood have yet been detected in the East, where the area of submersion was probably situated, nor indeed is it likely that any such traces will ever be found. They might confirm our faith, but they are by no means necessary, for the fact of the former destruction of the human race is made known to us in the sacred volume, and has been handed down by tradition in almost every nation of the earth, even the most barbarous and the farthest removed from the early cradle of the human race. It is natural to suppose that the writer, when he speaks of "all flesh," "all in whose nostrils was the breath of life," refers only to his own locality. This sort of language is common enough in the Bible when only a small part of the globe is intended. Thus, for instance, it is said that "all countries came into Egypt to Joseph to buy corn;" and that "a decree went out from Cæsar Augustus that all the world should be taxed." In these and many similar passages the expressions of the writer are obviously not to be taken in an exactly literal sense. Even the apparently very distinct phrase "all the high hills that were under the whole

heaven were covered" may be matched by another precisely similar, where it is said that God would put the fear and the dread of Israel upon every nation under heaven. It requires no effort to see that such language is framed with a kind of poetic breadth. The real difficulty lies in the connecting of this statement with the district in which Noah is supposed to have lived, and the assertion that the waters prevailed fifteen cubits upward. If the Ararat on which the ark rested be the present mountain of the same name, the highest peak of which is more than 17,000 feet above the sea, it would have been quite impossible for this to have been covered, the water reaching fifteen cubits, i. e. twenty-six feet above it, unless the whole earth were submerged. The author of the *Genesis of the Earth*, etc. has endeavored to escape this difficulty by shifting the scene of the catastrophe to the low country on the banks of the Tigris and Euphrates (a miraculous overflow of these rivers being sufficient to account for the Deluge), and supposing that the "fifteen cubits upward" are to be reckoned, not from the top of the mountains, but from the surface of the plain. By "the high hills" he thinks may be meant only slight elevations, called "high" because they were the highest parts overflowed. But fifteen cubits is only a little more than twenty-six feet, and it seems absurd to suppose that such trifling elevations are described as "all the high hills under the whole heaven." At this rate the ark itself must have been twice the height of the highest mountain. The plain meaning of the narrative is that, far as the eye could sweep, not a solitary mountain reared its head above the waste of waters. On the other hand, there is no necessity for assuming that the ark stranded on the high peaks of the mountain now called Ararat, or even that that mountain was visible. A lower mountain range, such as the Zagros range for instance, may be intended. In the absence of all geographical certainty in the matter, it is better to adopt some such explanation of the difficulty. Indeed, it is out of the question to imagine that the ark rested on the top of a mountain which is covered for 4000 feet from the summit with perpetual snow, and the descent from which would have been a very serious matter both to men and other animals. The local tradition, according to which the fragments of the ark are still believed to remain on the summit, can weigh nothing when balanced against so extreme an improbability. Assuming, then, that the Ararat here mentioned is not the mountain of that name in Armenia, we may also assume the inundation to have been partial, and may suppose it to have extended over the whole valley of the Euphrates, and eastward as far as the range of mountains running down to the Persian Gulf, or further. As the inundation is said to have been caused by the breaking up of the fountains of the great deep, as well as by the rain, some great and sudden subsidence of the land may have taken place, accompanied by an inrush of the waters of the Persian Gulf, similar to what occurred in the Runn of Cutch, on the eastern arm of the Indus, in 1819, when the sea flowed in, and in a few hours converted a tract of land 2000 square miles in area into an inland sea, or lagoon (see the account of this subsidence of the Delta of the Indus in Lyell's *Principles of Geology*, p. 460-68).—Kitto, s. v.; Smith, s. v. Noah. Compare FLOOD.

De'lus (or DELOS, Δῆλος, so called from having appeared, δῆλος, manifest, from the sea, at the command of Neptune), mentioned in 1 Macc. xv, 28, as one of the places addressed by Lucius in behalf of the Jews, is the smallest of the islands called Cyclades, in the Ægean Sea (see Smith's *Dict. of Class. Geog.* s. v.), being only about five miles in circumference (Pliny, ii, 89). It was situated between Myconus and Rhenea. It was one of the chief seats of the worship of Apollo, and was celebrated as the birth-place of this ¹ and of his sister Artemis, or Diana (Spanheim on imachus's *Hymn to Del.*). We learn from Jose-

phus (*Ant.* xiv, 10, 8) that Jews resided in this island, which may be accounted for by the fact that, after the fall of Corinth (B.C. 146), it became the centre of extensive commerce (Cicero, *Manil.* 18; Pliny, ii, xvi, 89; Livy, xli, 25; xlv, 29; Strabo, xiv, p. 68; Pausanias, iii, 23). The sanctity of the spot in Greece, iii, 222) and its consequent security, in Italy, which was a kind of fair, the excellence of its harbor, and its convenient situation on the highway between Italy and Greece to Asia, made it a favorite resort of merchants (Strabo, x, p. 486). So extensive was the commerce carried on in the island that 10,000 slaves are said to have changed hands there in one day (Strabo, xiv, p. 668). It was especially celebrated for bronze (see *Deliacum*, Pliny, xxxiv, 2, 4; Cicero, *Ant.* 46; *Verr.* ii, 84). Delus is at present uninhabited except by a few shepherds, but contains extensive ruins (Tournefort, i, 349 sq.). It, together with an adjoining island, is now called *Dhiles*. See Leake, *Norie Greece*, iii, 95 sq.; Ross, *Reisen auf d. Griech. Inseln*, 30; ii, 167; Sallier, *Hist. de l'Isle de Delos*, in the *Ann. de l'Acad. des Inscip.* iii, 376; Schwenk, *Delos*, Part I (Francof. 1825); Schläger, *De Rebus Del.* p. 1840).

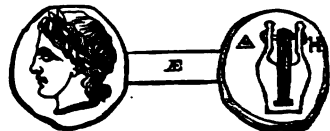

Coin of Delos.

De Lyra. See LYRA.

De Maistre. See MAISTRE.

De'mas (Δημάς, probably a contraction from Δημήτριος, or perhaps from Δημαργός), a companion of the apostle Paul (called by him his fellow-laborer, *συνεργός*, in Philem. 24; see also Col. iv, 14) during his first imprisonment at Rome. B.C. 57. At a later period (2 Tim. iv, 10), we find him mentioned as having deserted the apostle through love of this present world, and gone to Thessalonica. B.C. 64. This departure has been magnified by tradition into an apostasy from Christianity (see Epiphanius, *Heret. l.* i, which is by no means implied in the passage (*Basil. Ecc. Apost.* p. 311 sq.).—Smith, s. v.

Demay. See TALMUD.

Demetrius (Δημήτριος, probably from Δημήτηρ, the Greek name of the goddess Cybele), the name originally of several of Alexander's generals (see Smith's *Dict. of Class. Biog.* s. v.), and borne by several of the Macedonian and Syrian princes, two of whom are often referred to in the Apocrypha, and three in Josephus; also by two men mentioned in the New Test., and by several others in Josephus.

1. DEMETRIUS I, surnamed SOTER (Σωτήρ, "the Saviour," in recognition of his services to the Bactrianians), king of Syria, was the son of Seleucus II Philopator, and grandson of Antiochus the Great. While still a boy he was sent by his father as a hostage to Rome (B.C. 175) in exchange for his uncle Antiochus Epiphanes (Appian, *Syr.* 45). From this position he was unable to offer any opposition to the usurpation of the Syrian throne by Antiochus IV; but on the death of that monarch (B.C. 164) he claimed his liberty, and the recognition of his claim by the Roman senate in preference to that of his cousin Antiochus V. His petition was refused from selfish policy (Polyb. xxxi, 12), and by the advice and assistance of Polybius, whose friendship he had gained at Rome (Polyb. xxxi, 19; Justin, xxxiv, 8), he left Italy secretly, and landed with a small force at Tripolis in Phœnicia (2 Macc. xiv, 1; 1 Macc. vii, 1; Josephus *Ant.* xii, 1). The Syrians soon declared in his favor (B.C. 162), and Antiochus and his protector Lyzusæ were put to death (1 Macc. vii, 2, 8; 2 Macc. xiv, 5).

ing thus gained possession of the kingdom, Demetrius succeeded in securing the favor of the Romans (Polyb. xxii, 4), and he turned his attention to the final organization of his dominions. The Græcizans party were still powerful at Jerusalem, and he exerted them by arms. In the first campaign his rival Bacchides established Alcimus in the high priesthood (1 Macc. vii, 5-20); but the success was not permanent. Alcimus was forced to take refuge a second time at the court of Demetrius, and Nicanor, who was commissioned to restore him, was defeated in two successive engagements by Judas Maccabæus (1 Macc. 31, 32, 48-45), and fell on the field (see Michaelis 1 Macc. vii, 32, against Wernsdorf, *De fide Maccab.* 24 sq.; also Joseph. *Ant.* xii, 10, 2). Two other campaigns were undertaken against the Jews by Bacchides (B.C. 161-158); but in the mean time Judas had completed a treaty with the Romans shortly before his death (B.C. 161), who forbade Demetrius to oppress the Jews (1 Macc. viii, 31). Not long afterwards Demetrius further incurred the displeasure of the Romans by the expulsion of Ariarathes from Cappadocia (Polyb. xxxi, 20; Justin, xxxv, 1), and he alienated the affection of his own subjects by his private excesses (Justin, l. c.; comp. Polyb. xxxiii, 14). When his power was thus shaken (B.C. 152), Alexander Balas was brought forward, with the consent of the Roman senate, as a claimant to the throne, with the powerful support of Ptolemy Philometor, Attalus, and Ariarathes. Demetrius vainly endeavored to secure the services of Jonathan, who had succeeded his brother Judas as leader of the Jews, and now, from the recollection of his wrongs, warmly favored the cause of Alexander (1 Macc. x, 1-6). The rivals met in a decisive engagement (B.C. 150), and Demetrius, after displaying the greatest personal bravery, was defeated and slain (1 Macc. x, 48-50; Joseph. *Ant.* xiii, 2, 4; Polyb. i, 5). In addition to the very interesting fragments of Polybius, the following references may be consulted: Justin, xxxiv, 3; xxxv, 1; Appian, *Syr.* 46, 47, 7; Livy, *Epit.* xlvii; Euseb. *Ann. Chron.* p. 165. He left two sons, Demetrius, surnamed Nicator, and Antiochus, called Sidetes, both of whom subsequently ascended the throne.—Smith, s. v. See ANTCIOCHUS.

Macc. x, 74-82). In spite of these hostilities, Jonathan succeeded in gaining the favor of Demetrius when he was established in the kingdom (1 Macc. xi, 23-27), and obtained from him an advantageous commutation of the royal dues and other concessions (1 Macc. xi, 32-37). In return for these favors the Jews rendered important services to Demetrius when Tryphon first claimed the kingdom for Antiochus VI, the son of Alexander (1 Macc. xi, 42); but afterwards, being offended by his faithless ingratitude (1 Macc. xi, 68), they espoused the cause of the young pretender. In the campaign which followed, Jonathan defeated the forces of Demetrius (B.C. 144; 1 Macc. xii, 28); but the treachery to which Jonathan fell a victim (B.C. 143) again altered the policy of the Jews. Simon, the successor of Jonathan, obtained very favorable terms from Demetrius (B.C. 142); but shortly afterwards Demetrius was himself taken prisoner (B.C. 138) by Arsaces (q. v.) VI (Mithridates), king of Parthia, whose dominions he had invaded (1 Macc. xiv, 1-3; Justin, xxxvi; Joseph. *Ant.* xiii, 5; Livy, *Epit.* lii). Appian and Justin place this captivity of Demetrius before the revolt of Tryphon, but the order of the narrative in the book of Maccabees is most probable (notwithstanding Wernsdorf, *De fide Maccab.* p. 137 sq.). Mithridates treated his captive honorably, and gave him his daughter Rhodoguna in marriage (Appian, *Syr.* 67); and after his death, though Demetrius made several attempts to escape, he still received kind treatment from his successor, Phraates. When Antiochus Sidetes, who had gained possession of the Syrian throne, invaded Parthia, Phraates employed Demetrius to effect a diversion. In this Demetrius succeeded, and when Antiochus fell in battle he again took possession of the Syrian crown (B.C. 128). Not long afterwards a pretender, supported by Ptolemy Physcon, appeared in the field against him, and after suffering a defeat he was assassinated, according to some by his wife Cleopatra (Appian, *Syr.* 68), while attempting to escape by sea (Justin, xxxix, 1; Joseph. *Ant.* xiii, 9, 8).—Smith, s. v. See CLEOPATRA.



Tetradrachm (Attic Talent) of Demetrius I. *Obverse:* Head of Demetrius to the right. *Reverse:* Legend (in Greek), "Of King Demetrius Soter;" in the field, monogram and MI; in exergue, AEP (161 of *ÆR.* Seleuc.); seated female figure to the left, with sceptre and cornucopia.

2. DEMETRIUS II, surnamed NIKĀTOR (Νικᾶτωρ, "the Victor;" so on coins, Eckhel, iii, 229 sq.; elsewhere ΝΙΚΑΝΟΡ), king of Syria, was the elder son of Demetrius Soter, preceding. He was sent by his father, together with his brother Antiochus, with a large treasure, to Cnidus (Justin, xxxv, 2), when Alexander Balas laid claim to the throne of Syria, and thus escaped falling into the hands of that usurper. When he was grown up, the weakness and vices of Alexander furnished him with an opportunity of recovering his father's dominions. Accompanied by a force of Cretan mercenaries (Justin, l. c.; comp. 1 Macc. x, 67), and aided by Ptolemy Philometor (1 Macc. xi, 19; Diod. Sic. *Ecl.* xxxii, 1), whose daughter Cleopatra was promised to him, he made a descent on Syria (B.C. 148 or 147), and was received with general favor (1 Macc. x, 67 sq.). Jonathan, however, still supported the cause of Alexander, and defeated Apollonius, whom Demetrius had appointed governor of Cœle-Syria (1



Tetradrachm (Attic Talent) of Demetrius II. *Obverse:* Head of Demetrius to the right. *Reverse:* Inscription (in Greek), "Of King Demetrius Theos Philadelphus Nicator;" in exergue, $\Xi\text{P}\Theta$ (169 of *ÆR.* Seleuc.). Apollo to the left, seated on corymba, with arrow and bow.

3. DEMETRIUS III, surnamed ΕΥΚΑΙΡΟΣ (Εὐκαιρός, i. e. "the Opportune;" on coins THEOS PHILOPATOR and SOTER (Eckhel, iii, 246, 246), king of Syria, was the fourth son of Antiochus Grypus, and grandson of Demetrius II. During the civil wars that followed the death of his father, he was set up as king of Damascus, or Cœle-Syria, by the aid of Ptolemy Lathyrus, king of Cyprus; and after the death of Antiochus Eusebes, he and his brother Philip for a time held the whole of Syria (Josephus, *Ant.* xiii, 18, 4). His assistance was invoked by the Jews against the tyranny of Alexander Jannæus (q. v.); but, though he defeated this prince in battle, he did not follow up the victory, but withdrew to Beroea. War immediately broke out between him and his brother Philip; and Strator, the governor of Beroea, who supported Philip, having obtained assistance from the Arabians and Parthians, blockaded Demetrius in his camp, until he was compelled by famine to surrender at discretion. He was sent as a prisoner to Mithridates (Arsaces IX), king of Parthia, who detained him in an honorable captiv-

ity till his death (Josephus, *Ant.* xiii, 14). His coins bear date from 218 to 224 *Ær.* Seleucid., i. e. B. C. 94-88. See SYRIA.

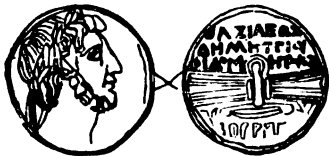

Coin of Demetrius III.

4. Surnamed PHALEREUS (ὁ Φαληρέσις, the *Phalerian*), the zealous keeper of the Alexandrian library under Ptolemy Philadelphus, who at his suggestion undertook the Septuagint (q. v.) version, and secured the benefit of the criticism of the resident Jews upon the translation (Josephus, *Ant.* xii, 2, 1, 4, 18). See Ostermann, *De Dem. Phal. vita, rebus gestis et scriptorum reliquiis* (pt. i, Hersfeld, 1847, 4to).

5. A freed-man of Pompey, who rebuilt, at his request, the city of Gadara, of which he was a native (Josephus, *Ant.* xiv, 4, 4).

6. An Alexandrian Jew and alabarch, who married Mariamne (formerly the wife of Archelaus), by whom she had a son Agrippinus (Josephus, *Ant.* xx, 7, 8).

7. A silversmith at Ephesus, who, being alarmed at the progress of the Gospel under the preaching of Paul, assembled his fellow-craftsmen, and excited a tumult by haranguing them on the danger that threatened the worship of the great goddess Diana, and consequently their own craft as silversmiths. A. D. 52. Their employment was to make "silver shrines for Diana" (Acts xix, 24); and it is now generally agreed that these "shrines" (*vaoi*) were silver models of the temple, or of its adytum or chapel, in which perhaps a little image of the goddess was placed. These, it seems, were purchased by foreigners, who either could not perform their devotions at the temple itself, or who, after having done so, carried them away as memorials, or for purposes of worship, or as charms. The continual resort of foreigners to Ephesus from all parts, on account of the singular veneration in which the image of the goddess was held, must have rendered this manufacture very profitable, and sufficiently explains the anxiety of Demetrius and his fellow-craftsmen. See DIANA.

8. A Christian, mentioned with commendation in 3 John 12. A. D. cir. 90. From the connection of the apostle John with Ephesus at the time the epistle was written, some have supposed that this Demetrius is the same as the preceding, and that he had been converted to Christianity. But this is a mere conjecture, rendered the more uncertain by the commonness of the name.—Kitto, s. v.

Demetrius, bishop of Alexandria, is said to have succeeded Julian in that see A. D. 189 (Eusebius, *ll. E.* v, 22). He was at first the friend of Origen, and committed the instructions in the school of Alexandria entirely to him (Eusebius vi, 8); but he afterwards, "overcome by human infirmity" (Euseb. vi, 8) seems to have become envious of Origen, and his enemy. When Origen (A. D. 228) was ordained presbyter at Cæsarea, Demetrius excluded him from the Church—an act which was not recognized by the churches generally. Demetrius died about 248.—Mosheim, *Commentaries*, cent. iii, § 80. See ORIGEN.

Demetrius, CYDONIUS, a theologian of the Greek Church, lived in the second half of the 14th century. He was born at Thessalonica or Byzantium, and probably received his surname from the circumstance that he lived at Cydona in Crete. The emperor John Cantacuzenus, who was greatly attached to him, raised him to the highest posts of honor in the state. When a prince thought of embracing monastic life, Deme-

trius determined to leave the world also, and both entered the same convent in 1365. Subsequently he went to Italy to study the theology of the Lat Church, and while there became a friend of Thomas Aquinas and other prominent Latin theologians. The year of his death is not known; the latest incident of his life is a letter addressed in 1384 to the emperor Manuel Palæologus, on the occasion of the latter ascending the throne. He is the author of a large number of works, and the translator of many Latin works into Greek. Most of his works have never been printed. His work, *Περί τοῦ καταφρονεῖν τὴν ζωὴν καὶ καταμενεῖν τὴν θάνατον*, on *contemning death*, was printed by R. Seiler (Basel, 1558), and by Kriemoel (Leipzig, 1786). A selection of his letters was published by Matthæi (Moscow 1776, and Dresden, 1789). For a list of his writings and their various editions, see H. J. Mann, *Bibliographisches Lexikon*, i, 499; Fabricii *Bibliotheca Græca*, i, 498; see also Hoefer, *Biographie Générale*, xiii, 558.

Demission, the name in Scotch Presbyterian churches for the act by which a minister resigns his charge. He can only resign it into the hands of the presbytery, as they ordained him. The court judges of the grounds of demission, and may refuse or comply. An old form in the Church of Scotland was as follows: "I, Mr. A. B., minister at C., for such cause demit my ministry at the said parish of C., purely and simply into the hands of the presbytery of D., declaring that, for my part, the said parish shall be held vacant, and that it shall be free to the parish and presbytery, after due intimation hereof, by warrant of the presbytery, to call and plant another minister therein; and consent that this be recorded in the presbytery books, *ad futuram rei memoriam*. In witness whereof I have subscribed these presents at —, etc." The demission being accepted, the church is declared vacant.—Eadie, *Ecccl. Dictionary*, s. v.

Demiurge (Greek, *δημιουργός*, from *δημιος*, people, and *ἔργον*, obs. *I work*; a *worker for the people*), hence, a *workman*, *craftsman*) was the name given by the Gnostics to the mysterious being by whom God is supposed to have created the universe. The Gnostics believed that the Supreme Being dwelt in a false and pleroma) of inaccessible light; that he had created other beings, called sons, or emanations; that from these other sons were descended; and from these an inferior order of spirits were derived, among whom he called the Demiurge had created the world, and had rebelled against the Supreme Being. He makes out of matter the visible world, and rules over it. He was considered as the God of the Jews. "In the further development of the idea the Gnostic systems differ: the anti-Jewish Gnostics, Marcion and the Ophites, represent the Demiurge as an insolent being, resisting the purposes of God, while the Judaizing Gnostics, Basilides and Valentine, make him a restricted, unconscious instrument of God to prepare the way of redemption."—Schaff, *Hist. of Christian Church*, i, § 71; Mosheim, *Commentaries* (Murdock's translation, i, § 461; ii, 331). See GNOSTICISM.

Demme, CHARLES RUDOLPH, D. D., an eminent Lutheran divine, the son of Dr. Herman Demme, was born in Mühlhausen, Thuringia, April 10, 1793. He studied at the Gymnasium at Altenburg, and the universities of Göttingen and Halle. On the uprising of Germany to repel the invasion of Napoleon, he offered his services, and immediately repaired to the scene of conflict. His zeal led him into imminent danger; and at Waterloo he was carried, wounded and bleeding, from the field. He had been designed for the law. He came to this country in 1818, a young man of twenty-three, deeply imbued with the love of liberty, and an ardent admirer of American institutions. He entered the ministry in 1819, and accepted a call to Hummelstown, Pa. He removed to Philadelphia

822, and became associate pastor with Rev. Dr. offer of St. Michael's and Zion's churches, where continued to labor for thirty-seven years with great activity and success. Worn out by great labors, for several years before his death he was unable to perform any active duties in the ministry. He died Sept. 1863. Dr. Demme was a man of enlarged culture, accomplished scholar, and a prince among preachers.

As a pulpit orator he was not surpassed by any of his contemporaries. Illustrating in his life the serene and blessedness of the Gospel, he brought to the people piety and learning, and made the ministry of the Word the grand aim of his life, with which no other pursuit was allowed to interfere. In 1839 he was elected to the professorship of the Theological Seminary, Columbus, Ohio, and in 1849 was appointed professor in the seminary at Gettysburg, but both positions he felt it his duty to decline. He was a member of the American Philosophical Society, and was honored with the doctorate of divinity from the University of Pennsylvania. He edited in German the works of Josephus, carefully comparing the translation with the original, and adding a large number of notes.

Demon; Dæmoniac. See **DÆMON; DÆMONIAC.**

Dem'ophon (Δημόφῶν), a Syrian general or military governor in Palestine under Antiochus V. Eupator (2 Macc. xii, 2).

Dempster, John, D.D., an eminent Methodist minister and promoter of theological learning in the church, was born Jan. 2, 1794, in the town of Florida, N. Y. His father, the Rev. James Dempster, was a Scotchman, educated at the University of Edinburgh, and, though bred a Presbyterian, was received by Mr. Wesley as one of his collaborators, and sent by him as a missionary to America. He preached for a season in the city of New York, but for some reason became disconnected from Mr. Wesley's service, and was thereafter a pastor of a Presbyterian church in the town of Florida till his death in 1808. The son was too young to profit intellectually from his father's training, and grew up ignorant almost of books till his conversion at a Methodist camp-meeting in 1812, when he began a course of sedulous and systematic study, which he kept up during his whole life. In 1816 he entered the itinerant ministry of the Methodist Episcopal Church, and his successive appointments, as stated in the Minutes, were as follows: 1816, St. Lawrence, Lower Canada District; 1817, Paris, New York; 818, Watertown; 1819, Scipio; 1820, superannuated; 821-22, Watertown; 1823, Homer; 1824, Auburn; 825-26, Rochester; 1827-28, Cazenovia; 1829-32, Caruga District, Oneida Conference; 1833-35, Black River District; 1836-41, Missionary to Buenos Ayres; 1842, Vestry Street, New York; 1843-44, Mulberry Street; 1845-54, professor in Biblical Institute, Newbury, Vt., and Concord, N. H.; 1855-63, professor in Garrett Biblical Institute, Evanston, Ill. "His fields of labor were extremely diverse, and yet he occupied every one of them with marked success. From the borders of Canada on the north, to St. Augustine, Fla., on the south, whither he went in 1835, primarily in search of health, and thence to Buenos Ayres, in South

America; from New England on the east to Illinois on the west, his name has, during the last half century, been familiar to the good, and associated with active labors for the promotion of the cause of Christ." By incessant labor he made up largely the deficiencies in his early education, acquiring the Latin, Greek, and Hebrew languages, and a fair amount of general culture. His mind, naturally metaphysical, turned especially to questions of philosophical theology, such as the divine nature and government, the will, etc. and on these topics he both spoke and wrote with great success. But the great work of his life was the organization of theological seminaries in the Methodist Episcopal Church. After eighteen years of labor, he saw two of these (Concord and Evanston) in full operation, largely as the fruit of his own industry, energy, and perseverance. He died Nov. 28, 1863, at Chicago. As a preacher he was at once simple, stirring, and profound. He seized with a master hand upon the great cardinal truths of revelation and providence, and wielded them with equal application to the judgment and the conscience. He left many MSS., especially a work on the will; but, thus far, all that has been published in permanent form is his *Lectures and Addresses* (Cincinnati, 1864, 12mo). See *Appendix to his Lectures; Minutes of Conferences*, 1864, p. 148; *Methodist Quarterly Review*, July, 1864; Stevens, *History of the Methodist Episcopal Church*, vol. iii.

Dempster, Thomas, a Scotchman of much miscellaneous erudition, was born at Muireisk, Aberdeenshire, about the year 1579. He studied at Cambridge, went to Paris, and obtained a temporary professorship in the College of Beauvais, where he manifested a very quarrelsome temper. He was afterwards professor at Pisa and Bologna, near which city he died, Sept. 6, 1625. Among his writings is a *Historia Ecclesiastica Gentis Scotorum*, "a work in which his desire to magnify the merits of his country often induced him to forge the names of persons and books that never existed, and to unscrupulously claim as Scotchmen writers whose birth-place was doubtful."—*New Gen. Dictionary*, iv, 369.

Den, the rendering in the Auth. Vers. of the following Heb. and Greek words: **מַעְרָה**, *me'arah* (Isa. xxxii, 14; Jer. vii, 11), a *cave* (as elsewhere rendered); **מַחְרָה**, *ma'harah*, a *hole* (as of a venomous reptile, Isa. xi, 8); **סֹךְ**, *sok*, a *booth* or *thicket* ("pavilion," Psa. xxvii, 5; "tabernacle," Psa. lxxvi, 2), hence a "covert" (Jer. xxv, 38) or *lair* of a wild animal (Psa. x, 9); **מַעוֹן**, *ma'on* (Jer. ix, 11; x, 22), or **מַעוֹנָה**, *me'onah* (Job xxxviii, 40; Psa. civ, 22; Cant. iv, 8; Amos iii, 4; Nah. ii, 12), properly a dwelling-place or habitation (as elsewhere rendered); **מִןחַרָה**, *min'harah*, a *fissure* in the rocks, used for hiding (Judg. vi, 2); **אָרֶב**, *'areb*, an *ambush* ("lie in wait," Job xxxviii, 40), hence *lair* of a beast of prey (Job xxxvii, 8); **σπήλαιον**, a *cave* (as rendered John xi, 38), hence a *recess* for secrecy (Heb. xi, 38; Rev. vi, 16), or a *resort* of thieves (Matt. xxi, 13; Mark xi, 17; Luke xi, 38). See **CAVE**.



Antique Figure of a Man in a Den of Lions.

In Dan. vi, the "den (Chald. דִּנָּר, *gōb*, a *pl*; Sept. *λάκος*; Vulg. *lucus*) of lions" is repeatedly named as a peculiar means of punishment for state offenders at Babylon. This usage, although not mentioned by any other ancient authority, has received remarkable confirmation (see "*Truths of Revelation demonstrated by an Appeal to Monuments*," etc., "by a Fellow of seven learned Societies," Lond. 1831) from certain remains discovered in that region by modern travellers (Kitto, *Pict. Bible*, note on Dan. vi, 16), especially one on a block of white marble found near the tomb of Daniel at Susa, and thus described by Sir R. K. Porter in his *Travels in Persia* (ii, 416): "It does not exceed ten inches in width and depth, measures twenty in length, and is hollow within, as if to receive some deposit. Three of its sides are cut in bas-relief, two of them with similar representations of a man apparently naked, except a sash round his waist and a sort of cap on his head. His hands are bound behind him. The corner of the stone forms the neck of the figure, so that its head forms one of its ends. Two lions in sitting posture appear on either side at the top, each having a paw on the head of the man." See LION.

Denarius (δηνάριον), the principal silver coin of the Romans, which took its name from having been originally equal to ten times the "as" (Pliny, xxxiii, 12), which was the unit. See FARTHING. It was in later times (after B.C. 217) current also among the Jews, and is the coin which is called "a PENNY" (q. v.) in the Auth. Vers. The denarii were first coined in B.C. 269, or four years after the first Punic War, and the more ancient specimens are much heavier than those of later date (Böckh, *Metrol. Unters.* p. 299, 469). Those coined in the early period of the commonwealth have the average weight of 60 grains, and those coined under the empire of 52.5 grains. With some allowance for alloy, the former would be worth 8.6245 pence, or 17 cents, and the latter 7.5 pence, or 15 cents. It has been supposed, however, that the reduction of weight did not take place till the time of Nero; and, in that case, the denarii mentioned in the Gospels must have been of the former weight and value, although the equivalent of the Greek δραχμή (Pliny, xxi, 109), or about 15 cents, is the usual computation (see Wurm, *De ponder. mensura*, p. 54). A denarius was the day-wages of a laborer in Palestine (Matt. xx, 2, 9, 13; Tobit v, 15); and the daily pay of a Roman soldier was less (Tacitus, *Ann.* i, 17). In the time of Christ the denarius bore the image of the emperor (Matt. xxii, 19; Mark xii, 16), but formerly it was impressed with the symbols of the republic. — Kitto, s. v.

The name of this coin occurs in the Talmud, in the form דִּנָּר (see Lightfoot, at Matt. xx, 2). Pliny speaks of a *golden denarius* (*Hist. Nat.* xxxiii, 13; xxxiv, 17; xxxvii, 3; so also the Mishna, *Kiddush.* ii, 2, etc.), which was of the average weight of 120 grains, and was current for 25 of the silver coin. In later times a copper coin called denarius. It has



Roman Denarii of the time of the Republic, now in the Brit. Museum (actual size; weight of the first, 60.6 grains; of the second, 58.5).

even its representative in the modern Oriental See Greave, *Roman Foot and Denarius* (Lond. 1857). Raasche, *Lex. Rei Numariae*, II, i, 138; Pinkerton, *Ess. on Medals*, i; Akerman, *Catalogue of Rom. Coins* (Lond. 1834), i, 15-19; and the essays *De denario aeneo* by Christiern (Upsal. 1732) and Mayer (Gryph. 1762). See MONEY.

Denck. See DENK.

Denderah (Gr. *Tentyra*; Coptic *Tentyra*, probably from *Tēn-Athor*, the abode of Athor), a town of Upper Egypt, situated near the left bank of the Nile, in lat. 26° 13' N., long. 32° 40' E. It is celebrated on account of its temple, dating from the period of Cleopatra and the earlier Roman emperors, and one of the finest and best preserved structures of the kind in Egypt. The principal temple measures 220 feet in length by about 50 in breadth, and has a noble portico supported on 24 columns. The walls, columns, etc., are covered with figures and hieroglyphics. Prominent among the former is that of Athor or Aphrodite, to whom the temple was dedicated. On the ceiling of the portico are numerous theological figures arranged in zodiacal fashion, with



"Zodiac" of Denderah.



Northern Gate and principal Temple of Denderah.

re been regarded as a representation of the zodiac; certain peculiarities have led some recent archaeological travellers to doubt whether the figures were intended to have any reference to astronomy. There are many other sacred buildings at Denderah, including a temple of Isis. The whole, with the exception of one propylon, are surrounded by a sun-dried brick-wall, 1000 feet long on one side, and in some parts 35 ft high.—Chambers, *Encyclopaedia*, s. v.

Denial. See SELF-DENIAL.

DENIAL OF CHRIST (Luke xii, 9). See PETER.

Denis, the French name for Dionysius (q. v.).

Denis or **Denys**, St., 1. the so-called apostle of France and first bishop of Paris, is said to have been sent from Rome about 250 A.D. to preach the Gospel to the Gauls. After delays from persecutions brought on him by his zeal at Arles and other places, he arrived in Paris, where he made many proselytes. Pescennius or Sicinnius Lescennius, who was then the Roman governor of this part of Gaul, ordered Denis to be brought before him, along with other two Christians, Justicus, a priest, and Eleutherius, a deacon. Finding them firm in their faith in spite of torture, Pescennius caused them to be beheaded, A.D. 272, or, as others say, A.D. 290. Gregory of Tours, Fortunatus, and the Latin martyrologists state that the bodies of the three martyrs were thrown into the Seine, but were recovered by a pious woman, and buried near the place where they lost their lives. Their supposed relics, in silver caskets, were afterwards taken to the abbey of St. Denis (see below). The *Acta* of St. Denis, written about the end of the 7th or beginning of the 8th century, is founded upon popular traditions, and the best historians of France hold that nothing can be certainly known of either the time or the place of the martyrdom, or of the genuineness of the relics of St. Denis. St. Denis was for a long time confounded with Dionysius the Areopagite (q. v.). He is honored as a saint in the Roman Church on the 9th of October. His name was the war-cry of the French soldiers, who were charged to the cry *Montjoie St. Denis*.—Hofer, *Nov. Biog. Générale*, xiii, 674. See DIONYSIUS THE AREOPAGITE.

2. The ABBEY OF ST. DENIS, near Paris, named from the tradition that Dionysius the Areopagite was buried there. The abbey was founded by Dagobert I, king of France, A.D. 613. The vaults of the church of St. Geneviève, connected with the abbey, contained (before the French Revolution) the bodies of 25 kings, 10 queens, 84 princes and princesses, and those of Bertrand du Guesclin and Turenne. In 1793 a mob, headed by the Jacobins, destroyed the abbey and carried the contents of the vaults to the nearest cemetery. The abbey was restored in 1806, and after the Restoration Louis XVIII caused such of the remains as could be found to be restored. There is still at the abbey of St. Denis a chapter of St. Dionysius Areopagite, composed of the grand almoner (primicier), 10 canons of the first class (archbishops and bishops aged over 60), and 24 canons of the second class.—Pierer, *Universal-Lexikon*, s. v.

Denis, MICHAEL, a German Jesuit, was born at Schärding, on the Inn, Sept. 27, 1729. He entered the order of the Jesuits in 1747, and was ordained priest in 1756. In 1759 he was appointed professor at the Collegium Theresianum at Vienna, and in 1778 librarian of the library of Garelli. After the suppression of the Collegium Theresianum in 1784, the emperor Joseph II appointed him second "custos" and aulic councillor. He died Sept. 29, 1800. Denis was in friendly relations with Klopstock and other prominent scholars of Protestant Germany, and was esteemed for his amiable character and for his efforts in behalf of German literature. He became especially known by his attempt to imitate the poetry of the ancient bards; but his poems were more admired for their noble sentiments than their poetical value. He also wrote several bibliographical works, and a Latin elegy on the downfall of his order (*Fatum Jesuitarum*). A posthumous autobiography of Denis was published, together with other posthumous writings, by Retzer (*Literarischer Nachlass*, Vienna, 1801-1802).—*Allgem. Real-Encyclop.* iv, 285.

Denk, JOHANN, an Anabaptist of the 16th century. Nothing is known of his early years. In 1521 he was in Basle, and in 1523 at Nürnberg, as rector of the school of St. Sebaldus. He rejected infant baptism, and promulgated anti-trinitarian ideas. He was brought before the council of Nürnberg, and, being unable to defend himself, was expelled from the city for life. We next find him in Augsburg in the year 1525, where he wrote and edited his book *vom Geseetze Gottes*. In 1526 he came to Strasburg, where he seems first to have become acquainted with Louis Hetzer (q. v.). Their connection resulted in the publication of an edition of the Old Testament prophets. It was published in 1527 at Worms, and Luther speaks favorably of the translation as such. Denk's theological errors soon became known, and he was cited to a public disputation by the clergy of Strasburg. Bucer was his principal opponent, and based his charge, that Denk's teaching made sin a mere empty sound, upon the book *vom Geseetze Gottes*. Denk was defeated and driven from the city. After a few months spent in travelling, during which he ventured to revisit Nürnberg, he went to Basle, where he died of the plague in November, 1527. In his doctrines he was Anabaptist and anti-trinitarian; and the following dogmas were peculiar to him. He taught an internal word which, as the power of the Highest, produces knowledge and love in man; that salvation is not connected with the Holy Scriptures; the law, under which he comprehends the entire Scriptures, is opposed to the spirit; the sacraments are of a subordinate and superfluous character to believers; the wicked are finally to be saved, etc. Ranke (*Reformation*, iii, 559, cited by Hardwick, *Ch. Hist.* ii, ch. v) gives the following statement of Denk's views: "The basis of his doctrine is, that God is love, which, he said, flesh and blood could never have understood had it not been embodied in certain human beings, who might be called divine men, or the children of God. But in one of them love was supremely exemplified—in Jesus of Nazareth. He had never stumbled in the path marked out by God; he had never lost his unity with God; he was a Saviour of his people, for he was the forerunner of all those who should be saved. This was the meaning of the words that all should be saved by Christ." His followers were called *Demoniaci*, because they named seven evil spirits to their candidates for baptism, which they were supposed to possess, and which must be given up, while seven good spirits were to be received in their stead.—Herzog, *Real-Encyclopädie*, xix, 403; Trechsel, *Protest. Antitrinitarier*, i, 17 sq.; *Theol. Stud. u. Kritiken*, 1851, p. 121, 412.

Denmark, a kingdom in Europe, with an area of 14,553 square miles, and in 1860 (according to the cen-

sus) 1,608,095 inhabitants in Denmark proper, and 124,020 in its dependencies.

I. *Church History.*—Willebrord is said to have been the first Christian missionary in Denmark (8th century), but he was not able to establish any permanent mission. Charlemagne extended the territory of Christianity to the frontier of Denmark, and his son, the emperor Louis, sent archbishop Eddo of Rheims as his ambassador to king Harold Klak, who had requested his aid. Eddo established a missionary school in Holstein. King Harold, who had been deprived of his throne, was baptized in 826, with his family and many of his countrymen, and soon after Ansgar (q. v.) was placed at the head of the Danish mission. Through his labors Christianity got a firm footing, but had still to struggle for about 150 years with paganism, until Canute the Great (1019-35), completed the Christianization of the entire country. The last stronghold of paganism, the island of Bornholm, was converted about 1060. The bishoprics which were estab-

lished in Denmark were subordinate to the archbishop of Bremen until the 11th century, when a new and episcopal see was established for the north of the Baltic. The first bishops appointed in Denmark were Englishmen, and English influence prevailed until the 12th century, when Denmark allied herself more closely with France. In the following century French influence was supplanted by German. Convents were numerous, but the enforcing of celibacy cost the people more trouble in Denmark than in any other country. Until the 12th century the clergymen were generally married. In 1222 a papal legate came to Denmark to carry through the introduction of celibacy. Some hundred priests then appealed from the pope to a general council, but a national synod aided the legate in accomplishing his purpose. On the whole, Denmark was but little affected by the great ecclesiastical movements of the Middle Ages. The Inquisition was almost unknown. Protestant ministers were introduced into Denmark as early as 1520, but the bishops, who

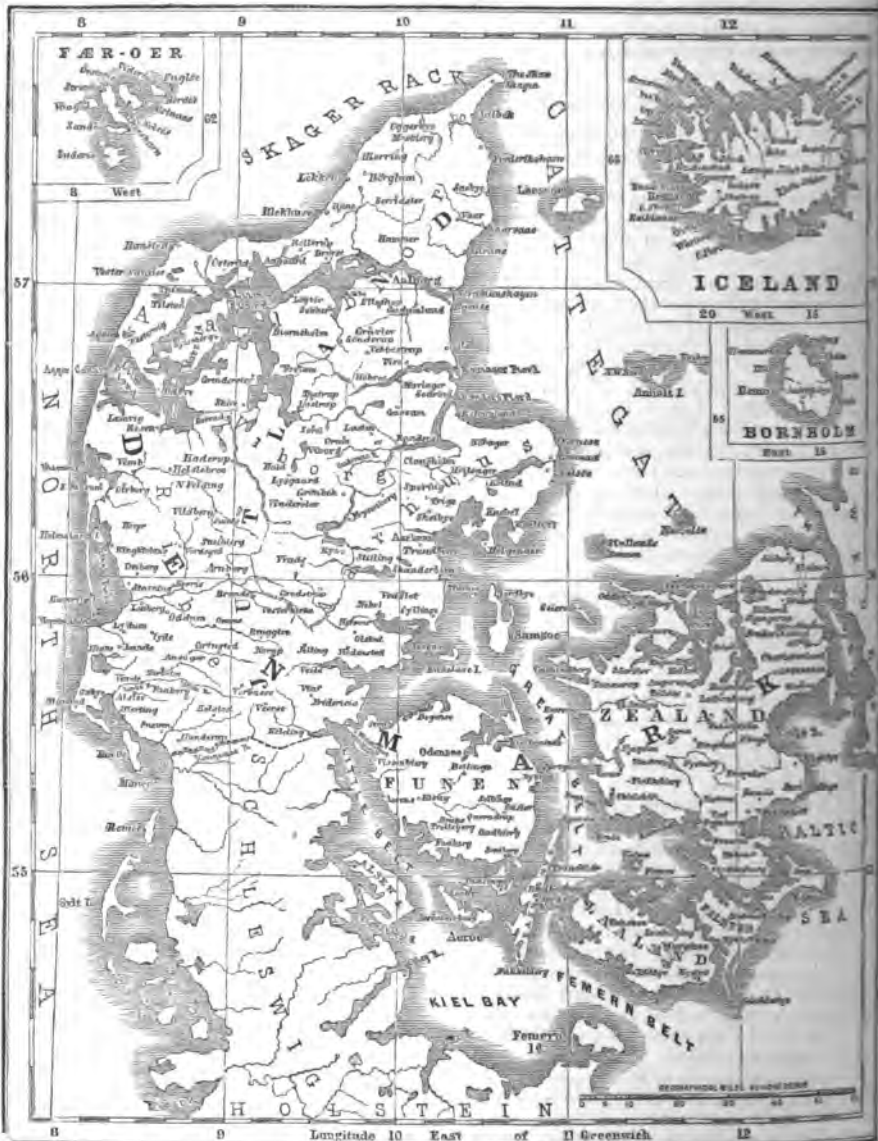

Map of Denmark.

wealth made almost independent of the king, opposed the Reformation. King Frederick I declared himself in 1526 in favor of Protestantism, yet the Diet lensee, in 1527, only gave to the Lutherans equal rights with the Roman Catholics. The Lutheran Church obtained a complete victory under Christian IV who in 1536 deposed the hostile bishops, and called Copenhagen (q. v.) to Denmark to reorganize the Danish Church on an evangelical basis. Not long after, the whole country joined the Lutheran Church, and for more than a hundred years the exercise of any other religion was forbidden. The Danish Church did not produce any symbolical books of its own, but adopted the Confession of Augsburg of 1530, and the smaller schism of Luther, which, with the three confessions of faith of the ancient Church, are regarded as symbolical books of the Danish Church. The subsequent development of the Danish Church was a reaction of that of Germany, including also the Rationalism of the 18th century. Yet in that very century Denmark was a model for all Europe by its zeal for foreign missions. See EGEBE. A powerful reaction against the predominance of Rationalism commenced in 1656, under Dr. Grundtvig and Dr. Rudelbach. Some years after Grundtvig became the leader of a Low-Church evangelical party, and Rudelbach of the High-Church Lutheran party. The strife between these two parties still divides the Church. The party headed Grundtvig inclines towards Congregational principles, and has intimated that they may be induced to separate altogether from a connection with the state. Only a very limited toleration was granted to members of dissenting denominations in Denmark until 1818. In a few cities only (Copenhagen, Fridericia, Aalborg, Gluckstadt, Altona) equal rights were granted to dissenters; but all restrictive laws were repealed in 1848 for Denmark proper, and the number of dissenters has since considerably increased. In 1859, Denmark was visited for the first time since the 15th century by a Roman bishop, who met, on the part of the king, with a friendly reception. According to the new Constitution of 1866, the Lutheran Church is the state church, and the king must belong to it; but otherwise there is an absolute liberty for all religious sects.

II. Constitution.—The first constitution of the Protestant Church of Denmark was drawn up by a committee, then revised by Luther and the other theologians of Wittenberg, and published, with some additions by the king, in 1537. The code of 1688 made the king the supreme head of the Church, with almost absolute powers. The king exercises ecclesiastical jurisdiction through the bishops, all of whom are equal in rank, though the bishop of Zealand is considered *primus inter pares*, as he has the most extensive diocese and the prerogative of crowning the king. Every bishop has under him several provosts, who have each the superintendence of a district, which they visit once a year. They are elected by the pastors of the district, and confirmed by the bishop. The pastors have the right to engage chaplains. A great change in the ecclesiastical constitution of Denmark took place in 1848, in consequence of the political revolution of that year. Full religious liberty was granted to all denominations, and the right of self-government was promised to the Established Church. The diets of Denmark have ever since been occupied with the discussion of various drafts of a new Church Constitution, but so great is the divergence of religious parties, that as yet (1868) the reconstruction of the Church on the basis of self-government has not been accomplished. The principle of religious liberty, in the mean while, has worked so beneficially that the clergy and laity of all parties are almost unanimously in favor of maintaining it. When, in 1866, the ministry solicited the opinions of the diocesan synods concerning the abrogation of compulsory baptism, they generally advocated it.

III. Worship.—The first liturgy (altar-book) of the Danish Church was elaborated in 1555 by bishop Paladius. By order of king Christian V, a ritual, regulating the entire divine service, was issued in 1686, and soon after, in connection with a new edition of the altar-book, was prescribed for general use. Towards the close of the 18th century, a new liturgy, entirely pervaded by rationalistic views, was drawn up, but its introduction, notwithstanding the prevalence of Rationalism among the clergy, was regarded as dangerous. Yet the ecclesiastical authorities connived at any deviation from the formularies which individual clergymen saw fit to make. A new draft of a liturgy was published in 1839 by bishop Mynster, but general uniformity in external worship has never been restored. A considerable party among the clergy is against the principle of binding the whole Church to one liturgy, and in favor of extensive liberties of individual congregations. In the duchy of Sleswick a rationalistic liturgy was drawn up in 1797 by the superintendent general Adler, and at first generally introduced, yet soon its use was left to the option of the congregations. In Holstein, liturgies which strictly adhere to the Lutheran theology have always been, and are still in use.

IV. Statistics.—(1.) The Lutheran Church, or, as it is now (since 1849) officially called, the People's Church, has 9 bishops, viz. 4 for the islands, 4 for Jutland, and 1 for Iceland. Every bishopric is divided into a number of provostries. The number of provosts amounts to 160 for Denmark and 19 for Iceland. A theological faculty is connected with the University of Copenhagen. Among the periodicals, we mention the *Danish Church Gazette*, the organ of the (Low-Church) party of Grundtvig. A Danish missionary society was established at Copenhagen in 1821, and sustains a mission in India. (2.) Other denominations. According to the census of Feb. 1, 1860, there were in that year in Denmark proper 12,907 souls not belonging to the state church in a total population of 1,608,095, viz.: Jews, 4214; Mormons, 2657; Baptists, 2270; Reformed, 1761; Roman Catholics, 1240; Anglicans, 114; 202 members of the Apostolical Church; 162 of the Free Lutheran Church; and the remainder, in small numbers, is divided among several other sects. The Baptists had in all Denmark in 1866, 16 churches and 1726 members. The Reformed Church has, according to an article of one of the Danish bishops in Herzog's *Real-Encyclop.* only 1600 souls (900 in Denmark proper). The Methodist Episcopal Church has a flourishing mission in Copenhagen, under the charge of pastor Willerup, whose labors there (since 1858) have been very successful. An elegant Methodist Episcopal Church has just been erected in that city, and has a large congregation; in 1866 it had seventy-three members, and had appointments in four other towns; the Methodist Sunday-school had two hundred children, and the publication of a weekly Sunday-school paper had been commenced. The Roman Catholics have two periodicals (the *Scandinavian Church Gazette* and a political paper) and an establishment of the Sisters of Charity at Copenhagen. There were in 1859 seven congregations of Lutheran seceders, with one periodical (Oersund).—Herzog, *Real-Encyclopädie*, iii, 580 (art. by the Danish bishop, Dr. Engelstoft). See Pontoppidan, *Annales ecclesie Dan. diplom.* (Copenh. 1741); Munter, *Kirchengeschichte von Dänemark und Norwegen* (Leips. 1823); Wiggers, *Kirchliche Statistik*, ii, 375 sq.; Schem, *Eccles. Year-book for 1859*, p. 132 and 211, and *Ecclesiastical Almanac for 1868*.

Denominations, The Three, the designation of an association of dissenting ministers residing in London, or the immediate neighborhood, belonging to the Presbyterian, Independent, and Baptist denominations. It is usually known as *The General Body of Protestant Dissenting Ministers of London and Westminster*.

ster. At first its proceedings included loyal addresses to the throne. Dr. Calamy preached in 1781 the first sermon to ministers in Dr. Williams's library, in Redcross Street; and this *concio ad clerum* continued for several years. "Every congregation of Protestant dissenters, Presbyterians, Independents, and Baptists, in and within twelve miles of London, appoints two deputies. Since 1787 the election has regularly taken place, and the committee have unremittingly watched over bills brought into Parliament in any way affecting dissenters, kept alive an interest in behalf of the repeal of the Test and Corporation acts, supported every measure which promised to be beneficial in extending and consolidating religious liberty, and successfully exerted themselves in protecting individual ministers and congregations against those molestations to which they have been exposed on the part of bigoted and persecuting churchmen."—Buck, *Theol. Dict.* s. v.

Dens, PETER, a Roman Catholic theologian, was born in 1690 at Boom, in Belgium. "Apparently nothing is known—at least by Protestant writers—regarding the incidents of his life, as his name appears in no encyclopædia or biographical work that we are acquainted with. The scanty information we possess is derived from the epitaph inscribed on his tomb in the chapel of the archiepiscopal college of Malines by the present (1857) rector. From this epitaph it appears that he was reader in theology at Malines for twelve years, *plebanus* or parish parish of St. Rumold's or Rumbold's Church in the same city, and president of the College of Malines for forty years. He also held various honorary church offices. He was canon and penitentiary, synodical examiner and scholastic archpriest of St. Rumold's—the metropolitan church of Belgium. He died February 15, 1775, in the 85th year of his age. The work which has rendered Dens's name familiar, even to the Protestant public, is his *Theologia Moralis et Dogmatica* (new ed. Dublin, 1832, 8 vols. 12mo). It is a systematic exposition and defence—in the form of a catechism—of every point of ethics and doctrine maintained by Roman Catholics, and is extensively adopted as the text-book of theology in their colleges. It appears to owe its popularity more to its being a handy compilation than to any great talent exhibited by its author" (Chambers, *Encyclopædia*, s. v.). A synopsis of the work by Dr. J. F. Berg, with copious notes illustrating the dangerous tendency of the Romanist moral theology, was published in 1840 (Philadelphia), and passed through repeated editions.

Deodatus, POPE. See DEUSDEBIT.

Deontology (*τὸ δέον*, what is due or binding; and *λόγος*, discourse). We take the following citations on the use of this word from Fleming, *Vocabulary of Philosophy* (Phila. 1860), s. v.: "Deontology, or that which is proper, has been chosen as a fitter term than any other which could be found to represent, in the field of morals, the principle of utilitarianism, or that which is useful" (Bentham, *Deontology, or the Science of Morals*). On the other hand, Whewell (*Preface to Mackintosh's Prelim. Dissert.* p. 20) says that "the term deontology expresses moral science, and expresses it well, precisely because it signifies the science of duty, and contains no reference to utility." Deontology involves the being bound or being under obligation, the very idea which utility does not give. "The ancient Pythagoreans defined virtue to be 'ἔτις τοῦ δέοντος' (that is, the habit of duty, or of doing what is binding), the oldest definition of virtue of which we have any account, and one of the most unexceptionable which is yet to be found in any system of philosophy" (Stewart, *Active and Moral Powers*, ii, 446). Sir W. Hamilton observes that ethics are "well denominated deontology" (Reid's *Works*, p. 540, note).

Dependence, FEELING OF, the essence of relig-

ion, according to Schleiermacher. See SCHLEIERMACHER.

Deposit (פיקדון, *pikkadon'*, something placed in trust; "store," Gen. xli, 86; "delivered," Lev. xli, 86; Sept. *παράθηξεν* [so in 2 Tim. 1, 12], or *παράθεσεν* [see Grinfield, *N. T. Hellenisticum*, p. 1146]; *Vid. depositum*). The arrangement by which one man deposits at another's request the property of the latter and demands back (Exod. xxii, 7), was one common to all the nations of antiquity (Sir W. Jones, *Law of the Nations*, in his *Works*, viii, 448); and the dishonest dealing with such trusts is marked by profane writers as extreme reprobation (Herod. vi, 86; Juvenal, *Sat.* i, 10; etc.; Joseph. *Ant.* iv, 8, 38; *War.* iv, 8, 5, 7, 1, 2, 3, 4, 5, 6, 7, 8, 9, 10, 11, 12, 13, 14, 15, 16, 17, 18, 19, 20, 21, 22, 23, 24, 25, 26, 27, 28, 29, 30, 31, 32, 33, 34, 35, 36, 37, 38, 39, 40, 41, 42, 43, 44, 45, 46, 47, 48, 49, 50, 51, 52, 53, 54, 55, 56, 57, 58, 59, 60, 61, 62, 63, 64, 65, 66, 67, 68, 69, 70, 71, 72, 73, 74, 75, 76, 77, 78, 79, 80, 81, 82, 83, 84, 85, 86, 87, 88, 89, 90, 91, 92, 93, 94, 95, 96, 97, 98, 99, 100). which is likewise taken by Clemens Alex. (*Strom.* i, 749), Chrysostom (*Orat.* lxiv, p. 640), and others (see Rawlinson, *Herod.* iv, 477, note). Even our Saviour seems (Luke xvi, 12) to allude to conduct in such cases as a test of honesty. In later times, when no banking system was as yet devised, shrines were often used for the custody of treasure (2 Macc. iii, 10, 12, 15; *Joseph. Antab.* v, 8, 7; Cicero, *Legg.* ii, 16; Plutarch, *Life of Alcibiades*, 18). Among an agricultural people, the exigencies of war and other causes of absence must often have rendered a temporary deposit, especially as regards animals, an owner's only course of safety. See TERTIUS NORWICH. Nor was the custody of such property burdensome, for the use of it was no doubt, so far as that was concerned with its unimpaired restoration, allowed to be depositary, which office also no one was compelled to accept. The articles specified by the Mosaic law as (1) "money or stuff;" and (2) "an ass, or an ox, or a sheep, or any beast." The first case was rendered only liable to loss by theft (probably for loss by accidental fire, etc. no compensation could be claimed), and the thief, if found, was to pay double, i. e., probably to compensate the owner's loss, and the unjust sequestration thrown on the depositary (comp. Götsche, *Lehrb. üb. Civilrecht*, II, ii, 315). If no theft could be proved, the depositary was to swear before the judges that he had not appropriated the article, and then to quit (comp. Schweppe, *Röm. Privatrecht*, p. 353). In the second, if the beast were to "die, or be hurt, or driven away, no man seeing it"—accidents to which beasts at pasture were easily liable (comp. *Chron.* v, 21)—the depositary was to purge himself by a similar oath. (Such oaths are probably alluded to in Heb. vi, 16, as "an end of all strife"). In case, however, the animal were stolen, the depositary was liable to restitution, which probably was necessary to prevent collusive theft (Kalisch, *Exod.* p. 419). See DAMAGES. If it were torn by a wild beast, some proof was easily producible, and, in that case, no restitution was due (Exod. xxii, 7-13). The Jewish commentators make various distinctions on this enactment (see Eisenmüller, in loc.). In case of a false oath so taken by the perjured person, besides making restitution, was to "add the fifth part more thereto," to compensate the one injured, and to "bring a ram for a trespass-offering unto the Lord" (Lev. vi, 5, 6). In the book of Tobit (v, 3) a written acknowledgment of a deposit is mentioned (i, 14 [17]; iv, 20 [21]). This, however, merely facilitated the proof of the fact of the original deposit, leaving the law untouched. The Mishna (*Baba Mezia*, c. iii; *Shevuoth*, v. 1) shows that the law of the oath of purgation in such cases continued in force among the later Jews (Michaelis, *Mos. Recht*, ch. 162). See Smith's *Dict. of Class. Antiq.* s. v. DEPOSITUM. The Roman law of deposit is stated in Justinian's *Institutes*, iii, tit. xiv, 3; comp. *iv*, tit. vi, li. 23 (See Sandars, p. 429, 540, 543; Vinnius, p. 813, 814). A deposit, in Athenian law, was likewise called *ροπή* (*κατάθηξιν*) (Demosthenes, *pro Phorm. Orator.* Bekker, Oxon. vi, 1042). Comp. the *λόγος τῆς ῥοπῆς* (*λόγος* of Isocrates (*Or. Attici*, Bekker, Oxon. ii, 515-550). —Smith, s. v.; Kitto, s. v. Comp. PLEDGE.

osition (1.), in the ecclesiastical law of the an Church, is the depriving a priest of the privy, and forbidding him to perform the duties of his ion, but not depriving him of orders. According e ancient discipline, the deposed person lost not his office and benefice forever, but he also forfeit privileges of his rank, and was reduced into the .

But since the 12th century, this extended meaning of the term has been expressed by the word *degrava* (q. v.); at a later date, distinction was also made eeen verbal and the more solemn degradation. The r only was accompanied by the loss of the privileges erical rank. In *deposition*, a hope for future reiment might be held out, or otherwise. In the er case it was termed *privation*. In the *depositio etua*, a simple judgment of the competent authorieprives the guilty party forever of his privileges, jurisdiction, and his benefice, but he is still regardas belonging to the clergy. The crimes which e punished in this manner are murder, perjury, in-, adultery, etc. *Deposition*, being an act of jurion, can be inflicted by any diocesan bishop who been confirmed by the Pope, even though he be not secrated. At the present day deposition cannot be icted, so far as the civil rights of parties are coned, without the consent of the secular authorities. *Netzer u. Welte, Kirchen-Lexikon*, iii, 107.

2.) In the Church of England, by Canon 122, sence against a minister, of deposition from the minis-, shall be pronounced by the bishop only, with the istance of his chancellor and dean (if they may conveniently be had), and some of the prebendaries, if the urt be kept near the cathedral church; or of the hdeacon, if he may be had conveniently, and two er at least grave ministers and preachers to be call by the bishop, when the court is kept in other places. (3.) In Scotland, "the minister of a parish who has en guilty either of immoral and scandalous conduct, of preaching or otherwise publishing doctrines conry to the standards of the church to which he has clared his adherence, or of contumaciously setting ide the authority of the Presbyterian church-courts, ay be deposed from his holy office by the church-urts. By this means he is deprived not only of his eclesiastical dignity, but of the temporalities of his enefice (stat. 1592, c. 115), and the benefice becomes acant just as if he were dead. He may, however, be stored to the exercise of the ministry, and to his position as a minister of the Church, by the General Assmly, but he cannot, of course, be restored to his enefice; and it is considered irregular that he should e so even by a new presentation by the patron, because the stigma attached to his character by his deposition is likely to affect his usefulness. Where sentence of deposition is pronounced by an inferior church-court, the judgment of which is reversed on appeal to he General Assembly, it is held that it had never een pronounced; but if the sentence be affirmed, it akes effect from the date when it was pronounced by he inferior court, and from that date the minister's ight to the profits of his benefice ceases. Sentence of deposition cannot be pronounced by a presbytery in he absence of the minister, except by the authority of the General Assembly" (Chambers, *Encyclopaedia*, i, v.).

(4.) The grounds of deposition in the Protestant Episcopal Church are stated in the 87th Canon of the Convention of 1882; and Canon 89 provides that, "1. When any minister is degraded from the holy ministry, he is degraded therefrom entirely, and not from a higher to a lower order of the same. Deposition, displacing, and all like expressions, are the same as degradation. No degraded minister shall be restored to the ministry. 2. Whenever a clergyman shall be degraded, the bishop who pronounces sentence shall, without delay, give notice thereof to every minister and vestry in the diocese, and also to all the bishops

of this Church, and where there is no bishop, to the standing committee." See DISCIPLINE.

Depravity (Lat. *pravus*), the moral crookedness and corruption of man's nature. The Scriptures describe moral goodness and obedience as the pursuing of a straight or right line (hence the word "rectitude"). Depravity is the turning aside out of that straight line. "It is the fault and corruption of the nature of every man that naturally is engendered of the offspring of Adam, whereby man is very far gone (*quam longissimè*, as far as possible to be *within reach of a recovery*) from original righteousness," etc. (ixth Art. of Rel. of Church of England; viith of the M. E. Church). On the nature and extent of depravity, see SIN, ORIGINAL.

Deprivation, the act of taking away from an ecclesiastic any benefice or other spiritual preferment which he may hold (see Canon 122 *Church of England*). "In England this may be done either (1) by a sentence declaratory in the proper court, on the ground of attainer or conviction of treason, felony, or any other infamous crime, or of conviction for heresy, infidelity, or gross immorality, or for farming or trading contrary to law, 1 and 2 Vict. c. 106, s. 81; or (2) in pursuance of divers penal statutes, which declare the benefice void for some feoffance or neglect, or else some malfeasance or crime, as simony; for maintaining any doctrine in derogation of the king's supremacy, or of the Thirty-nine Articles, or the Book of Common Prayer; for neglecting to read the liturgy and articles in the church, and to declare assent to the same, within two months after induction; for using any other form of prayer than the liturgy of the Church of England; for continued neglect, after order from the bishop, followed by sequestration, to reside on the benefice. In these latter cases the benefice is void without any formal sentence of deprivation (Stephen's *Comment.* iii, 87). A bishop may be deprived of his bishopric, but cannot be deposed, the character of a bishop, like that of a priest, being indelible. The tribunal by which the bishop of Clogher was deprived in 1822 consisted of the archbishop and the other bishops of the province; and this precedent having been established, would probably be adhered to on any future occasion, notwithstanding that the archbishop alone might have full authority to deprive" (Cripps's *Laws of the Church*, p. 100).—Chambers, *Encyclopaedia*. See DEGRADATION; DEPOSITION.

Deputy stands in our version as a translation of two Heb. and one Greek term.

1. This rendering occurs in 1 Kings xii, 47, of the נָצַב, *nitatsab'* (literally *set over*), or *prefect*, apparently constituted a *sheik* by common consent of the Edomitic clans prior to royalty. See DUKE. It is also spoken of the "officers" or chiefs of the commissariat appointed by Solomon (1 Kings iv, 5, etc.) See PURVEYOR.

2. The same rendering occurs in Esther viii, 9; ix, 8, of the פֶּחָחִי, *pechuh'* (*pehhâh*), a Sanscrit term, whence the modern *pasha*, or Persian *prefect* on this side the Euphrates; applied also to the "governors" of inferior rank in the Assyrian, Babylonian, and Median empires, and even to the governor of Jerusalem. See GOVERNOR.

3. *Proconsul* (ἀνθύπατος) was the proper title of the governor of a Roman province when appointed by the senate. See PROVINCE. Several such are mentioned in the Acts, viz. Sergius Paulus in Cyprus (xiii, 7, 8, 12), Gallio in Achaia (xviii, 12), and the chief officer of Achaia, whose court is indefinitely referred to in ch. xix, 88, by the use of the plural (see Smith's *Dict. of Class. Antiq.* s. v. Proconsul). See PROCONSUL.

Der'bè (Δέρβη, Acts xiv, 20, 21; xvi, 1; adjct. Δερβαῖος, Acts xx, 4), a small town situated in the

eastern part of the great upland plain of Lycaonia, which stretches from Iconium (q. v.) eastward along the north side of the chain of Taurus (Smith's *Dict. of Class. Geogr.* s. v.). It must have been somewhere near the place where the pass called the Cilician Gates opened a way from the low plain of Cilicia to the tableland of the interior; and probably it was a stage upon the great road which passed this way. It appears that Cicero went through Derbe on his route from Cilicia to Iconium (*ad Fam.* xiii, 73). Such was Paul's route on his second missionary journey (Acts xv, 41; xvi, 1, 2), and probably also on the third (xviii, 23; xix, 1). In his first journey (xiv, 20, 21) he approached from the other side, viz. from Iconium, in consequence of persecution in that place and at Lystra (q. v.). No incidents are recorded as having happened at Derbe. In harmony with this, it is not mentioned in the enumeration of places in 2 Tim. iii, 11. "In the apostolic history Lystra and Derbe are commonly mentioned together: in the quotation from the epistle, Lystra is mentioned and not Derbe. The distinction is accurate, for St. Paul is here enumerating his persecutions" (Paley, *Horæ Paulinæ*, in loc.). It is uncertain whether Lystra or Derbe was the birthplace of Timothy; the former seems to be the more likely from Acts xvi, 1, 2. Derbe was the home of another of Paul's favored companions, Gaius (Acts xx, 4). Strabo places Derbe at the edge of Isauria (*Geogr.* xi, p. 892, ed. Casaubon; comp. Ptolemy, v, 6, 17); but in the *Synecdemus* of Hierocles (Wesseling, p. 675, where the word is $\Delta\rho\beta\alpha\iota$) it is placed, as in the Acts of the Apostles, in Lycaonia. The boundaries of these districts were not very exactly defined. The whole neighborhood, to the sea-coast of Cilicia (q. v.), was notorious for robbery and piracy. Antipater, the friend of Cicero (*ad Fam.* xiii, 73) was the bandit chieftain of Lycaonia. Amyntas, king of Galatia (successor of Delotarus II), murdered Antipater, and incorporated his dominions with his own. Under the Roman provincial government, Derbe was at first placed in a corner of Cappadocia (q. v.); but other changes were subsequently made. See GALATIA. Derbe does not seem to be mentioned in the Byzantine writers. Leake says (*Asia Minor*, p. 102) that its bishop was a suffragan of the metropolitan of Iconium. A full account of the surrounding country is given in Conybeare and Howson's *Life of St. Paul*, i, 211, 296 sq. Consult also Hamilton in the *Journal of the Geog. Society*.

Three sites have been assigned to Derbe. (1.) By Colonel Leake (*Asia Minor*, p. 101) it was supposed to be at *Bin bir-Kiliasch*, at the foot of the Karadagh, a remarkable volcanic mountain which rises from the Lycaonian plain; but this is almost certainly the site of Lystra. (2.) In Kiepert's *Map* Derbe is marked farther to the east, at a spot where there are ruins, and which is in the line of a Roman road. (3.) Hamilton (*Researches in Asia Minor*, ii, 313) and Texier (*Asie Mineure*, ii, 129, 130) are disposed to place it at *Dieli*, a little to the S.W. of the last position, and nearer to the roots of Taurus. In favor of this view there is the important fact that Steph. Byz. says that the place was sometimes called $\Delta\epsilon\lambda\beta\epsilon\iota\alpha$, which in the Lycaonian language (see Acts xiv, 11) meant a "juniper-tree." Moreover, he speaks of a $\lambda\mu\acute{\eta}\nu$ (harbor) here, which (as Leake and the French translators of Strabo suggest) ought probably to be $\lambda\acute{\iota}\mu\eta\eta$ (lake); and, if this is correct, the requisite condition is satisfied by the proximity of the Lake *Ak Göh*. Wieseler (*Chronol. der apost. Zeitalter*, p. 24) takes the same view, though he makes too much of the possibility that Paul, on his second journey, travelled by a minor pass to the W. of the Cilician Gates. On the other hand, this location seems too far from the ancient road (compare Cellar. *Noël.* ii, 202 sq.).—Smith, s. v. See LYCAONIA.

Dercëto. See ATARGATIS.

Derek. See TALMUD.

Dereser, THADDEUS ANTON, a Roman Catholic divine, was born March 11, 1757, at Fabr, in Prussia. He studied theology at Heidelberg, where he began his academical career as lecturer. In 1780 he became professor of Oriental literature at Bamberg; in 1791, episcopal vicar and professor of theology at Strasburg; in 1796, professor at Heidelberg; in 1800, professor of dogmatic theology at Freiburg; in 1815, professor of dogmatics and interpretation at Breslau, in which post he remained until his death, June 16, 1827. Dereser was a very liberal theologian for a Romanist, and his life was not free from vicissitudes in consequence of his freedom of speech and writing. Besides some devotional books, his chief labor was a continuation of the *Bibel-Werk* of Baumgarten-Crusius, of which Dereser did the most of the O. T. (translating and exegesis), Frankfurt, 1797-1838.—*Aschbacher-Lexikon*, ii, 816.

Derham, WILLIAM, a philosopher and divine, born at Stoughton, near Worcester, in 1657; was educated at Trinity College, Oxford; in 1685, obtained the livings of Wargrave and Upminster; and, on the accession of George I, was made king's chaplain and a canon of Windsor in 1716. In 1730 he received the degree of D.D. He died in 1735. His three principal works are, *Physico-Theology*, the Boyle lectures for 1711-12 (best ed. Lond. 1798, 2 vols. 8vo.); *Theology* (London, 1719, 8vo.); and *Christo-Theology*, a demonstration of the Divine authority of the Christian religion (Lond. 1730, 8vo). Of these, the first demonstrates "the being and attributes of God from his works of creation;" the second "from a survey of the heavens."—Kippis, *Biographia Britannica*, v, 118.

Dering, EDWARD, a Puritan divine, born in Kent, was chosen fellow of Christ's College, Cambridge, in 1668. In 1671 he secured a prebend in Salisbury. He obtained high reputation both as a preacher and scholar, and used his abilities and influence to great purpose against the High-Church and Romanists. In 1673 the privy council forbade his preaching, and in 1676 he died. The substance of his writings may be found in his *Works, more at large than before printed* (Lond. 1614, 4to).—Strype, *Annals of the Hist. of Puritans*, i, 204, 230; Hook, *Eccles. Biographia*, iv, 423.

Derodon, DAVID, a Protestant French theologian and philosopher, was born at Die, in the Dauphiné, about 1600. He opposed the Cartesian philosophy, and was one of the ablest dialecticians of his time. He wrote a considerable number of works against the doctrines of the Roman Catholic Church, which had a wide circulation, and were translated into several foreign languages. Among them were *Quatre Raisons pour lesquelles on doit quitter la R. P. R.* (Paris, 1681); *De tre Raisons qui traitent de l'eucharistie, du purgatoire, du péché originel et de la prédestination* (1662); and *Le Tombeau de la Messe* (Geneva, 1654; English translation, London, 1678). The latter book was on March 6, 1668, burned by the public executioner, the author exiled, and the bookseller sentenced to a fine of 100 livres, the loss of his license, and ten years imprisonment. Derodon went to Geneva, where he died in 1664. He is also the author of several works on philosophical subjects, and against the atheists. His complete works were collected into two volumes, and published after his death (*Derodonis Opera Omnia*, Geneva, 1664 and 1669, 2 vols.); the first volume contains the philosophical, and the second the theological writings.—Hofer, *Biogr. Génér.* xiii, 716.

Deror. See SWALLOW.

De Rossi. See ROSSI, DR.

Dervishes, Mohammedan monks, corresponding in many respects to the monks of the Roman Church. These may be divided into two classes: those who belong to fraternities or societies for religious exercises

se tenets and oaths are kept so secret that the un-ated can only describe their outward appearance the ceremonies which are practiced in public; and e recluses who, without belonging to any special , profess holiness and abstinence, and wander soli- through the land. The word *derwish* is Persian, ifying *poor*, corresponding to the Arabic *fakir*, ch gives name to the same order in Arabia and ia. Oriental tradition traces the order of Hermits c. to John the Baptist, and even to Seth. Two uries before Mohammed, there existed in Arabia Meschaious (Walkers) and the Ischraichious (ntemplatives). These, under the influence of Mo- medanism, merged into Mutekelim (metaphysis- is) and Sufis, who were essentially pantheists. In second century of the Hegira (729), sheik Olivan, ufi, established the first religious order in Islam. vishism doubtless took its proximate rise in Per- 1 Sufism.

The Turkish dervishes claim caliph Ali, one of the mediate successors of Mohammed, as their founder. himself founded no order; but some of his follow- formed a society called Safashafei, men devoted a monastic life. They soon fell into excesses, ing- in the use of drugs (chiefly hashish), intoxic- ing liquors, and, in fact, anything which would mote trances, ecstasies, and hallucinations, result- ; in violent paroxysms and delirium. They formed : practice of cutting themselves, mutilating their lbs, standing for a long time in agonizing positions, l otherwise barbarously abusing their bodies. They, wever, managed to reconcile with this external and blic self-abuse an almost universal private sensual- . The members of this order were subsequently led dervishes, but at what time the word *derwish* s first used is not definitely known. There are in rky thirty-two orders of dervishes, having various mes, and differing in their worship and practice. istside of Turkey there are many more orders, called the different countries by the local names Fakirs, fis, Sufis, etc. The chiefs of the different orders e called *sheiks*, or *pirs*, who are privileged to nomi- te their successors. The dervishes mostly dwell in mmunity, and have monasteries (tekies) in vari- s places. Their rules are not very rigid. The de- cation of Mohammed, "No monachism in Islam," had come a strong religious prejudice, and this prejudice ey have never been able fully to overcome. Cel- icy is not enjoined, though encouraged, and many of em are married. These, however, are not regular embers of the monasteries, although they are required pass the night there previous to any public exhibi- on. They may withdraw from the order at any time, id are often expelled for misdemeanors.

The mendicant dervishes are mostly foreigners, or ose who have been expelled from the various orders, : impostors, who cheat and bewitch the people under e garb of dervishism. These travelling dervishes re mostly jugglers, and their skill in trickery is truly onderful. They often become wealthy in the prac- ce of their arts. Their power over the common peo- le is very great, while the better-informed are beyond heir reach.

The higher orders of dervishes have come to have an xtensive influence not only with the masses, but with he government itself. This power was acquired (1) hrough the wealth which came into their possession. arge legacies were left to them for the benefit of the oor. These legacies were applied to building up der- vishism. They soon learned also to impress the people with a strong belief in the efficacy of their prayers. These came to be purchased at high prices, and thus became a fruitful source of revenue. Their power was ncreased (2) by the popularity of the institution. In asking a stand against the dervishes, the government was virtually opposing a large majority of its own subjects. Sultan Mahmoud II attempted to break

their power. On the 10th of July, 1826, he massacred the three chiefs of the Betacki dervishes in Stamboul, razed their tekies, and drove the most of them into exile. Ten years from this time they were as power- ful as ever. The ulemas have always been their bitter enemies, and have affected to despise and ridicule them, but popular sympathy has been on their side.

In Turkey there are three principal orders, viz.:

I. The Mevlevy (Molowiyeh), or dancing dervishes, who claim as their founder Meolana-Jelaleddin-Hoomy-Muhammed, surnamed Sultan-ul-Ulema, or Sovereign of the Learned. Jelaleddin wrote a book called *Mes- nevy*—a poetical composition—much of which has be- come proverbial in the East. The chiefs of this order exercise the prerogative of nominating the sheiks of the monasteries, and of girding each newly-made sul- tan with the sword of Osman. The dervishes of this order are humble in demeanor, and keep a fast during the month of Ramadan, in addition to the weekly fast on Thursday. Candidates desiring to be admitted to the order are placed on probation a thousand and one days, and required to perform the most menial ser- vices in the kitchens of the monasteries. The worship of this order consists in chanting the poems of their founder, reciting a prayer (*fat-ha*), and performing the dance, *deor* (circle). They have also an orchestra, who sing Persian odes, and play kettle-drums, tam- bourines, and fifes for the dancers. In these dances



Dancing Dervishes.

about a dozen engage at a time, and after a few min- utes they are relieved by others, each set taking their turn three or four times during the service. The master of the dance (*simazenbashi*) watches them closely to keep them in their places. A traveller makes the following computation: "By looking at a stop-watch, I ascertained that on an average they turned sixty-four times in a minute. After spinning round for about five minutes, at a signal from the high-priest, both music and dancers suddenly stopped, but recommenced in a few seconds. The third time they kept it up for nine minutes and three quarters; my brain was swimming too, so much so that I could hardly count their evolutions. The fourth and last time they whirled for five minutes and three quarters, thus making in all 1504 turns in 23½ minutes" (Auldjo, *Journal of a Visit to Constantinople*, Lond. 1885, p. 78).

II. The Bedevy (or Bodawy), or howling dervishes, as travellers call them, have a convent at St. Dimitry, near Constantinople. Their religious exercises consist of prayers (*namoz*), chants, and vociferations of the name of God, accompanied with a rocking motion of their bodies. This motion attempts to imitate the rolling of a ship on the water, and indicates their relation to God—Allah being the ocean and they the ships. They recite the attributes of God in a loud voice, putting a terrible emphasis on the word *Allah* as often as it occurs; and this they keep up with a kind of frenzy until voice and strength are gone, when many of them, covered with perspiration and foam, fall senseless to

the floor. In the midst of their fury they cut themselves with knives and other sharp instruments; but there is method in their madness, and they seldom make deep wounds.

III. The *Rufai*, who had for their founder Seid-Ahmed-Rufai. Their exercises are much like those of the *Bedevy*. Their highest ambition seems to be to make rapid motions and loud noises. Their leader chants the *hamedy-Muhammedy*, or hymns in honor of Mohammed, while the rest join in the chorus *Ya Allah! Ya Hu!* and this chorus increases in violence until it becomes a roar. At the height of the excitement they seize red-hot irons prepared for the purpose, and hold them in their teeth until the glow disappears. They also hack their flesh with swords and knives. These wounds the sheik blows upon and anoints with his saliva, which, it is said, effects a cure in a few hours. The excited state of their bodies produces a profusion of blood from very slight wounds, and their trickery deceives the people into the belief that wonderful miracles are wrought in the healing of these wounds.

There are many orders besides these, having a greater or less importance: the *Kaderijeh*, founded by Abdel-Kader-el-Gilani, known by their white banners and turbans; the *Said-Ibrahim*, founded by Sidi-Ibrahim-el-Dahuki, whose turbans and banners are green; the *Rushenis*; the *Shemairs*; the *Jemalis*; the *Nacsh-bendies*, who are itinerating dervishes, and make pilgrimages to all parts of the Mohammedan realm. From the better orders the imans, or Mohammedan priests, are chosen, and many of them also exercise civil functions.

A special work on dervishes has been published by John P. Brown, secretary and dragoman of the legation of the United States of America at Constantinople (*The Dervishes, or Oriental Spiritualism*, Phila. 1868). According to this author, the spiritualism of the dervishes has its roots in religious conceptions prevalent in the East anterior to the rise of Islamism, and ascetic practices like those common among them have been found equally widely spread, and are traceable to a very high antiquity. None of the dervishes, he says, separate themselves from the doctrines or precepts of the Koran, the contents of which they seek rather to spiritualize. They divide, moreover, the Koran and other books of religion into three portions—the historical, the biographical, and the purely spiritual. "The historical and biographical portions of these books may even comprise errors, omissions, exaggerations, and even may have been more or less changed from time to time by copyists; while that which is purely spiritual and essential to the soul of man, commenced with his creation, has always existed unchanged, and will so continue to the end of time" (p. 106). According to their best writers, it is held that there are four creations: "1. The creation of Adam from the clay, or mud, of which the earth is composed. 2. The creation of Eve from a rib or part of Adam. 3. The creation of the human species, that is, the children of Adam, by natural propagation. 4. The creation of Jesus Christ by a special breath of God, conveyed to a virgin—Mary—by the angel Gabriel" (p. 107). And as the spirit of man is capable of communing directly with this spirit of God, a holy person will regard all ordinary pleasures and pursuits of life as indifferent objects; and the more he is destitute of worldly goods, the less will he be liable to be drawn from that contemplation of God which leads to union with the divine spirit. Hence all orders of dervishes are tacitly or openly mendicants. But degrees are well recognised in saintly attainment. Adam was a holy man whom the angels were bidden to worship; Abraham was the "friend of God," and "Jesus Christ owes his existence as a saint to the special breath of his divine Creator, but is not, nevertheless, considered as being God. He is held to be only a divine emanation of the most sublime character" (p. 109).

See Madden, *Turkish Empire* (London, 1853); Auldjo, *Journal of a Visit to Constantinople*, etc. (London, 1835); Ubicini, *Lettres sur la Turquie*; Chardin, *Journal* (Amsterdam, 1735, 4to), ii; 269-297; Paul Kræmer, *The present State of the Ottoman Empire*, etc. (London, 1668, fol.), p. 135 sq.; D'Herbelot, *Bibl. Orient.* (Paris, 1744), *Derriche* and *Fakir*; Mouradgea d'Ohsson, *Ta'rikh l'Empire Ottoman*; Rogers, in *Good Words*, Jan. 1852; Von Hammer, *Osmanisches Reich* (Wien, 1811, 8vo); Brown, *The Dervishes, or Oriental Spiritualism* (Philadelphia, 1868, 12mo).

De Sacy. See SACY, DE.

De Sales. See SALES, DE.

Des Cartes, RENE (DU PERRON)—in his Latin form Rénatus Cartesius—one of the earliest in form and the first in genius and reputation, of the great philosophers of France, was born at La Haye, in Normandy, on the 30th of March, 1596, and died at Stockholm on the 11th of February, 1650. He assumed the name of Du Perron from a small estate inherited by his mother. He divides with Bacon the glory of founding the modern philosophy of Europe, and communicated a more potent impulse than Bacon to the general philosophy of mind. These two great names, as Cousin observes, inaugurate and constitute the philosophy of the sixteenth century. They have been compared and contrasted with each other under the blinding influence of national prejudice and national rivalry, and the palm has been conceded to the one or to the other according as the critic was French or English. The profound and widely-diffused influence of Des Cartes is evinced by the names and theories of his opponents, as well as by the names and writings of those who adopted or modified his doctrines. Among the antagonists of Cartesianism within the seventeenth century may be specified Gassendi, Hobbes, Arnauld, Huet, Sir Isaac Newton, John Locke, and Samuel Clarke; among its more or less acquiescent followers may be enumerated Rohault, Clerseleur, Spinosa, Bréville, Malebranche, and Leibnitz. It is not too much to say that the whole domain of metaphysics and a large portion of physics still bear the impress of the genius and labors of Des Cartes.

Life of Des Cartes.—The constitution of Des Cartes was always feeble. To this may be ascribed his studious habits, his quick impressibility, his indistinct reverie and solitary meditation, his habitual love of seclusion, and the timidity which restrained and retarded the enunciation of his dogmas. At eight years of age he was sent to the Jesuit college of La Fleche, where he remained eight years. His keen observation and curious inquiries had led his father to distrust him, even in early childhood, as "the philosopher." His weak health occasioned the relaxation in his half of the ordinary routine of academic discipline. He was allowed to lie late in bed in the morning. During these morning vigils, which were observed through life, he meditated and revolved the whole scheme of his philosophy. Des Cartes prosecuted his college studies with diligence and success, but became dissatisfied with their supposed vanity and superficiality. His complaints on this subject, uttered a quarter of a century afterwards, are a strange anticipation of the opening monologue of Goethe's *Faust*. After leaving La Fleche he went to Paris, and plunged into dissipation; but from this course he soon withdrew into studious seclusion, concealing himself from his acquaintances for a year. When discovered he retired to Holland, and took service under prince Maurice of Nassau, 1617-19. Here he composed his treatise on *Music*, and developed his remarkable mathematical capacity and attainments. In 1619 he volunteered under Maximilian of Bavaria, and participated in the opening campaign of the Thirty Years' War. His winter quarters, 1619-20, were at Neuburg on the Danube, where he devoted himself for months to solving

ation, and determined the rude outline of his sub-
 tant philosophy. His isolation and intense concern
 of thought affected his brain so far that he fan-
 himself assured by celestial visitations of the truth
 philosophic principles and method. Some sus-
 of the possibility of delusion led him to vow a
 mage to Loretto if his speculations should prove

This vow he discharged four years afterwards.
 olicitude to attain more certain knowledge than
 equired in the schools tempted him to seek a con-
 n with the mysterious society of the Rosicrucians,
 were reputed to possess strange learning and a
 ulous acquaintance with the secrets of nature.
 nally renounced all belief in the existence of the
 erhood of the Rosy Cross.

om the Bavarian army he passed into the Impe-
 and attended its early operations in Hungary
 st Bethlem Gabor; but, after seeing his general,
 uoy, slain before Neusohl, he resigned a military
 r. He had taken up arms for the sake of study-
 men, manners, and countries. He prosecuted
 researches by returning circuitously to Holland
 gh Moravia, Silesia, Pomerania, Brandenburg,
 Holstein, thus visiting regions deemed wholly bar-
 in Western Europe. His unsuspected knowl-
 of the Dutch tongue and his resolute demeanor

d him from murder on the voyage between Emb-
 and the coasts of Friesland. He returned to the
 ue after an absence of three years; passed through
 Spanish Netherlands, arrived at Paris five years
 he had deserted it, and reached his father's house
 ennes, in Brittany, in March, 1622. He thence
 eeded to Poitou to take possession of his share of
 mother's estate, designing to sell it and purchase
 ne place of quick revenue." We are here remind-
 f the oft-recurring projects of Bacon. He failed in
 plans at this time, returned to Rennes, became op-
 sed with the want of occupation in his father's
 e, and reappeared in Paris, where he was suspect-
 o be a Rosicrucian emissary. He was still harass-
 y uncertainties and indecision in regard to
 ce of a vocation. Finding his studies interrupted
 he capital of France, he visited Rennes and Poitou
 in, and sold the greater part of his inheritance.

low commenced a second series of journeys. He
 it first to Switzerland, thence to the Valteline and
 Tyrol, and thence to Venice. He now made his
 rimage to Loretto, whence it may be inferred that
 was by this time satisfied of the truth and solidity
 is philosophical tenets. He was in Rome during
 Jubilee of Urban VIII (1624). He visited Flor-
 e on his homeward route.

He returned to Paris by way of Florence, Turin, and
 ons, and resided for more than three years in the
 nch metropolis, engaged in prosecuting his research-
 and meditations, in polishing lenses and mirrors,
 in determining mathematically and experimental-
 ly the best form of curvature to be given to them.
 conclusions on this point were afterwards embod-
 in his *Dioptrics*. He again withdrew from nearly
 his acquaintances, but his retreat was betrayed by
 indiscretion of a servant. Finding it impossible
 secure the desired seclusion in Paris, he sought a
 eat in Holland in 1629. He now resolved to de-
 se himself entirely to a speculative life. This was
 end of five years of military service, of eight years
 travel, and of fifteen years of hesitation. It is prob-
 ly the lesson of his own experience which is en-
 ced in his *Ethics* in the earnest censure of all irrec-
 tion. The indecision which is thus forcibly con-
 nued was characteristic of Des Cartes, and may
 ve been unconsciously connected with the adoption
 doubt as the basis of his Method.

He was not stationary in any single abode; but his
 me, if home he had anywhere, was in the northern
 rt of the country, at the remote town of Egmont.
 e used every artifice to conceal his retreat. He

communicated his hiding-place to none of his country-
 men except his Franciscan friend Mersenne, through
 whom he conducted nearly all his correspondence with
 the learned world. In 1631 he visited England on the
 invitation of Charles I; in 1634 he went to Denmark.
 Spain, Portugal, Russia, and Turkey were the only
 European states not reached in his wanderings. He
 thrice visited France after his Dutch settlement—in
 1644, 1647, and 1648. On one of these occasions he
 was tempted to Paris by the promise of an honorable
 provision from the crown, but he found that he had
 been drawn from his retreat solely to gratify the curi-
 osity of sight-seers and courtiers.

Des Cartes ascribes the determination of the funda-
 mental principles of his philosophy to his twenty-third
 year, and to his winter-quarters on the Danube. His
 mathematical discoveries were still earlier. In 1638,
 after three years of elaboration, he had prepared a
 sketch of his views of the constitution of the universe,
 but the condemnation of Galileo caused him to with-
 hold it from the press. At length, in 1637, being then
 forty-one years of age, he yielded to the solicitations
 of his friends, and promulgated the general principles
 of his reform in the celebrated *Discours de la Méthode*,
 to which were appended three other treatises—on *Me-
 teors*, *Geometry*, and *Dioptrics*.

Soon after the publication of the Method and accom-
 panying essays, the *Philosophical Meditations* were
 prepared for the press. Des Cartes sent them to his
 friend Mersenne in Paris with the request that they
 should be submitted to the most acute and learned of
 his acquaintances for the benefit of their suggestions
 and observations. Searching criticisms were in conse-
 quence received from Caterus, Hobbes, Arnauld, Gas-
 sendi, Bourdin, S. J., and others. To these objections
 replies by the author were appended, and the whole
 were published together at Paris in 1641, with a ded-
 ication to the theological faculty of the University of
 Paris, in order to place his doctrines under the protec-
 tion of the Church.

Des Cartes continued the exposition of his philoso-
 phy by publishing in Latin in 1644 his *Principia Phi-
 losophica*. This work contains the elaborate and sys-
 tematic deduction of his whole scheme of the intellec-
 tual and material universe. It commences as charac-
 teristically as the *Novum Organum* of Bacon, with the
 fundamental principle of his speculation, that "once
 in life we should endeavor to doubt of all things." It
 arrives at length at the declaration that "none of the
 phenomena of nature have been omitted in the treat-
 ise, but that nothing is to be included in natural phe-
 nomena except what is detected by sense." The last
 sentence of these Principles is equally characteristic
 of the philosopher and the philosophy. "Mindful of
 my weaknesses, I affirm nothing; but I submit all
 these things first to the authority of the Catholic
 Church, next to the judgment of the prudent; and I
 desire nothing to be believed by any one which is not
 approved by manifest and irrefragable reasons." The
 work is preceded by a complete and methodical index,
 stating the substance of each section, and thus afford-
 ing a clear and concise summary of its contents. The
 whole of Cartesianism is thus compressed into one pic-
 ture and into a few pages.

During his long residence in Holland, the tranqui-
 lity of Des Cartes was disturbed by controversies due
 to the imprudence of his admirers. His annoyances
 and hazards increased with the lapse of time. His ini-
 tial doubt seemed to sanction scepticism and to en-
 courage infidelity. His views of matter and mind
 appeared to one party to favor transubstantiation; to
 another, to lead to fatalism. His explanation of the
 connection of body and spirit apparently reduced all
 material action to mere mechanism, or to direct divine
 action. Hence arose the truculent attacks of Voët,
 one of the most prominent Dutch theologians, and rec-
 tor of the University of Utrecht. Des Cartes at length

broke his customary silence, and addressed a long and acrimonious reply to Voët.

These dissensions, so peculiarly irritating and alarming to a cautious and timid nature like Des Cartes's, inclined him to cast about for a more tranquil retreat than that which he had so long cherished. He accordingly consented, after much habitual hesitation, to receive a shelter from queen Christina of Sweden, who had been delighted with his treatise on the Passions, originally composed for the princess palatine Elizabeth. A Swedish admiral, with a royal vessel, was sent to convey Des Cartes to Stockholm, where he was welcomed with honor and favor. The queen was charmed with his conversation and sought his advice, which he gave with modesty and prudence. She availed herself systematically of his instructions, employing the early hours for this purpose, to avoid interference with other studies, with state affairs, and the royal pleasures. Des Cartes was required to forego his life-long habits, and to attend her majesty regularly at five o'clock in the cold mornings of a Swedish winter. This great change, and the severity of the climate, proved fatal to him. He was attacked with fever on Feb. 2, 1650, and died on the 11th of the month. The queen was deeply affected by the announcement of his death. She desired to place his body among the royal sepulchres, and to honor it with a splendid tomb; but as he died in the bosom of the Roman Catholic Church, his remains were deposited in the Roman Catholic cemetery. Sixteen years after his death his remains were removed to France, and placed with imposing ceremonies in the church of Ste. Genevieve. The funeral oration designed for the occasion was prohibited by order of the court; but the like honor was rendered a century later, 1765, by the eulogy of M. Thomas, which was crowned by the French Academy.

The Philosophy of Des Cartes.—The Cartesian philosophy is to be ascertained from the Method, the Meditations, and the Principia. The remaining works are either subsidiary or accessory; either developments and expositions which confuse rather than elucidate, or special treatises on particular branches of science, such as geometry, dioptrics, meteorology, anatomy, physiology, logic, etc. To one solicitous of appreciating the whole intellectual habit of the philosopher, the large collection of his letters is as indispensable as the letters themselves are often charming. To one desirous of obtaining a minute acquaintance with all the perplexities, ambiguities, and vacillations of the Cartesian system, these letters, together with the objections and replies appended to his Meditations, are invaluable. All the smaller works should, of course, be studied by those who would determine the exact position of Des Cartes in the history of speculation, and the precise services rendered by him in the promotion of science.

The first principle of Cartesianism is to make the mind a perfect blank, a *tabula rasa*, and then to reconstruct the whole fabric of conviction and opinion. The same recommendation is given, in a different spirit, by Bacon in the preface to the *Novum Organon*. As Des Cartes recognised the uncertainty and incoherence of contemporary speculation, he proposed to commence the resuscitation of knowledge by doubting all things.

Having rendered his mind a blank by universal doubt, he next sought a foundation for an indubitable body of doctrine. This he detected in the consciousness of thought, including sensation, perception, reflection, and emotion under this term. Hence proceeds the celebrated inauguration of his whole philosophy with the maxim *Cogito, ergo sum*—I think, therefore I am. This is probably an original position with Des Cartes; but thought is, nevertheless, explicitly alleged by Aristotle as an evidence of existence (*Eth. Nicomach.* IX, ix, § 7, 9, ed. Didot). The argument is much more legitimately employed by Ar-

istotle than by Des Cartes as an evidence of past existences, not of existence in general. It has often been indicated that the Cartesian enthymeme is deduced from the tacit assumption of the major premise: reasoning really proceeds in a circle. The acceptance of the dogma assured him of his own existence; it furnished no evidence of the existence of any other being, else, nor did it explain the origin or the preservation of his own existence. The finite existence must repose upon something more stable and immutable than the fleeting, fitful life of which his consciousness assured him. He concludes, therefore, that his own and all other existence must depend for its origin and maintenance upon a more perfect, eternal, and illimitable Being—upon some great "I am," which he discovers in his own mind the notion of such a Being—of God. It could not have been invented by himself, for it transcends his finite capacities. It must have been implanted by God himself; and the presence of the notion attests the existence which it represents. This is a concise statement of the Cartesian argument *a priori* for the Being of God. Last predecessor, it is not original. It is found first developed in the *Proslogium* of St. Anselm. It was popularized by Gaunilo, a contemporary, in the *Liber de insipientie*, and refuted a century and a half later by Thomas Aquinas in his *Summa Theologiae*. The argument proceeds upon the actual or virtual admission of innate ideas, and is accompanied by the reception of another postulate, that innate ideas are necessarily true, because, as they are implanted by God, they partake of the divine veracity, and God can neither deceive nor be deceived. Both innate ideas and the impossibility of divine deception have been denied. Innate ideas, in their Cartesian form, were exploded by Locke; and the impossibility of divine inspiration had been questioned three centuries earlier by Gerv. Arminiensis, general of the Augustinians, and was afterwards acknowledged by Des Cartes to be liable to many objections. But, as Bayle remarks, a universal maxim obnoxious to exceptions furnishes no foundation of certainty, and confirms rather than eradicates scepticism.

Another argument for the being of God is first given by Des Cartes, and appears much more original and tenable. It proceeds from the admission of a First Cause (Des Cartes rejects final causes), using, however, the corrections and modifications of St. Thomas Aquinas, who deduces the argument, not from primary causation, but from the continuous support of created beings. The Argument from a First Cause simply is consistent with either Stoic Fatalism or Epicurean Chance. The argument from perpetual preservation asserts an all-wise Providence and a sustaining Creator. The former leads easily to Pantheism, the other to the acceptance of Revelation.

Having established his own existence, the existence of God, and the verity of innate ideas, how were other ideas to be recognised and distinguished? Here comes in the Cartesian criterion of truth, which extends no further than simply to the determination of innate ideas. Ideas (the term is as much misapplied by Des Cartes as by Locke) which are clear and distinct may be received as *ipso facto* true; and if they are also simple, they may be regarded as innate. The criterion is evidently arbitrary and delusive. What seems clear and distinct, and simple to one mind, may be obscure, intricate, and complex to another. Under this criterion any strong conviction, any engrossing hallucination may present the credentials of truth. It is, therefore, not surprising that so many vagaries should be embodied in the dogmatic exposition of the Cartesian philosophy. But the acceptance of this principle of clearness, distinctness, and simplicity had a potent and felicitous influence upon the literature of France. Des Cartes was himself a model of grace and lucidity of expression, and his criterion of truth, prominently

dawn of the age of Louis XIV, and illustrated in position by himself and by Pascal, contributed ely to produce the characteristic excellences of the rich classic style.

Such as they are, these are the constituent principles of the philosophy of Des Cartes. They are not original. Both Bayle and Leibnitz mention the enrolment of this philosopher among the number of those who pretend to invent what they borrow—"gloriamque adeptos, tamquam repererint quæperant." It is impossible to proceed far in either metaphysics or the physics of Des Cartes without tinging the dreams of Leucippus, Democritus, Epicurus and other philosophers of Greece, and being continually reminded of the sonorous verses and luminous positions of Lucretius.

His definition of existences was suggested to Des Cartes by his demonstration of existence. Mind, or spiritual existence, is thinking substance; body, or material existence, is substance without thought. But as the positive characteristic is required for the discrimination of matter, extension, which is its most familiar property, was assumed as its specific difference, and matter was defined to be extended substance. This necessitated the identification of space and matter, or negation of space as a separate entity. Hence arose the doctrine of the *plenium*, and the maxim that nature abhors a void. The thesis of Lucretius, "est rebus inane," and his argumentation on the thesis, convince that there was no real novelty in these doctrines. But in Des Cartes the two forms of existence are presented as opposite, irreconcilable, and reciprocally incommunicable. In consequence, beasts can possess no capacity of reason. They are purely mechanical—mere machines. This is one of the boldest, most paradoxical, and most dangerous of the Cartesian tenets; but it appears to be a necessity of his philosophy, though he is accused of having taken it—a worthless appropriation—from the Antoniana Margarita of Gomez Pereira, 1554. Certain it is that the acceptance of the Cartesian definitions of mind and matter must result in the declaration that beasts are mere machines. But, if they are such, how are they set in motion, and how do they perform actions apparently voluntary and deliberate? Moreover, if beasts are machines, man must also be a machine, so far as his body is concerned, for mind and matter cannot operate upon one another. An attempt was made to solve these enigmas by the peculiar Cartesian doctrine of assistance, or of divine co-operation in determining all the material actions of animate bodies. In Malebranche this doctrine unfolded itself into the scheme of Occasional Causes; in Leibnitz, into the splendid fantasy of the Pre-established Harmony; in Spinoza, into the most abstract, complete, and systematic Pantheism.

This theory in regard to the mechanical complexion of vital movements affected the ethics of Des Cartes. The chief details of his treatise on the Passions were derived from Aristotle, but his own views of mind and matter, and his own studies and experiments in anatomy and kindred sciences, modified his explanation of the peripatetic doctrines. He made his Moral Philosophy in great measure an exposition of the physical phenomena which accompany emotion; he employed largely the device of vital spirits, which reappear so habitually in Locke; he regards them very much as if they were fluids in a hydraulic engine; and thus he becomes the legitimate precursor of Condillac and Cabanis, of Bain, Moleschott, and Herbert Spencer. The positions of Des Cartes, whether they be sober or fantastical, furnish suggestion or stimulation, and often direction, to the most various branches and types of subsequent speculation.

Des Cartes has left behind him a treatise on Man, to which a singular contrast is offered by the nearly contemporaneous essay of Hobbes, *De Homine*. Man

is the union of the intellectual and material universe—the point where both meet—the synthesis of opposites—the microcosm—the complex organism, whose explanation demands the theory of mind and of matter alike. He thus furnishes a passage from metaphysical to physical inquiries, and *vice versa*.

If the metaphysics of Des Cartes be founded upon the observation of the supposed facts of consciousness, his physical theory of the universe is purely fanciful—a romance, as it was designated by himself. In developing the grand conception of a complete exposition of the order of creation, for which due credit should be given to Des Cartes, it was necessary to explain the phenomena of continual movement on principles exclusively material, without admitting distinct space, or permitting any unoccupied interstices between the constituent particles of the mighty whole. In order that there might be an unlimited tenacity of matter, to allow the free circulation of bodies of diverse density, the atoms of the Ionic school must be rejected, and the infinite divisibility of matter maintained. These prerequisites were secured by the hypothesis of an endless circulatory volubility of matter, which might explain at the same time the motions of the planetary bodies. Another advantage was attained by this fancy. The Copernican system, which had been apparently repudiated by the papacy in the recent condemnation of Galileo, was not asserted, and other theological objections were anticipated by obscuring the distinction between absolute and relative motion. The very statement of his system of the universe as an hypothesis was a concession made by the timidity of Des Cartes to the pretensions of ecclesiastical dogmatism; and it was in response to this and subordinate Cartesian hypotheses that Newton uttered his celebrated maxim, "hypotheses non fingo."

The Cartesian theory of the world turns on the celebrated doctrine of the Vortices. Matter originally exists, if such be the will of God, in a state of incalculable divisibility and of unimaginable attenuation. In this condition of instability motion commences, because there can be no equilibrium between dissimilar and disconnected particles. This motion becomes circular, or irregularly spiral, from the greater or less violent tendency of the particles pressing against each other towards the line of an undetermined axis. As the process advances the revolution becomes more decided, the axis of revolution more definite, and a determinate vortex is established. By the continuance of these gyrations, the more compact particles of matter are forced inwards, and are further condensed, while the more rarefied are thrown off towards the extremities of the ring. But the more solid portions are still interpenetrated by the thinner and more fluid, and the whole vertiginous movement endures, and carries along both the sensible and impalpable materials of the universe. Different centres and different axes of revolution constitute themselves, and thus multitudinous systems of planetary bodies, each in its own vortex, spring into existence. New vortices may originate in the bosom of larger vortices, or vortices may come in contact with each other, and coalesce in a joint action, in which none lose their primitive movement; or larger vortices may seize, encompass, and hurry along with them the weaker spirals which they enclose. All the heavenly movements are provided for by this complex scheme, but, though simple in principle and consistent in development, it is more complicated in action and in exposition than the "cycles on epicycles rolled" of the Ptolemaic mechanism of the heavens. These are the Cartesian Physics which were exploded by Sir Isaac Newton, and which have lain so dead and dormant since the Newtonian Principles that they are scarcely mentioned except as the objects of scientific scorn.

But some apology may be made for this splendid hallucination. It is not for the present generation of

men of science to sneer at the Cartesian Vortices. Founded as they were upon the magnetical researches of Gilbert, they furnish a prelude for the cosmical magnetism of the present day, for the whole nebular hypothesis, for the system of evolution of Spencer. As a part of his exposition, Des Cartes asserts the correlation and conservation of forces, and the indestructibility of matter, which have so startling and modern an air in the speculations of Mayer, Helmholtz, Grove, Faraday, etc. If the theory of Des Cartes is intrinsically absurd, its absurdity is strangely analogous to the most recent generalizations of science.

Like the rest of his dogmas, the dream of the vortices was not original with Des Cartes. Leibnitz speaks of them as "vorticum a veteribus captorum." Speisius charged Des Cartes with having borrowed them from Giordano Bruno and Kepler; and even his own enthusiastic biographer, Baillet, ascribes to Kepler three of the principal Cartesian speculations: 1. Vortices; 2. Gravitation; & 3. Optics. He was largely indebted to Bacon, Gassendi, Fermat, Gilbert, among his contemporaries, and to multitudes of near and distant predecessors. But he was too greedy of pre-eminence to acknowledge his obligations.

The Vortices constitute only a small part of the Physical Philosophy of Des Cartes, but they are the most characteristic portion, and affect nearly all its developments. He has presented reflections, observations, and experiments in regard to most of the principal phenomena of nature, animate and inanimate, material and immaterial. He has studied the wind, the rain, and the hail, the play of light and of colors, the formation of minerals, the growth of plants, comets and earthquakes, the motions of the planets, the mysteries of the stars, the anatomy and the physiology of man, as well as the constitution of the mind and the metaphysics of creation. It was a magnificent and all-embracing survey which he undertook, and of which he left only a sketch, carefully elaborated in some parts and barely indicated in others. His philosophy, as a system, never possessed much intrinsic value, though its vastness of conception and audacity of execution excited lively and lasting enthusiasm. The influence exerted by it can scarcely be overrated, and should not be undervalued. It provoked investigation in all departments of knowledge; it directed inquiry to the most promising fields of study; it commended, by an illustrious example, diligence in observation and patient accuracy of experiment; while the author presented in his own person an admirable type of an earnest, exclusive, simple, and devoted philosophic career.

The Cartesian Philosophy has passed away after a brief and splendid, but not unclouded reign; but to Des Cartes will be due the homage of all ages for the stimulation to more accurate research which he supplied. He has also a more special title to fame on the score of his mathematical discoveries—his invention of Co-ordinate Geometry and Indeterminate Co-efficients. These can be only mentioned in passing, as they affected neither religious opinion nor the developments of theology; and in this work the diverse forms of secular speculation must be regarded mainly in the light of their action upon Christian thought. The names of Malebranche, Spinoza, Bayle, and Leibnitz furnish ample evidence of the powerful but diverse stimulation communicated to theological investigations by the writings of Des Cartes, and demonstrate the justice of that still prevailing feeling which recognises in him one of the fathers of modern philosophy, notwithstanding the rejection of nearly all his distinctive opinions.

Literature.—Des Cartes and his philosophy occupy so large a space in the records of modern philosophy that it would be equally impracticable and nugatory to attempt a full enumeration of the sources of information. All the historians of philosophy, from Bruck-

ner to Des Cartes. Brucker's account of Cartesianism is one of the most satisfactory parts of his laborious work, though it is by no means partial to Des Cartes. If scattered observations of Bayle and Leibnitz had never been overlooked, nor should the favorable criticisms of Victor Cousin be disregarded. The life of Des Cartes must still be sought in the voluminous early biography, Baillet, though much interesting matter may be derived from the *Œuvres* of Thomsen and later prize essayists. Many interesting antebiblical notices are found in the *Discours de la Méthode* and in the letters of Des Cartes. Other materials inviting consultation for a due estimate of his philosophy, and of its relations to previous and subsequent speculation, are Cousin, *Cours de Philosophie*, and *Œuvres de Philosophie Cartésienne* (Paris, 1845); *Mémoires sur la Persécution du Cartésianisme* (1836); *Œuvres Essais Philosophiques* (Paris, 1832); Bonillet, *Œuvres Critique de la Révolution Cartésienne* (Paris, 1841); Lamoulin, *Le Cartésianisme* (Paris, 1843); and *Œuvres Hist. Philosophie du XVIII^e Siècle* (Paris, 1846); also *Essai sur la Philosophie en France au XVII^e Siècle*, vols. 8vo (Paris, 1857). There is an admirable article on the genius and writings of Des Cartes in the *Edinburgh Review*, Jan. 1852. But the indispensable and only sufficient text for the real student is contained in the works of Des Cartes, of which the best edition is *Opera Omnia* (Amstelodami, 1692-1701, 8 vols. 4to); *Œuvres Complètes de Des Cartes*, ed. Victor Cousin (Paris, 1824-26, 11 vols. 8vo). There is a convenient selection of his purely philosophical treatises in *Œuvres* (Paris, 1844). On the relations of Cartesianism to theology, see Gass, *Geschichte d. prot. Dogmatik* (Berlin, 1854-62, 8 vols.); Dorner, *Geschichte d. prot. Theologie*, München, 1867, p. 461 sq.; Farrer, *Critical History of Free Thought*, Lecture III; Hagenbach, *History of Doctrines*, § 225, 238; Tholuck, *Academisches Lehrbuch* (17ten Jahrvhunderts (1854, part ii); Morell, *History of Modern Philosophy* (N. Y. edition), p. 115, 194.

DESCENT (CHRIST'S) INTO HELL. See **HELL**.
DESCENT INTO; CREED, APOSTLES'.

Desert (Gr. ἔρημος; see Rechenberg, *De ἔρημοις*, Lips. 1680), a word which is sparingly employed in the A. V. to translate four Hebrew terms, and even in the rendering of these is not employed uniformly. The same term is sometimes translated "wilderness," sometimes "desert," and once "south." In one place we find a Hebrew term treated as a proper name, and in another translated as an appellative. This gives rise to considerable indefiniteness in many passages of Scripture, and creates confusion in attempts at interpretation. But, besides all this, the ordinary meaning attached to the English word "desert" is not that which can be legitimately attached to any of the Hebrew words it is employed to represent. We usually apply it to "a sterile sandy plain, without inhabitants, without water, and without vegetation"—such, for example, as the desert of Sahara, or that which is overlooked by the Pyramids, and with which many travellers are familiar. No such region was known to the sacred writers, nor is any such one referred to in Scripture. It will consequently be necessary to explain in this article the several words which our translators have rendered "desert," and to show that, as used in the historical books, they denote definite localities. See **TOPOGRAPHICAL TERMS**.

1. **MIDBAR**, מִדְבָּר (Sept. ἔρημος, and ἀρόσις) is of very frequent occurrence, and is usually rendered "wilderness" (Gen. xiv, 6, etc.), though in some places "desert" (Exod. iii, 1; v, 1, etc.), and in Ps. lxxxv, 6, "south." It properly designates pasture-ground, being derived from מִדְבָּר, *dabar*, "to drive," significant of the pastoral custom of driving the flock out to feed in the morning, and home again at night; and it means a wide, open tract used for pasture:

"common; thus, in Joel ii, 22, "The pastures of *desert* shall flourish." It is the name most commonly applied to the country lying between Palestine and Egypt, including the peninsula of Sinai, through which the Israelites wandered (Gen. xxi, 14, 21; Exod. 27; xix, 2; Josh. i, 6, etc.). Now the peninsula Sinai is a mountainous region; in early spring its stony soil produces grass and green herbs, and, with the exception of one little plain on the north side of the great mountain-chain, there is no sand whatever. This small plain is expressly distinguished from the rest by the name *Debet er-Rameh*, "plain of sand" (Robinson, *Bib. Res. i*, 77; Porter, *Handbook for Syria and Pal.* p. 2 sq.). On the other hand, in this whole region streams of water are not found except in winter and after heavy rain; fountains are very rare, and there are no settled inhabitants. Stanley, accordingly, has shown that "sand is the exception and not the rule of the Arabian Desert" of the peninsula of Sinai (*Desert*, p. 8, 9, 64). As to the other features of a desert, certainly the peninsula of Sinai is no plain, but a region extremely variable in height, and diversified even at this day by oases and valleys of verdure and vegetation, and by frequent wells, which were all probably far more abundant in those earlier times than they now are. With regard to the Wilderness of the wanderings—for which Midbar, or *grazing-tract* (almost our "prairie"), is almost invariably used—this term is therefore most appropriate; for we must never forget that the Israelites had flocks and herds with them during the whole of their passage to the Promised Land. They had them when they left Egypt (Exod. x, 26; xii, 38); they had them at Hazereth, the middle point of the wanderings (Num. xi, 22), and some of the tribes possessed them in large numbers immediately before the transit of the Jordan (Num. xxxii, 1). In speaking of the Wilderness of the Wanderings the word "desert" occurs as the rendering of *Midbar*, in Exod. iii, 1; v, 8; xix, 2; Num. xxxiii, 5, 16; and in more than one of these it is evidently employed for the sake of euphony merely. See EX-DE.

Midbar is also used to denote the wilderness of Arabia; but generally with the article מִדְבָּר *Midbar*, "the desert" (1 Kings ix, 18). The wilderness of Arabia is not sandy; it is a vast undulating plain, parched and barren during summer and autumn, but in winter and early spring yielding good pasture to the flocks of the Bedawin that roam over it. Hence the propriety of the expression *pastures of the wilderness* (Psa. lxxv, 13; Joel i, 19; compare Luke xv, 4). Thus it is that the Arabian tribes retreat into their deserts on the approach of the autumnal rains, and when spring has ended and the droughts commence, return to the lands of rivers and mountains, in search of the pastures which the deserts no longer afford. It may also be observed that even deserts in the summer time are interspersed with fertile spots and clumps of herbage (Hackett's *Illustration of Scripture*, p. 25). The *Midbar of Judah* is the bleak mountainous region lying along the western shore of the Dead Sea, where David fed his father's flocks, and hid from Saul (1 Sam. xvii, 28; xxvi, 2 sq.). The meaning of *Midbar* in both these instances is thus likewise a district without settled inhabitants, without streams of water, but adapted for pasturage. It is the country of nomads, as distinguished from that of the agricultural and settled people (Isa. xxxv, 1; 1, 2; Jer. iv, 11). The Greek equivalents in the New Test. are *ἔρημος* and *ἔρημία*. John preached in the "wilderness," i. e. the open, unpopulated country, and our Lord fed the multitudes in the "wilderness" or wild region east of the Dead Sea (Matt. iii, 8; xv, 38; Luke xv, 4). See WILDERNESS.

Midbar is most frequently used for those tracts of waste land which lie beyond the cultivated ground in the immediate neighborhood of the towns and villages

of Palestine, and which are a very familiar feature to the traveller in that country. In spring these tracts are covered with a rich green verdure of turf, and small shrubs, and herbs of various kinds. But at the end of summer the herbage withers, the turf dries up and is powdered thick with the dust of the chalky soil, and the whole has certainly a most dreary aspect. An example of this is furnished by the hills through which the path from Bethany to Jericho pursues its winding descent. In the spring, so abundant is the pasturage of these hills that they are the resort of the flocks from Jerusalem on the one hand and Jericho on the other, and even from the Arabs on the other side of Jordan. Even in the month of September, though the turf is only visible on close inspection, large flocks of goats and sheep may be seen browsing, scattered over the slopes, or stretched out in a long, even line like a regiment of soldiers. A striking example of the same thing, and of the manner in which this waste pastureland gradually melts into the uncultivated fields, is seen in making one's way up through the mountains of Benjamin, due west, from Jericho to Mukhmas or Jeba. These *Midbars* seem to have borne the name of the town to which they were most contiguous, for example, Bethaven (in the region last referred to); Ziph, Maon, and Paran, in the south of Judah; Gibeon, Jeruel, etc., etc. See VILLAGE.

In the poetical books "desert" is found as the translation of *Midbar* in Deut. xxxii, 10; Job xxiv, 5; Isa. xxi, 1; Jer. xxv, 24. See MIDBAR.

2. ARABAH (אַרְבָּה, Sept. *Ἀραβία* and *δυσμῆ*), from אַרְבָּ, *arab'*, to dry up (Gesenius, *Thez.* p. 1060), i. e. parched ("desert" in Isa. xxxv, 1, 6; xl, 8; xli, 19; li, 8; Jer. ii, 6; xvii, 6; 1, 12; Ezek. xlvii, 8; elsewhere usually "plain"), which is either applied to any arid tracts in general, or specially to the *Arabah* (as it is still called), or lone desert tract or plain of the Jordan and Dead Sea, shut in by mountains, and extending from the lake of Tiberias to the Eranitic Gulf; called by the Greeks *Ἀράβιον* (Euseb. *Onomast.*). The more extended application of the name by the Hebrews is successfully traced by professor Robinson from Gesenius: "In connection with the Red Sea and Elath" (Deut. i, 1; ii, 8). "As extending to the lake of Tiberias" (Josh. xii, 8; 2 Sam. iv, 7; 2 Kings xxv, 4). "Sea of the Arabah, the Salt Sea" (Josh. iii, 16; xii, 8; Deut. iv, 49). "The *arboth* (plains) of Jericho" (Josh. v, 10; 2 Kings xxv, 5). "Plains (*arboth*) of Moab," i. e. opposite Jericho, probably pastured by the Moabites, though not within their proper territory (Deut. xxiv, 1, 8; Num. xxii, 1). In the East, wide, extended plains are usually liable to drought, and consequently to barrenness. Hence the Hebrew language describes a plain, a desert, and an unfruitful waste by this same word. Occasionally, indeed, this term is employed to denote any dry or sterile region, as in Job xxiv, 5, and Isa. xl, 3. It is thus used, however, only in poetry, and is equivalent to *Midbar*, to which it is the poetic parallel in Isa. xxxv, 1: "The wilderness (*Midbar*) shall be glad for them, and the desert (*Arabah*) shall rejoice, etc.;" also in xli, 19. *Midbar* may be regarded as describing a region in relation to its use by man—a pastoral region; *Arabah*, in relation to its physical qualities—a wilderness (Stanley, *Palest.* p. 481). But in the vast majority of cases in which it occurs in the Bible, *Arabah* is the specific name given either to the whole, or a part of the deep valley extending from Tiberias to the Gulf of Akabah. With the article אַרְבָּה, it denotes, in the historical portions of Scripture, the whole of the valley, or at least that part of it included in the territory of the Israelites (Deut. i, 7; iii, 17; Josh. xii, 1; etc.); when the word is applied to other districts, or to distinct sections of the valley, the article is omitted, and the plural number is used. Thus we find "the plains of Moab"

(עֲרֵבוֹת, Num. xxii, 1, etc.); "the plains of Jericho" (Josh. iv, 18); "the plains of the wilderness" (2 Sam. xvii, 16). The southern section of this sterile valley still retains its ancient name, *el-Arabah* (Robinson, *Bib. Res.* i, 169; ii, 186; Stanley, *Palest.* p. 84). It appears, therefore, that this term, when used, as it invariably is in the topographical records of the Bible, with the definite article, means that very depressed and enclosed region—the deepest and the hottest chasm in the world—the sunken valley north and south of the Dead Sea, but more particularly the former. True, in the present depopulated and neglected state of Palestine, the Jordan Valley is as arid and desolate a region as can be met with, but it was not always so. On the contrary, we have direct testimony to the fact that when the Israelites were flourishing, and later in the Roman times, the case was emphatically the reverse. Jericho (q. v.), "the city of palm-trees," at the lower end of the valley, Bethshean (q. v.) at the upper, and Phasaelis in the centre, were famed both in Jewish and profane history for the luxuriance of their vegetation (Joseph. *Ant.* xviii, 2, 2; xvi, 5, 2). When the abundant water-resources of the valley were properly husbanded and distributed, the tropical heat caused not barrenness, but tropical fertility, and here grew the balsam, the sugar-cane, and other plants requiring great heat, but also rich soil, for their culture. *Arabah*, in the sense of the Jordan Valley, is translated by the word "desert" only in Ezek. xvii, 8. In a more general sense of waste, deserted country—a meaning easily suggested by the idea of excessive heat contained in the root—"desert," as the rendering of *Arabah*, occurs in the prophets and poetical books; as Isa. xxxv, 1, 6; xl, 8; xli, 19; li, 8; Jer. ii, 6; v, 6; xvii, 6; 1, 12; but this general sense is never found in the historical books. In these, to repeat once more, *Arabah* always denotes the Jordan Valley, the *Ghôr* of the modern Arabs. See ARABAH.

8. **YESHIMON'**, יֶשִׁימוֹן (Sept. *ἀνδροπος* et *ἔρημος*), from יָשַׁם, to lie waste ("wilderness," Deut. xxxii, 10; Psa. lxxviii, 7; "solitary," Psa. cvii, 4), in the historical books is used with the definite article, apparently to denote the waste tracts on both sides of the Dead Sea. In all these cases it is treated as a proper name in the A. V.: thus in Num. xxi, 20, "The top of Pisgah, which looketh towards *Jeshimon*." See also BETH-JESHIMOTH. Without the article it occurs in a few passages of poetry, in the following of which it is rendered "desert": Psa. lxxviii, 40; cvi, 14; Isa. xliiii, 19, 20. This term expresses a *greater extent* of uncultivated country than the others (1 Sam. xxiii, 19, 24; Isa. xliiii, 19, 20). It is especially applied to that desert of peninsular Arabia in which the Israelites sojourned under Moses (Num. xxi, 20; xxiii, 28). This was the most terrible of the deserts with which the Israelites were acquainted, and the only *real* desert in their immediate neighborhood. It is described under ARABIA, as is also that Eastern desert extending from the eastern border of the country beyond Judea to the Euphrates. It is emphatically called "the Desert," without any proper name, in Exod. xxiii, 31; Deut. xi, 24. To this latter the term is equally applicable in the following poetical passages: Deut. xxxii, 10; Psa. lxxviii, 7; lxxviii, 40; cvi, 14. It would appear from the reference in Deuteronomy—"waste, howling wilderness," that this word was intended to be more expressive of utter wasteness than any of the others. In 1 Sam. xxiii, 19, and xxvi, 1, it evidently means the wilderness of Judah.—Kitto, s. v.; Smith, s. v. See JESHIMON.

4. **CHORBAH'**, חֲרֵבָה (Sept. *ἔρημος*, etc.; A. V. usually "waste," "desolate," etc.), from חָרַב, to be dried up, and hence desolate, is a more general term denoting a *dry place* (Isa. xlviii, 21), and hence *desolate* (Psa. ix, 6), or concretely *desolate* (Lev. xxvi, 81,

83; Isa. xlix, 14; lxiv, 10; Jer. vii, 34; xxxi, 5; 9, 11, 18; xxvii, 12; xliiv, 2, 6, 22; Ezek. v. 11; 13; xxix, 9, 10; xxv, 4; xxviii, 8), or *ruin* (1 Sam. xxxvii, 10, 83; xxxviii, 12; Mal. i, 4; Isa. lvi, lxi, 4). It is generally applied to what has been rendered desolate by man or neglect (Ezra ix, 9; cix, 10; Isa. xliiv, 26; li, 8; lii, 9; Jer. xlix, 12; xxvi, 20; xxlii, 24, 27; xxxvi, 4; Dan. ix, 2). It is employed in Job iii, 14, to denote buildings that finally fall to ruin (comp. Isa. v, 17, the ruined house of the rich). The only passage where it expressed a natural waste or "wilderness" is Isa. xlviii, 21, which refers to that of Sinai. It does not occur in any other biblical passage, and is rendered "desert" only in Job ii, 6; Isa. xlviii, 21; Ezek. xliii, 4.

5. The several deserts or wildernesses mentioned in Scripture (besides the above) are the following: (1) the *Desert of Shur* or *Etham* (Num. xxxiii, 8; Exod. xv, 22); (2) the *Desert of Paran* (Num. xliii, 8); (3) the *Desert of Sinai* (Exod. xix); (4) the *Desert of Sin* (Exod. xvi, 6); (5) the *Desert of Zin* (Num. xx, 1)—these are probably only different names of the great *Arabian Desert*, distinguished by several proper names; (6) the *Desert of Judah*, which is mentioned in Psa. lxxiii, in the title; Luke i, 80); (7) the *Desert of Ziph* (1 Sam. xxiii, 14, 15); (8) the *Desert of Ephraim* (Josh. xv, 62); (9) the *Desert of Carmel* (Josh. xiv, 65); (10) the *Desert of Maon* (1 Sam. xxiii, 24); (11) the *Desert of Tekoa* (2 Chron. xxx, 20)—these are probably only parts of the *Desert of Judah*; (12) the *Desert of Jericho*, separating the Mount of Olives from the city of Jericho (Jer. lii, 8); (13) the *Desert of Ephraim* seems to be a part of Mount Ephraim (Josh. xv, 12); (14) the *Desert of Damascus* (1 Kings xix, 16), the same as the Desert Syria, where Tadmor was situated (1 Kings ix, 18).

6. "Desert" or "wilderness" is also the symbol in Scripture of temptation, solitude, and persecution (Isa. xxxvii, 10; xxxiii, 9). The figure is sometimes emblematical of spiritual things, as in Isaiah xli, 19: "In chap. xxxii, 15, where it refers to nations in view of their that they should be enlightened and made to produce fruit unto holiness. A desert is mentioned as the symbol of the Jewish Church and people, when they have forsaken their God (Isa. xl, 8); it is also spoken of with reference to the conversion of the Gentiles (Isa. xli, 1). The solitude of the desert is a subject often alluded to (Job xxxviii, 26; Jer. ix, 2). The desert is considered the abode of evil spirits, or at least the occasional resort (Matt. xii, 43; Luke xi, 24), an opinion held also by the heathen (Virg. *Æn.* vi, 27). See Wemyss's *Clavis Symbolica*, s. v).

Desire. See CONCUPISCENCE; SIN.

Desire (Ecc. xii, 5). See CAPER-PLANT.

DESIRE OF ALL NATIONS (דִּשְׁוֹן לְכָל הָעַמִּים) is the *delight of all the nations*; Sept. *τὰ ἐκλεκτὰ σαρκεῖα τῶν ἔθνων*; Vulg. *desideratus cunctis gentibus*) is an expression (Hag. ii, 7) usually referred to as a title to the Messiah (see in Henderson, *Comment.* in loc.), but denoting rather the choicest treasures of the Gentiles (comp. Isa. lx, 8-7), which are figuratively represented as an allusion to the Messianic dispensation (see Moore, *Comment.* in loc.; Sartorius, *De venturo gentium Desiderio*, 1756).

Desk, in the Church of England, a raised seat otherwise called a "reading-pew" (see rubric before "Commination"), set up in the body of the church from which, since the beginning of the reign of James I, it has been appointed that the daily morning and evening service should be read, the chancel having been used for that purpose before the above period. In the Protestant Episcopal Church of the United States there is no rubric on the subject.

Desmares, TOUSSAINT GUI JOSEPH, a celebrated preacher and controversial writer, was born at in 1599. He entered at an early age the new regulation of the Oratory, where Father (subsequently cardinal) Berulle became his spiritual adviser, later, his friend. As a preacher, from 1688 to he met with marked success. A profound study of the works of St. Augustine made him an adherent of the Jansenists, whose doctrines he defended with a which made him many enemies. He was forbidden the pulpit, and a *lettre de cachet* was obtained against him but he had time to escape. By another *lettre* he was permitted to quit, whence he was in 1658 permitted to return. He then went to Rome to plead the cause of the Jansenists, and delivered in the presence of the pope a remarkable speech, which was published in the *Journal de St. Amour*. On his return to France he concealed himself until 1668, when the archbishop of Paris appointed him to preach during Advent in the church of St. Roch. But soon he was again obliged to flee, but he found a powerful protector, first in the person of Luynes, and subsequently in the duke of Liancourt. He died at Liancourt on Jan. 19, 1669. All his works that are published are of a controversial character; some others, e. g. *Trasité de l'Église*, still remain unpublished.—Hoefler, *Biog. Générale*, xiii, 842.

Desmarests. See MARESIUS.

Desolation, ABOMINATION of (βδελύγμα τῆς μύσεως, Matt. xxiv, 15; Mark xiii, 14, as a translation of שָׁמַיִם אֲבִיּוֹן), especially in Dan. ix, 27, and for the overspreading (שָׁמַיִם אֲבִיּוֹן, wing) of abominations he shall make it desolate" (so the A. V. vague and inaccurately renders). Here an especial difficulty in the interpretation of the phrase is created by the ambiguity of the term שָׁמַיִם אֲבִיּוֹן, which is usually regarded as equivalent to the περιούσιον, or 'singlet pinnacle') of the Temple (Matt. iv, 5; iv, 9). See NACLE. "We believe," says Hävernick, "that all the meanings of שָׁמַיִם אֲבִיּוֹן that are sufficiently supported, none so commends itself as that of border, properly of a garment, e. g. 1 Sam. xv, 27; Num. xv, 8; Ezra v, 8; Zech. viii, 23; Hag. ii, 12; then secondarily of places, regions of the earth, hence שָׁמַיִם אֲבִיּוֹן, the ends, limits, uttermost parts of the earth, Job xxxvii, 8; xxxviii, 18; Isa. xi, 12; Ezek. vii, 2. Sept. περιούσιος τῆς γῆς, the extremity of the earth.)

... According to this, שָׁמַיִם אֲבִיּוֹן would denote here *extremities regionis*, the utmost point or part of a district or of a place, and שָׁמַיִם אֲבִיּוֹן, on the utmost point of abomination, i. e. on the highest place where abomination could be committed. But the highest point in Jerusalem was the Temple, and it must be this which is thus designated here. We admit that this meaning would be obscure before the fulfilment of the prediction; but this we hold to be only a characteristic feature of such predictions. . . . As respects the form שָׁמַיִם אֲבִיּוֹן, most interpreters take it as *nomen participiale* for 'destruction'; but this is against the usage of the form elsewhere in Daniel (xi, 31), and the meaning is brought out much more vividly and poetically by our construction. 'On the summit of abomination is a destroyer,' probably collectively for 'destroyers' in general. . . . According to this explanation, there can be no doubt that the Sept. has already rightly given the meaning of the passage when it translates *καὶ ἐπὶ τὸ ἱερόν βδελύγμα τῶν ἱερῶσεων ἴσται*, and so the Syr. Ambros. Somewhat different from this is Theodotion, *καὶ ἐπὶ τοῦτοις* (these two words are wanting in the Vatican Codex) *ἐπὶ τὸ ἱερόν βδελύγμα τῆς ἱερῶσεως* (Cod. Vat. τῶν ἱερῶσεων), and so Jacob of Edessa (ap. Bugati, p. 161), except that he seems to have read *καὶ ἱερῶσεως*. The Peshito gives 'on the wings of abhorrence,' and this Ephraem refers to the Roman eagles. The Vulg., *Et erit in templo abomi-*

natio desolationis: Ven. Gr., *καὶ περιούσιος βδελύγματα ἱερῶσεων*" (*Commentar. üb. Daniel* in loc.). Some codices read *שָׁמַיִם אֲבִיּוֹן*, and in the temple of Jehovah an abomination (see Kennicott, *Bib. Heb.* in loc.; De Rossi, *Var. Lectt.* iv, 147). This agrees with the reading of the Sept. and Jerome, as also of the Memphitic and Sahidic versions, and with the citation of the evangelists. It may be a mere correction, but there is a curious fact urged by Michaelis which seems to give it some weight. Josephus, in recording the destruction of the Arx Antonia, says that the Jews thus made the Temple building a square, not considering that it was written in the prophecies that the city and Temple should be taken when the Temple was made four-square (*War*, vi, 5, 4). To what prediction the historian here refers has always appeared obscure, and his whole statement has been perplexing. But Michaelis argues that if the reading of Dan. ix, 27 was in his day that given above, the difficulty is solved; for we have only to suppose he read the last word שָׁמַיִם אֲבִיּוֹן, *she-yakots'*, in which case the meaning would be "and in the Temple shall he who cuts off (from שָׁמַיִם אֲבִיּוֹן) be a desolator" (*Orient. u. exeg. Bibliothek*, ii, 194). If we may take Josephus as a representative of the common opinions of his countrymen, they must have regarded these predictions as finding their fulfilment not merely in the acts of Antiochus Epiphanes, but also in the destruction of Jerusalem by the Romans (*Ant.* x, 7). As against the opinion that שָׁמַיִם אֲבִיּוֹן is to be understood of idolatrous objects carried by heathens into the Temple, it has been objected that this word designates idols only as adopted by the Jews. But this is wholly unfounded, as 1 Kings xi, 5; 2 Kings xxiii, 13, and other passages abundantly show. Indeed, the word is always used objectively, to designate that which is an abomination, not *in*, but *to* the parties spoken of.—Kitto, s. v. See ABOMINATION.

Desperati, a name of reproach by which the early Christians, in times of persecution, were stigmatized. Lactantius says, "Those who set a value on their faith, and will not deny their God, they first torment and butcher with all their might, and then call them *desperati*, because they will not spare their own bodies; as if anything could be more desperate than to torture and tear in pieces those whom you cannot but know to be innocent."—Bingham, *Orig. Eccl.* bk. i, ch. ii, § 9.

Des'sau (Δεσσαού v. r. Δεσσαού, perh. for Chald. דֵּסְסָא, i. e. Heb. דֵּסְסָא, *trituration*; Vulg. *Dessau*), a village (κώμη, *castellum*) at which Nicanor's army was once encamped during his campaign with Judas (2 Macc. xiv, 16). There is no mention of it by this name in the account of these transactions in 1 Macc. or in Josephus, but Ewald conjectures (*Gesch. Isr.* iv, 368 note) that it may have been the ADASA (q. v.) in the same region (1 Macc. vii, 40, 45; Joseph. *War*, iii, 6).

Destroyer (מַשְׁחִיתִים, *maschchithim*), Exod. xii, 29; *ἀλοφρευτής*, 1 Cor. x, 10), an exterminator (see Brömel, *De angelo exterminatore*, Jen. 1685; also in the *Theaur. theol. philolog.* V. T. i, 801 sq.). See DEATH. The Hebrews were accustomed by a figure to speak of any superhuman agency as that of an angel (see Bush, *Note* on Exod. iii, 2); and whenever this had a providential aspect it was attributed to a divine messenger (2 Kings xix, 35; 2 Sam. xxiv, 15, 16; Psa. lxxviii, 49; Acts xii, 23). See ANGEL. Even Satan's malignity is represented as thus employed (Job ii, 6, 7). See ABADDON.

Deservants, a name given in the Church of France to such of the Roman Catholic clergy as have charge of churches or chapels subordinate to the parish church. The old French law distinguishes between parish churches (*parochiales ecclesie*) and auxiliary churches (*succursales ecclesie*), and the clergyman supplying the latter were under the orders of the

parish priest (Du Cange, *Gloss*, s. v.) When Bonaparte restored the Roman Catholic Church in France, he provided for the stipend of the pastors (*curés*) out of the government funds; it became therefore desirable to reduce their number as much as possible. It was settled that there should be one for every district subject to a justice of the peace, and that the subordinate churches (*succursales*) should be supplied with what priest they required on condition that these priests should be chosen among those who had pensions, by means of which, together with what their congregations would give them, they could support themselves. Two decrees, dated May 31, 1804, and Dec. 26, 1804, granted to the *deservants* a stipend of 500 francs. The *deservants* firmly established themselves in their respective fields of labor, and came, in fact, to differ only from the curates or pastors in having a smaller salary, and being more under the control of the bishops. This control they tried to escape, but their efforts met with but little success. Pope Gregory XVI decided in favor of the existing order of things. The bishops never remove a *deservant* from his parish except for grave reasons. The *deservants* form the greater part of the Roman Catholic clergy of France, Belgium, and Rhenish Prussia. See Sibour, *Institutions diocésaines par Mgr. l'évêque de Digne* (Paris, 1845; Digne, 1848), etc.; Jacobson, in Herzog, *Real-Encyclopædie*, iii, 330.

Destruction, CITY OF (Isa. xix, 18). See ON.

DESTRUCTION OF BEL AND THE DRAGON, THE HISTORY OF THE, one of the apocryphal books of the Old Testament, found only in the Greek. See APOCRYPHA.

I. Title and Position.—This apocryphal piece, which is called by Theodotion, or in our editions of the Sept., *Βῆλ καὶ Δράκων*, *Bel and the Dragon*, and in the Vulg. *Historia of Bel and the Great Serpent*, has in the Sept. the inscription *ἐκ προφητείας Ἀμβρακῶν υἱοῦ Ἰησοῦ ἐκ τῆς φυλῆς Λευὶ*, *A Part of the Prophecy of Habakkuk, the Son of Jesus, of the Tribe of Levi*, and is placed at the end of Daniel as a supplemental chapter, forming in the Vulg. the 14th chapter of that prophet. In the English Authorized Version it is entitled in full as above, where it is placed between the History of Susanna and the Prayer of Manasses. See BEL AND THE DRAGON.

II. Contents.—The plan of the writer is both ingenious and attractive. Cyrus, who was a devout worshipper of Bel, urged Daniel to serve his idol, and referred to the marvellous fact that it devoured daily the enormous sacrifice of twelve great measures of fine flour, forty sheep, and six vessels of wine (ver. 1-6); but Daniel, knowing the deception connected therewith, smiled at it (ver. 7); thereupon the king summoned the priests of Bel, and demanded an explanation from them (ver. 8-10); they, to satisfy him that the idol does consume the sacrifice, told the monarch that he should place it before Bel himself (ver. 11-13). Daniel, however, had ashes strewed on the pavement of the temple, and convinced Cyrus, by the impress of the footsteps upon the ashes, that the sumptuous feast prepared for Bel was consumed in the night by the priests, their wives, and their children, who came into the temple through secret doors, and the king slew the crafty priests (ver. 11-22). As for the Dragon, who, unlike the dumb Bel, was, as Cyrus urged, a living being (ver. 23, 24), Daniel poisoned it, and then exclaimed, "These are the gods you worship!" (ver. 25-27). The Babylonians, however, greatly enraged at the destroyer of their god, demanded of Cyrus to surrender Daniel, whom they cast into a den wherein were seven lions (ver. 28-32). But the angel of the Lord commanded the prophet Habakkuk, in Judæa, to go to Babylon to furnish Daniel with food, and when he pleaded ignorance of the locality, the angel carried him by the hair of his head through the air to the den, where he fed and comforted Daniel (ver.

86-89). After seven days Cyrus went to the den, to bewail Daniel, "and, behold, Daniel was sitting. The king then commanded that he should be set out, and all his persecutors be thrown in to be fully devoured, and the great Cyrus openly acknowledged the greatness of the God of Israel (ver. 44). This story is read in the Roman Church on Ash Wednesday, and in the Anglican Church on the 23d of November. See DANIEL, APOCRYPHAL ADDITIONS.

III. Character of the Book.—The object of this Jewish author of the history of the destruction of Bel and the Dragon was, according to Jahn, "to warn against the sin of idolatry some of his brethren who had embraced Egyptian superstitions. The book was therefore well adapted to the time, and shows that philosophy was not sufficient to keep men from passing into the most absurd and degrading superstitions. The time of the writing Jahn ascribes to the age of the Ptolemies, when serpents were still worshipped at Thebes.

Among the difficulties attending this as a portion of the book of Daniel, Jahn enumerates the denominating Daniel a priest (xiv, 1), which he conceives to be a confounding of Daniel the prophet with Danea the priest (Ezra viii, 2; Neh. x, 7); the order of the king to destroy the idol of Bel, and the assertion that serpents were worshipped at Babylon; but he conceives all these difficulties to be removed by regarding the whole as a parable, pointing out the vanity of idols and the impostures of the priests. We are indebted by Herodotus that the temple of Bel was destroyed by Xerxes. By Protestants, of course, these apocryphal additions to Daniel are regarded as wholly insufficient. See DEUTERO-CANONICAL.

IV. Source and original Language.—The basis of this story is evidently derived from Dan. vi and Ezr. viii, 3, ingeniously elaborated and embellished to effect the desired end. It is not in the nature of such sacred legends to submit to the trammels of fact, or to endeavor to avoid anachronisms. That Daniel, who was of the tribe of Judah, should here be represented as a priest of the tribe of Levi; that he should have been to have destroyed the temple of Belus which was pulled down by Xerxes, and that the Babylonians should be described as worshippers of living animals, which they never were, are therefore quite in harmony with the character of these legends. Their object is effect and not fact. The Greek of our editions of the Sept. is the language in which this national story has been worked out by the Alexandrine embellisher to exalt the faith of Abraham before the idolatrous Greeks. Various fragments of it in Aramaean and Hebrew are given in the Midrash (*Beresith Rabba*, c. 68), Josephus (see Gorion (p. 84-87, ed. Breithaupt), and in Delitzsch's work, *De Habacuci vitâ et orac.*, which will show the Babylonian and Palestinian shape of these popular traditions.—Kitto, s. v. See BEL.

Destructionists. See ANNihilationists.

Determinism, the general name for all those theories according to which man, in his religious and moral action, is absolutely determined by external or internal motives not belonging to him, and which either deny his freedom or explain it as a mere semblance. In opposition to determinism, the word *indeterminism* has been used of a will which is absolutely undetermined from abroad, but wholly determined itself. Such an absolute indeterminism can only be predicated of the absolute being. Absolute determinism, on the other hand, can only be attributed to objects whose activity is altogether dependent upon external impulses, as is the case with the objects of nature. Applying the term to man, every branch of the Christian Church holds to some kind of determinism, inasmuch as he is dependent upon the absolute being, and that his actions are influenced by impulses not his own.

ut it is common to understand by determinism those views of man's dependence upon external influences which destroy his moral responsibility. In this sense various kinds of determinism are distinguished. It is *utilitarian* or *predeterministic* if it places an irresistible fatality above even the divine being or economy, as was done by the Greeks in the doctrine of fate, and is ill done by the Mohammedans. It is *pantheistic* if it deduces necessity from the unalterable connection of things, making the individual acts of man, as it were, a sport of the world-soul with itself, as was the case in the cosmic theories of the Indians, in the ethics of the Stoics, in the system of Spinoza, and in certain modern systems. The *astrological* determinism is a transition from the first to the second kind. Determinism is *materialistic* if the want of human freedom is explained by the life of the human soul being determined by an evil or hostile *materia*, as was done by the Parsees, the Gnostics, and the Manichæans. Different from these ancient materialists are the modern representatives of a materialistic determinism, like La Fontaine, who reduce all human actions to an absolute impulsion by sensuous motives. A subdivision of his determinism is the phrenological determinism which in modern times has found some champions. A subtle form of determinism is found in some rationalistic writers, who explain the self-determination of man as a coercion by inner representations (Priestley) or by adequate reasons (Leibnitz). Other writers on his subject have divided determinism into mechanical, rational, and metaphysical determinism.—Herzog, *Real-Encyklop.* iii, 331. See WILL; PREDESTINATION.

Detraction (Lat. *detractio*, from *detrahere*) means primarily taking off from a thing; and in morals it is the act of depreciating another's reputation. Barrow observes (*Works*, N. Y. edition, i, 208 sq.) that it differs from *slander*, which involves an imputation of falsehood; from *reviling*, which includes bitter and foul language; and from *censuring*, which is of a more general purport, extending indifferently to all kinds of persons, qualities, and actions; but detraction especially respects worthy persons, good qualities, and laudable actions, the reputation of which it aims to destroy. It is a fault opposed to *candor*. "Nothing can be more incongruous with the spirit of the Gospel, the example of Christ, the command of God, and the love of mankind, than a spirit of *detraction*; and yet there are many who never seem happy but when they are employed in this work; they feed and live upon the supposed infirmities of others; they allow excellence to none; they depreciate every thing that is praiseworthy; and, possessed of no good themselves, they think all others are like them. 'O! my soul, come thou not into their secret; unto their assembly, mine honour, be not thou united'" (Buck, *Theolog. Dict.* s. v.). "When we consider the motives in which detraction originates, we shall find that most of them spring from, or centre in, malevolence. In some persons there is a lust of distinction, which cannot endure an equal, and burns with a desire to level the pre-eminence of every superior. In whatever degree this disposition may prevail, it is combined with a desire to eclipse the worth, or to deduct from the excellence of those above, or those on a level of ability or merit with itself. Hence, if we would eradicate every propensity to detraction, it is essentially requisite that we cultivate a humble spirit, and that, impressed with a consciousness of our own unworthiness, we learn to think and to speak of others more justly as well as more charitably. Some persons of mean talents, slender capacity, grovelling desires, or little industry, who are too timid to undertake any thing good or great, or too feeble or too indolent to execute it, are continually endeavoring to screen themselves from contempt, or to hide their own individual insignificance by depreciating the worth, railing at the audacity, or ridiculing the exertions of those who have more ability, more en-

terprise, more intellect, and more activity than themselves. There is no integrity, however pure, no worth, however genuine, which is not exposed to invidious obscurity, to unjust surmises, and wily misrepresentation; and designing and interested men, who abound in the wisdom of this world, well know how to convert these practices to their own advantage, and to the injury of their neighbor. If detraction be found in a greater degree, or of a more mischievous kind, in a court than in a village, it is only because in the former there is a stronger incitement to its exercise, and more ample space for its operations. Detraction tends to reduce the best men to a level with the worst, and thus to bring worth itself into disrepute. It tends to chill the ardor of doing good, and to produce a general belief that all the virtue which exists among men is imaginary and counterfeit. It involves in itself a high degree of depravity, and is connected with the violation of every moral tie. Is it not adverse to justice? Is it not incompatible with charity? Is it not a plain dereliction of our duty to God? For is it not principally occupied in lessening the estimation of the good and wise, who are more especially the objects of his favor, and the excellence of his rational creation? Must not the practice, therefore, bring us under the divine displeasure? Is there not in the habit so large a mixture of malevolence as necessarily implies that we are strangers to the love of God; and, if we will persist in so hateful a practice, can we hope to escape that place of torment in which there are weeping and gnashing of teeth? (*Fellowes's Body of Theology*, ii, 852, 867; *Warner's System of Divinity and Morality*, ii, 90)."—Robinson, *Theol. Dict.* s. v.

Deu'el (Heb. *Deuel*, דְּעוּאֵל, according to Gesenius, *invocation of God*; according to Fürst, *acquainted with God*; Sept. Παγούηλ; Vulg. *Dehuel*), father of Eliasaph, the "captain" (דָּבָר) of the tribe of Gad at the time of the numbering of the people at Sinai (Num. i, 14; vii, 42, 47; x, 20). B.C. ante 1657. The same man is mentioned again in ii, 14, but here the name appears as REUEL (q. v.), owing to an interchange of the two very similar Hebrew letters ד and ר. In this latter passage the Samaritan, Arabic, and Vulg. retain the D; the Sept., as in other places, has R. The greater weight of evidence is therefore in favor of the reading "Deuel" in both passages. Fürst ingeniously suggests (*Heb. Handw.* p. 304) that the name may have been originally *Daruel* (דָּרְעוּאֵל), which would explain the various reading.

Deurhoff, WILLIAM, was born at Amsterdam in 1650. He did not follow any particular course of study, received no regular education, and followed the business of basket-making during his whole life, yet made himself a name by the originality and vigor of his reasoning faculties. He died in 1717. While following his daily vocations, he studied philosophy and theology, yet without any system or method. Among the philosophers he followed more especially Spinoza and Des Cartes, particularly the latter; yet he thought he could improve on Des Cartes's system. The peculiar philosophico-theological system which he thus originated is presented explained in his various writings, which, however, are now become scarce, and contain, besides, many heterodox principles. See Bruckeri *Historia Philosophiæ* (tom. iv, pt. ii, Lpz. 1744, p. 291, 704, 720); Herzog, *Real-Encyklop.* iii, 868.

Deusdedit, or **Deodätus**, POPE, succeeded Boniface IV, 615, and died 618. His reign is marked by quite wonderful miracles, and by false decretals. His name is among the *saints* (Nov. 9).

Deus misereatur (*God have mercy*), the Latin name of the sixty-seventh psalm, derived from its first words, which, in the Church of England, may be used in the evening prayer, after the second lesson, instead of the *nunc dimittis*, except on the twelfth day of the

month, on which it occurs among the psalms for the day.—Hook, *Church Dictionary*, s. v.

Deusing, HERMAN, son of Anthony Deusing, a distinguished physician, mathematician, and professor, was born in Groningen, March 14, 1654. He was bred to the profession of law, but, taking a dislike to it, he relinquished it, and devoted himself exclusively to theological studies. In 1690 he published his *Historia allegorica Veteris et Novi Testamenti, juncta revelatione mysterii s. s. triados*. By this work he made himself known as a typical and mystical theologian. The typical interpretation of the Scriptures was pushed to its extreme limits. The doctrine of the Trinity was allegorically explained. The result was, that he was accused of heresy, and debarred from the Lord's Supper. He wrote two works in his own defence, one in Dutch and the other in Latin. In 1700 appeared his *Commentarius mysticus in decalogum et explicatio mystica tum historia de muliere hamorrhœisa et filia Jaisri, tum parabolas de Epulone divite et Lazaro mendico*. In 1712 he gave to the world his *Mysterium s. s. triados*, in which he fully developed his allegorical views of this doctrine. He also contributed several exegetical articles to the *Bibliotheca Bremensis*. He gradually receded from his extreme views. The Groningen Consistory repealed the sentence of suspension that they had passed against him. He now connected himself with the Walloon Church. He was permitted to spend the remainder of his days in peace, and he died January 8, 1722, in the city of his birth.

Deutero-Canonical BOOKS OF THE OLD TESTAMENT, a term applied in modern times to denote those sacred books which, originally denominated *ecclesiastical* and *apocryphal*, were not in the Jewish or Hebrew Canon, but, as being contained in the old Greek versions, were publicly read in the early Christian Church. See APOCRYPHA. For the suspected books of the *New Testament*, see ANTILEGOMENA.

1. It is acknowledged by all that these books never had a place in the Jewish Canon. The Roman Catholic professor Alber, of Pesth (who considers them as of equal authority with the received books of the Hebrew Canon), observes: "The Deutero-canonical books are those which the Jews had not in their Canon, but are, notwithstanding, received by the Christian Church, concerning which, on this very account of their not having been in the Jewish Canon, there has existed some doubt even in the Church" (*Institut. Hermeneut.* vol. 1, ch. viii, ix). Josephus, a contemporary of the apostles, after describing the Jewish Canon (*Apion*, i, 8), which he says consists of twenty-two books, remarks: "But from the reign of Artaxerxes to within our memory there have been several things committed to writing which, however, have not acquired the same degree of credit and authority as the former books, inasmuch as the tradition and succession of the prophets were less certain." It has been shown by Hornemann (*Observat. ad illust. doctr. de Canon. V. T. ex Philone*) that, although Philo was acquainted with the books in question, he has not cited any of them, at least with the view of establishing any proposition.

2. Among the early Christian writers, Jerome, in his Prefaces, gives us the most complete information that we possess regarding the authority of these books in his time. After enumerating the twenty-two books of the Hebrew Canon, consisting of the Law, the Prophets, and the Hagiographa, he adds: "This prologue I write as a preface to the books to be translated by us from the Hebrew into Latin, that we may know that all the books which are not of this number are *apocryphal*; therefore Wisdom, which is commonly ascribed to Solomon as its author, and the book of Jesus the son of Sirach, Judith, Tobit, and the Shepherd, are not in the Canon." Again, in the preface to his edition of the books of Solomon from the Hebrew,

he observes: "These three books (Proverbs, Ecclesiastes, and Canticles) only are Solomon's. There is also the *Book of Jesus the son of Sirach*, and another pseud-epigraphal book, called the *Wisdom of Sirach*, the former of which I have seen in Hebrew, called *Wisdom of Ecclesiasticus*, as among the Latins, but the latter with which likewise have been joined Ecclesiastes and the Song of Songs, that the collection might the more resemble the books of Solomon both in matter and design. The second is not to be found at all among the Hebrews, and the style plainly evinces its Greek origin: some ancient writers say it is a work of Pseudo-Jew. As, therefore, the Church reads Judith, Tobit, and the books of Maccabees, but does not read them among the Canonical Scriptures, so likewise may read these two books for the edification of the people, but not as of authority for proving any doctrine of religion (*ad adificationem plebis, non ad auctoritatem ecclesiasticorum dogmatum confirmandam*)." Of his own he says that he does "not translate it because it was not in Hebrew, nor received by the Jews." It is never translated Wisdom, Ecclesiasticus, or either of the books of Maccabees, and observes that "these books are not of the twenty-four letters, are utterly rejected" (*Prof. ad Esram*). In his Preface to Judith he says, in like manner, "Among the Hebrew this book is read among the *hagiographa* (or, according to some manuscripts, *apocrypha*), whose authority is not judged sufficient to support disputed matters. He adds, at the same time, that "the Council of Nice is said to have included it in the catalogue of the Canonical Scriptures." We have, however, no authority for supposing that the Council of Nice ever formed such a catalogue. There is no account of the matter in any of its acts which have reached us. There is, indeed, a catalogue, as is observed by Mr. Jones, attributed by Pappus, in his *Synodicon*, to this council, with this relation: "That the bishops there assembled were, by a very extraordinary miracle, convinced which were inspired and which were apocryphal books, after this manner: Having put all the books that had claim to inspiration under the communion-table (*ἐπὶ θείᾳ ἁρακίᾳ*) in a church, they prayed to God that those which were of divine inspiration might be found above or upon the table, and those which were apocryphal might be found under; and, accordingly, as they prayed, it came to pass." This is universally acknowledged to be a fable, and cardinal Bellarmine (*De Verbo Dei*) admits that there could have been no canon determined on by the Nicene Council, as in that case none would have ventured to reject it; but he supposes that Jerome may have found in some of its acts, now lost, some citation from the book of Judith. Bellarmine further admits that in Jerome's time the ecclesiastical books, although read in the churches, were neither in the Jewish nor Christian Canon, inasmuch as no general council had yet determined anything concerning them.

Rufinus made the same distinction with regard to the books of Scripture that Jerome did. After enumerating the books of the Old and New Testaments exactly according to the Jewish Canon, saying, "These are the volumes which the fathers have included in the Canon, and out of which they would have us prove the doctrines of our faith," he adds, "however, it ought to be observed that there are also other books which are not canonical, but have been called by our forefathers *ecclesiastical*, as the Wisdom of Solomon, and another called the Wisdom of the Son of Sirach, which among the Latins is called by the general name of Ecclesiasticus, by which title is denoted not the author of the book, but the quality of the writing. Of the same order is the book of Tobit, Judith, and the books of the Maccabees. In the New Testament is the book of the Shepherd of Hermas, which is called 'Two Ways, of the Judgment of Peter;' all which they would have to be read in the churches, but not alleged by way of

Council of Carthage, held in the year 419. The reference said to have been made from the *third* Council of Carthage, held in 397, to pope Boniface, is a manifest anachronism in the copies of the acts of this council (see L'Abbe's *Concilia*), as the pontificate of Boniface did not commence before 417. It has therefore been conjectured that this reference belongs to the fourth council.

As St. Augustine had great influence at these Councils, it must be of importance to ascertain his private sentiments on this subject. This eminent man, who was born in 354, consecrated bishop of Hippo (the present Bona) in 395, and died in 430, in the seventy-sixth year of his age, writes as follows in the year 397 :

"The entire Canon of Scripture is comprised in these books. There are 5 of Moses, viz. Genesis, Exodus, Leviticus, Numbers, Deuteronomy; 1 of Joshua, 1 of Judges, 1 small book called Ruth, which seems rather to belong to the beginning of the Kingdoms, the 4 books of the Kingdoms, and 2 of the Remains, not following one another, but parallel to each other. These are historical books which contain a succession of times in the order of events. There are others which do not observe the order of time, and are unconnected together, as Job, Tobit, Esther, and Judith, the 2 books of Maccabees, and the 2 books of Ezra, which last do more observe the order of a regular succession of events, after that contained in the Kingdoms and Remains. Next are the Prophets, among which is 1 book of the Psalms of David, and 5 of Solomon, viz. Proverbs, Canticles, and Ecclesiastes; for these 2 books, Wisdom and Ecclesiasticus, are called Solomon's for no other reason than because they have a resemblance to his writings: for it is a very general opinion that they were written by Jesus the son of Sirach; which books, however, since they are admitted into authority, are to be reckoned among prophetic books. The rest are the books of those who are properly called prophets, as the several books of the 12 Prophets, which being found together, and never separated, are reckoned 1 book. The names of which prophets are these: Hosea, Joel, Amos, Obadiah, Jonah, Micah, Nahum, Habakkuk, Zephaniah, Haggai, Zechariah, Malachi. After these the four Prophets of large volumes, Isaiah, Jeremiah, Daniel, Ezekiel. In these 44 books is comprised all the authority of the Old Testament" (*De Doctr. Christ.*). [For the New, see ANTILOGOMENA; they are the same with those now received.]

It has, indeed, been maintained that Augustine altered his opinion on the subject of the deuterocanonical books in his Retractions (see Henderson *On Inspiration*, p. 495); but the only passage in this work bearing on the subject, which we can discover, is that wherein he confesses his mistake in terming Ecclesiasticus a *prophetic* book. Augustine has also been supposed to have testified to the inferior authority of these books, from his saying that one of them was read from the *reader's* place. "The sentiment of the book of Wisdom is not to be rejected, which has descended to be recited for such a long course of years from the *step of the readers* of the Church of Christ, and to be heard with the veneration of divine authority from the bishop to the humblest of the laics, faithful, penitents, and catechumens."

What the result of the reference from Africa to the "churches beyond the seas" may have been, we can only judge from the letter which is said to have been written on the subject by Innocent I, bishop of Rome, to St. Exupere, bishop of Toulouse, in the year 405. In this letter, which, although disputed, is most probably genuine, Innocent gives the same catalogue of the books of the Old and New Testaments as those of the councils of Hippo and Carthage, omitting only the book of Esther.

The next catalogue is that of the Roman Council, drawn up by pope Gelasius and seventy bishops. The genuineness of the acts of this council has been questioned by Pearson, Cave, and the two Basnages, but vindicated by Pagi and Jeremiah Jones. The catalogue is identical with the preceding, except in the order of the books.

Some of the most important manuscripts of the Holy Scriptures which have descended to us were written soon after this period. The very ancient Alexandrian MS. now in the British Museum contains the following books in the order which we here give them, together with the annexed catalogue: "Genesis, Exodus,

Leviticus, Numbers, Deuteronomy, Joshua, Judges, Ruth—8 books. Kingdoms, 4; Remains, 2—6 books. Sixteen Prophets, viz. Hosea, 1; Amos, 2; Micah, 3; Joel, 4; Obadiah, 5; Jonah, 6; Nahum, 7; Amos, 8; Zephaniah, 9; Haggai, 10; Zechariah, 11; Malachi, 12; Isaiah, 13; Jeremiah, 14; Ezekiel, 15; Daniel, 16; Esther; Tobit; Judith; Ezra, 2; Maccabees, 4; Psalter and Hymns; Job; Proverbs; Ecclesiastes; Canticles; Wisdom; Wisdom of Jesus Smech; 4 Gospels; Acts, 1; 7 Catholic Epistles; 14 Epistles of Paul; Revelation; 2 Epistles of Clement; together . . . books; Psalms of Solomon." These books are equally incorporated in all the manuscripts of the Latin Vulgate (which was originally translated from the Septuagint). Those which Jerome did not translate from the Hebrew or Greek, as Wisdom and Ecclesiasticus, were adopted from the older Latin version.

Although the Canon of Scripture seemed now to be so far settled by the decrees of these councils, all did not conceive themselves bound by them; and it is observed by Jahn (*Introd.*) that they were not otherwise to be understood than "that the ecclesiastical books enumerated in this catalogue were to be held as useful for the edification of the people, but not to be applied to the confirmation of doctrines of faith." Such appears at least to have been the sentiment of many eminent divines during this period and the 16th century.

8. Bishop Cosin, in his excellent *Scholastic History of the Canon*, furnishes to this effect a host of quotations from writers of the Middle Ages, including Va. Bede, John of Damascus, Alcuin, Peter Mauriac, Hugh de St. Victor, cardinal Hugo de St. Cher, the author of the ordinary *Gloss*, and Nicholas Lyranus. Of these, some call the deuterocanonical books "excellent and useful, but not in the Canon;" others speak of them as "apocryphal, that is, doubtful Scriptures," as not having been "written in the time of the prophets, but in that of the priests, under Ptolemy," &c. as not "equalling the sublime dignity of the other books, yet deserving reception for their laudable instruction," classing them with the writings of Jerome, Augustine, Ambrose, and Bede, and making a marked distinction not only between the Jewish and Christian Canons, but even between parts of the deuterocanonical writings. Dr. Archibald Alexander also (*Canon of the Old and New Testament ascertained*) cites several of the same authorities; he has, however, in one instance, evidently mistaken Peter Lombard for Peter Comestor, the author of *Scholastic History*. At the era of the Reformation we find Faber, Stapulensis, and cardinal Cajetan expressing themselves to the same effect, and the learned Sanctes Pagmini, in his translation of the Bible from the original languages, published at Lyons in 1528 (the first Bible that contained the division into verses with the present figures), dedicated to pope Clement VII, distinguished the ecclesiastical books, which he says were not in the Canon, by the term *Hagiographa*. For a description of this rare work, see *Christian Remembrancer*, iv, 419, is a treatise *On the division of verses in the Bible*, by Rev. W. Wright, LL.D.

4. We now arrive at the period of the Reformation when the question of the Canon of Scripture was warmly discussed. Long before this period (viz. in 1380), Wickliffe had published his translation of the Bible, in which he substituted another prologue for Jerome's; wherein, after enumerating the "twenty-five" books of the Hebrew Canon, he adds: "Whatever book is in the Old Testament, besides these twenty-five, shall be set among the Apocrypha, that is, without authority of belief." He also, in order to distinguish the Hebrew text from the Greek interpolations, inserted Jerome's notes, *rubricated*, into the body of the text.

Although Martin Luther commenced the publication of his translation of the Bible in 1522, yet, as it was

lished in parts, he had not yet made any distinction between the two classes of books, when Lonicer published his edition of the Greek Septuagint at Strasburg in 1526, in which he separated the Deutero-canonical, or Apocryphal, books from those of the Jewish canon, for which he was severely castigated by Moccus (see Masch's edition of Le Long's *Bibliotheca biblica*, ii, 268). Arias Montanus went still further, and rejected them altogether. In 1584 the complete edition of Luther's Bible appeared, wherein those books which Jerome had placed *inter apocrypha* were separated, and placed by themselves between the Old and New Testament, under the title "Apocrypha; that is, books which are not to be considered as equal to holy scripture, and yet are useful and good to read."

A few years after, the divines of the Council of rent assembled, and among the earliest subjects of their deliberation was the Canon of Scripture. "The Canon of Augustine," says bishop Marsh, "continued to be the canon of the ruling party. But as there were not wanting persons, especially among the learned, who from time to time recommended the Canon of Jerome, it was necessary for the Council of Trent to decide between the contending parties (*Comparative View*, p. 97). The Tridentine fathers had consequently a nice and difficult question to determine. On the 11th of April, 1648, all who were present at the fourth session of the Council of Trent adopted the Canon of Augustine, declaring, "He also is to be anathema who does not receive these entire books, with all their parts, as they have been accustomed to be read in the Catholic Church, and are found in the ancient editions of the Latin Vulgate, as sacred and canonical, and who knowingly and wilfully despises the aforesaid traditions . . ." We are informed by Jahn (*Introduction*) that this decree did not affect the distinction which the learned had always made between the canonical and deutero-canonical books, in proof of which he refers to the various opinions which still prevail in his church on the subject, Bernard Lamy (*Apparatus Biblicus*, ii, 5) denying, and Du Pin (*Prolegomena*) asserting, that the books of the second canon are of equal authority with those of the first. Those who desire further information will find it in the two accounts of the controversies which took place at the council on this subject—one from the pen of cardinal Pallavicini, the other by father Paul Sarpi, the two eminent historians of the council. Professor Alber, to whom we have already referred, having denied that any such distinction as that maintained by his brother professor, Jahn, can lawfully exist among Roman Catholic divines, insists that both canons possess one and the same authority. The words of Bernard Lamy, however, cited by Jahn, are—"The books of the second canon, although united with the first, are not, however, of the same authority" (*Apparat. Bibl.* ii, 5, p. 833). Alber endeavors to explain this as meaning only that these books had not the same authority before the Canon of the Council of Trent, and cites a passage from Pallavicini to prove that the anathema was "directed against those Catholics who adopted the views of cardinal Cajetan" (ii, 105). But, however this may be, among other opinions of Luther condemned by the council was the following: "That no books should be admitted into the Canon of the Old Testament but those received by the Jews; and that from the New should be excluded the Epistle to the Hebrews, those of James, 2 Peter, 2 and 3 John, Jude, and the Apocalypse." The whole of the books in debate, with the exception of 3d and 4th Esdras, and the Prayer of Manasse, are considered as canonical by the Council of Trent. But it must be recollected that the decision of the Council of Trent is one by no means peculiar to this council. The third Council of Carthage had considered the same books canonical. "The Council of Trent," says bishop Marsh, "declared no other books to be sacred and canonical than such as

had existed from the earliest ages of Christianity, not only in the Latin version of the Old Testament, but even in the ancient Greek version, which is known by the name of the Septuagint. . . . In the manuscripts of the Sept. there is the same intermixture of canonical and apocryphal books as in the manuscripts of the Latin version" [although there are in different manuscripts variations in the particular arrangement of single books]. "The Hebrew was inaccessible to the Latin translators in Europe and Africa during the first three centuries." The ecclesiastical books were generally written within a period which could not have extended to more than two centuries before the birth of Christ. In the choice of the places which were assigned them by the Greek Jews resident in Alexandria and other parts of Egypt, who probably added these books to the Sept. version according as they became gradually approved of, they were directed "partly by the subjects, partly by their relation to other writings, and partly by the periods in which the recorded transactions are supposed to have happened." Their insertion shows how highly they were esteemed by the Greek Jews of Egypt; but whether even the Egyptian Jews ascribed to them canonical and divine authority it would not be easy to prove (Marsh's *Comparative View*).

The following were the proceedings of the Anglican Church in reference to this subject: In Coverdale's English translation of the Bible, printed in 1535, the deutero-canonical books were divided from the others and printed separately, with the exception of the book of Baruch, which was not separated from the others in this version until the edition of 1550. They had, however, been separated in Matthew's Bible in 1537, prefaced with the words, "the volume of the book called *Hagiographa*." This Bible contained Olivetan's preface, in which these books were spoken of in somewhat disparaging terms. In Cramer's Bible, published in 1559, the same words and preface were continued; but in the edition of 1649 the word *Hagiographa* was changed into *Apocrypha*, which passed through the succeeding editions into King James's Bible. Olivetan's preface was omitted in the Bishop's Bible in 1568, after the framing of the canon in the Thirty-nine Articles in 1562. In the Geneva Bible, which was the popular English translation before the present authorized version, and which was published in 1559, these books are printed separately with a preface, in which, although not considered of themselves as sufficient to prove any point of Christian doctrine, they are yet treated with a high degree of veneration. In the parallel passages in the margin of this translation, references are made to the deutero-canonical books. In the first edition of the Articles of the Church of England, 1552, no catalogue of the "Holy Scripture" had yet appeared, but in the Articles of 1562 the Canon of St. Jerome was finally adopted in the following order: 5 books of Moses, Joshua, Judges, Ruth, 1 and 2 Samuel; 1 and 2 Kings, 1 and 2 Chronicles, 1 and 2 Esdras, Esther, Job, Psalms, Proverbs, Ecclesiastes, Cantica, four Prophets the Greater, twelve Prophets the Less. In the 6th Article it is declared that "in the name of the Holy Scripture we do understand those canonical books of the Old and New Testament, of whose authority was never any doubt in the Church," and that "the other books (as Jerome saith) the Church doth read for example of life and instruction of manners, but yet it doth not apply them to establish any doctrine." The books which the article then enumerates are 1 and 2 [3 and 4] Esdras, Tobias, Judith, the rest of the book of Esther, Wisdom, Jesus the son of Sirach, Baruch the Prophet, the Song of the Children, the Story of Susanna, Bel and the Dragon, the Prayer of Manasse, and 1 and 2 Maccabees. It is not, however, altogether correct, in point of fact, in including in the number of books thus referred to by Jerome as read by the Church for edification the third and fourth

books of Esdras. These books were equally rejected by the Church of Rome and by Luther, who did not translate them. The Church of England further declares that "all the books of the New Testament, as they are commonly received, we do receive and account them canonical." The Church of England has herein followed the Councils of Hippo and Carthage. The phrase "of whose authority was never any doubt in the Church," refers therefore more strictly to the books of the Old Testament than the New, for we have already seen that doubts *did* exist respecting the *AXILEGOMENA* of the New Testament. In the first book of Homilies, published in 1547, and the second in 1560, both confirmed by the Thirty-fifth Article of 1562, the deuterocanonical books are cited as "Scripture," and treated with the same reverence as the other books in the Bible, and in the preface to the book of Common Prayer they are alluded to as being "agreeable to" the Holy Scriptures.

The Helvetic Confession, dated 1st of March, 1566, has the following expression respecting the apocryphal books: "We do not deny that certain books of the Old Testament were named by the ancients apocryphal, by others ecclesiastical, as being read in the churches, but not adduced for authority in matters of belief; as Augustine, in the 18th book of the *City of God*, ch. xxxviii, relates that the names and books of certain prophets were adduced in the books of Kings, but adds that these were not in the Canon, and that those we have were sufficient for piety." The Confession of the Dutch churches (dated the same year) is more full. After recounting the canonical books, "respecting which no controversy existed," it adds, "We make a distinction between these and such as are called apocryphal, which may indeed be read in the Church, and proofs adduced from them, so far as they agree with the canonical books; but their authority and force are by no means such that any article of faith may be certainly declared from their testimony alone, still less that they can impugn or detract from the authority of the others." They add, as their reason for receiving the canonical books, that "it is not so much because the Church receives them, as that the Holy Spirit testifies to our consciences that they have come from God; and chiefly on this account, because they of themselves bear testimony to their own authority and sanctity, so that even the blind may see the fulfilment of all things predicted in them, as it were with the senses."

The Westminster Confession proceeded on the same principle, but treated the books of the second canon with less ceremony. After enumerating the canonical books (ascribing thirteen epistles only to Paul), they proceed to say that "books called Apocrypha, not being of divine confirmation, are no part of the Canon of Scripture, and therefore of no authority in the Church of God, nor to be any otherwise approved or made use of than other human writings." And again: "The authority of Holy Scripture, for which it ought to be believed and obeyed, depended not on the testimony of any man or Church, but wholly upon God, the author thereof, and therefore it is to be received because it is the Word of God. We may be moved and induced by the Church to a high and reverent esteem of the Holy Scriptures; and the heavenliness of the matter, the efficacy of the doctrine, the majesty of the style, etc., are arguments whereby it doth abundantly evidence itself to be the Word of God; yet, notwithstanding, our full persuasion and assurance of the infallible truth and divine authority thereof is from the inward work of the Holy Spirit, being witness by and with the Word in our hearts."

Luther (on 1 Cor. iii, 9, 10) had declared that the *touchstone* by which certain Scriptures should be acknowledged as divine or not was the following: "Do they preach Jesus Christ or not?" And, among the moderns, Dr. Twisten (*Vorlesungen über die Dogmatik*,

1829, i, 421 sq.) has maintained a somewhat similar principle (see Gausson's *Theopneustia*). The Cession of Augsburg, dated in 1531, contains no article whatever on the Canon of Scripture; nor do the Lutherans appear to have any other canon than Luther's Bible. For the sentiments of the Greek Church, see *ESDRAS*; *ESTHER*; *MACCABEES*.

¶ We shall add a few words on the grounds on which authorities adopted by different parties for deciding whether a work is canonical or not. Mr. Jeremias Jones furnishes us with three different views on this subject. "The first," he says, "is the opinion of the Papists, who have generally affirmed, in their controversies with the Protestants, that the authority of the Scriptures depends upon, or is derived from, the power of their Church. By the authority of the Church those authors plainly mean a power lodged in the Church of Rome and her synods, of determining what books are the word of God, than which nothing can be more absurd or contrary to common sense; for, if so, it is possible, nay, it is easy for them to make a book which is not divine to be so." And he maintains that "it is possible, on this principle, that *Esop's fables*, or the infidel books of *Celsus*, *Julian*, and *Paphry*, might become a part of the New Testament." But the fact must not be lost sight of that the Church has never pretended to exercise a power of this description. Bishop Marsh, referring to this subject observes: "That the Council of Trent assumed the privilege of raising to the rank of canonical authority what was generally acknowledged to have no such authority, is a charge which cannot be made without injustice; the power of declaring canonical a book which has never laid claim to that title is a power not exercised even by the Church of Rome. In this respect it acts like other churches; it sits in judgment on existing claims, and determines whether they are valid or not." From certain expressions of divines, who have asserted that the Scriptures would have no authority whatever without the testimony of the Church, it has been supposed that they ascribed to the Church an arbitrary power over these divine books; Bellarmine, therefore, has drawn a distinction between the objective and subjective authority of the Scriptures, their authority in themselves, and that which they have in respect to us. Thus Augustine said that he would not believe the Gospel but for the authority of the Church, adding, however, that the invitation of the Church was but the first step to his complete illumination by the Spirit of God (*Confessions*, ii, 8).

Another principle was that adopted by all the reformed communions (except the Anglican Church), viz., to use Mr. Jones's words, that "*there are inward or innate evidences in the Scriptures, which, applied by the illumination or testimony of the Holy Spirit, are the only true proofs of their being the Word of God*;" or to use the words of the French reformed communion in its Confession, which harmonize with the method adopted by the Scotch and Belgian communions, that upon the internal persuasion of the Spirit they bear the Canonical from Ecclesiastical, i. e. *Apocryphal* basis. This method Mr. Jones thinks to be of a very extraordinary nature. "Can it be supposed," he asks, "that out of ten thousand books, private Christians, or even our most learned reformers, should by any internal evidence agree precisely on the number of twenty-seven, which are now esteemed canonical, indeed thereto by some characters those books contain, of their being written by the inspiration of the Holy Ghost?" This he conceives to be folly and madness, and an assumption of "immediate inspiration." "It first supposes the books to be inspired, and then prove that they are so because they are so." This is only an argument, says bishop Burnet, to him that feels it, if it be one at all. "For my part," said the celebrated Richard Baxter, "I confess I could never boast of any such testimony or light of the Spirit, nor reason ne-

er, which, without human testimony, would have made me believe that the book of Canticles is canonical and written by Solomon, and the book of Wisdom apocryphal and written by Philo. Nor could I have known any historical books, such as Joshua, Judges, Ruth, Samuel, Kings, Chronicles, Ezra, Nehemiah, etc., to be written by divine inspiration, but by tradition, etc.

The third method is that approved of by Mr. Jones, i. e. that tradition, or the testimony of the ancient Christians, preserved in their writings, is the best method of determining this subject. "This," adds Mr. Jones, "is the method the first Christians constantly made use of to prove, against the heretics, the truth of the sacred books, viz. by appealing to that certain and undoubted tradition which assured them they were the writings of the persons whose names they bear. Thus we know that Ovid, Virgil, or Livy wrote the books under their names." To this, we think, might have been added internal evidence and the application of critical skill. The chief objection which has been urged against this method is, that it leaves the canonicity of each book to the decision of every private individual, which is inconsistent with the idea of a canon. Certain it is that the ancient Church, in deciding on the present Canon, exhibited a wonderful theological tact, as the books which it has handed down as canonical, and these alone, are generally the same which, after having undergone the strictest ordeal that the learning and acumen of modern times have been enabled to apply to them, are acknowledged by the best critics to be authentic. In fact, the Church has adopted the same methods for this purpose which Mr. Jones has considered to be the only ones satisfactory to private individuals. Christians are thus in possession of the highest degree of satisfaction. Mr. Gausen (*Theopneustia*, p. 840) admits that the principle laid down by the reformed churches is untenable, and he substitutes for it "for the Old Testament, the Testimony of the Jews, and for the New, the Testimony of the Catholic Church; by which he understands, the general consent, in regard to the former, of all Jews, Egyptians and Syrians, Asiatics and Europeans, ancient and modern, good and bad; and by the testimony of the Catholic Church he understands "the universal consent of ancient and modern churches, Asiatic and European, good and bad; that is, not only the sections which have adhered to the Reformation, but the Greek section, the Armenian section, the Syrian section, the Roman section, and the Unitarian section." And in p. 842, 845, he ascribes entire infallibility to both Jewish and Christian churches in respect to the Canons of Scripture. "The Jews could not introduce a human book into the Old Testament, and neither the Council of Trent, nor even the most corrupt and idolatrous churches, could add a single apocryphal book to the New. . . . It was not in their power not to transmit them intact and complete. In spite of themselves it was so ordered," etc.

The question, however, in dispute is not so much with regard to the Jewish Canon, regarding which no controversy exists, as whether there is or is not sufficient testimony to the fact how far our Saviour and his apostles gave the stamp of their authority to any books not contained in this Canon. We have no certain evidence as to the authority on which, or the time when, the Jewish Canon was collected (see EZRA), or of the cause of its closing, and our best evidence in favor of the canonicity of the Hebrew Scriptures rests on the authority of Christ as contained in the Scriptures of the New Testament. (Comp. in addition to the works already cited, Vicenzi's *Introductio in Scrip. Deutero-canon.* Rome, 1842; Keerl, *Die Apokryphenfrage aufs Neue beleuchtet*, Lips. 1855; Stier, *Letztes Wort über die Apokryphen*, Lpz. 1865; Stowe, in the *Biblioth. Sacra*, April, 1864. Wahl has published an excellent *Clavis Librorum V. T. Apoc. philologica*, Lips. 1853).—Kitto, s. v. See CANON.

Deuteronomy (In Heb. the title is taken, like most of the other books, from the initial words, אֵלֶּיךָ דְּבָרַיִם, "These are the words," or simply דְּבָרַיִם, "Words;" in the Sept. Δευτερονόμιον, *second law*, as being a repetition of the Law; Vulg. *Deuteronomium*: called also by the later Jews מִשְׁנֵה דְּוָרָהוּרָה, *duplicate of the Law*, and סֵפֶר הַחֻקִּים, *book of admonitions*), the fifth book of Moses, or the last of the Pentateuch. It gives an account of the sublime and dignified manner in which Moses terminated that work, the accomplishment of which was his peculiar mission, and intersperses several additional items of history in the recapitulation of his public career. It forms a sacred legacy which he here bequeathed to his people, and very different from those laws which he had announced to them at Sinai. The tone of the law falls here considerably in the background, and the *subjectivity* (individuality) of the Lawgiver, and his peculiar relation to his people, stand out more prominently. A thoroughly sublime and prophetic spirit pervades all its speeches from beginning to end. The thoughts of the man of God are entirely taken up with the inward concerns of his people, their relations, future fate, and eventful vicissitudes. The Lawgiver here stands amid Israel, warning and consoling, commanding and exhorting, surveying and proclaiming the future with marvellous discernment.

I. *Contents*.—The book consists chiefly of three discourses delivered by Moses shortly before his death. They were spoken to all Israel in the plains of Moab, on the eastern side of the Jordan (i, 1), in the eleventh month of the last year of their wanderings, the fortieth year after their exodus from Egypt (i, 8). Subjoined to these discourses are the Song of Moses, the Blessing of Moses, and the story of his death.

1. *The first Discourse* (i, 1-iv, 40).—After a brief historical introduction (i, 1-5), the speaker recapitulates the chief events of the past forty years in the wilderness, and especially those events which had the most immediate bearing on the entry of the people into the promised land. He enumerates the contests in which they had been engaged with the various tribes who came in their way, and in which their success had always depended upon their obedience; and reminds them of the exclusion from the promised land, first of the former generation because they had been disobedient in the matter of the spies, and next of himself, with whom the Lord was wroth for their sakes (iii, 26). On the appeal to the witness of this past history is then based an earnest and powerful exhortation to obedience; and especially a warning against idolatry as that which had brought God's judgment upon them in times past (iv, 8), and would yet bring sorer punishment in the future (iv, 26-28). To this discourse is appended a brief notice of the severing of the three cities of refuge on the east side of the Jordan (iv, 41-43).

2. *The second Discourse* is introduced, like the first, by an explanation of the circumstances under which it was delivered (iv, 44-49). It extends from ch. v, 1, to xxvi, 19, and contains a recapitulation, with some modifications and additions, of the Law already given on Mount Sinai. Yet it is no bare recapitulation or naked enactment, but every word shows the heart of the lawgiver full at once of zeal for God and of the most fervent desire for the welfare of his nation. It is the father no less than the legislator who speaks; and while obedience and life are throughout bound up together, it is the obedience of a loving heart, not a service of formal constraint which is the burden of his exhortations. The following are the principal heads of discourse:

a. He begins with that which formed the basis of the whole Mosaic code—the Ten Commandments—and impressively repeats the circumstances under which they were given (v, 1-vi, 8).

b. Then follows an exposition of the spirit of the First Table. The love of Jehovah who has done so great things for them (vi), and the utter uprooting of all idol-worship (vii), are the points chiefly insisted upon. But they are also reminded that if idolatry be a snare on the one hand, so is self-righteousness on the other (viii, 10 sq.), and therefore, lest they should be lifted up, the speaker enters at length on the history of their past rebellions (ix, 7, 22-24), and especially of their sin in the matter of the golden calf (ix, 9-21). The true nature of obedience is again emphatically urged (x, 12-xi, 32), and the great motives to obedience set forth in God's love and mercy to them as a people (x, 15, 21, 22), as also his signal punishment of the rebellious (xi, 3-6). The blessing and the curse (xi, 26-32) are further detailed.

c. From the general spirit in which the law should be observed, Moses passes on to the several enactments. Even these are introduced by a solemn charge to the people to destroy all objects of idolatrous worship in the land (xii, 1-3). They are, upon the whole, arranged systematically. We have first the laws touching religion; then those which are to regulate the conduct of the government and the executive; and, lastly, those which concern the private and social life of the people. The whole are framed with express reference to the future occupation of the land of Canaan.

(1.) *Religious Statutes* (xii-xvi, 17).—There is to be but one sanctuary where all offerings are to be offered. Flesh may be eaten anywhere, but sacrifices may only be slain in "the place which the Lord thy God shall choose" (xii, 5-32). All idol prophets, all enticers to idolatry from among themselves, even whole cities if idolatrous, are to be cut off (xiii), and all idolatrous practices to be eschewed (xiv, 1, 2). Next come regulations respecting clean and unclean animals, tithe, the year of release, and the three feasts of the Passover, of Weeks, and of Tabernacles (xiv, 8-xvi, 17).

(2.) *Governmental and Executive Functions* (xvi, 18-xxi, 23).—The laws affecting public personages and defining the authority of the judges (xvi, 18-20) and the priests (xvii, 8-18), the way of proceeding in courts of justice (xvii, 1-18); the law of the king (xvii, 14-20), of the priests, and Levites, and prophets (xviii); of the cities of refuge and of witnesses (xix). The order is not very exact, but, on the whole, the section xvi, 18-xix, 21, is *judicial* in its character. The passage xvi, 21-xvii, 1, seems strangely out of place. Baumgarten (*Comm.* in loc.) tries to account for it on the ground of the close connection which must subsist between the true worship of God and righteous rule and judgment. But who does not feel that this is said with more ingenuity than truth?

Next come the laws of war (xx), both as waged (a) generally with other nations, and (b) especially with the inhabitants of Canaan (ver. 17).

(3.) *Private and Social Injunctions*, or laws touching domestic life and the relation of man to man (xxi, 15-xxvi, 19). So Ewald divides, assigning the former part of chap. xxi to the previous section. Hävernich, on the other hand, includes it in the present. The fact is that ver. 10-14 belong to the laws of war, which are treated of in chap. xx, whereas 1-9 seem more naturally to come under the matters discussed in this section. It begins with the relations of the family, passes on to those of the friend and neighbor, and then touches on the general principles of justice and charity by which men should be actuated (xxiv, 16-22). It concludes with the following confession, which every Israelite is to make when he offers the first-fruits, and which reminds him of what he is as a member of the theocracy, as one in covenant with Jehovah, and greatly blessed by Jehovah.

Finally, this whole long discourse is wound up by a brief but powerful appeal (xxvi, 16-19), which reminds of the words with which it opened. It will be ob-

served that no pains are taken here, or indeed generally in the Mosaic legislation, to keep the several portions of the law, considered as moral, ritual, and ceremonial, apart from each other by any clearly-marked line. But there is in this discourse a very marked gradual descent from the higher ground to the lower. The speaker begins by setting forth Jehovah himself as the great object of love and worship; thence he passes [1.] to the Religious, [2.] to the Political, and [3.] to the Social economy of his people.

3. In the *third Discourse* (xxvii, 1-xxx, 20), the elders of Israel are associated with Moses. The people are commanded to set up stones upon Mount Ebal, and on them to write "all the words of this law." They follow the several curses to be pronounced by the Levites on Ebal (xxvii, 14-26), and the blessings on Gibeon (xxviii, 1-14). How terrible will be the punishment of any neglect of this law is further portrayed in the vivid words of a prophecy but too fearfully verified in the subsequent history of the people. The subject of this discourse is briefly "The Blessing and the Curse." The prophetic speeches visibly and gradually increase in energy and enthusiasm, until the perspective of the remotest future of the people of God lies open to the eye of the inspired lawgiver in all its chequered details, when his words resolve themselves into a flight of poetical ecstasy, into the strains of a splendid triumphal song, in which the tone of grief and lamentation is as heart-rending as the announcement of divine salvation therein is jubilant (ch. xxvii, xxviii).

4. The delivery of the Law as written by Moses (in its still further preservation) to the custody of the Levites, and a charge to the people to bear it read once every seven years (xxxii); the Song of Moses spoken in the ears of the people (xxxii, 30-xxxiii, 44); and the blessing of the twelve tribes (xxxiii).

5. The book closes (xxxiv) with an account of the death of Moses, which is first announced to him in xxxii, 48-52. On the authorship of the last chapter, see below.

II. *Relation of Deuteronomy to the preceding book.*—It has been an opinion very generally entertained by the more modern critics, as well as by the earlier, that the book of Deuteronomy forms a complete whole in itself, and that it was appended to the other books as a later addition. Only chapters xxxii, xxxiii, xxxiv have been in whole or in part called in question by De Wette, Ewald, and Von Lengerke. De Wette thinks that xxxii and xxxiii have been borrowed from other sources, and that xxxiv is the work of the Elohist (q. v.). Ewald also supposes xxxii to have been borrowed from another writer, who lived, however (in accordance with his theory, which we shall notice lower down), after Solomon. On the other hand, he considers xxxiii to be later, whilst Bleek (*Report*, i, 25) and Tuch (*Gen.* p. 556) decide that it is Elohist. Some of these critics imagine that these chapters originally formed the conclusion of the book of Numbers, and that the Deuteronomist tore them away from their proper position in order the better to incorporate his own work with the rest of the Pentateuch, and to give it a fitting conclusion. Gesenius and his followers are of opinion that the whole book, as it stands at present, is by the same hand. But it is a question of some interest and importance whether the book of Deuteronomy should be assigned to the author, or one of the authors, of the former portions of the Pentateuch, or whether it is a distinct and independent work. The more conservative critics of the school of Hengstenberg contend that Deuteronomy forms an integral part of the Pentateuch, which is throughout to be ascribed to Moses. Others, as Stähelin and Delitzsch, have given reasons for believing that it was written by the Jehovist; whilst others again, as Ewald and De Wette, are in favor of a different author.

The chief grounds on which the last opinion rests

the many variations and additions to be found in Deuteronomy, both in the historical and legal portions, as well as the observable difference of style and phraseology. It is necessary, therefore, before we come to consider more directly the question of authorship, to enter into account these alleged peculiarities; and it will be well to enumerate the principal discrepancies, variations, etc., as given by De Wette in the last edition of his *Einführung* (many of his former objections he afterwards abandoned), and to subjoin the replies and explanations which they have called forth.

(1.) *Discrepancies.*—The most important discrepancies alleged to exist between the historical portions of Deuteronomy and the earlier books are the following: 1.) The appointment of judges (i, 6-18) is at variance with the account in Exod. xviii. It is referred to a different time, being placed after the departure of the people from Horeb (ver. 6), whereas in Exodus it is said to have occurred during their encampment before the mount (Exod. xviii, 5). The circumstances are different, and apparently it is mixed up with the sending of the seventy elders (Num. xi, 11-17). To this it has been answered, that although Deut. i, 6 mentions the departure from Sinai, yet Deut. i, 9-17 evidently refers to what took place during the abode there, as is shown by comparing the expression "at that time," ver. 9, with the same expression in ver. 18. The speaker, as is not unnatural in animated discourse, looks himself and goes back to take notice of an important circumstance prior to one which he has already mentioned. This is manifest, because ver. 19 is so early resumptive of ver. 6. Again, there is no force in the objection that Jethro's counsel is here passed over in silence. When making allusion to a well-known historical fact, it is unnecessary for the speaker to enter into details. This at most is an omission, not a contradiction. Lastly, the story in Exodus is perfectly distinct from that in Num. xi., and there is no confusion of the two here. Nothing is said of the institution of the seventy in Deut., probably because the office was only temporary, and if it did not cease before the death of Moses, was not intended to be perpetuated in the promised land. (So in substanceanke, Lengerke, Hengstenberg, Hävernick, Stähelin.)

(2.) Chap. i, 22 is thought to be at variance with Num. xiii, 2, because here Moses is said to have sent spies into Canaan at the suggestion of the people, whereas there God is said to have commanded the measure. The explanation is obvious. The people make the request; Moses refers it to God, who then gives to it His sanction. In the historical book of Numbers the divine command only is mentioned. Here, where the lawgiver deals so largely with the feelings and conduct of the people themselves, he reminds them both that the request originated with themselves, and also of the circumstances out of which that request sprang (ver. 20, 21). These are not mentioned in the history. The objection, it may be remarked, is precisely of the same kind as that which in the N. T. is urged against the reconciliation of Gal. ii, 2 with Acts xv, 2, 3. Both admit of a similar explanation.

(3.) Chap. i, 44, "And the Amorites which dwelt in that mountain," etc., whereas in the story of the same event, Num. xiv, 43-45, Amalekites are mentioned. Answer: in this latter passage not only Amalekites, but Canaanites, are said to have come down against the Israelites. The Amorites stand here not for "Amalekites," but for "Canaanites," as being the most powerful of all the Canaanitish tribes (comp. Gen. xv, 16; Deut. i, 7); and the Amalekites are not named, but hinted at, when it is said, "they destroyed you in Seir," where, according to 1 Chron. iv, 42, they dwelt (so Hengst. iii, 421).

(4.) Chap. ii, 2-8, confused and at variance with Num. xx, 14-21, and xxi, 4. In the former we read

(ver. 4), "Ye are to pass through the coast of your brethren, the children of Esau." In the latter (ver. 20), "And he said, Thou shalt not go through. And Edom came out against him," etc. But, according to Deuteronomy, that part of the Edomitish territory only was traversed which lay about Elath and Ezion-geber. In this exposed part of their territory any attempt to prevent the passage of the Israelites would have been useless, whereas at Kadesh, where, according to Numbers, the opposition was offered, the rocky nature of the country was in favor of the Edomites. (So Hengst. iii, 288 sq.) To this we may add, that in Deut. ii, 8, when it is said "we passed by from our brethren the children of Esau . . . through the way of the plain from Elath," the failure of an attempt to pass elsewhere is implied. Again, according to Deut., the Israelites purchased food and water of the Edomites and Moabites (ver. 6, 28), which, it is said, contradicts the story in Num. xx, 19, 20. But in both accounts the Israelites offer to pay for what they have (comp. Deut. ii, 6 with Num. xx, 19). And if in Deut. xxiii, 4 there seems to be a contradiction to Deut. ii, 29 with regard to the conduct of the Moabites, it may be removed by observing (with Hengst. iii, 286) that the unfriendliness of the Moabites in not coming out to meet the Israelites with bread and water was the very reason why the latter were obliged to buy provisions.

(5.) There is a difference in the account of the encampments of the Israelites as given Deut. x, 6, 7, compared with Num. xx, 23; xxxiii, 80 and 87. In Deut. it is said that the order of encampment was, 1. Bene-jaakan; 2. Moera (where Aaron dies); 3. Gudgodah; 4. Jotbath. In Numbers it is, 1. Moseroh; 2. Bene-jaakan; 3. Hor-hagidgad; 4. Jotbath. Then follow the stations Ebronah, Ezion-geber, Kadesh, and Mount Hor, and it is at this last that Aaron dies. (It is remarkable here that no account is given of the stations between Ezion-geber and Kadesh on the return route.) Various attempts have been made to reconcile these accounts. The explanation given by Kurtz (*Atlas zur Gesch. d. A. B.* 20) is, on the whole, the most satisfactory. He says: "In the first month of the fortieth year the whole congregation comes a second time to the wilderness of Zin, which is Kadesh (Num. xxxiii, 86). On the down-route to Ezion-geber they had encamped at the several stations Moseroh (or Moserah), Bene-jaakan, Chor-hagidgad, and Jotbath. But now, again departing from Kadesh, they go to Mount Hor, 'in the edge of the land of Edom' (ver. 37, 38), or to Moserah (Deut. x, 6, 7), this last being in the desert at the foot of the mountain. Bene-jaakan, Gudgodah, and Jotbath were also visited about this time, i. e. a second time, after the second halt at Kadesh." See EXOD. x.

(6.) But this is not so much a discrepancy as a peculiarity of the writer: in Deut. the usual name for the mountain on which the law was given is Horeb, only once (xxxiii, 2) Sinai; whereas in the other books Sinai is far more common than Horeb. The answer given is that Horeb was the general name of the whole mountain range, Sinai the particular mountain on which the law was delivered; and that Horeb, the more general and well-known name, was employed in accordance with the rhetorical style of this book, in order to bring out the contrast between the Sinaitic giving of the law, and the giving of the law in the land of Moab (Deut. i, 5; xxix, 1). So Keil. See HOREB.

(II.) *Additions.*—1. *In the History.* (a) The command of God to leave Horeb, Deut. i, 6, 7, not mentioned in Num. x, 11. The repentance of the Israelites, Deut. i, 45, omitted in Num. xiv, 45. The intercession of Moses in behalf of Aaron, Deut. ix, 20, of which nothing is said in Exod. xxxii, xxxiii. These are so slight, however, that, as Keil suggests, they might have been passed over very naturally in the earlier books, supposing both accounts to be by the same hand. But of more note are: (b) The command not

to fight with the Moabites and Ammonites, Deut. ii, 9, 19, or with the Edomites, but to buy of them food and water, ii, 4-8; the valuable historical notices which are given respecting the earlier inhabitants of the countries of Moab, and Ammon, and of Mount Seir, ii, 10-12, 20-28; the sixty fortified cities of Bashan, iii, 4; the king of the country who was "of the remnant of giants," iii, 11; the different names of Hermon, iii, 9; the wilderness of Kedemoth, ii, 26; and the more detailed account of the attack of the Amalekites, xxv, 17, 18, compared with Exod. xvii, 8.

2. *In the Law.* The appointment of the cities of refuge, Deut. xix, 7-9, as compared with Num. xxxv, 14 and Deut. iv, 41; of one particular place for the solemn worship of God, where all offerings, tithes, etc. are to be brought, Deut. xii, 5, etc., whilst the restriction with regard to the slaying of animals only at the door of the tabernacle of the congregation (Lev. xvii, 8, 4) is done away, 15, 20, 21; the regulations respecting tithes to be brought with the sacrifices and burnt-offerings to the appointed place, Deut. xii, 6, 11, 17; xiv, 22, etc.; xxvi, 12; concerning false prophets and seducers to idolatry and those that hearken unto them, xiii; concerning the king and the manner of the kingdom, xvii, 14, etc.; the prophets, xviii, 15, etc.; war and military service, xx; the expiation of secret murder; the law of female captives; of first-born sons by a double marriage; of disobedient sons; of those who suffer death by hanging, xxi; the laws in xxii, 5-8, 18-21; of divorce, xxiv, 1, and various lesser enactments, xxiii and xxv; the form of thanksgiving in offering the first-fruits, xxvi; the command to write the law upon stones, xxvii, and to read it before all Israel at the Feast of Tabernacles, xxxi, 10-18.

Many others are rather extensions or modifications of, than additions to, existing laws, as, for instance, the law of the Hebrew slave, Deut. xv, 12, etc. compared with Exod. xxi, 2, etc. See also the fuller directions in Deut. xv, 19-28; xxvi, 1-11, as compared with the briefer notices, Exod. xiii, 12; xxiii, 19.

All these, however, afford no real difficulty in identifying the author with that of the preceding books, on the supposition that it was Moses himself, who, as the propounder of the law and the director of the history, was competent to expand and illustrate both, and, indeed, could hardly fail to do so, were he other than a mechanical copyist.

III. *Date of Composition.*—Was the book really written, as its language certainly implies, before the entry of Israel into the Promised Land? Not only does the writer assert that the discourses contained in the book were delivered in the plains of Moab, in the last month of the 40 years' wandering, and when the people were just about to enter Canaan (i, 1-5), but he tells us with still further exactness that all the words of this Law were written at the same time in the book (xxxii, 9). Moreover, the fact that the goodly land lay even now before their eyes seems everywhere to be uppermost in the thoughts of the legislator, and to lend a peculiar solemnity to his words. Hence we continually meet with such expressions as "when Jehovah thy God bringeth thee into the land which He hath sworn to thy fathers to give thee," or "whither thou goest in to possess it." This phraseology is so constant, and seems to fall in so naturally with the general tone and character of the book, that to suppose it was written long after the settlement of the Israelites in Canaan, in the reign of Solomon (De Wette, Lengerke, and others), or in that of Manasseh (Ewald, as above), is not only to make the book a historical romance, but to attribute very considerable inventive skill to the author (as Ewald in fact does).

De Wette argues, indeed, that the character of the laws is such as of itself to presuppose a long residence in the land of Canaan. He instances the allusion to the temple (xii, and xvi, 1-7), the provision for the right discharge of the kingly and prophetic offices,

the rules for civil and military organization and the state of the Levites, who are represented as living without cities (though such are granted to them, Num. xxxv) and without tithes (allotted to them, Num. xviii, 20, etc.). But in the passages cited the Temple is not named, much less is it spoken of as ready existing; on the contrary, the phrase employed is "The place which the Lord your God shall choose." Again, to suppose that Moses was incapable of providing for the future and very different positions of his people as settled in the land of Canaan, is to deny him even ordinary sagacity. Without raising the question about his divine commission, surely it is not much to assume that so wise and great a legislator would foresee the growth of a polity, and would be anxious to regulate its due administration in the best of God. Hence he would guard against false prophets and seducers to idolatry. As regards the Levites, Moses might have expected or even desired that, though possessing certain cities (which, however, were inhabited by others as well as themselves), they should be confined to those cities, but scattered over the face of the country. This must have been the case at first, owing to the very gradual occupation of the new territory. The mere fact that, in giving them certain rights in Deut., nothing is said of an earlier provision in Num., does not by any means prove that this earlier provision was unknown or had ceased to be in force.

Other reasons for a later date, such as the mention of the worship of the sun and moon (iv, 19; xviii, 17), the punishment of stoning (xvii, 5; xxii, 21, etc.); the name *Feast of Tabernacles*; and the motive for keeping the Sabbath, are of little force. In Amos v. 25, Saturn is said to have been worshipped in the wilderness; the punishment of stoning is found also in the older documents; the Feast of Tabernacles agrees with Lev. xxiii, 34; and the motive alleged for the observance of the Sabbath, at least, does not exclude other motives.

IV. *Author.*—1. It is generally agreed that by the greater portion of the book is the work of one author. The only parts which have been questioned as possible interpolations are, according to De Wette, 41-8; x, 6-9; xxxii and xxxiii. Internal evidence, indeed, is strongly decisive that this book of the Pentateuch was not the work of a compiler.

2. It cannot be denied that the style of Deuteronomy is very different from that of the other four books of the Pentateuch. It is more flowing, more rhetorical, more sustained. The rhythm is grand, and the diction more akin to the sublimer passages of the prophets than to the sober prose of the historians.

3. Who, then, was the author? This question, of course, is intimately connected with the preceding discussion. We will consider, first, the views of those who deny its authorship by Moses. On this point the following principal hypotheses have been maintained:

a. The opinion of Stäbelin (and, as it would seem, of Bleek), that the author is the same as the writer of the Jehovistic portions of the other books. He thinks that both the historical and legislative portions plainly show the hand of the supplementist (*Krit. Unters.*, p. 76). Hence he attaches but little weight to the alleged discrepancies, as he considers them all to be the work of the reviser, going over, correcting, and adding to the older materials of the Elohistie documents already in his hands.

b. The opinion of De Wette, Geeseus, and others, that the Deuteronomist is a distinct writer from the Jehovist. De Wette's arguments are based (1) on the difference in style; (2) on the contradictions already referred to as existing in matters of history, as well as in the legislation, when compared with that in Exodus; (3) on the peculiarity noticeable in this book, that God does not speak by Moses, but that Moses himself speaks to the people, and that there is no mention

the angel of Jehovah (comp. i, 80; vii, 20-23; xi, 17, with Exod. xxiii, 20-23); and (4) lastly, on the fact that the Deuteronomist ascribes his whole work to Moses, while the Jehovist assigns him only certain portions.

c. From the fact that certain phrases occurring in it are found also in the prophecy of Jeremiah, it has been too hastily concluded by some critics that these books were the work of the prophet. So Von Hübner, Gesenius (*Gesch. d. Hebr. Spr.* p. 32), and Hartmann (*Hist. Krit. Forsch.* p. 660). König, on the other hand (*Alttest. Stud.* ii, 12 sq.), has shown not only that this idiomatic resemblance has been made too much of (see also Keil, *Einl.* p. 117), but that there is the greatest possible difference of style between the two books. De Wette expresses himself similarly (*Einl.* p. 191).

d. Ewald is of opinion that it was written by a Jew living in Egypt during the latter half of the reign of Amnaseh (*Gesch. des V. I.* i, 171). He thinks that a young Jew of that age, gifted with prophetic power, and fully alive to all the evils of his time, sought thus to revive and to impress more powerfully upon the minds of his countrymen the great lessons of that law which he saw they were in danger of forgetting. He vailes himself, therefore, of the groundwork of the earlier history, and also of the Mosaic mode of expression. But as his object is to rouse a corrupt nation, he only makes use of historical notices for the purpose of introducing his warnings and exhortations with more effect. This he does with great skill and as a master of his subject, while at the same time he gives fresh vigor and life to the old law by means of those new prophetic truths which had so lately become the heritage of his people. Ewald further considers that there are passages in Deuteronomy borrowed from the books of Job and Isaiah (iv, 32, from Job viii, 8; and xxviii, 29, 30, 35, from Job v, 14; xxxi, 10; ii, 7; and xxviii, 49, etc. from Isa. v, 26 sq.; xxxiii, 19), and much of it akin to Jeremiah (*Gesch.* i, 171, note). The story of Moses (xxxii) is, according to him, not by the Deuteronomist, but is nevertheless later than the time of Solomon.

e. The old traditional view that this book, like the other books of the Pentateuch, is the work of Moses himself. Of the later critics, Hengstenberg, Hävernick, Ranke, and others, have maintained this view. Moses Stuart writes: "Deuteronomy appears to my mind, as it did to that of Eichhorn and Herder, as the earnest outpourings and admonitions of a heart which felt the deepest interest in the welfare of the Jewish nation, and which realized that it must soon bid farewell to them . . . Instead of bearing upon its face, as is alleged by some, evidences of another authorship than that of Moses, I must regard this book as being so deeply fraught with holy and patriotic feeling as to convince any unprejudiced reader who is competent to judge of its style, that it cannot, with any tolerable degree of probability, be attributed to any pretender to legislation, or to any mere imitator of the great legislator. Such a glow as runs through all this book it is in vain to seek for in any artificial or supposititious composition" (*Hist. of the O. T. Canon*, § 8).

In support of this opinion, it is said: 1. That, supposing the whole Pentateuch to have been written by Moses, the change in style is easily accounted for when we remember that the last book is hortatory in its character, that it consists chiefly of orations, and that these were delivered under very peculiar circumstances. 2. That the *usus loquendi* is not only generally in accordance with that of the earlier books, and that as well in their Elohistical as in their Jehovistic portions, but that there are certain peculiar forms of expression common only to these five books. 3. That the alleged variations in matters of fact between this and the earlier books may all be reconciled (see above), and that the amplifications and corrections in the leg-

islation are only such as would necessarily be made when the people were just about to enter the promised land. Thus Bertheau observes: "It is hazardous to conclude from contradictions in the laws that they are to be ascribed to a different age . . . He who made additions must have known what it was he was making additions to, and would either have avoided all contradiction, or would have altered the earlier laws to make them agree with the later" (*Die Sieben Gruppen Mos. Gesetze*, p. 19, note). 4. That the book bears witness to its own authorship (xxxii, 19), and is expressly cited in the N. T. as the work of Moses (Matt. xix, 7, 8; Mark x, 3; Acts iii, 22; vii, 37).—Smith, s. v.

The book contains, in addition, not a small number of plain, though indirect traces, indicative of its Mosaic origin (see *Jour. Sac. Lit.* Jan. 1868, p. 818 sq.). We thus find in it: 1. Numerous notices concerning nations with whom the Israelites had then come in contact, but who, after the Mosaic period, entirely disappeared from the pages of history: such are the accounts of the residences of the kings of Bashan (i, 4). 2. The appellation of "mountain of the Amorites," used throughout the whole book (i, 7, 19, 20, 44), while even in the book Joshua, soon after the conquest of the land, the name is already exchanged for "mountains of Judah" (Josh. xi, 16, 21). 3. The observation (ii, 10) that the *Emim* had formerly dwelt in the plain of Moab: they were a great people, equal to the *Akakim*. This observation quite accords with Gen. xiv, 5. 4. A detailed account (ii, 11) concerning the Horim and their relations to the Edomites. 5. An account of the Zamzumim (ii, 20, 21), one of the earliest races of Canaan, though mentioned nowhere else. 6. A very circumstantial account of the Rephaim (iii, 3 sq.), with whose concerns the author seems to have been well acquainted.

The standing-point also of the author of Deuteronomy is altogether in the Mosaic time, and, had it been assumed and fictitious, there must necessarily have been moments when the spurious author would have been off his guard, and unmindful of the part he had to play. But no discrepancies of this kind can be traced; and this is in itself an evidence of the genuineness of the book.

A great number of other passages force us likewise to the conclusion that the whole of Deuteronomy originated in the time of Moses. Such are the passages where: 1. A comparison is drawn between Canaan and Egypt (xi, 10 sq.), with the latter of which the author seems thoroughly acquainted. 2. Detailed descriptions are given of the fertility and productions of Egypt (viii, 7 sq.). 3. Regulations are given relating to the conquest of Canaan (xii, 1 sq.; xx, 1 sq.), which cannot be understood otherwise than by assuming that they had been framed in the Mosaic time, since they could be of no use after that period.

Besides, whole pieces and chapters in Deuteronomy, such as xxxii, xxxiii, betray in form, language, and tenor, a very early period in Hebrew literature. Nor are the laws and regulations in Deuteronomy less decisive of the authenticity of the book. We are struck with the most remarkable phenomenon that many laws from the previous books are here partly repeated and impressed with more energy, partly modified, and partly altogether abolished, according to the contingencies of the time, or as the new aspect of circumstances among the Jews rendered such steps necessary (comp. e. g. Deut. xv, 17, with Exod. xxi, 7; Deut. xii with Lev. xvii). Such pretensions to raise, or even to oppose his own private opinions to the authority of divine law, are found in no author of the subsequent periods, since the whole of the sacred literature of the later times is, on the contrary, rather the echo than otherwise of the Pentateuch, and is altogether founded on it. Add to this the fact that the law itself forbids most impressively to add to, or take anything from it, a prohibition which is repeated even in Deu-

teronomy (comp. iv, 2; xiii, 1); so that on the theory that this book contains nothing more than a gradual development of the law, it clashes too often with its own principles, and thus pronounces its own sentence of condemnation.

The part of Deuteronomy (xxxiv) respecting the death of Moses requires a particular explanation. That the whole of this section is to be regarded as a piece altogether apart from what precedes it, or as a supplement by another writer, is a ready solution maintained by the older theologians (comp. e. g. Carpzov, *Introd. in libr. V. T. i*, 137); and this opinion is confirmed not only by the contents of the chapter, but also by the express declaration of the book itself on that event and its relations; for chapter xxxi contains the conclusion of the work, where Moses describes himself as the author of the previous contents, as also of the Song (ch. xxxii), and the blessings (ch. xxxiii) belonging to it. All that follows is, consequently, not from Moses, the work being completed and concluded with chapter xxxiii. There is another circumstance which favors this opinion, namely, the close connection that exists between the last section of Deuteronomy and the beginning of Joshua (comp. Deut. xxxiv, 9 with Josh. i, 1, where also the connective force of the term "וַיָּבֵר", "and it came to pass," in the latter passage, must not be overlooked), plainly showing that ch. xxxiv of Deuteronomy is intended to serve as a point of transition to the book of Joshua, and that it was written by the same author as the latter. The correct view of this chapter, therefore, is to consider it as a real supplement, but by no means as an interpolation (such as some critics erroneously suppose to exist in the Pentateuch in general). To apply to it the term interpolation would be as wrong as to give that appellation, e. g., to the 8th book of Cæsar's work *De Bello Gallico*, simply because it was written by an unknown author, for the very purpose of serving as a supplement to the previous books.—Kitto, s. v. See PENTATEUCH.

V. Separate commentaries upon the book of Deuteronomy are not numerous; the most important are designated by an asterisk (*) prefixed: Origen, *Selecta in Deut.* (in *Opp.* ii, 386); Ephraem Syrus, *Explanatio in Deut.* (in *Opp.* iv, 269); Theodoret, *Questiones in Deut.* (in *Opp.* i, pt. i); Isidorus Hispanensis, *Commentaria in Deut.* (in *Opera*); Bede, *In Deut. Explanatio* (in *Opp.* iv); id. *Questiones super Deut.* (ib. viii); Victor Hugo, *Annotatiunculae in Deut.* (in *Opp.* i); Rupertus Tuitiensis, *In Deut.* (in *Opp.* i, 288); Luther, *Deuteronomium castigatum* (Viteb. 1524, 8vo); also in *Opp.* iii, 76; *Exeg. Opp.* xiii); Bugenhagen, *Commentarius in Deut.* (Basil. 1524, Viteb. 1525, 8vo); Macchabeus, *Enarratio in Deut.* (London, 1588, 8vo); Chytræus, *Enarrationes in Deut.* (Viteb. 1575, 1590, 8vo); Calvin, *Sermons upon Deut.* (from the French by Golding, Lond. 1588, fol.); Brent, *Comment. in Deut.* (in *Opp.* i); Bp. Babington, *Notes upon Deut.* (in *Works*, p. 149); Lorinus, *Commentarius in Deut.* (Lugd. 1625, 1629, 2 vols. fol.); Masius, *Annotationes in cap. xviii et seq.* (in the *Critici Sacri*, i, pt. ii); Franze, *Disputationes per Deut.* (Viteb. 1608, 4to); *Gerhard, *Commentarius super Deut.* (Jen. 1657, 4to); Cocceius, *Nota in Deut.* (in *Opp.* i, 186); id. *De ult. Deut. capita* (ib. i, 201); Alting, *Commentarius in cap. i-xix* (in *Opp.* i, 121, Amst. 1687); Duquet, *Explicatio de c. xxi-xxxiii* (Par. 1784, 12mo); Vitringa, *Comm. in cant. Moisi* (Harl. 1784, 4to); Holt, *Deuteronom. illustratum* (Lugd. 1768, 4to); Marck, *Comment. in cap. xxi-xxxiii* (in *Partes Pentat.*); Hagemann, *Betrachtungen üb. d. f. B. Moisi* (Brunsw. 1744, 4to); Homberg, *בְּרֵאשִׁית לְמֹשֶׁה* (in Mendelssohn's Pentateuch, Berlin, 1788, etc.); *Rosenmüller, *Scholæ* (in *Schol.* pt. ii); *Horsley, *Notes on Deut.* (in *Bib. Criticism*, i); Riehm, *Moses im kande Moab* (Lpz. 1854, 8vo); Cumming, *Readings on Deut.* (London, 1856, 12mo); *Graff, *Der Segen Moisi erklärt* (Lpz. 1857, 8vo); How-

ard, *Deut. from the Sept.* (Lond. 1857, 8vo); *Schütz, *Das Deuteronom. erklärt* (Berl. 1859, 8vo); *Knobel, *Erläuterung* (in the *Exeg. Handb.* part xiv); *Schwabe, *Bearbeitung* (in Lange's *Bibelwerk*, O. T. iii, Bielefeld, 1866, 8vo). See OLD TESTAMENT.

Dévay, MATTHIAS BÉRO, the most prominent among the Reformers of Hungary in the 16th century, was born towards the close of the 15th or the beginning of the 16th century, in Deva, a hamlet in the county (county) of Hunyad. It is not certain, as the Hungarian writers think, that he studied at Ofen; the celebrated Grynszus, the first promoter of the Reformation in Hungary. In 1528 his name is mentioned among the students of the University of Cracow. After his return from this university, at which he studied for two years, he became a priest and a monk. In this position he still was in 1527, but soon after he adopted the principles of the Reformation, and in 1528 went to Wittenberg, to study the new theology. While in Wittenberg he lived in the house of Luther. In 1531 he was minister of a Protestant congregation in Ofen, and distinguished for his reformatory labors. About this time he wrote a small work against the invocation of the saints (*De sanctorum dormitione*), and fifty-two propositions explaining the fundamental principles of the Reformation. Still, in the course of the year 1531, he was called as preacher to Kaschau by the council of that town. On Nov. 6, 1531, he was arrested by order of Thomas Szalaházy, bishop of E-lau and councillor of king Ferdinand, and kept a prisoner first at Likava, subsequently at Pressburg, from whence he was taken to Vienna. In Vienna, bishop Faber, one of the leading opponents of the Reformation, conducted the trial; but Dévay was soon discharged, and returned to Ofen. As he, however, soon resumed his reformatory activity, he was re-arrested in 1532, and held in prison at Ofen until 1533. After his liberation from this captivity, Dévay placed himself under the protection of count Nádasdy, a Hungarian magnate who had openly espoused the cause of the Reformation. He devoted his time chiefly to a refutation of two works which Gregory Szegedy, the provincial of the Franciscan order in Hungary, and a member of the Sorbonne, had written against the Reformation. This work (together with the defence of Dévay before bishop Faber) appeared in 1537 at Basel under the title *Disputatio de Statu in quo sint bestie cum anima post hanc vitam ante ultimi judicii diem*. At the close of the year 1537 he returned, together with his friend Johann Sylvester, who likewise distinguished himself as a reformer of Hungary, to count Nádasdy, bringing with him a letter of recommendation from Melancthon. For several years, Nádasdy, Dévay, and Sylvester displayed great activity for the propagation of the Reformation. Dévay wrote an outline of the Hungarian grammar for elementary schools (*Orthographia Hungarica*), the first book printed in the Hungarian language. This little book contained, besides the grammatical matter, a statement of the fundamental principles of the Reformation, and children's prayers taken from the smaller catechism of Luther. The civil war in Hungary, in which a Turkish army supported the claims of the son of Zápolya, the rival of king Ferdinand, to the Hungarian crown, and in which Nádasdy, Dévay, and Sylvester were on the side of Ferdinand, interrupted the labors of the reformers, and destroyed the Protestant school and printing-press at Uj-Sziget. Dévay had to leave Hungary, and was recommended by Melancthon to Margrave George, a zealous patron of the Reformation, who owned large possessions in Hungary. Dévay on this occasion paid another visit to Switzerland, and there adopted the views of the Helvetic Reformers on the doctrine of the Lord's Supper. On his return to Hungary he zealously preached his new views. The Lutheran ministers of the district of Sárvár, where Nádasdy lived, complained of this change of views to

ther, who in his reply (dated April 31, 1544) finds it incumbent to believe in the change, but says that, at all points, Dévay has not received this doctrine from him, and that he (Luther) would continue to fight that "domination" publicly and privately. After his return to Hungary, Dévay labored as preacher and "senior" (elder) in the town of Debreczin, where the Reformation had a powerful patron in count Valentin Török Enying, a near relative of count Nádasdy. While Debreczin, Dévay wrote, in the Hungarian language, an exposition of the Ten Commandments, the Articles of Faith, the Lord's Prayer, and the Seal of Faith. His book was probably printed at Cracow. The year and place of the death of Dévay are not known, but it is probable that in the year 1547 he was no longer alive. Besides the works already mentioned, Dévay was the author of a hymn containing the principal articles of the Reformed Faith, and which was received to the hymn-book of the Reformed Church of the Helvetic Confession in Hungary.—Herzog, *Real-Encyclop.* xix, 406, Wetzlar und Welte, *Kirchen-Lex.* iii, 23; Craig (transl.), *History of the Protestant Church in Hungary* (Lond. 1854), p. 50 sq.; Schröckh, *Kirchengeschichte seit der Reformation*, ii. 730.

Development, a word denoting primarily *unfolding*, *unwrapping*; hence, secondarily, a process of growth or expansion. It has recently come into extensive use both in philosophy and in theology. In philosophy, it is part of the Pantheistic doctrine not only that all existing forms of life have been developed from simpler forms, but also that the Infinite, as well as the finite, passes from one stage of life to another by unending development. "The whole fabric of ancient and modern Pantheism rests upon the *petitio principii* that the doctrine of evolution has the same legitimate application within the sphere of the Infinite and Eternal that it has within that of the finite and temporal, a postulate that annihilates the distinction between the two. The idea of undeveloped being has no rational meaning except in reference to the created and the conditional" (Shedd, *History of Christian Doctrine*, i, 13).

1. As applied to history, the doctrine of development, as stated by its ablest advocates, is that all created existences obey a law of evolution from the potential germ given by the Creator; and that this law applies to the race of man as well as to individuals of the race. As a tree is developed from its seed, so the human body, the human mind, the human race, grow, according to the law of their organic life. Under this view, "history is no longer viewed as a mere inorganic mass of names, dates, and facts, but as *spirit and life*, and therefore as process, motion, development, passing through various stages, ever rising to some higher state, yet identical with itself, so that its end is but the full unfolding of its beginning. This makes Church history, then, appear as an organism, starting from the person of Christ, the creator and progenitor of a new race; perpetually spreading both outwardly and inwardly; maintaining a steady conflict with sin and error without and within; continually beset with difficulties and obstructions; yet, under the unflinching guidance of Providence, infallibly working an appointed end. This idea of organic development combines what was true in the notion of something permanent and unchangeable in Church history, as held by both the Catholic and the Old-Protestant orthodoxy, with the element of truth in the Rationalistic conception of motion and flow; and on such ground alone is it possible to understand fully and clearly the temporal life of Christianity. A permanent principle, without motion, stiffens into stagnation; motion, without a principle of permanence, is a process of dissolution. In neither case can there properly be any living history. The conception of such history is, that while it incessantly changes its form, never for a moment standing still, yet through all its changes it remains

true to its own essence; never outrages itself; incorporates into each succeeding stage of growth the results of the preceding, and thus never loses anything which was ever of real value" (Schaff, *Apostolic Church*, § 34). Certain guards are necessary to prevent the Christian theory of development from passing into the Pantheistic view. They are stated by Dr. Shedd (*History of Christian Doctrine*, § 8, 4) substantially as follows: 1. The pantheists substitute development for creation. Development supposes existing materials; creation, on the other hand, is from nothing, and presupposes no materials. All germs, according to Christian theism, are created by God. Mere development (which is simply the *unfolding* of something previously *folded up*) cannot account for the origin of anything. "The significant fact in natural history, not yet invalidated by the most torturing experiments of baffled theorists, that one species never expands into another, proves that though a process of development can be accounted for out of the latent potentiality at the base, the latter can be accounted for only by recurring to the creative power of God. The expansion of a vegetable seed, even if carried on through all the cycles upon cycles of the geological system, never transmutes it into the egg of animal life; and this only verifies the self-evident proposition that nothing can come forth that has never been put in" (Shedd, *Hist. of Christian Doctrine*, § 3). The second caution is always to discriminate the idea of a development from that of an *improvement*. It depends upon the nature of the germ whether the evolution shall be from good to better, or from bad to worse. By the abuse of free-will in the spiritual sphere the normal development may be displaced; but original righteousness was not developed into original sin. Man, endowed with free-will, created sin, so to speak, under the permission of God. Abstractly, then, development may be synonymous with corruption and decline, as well as with improvement.

But, even with all these guards and cautions, the doctrine of development, when applied within the sphere of moral action, is a perilous one. Any theory of the history of man which leaves out of the case his free agency, must end either in Fatalism or in Pantheism. Dr. T. H. Skinner, Jr., in the *Baptist Quarterly Review* for January, 1868, while vindicating Dr. Shedd's theory of development from the charge of Pantheism, endeavors to show that it runs into Fatalism. "Dr. Shedd does not discriminate development from necessity. From the scheme of realistic development, neither a true and just human responsibility, nor a true divine moral government of free agents, can be deduced." If it be true, as Dr. Shedd says, that the same law of organic sequence prevails in the sphere of mind and of freedom that works in the kingdom of matter and necessity, then necessity rules the one sphere as it does the other, and rules under the same law.

2. As applied to doctrine, the Christian view of development is that there has been a gradual progression in the manifestation of the divine plan to man, both in revelation and in history. This doctrine is well set forth and illustrated, so far as the N. T. is concerned, in Bernard's *Progress of Doctrine in the New Testament* (Bampton Lecture for 1866; Boston, Gould & Lincoln, 1867). The Bible, beginning with Genesis, gives the exposition, not of a revelation completed, but of a revelation in progress, and expanding into greater fullness and clearness from the beginning until its final completion in the Apocalypse, at the close of the Canon. After this, the Church has never held to any advance in *divine teaching*; all growth, subsequent to the apostolical age, has been growth in man's apprehension of divine truth, not in God's revelation of it. The Holy Spirit is still a divine guide to all seekers after truth; not in the way of new revelation, however, but of "reminding" men of the truth once given, and of il-

luminating the truly believing inquirer in his search into the meaning of revelation. The body of Christian truth, both fact and doctrine, is revealed and recorded, once for all, in the Scriptures of the Old and New Testament; and these Scriptures constitute, in every age, the norm of doctrine, and the criterion by which all new exhibitions of doctrine are to be tested. No new truth can be developed any more than a new man can be created. But it is very clear that there may be, and has been, development of Christian doctrine in the sense of clearer apprehension of it on the part of the Church. The science of theology implies the application of human reason to the given facts and doctrines of Christianity; first, the application of reason to Scripture (exegesis), to find out what its doctrines are; and, secondly, the use of reason in co-ordinating these doctrines into scientific form (system). It will be observed that the "development of doctrine," as thus stated, is very different from the theory that the Bible gives only the "germs" of doctrine, out of which, by a necessary organic law, the doctrines themselves are "developed." This image of a "germ" is very apt to mislead. Even if a doctrine were a living thing such as a germ is, "it is to be remembered that even a germ is developed by attracting and assimilating to itself many foreign elements which are around it. It is by additions from without, and different from itself, that it grows" (Donaldson, *History of Christian Literature*, i, 5).

In doctrine, however, as in history, development is not always synonymous with improvement. Human apprehension of divine truth is sometimes wrong, as well as sometimes right; and the history of doctrines, while implying development in its very idea, yet includes variations of rise and fall in human statements of the one divine truth. A right theory "of the development of Christian theology by no means implies that each later age must necessarily have a fuller and deeper knowledge of divine things than its predecessors, either as spread abroad through the body of the Church, or as centred in its chief teachers. Were this a consequence of this theory, this alone would be fatal to it, the very reverse having notoriously been often the case. But even in science, which is so much less dependent on moral influences, and with which the varieties of character and feeling have so little to do, the progress has never been uniform and uninterrupted; while in poetry, in the arts, in philosophy, where the understanding is greatly swayed by moral affections, and derives a main part of its sustenance and energy from them, man's course has been so irregular that nothing like a law of it has been ascertained. So, too, must it needs be in theology, where the subject matter is divine truth, which cannot be received intellectually unless it be also received morally, to the pure reception of which all corrupt feelings of our nature are opposed, and which they are perpetually attempting to sophisticate and distort. Thus it has often come to pass that the inheritance left us by one age has been squandered, or wasted, or forfeited by its successor, so that it by no means follows from the theory of the development of Christian truth that even the later system of theology must be the better. For the world is always wrestling to draw men away from the truth, and will often prevail, as Jacob did over the angel; and when faith is at a low ebb, when the visible, and the immediate, and material predominate in men's hearts and minds over the invisible, the ideal, and the spiritual, theology must needs dwindle and decay. But when there is a revival of faith, if this revival coincides with, or is succeeded by a period of energetic thought, a deeper or clearer insight will be gained in certain portions of truth, especially appropriate to the circumstances and exigencies of the age, and which have not yet been set forth in their fulness. Thus, to cite the two most notable examples, the true doctrine of the Trinity

was brought out more distinctly in the fourth century than that of justification by faith in the sixteenth; the prevalence of error acting in both instances as a motive and spur to the clearer demarcation and expansion of the truth. At the same time, through our aptness to overlook himself, and to exaggerate the importance of whatever may be engaging him at the moment, an age which has been allowed to behold a truth which it may too easily depreciate and let slip the truth which its ancestors have bequeathed to it, its proneness has ever been a main source of loss. Thus, on all sides, we are continually reminded of our inherent weakness, and how that weakness is ever the most mischievous when we are beguiled into fancying ourselves strong; and while we are hereby exhorted to be diligent in studying the whole history of the Church, and the writings of her chief teachers in every age, lest we drop and lose any portion of the precious riches which they have been allowed to win for mankind, we are still more strongly admonished to compare every proposition, and every scheme of propositions—every proposition, both as it stands by itself and in its relation to the other parts of Christian truth—with the only canon of truth, the written Word of God" (Hare, *Mission of the Comforter*, note G).

In what has been called the *extreme subjective school* of German theology, there is a false doctrine of development, which is stated as follows in Chambers's *Encyclopædia* (s. v. DEVELOPMENT): "According to this school, Christian doctrine is nothing else than the expression of the Christian consciousness at any time. Scripture maintains no permanent or authoritative relation to it. It is all progress—a continued flux, without any normal standard or expression. Scripture may be its primary expression, but it may leave its fountain-head, and in the course of time issue in developments not necessarily bound to Scripture. But according to the view above set forth, Scripture remains the absolute and complete revelation of Christian doctrine, which is continually unfolded, but never exhausted by inquiry—beyond which right reason and truth never travel. The Christian revelation not only admits of, but demands constant criticism, as the means of unfolding more comprehensively and perfectly its contents, but it remains in itself the consummate expression of all spiritual truth; and it is this very peculiarity of the Christian revelation that makes its contents capable of continual and ever fresh development. It is just because its substance is divine that its doctrinal expressions never cease to interest and to answer to the necessities of successive times. Other religions, while capable of development, reach a point where they cease to have any further living meaning, and pass on the one hand into mere popular mythology, or into an esoteric priestly tradition. They become transmuted into poetry or some ordinary product of philosophical speculation. Civilization overtakes and supplants them. But it is of the distinguishing divine character of Christianity that its doctrines possess a vital ever-renewing power, capable of adaptation to the highest forms of human civilization, and full of enlightenment and guidance to the most advanced intelligence. The development of Christian doctrine, therefore, is not merely a subject of curious and important study in the past, but of great and significant influence for the present and the future."

8. Certain Romanist writers have recently made use of the doctrine of development to vindicate the theology of that Church. They hold that the Scriptures do not contain the entire revelation of God to man, but that revelation is receiving additions, and gradually becoming complete, by the successive decisions of the Church. This view has been set forth by Möhler, and with special skill by J. H. Newman (*Essay on the Development of Christian Doctrine* [N. Y. 1858, 8vo]). Its ground is that the revelation given in the Bible was intentionally incomplete, and forms an inchoate

d imperfect system of truth, needing for its completion a gradual development under infallible guidance, and that the present system of doctrine in the Roman Catholic Church is the ripened result of this development, so far as made. See also Döllinger, *Christentum und Kirche*, 1860, p. 162. The doctrine has not met with general favor in the Roman Catholic Church, as it is in conflict with the established reliance of that Church upon tradition, and upon what is called "Catholic content." One of the ablest of modern Romanist writers, Rowson, has written powerfully against the development theory (in his *Quart. Review*). Extremes meet; the Rationalistic theory agrees with the Romanist (in Fr. Newman's view of it) in representing the system of Christianity delivered in the New Testament as defective and imperfect. The Council of Trent declared *sess. iv*) as follows: "The sacred and holy, oecumenical and general Council of Trent, keeping always in view the removal of errors and the preservation in the Church of the purity of the Gospel, which Gospel, before promised through the prophets in the Holy Scriptures, was first orally published by our Lord Jesus Christ, the Son of God, and then commanded to be preached by his apostles to every creature, as the fountain both of every saving truth and discipline of morals; and perceiving that this truth and discipline are contained in the written books, and the unwritten traditions which, received by the apostles from the mouth of Christ himself, or from the apostles themselves, the Holy Ghost dictating, have come down even unto us, transmitted as it were from hand to hand; [the council] following the examples of the orthodox fathers, receives and venerates with equal affection of piety and reverence all the books both of the Old and of the New Testament, seeing that one God is the author of both, as also the said traditions, as well those appertaining to faith as to morals, as having been dictated either by Christ's own word of mouth or by the Holy Ghost, and preserved by a continuous succession in the Catholic Church." Mr. Newman's book was ably answered by W. Archer Butler, *Letters on Romanism* (Cambridge, 1854, 8vo). The following remarks of Julius Charles Hare (*Mission of the Comforter*, note G) are in point: "Some of the German apologists for Romanism, having perceived, as could not but happen in a country where learning and criticism have found a home, that the old plea of a positive, unwritten tradition in the Church was utterly untenable as a ground for the doctrinal and practical innovations of later times, have fancied that they might render their Church a service by taking up the popular and modern theory of the development of mankind—a theory which has been carried into the most outrageous extravagances in the contemporary schools of philosophy, as it has also been in France by the St. Simonians. This theory has been used by others to show that Christianity itself is a transient religion, belonging to a by-gone period and almost obsolete; they have tried to employ it in defence of the Church of Rome. Herein, however, it was impossible for them to succeed. That Church, whose constant effort, since the time when it cut itself off from the living body of Christ, has been to check, to repress, to cramp, to fetter the mind, could not find support in a theory which implies the freedom of the mind; nor can any Church, unless it recognises, both doctrinally and practically, that the property of truth is to set the mind free."

4. The following section was prepared for this Cyclopaedia by the late Dr. Harbaugh just before his death. We print it as he left it, though it involves a little repetition of what has been given above.

Development.—This word, related primarily to the sphere of organic life in the natural world, has also come to perform important service in science, especially in psychology, philosophy, theology, and history. In the earlier stages of science generally, the data and

phenomena were classified and arranged according to the outward peculiarities which they presented. In time, however, and especially under the influence of Christianity, as the key to the deepest life of the world, scientific thinking felt itself urged to a deeper apprehension of all kinds of phenomena. The mechanical and outward in systematizing accordingly had to give way to the determining power of mere inward principles.

Thus it has come to pass that while science, so far as it has been apprehended and advanced by non-Christian thinking, has been, for the most part, satisfied with the word *progress*, science grounded in the distinctively Christian principle has found the word development indispensable. The word, as thus used, presupposes a distinctive theory of the essence of Christianity, and so also of the Church, its history and its dogmas, as well as of affiliated sciences, such as psychology and philosophy. It finds inadequate the view of the essence of Christianity which resolves it into the idea of *doctrine*, as in Supranaturalism; so also the view which makes it only an ethical force, law, or *rule of life*, as set forth in the school of Kant and by Rationalism; and so, moreover, the conception that it is, in its essential character, a mere power of redemption operative in the *sphere of religious feeling*, according to Schleiermacher and the Mystics. Admitting and appreciating all these as secondary and dependent, it holds that Christianity is primarily and essentially a *life*—the divine-human life of its founder, Jesus Christ—which becomes the deepest life of renewed humanity, of history, and of science (see Ullman, *Distinctive Character and Essence of Christianity*). Life being essentially *organic*, it must have the word development to indicate that unfolding from a germ-like inward principle which is the distinctive characteristic of organic life. To the genetic processes involved in the activities of life it applies the word development. "This idea of an organic, steadily improving development of humanity, according to a wise, unalterable plan of Providence, is properly as old as Christianity, meets us in many passages of the New Testament (Matt. xiii, 31, 32; Ephes. iv, 12-16; Coloss. ii, 19; 2 Pet. iii, 18), and in occasional remarks of the early fathers, such as Tertullian and Augustine; and was brought out in the 18th century with peculiar emphasis and freshness by the genial Herder, in his 'Ideas on the Philosophy of the History of Humanity' (784), so highly valued by the gifted historian of Switzerland, John von Müller" (see Herder's *Sämmtliche Werke, zur Phil. und Gesch.* Theil iii, § 74 sq.). "The more mature and philosophical conception of it, however, and the impulse which it gave to a deeper and a livelier study of history, are due especially to the philosophy of Schelling, and, still more, of Hegel. With Hegel, all life and thought is properly development, or a process of organic growth, which he calls *Aufhebung*—that is, in the threefold sense of this philosophical term so much used by him, (1.) an abolition of the previous imperfect form (an *aufheben*, in the sense of *tollere*); (2.) a preservation of the essence (*conserve*); and (3.) an elevation of it to a higher stage of *existence* (*elevare*)" (Dr. Schaff's *History of the Apost. Church*, p. 90, 91).

The conception of development has, however, also been carried out of its proper Christian sense, and perverted to the service of anti-Christian systems of thought. Thus Pantheism, laying hold upon some insufficiently guarded point in the Hegelian theory, has employed it in its scheme. The one school of Hegel, denying with him the existence of a personal God, as the creator of all principles of created life, proposes to account for all animated existence by a theory of development starting in matter, ideas, or thought (all of which, however, it leaves vague and floating), holding that nature through successive upward gradations ultimately reaches self-consciousness in the human spir-

it, and thus also God himself comes to exist in the form of the general human consciousness, the world-idea, the self-manifestation of the idea of God, "who is at once the manifestation and the moment of the process of the development and actualization of his substance as the absolute spirit" (Herzog, *Real-Encyclop.* v, 629). Nor has Rationalism failed to seize upon and pervert the Christian conception of development for its use. Leaving out of view and ignoring the nature of Christianity as a life, it acknowledges no life-principle in Christianity; consequently breaks with all genetic, traditional, or historical processes, and proposes a progress of moral enlightenment which shall advance beyond Christ, the Church, and Revelation. Its processes and progress, which it calls development, starting in revolution, can present only a history of deterioration and corruption. The Christian idea of development, properly used, leaves no room for such-like revolution and negative progress. Substantially into this snare Prof. Bush has fallen, in the otherwise just and valuable discussion by which he introduces his work on the Resurrection (*Anastasis, the Introduction*, p. 18-29). The Roman Catholic convert, *John Henry Newman*, has also a theory of development, which, however, seems to be rather a development in the sphere of ideas than of facts—of life; hence it is rather mechanical and philosophical than organic and Christian. It moves more in the region of subjective mental processes than in the objective essential life of Christianity. It is consequently of little actual account either as a polemic against the Protestant idea of development, or as fixing on a firmer and more consistent basis the dogmas of the Roman faith, over into which he passed while his work (which actually marked his transition) was going through the press (*Essay on the Development of Christian Doctrine*). The Roman theory can conceive of no development except in the way of progress that needs as such to be outwardly measured by referring itself to an outward infallible authority in the pope. But "such development requires no 'infallible earthly head' for its direction and conduct, just as little as a living oak needs to be built up by line and compass. An authority of this sort, supposed to supersede the free working of the intelligence and will of the Church itself, would be the source of petrification and stagnation only, not of development. This implies freedom, ethical activity, life poised upon itself as a principle and centre. It is just the stability system which in every shape turns into mechanism and leads to popery" (Nevin, *Mercersburg Review*, i, 518, 514).

See, besides the works cited in the course of this article, Trench, *Hulsean Lectures*, 1845-46, lecture v; Lord's *Theological and Literary Journal*, April, 1854, art. vi; Hampden, *Bampton Lectures* for 1882, lect. viii; Soames, *Latin Church during Anglo-Saxon Times*, chap. xii; Craik, *Old and New* (N. Y. 1860), p. 226 sq.; Schaff, *What is Church History* (Philadel. 1846, 12mo); *English Review*, various articles in vols. iv, vi, ix, xi; Cunningham, *Historical Theology*, i, 210 sq.; *American Presb. and Theol. Review*, Oct. 1867, art. iv; Donaldson, *Critical History of the first three Centuries*.

Devil (ὁ διάβολος, of which the English term is but a variation). This term signifies one who travesties another's character for the purpose of injuring it, a slanderer, and is sometimes applied to any calumniator, e. g. a gossip-monger (1 Tim. iii, 11; 2 Tim. iii, 8; Titus ii, 3); but it is spoken especially, by way of eminence, of the arch enemy of man's spiritual interest, whom the Jews represented as continually impugning the character of saints before God (comp. Job i, 6; Rev. xii, 10; Zech. iii, 1). See ACCUSER. In 1 Pet. v, 8, he is expressly called "the accuser (*ἀντιδικός*) of the brethren," with a reference to forensic usages. See ADVOCATE. The word is found in the plural number and adjective sense in 1 Tim. iii, 11; 2 Tim. iii, 8; and Tit. ii, 3. In all other cases it is used

with the article as a descriptive name of Satan, except that in John vi, 70, it is applied to Judas a "Satan" to Peter in Matt. xvi, 23), because they—the one permanently, and the other for the moment—were doing Satan's work. (On John xi, 31, see Lagherard's *Commentatio*, Erf. 1794; Hane, *Scriptur.* p. 51-75; on Heb. ii, 14, Anon. *De Diabolo*, Göt. 1783; Oestmann, *De loco 1 Pet. v, 8*, Gryph. 1816). The name describes him as slandering God to man, and man to God. See DIABOLUS. *a.* The former work is of course, a part of the great work of temptation to evil and is not only exemplified, but illustrated, as in a general nature and tendency, by the narrative of Gen. iii. We find there that its essential characteristic is the representation of God as an arbitrary and selfish ruler, seeking his own good, and not that of his creatures. The effect is to stir up in man the spirit of freedom to seek a fancied independence; and it is but a slight step further to impute falsehood or cruelty to God. The success of the devil's slander is seen as only in the scriptural narrative of the Fall, but in the corruptions of most mythologies, and especially in the horrible notion of the divine *φθόνος*, or envy, which ran through so many (see, e. g. Herod. i, 32; vii, 4). The same slander is implied rather than expressed in the temptation of our Lord, and its overcome by the faith which trusts in God's love even where its signs are hidden from the eye (comp. the unmasking of a similar slander by Peter in Acts v, 4). *b.* The other work, the slandering or accusing of man before God, is as it must naturally be, unintelligible to us. The All-seeing Judge can need no accuser, and the All-Powerful could, it might seem, have no intercourse with the Evil One. But, in truth, the question touches on the mysteries, the relation of the Infinite to the finite; and it, and the permission of the existence of evil under the government of him who is "the Good." As a part of these it must be viewed—to the latter especially it belongs; and this latter, while it is the great mystery of all, is also one in which the facts are proved to us by incontrovertible evidence.—Smith, s. v. See SATAN.

The word "devil" also often stands, but improperly, in our version as a rendering of *δαίμων*, an impure spirit from the other world acting upon a human being. See DEMON.

In Lev. xvii, 7, the word translated "devil" is *שָׂטָן* (*sa'ir*, hairy), ordinarily a "goat," but rendered "satyr" in Isa. xlii, 21; xxxiv, 14; probably alluding to the wood-demons, resembling he-goats, supposed to live in deserts, and which were an object of idolatry and beastly worship among the heathen. See SATYR.

The term rendered "devil" in Deut. xxxii, 17; Ps. cvi, 37, is *שֵׁט* (*shed*, properly lord, Sept. and Vulg. *dæmon*), an idol, since the Jews regarded idols as demons that caused themselves to be worshipped by men. See IDOLATRY.

The belief of the Hebrews down to the Babylonian exile seems but dimly to have recognised either Satan or demons, at least as a dogmatic tenet, nor had it any occasion for them, since it treated moral evil as a properly human act (comp. Gen. iii), and always as subjective and concrete, but regarded misfortune, according to theological axioms, as a punishment deserved on account of sin at the hands of a righteous God, who inflicted it especially by the agency of one of his angels (2 Sam. xxiv, 16; comp. 2 Kings xix, 35), and was accordingly looked upon as the proper author of every afflictive dispensation (Amos iii, 6). Apparitions were part of the popular creed: there were beings inimical to mankind inhabiting solitudes, but not yet adopted in the association of religious ideas. See SPECTRE. The Azazel (q. v.) is thought by many to have been held to be such a demon; yet, if we grant even this, it still remains but an isolated being, one might almost say, a mere liturgical idea. Neverthe-

, it cannot be denied that these representations are fitted to serve as introductory to dogmatic dæmology, when the belief was eventually carried out to full conclusion. The period of the exile is the era of this development; and when also the Median tenets of Ahriman and his emanations came in direct contact with the Israelitish faith, they exerted so powerful an influence in drawing out the natural conceptions that the Amahaspands of the Zendæsta (q. v.) are strongly reflected in the Jewish analogy. Earlier, indeed, a Satan, so called by way of eminence, occasionally appears as the malicious author of human misfortune, but only under the divine overruling: e. g. he incites David to a sinful act (Chron. xxi, 1); casts suspicions upon Job's piety (Job i, 6 sq.), and, with Jehovah's permission, inflicts on him a lot gradually more severe to the utmost limit of endurance; appears as the mendacious slanderer (ὁ κατήγορος, Rev. xii, 10) of the high-priest Joshua before the Angel of God, but draws upon himself the divine malediction (Zech. iii, 1 sq.). Yet in this he is as little like the Ahriman of the Zendæsta (Rhode, *Heil. Sage*, p. 182 sq.; Matthäi, *Religionsgeschichte d. Apostel*, II, i, 171 sq.; Creuzer, *Symbol.* i, 705) as an indifferent prosecuting attorney-general or judicial superintendent commissioned by Jehovah: ill-will actuates him, and desire for the misery of the pious. Dæmons are not mentioned in the nonical books of the Old Test., unless (with many interpreters) we understand "the host of the high heavens" in Isa. xxiv, 21 (צְבָאֵי הַשָּׁמַיִם, *army of the lofty*, comp. Dan. viii, 10), of the evil angels (comp. Isa. xiv, 2), and interpret the whole passage as referring to their punishment. See LUCIFER. In the Apocrypha, the old Hebrew notion of Jehovah's angels who allot disaster occurs but partially, and in case mishap overlooks the enemies of the pious, the angels are alluded to as auxiliaries and friends of the latter (2 Macc. xv, 3 sq.), although we may search in vain such passages or a single mention of dæmons. On the other hand, the books of Tobias and Baruch are full of representations concerning them (*δαίμονια*), while they never refer to Satan. These beings dwell in waste places (Bar. iv, 35; Tob. viii, 3; comp. Sept. at Isa. xlii, 21; xxxiv, 14); also ruins (Gemara, *Berachoth*, p. 16, Rabe's trans.; they are the heathen gods, Bar. iv, 7; comp. Sept. at Psa. cxv, 5; 1 Cor. x, 20); but mingle among men, take their abode in them as tormenting spirits (Tob. vi, 9), and can only be expelled by mystical means (Tob. vi, 20). One of them, Asmodeus (q. v.), is licentious (on the lust of dæmons as being signified in Gen. vi, 2, see the book of Enoch, ch. vii, and the *Testam. Reuben*, c. 5, in Fabricii *Pseudepigr.* V. T. i, 530), falls in love with a beautiful maiden, and through jealousy kills her seven successive bridegrooms on the wedding night (Tob. iii, 8; comp. vi, 15). In the book of Wisdom (ii, 24), the devil (ὁ διάβολος) comes plainly forward as an interpretation of the serpent that seduced Eve (Gen. iii) the *Targum* of Jonathan actually names, at Gen. iii, 6, *Sammael* as the "angel of death," מַלְאָכֵי מוֹת: see Gerlach, *De angelo mortis*, Hal. 1734), and here the Zend-avestic parallel becomes more evident (the serpent was a symbol of Ahriman, Creuzer, *Symbol.* i, 724). Josephus knows nothing of Satan, but dæmons (*δαίμονες* or *δαίμονια*), souls of dead men (*War*, vii, 6, 8), are with him tormenting spirits, which take possession of men (ib.), and inflict upon them severe, incurable diseases, particularly of a psychical character (*Ant.* vi, 8, 2; 11, 8, in explanation of 1 Sam. xvi, 14). Their expulsion can be effected (see Gemara, *Berachoth*, p. 28, Rabe's tr.) by magical formulæ (*Ant.* viii, 2, 5) and mystical means (*War*, vii, 6, 8). Such dæmoniacs (*δαίμονιζόμενοι*) are, as is well known, mentioned in the gospels, and Jesus restored many of them by a simple word. See POSSESSED (WITH A DEVIL). But per-

haps the dæmology of the New Test. is exhibited in a more strictly dogmatic light than any other. The dæmons have Satan as their chief (ἀρχων, Matt. xii, 24), dwell in men as "unclean spirits" (πνεύματα ἀκάθαρα or πονηρά, Matt. xii, 43; Luke viii, 2; x, 20; xi, 24; Eph. vi, 12; one inferior to the other, Luke xi, 26), and induce maladies as "spirits of infirmities" (πνεύματα ἀσθενειῶν, Luke viii, 2; xiii, 11; comp. 1 Cor. v, 5; 1 Tim. i, 20). They appear in association with Satan in the Apocalypse (Rev. xii, 7, 9; xvi, 18 sq.). Satan himself (ὁ Σατανᾶς, ὁ Διάβολος, ὁ πονηρός, Βεελζεβούλ [see BEELZEBUB], Βελιάλ [בְּלִיָּאֵל] or Βελίαρ, 2 Cor. vi, 15 [see BELIAL]), is the originator of all wickedness and mischief (Luke x, 19; xi, 16; xxii, 31; Acts v, 8; 2 Cor. xi, 3; Eph. ii, 2), therefore the opponent (ὁ ἐχθρός) of the kingdom of God (Matt. xiii, 39; Luke x, 18; xxii, 3 sq.; for whose subjugation Christ came, John xii, 31; xiv, 30; xvi, 11), and the tempter (ὁ πειράζων) of the faithful (1 Cor. vii, 5; 1 Thess. iii, 5; 1 Pet. v, 8 sq.), as Jesus himself was tempted by him in the beginning of his ministry (Matt. iv). Satan's first act towards mankind was the leading of Eve into sin (2 Cor. xi, 3; comp. Rev. xii, 9; John viii, 44), and so he became the originator and king of death (1 Cor. xv, 26; Heb. ii, 14; the *Sammael*, מַלְאָכֵי, of the later Jews, see Buxtorf, *Lex. Chald.* col. 1495). He and his angels (Rev. xii, 9; comp. 2 Cor. xii, 7), i. e. apparently the dæmons, were originally created good (inasmuch as from the hand of God only good can come, but against him, the Creator of the universe, no opposing being could originally exist); but through their own fault they fell (John viii, 44 [?]; 2 Pet. ii, 4; Jude 6); yet they rule in the kingdom of darkness (Eph. vi, 12; comp. Col. i, 13; roving about in the atmosphere, Eph. ii, 2), as well as over all mankind alienate from God (ὁ κόσμος, as *κόσμοκράτορες*, Eph. vi, 12; but Satan as ἀρχων τοῦ κόσμου τούτου or θεὸς τοῦ αἰῶνος τούτου, John xii, 31; xiv, 30; xvi, 11; 2 Cor. iv, 4; Eph. ii, 2), although destined to a future fearful sentence (2 Pet. ii, 4; Jude 6), when Christ shall appear to overthrow the kingdom of Satan (1 John ii, 8); indeed, Satan has already through him received his condemnation (John xii, 31; xvi, 11; comp. Heb. ii, 14). The later speculations of the Jews on the subject of Satan and dæmons may be seen in Eisenmenger (*Entdeckt. Judenth.* ii, c. 8, p. 408 sq.). The Targums often introduce Satan into the O. T. text; in fact, whenever an opportunity presents itself (e. g. Jonath. on Exod. xxxii, 19; Lev. ix, 2). On this subject, see especially Mayer, *Historia Diaboli* (2d ed. Tub. 1780); Ode, *De angelis* (Traj. ad Rh. 1739), sect. 4, p. 468 sq.; Schmidt, in his *Biblioth. für Krit. u. Exegese*, i, 525 sq. ("Comparison of the New-Test. dæmology with the Zendic books"); Winzer, *De demonologia in N. T. proposita* (Viteb. 1812, Lips. 121, incomplete); Matthäi, *Religionsgeschichte d. Apostel*, II, i, 98 sq.; Cölln, *Bibl. Theol.* i, 423 sq.; ii, 69 sq.; 229 sq.; M. Stuart, in the *Bibliotheca Sacra* (1848), i, 120 sq.—Winer, ii, 888. See ANGEL; EXORCISM; SATAN.

Devil-worshippers. See YEZIDITES.

Devoted thing. See ANATHEMA.

Devotee. "In the primary sense of the word, means a person wholly given up to acts of piety and devotion; but it is usually understood, in a bad sense, to denote a bigot or superstitious person—one addicted to excessive and self-imposed religious exercises."—Buck, *Theol. Dictionary*, s. v.

Devotion (Lat. *devoeo*, to give up one's self wholly to any object). "It is employed to mean either, 1, that religious habit of the mind which is otherwise called devoutness; or, and more commonly, 2, the expression of such a state of mind in particular acts and instances of a religious nature. A spirit of devotion is one of the greatest blessings, and the want of it one

of the greatest misfortunes, which a Christian can experience. When it is present, it gives life to every act of worship we perform; it renders every such act interesting and comfortable to ourselves. It is experienced in our most retired moments; in our beds, in our closets, our rides, and our walks. It is felt within us when we are assembled with our children and servants in family prayer. It leads us to church, to the congregation of our fellow-Christians there assembled. In an especial manner it accompanies us in our joint offices of religion, and it returns us to our homes holier, happier, and better. But that which greatly enhances its value to every anxious Christian is that it affords to himself a proof that his heart is right towards God. When it is followed by an abstinence from sin and endeavors after virtue, by avoiding evil and doing good, the proof and the satisfaction to be drawn from it are complete. Wherever the vital and unadulterated spirit of Christian devotion prevails, its immediate objects will be to adore the perfections of God; to entertain with reverence and complacency the various intimations of his pleasure, especially those contained in holy writ; to acknowledge our absolute dependence on and infinite obligations to him; to confess and lament the disorders of our nature and the transgressions of our lives; to implore his grace and mercy through Jesus Christ; to intercede for our brethren of mankind; to pray for the propagation and establishment of truth, righteousness, and peace on earth; in fine, to long for a more entire conformity to the will of God, and to breathe after the everlasting enjoyment of his friendship. The effects of such a spirit, habitually cherished and feelingly expressed before him, must surely be important and happy. Among these may be reckoned a profound humility in the sight of God, a high veneration for his presence and attributes, an ardent zeal for his worship and honor, a constant imitation of our Saviour's divine example, a diffusive charity for men of all denominations, a generous and unwearied self-denial, a total resignation to Providence, an increasing esteem for the Gospel, with clearer and firmer hopes of that immortal life which it has brought to light" (Paley, *Sermons*, Ser. vi).

Dew (לַי, *tal*, gentle moisture; Gr. ὀρόρος) is mentioned as falling in the East (Maundrell, p. 77; Robinson, iii, 479), e. g. in Babylon (Dan. iv, 12, 22), likewise in Palestine during the summer nights (Baruch, ii, 26), so heavy as to wet like a moderate rain (Cant. v, 2; Judg. vi, 38), the absence of which it somewhat supplies (Ecclus. xviii, 16; xliii, 22), greatly cooling the earth heated by day (comp. Curt. vii, 5, 6), and refreshing vegetation (Hasselquist, p. 264; Volney, i, 51; Rosenmüller, *Morgenl.* i, 122). Thus it is coupled in the divine blessing with rain, or mentioned as a prime source of fertility (Gen. xxvii, 28; Deut. xxxiii, 13; Zech. viii, 12), and its withdrawal is attributed to a curse (2 Sam. i, 21; 1 Kings xvii, 1; Hag. i, 10). See IRRIGATION.

The value of this blessing cannot be adequately appreciated by the Western reader; but in Palestine, and indeed throughout Western Asia, rain rarely if ever falls from April to September, and the heat of the sun being at the same time very strong, all vegetation would be parched and dried up were it not for the copious dews which fall during the night and completely moisten the ground, keeping in a fertile condition lands which would otherwise be sterile and desolate. But all this moisture evaporates with astonishing rapidity as soon as the sun has risen. It seems that the advantage of these abundant dews is not generally enjoyed except in regions more or less hilly or elevated, or in confined valleys. In extensive open plains and deserts, it does not seem that any copious dews fall in summer. But in such tracts no men can inhabit except the wandering tribes, and towns and villages are only found on the banks of natural or artificial streams;

nor, unless in the same situations, is any cultivated attempted where there are no night dews in season to compensate for the want of rain (Kitto, *Phys. Ant.* note on Gen. xxvii, 28). See FLECKE. The various passages of Scripture in which dew is mentioned, as well as the statements of travellers, might, however, unless carefully considered, convey the impression that in Palestine the dews fall copiously at night during the height of summer, and supply in some degree the lack of rain. But we find that those who were dews travelled in spring and autumn, while those who travelled in summer make no mention of them. In fact, scarcely any dew does fall during the summer months—from the middle of May to the middle of August; but as it continues to fall for some time after the rains of spring have ceased, and begins to fall before the rains of autumn commence, we may from thence gather the sense in which the scriptural references to dew are to be understood. Without the dews continuing to fall after the rains have ceased, and commencing before the rains return, the season of acute drought, and the parched appearance of the country, would be of much longer duration than they really are. See DROUGHT. The partial refreshment afforded to the ground at the end of a summer without dews or rains, is of great value in Western Asia, and would alone explain all the Oriental references to the effects of dew. This explanation is of further interest as indicating the times of the year to which the scriptural notices of dew refer; for as it does not, in any perceptible degree, fall in summer, and as few would think of mentioning it in the season of rain, we may take all such notices to refer to the months of April, May, part of August, and September (Kitto, *Phys. Hist. of Palest.* p. ccci). See SEASONS.

Dew, as consisting of innumerable drops, is put as the symbol of multitude (2 Sam. xvii, 12); thus, in Psalms, cx, 3, from the womb of the morning shall be the dew of thy youths, i. e. the youth of thy people numerous and fresh as the drops of the morning dew shall go forth to fight thy battles (comp. Mic. v, 6). It becomes a leading object in prophetic imagery by reason of its penetrating moisture without the apparent effort of rain (Deut. xxxii, 2; Job xxix, 19; Isa. cxxxiii, 3; Prov. xix, 12; Isa. xxvi, 19; Hos. xii, 5; Mic. v, 7). It is mentioned as a token of exposure in the night (Cant. v, 2; Dan. iv, 15, 23, 25-33; v, 2). Also the morning dew is the symbol of something evanescent (Hos. vi, 4; xiii, 3). From its soothing and refreshing influence, dew is sometimes made an emblem of brotherly love and harmony (Psa. cxxxxiii, 3). See Wemyss's *Symbol. Dict.* s. v. See RAIN.

De Wette. See WETTE, DE.

De Witt, JOHN, D.D.; born at Kingston, N. Y. Dec. 15, 1788; the son of a worthy farmer; graduated at Nassau Hall, Princeton, N. J. 1809; began the study of the law, but, after his conversion, studied theology with Rev. Dr. Porter, of Catskill; was licensed in 1811 in the ministry of the Presbyterian Church; was first settled at Lanesboro, Mass., and in 1813 became a pastor in the Reformed Dutch Church, Albany, N. Y. After a very successful career as pastor, he was in 1822 elected professor of Biblical Criticism, Ecclesiastical History, and Pastoral Theology in the Theological Seminary of the Reformed Protestant Dutch Church at New Brunswick, N. J. This chair he filled with great acceptance until his death, which occurred Oct. 11, 1823, in the 42d year of his age. Dr. De Witt was a man of fine personal appearance, of a generous nature, of tender sympathy, of deep piety and religious earnestness. He was an eloquent and powerful preacher, a learned and successful professor. His manuscript sermons were of a high order. Of his productions in print we know only of a sermon in memory of the Rev. Dr. John H. Livingston, and one at

generation. His early death blighted many hopes which his genius and eminent abilities had inspired.

Dexioläbus. See SPEARMAN.

Deyling. SALOMON, a German theologian, was born at Leipsig, in 1677, at Weida, in Voigtland. He struggled with poverty to gain his elementary education, and completed his studies at the University of Wittenberg, where he became master in 1699. In 1708 he became a member in the faculty of philosophy, and in 1710 doctor in theology. In 1716 he was made general superintendent at Eisleben, in 1720 pastor in the Nicolai-church at Leipsig, and during the rest of his life was professor of theology there. He died August 5, 1755.

He wrote *Dissert. de corrupto Ecclesie Romanae statu sub Lutherum*, etc. (Wittenberg, 1784, 4to); *Observationes Sacrae* (Leips. 1735-89, 3d edit. 5 vols. 4to), containing illustrations and critical remarks upon difficult parts of Scripture; also *Observationes Miscellaneae* (Leips. 1786, 4to), on questions of exegesis and Church history; *Observationum Sacrarum pars v* (Leips. 1748, 8vo). For a list of his writings (89 in number), see *Leipsig, Die gelehrten Theologen Deutschlands*, i, 822.

D'Holbach. See HOLBACH.

Diabölus, the Lat. form of the Gr. διάβολος, Engl. 'devil,' i. e. properly an *accuser*, a *calumniator*. We rely meet with this word in versions of the Old Testament. Sometimes it answers to the Hebrew *Belial*, sometimes to *Satan*. The Ebils of the Mohammedans is the same with our *Lucifer*; and the name is similar to that of Diabolus. The Mussulmans call him likewise *szazel*, which is the Scripture name for the scape-goat, and is probably the Azazel of the *Book of Enoch* (q. v.). They maintain that Eblis was called by this name, signifying *perdition*, or *refractory*, which is nearly the meaning of *Belial*, because, having received orders to reprobate himself before Adam, he would not comply, under pretence that, being of the superior nature of fire, he ought not to bend the knee to Adam, who was formed only of earth. Diabolus sometimes signifies the evil, as Wisd. ii, 24; sometimes an accuser, an adversary who prosecutes before the judges, as Psa. cix, 6; Eccles. xxi, 27.—Calmet, s. v. See DEVIL.

Diaconate, the office or order of a *deacon* (q. v.).

Diaconicum (*Gr.* and *Lat.*). This word has different significations in ecclesiastical authors. Sometimes it is taken for that part of the ancient church in which the deacons used to sit during the performance of divine service, namely, at the rails of the altar; sometimes for a building adjoining to the church, in which the sacred vessels and habits were laid up; sometimes for that part of the public prayers which the deacons pronounced. Lastly, it denotes an ecclesiastical book, in which are contained all things relating to the duty and office of a deacon, according to the rites of the Greek Church.—Hook, *Church Dictionary*, s. v.

Diadem is the rendering of several Heb. words in the Auth. Vers. of the Bible: מִטְנֵה פֶּהֶת (*mitneh' pheth*, something wrapped around the head), spoken of the tiara of a king ("diadem," Ezek. xxi, 81), elsewhere of the turban of the high-priest ("mitre"); כִּנִּיף (*kaniph'*, something wound about the head), spoken of the turban of men ("diadem," Job xxix, 14), of women ("hood," Isa. iii, 28), of the high-priest ("mitre," Zech. iii, 5), and the tiara of a king ("diadem," Isa. lxii, 8, where the text reads כִּנִּיף, *tsanuph'*), and צִפְרִיחַ (*tsaphirah'*, a circlet), spoken of a royal tiara ("diadem," Isa. xxviii, 5). See HEAD-DRESS. All these terms occur in poetical passages, in which neither the Hebrew nor the English words appear to be used with any special force, except the first. See MITRE. But in Greek the distinction between διάδημα (only Rev. xii, 8; xiii, 1; xix, 12), or *diadem*, as the badge of royalty, and στέφανος, or *crown*, as a

conventional mark of distinction in private life, is carefully observed (see Trench, *Synonymes of the New Testament*, p. 112 sq.). See TURBAN.

What the "diadem" of the Jews was we know not. That of other nations of antiquity was a fillet of silk, two inches broad, bound round the head and tied behind, the invention of which is attributed to Liber (Plin. *Hist. Nat.* vii, 56, 57). Its color was generally white (Tacitus, *Ann.* vi, 87; Sil. Ital. xvi, 241); sometimes, however, it was of blue, like that of Darius, *carulea fascia albo distincta* (Q. Curt. iii, 8; vi, 20; Xenoph. *Cyr.* viii, 3, 18), and it was sown with pearls or other gems (Zech. ix, 16; Gibbon, i, 892), and enriched with gold (Rev. ix, 7, where, however, the text has στέφανος). It was peculiarly the mark of Oriental sovereigns (1 Macc. xiii, 82, τὸ διάδημα τῆς Ἀσίας), and hence the deep offence caused by the attempt of Cæsar to substitute it for the laurel crown appropriated to Roman emperors (Cicero, *Phil.* ii, 84); when some one crowned his statue with a laurel-wreath (*candida fascia preli-gatam*), the tribunes instantly ordered the fillet or diadem to be removed and the man to be thrown into prison (Sueton. *Cæs.* 79). Caligula's wish to use it was considered an act of insanity (Sueton. *Cal.* 22). Heliogabalus only wore it in private. Antony assumed it in Egypt (Flor. iv, 11), but Diocletian (or, according to Aurel. Victor, Aurelian) first assumed it as a badge of the empire. Representations of it may be seen on the coins of any of the later emperors (Tillemont, *Hist. Imp.* liii, 531). A crown was used by the kings of Israel even in battle (2 Sam. i, 10; similarly it is represented on coins of Theodosius as encircling his helmet); but in all probability this was not the state crown (2 Sam. xii, 80), although used in the coronation of Joash (2 Kings xi, 12). Kitto supposes that the state crown may have been in the possession of Athaliah; but perhaps we ought not to lay any great stress on the word כִּנִּיף in this place, especially as it is very likely that the state crown was kept in the Temple. In Esth. i, 11; ii, 17, we have כִּתְרוֹן (Sept. *κίραρις*, *κίραρις*) for the turban (*στολή βυσσίνη*, vi, 8) worn by the Persian king, queen, or other eminent persons to whom it was conceded as a special favor (viii, 15, *διάδημα βύσσινον πορφύρεον*). The diadem of the Persian king differed from that of others in having an erect triangular peak (*κυρβασία*, Aristoph. *Av.* 487; Suid.



Tetradrachm of Tigranes, king of Syria, with the Oriental tiara instead of the simple diadem of the earlier kings or Seleucidae.

See also the illustration of a diadem on the right side of the page, showing a profile of a head wearing a crown with a triangular peak, surrounded by a decorative border.

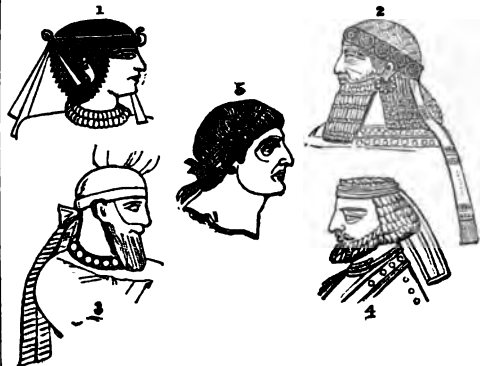

Ancient Diadema.

1. Egyptian (Wilkinson's *Anc. Egypt.*); 2. Of Sardanapalus III (Assyrian Sculptures, Brit. Museum); 3. Persopolitan (Sir R. K. Porter's *Travels*); 4. Parthian (Coin of one of the Arsacidae); 5. Jewelled, of Constantine (Coin in Brit. Mus.).

s. v. *tiara*; and Hesych.). Possibly the *קַרְנֵי הַדָּן* of Dan. iii, 21 is a tiara (as in Sept., where, however, Drusius and others *invert* the words *kai tiarais kai pericraniois*), A. V. "hat." Some render it by *tibiale* or *calcamentum*. Schleusener suggests that *κρωβυλος* may be derived from it. The tiara generally had pendent flaps falling on the shoulders. (See Paschalius, *de Corona*, p. 578; Brissonius, *de Regn. Pers.* etc.; Layard, ii, 320; Scacchus, *Myrothec.* iii, 38; Fabricius, *Bibl. Ant.* xiv, 13). The words *קַרְנֵי הַדָּן*, "exceeding in dyed attire upon their heads," in Ezek. xxiii, 15, mean long and flowing turbans of gorgeous colors (*Sept. παράβατρα*, where a better reading is *τιάραι βατραί*).—Smith, s. v. See CROWN.

DIADEM. See NIMBUS.

Diadōchus, MARCUS, a Greek theologian, who probably lived in the 4th century. Nothing is known of him except that he was the author of a small work against the Arians, entitled *Τῷ μακαρίου τοῦ Διαδόχου κατὰ Ἀρειανῶν λόγος* (*Beati Marci Diadochi Sermo contra Arianos*), and published by J. K. Wetstein as an appendix to his edition of Origen's *De Oratone* (Basel, 1694, 4to; reprinted, with a new Latin translation, in the *Bibliotheca Patrum* of Galland, vol. v). Some writers suppose that Diadochus was one of two Egyptian bishops by the name of Mark who were banished by the Arians during the patriarchate of George of Cappadocia, restored during the reign of Julian, and mentioned in a letter of Athanasius to the Antiochians as being present at the synod held at Alexandria in 362. According to the conjecture of Galland, Mark Diadochus was one of two bishops named Mark who were ordained priests by Alexander, the predecessor of Athanasius, and exiled by the Arians; the one to the great oasis (Upper Egypt), the other to the oasis of Ammon. It may be that these two Marks were the same as the two preceding ones.—Hoefler, *Biographie Générale*, xiv, 21.

Dial (*מַעְלֵי הַדָּן*, *maaloth'*; the plur. of an *ascent*, as it is sometimes rendered; Sept. *ἀναβαθμοί*, Vulg. *horologium*), a method of measuring time employed by Ahaz (2 Kings xx, 11; Isa. xxxviii, 8). The word is the same as that rendered "steps" in Exod. xx, 26; 1 Kings x, 19, and "degrees" in 2 Kings xx, 9, 10, 11; Isa. xxxviii, 8, where, to give a consistent rendering, we should read with the margin the "degrees" rather than the "dial" of Ahaz. In the absence of any materials for determining the shape and structure of the solar instrument, which certainly appears intended, most interpreters follow the most strictly natural meaning of the words, and consider, with Cyril of Alexandria and Jerome (*Comm. on Isa.* xxxviii, 8), that the *maaloth* were really stairs, and that the shadow (perhaps of some column or obelisk on the top) fell on a greater or smaller number of them according as the sun was low or high. The terrace of a palace might easily be thus ornamented. Dr. Adam Clarke, in his *Commentary* on 2 Kings xx, 10, 11, however, gives some ingenious illustrations, accompanied by a diagram, and others may be seen in Calmet's *Dictionary*, s. v. See DEGREE.

The invention of the sun-dial belongs most probably to the Babylonians. Herodotus affirms that the Greeks derived from them the pole (*πῶλος*, supposed to mean the dial-plate), the gnomon, and the division of day into twelve parts (ii, 109). Vitruvius also ascribes the most ancient form of the dial, called hemicycle, to Berosus the Chaldean (ix, 9), though he probably means no more than that he introduced it into Greece. Certainly those Greeks to whom Vitruvius ascribes inventions or improvements in dialling can be proved to have had communication, more or less

remote, with the Chaldeans. The first mention in Scripture of the "hour" is made by Daniel, at Babylon (ch. iii, 6), although it is possible that Ps. ciii and cix, 23, may contain allusion to the progress of a shadow as measuring diurnal time. The Greeks used the dial before the Romans; and with regard to the Egyptians, "there are no indications in the sculptures to prove the epoch when the dial was first known in Egypt" (Wilkinson, *Anc. Egyptians*, iii, 342); it has been suggested that the *מַעְלֵי הַדָּן*, "images," (Ezek. xvii, 8; xxvii, 9; Ezek. vi, 4, 6, rendered in the margin "sun-images," were gnomons to measure time (Jahn, *Archäol.* I, i, 539), but there seems no adequate ground for this theory. On the mode of regulating time among the Greeks and Romans, see Smith's *Dict. of Class. Ant.* s. v. *Horologium*. See TIME.

The circumstances connected with the dial of Ahaz (2 Kings xx, 11; Isa. xxxviii, 8), which is perhaps the earliest of which we have any clear mention, entirely concur with the derivation of gnomonics from the Babylonians. Ahaz had formed an alliance with Tiglath-pileser, king of Assyria (2 Kings xvi, 7, 9); he was a man of taste, and was ready to adopt foreign improvements, as appears from his admiration of the altar of Damascus, and his introduction of a copy of it into Jerusalem (2 Kings xvi, 10). "The princes of Babylon sent unto him to inquire of the wonder that was done in the land" (2 Chron. xxxii, 31). Hence the dial also, which was called after his name, was probably an importation from Babylon. Different conjectures have been formed respecting the construction of this instrument. Grotius follows the Rabbins in describing it as "a concave hemisphere, with a globe in the midst, the shadow of which fell on the different lines engraven in the concavity of the hemisphere, these lines being twenty-eight in number." Mr. Traylor (in Calmet's *Dict.*) discovered some representations of ancient dials, one of which was found at Heracleum, and was probably originally from Egypt, which he conceives to answer, in many respects, to the circumstances of the sacred narrative (see also *King's Pict. Bible*, note on 2 Kings xx, 11). The subjects of the figures seem to apply to the description of the dial of Berosus given by Vitruvius (ix, 9), "a half circle hem-

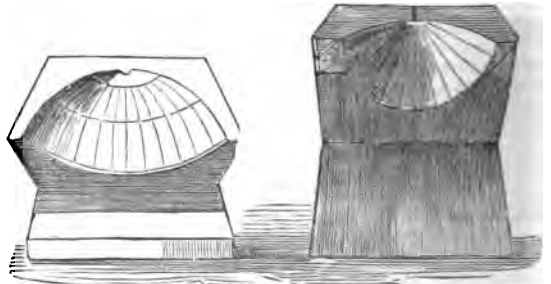

Ancient portable Sun-dials.

lowed into the stone, and the stone cut down to an angle." This kind of sun-dial was portable, and did not require to be constructed on or for a particular spot, to which it was subsequently confined, and, therefore, one ready-made might easily be brought on a camel from Babylon to Ahaz. If the instrument used in this instance were brought from Babylon, we see the reason why the king of Babylon was so peculiarly interested in the event (2 Kings xx, 12). See AHAZ.

The chief difficulty in the case of the dial of Ahaz is to understand what is meant by the peculiar terms in which it is expressed, *מַעְלֵי הַדָּן*, the *degrees* or *steps* of Ahaz. They may mean lines or figures on a dial-plate, or on a pavement, or the steps to the palace of Ahaz, or some steps or staircases he had erected else-

ere (see Carpov, *Apparat. Historic. Crit.* Lips. 18, p. 352, etc.). The Sept. in Isaiah reads ἀναθρομους τοῦ οἴκου τοῦ πατρὸς σου, "the steps or stairs the house of thy father." Josephus also says steps or degrees in his house" (*Ant.* x, 2, 1). The Vulgate renders the passage in Kings, מַעְבְּרֵי הַבֵּית, "our-stone," and gives the same meaning to "the stairs" (2 Kings ix, 18), and renders Isa. xxxviii, 8, מַעְבְּרֵי הַבֵּית, "on the shadow of the stone hours." Symmachus most certainly understood a dial; στρέψω τὴν σκῆν τῶν γραμμῶν ἢ κατέβη ὠρολογίῳ Ἀχαζ, "I will cause to return the shadow of the degrees which (shadow) is gone down on the dial of Ahaz;" and so Jerome renders it *Horologium*. Von Gumpach's opinion (*Zeitrechnung der Babylonier*, Heidelberg, 1852, p. 25) is that it was an accurate scientific apparatus, indicating the half hours by the incidence of the shadow of the upright pole or gnomon with the edge of the several "degrees" or steps, somewhat in the manner of the subjoined figure. Mr.

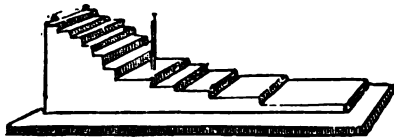

Supposed Form of the Dial of Ahaz.

Bartholomew is favorable to the conjecture of Von Gumpach that it was a present to Ahaz from Tiglath-pileser; and he compares it with the presumed form of the tower of Babel, which may have been constructed in part for astronomical purposes (*Nis. and Bab.* p. 424 sq.). On the

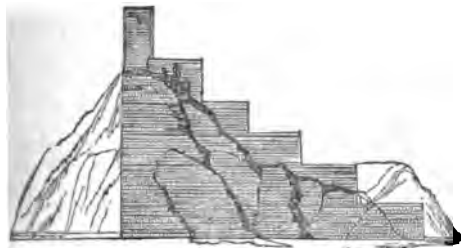

Eastern Face of the Birs Nimroud, with proposed Restoration.

whole, however, the dial of Ahaz seems to have been a distinct contrivance rather than any part of a house. It would also seem probable, from the circumstances, that it was of such a size, and so placed, that Hezekiah, now convalescent (Isa. xxxviii, 21, 22), but not perfectly recovered, could witness the miracle from his chamber or pavilion. May it not have been situated "in the middle court" mentioned 2 Kings xx, 4? The cut given below presents a dial discovered in Hin-

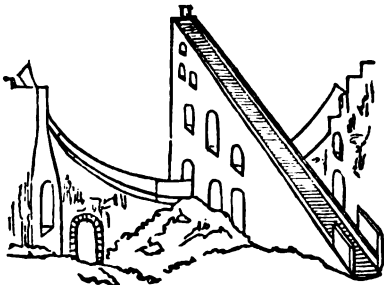

Indian Sun-dial.

doostan, near Delhi, the ancient capital of the Mogul empire, whose construction would well suit the circumstances recorded of the dial of Ahaz. It seems to have answered the double purpose of an observatory and a

dial—a rectangled hexangle, whose hypothenuse is a staircase, apparently parallel to the axis of the earth, and bisects a zone or coping of a wall, which wall connects the two terminating towers right and left. The coping itself is of a circular form, and accurately graduated to mark, by the shadow of the gnomon above, the sun's progress before and after noon; for when the sun is in the zenith, he shines directly on the staircase, and the shadow falls beyond the coping. A flat surface on the top of the staircase, and a gnomon, fitted the building for the purpose of an observatory. According to the known laws of refraction, a cloud or body of air of different density from the common atmosphere, interposed between the gnomon and the coping of the dial-plate below, would, if the cloud were denser than the atmosphere, cause the shadow to recede from the perpendicular height of the staircase, and, of course, to reascend the steps on the coping, by which it had before noon gone down; and if the cloud were rarer, a contrary effect would take place (see bishop Stock's *Trasul. of Isaiah*, Bath, 1808, p. 109). Such a building might also be called "a house." It agrees also with Adam Clarke's supposition that "the stairs" were really "a dial," and probably this very dial, on which, as being in the most public place, or rather on the platform on the top of which they set Jehu, while they proclaimed him king by sound of trumpet" (*Commentary* at 2 Kings ix, 18). Bishop Stock's speculation that the retrogression of the shadow might be effected by refraction is supported by a natural phenomenon of the kind on record. On the 27th of March, 1703, P. Romauld, prior of the cloister of Metz, made the observation that, owing to such a refraction of the solar rays in the higher regions of the atmosphere, in connection with the appearance of a cloud, the shadow on his dial deviated an hour and a half (Rosenmüller). The phenomenon on the dial of Ahaz, however, was doubtless a miraculous nature, even should such a medium of the miracle be admitted: nothing less than a divine communication could have enabled Isaiah to predict its occurrence at that time and place; besides, he gave the king his own choice whether the shadow should advance or retire ten degrees. There seems, however, to be no necessity for seeking any medium for this miracle, and certainly no necessity for supposing any actual interference with the revolution of the earth, or the position of the sun. In the more distinct and ample account of it in 2 Kings, it is simply said that the Lord, at the prayer of Isaiah, brought the shadow ten degrees backward. Adopting the present state of the text in the parallel passage, Isa. xxxviii, 8, it is observable that what is called the sun in one part of the verse is called the shadow in the other. It is certainly as philosophical to speak of the sun returning, as it is of his setting and rising. Thus the miracle, from all the accounts of it, might consist only of the retrogression of the shadow ten degrees, by a simple act of Almighty power, without any medium, or, at most, by that of refracting those rays only which fell upon the dial. It is not said that any time was lost to the inhabitants of the world at large; it was not even observed by the astronomers of Babylon, for the deputation came to inquire concerning the wonder that was done in the land. It was temporary, local, and confined to the observation of Hezekiah and his court, being designed chiefly for the satisfaction of that monarch. It is remarkable that no instrument for keeping time is mentioned in the Scripture before the dial of Ahaz (about B.C. 700); nor does it appear that the Jews generally, even after this period, divided their day into hours. The dial of Ahaz was probably an object only of curious recreation, or served at most to regulate the occupations of the palace. Mr. Bosanquet, in a curious paper read before the Asiatic Society, endeavors to make out a synchronism between the reigns of Hezekiah and the Assyrian kings by means of the astronomical event in question. He

shows that upon such steps as appear to have been used for exhibiting the sun's meridional altitude, any very large partial eclipse on the northern limb of the sun, occurring about ten days from the winter solstice, near the hour of noon, would produce the effect described in the instance under consideration; and he calculates that such an eclipse actually took place Jan. 11, B.C. 689, which he accordingly fixes upon as the date of the Scriptural incident (*Jour. Sac. Lit. Oct. 1854*, p. 217, 218). This, however, does not tally with the Hebrew chronology, nor is it sufficiently confirmed by other savans to be entitled to reception. See CHRONOLOGY.

See Calmet, *La rétrogradation du soleil à l'horologe d'Achas* (in his *Dissertations* [in *Commentaire*], ii, 796); Martini, *Von den Sonnenuhren der Alten* (Lips. 1777), p. 86; Goguet, *Untersuchungen*, iii, 85; Volthuyesen, *Beiträge* (ed. Cramer, Kilon, 1777), p. 16 sq.; Sahm, *De regressu solis tempore Hiakia* (1689, 1696); Geret, *De sole tempore Hiakia retrogrado* (1678); Heisse, *Sciaticum Achas* (Jena, 1680); Hopkins, *Plumb-line Papers* (Auburn, 1862), ch. ii. See HEZEKIAH.

Diamond occurs in the Auth. Vers. as the translation of two Heb. words. See GEM.

1. יָהָלֹם (*yahalom*), so called from *beating*, with allusion to its hardness), a precious gem, placed sixth in the breastplate of the high-priest, with the name of Naphtali carved on it (Exod. xxviii, 18; xxxix, 11), and mentioned by Ezekiel (xxviii, 18) among the precious stones of the king of Tyre. The Sept. and Vulg. understand by it the *jasper*; several of the ancient versions render it by *onyx*, which is not improbable; still others by *adamant*, which is less likely. There is much reason to doubt whether the diamond was known in the time of Moses (see below). Our translation "diamond" is derived from Aben Ezra, and is defended by Braun (*Vest. Sacerd.* ii, 18). Kalisch (on *Exod.* p. 586) says "perhaps emerald." See ONYX.

2. שָׁמִיר (*shamir*), a sharp point; hence often a *bringer*, a precious stone, named in Jer. xvii, 1; Ezek. iii, 9; Zech. vii, 12. The Sept. in Jeremiah, and the Vulg. in all the passages, take it for the *diamond*. The signification of the word (from שָׁרַץ, to pierce) countenances this interpretation, the diamond being, for its hardness, used in perforating and cutting other minerals. Indeed, this use of the *shamir* is distinctly alluded to in the passage in Jeremiah, where the *stylus* pointed with it is distinguished from one of iron (comp. Pliny, *Hist. Nat.* xxxvii, 15). The two other passages also favor this view by using it figuratively to express the hardness and obduracy of the Israelites. Our version has "diamond" in Jer. xvii, 1, and "adamant" in the other texts. Bochart, however (*Hieros.* iii, 848 sq.), rejects the usual explanation, and, comparing the word *shamir* with the Greek σμίρις or σμύρις, conceives it to mean "emery." This is a calcined iron mixed with siliceous earth, occurring in livid scales of such hardness that in ancient times, as at present, it was used for polishing and engraving precious stones, diamonds excepted (Hoffmann, *Mineral.* i, 561 sq.). Bohlen suggests an Indian origin of the word, and compares *as-mira*, stone which cuts, spoken of gems, iron, etc. from their hardness. Rosenmüller is in favor of the diamond in his *Scholia*, but in his *Alterthumskunde* he takes up Bochart's notion, and urges that if the Hebrews had been acquainted with the diamond, and the manner of working it, we should doubtless have found it among the stones of the high-priest's breastplate; and that, as the *shamir* was not one of the stones thus employed, therefore it was not the diamond. But to this it may be replied that it was perhaps not used because it could not be engraved on, or was possibly not introduced until a later period. The argument drawn from the rarity of the word in the Old Testament is of

little weight, and there is no necessity for seeking an

Oriental origin of the word σμίρις, or ground for considering it identical with *shamir*, as it may easily be traced from the Greek itself (see Passow, s. v.; Eshhorn, *De Gemmis Sculpt. Hebr.*). For an account of the diamond of the ancients, see Moore's *Ancient Mineralogy*, p. 143-145. See ADAMANT.

The diamond is the hardest and most valuable of the precious stones, and for many ages was considered indestructible by fire or any other means; modern chemistry, however, has proved that at a heat less below that required to melt silver it is gradually dissolved or burned. It is, in fact, nothing but pure carbon, but in a more highly crystallized state than coal. In former times, all the diamonds that were known were brought from different parts of India, particularly from the famous mine of Golconda, near Hyderabad, the present capital of the Deccan, in Hindostan: the islands of Molucca and Borneo have also produced many valuable stones. The diamond mines of Golconda are now so far exhausted as to be considered not worth the expense of working, and the diamonds which are brought to Europe come chiefly from Brazil. They are always found in an alluvial soil, generally gravel, resting on granite, and not imbedded in any other substance, but appear like small pebbles, with the surface flattened in many parts. See PEARL (Cyclopædia), s. v.

Diana. The Artemis of the Greeks (*Apollon.* Acts xix, 24), and Diana of the Romans, is a goddess known under various modifications and with almost incompatible attributes. According to the Hebræic accounts and Hesiod, she was the daughter of Jupiter and Latona, born at the same time with Apollo at Delos. As the tutelary divinity of Ephesus, in which character alone she concerns us here, she was undoubtedly a representative of the same power presiding over conception and birth which was adored in Palestine under the name of ASHTORETH. She is therefore related to all the cognate deities of that Asiatic Juno-Venus, and partakes, at least, of their connection with the moon. Creuzer has combined a number of testimonies in order to show how her worship was introduced into Ephesus from the coasts of the Black Sea, and endeavors to point out the several Medo-Persian, Egyptian, Libyan, Scythian, and Cretan elements of which she is compounded (*Symbol.* ii, 115 sq.). The Arabic version of the Acts relates Artemis, in the chapter cited, by *As-Zuhara*, which is the Arabic name for the planet Venus. From certain Ephesian coins which represent her seated upon her favorite deer, and in other rustic positions, it appears that she was identical with the virgin huntress of the earlier mythology, the grosser feature of her worship being apparently borrowed from association with the



Ephesian Medals of Diana.

voluptuous religions of the East. Guhl, indeed (*Ephesiaca*, p. 78-86), endeavors in almost all points to identify her with the true Greek goddess. In some respects there was doubtless a fusion of the two. Diana was the goddess of rivers, of pools, and of harbors, and these conditions are satisfied by the situation of the sanctuary at Ephesus. Coressus, one of the hills on which the city stood, is connected by Stephanus Byzantius with κόρη, "maid." We may also refer to the popular notion that, when the temple was burnt on the night of Alexander's birth, the calamity occurred because the goddess was absent in the character of Lucina. But the true Ephesian Diana is represent-

is a form entirely alien from Greek art (see Je-
 2, *Præfat. ad Ephes.* p. 639, ed. Ver.). Guhl in-
 1 supposes this mode of representation to have
 2 ence simply to the fountains over which the god-
 3 presided, conceiving the multiplication of breasts
 4 e similar to the multiplication of eyes in Argus or
 5 eads in Typhæus. But the correct view is un-
 6 tedly that which treats this peculiar form as a
 7 bol of the productive and nutritive powers of na-
 8 . This is the form under which the Ephesian
 9 na, so called for distinction, was always represent-
 0 wherever worshipped; and the worship extended
 1 many places, such as Samos, Mitylene, Perga, Hi-
 2 olis, and Gortyna, to mention those only which
 3 ur in the N. T. or the Apocrypha. Josephus men-
 4 s a very rich fane of hers at Elymais in Persia
 5 t. xii, 9, 1). Her most noted temple was at Ephes-
 6 . Here also, as in the temple of Apollo at Daphne,
 7 re the privileges of asylum. This is indicated on
 8 e of the coins of Ephesus (Akerman, in *Trans. of*
 9 *Numismatic Soc.* 1841); and we find an interesting
 0 of the continuance of these privileges in imperial
 1 es in Tacit. *Ann.* iii, 61 (Strabo, xiv, 641; Pausan.
 2 ; Cicero, *Verr.* ii, 88). The temple had a large
 3 nue from endowments of various kinds. It was
 4 o the public treasury of the city, and was regarded
 5 the safest bank for private individuals. See ERHE-
 6 s.

Her temple at Ephesus was one of the wonders of
 a world, but its great glory was the *διοικητικὸν ἀγάλμα*,
 the image which fell down from Jupiter" (Acts xix,
). Images claiming so lofty an origin were to be
 and in other cities besides Ephesus. There was a
 milar one at the temple of the Tauric Diana, and
 1 other of Minerva, called the Palladium, at Troy.
 t Rome, too, was the sacred ancile or shield of
 ars, which Numa pretended had fallen from heav-
 1, and it was jealously guarded in consequence.
 he early images of Diana are supposed to have been
 mply black conical stones, and afford another rea-
 n for the semi-conical figure of the Ephesian Di-
 na. They may have been *aerolites*, similar to the
 ne which existed in the temple of the Sun at Baal-
 ec, or the famous black stone in the Kaaba at Mecca.
 ler original Ephesian image, said to have fallen from

heaven, was probably
 very rude, and, to judge
 from its representation
 on ancient coins, little
 more than a head with
 a shapeless trunk, sup-
 ported by a staff on each
 side. There is some dis-
 pute as to the material
 of which her image was
 made. Most authori-
 ties say it was of ebony,
 the black color being,
 as Creuzer thinks, sym-
 bolic. Pliny relates



Ephesian Coin with Diana's
 Temple.

that Mucianus, who had seen it, affirms that it was of
 the wood of the vine, and that it was so old that it had
 survived seven restorations of the temple (*Hist. Nat.*
 xvi, 79). According to Xenophon, it was of gold
 (*Anab.* v, 8). The later image with the full develop-
 ment of attributes, of which we give a representation
 below, is, as Creuzer says, a Pantheon of Asiatic and
 Egyptian deities. Even in it, however, we see how
 little influence Greek art had in modifying its antique
 rudeness. It still is more like a mummy than a Greek
 statue. Some of the most significant attributes in this
 figure are—the turreted head, like that of Cybele;
 the nimbus behind it representing the moon; the zo-
 diacal signs of the bull, the twins, and the crab on her
 bosom; below them two garlands, one of flowers and
 the other of acorns; the numerous breasts; the lions,
 stags, and cows in various parts; the bees and flowers



Image of the Ephesian Diana.

on the sides; and others described in Millin's *Galerie*
Mythol. i, 26. See SHRINE.

Of this heaven-descended image the great city Ephes-
 us was a "worshipper," *νεωκόρος*, literally a "tem-
 ple-sweeper," a title which was assumed by many
 cities as a mark of high distinction. There were, how-
 ever, a class of men particularly called *νεωκόροι* (Xen-
 oph. *Anab.* v, 8, 6), who were persons of rank and con-
 sideration, and to whom was assigned the duty of of-
 fering sacrifices on behalf of the emperor. Her priests
 were called Megabyzi, and were eunuchs (Strabo, xiv,
 641). They were restricted to a severe diet, and pro-
 hibited from entering any private house; they must
 have been a wealthy body, for they sent a statue of
 gold to Artemidorus, who pleaded their cause at Rome,
 and rescued their property out of the hands of the
 farmers of the public revenues, who had seized upon
 them. Once in the year was there a public festival
 held in honor of the goddess in the city of Ephesus,
 and to this festival all the Ionians who could do so
 made a point of repairing with their wives and chil-
 dren, bringing with them not only costly offerings to
 Diana, but also rich presents for the priests. No arms
 were allowed to be worn in the precincts of her tem-
 ple. No bloody sacrifices were offered. The symbol
 of this divinity was a bee (Aristoph. *Ran.* 1273), and
 her high-priest bore the name of king (*βασιλεύς*). Her
 worship was said to have been established at Ephesus
 by the Amazons (Pausan. ii, 7, 4; viii, 12, 1). See

luminating the truly believing inquirer in his search into the meaning of revelation. The body of Christian truth, both fact and doctrine, is revealed and recorded, once for all, in the Scriptures of the Old and New Testament; and these Scriptures constitute, in every age, the norm of doctrine, and the criterion by which all new exhibitions of doctrine are to be tested. No new truth can be developed any more than a new man can be created. But it is very clear that there may be, and has been, development of Christian doctrine in the sense of clearer apprehension of it on the part of the Church. The science of theology implies the application of human reason to the given facts and doctrines of Christianity; first, the application of reason to Scripture (exegetis), to find out what its doctrines are; and, secondly, the use of reason in co-ordinating these doctrines into scientific form (system). It will be observed that the "development of doctrine," as thus stated, is very different from the theory that the Bible gives only the "germs" of doctrine, out of which, by a necessary organic law, the doctrines themselves are "developed." This image of a "germ" is very apt to mislead. Even if a doctrine were a living thing such as a germ is, "it is to be remembered that even a germ is developed by attracting and assimilating to itself many foreign elements which are around it. It is by additions from without, and different from itself, that it grows" (Donaldson, *History of Christian Literature*, 1, 5).

In doctrine, however, as in history, development is not always synonymous with improvement. Human apprehension of divine truth is sometimes wrong, as well as sometimes right; and the history of doctrines, while implying development in its very idea, yet includes variations of rise and fall in human statements of the one divine truth. A right theory "of the development of Christian theology by no means implies that each later age must necessarily have a fuller and deeper knowledge of divine things than its predecessors, either as spread abroad through the body of the Church, or as centred in its chief teachers. Were this a consequence of this theory, this alone would be fatal to it, the very reverse having notoriously been often the case. But even in science, which is so much less dependent on moral influences, and with which the varieties of character and feeling have so little to do, the progress has never been uniform and uninterrupted; while in poetry, in the arts, in philosophy, where the understanding is greatly swayed by moral affections, and derives a main part of its sustenance and energy from them, man's course has been so irregular that nothing like a law of it has been ascertained. So, too, must it needs be in theology, where the subject matter is divine truth, which cannot be received intellectually unless it be also received morally, to the pure reception of which all corrupt feelings of our nature are opposed, and which they are perpetually attempting to sophisticate and distort. Thus it has often come to pass that the inheritance left us by one age has been squandered, or wasted, or forfeited by its successor, so that it by no means follows from the theory of the development of Christian truth that even the later system of theology must be the better. For the world is always wrestling to draw men away from the truth, and will often prevail, as Jacob did over the angel; and when faith is at a low ebb, when the visible, and the immediate, and material predominate in men's hearts and minds over the invisible, the ideal, and the spiritual, theology must needs dwindle and decay. But when there is a revival of faith, if this revival coincides with, or is succeeded by a period of energetic thought, a deeper or clearer insight will be gained in certain portions of truth, especially appropriate to the circumstances and exigencies of the age, and which have not yet been set forth in their fulness. Thus, to cite the two most memorable examples, the true doctrine of the Trinity

was brought out more distinctly in the fourth century than that of justification by faith in the sixteenth; the prevalence of error acting in both instances as a motive and spur to the clearer demarcation and definition of the truth. At the same time, through eagerness to overleap himself, and to exaggerate the importance of whatever may be engaging him at the moment, an age which has been allowed to behold a truth may too easily depreciate and let slip the truth which its ancestors have bequeathed to it, and its proneness has ever been a main source of loss. Thus, on all sides, we are continually reminded of our inherent weakness, and how that weakness is ever most mischievous when we are beguiled into fancying ourselves strong; and while we are hereby excited to be diligent in studying the whole history of the Church, and the writings of her chief teachers in every age, lest we drop and lose any portion of the precious riches which they have been allowed to win for us, we are still more strongly admonished to compare every proposition, and every scheme of propositions—every proposition, both as it stands by itself and in its relation to the other parts of Christian truth—with the only canon of truth, the written Word of God" (Hare, *Mission of the Comforter*, note G).

In what has been called the *extreme subjective school* of German theology, there is a false doctrine of development, which is stated as follows in Chambers's *Encyclopædia* (s. v. DEVELOPMENT): "According to this school, Christian doctrine is nothing else than the expression of the Christian consciousness at any time. Scripture maintains no permanent or authoritative relation to it. It is all progress—a continued flux, without any normal standard or expression. Scripture may be its primary expression, but it may leave it a fountain-head, and in the course of time issue in developments not necessarily bound to Scripture. But according to the view above set forth, Scripture remains the absolute and complete revelation of Christian doctrine, which is continually unfolded, but never exhausted by inquiry—beyond which right reason and truth never travel. The Christian revelation not only admits of, but demands constant criticism, as the mass of unfolding more comprehensively and perfectly its contents, but it remains in itself the consummate expression of all spiritual truth; and it is this very peculiarity of the Christian revelation that makes its contents capable of continual and ever fresh development. It is just because its substance is divine that its doctrinal expressions never cease to interest and to answer to the necessities of successive times. Other religions, while capable of development, reach a point where they cease to have any further living meaning, and pass on the one hand into mere popular mythology, or into an esoteric priestly tradition. They become transmuted into poetry or some ordinary product of philosophical speculation. Civilization overtakes and supplants them. But it is of the distinguishing divine character of Christianity that its doctrines possess a vital ever-renewing power, capable of adaptation to the highest forms of human civilization, and full of enlightenment and guidance to the most advanced intelligence. The development of Christian doctrine, therefore, is not merely a subject of curious and important study in the past, but of great and significant influence for the present and the future."

3. Certain Romanist writers have recently made use of the doctrine of development to vindicate the theology of that Church. They hold that the Scriptures do not contain the entire revelation of God to man, but that revelation is receiving additions, and gradually becoming complete, by the successive decisions of the Church. This view has been set forth by Mithel and with special skill by J. H. Newman (*Essay on the Development of Christian Doctrine* [N. Y. 1853, 8vo]). Its ground is that the revelation given in the Bible was intentionally incomplete, and forms an incom-

1 imperfect system of truth, needing for its completion a gradual development under infallible guidance, 2 that the present system of doctrine in the Roman Catholic Church is the ripened result of this development, so far as made. See also Döllinger, *Christentum & Kirche*, 1860, p. 162. The doctrine has not met with general favor in the Roman Catholic Church, as it is in conflict with the established reliance of that Church on tradition, and upon what is called "Catholic canon." One of the ablest of modern Romanist writers, Owen, has written powerfully against the development theory (in his *Quart. Review*). Extremes meet; the Rationalistic theory agrees with the Romanist (in the view of Newman's view of it) in representing the system of Christianity delivered in the New Testament as defective and imperfect. The Council of Trent declared (sess. iv) as follows: "The sacred and holy, œcumenical and general Council of Trent, keeping always in view the removal of errors and the preservation in the Church of the purity of the Gospel, which Gospel, before promised through the prophets in the Holy Scriptures, was first orally published by our Lord Jesus Christ, the Son of God, and then commanded to be reached by his apostles to every creature, as the fountain both of every saving truth and discipline of morals; and perceiving that this truth and discipline are contained in the written books, and the unwritten traditions which, received by the apostles from the mouth of Christ himself, or from the apostles themselves, the Holy Ghost dictating, have come down unto us, transmitted as it were from hand to hand; [the council] following the examples of the orthodox fathers, receives and venerates with equal affection of piety and reverence all the books both of the Old and of the New Testament, seeing that one God is the author of both, as also the said traditions, as well those appertaining to faith as to morals, as having been dictated either by Christ's own word of mouth or by the Holy Ghost, and preserved by a continuous succession in the Catholic Church." Mr. Newman's book was ably answered by W. Archer Butler, *Letters on Romanism* (Cambridge, 1854, 8vo). The following remarks of Julius Charles Hare (*Mission of the Comforter*, note G) are in point: "Some of the German apologists for Romanism, having perceived, as could not but happen in a country where learning and criticism have found a home, that the old plea of a positive, unwritten tradition in the Church was utterly untenable as a ground for the doctrinal and practical innovations of later times, have fancied that they might render their Church a service by taking up the popular and modern theory of the development of mankind—a theory which has been carried into the most outrageous extravagances in the contemporary schools of philosophy, as it has also been in France by the St. Simonians. This theory has been used by others to show that Christianity itself is a transient religion, belonging to a by-gone period and almost obsolete; they have tried to employ it in defence of the Church of Rome. Herein, however, it was impossible for them to succeed. That Church, whose constant effort, since the time when it cut itself off from the living body of Christ, has been to check, to repress, to cramp, to fetter the mind, could not find support in a theory which implies the freedom of the mind; nor can any Church, unless it recognises, both doctrinally and practically, that the property of truth is to set the mind free."

4. The following section was prepared for this Cyclopedia by the late Dr. Harbaugh just before his death. We print it as he left it, though it involves a little repetition of what has been given above.

Development.—This word, related primarily to the sphere of organic life in the natural world, has also come to perform important service in science, especially in psychology, philosophy, theology, and history. In the earlier stages of science generally, the data and

phenomena were classified and arranged according to the outward peculiarities which they presented. In time, however, and especially under the influence of Christianity, as the key to the deepest life of the world, scientific thinking felt itself urged to a deeper apprehension of all kinds of phenomena. The mechanical and outward in systematizing accordingly had to give way to the determining power of mere inward principles.

Thus it has come to pass that while science, so far as it has been apprehended and advanced by non-Christian thinking, has been, for the most part, satisfied with the word *progress*, science grounded in the distinctively Christian principle has found the word *development* indispensable. The word, as thus used, presupposes a distinctive theory of the essence of Christianity, and so also of the Church, its history and its dogmas, as well as of affiliated sciences, such as psychology and philosophy. It finds inadequate the view of the essence of Christianity which resolves it into the idea of *doctrine*, as in Supranaturalism; so also the view which makes it only an ethical force, law, or *rule of life*, as set forth in the school of Kant and by Rationalism; and so, moreover, the conception that it is, in its essential character, a mere power of redemption operative in the *sphere of religious feeling*, according to Schleiermacher and the Mystics. Admitting and appreciating all these as secondary and dependent, it holds that Christianity is primarily and essentially a *life*—the divine-human life of its founder, Jesus Christ—which becomes the deepest life of renewed humanity, of history, and of science (see Ullman, *Distinctive Character and Essence of Christianity*). Life being essentially *organic*, it must have the word *development* to indicate that unfolding from a germ-like inward principle which is the distinctive characteristic of organic life. To the genetic processes involved in the activities of life it applies the word *development*. "This idea of an organic, steadily improving development of humanity, according to a wise, unalterable plan of Providence, is properly as old as Christianity, meets us in many passages of the New Testament (Matt. xiii, 81, 82; Ephes. iv, 12-16; Coloss. ii, 19; 2 Pet. iii, 18), and in occasional remarks of the early fathers, such as Tertullian and Augustine; and was brought out in the 18th century with peculiar emphasis and freshness by the genial Herder, in his 'Ideas on the Philosophy of the History of Humanity' (784), so highly valued by the gifted historian of Switzerland, John von Müller" (see Herder's *Sämmtliche Werke, zur Phil. und Gesch.* Theil iii, § 74 sq.). "The more mature and philosophical conception of it, however, and the impulse which it gave to a deeper and a livelier study of history, are due especially to the philosophy of *Schelling*, and, still more, of *Hegel*. With Hegel, all life and thought is properly development, or a process of organic growth, which he calls *Aufhebung*—that is, in the threefold sense of this philosophical term so much used by him, (1.) an abolition of the previous imperfect form (an *aufheben*, in the sense of *tolerate*); (2.) a preservation of the essence (*conserve*); and (3.) an elevation of it to a higher stage of existence (*elevare*)" (Dr. Schaff's *History of the Apost. Church*, p. 90, 91).

The conception of development has, however, also been carried out of its proper Christian sense, and perverted to the service of anti-Christian systems of thought. Thus Pantheism, laying hold upon some insufficiently guarded point in the Hegelian theory, has employed it in its scheme. The one school of Hegel, denying with him the existence of a personal God, as the creator of all principles of created life, proposes to account for all animated existence by a theory of development starting in matter, ideas, or thought (all of which, however, it leaves vague and floating), holding that nature through successive upward gradations ultimately reaches self-consciousness in the human spir-

Several of his writings have been translated into other languages; one even into Chinese. In a scientific point of view, his writings are of no great value.

Dickey, John M., a Presbyterian minister, was born in York District, S. C., Dec. 16, 1789. After overcoming many difficulties, he completed his theological studies, was licensed in 1814, and became minister of White River church, near Washington, Davis County, Ind. When ordained in 1817 he joined the Salem Presbytery, and devoted much time as a voluntary missionary to destitute places. In 1819 he removed to Lexington, Scott County, supplied the church of Graham, and was installed over Pisgah and Lexington. He subsequently visited the valley of the Wabash and the central part of Indiana, where he organized three churches. From 1835 his labors were confined, with little exception, to the Pisgah church, which his health obliged him to resign in 1847, when he became an agent for the American Tract Society. He died Nov. 21, 1849. He published *A History of the Presbyterian Church, Indiana* (1828), and *A Series of Letters* addressed to his friends.—Sprague, *Annals*, iv, 514.

Dickey, William, a Presbyterian minister, was born Dec. 3, 1774, in York County, S. C. His parents soon after removed to Kentucky, where he grew to manhood. He obtained an education with much self-denial, and in 1802 was licensed to preach. He labored fourteen years with the churches of Salem and Bethany, Ky., and then removed to Washington, Lafayette County, Ohio, and soon after to Bloomingburg, Ohio, where he remained forty years. He died in December, 1857.—Wilson, *Presbyterian Hist. Almanac*, 1864, p. 112.

Dickins, John, a distinguished preacher of the Methodist Episcopal Church, was born in London 1746. He studied at Eton College; emigrated to America before the Revolution; became a Methodist in 1774; preached extensively in Virginia and North Carolina from 1777 till 1782, when he located, but continued his ministerial labors diligently in Virginia. Bishop Asbury met him there in 1780, when Dickins framed a subscription paper for a seminary, on the plan of Wesley's Kingswood School, the first project of a literary institution among American Methodists. It resulted in Cokesbury College. At the close of the war Asbury induced him to go to New York, where he took charge of John-street Church, the first married preacher who occupied its parsonage. His labors were successful in gathering together the fragments of the Church, seriously broken by the recent war. Dickins was here the first American preacher to receive bishop Coke, and approve Wesley's scheme of the organization of the denomination. He had an important agency in that work. In 1785 he travelled Bertie Circuit, Va. He was reappointed to New York in 1786, '87, '88. In 1789 he was stationed in Philadelphia, and there began one of the greatest institutions of American Methodism, its "Book Concern;" there also he died in the memorable outbreak of the yellow fever in 1798. He was one of the soundest minds and ablest preachers of early Methodism; a good scholar in English, Latin, Greek, Hebrew, and mathematics; an influential counsellor, and a mighty preacher.—Stevens's *Hist. of the Meth. Episc. Church*, vol. ii, iii, and iv, passim; *Minutes of Conferences*, i, 179.

Dickinson, Austin, a Congregational minister, was born at Amherst, Mass., Feb. 15, 1791. He graduated at Dartmouth 1813; studied theology at Princeton; was admitted to the ministry Feb. 2, 1819, and travelled south for his health. He came North in 1822, and became agent for Amherst College, and was very efficient and successful. "Besides being largely successful in raising the charity fund of \$50,000, which has been a source of permanent prosperity to the college, and \$30,000 for general purposes, he ex-

erted as much influence as any other man in obtaining a charter for the college" (Sprague). In 1826 he edited the "National Preacher" in New York, and was editor until 1838. In 1844 he began writing religious articles for the secular press, and continued a useful task until the end of his life, Aug. 14, 1858.—Sprague, *Annals*, ii, 674.

Dickinson, Jonathan, A.M., a Presbyterian minister and President of Princeton College, was born at Hatfield, Mass., April 22, 1688, and graduated at Yale 1706. After being engaged for some time in a study of theology, he was licensed and ordained in 1710. His field of labor embraced Elizabethtown, Bala, Westfield, Connecticut Farms, Springfield, and Osham, N. J. In 1717 he joined the Philadelphia Presbytery, where he continued to exercise his ministry for nearly forty years. In the great Whitefield revival he stood up firmly in defence of the genuineness of the work, and on one occasion at least Whitefield is known to have preached in his parish to an immense congregation. Still he had no sympathy with the prevailing fanatical tendencies of the time, and manifested the utmost caution in discriminating between true and false religious experience. He published a tract bearing on this subject, written with great rigour and discrimination. After the division of the Presbyterian Church in 1741 into the Synods of New York and Philadelphia, each synod was intent on making provision to train up young men for the ministry; Dickinson was the acknowledged leader of the Synod of New York, as he had been of the old Synod of Philadelphia before the separation, and he is supposed to have had a primary influence in originating the College of New Jersey. A charter for a college having been obtained from the acting governor of the colony, the institution, which took the name of Nassau Hall, went into operation, with Jonathan Dickinson as its president, though, in taking upon himself this post office, he did not relinquish any of his duties as a pastor. It did not commence its operations till 1746, and his death occurred on the 7th of October, 1747. His publications include *A Defence of Presbyterianism* (1724); *Four Sermons on the Reasonableness of Christianity* (1732); *Five Discourses on Points of Christian Faith*, etc. (1741); *A Display of God's special Grace* (1742); *Reflections on Regeneration*, with a *Discussion of the received Doctrine* (1745); *A Vindication of God's sovereign free Grace* (1746); *A second Treatise*, etc. (1748); and several detached sermons.—Sprague, *Annals*, iii, 14.

Dickinson, Peard, an English Wesleyan minister, was born at Topsham, Devonshire, Nov. 16, 1738. He received a careful training from a well-educated father, and in 1776 went to Bristol, where he soon joined a Methodist society. He entered Oxford as commoner of St. Edmund Hall in 1779, passed A.B. in 1782, and A.M. in 1785. In 1783 he was ordained in the Church of England, and became curate to Furnet (q. v.) at Shoreham. In 1786 he went to London as pastor of one of Mr. Wesley's societies, and continued to reside there in charge of various societies during the rest of his life. He died May 16, 1802. He was a man of great learning, and especially an excellent linguist. His researches in the early writings of Christianity were very thorough. He was a warm and beloved pastor, an intimate friend of the Wesley's, and a sort of intermediate link between the Church of England and Wesleyan Methodism.—Smith, *History of Wesleyan Methodism*, i, 574; Jackson, *Christian Biography*; Stevens, *History of Methodism*, ii, 315.

Dickson, David, an eminent Scotch divine, was born at Glasgow in 1583, and educated at the University of Edinburgh, in which he afterwards became professor of Philosophy. Having been appointed minister of Irvine in 1618, he became a very popular preacher. In 1648 he became professor of Divinity in the

iversity of Glasgow, and afterwards in that of Edinburgh. He was ejected at the Restoration in 1662, died the same year. He was considered one of the ablest and most useful men of his time, and his works continue to be esteemed, particularly his commentaries, which, though brief, have much point and densation. Dickson's name will ever be remembered for his version of the hymn *O Mother dear Jerusalem* (see Hymnology). His principal works are, *Brief Exposition of the Gospel according to Matthew* (Lond. 1651, 12mo); *A short Explanation of the Epistle to the Hebrews* (Aber. 1635, sm. 8vo; Lond. 1839, royal 8vo); *Expositio analytica omnium apostolicarum epistolarum* (Glasgow, 1645, 4to; *A brief Explication of the Epistles* (Lond. 1655, 8 vols. 8vo; Glasg. 1884, 2 vols. no); *Therapeutica sacra* (Edin. 1656, 8vo); *Therapeutica sacra, translated by the Author* (2d edit. Edinb. 17, 8vo); *Truth's Victory over Error* (Glasg. 1772, no).—Hetherington, *Ch. of Scotland*, vol. 1; M'Crie, *Sketches of Ch. Hist.* i. 196; ii. 61.

Dictates of Pope Gregory (*Dictatus papae, dictatus Gregorii VII, Dictatus Hildebrandini*), a title given to twenty-seven theses, in which Gregory VII (Hildebrand) is said to have set forth the grounds and principles of the supremacy and power of the pope in relation to the Church and to secular governments. They are contained in lib. ii of his letters, between the 54th and the 56th epistles, and also in Harduin, *Concil.* n. vi, p. 1, p. 1304 sq. "Baronius, ann. 1076, no. 31, d. Christ. Lupus, in *Notis et Dissert.*, consider these theses as spurious; the French writers, Jo. Lannois, *Epistol.* lib. i, ep. 13, Anton. Pagl, *crit. in Baron.* l. c., and especially Natalis Alexander, *Hist. Eccl.* ssec. xi et xii, dissert. iii, set them down, not indeed as spurious, but as wholly inconsistent with Gregory's principles. The modern authorities, following Mosheim, suppose them to express Gregory's principles, though written by some one else. They seem to have been an Index capitulorum of some synod held under Gregory's influence" (Gieseler, *Ch. Hist.* div. iii, § 47). The dictates themselves are as follows: 1. The Roman Church was founded by the Lord alone. 2. The bishop of Rome only properly termed the universal bishop. 3. He only can appoint or depose a bishop. 4. The papal legate has the right to preside in all Church assemblies, even though he is not the equal in rank of the bishops, and he may pronounce sentence of deposition upon them. 5. The pope may deprive absent bishops also of their rank. 6. No person is permitted to occupy the same see with a person excommunicated by the pope. 7. The pope only is qualified to issue new laws whenever circumstances demand it, to organize new congregations, to change a cathedral into an abbey, to divide a diocese, or to contract several impoverished sees into one. 8. He only has power to make use of the imperial insignia. 9. Princes must kiss the feet of the pope only. 10. Only his name is to be recited in the churches. 11. The name and title of pope apply to no person only. 12. He is empowered to depose the emperor. 13. He may translate bishops from one see to another. 14. He can ordain the clergymen of all churches. 15. A clergyman that has been ordained by him may serve with other churches, but no other bishop has the right to appoint him to a superior position. 16. The pope only has power to pronounce a council oecumenical. 17. No chapter nor book of the holy Scriptures may be declared canonical without his sanction. 18. No person can overthrow his decisions; but he, on the other hand, may subvert the judgments of all men. 19. No person can judge him. 20. None may dare to condemn him who appeals to the apostolical chair. 21. All matters of consequence in any church must be reported to him. 22. The Romish Church has never erred, and, according to the testimony of the holy Scriptures, will not err to all eternity. 23. If the pope was canonically elected (i. e. according to the rules of the Church), he infallibly be-

comes a holy man, through the merits of St. Peter. 24. Inferiors (subjects) may complain of their superiors with the permission of the pope. 25. The pope may depose a bishop, and reappoint him, without convoking a synod. 26. One who is not agreed with the Romish Church does not belong to the Catholic (orthodox) Church. 27. The pope may release subjects from their fealty to wicked rulers. (The original Latin is given in Gieseler, *Church History*, div. iii, § 47).

Dictionary, BIBLICAL. The term *dictionary* is the most general one for designating an alphabetical arrangement of words with copious explanations attached, whereas *vocabulary* (Latin *vocabulum*) denotes a simple list of words with brief definitions; while a *lexicon*, on the one hand, is an etymological and grammatical exhibit of the words of a (usually foreign) language, and *Encyclopædia* (in Greek *παιδεία*, *instruction in a complete circle*) is properly a series (whether alphabetical or otherwise) of treatises embracing the whole range of a science by topics (*Crabbe's English Synonymes*). This last word is used by English authors especially as a title of works covering the entire compass of human knowledge, arranged alphabetically under leading heads, and has thence been sometimes applied, in a more limited sense, to similar works on one or more branches of science. The term *Cyclopædia*, however, is now generally recognised as more distinctively applicable to books of this class (see *History of Cyclopædias*, in the *Lond. Quart. Rev.* April, 1863). In order to entitle it justly to the rank of either of these latter appellations, a work should contain the *literature* of the subjects of which it treats. Finally, a *glossary* is an elucidation of obscure or obsolete words occurring in a particular author or class of writers; *thesaurus* is applied to a collection of learned dissertations, and also to an extensive lexicon, both being usually written in Latin; *bibliotheca* is applied to bibliographical works, and also to collective editions, e. g. *Bibliotheca Patrum*.

The first production of this kind, relating to the Bible, of which we have any definite knowledge, aside from those purely lexical, was the *Onomasticon* of Eusebius, edited and translated by Jerome, which, however, was merely geographical, and embraced Palestine only. It has been of great service, nevertheless, to all writers since on Biblical topography. Jerome likewise prepared a treatise of less value on the Hebrew proper names occurring in the Scriptures (*De Nominibus Hebraicis*, in vol. iii of his works, No. 15) chiefly from materials previously afforded by Philo Judæus and Origen; likewise the biographies of eminent early Christians (*De Viris Illustribus*, vol. ii, pt. ii of his works). After this, however, no work worthy of note belonging to the class we are considering appeared till the renewal of Biblical learning after the Reformation. The following are those of leading importance and celebrity.

(1.) Aug. Calmet (q. v.), *Dictionnaire Historique, Critique, Chronologique, Géographique, et Littérale de la Bible* (Paris, 1722, 2 vols., and [most complete] 1730, 4 vols. fol.). "This work was composed in a great degree out of the materials already used by the author in the notes, dissertations, and prefaces of his great work, the *Commentaire Littérale*. The first translation of it appeared in 1732, in three large and costly folio volumes, executed by two clergymen, Samuel d'Oyley and John Colson, the former of whom translated to the letter M, and the other to the end of the book. This translation formed the great treasury from which were drawn the materials of the large number of lesser dictionaries of the Bible which subsequently appeared. These exhibited little more diversity from each other than such as naturally arises where persons of different habits of mind form different abridgments of the same work, the original or new matter being chiefly constituted by the interspersions of doctrinal articles in support of the particular views which the com-

piler entertained. At length a new edition of Calmet was undertaken by Mr. Charles Taylor, and appeared in 1795 in four, and in later editions in five, quarto volumes. This was a very eccentric performance, composed thus: two volumes consisted of an *abridgment* of Calmet, one volume of engravings, and two volumes of 'Fragments.' These fragments contained a sprinkling of useful matter drawn from histories and travels; but three fourths of the whole consist of singularly wild and fanciful speculations respecting mythology, ethnology, natural history, antiquities, and sundry other matters, and are replete with unsound learning, outrageous etymologies, and the vagaries of an undisciplined intellect. Calmet, thus transformed, and containing as much of the editor as of the original author, has in its turn formed the basis of nearly all the Biblical dictionaries which have since appeared, including a very painstaking digest of the more useful parts of Taylor's matter incorporated with the dictionary under one alphabet, the whole abridged into one volume royal 8vo, which appeared in 1832. This work was in the same year reproduced in Boston, under the supervision of Dr. E. Robinson, who made some few but valuable additions to particular articles" (Kitto). Calmet's own dictionary is still a standard work with Roman Catholics, and a modified edition of it is incorporated into the extensive series of *Dictionnaires Chrétiens* lately published by the Abbé Migne at Paris. It never was a profound work, however, and has now so far fallen behind the progress of Biblical science as to be of little use to the student beyond mere textual purposes.

(2.) Although the work of Calmet was the most learned and practically useful of all similar productions that had hitherto appeared, yet the partial standpoint of the author rendered it unsuited to the enlarged demands of the present age, which, with the superficiality and want of plan in later works, had brought performances of this kind into some disrepute; and it was reserved for Dr. G. B. Winer (q. v.), a learned theologian of Leipzig, to restore them to their former credit by his *Biblisches Real-wörterbuch* (Leipz. 1820, 2 vols. 8vo), of which a second and improved edition was published in 1833-38, and a third, still further enlarged, in 1848. This is a wholly original work, executed in the most careful and scholarly manner, and nearly exhaustive, although in a very condensed form, of the classical and earlier modern illustrations of Biblical topics. It is a masterly performance of its kind, and has been of very great service in the compilation of the present Cyclopædia. "The sphere of Winer's work is, however, narrowly drawn, being designed altogether for students. The critical treatment in it is of a very unequal character, and many of the subjects examined in its pages, especially in the department of natural history, have little relation to the Bible." Similar publications by various other writers have been produced on the Continent of Europe, but they cannot be regarded as exhibiting equal claims to scientific criticism or well-considered arrangement. Several of these will be noticed below.

(3.) A great advance on all predecessors, constituting, it may be said, a new era in the history of the subject, is marked by the appearance (Edinb. 1845, 2 vols. 8vo) of the *Cyclopædia of Biblical Literature*, edited by John Kátto, D.D. (q. v.), chiefly from the contributions of original articles by forty writers, including many of the most eminent theologians and Biblical scholars of Protestantism in Great Britain, Germany, and America; a duplicate edition was also issued in this country (N. Y. 1852). This work not only covers a larger range of topics connected with the Bible, in its archæology and introduction, but also handles each subject with a freshness and ability previously unattempted. In the biography of Biblical characters, a department mostly occupied by the editor himself, the narratives are invested with an interest

like modern history. The geography and history of the Bible are fundamentally investigated anew. The details of Biblical criticism are given with clearness, accuracy, and considerable copiousness. For the first (and we may almost say the only) time, the difficulties of the natural history of the Bible are heroically grappled with by persons (Dr. Boyle in the department of Oriental botany, and Col. C. Hamilton Smith in that of Biblical zoology) competent in modern science to throw light upon them. Oriental customs are diligently and carefully explored, and errors scrupulously weeded out. A tolerably complete view of the literature of each subject is also usually given. In short, an earnest, liberal, and judicious scholarship is brought to bear upon every topic (with but few exceptions) that are appropriate to the scope of such a work. It has been the basis of a large number of important Biblical articles in this Cyclopædia. The only serious drawback upon its general value is a tendency to prolixity, and in some cases a speculative vein, together with the almost inevitable consequences of a multiplicity of authors, leading to omissions in some cases and discrepancies in others. The edition of 1856, although professing to be "carefully revised" by Dr. Burgess, altogether failed to remedy these defects, being printed from the new stereotype plates, with the change of a few pages and an unimportant sentence here and there, very many of the most palpable errors being left uncorrected. A really new and greatly augmented edition has now (Edinb. 1862-5, 3 vols. royal 8vo) been carried through the press by Dr. J. L. Alexander, with the aid of a number of scholars, which, while substantially a reprint of many of the old articles, has large additions of new ones, especially the *biographies* of eminent Biblical writers, thus more fully realizing the special title of the work. The articles on Biblical geography and criticism are also brought down to the present state of investigation.

(4.) The only remaining work which for originality and research deserves to be mentioned in comparison with the foregoing is the *Dictionary of the Bible* (Lond. 1860-4, 8 vols. 8vo), edited by Wm. Smith, LL.D. of the University of London, and consisting, like the preceding, of articles prepared afresh by fifty-three eminent English and American scholars, although the names appended to the several articles are not always those of persons so well known to be proficient in the topics assigned them. The work is of a very elaborate and learned character, and has been peculiarly available in the preparation of the present Cyclopædia from the fact that it seems to avoid as much as possible the line of treatment pursued by Kitto's. It has the advantage of the latter in a more copious vocabulary, especially in the less important Biblical names, and in bringing down the investigations to a later date, but is far from excelling it in point of clearness and coherence of style, while it is rather the inferior in copulence of matter and in comprehensiveness. The topographical details are particularly well treated, those relating to natural science are by no means satisfactory. The articles are, with a very few exceptions, terse and compact, with a tendency, however, to expansion as the work advances. It contains an immense body of very valuable information, to a large degree new, and for the most part well digested, and admirably supplements the stock accumulated by previous efforts in the same line. Like the preceding it is characterized by a liberal tone of theological sentiment.

(5.) The *Imperial Bible Dictionary* by Rev. P. Fairbairn, D.D., with numerous coadjutors (Edinb. 1865 sq., 2 vols. imperial 8vo), is of a more popular character, and not so extensive in its general range as the named above. It is, however, entirely evangelical in sentiment. Its cuts, a number of which have been borrowed in this Cyclopædia, are particularly fine. It

1, moreover, some new items to the investigations s predecessors.

5.) A new *Bibel-Lexikon* is announced in Germany, e edited by Dr. Daniel Schenkel, with the co-ation of Drs. Bruch, Diestel, Dillmann, Fritzsche, s, Hausrath, Hitzig, Holzmann, Keim, Lipsius, x, Reuss, Roskoff, Schwarz, Schweizer, and other nent Biblical scholars. These names give prom- of thorough and original research, but of Rational- views. The work is to be comprised in 4 vols. . What has thus far appeared (Leipzig, 1868) does afford much new material or literature.

Other Biblical dictionaries entitled to special notice containing much original and useful matter are: Ravanel, *Bibliotheca Sacra* (Genev. 1660, fol.); J. Otho, *Lex. Rabbino-philologicum* (Gen. 1675, 12mo; h additions by J. F. Zachariä, Kiel, 1757, 8vo); A. henbergii *Hierolexikon reale collectum* (Lips. et ncf. 1714, 2 vols.); the *Dictionnaire Universel, Dog- tique, Canonique, Historique, et Chronologique des Scies Ecclesiastiques, et avec des Sermons abrégés des is célèbres Orateurs Chrétiens*, par le P. R. Richard, autres Religieux Dominicains, etc. (Paris, 1760-64, ols.); J. Brown (of Haddington), *Dictionary of the ly Bible* (London, 1769, 2 vols. 8vo, and often since; o N. Y. 8vo); W. F. Hezel, *Biblisches Real-Lexikon eipsc*, 1783-85, 8 vols. 4to); F. G. Leun, *Bibl. Ency- pädie* (Gotha, 1793-98, 4 vols. 4to); C. G. Haupt, *bl. Real. u. Verbal-Encyclopädie* (Quedlinb. 1820-7, 3 ls. 8vo); W. Goodhue and W. C. Taylor, *Pictorial ctionary of the Holy Bible* (London, 1843, 2 vols. sm. .); J. A. Bastow, *Biblical Dictionary* (Lond. 1848, 3 ls. 12mo; condensed edition, Lond. 1859, 12mo); H. iller, *Biblisches Wörterbuch* (Stuttg. 1855-8, 2 vols. rge 8vo); Krehl, *New-Test. Handwörterbuch* (Gött. 57, 8vo). Of less importance in this respect are the llowing: T. Wilson, *Complete Christian Dictionary* ond. 1661, fol.); J. C. Beck, *Vollständ. bibl. Wörter- ch* (Basel, 1770, 2 vols. fol.); J. A. Dalmasius, *Dicti- urium manuale Biblicum* (Aug. Vind. 1776, 2 vols. o); A. Macbean, *Dictionary of the Bible* (Lond. 1779, o); P. Oliver, *Scripture Lexicon* (Birmingham, 1784, o); London, 1843, 18mo); G. L. Gebhardt, *Biblisches örterb.* (Lemgo, 1793-6, 3 vols. 8vo); M. C. F. Schnei- er, *Wörterb. üb. d. Bibel* (Lpz. 1795-1817, 4 vols. 8vo); . Robinson, *Theolog., Biblical, and Eccles. Dictionary* ondon. 1815, 8vo; also 1835); J. C. Vollbeding, *Bibl. örterb.* (Berl. 1800-5, 3 vols. 8vo); C. A. Wahl, *Bibl. andwörterb.* (Lpz. 1828, 2 vols. 8vo); W. Jones, *Bib- lical Cyclopædia* (Lond. 1831, 2 vols. 8vo); R. Watson, *Biblical and Theol. Dictionary* (Lond. 1831, royal 8vo; . Y. also Nashville, 8vo); C. L. Walbrecht, *Biblich. örterbuch* (Gött. 1837, 8vo); S. Green, *Biblical and heol. Dictionary* (London, 1840, 1860, 12mo); J. Gard- er, *Christian Cyclopædia* (Edinb. n. d. 8vo); A. C. offmann, *Allgem. Volks-Bibelleikon* (Lpz. 1842 sq., to); J. Eadie, *Biblical Cyclopædia* (2d ed. 1849, 8vo); l. P. Lawson, *Bible Cyclopædia* (London, 1849, 3 vols. oyal 8vo); F. C. Oetinger, *Biblisches Wörterb.* (Stuttg. 1849, 8vo); J. Farrar, *Biblical and Theolog. Dictionary* ondon. 1862, 12mo); H. Malcom, *Dictionary of the B- le* (London, 1854, 18mo); J. A. Bost, *Dictionnaire de la Bible* (Paris, 1865, 8vo); J. Ayre, *Treasury of Bible Knowledge* (London, 1866, small 8vo); H. Besser, *Bibl. Wörterbuch* (Gotha, 1866, 8vo); J. Hamburger, *Bib- lich-talmudisches Wörterbuch* (Strelitz, 1866 sq., 8vo); with many others of still less extent or importance in this country as well as in Europe. The strictly Biblical articles contained in the general Cyclopædias, as a class, are usually too meagre to deserve particular at- tention in this comparison.

DICTIONARIES, ECCLESIASTICAL AND THEO- LOGICAL. Several of the works enumerated in the above article include ecclesiastical and theological topics, as well as Biblical; e. g. Richard, *Dictionnaire Universel*; Robinson, *Theological, Biblical, and Eccle- siastical Dictionary*; Watson, *Biblical and Theological*

Dictionary, etc. We add here a list of the most im- portant general theological dictionaries.

BROUGHTON (THOMAS), *Bibliotheca Historica Sa- cra, or an Historical Library of the principal matters relating to Religion* (London, 1787, 2 vols. fol.); a work admirably done, on the whole, for that time. It has been largely used by succeeding editors of cyclopædic works.

FERRARIS (F. LUCIUS), *Prompta Bibliotheca, canon- ica, juridica, moralis, theologica, necnon ascetica, po- lemica, rubricistica, historica* (Madrid, 1795, 10 vols. in 5, fol.; revised by the monks of Monte Cassino, Rome, 1844-5, 2 vols. 4to; new ed. by Migne, Paris, 8 vols. imp. 8vo, 1856-58), is a vast compendium of Roman Catholic theology, canon law, and of the other topics enumerated in the title. The abbé Migne's edition is the most useful, and the cheapest.

BUCK, *Theological Dictionary, containing Definitions of all religious and ecclesiastical Terms*, etc. (London, 1802, 2 vols. 8vo; many English and American edi- tions; the best by E. Henderson, Lond. 1833 to 1854). This manual has been very widely circulated, and has well deserved its good repute, though superseded now by later and larger works.

BROWN (J. NEWTON), *Encyclopædia of Religious Knowledge, or Dictionary of the Bible, Theology, Reli- gious Biography, all Religions, Ecclesiastical History, and Missions; containing Definitions of all religious Terms, and impartial Accounts of the principal Christian Denominations that have existed in the World from the Birth of Christ to the present Day* (Brattleborough, 1835, roy- al 8vo; and in many editions since). This useful work has had perhaps a wider sale than any book of its class has ever reached. It has not the scientific character of more recent books, but at the time of its issue it was up to the wants of general readers, as well as of ministers in actual work. It has a *Missionary Gazetteer* at the end, prepared by the Rev. B. B. Ed- wards, and very full and accurate at the time of pub- lication.

ASCHBACH (Roman Catholic), *Allgemeines Kirchen- Lexikon, oder alphabetisch geordnete Darstellung des Wissenswürdigsten aus der gesammten Theologie und ihren Hilfswissenschaften* (Frankfurt a. M., and Mainz, 1846-1850, 4 vols. 8vo). As the title states, this book aims at selections from the whole field of theological knowledge. It is very fair, on the whole; learned, generally accurate, and great skill in condensation is shown throughout the work.

WETZER und WELTE (Roman Catholic), *Kirchen- Lexikon, oder Encyclopædie der katholischen Theologie und ihrer Hilfswissenschaften* (Freiburg, 1848-56, 12 large vols. 8vo), is the most scientific and complete book of its class in Roman Catholic literature. The German Romanist theologians are, in general, far more learned and also more liberal than those of other countries, and this work is a valuable fruit of their industry and erudition. It covers, for Roman Catholic theology, the same field as that treated by Herzog for Protestant theology; and its editors excel in the cyclopædic fac- ulty, so that the length of its articles is better propor- tioned to their importance than is the case with its great Protestant compeer. Nevertheless, the work is still far behind Herzog in learning and completeness.

FARRAR (JOHN), *An Ecclesiastical Dictionary, ex- planatory of the History, Antiquities, Heresies, Sects, and Religious Denominations of the Christian Church* (Lond. 1853, 12mo, p. 560), is a compact manual, chief- ly abridged from Bingham, Coleman, Riddle, and other writers on antiquities, with descriptions also of mod- ern sects, denominations, and usages. It is very well prepared, and forms a useful hand-book, especially for general readers; the absence of references to authori- ties makes it less valuable for students.

EADIE (JOHN), *Ecclesiastical Cyclopædia, or Dictio- nary of Christian Antiquities and Sects* (London, 1862, 12mo, 2d ed.). This work covers Theology, Patris-

tica, Church History, Archæology, etc. but, of course, in a brief and summary way. It draws largely from the *Encyclopædia Metropolitana* (which belongs to the same publishers), but a great deal of valuable and recent matter has been added by Dr. Eadie.

HOOKE, W. F., *A Church Dictionary* (sixth edition, London, 1862, 8vo; American edition, Philadelphia, 1854, 8vo). This is a compilation intended especially to set forth, for members of the Church of England, the "more important doctrines of the Church, and the fundamental verities of our religion." As an original authority it is of little value. Dr. Hook adopted (and acknowledged the adoption of) the title of Dr. Staunton's *Church Dictionary*, but he also "adopted," without acknowledgment of any kind, more than fifty pages of the matter of that excellent work.

STAUNTON, *Dictionary of the Church* (N. Y. 1839, 12mo), and, in enlarged form, *An Ecclesiastical Dictionary* (New York, 1864, 8vo), treats of the history, ritual, worship, discipline, ceremonies, and usages of the Church, from the point of view of the Protestant Episcopal Church. This work is careful, scholarly, and reliable within its sphere. It was largely used by Hook (see above).

EDEN (ROBERT), *The Churchman's Theological Dictionary* (3d edition, Lond. 1859), aims to give a "plain and simple explanation of theological and ecclesiastical terms, without entering into controversy;" and it accomplishes its aim admirably. In terseness and clearness of statement this little book is almost without a rival among brief dictionaries. It is written for the Church of England, but its point of view is that of the so-called moderate Episcopalians.

HERZOG, *Real-Encyclopædie für protestantische Theologie und Kirche, in Verbindung mit vielen protestantischen Theologen und Gelehrten herausgegeben von Dr. Herzog, ord. Prof. d. Theologie in Erlangen* (Gotha, 1854-66, 18 vols. and 3 supplementary vols., with index volume additional). This great work professes to treat of all important subjects in the entire range of Protestant theological science in one alphabet. In scientific structure, as well as in extent of learning, this Cyclopædia far surpasses all others in the same field. Its greatest fault is want of careful editorial supervision; each writer seems to have been allowed to treat his subject as he pleased, and to fill one page or ten, without sufficient reference to the comparative importance of the subjects discussed. Its deficiencies in English and American topics are very marked; but, with all drawbacks, the *Real-Encyclopædie* is a great treasury of theological and historical science, and must hold its place for many years as such. A condensed translation of the work was commenced in 1856 by the Rev. J. H. A. Bomberger, D.D., assisted by distinguished theologians of various denominations. Unfortunately, the publication was suspended at the 12th number (article Josiah).

A brief Theological and Biblical Dictionary, which is to embrace in 2 vols. the whole field of theology, was begun in Germany at the beginning of 1868 (*Theologische Univ.-Lex.* Elberfeld, 1868). The names of the editor and contributors are not given. In its tendency it promises to be entirely objective.

In France, a compendious "Universal Dictionary of Ecclesiastical Science" (*Dictionnaire Universel des Sciences Ecclésiastiques*, Tours, 1868), in 2 vols., has been published by abbé Glaire, well known by a number of exegetical works.

Besides the above, there are numerous hand-books, on special topics, arranged in alphabetical order, such as Fuhrmann, *Handwörterbuch der christlichen Religions- und Kirchen-geschichte* (Halle, 1826-29, 4 vols. 8vo); Stegel, *Handbuch der christlich-kirchlichen Alterthümer* (1836-38, 4 vols. 8vo); Doering, *Die gelehrten Theologen Deutschlands* (Berlin, 1831-35, 4 vols. 8vo); Doering, *Die deutschen Kanzel-Redner* (Berlin, 1830, 8vo); Bergier, *Dictionnaire de Théologie* (ed. by Gous-

set, Paris, 1854, 6 vols. 8vo); Newcomb, *Cyclopædia of Missions* (New York, 1864, 8vo); Jones, *Christian Biography* (Lond. 1829, 12mo); Jamieson, *Cyclopædia of Religious Biography* (Lond. 1853, 12mo); Hoak, *Ecclesiastical Biography* (Lond. 1846-1852, 8 vols. 12mo); *Cyclopædia of Religious Denominations* (Glasgow, 1852); Martigny, *Dictionnaire des Antiquités Chrétiennes* (Par. 1865, large 8vo). The abbé Migne has published the series of the *Encyclopédie Théologique*, containing 16 volumes, and professing to treat of all subjects within the range of theological literature. Few of them are of scientific value, and the whole series is, perhaps, at least important and useful of Migne's great undertakings.

Diderot, DENYS, a French writer and infidel philosopher, was born Oct. 5, 1713, at Langres, in Champagne, where his father was a cutter. He was educated for the Church at the Jesuits' College of Langres; but, declining to take orders, he studied in London, soon abandoned that pursuit, and devoted himself to literature. "After ten years of obscure drudgery he became one of the most famous among those literate and scientific men whose attacks on the established order of things, religious and ecclesiastical as well as political, acted so powerfully in precipitating the French Revolution. Diderot projected the *Encyclopédie, ou Dictionnaire Raisoné des Sciences, des Arts et des Mètièrs*, which was designed not merely to supersede the imperfect dictionaries of Chambers and others then in use, but to teach, on every occasion which could admit the teaching, the social and infidel doctrines which were held by the writers. In the course of it, and afterwards, Diderot wrote several didactic treatises, in decent and irreligious novels, and two sentimental comedies; and his published correspondence, especially with Voltaire and Grimm, throws much light on the gloomy picture which French society and morals then presented." He died at Paris July 30, 1784. "The great peculiarity of Diderot was his encyclopædic knowledge, and his versatility in comprehending a variety of subjects. Less critical than Voltaire, and less philosophical than Rousseau, he exceeded both as a practical teacher. But in unbelief he unhappily advanced farther than either; his temper lacked moral earnestness, and in later life he was an atheist. A growth of unbelief may be traced in him: at first he was a doubter, next he became a deist, lastly an atheist. In the first stage he only translated English works, and even condemned some of the English deists. His views seem gradually to have altered, probably under the influence of Voltaire's writings, and of the infidel books smuggled into France; and he thereafter assumed a tone bolder and marked by positive disbelief. In 1746 he wrote his *Pensées Philosophiques*, intended to be placed in opposition to the *Pensées* of Pascal. Pascal, by a series of sceptical propositions, had hoped to establish the necessity of revelation. Diderot tried by the same method to show that the revelation must be untrue. The first portion of the propositions bore upon philosophy and natural religion, but at length he came to weaken the proofs of the truth of Christianity, and controverted miracles, and the truth of any system which reposes on miracles; yet even in this work he did not evince the atheism which he subsequently avowed. It was soon after the imprisonment in which he was involved by this book that he projected the plan of the magnificent work, the *Encyclopédie*, or universal dictionary of human knowledge. Its object, however, was not only literary, but also theological; for it was designed to circulate among all classes new modes of thinking, which should be opposed to all that was traditional. Voltaire's unbelief was merely destructive; this was reconstructive and systematic. The religion of this great work was deism, the philosophy of it was sensationalist and almost materialist, seeming hardly to allow the existence of anything but mechanical be-

s. Soul was absorbed in body; the inner world in outer—a tendency fostered by physics. It was the **w of things** taken by the scientific mind, and lacks poetical and feeling elements of nature—a true **e of the cold and mechanical age** which produced

Diderot's atheism is a still further development **is unbelief**. It is expressed in few of his writings, **l presents** no subject of interest to us, save that it **ks to invalidate** the arguments for the being of a **d, drawn** from final causes. It has been well **oved** that the lesson to be derived from him is that **; mechanical** view of the world is essentially athe-
ic; that whosoever will admit no means **discovering** God but common logic, can-
not find him. Diderot's unbelief has been **isidered** to embody that which resulted **m the abuse** at once of erudition, phys-
ical science, and the sensational theory in **staphysics"** (Farrar, *Critical History of*
ve Thought, lect. v). A collection of his **ncipal** works was published by his disci-
ple Naigeon, in 15 vols. 8vo, 1798, and re-
inted since in 22 vols. 8vo, Paris, 1821,
with a life of the author by Naigeon him-
self, which, however, is rather a dissertation
on Diderot's writings and opinions than a
biography. Supplementary to the above edition

of Diderot's works are *Correspondance philos. et critique*
: Grimm et Diderot (Paris, 1829, in 15 vols.), and the
lémotres, Correspondance, et Ouvrages inédits de Dide-
rot (Paris, 1830, 4 vols.). See also Rosenkranz, *Dide-*
rot's Leben und Werke (1866, 2 vols.); Carlyle, *Miscel-*
lanea, vol. iv; Rich, *Dictionary of Biography*; *Engl.*
yclopædia; Vinet, *French Literature*; Hoefer, *Nouv.*
Biog. Générale, xiv, 80 sq.

Didier, or Géry (in Latin **DESIDERIUS**), bishop
of Cahors, was born at Albi in 595. He was of a no-
ble family in Aquitania, and was educated at the court
of king Clotaire II, who appointed him treasurer of the
royal domain. Dagobert, the son and successor of Clotaire,
made him, in addition to his office of treasurer,
count of Metz, and governor of Marseilles. In 629, when his
brother Rusticus, bishop of Cahors, was assassinated,
Didier was chosen his successor. As bishop he became
very rich, and made himself popular by a judicious
use of his wealth. Didier is a popular saint in South-
western France under the name of Géry. His works have
been lost; only sixteen *epistles*, addressed to prominent
persons of his time, as the kings Dagobert and Sigebert
III, are still extant. These epistles have been
published by Canisius (*Antiquæ Lectiones*, tom. v), in
Migne, *Patrologia Lat.* vol. lxxxvii, and by Bouquet,
Collection des Historiens de France, tom. iv.—Hoefer,
Biog. Générale, xiv, 102.

Didier, Sr., archbishop of Vienne, was born at Au-
tun, and became bishop of Vienne in 596. As he gave
instruction in belles-lettres and ancient literature, he
was denounced to Gregory the Great as teaching his
pupils pagan literature. Didier found it easy to justify
himself; but, having reproved queen Brunehild for
her conduct, this princess convoked a synod at Chalons
sur Saone and in 603 Didier was deposed and
exiled to an island in the river Rhone. Four years
after he was restored to his see, but as he did not cease
to censure the queen, and as he endeavored to with-
draw the young king Thierry from the influence of
his grandmother, Brunehild had him waylaid and as-
sassinated in a village called Priscinacum, on the
bank of the Chalarone (subsequently called St. Didier
de Chalarone), on May 28, 606. On Feb. 11, 1620, the
body of Didier was transferred to St. Peter and Paul's
church at Vienne. Several other churches claim to
possess some relics of Didier, who is commemorated by
the Church of Rome as a saint on Feb. 11 and May
28. Lives of Didier have been published by Mom-
brice and Chifflet.—Hoefer, *Biog. Générale*, xiv, 101.

Didrachm (Greek *δίδραχμον*, Lat. *didrachma*—**a**
double drachma, "tribute," Matt. xvii, 24), a silver coin
equal to two Attic drachmas, and also to the Jewish
half shekel (Joseph. *Ant.* iii, 8, 2). It was therefore
equivalent to about 1s. 4d. sterling, or 80 cents. See
DRAM; STATER. By the law every Jew was required
to pay half a shekel to the Temple (Exod. xxx, 13
sq.), and this amount is represented by the didrachma
in Matt. xvii, 24, where it is used for the "tribute-
money" demanded of Christ (compare Josephus, *Ant.*
xviii, 9, 1). The Septuagint everywhere renders the
"shekel" of the Old Testament by *didrachma*; but as

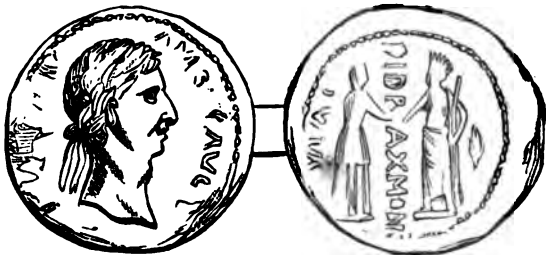

Roman Didrachm with Greek Inscription.

the Attic drachma was equal to only half a shekel, it
seems from this probable that the drachma of Alexan-
dria was equal to two Attic drachmas, or one of Ægina.
See Frentz, *De didrachmis a Christo solutis* (Viteb.
1787); Schmidt, *id.* (Argent. 1701; Lips. 1767; also in
his *Diapp.* p. 796-868); Leisner, *Illustratio loci* Matt.
(Fridericopol. 1794); Paulus, *Erwerbungsmitel des Stater*
(in his *Theol. Journ.* 1795, p. 859-78, 931-45). See
TRIBUTE.

Didymus (*Δίδυμος*, the *Twins*), a surname (John
xi, 16) of the apostle **THOMAS** (q. v.).

Didymus of Alexandria (called *the Blind*) was
born at Alexandria about A. D. 311, and unfortunately
lost his sight in the fourth or fifth year of his age; yet
he arrived at great proficiency, it is said, in philoso-
phy, rhetoric, mathematics, music, and divinity (Socra-
tes, *Ecl. Hist.* iv, 25). He became master of the
catechetical school of Alexandria, where his fame drew
to him "numbers from distant parts to see him only;"
and among his disciples were St. Jerome, Rufinus, Pal-
ladius, Evagrius, and Isidore. Anthony, the chief of
the Recluses, visited him; and seeing him blind, said,
"Let it nothing move you, O Didymus, that your bod-
ily eyes are lost, for you are deprived only of the same
kind of eyes as serve the basest insects for vision; but
rather rejoice that you possess those with which an-
gels are seen, and God himself is discerned." He
died at Alexandria A. D. 396. He opposed the Arian
doctrine, but seems to have embraced certain of the
views of Origen, which caused him to be condemned
at the fifth General Council of Constantinople. He
was a voluminous writer, but most of his works are
lost; there is a list of them in Jerome, *De Vir. Illust.*
and in Fabricius, *Bibliotheca Græca*, ix, 269 sq. (ed.
Harles). Those that are preserved are (1.) *De spiritu*
Sancto (of the Holy Spirit), of which Jeromæ made a
Latin version, which is preserved among his works.
The Greek original is lost. It is given in Galland's
Bibliotheca Patrum, vol. vi; in Migne, *Patrologia Græca*,
xxxix; and in separate editions, Cologne, 1581,
8vo; and (better) Helmstadt, 1614, 8vo. The book
teaches that the Holy Spirit is not a mere name or
property, but a real existence "in union with the Fa-
ther and the Son, and different from all created things;"
that it is the cause of wisdom, knowledge, and sancti-
fication; and (Luke xi, 13) "that it is the fulness of
the gifts of God; and all divine benefits subsist through
it, since whatever gift God's grace bestows flows down
from this fountain;" that it is *unbounded*, therefore no
creature (Mark xiii, 11); that it is not of the nature

of angels, for they are not *essentially* holy; that it is not a creature, for men's spirits are said to be filled with it, and no mind can be filled with a creature; nor is it a quality, for the working of an agent is attributed to it; that it exists with and as God, and is so called Acts v, 3, 4; and that it, with the Father and the Son, forms one essential Godhead in a Trinity of persons, each capable of distinct action in the same time and place; and that the Holy Spirit is of the *same nature* with the Father and the Son, because they have the same operation, etc. (2.) *Brevés narraciones in Epistolas Canonicas* (Exposition of the Catholic Epistles), given in Migne, *Patr. Gr.* vol. xxxix, and in other collections:—(3.) *Liber adversus Manichæos*, of which the original Greek is given in Canisii *Lect. Antiq.* i, 204 (compare Basnage's notes in his ed. of Canisius); also in Combefis, *Actuarium Noviss.* vol. ii, and in Migne, *Patr. Gr.* xxxix:—(4.) *De Trinitate*, Libri tres (*περί Τριᾶδος*), which was long lost, but was found by Joh. Aloys. Mingarelli, and published by him at Bologna, 1769, fol. It is given (Greek and Latin) in Migne, vol. xxxix, where also are several fragments of the Commentaries of Didymus on various parts of Scripture. See the notices in Migne, *Patrol. Græc.* xxxix, 140 sq.; Fabricius, *Bibliotheca Græca*, ix, 269 sq.; Cave, *Historia Literaria*, anno 370; Ceillier, *Auteurs Sacrés*, vol. v, ch. xix (Paris, 1865); Schroeckh, *Kirchengeschichte*, vii, 71 sq.; Guericke, *De Schola Alexandrina*; Schaff, *History of the Christian Church*, iii, § 167; Lardner, *Works*, iv, 800; Dupin, *Ecclesiastical Writers*, ii, 108; Clarke, *Succession of Sacred Literature*, i, 397; Lücke, *Questiones Didymianæ* (Gött. 1829); Alzog, *Patrologie*, § 52 (Freiburg, 1866, 8vo).

Didymus (Zwilling), Gabriel, a friend and co-worker of Luther, was born at Joachimsthal, in Bohemia, in 1487. He studied at Prague and Wittenberg, joined the Augustinians in 1502, and became priest in 1513. He was among the first to embrace the principles of the Reformation, and in 1521 caused private masses to be abolished in the Augustinian convent of Wittenberg, as well as the practice of begging, and substituted in their stead that of preaching on texts taken from Scripture. He afterwards severed his connection with the convents, and engaged in Carlsstadt's crusade against learning, but subsequently acknowledged his error on this point. He left Wittenberg, however, and went as pastor to Düben and Torgau. He was deposed in 1549 by Moritz of Saxony for his opposition to the Leipzig Interim (q. v.), and died in retirement in 1558. See Seckendorf, *Commentarius de Lutheranismis*; Terne, *Nachricht von des G. Didymus fatalem Leben* (Leipsic, 1737, 4to); Herzog, *Real-Encyclopædie*, iii, 384; Planck, *Geschichte d. prot. Theologie*, iv, 243 sq.

Dieffenbacher, Jacob Follmer, a minister of the German Reformed Church, was born near Milton, Northumberland County, Pa., December 18, 1802. He spent his youth on a farm, and in a saw-mill and cloth factory. He pursued his preparatory studies in the Milton Academy, and studied theology in the Theological Seminary of the German Reformed Church then at Carlisle, Pa. He was licensed and ordained in 1828, and was pastor successively in Sharpsburg charge, Md., Mercersburg, Pa., Woodstock, Va., and Harmony, Butler County, Pa. In this last charge he devoted part of his time to teaching. He died Feb. 4, 1842. While at Woodstock he published a small work entitled *The Scripture Doctrine of Water Baptism, of Infant Baptism, and Baptism by Pouring or Sprinkling*. At Woodstock, Va., he was compelled to stand a trial in court for an alleged violation of law in expressing certain sentiments on the subject of slavery in an address on colonization. He was, however, acquitted, but soon after left the state. He preached in German and English, and was a warm-hearted and zealous minister.

Diepenbrock, Melchior Baron of, was born at Bocholt, in Westphalia, January 10th, 1762. In 1814 he entered the Prussian militia, and afterwards studied theology at Landshut, Mayence, and Münster. He was consecrated priest in 1823, but remained vicar bishop Sailer (q. v.) as secretary at Regensburg. In 1830 he was made dean, and in 1835 prebendary of the cathedral. He afterwards acted as episcopal vicar general from 1842 to 1844, was created baron in 1844, and elected prince bishop of Breslau. In 1848 he was sent to the Parliament at Frankfort. In the conflict between the Prussian government and the Legislature, which refused to the former the right of levying taxes, Diepenbrock vigorously supported the government, and issued a pastoral, which, by order of the government, was published in all the official papers. He was made cardinal in 1850, and died Jan. 20, 1853, at Johannsberg, in Austrian Silesia. In 1850 he bequeathed the Melchior fund of 10,000 florins for the support of poor chaplains in the Austrian part of the diocese of Breslau. He was a moderate Papist, and, like most of the school of Sailer, earnest in piety and Church reforms. See SAILER. His principal works are, *Sacrilicher Blumenstrauß* (Regensburg, 1826; 2d ed. Salzb. 1852):—*Erinnerungen an d. jungen Grafen v. Stolberg. Leben Heinrich Suso's* (Regensb. 2d ed. 1837):—*Fastmische Stilleben nach Conscience*, and several sermons. A biography of Diepenbrock was published by his successor in the see of Breslau, bishop Foerster, in 1853.—Pierer, *Universal-Lexikon*, s. v.

Dies Absolutiōnis. One of the names of Good Friday. The title originated with the custom of absolving penitents from ecclesiastical penalties on this day.—Ambrosius, *Epist.* 33; Siegel, *Handbuch d. Aethiomer*, i, 376.

Dies Cinērum, the Latin name for **ASH-WEDNESDAY** (q. v.).

Dies Cœnæ Dominicæ or **Eucharistia**, one of the designations of Maundy Thursday (q. v.). It was distinguished by the celebration of the Lord's Supper. See MAUNDY THURSDAY.

Dies Dominicus (*ἡ κυριακή*), the ancient name of the Lord's Day, which was also called Sunday, *dominica*, especially when, in addressing the heathen, it was necessary to distinguish the day. During the early ages it was never called the Sabbath, that word being confined to the seventh day of the week, which continued to be observed by the Jews, and in part also, for a short time, by some of the converts to Christianity.—Bingham, *Orig. Eccles.* bk. xx, ch. ii, § 1; Coleman, *Ancient Christianity*, ch. xxiii, § 2.

Dies Iræ, the famous Latin judgment hymn of the 13th or 14th century, which, in its received form, reads as follows:

Dies iræ, dies illa,
Solvat sæculum in favilla,
Teste David cum Sibylla.
Quantus tremor est futurus,
Quando Juxta est venturus,
Cuncta stricte discussurus?
Tuba, mira! nunc spargens sonum
Per sepulchra regionum,
Coquet omnes ante thronum.
Mors stupebit et natura,
Quum resurget creatura,
Judicanti responsura.
Liber scriptus profertur,
In quo totum continetur,
Unde mandus judicetur.
Juxta ergo quum œdebit,
Quidquid latet, apparebit,
Nil inultum remanebit.
Quid sum miser tunc dicturus,
Quem patronum rogaturus,
Quum vix justus sis securus?
Rex tremende! majestatis,
Qui salvandos salvas gratis,
Salva me, fons pietatis.

Recordare, Jesu ple,
Quod sum causa tuæ viæ,
Ne me perdas illa die.

Quærens me sedisti lassus,
Redemisti cruce passus:
Tantus labor non sit cassus.

Iuste iudex ultionis,
Donum fac remissionis
Ante diem rationis.

Ingemisco tanquam reus,
Culpâ rubet vultus meus:
Supplicanti parce, Deus.

Qui Marlam absolvisti,
Et latronem exaudisti,
Mihî quoque spem dedisti.

Preces meæ non sunt dignas,
Sed tu, bone, fac benigne,
Ne perenni cremer igne.

Inter oves locum præsta,
Et ab hæcîs me sequestra,
Statuens in parte dextra.

Confutatis maledictis,
Flammis scribis addictis,
Voca me cum benedictis.

Oro supplex et acclinis,
Cor contritum quasi cinis,
Gere curam mei finis.

[Lacrimosa dies illa,
Qua resurget ex favilla
Judicandus homo reus;
Huic ergo parce, Deus.
Pie Jesu Domine
Dona eis requiem. Amen.]

This is the text of the Roman Missal. The last six lines we consider as an addition by another hand from later hymns in public use. Daniel (*Theaurus hymnol.*, 103) gives two other forms; one considerably longer, from a marble slab in the Franciscan church at fantua (first published by Mohnike, who, without good reason, considers it the original form), and commencing,

Cogita (Quæso) anima fideles
Ad quid responderis velis
Christo venturo de coelis.

I. *Contents.*—The hymn is variously called *Prosa le mortuâs*, *De die judicîi*, *In commemoratione defunctorum*, and is used in the Latin Church on the day of All Souls (Nov. 2), in masses for the dead, and on funeral solemnities. It is a judgment hymn, based upon the prophetic description of the great day of the Lord in Zeph. i, 15, according to the translation of the Vulgate: "DIES IRÆ, DIES ILLA, dies tribulationis et angustie, dies calamitatis et miseria, dies tenebrarum et caliginis, dies nebulae et turbinitis, dies tuba et clangoris super civitates munitas et super angelos ecclesios." The first words of this passage furnished the beginning and the theme of the poem. The other Scripture passages which the author had in view are Psa. cii, 26; xcvi, 13; xcvii, 8, etc. (hence *David* is introduced in the third line of the first stanza as the Scripture prophet of that day); 2 Pet. iii, 7-11 ("The day of the Lord will come as a thief in the night," etc.—hence in some versions *Peter* is substituted for *David*), and the descriptions which Christ himself gives of the general judgment (Matt. xxiv and xxv). But the Sibyl is also mentioned, as the representative of the unconscionable prophecies of heathenism, with allusion to the Sibylline oracle of the destruction of the world, commencing "*Væ quas illa dies deprendit.*" This apocryphal feature, though somewhat repugnant to Protestant taste, and hence omitted or altered in many Protestant versions of the poem, is in perfect keeping with the patristic and scholastic use of the Sibylline oracles, the 4th Eclogue of Virgil, and other heathen testimonies of the same kind, for apologetic purposes. It is intended to give the idea of the judgment of the world a universal character, founded in the expectations of Gentiles, Jews, and Christians, and indicated by the light of reason as well as the voice of revelation. The mediæval painters likewise place the Sibyl alongside of the prophets of Israel. The poem first describes the judg-

ment as a certain fact, with its accompanying terrors; then gives expression to the sense of guilt and dismay, and ends with a prayer for mercy, which prompted Christ to die for poor sinners, and to forgive the penitent thief.

II. *Character and Value.*—The *Dies Iræ* is universally acknowledged to be the sublimest production of sacred Latin poetry; and the grandest judgment hymn of all times and tongues. Daniel (*The. hymnol.* ii, p. 112) justly styles it "*uno omnium consensu sacra potèsses summum decus et ecclesie latine cernimur pretiosissimum.*" "It would be difficult," says Coles, "to find, in the whole range of literature, a production to which a profounder interest attaches than to that magnificent canticle of the Middle Ages, the *Dies Iræ*. . . . Of Latin hymns it is the best known, and the acknowledged masterpiece." The Germans call it the hymn of giants (*Gigantenhymnus*). In simplicity and faith it fully equals an older anonymous Latin judgment hymn of the seventh or eighth century, commencing *Apparebit repentina magna dies Domini*, while in lyric fervor and effect, as well as in majesty and terror, it far surpasses it and all the numerous imitations of later times. It stands solitary and alone in its glory, and will probably never be surpassed. It is truly "a thing of beauty that is a joy forever." Among poetic gems it is the diamond. It breathes, indeed, the mediæval spirit of legalistic rather than of joyous evangelical piety, but otherwise it is quite free from every objectionable feature of Romanism, which cannot be said of the two famous *Stabat Maters* (the *Mater dolorosa*, and the recently discovered *Mater speciosa*), tinctured as these are with Mariolatry. It represents salvation as an act of the free grace of Christ, *qui salvandos salvat gratis*. Hence it is as much admired by Protestants as by Roman Catholics. The secret of its beauty and power lies first in the intensity of Christian feeling with which its great theme is handled. The poet feels, as an awful and overpowering reality, the coming judgment of the quick and the dead; he hears the trumpet of the archangel sounding through the open sepulchres; he sees the tumult and terror, the devouring flames and final wreck of the universe, the Judge seated in terrific majesty on the throne, with the open book of the deeds of ages, dividing the good from the bad, and pronouncing the irrevocable sentence of eternal weal and woe; and with the spirit of an humble penitent he pleads for mercy, mercy, mercy, at the hands of Him who pardoned the penitent thief in his dying hour. The poem is in the highest degree pathetic, a cry from the depth of personal experience, and irresistibly draws every reader into sympathetic excitement. That man is indeed to be pitied who can read it without shaking and quivering with emotion. It is pregnant with life, and brings us face to face with the awful scenes of the judgment day. "It is electrically charged, and contact is instantly followed by a shock and shuddering." The second element of its power lies in the inimitable form, which commands the admiration of every man of taste. Whatever there is of dignity, majesty, and melody in the old Roman tongue is here brought out and concentrated as in no other poem, heathen or Christian, and made subservient to the one grand idea of the poem. It is onomatopoeitic, and echoes, as well as human language can do, the storm, and wrath, and wailing of the judgment day. Every word sounds like the solemn peal of an organ, or like the trumpet of the archangel summoning the dead to everlasting bliss or to everlasting woe. The stately metre, the triple rhyme, the selection of the vowels in striking adaptation to the sense and feeling, heighten and complete the effect upon the ear and the heart of the hearer. The music of the vowel assonances and consonances, e. g. the double u in the 2d and 7th stanzas (*futurus, venturus, discussurus; diciturus, rogaturus, securus*); the o and u in the 3d stanza (*sonum, regium, thronum*);

and the *i* and *e* in the 9th stanza, defy the skill of the best translators in any language. We quote the judgments of eminent writers. "Quot sunt verba tot pondera, immo tonitrua," says Daniel. "Combining somewhat of the rhythm of classical Latin with the rhymes of the mediæval Latin, treating of a theme full of awful sublimity, and grouping together the most startling imagery of Scripture as to the last judgment, and throwing this into yet stronger relief by the barbaric simplicity of the style in which it is set, and adding to all these its full and trumpet-like cadences, and uniting with the impassioned feelings of the south, whence it emanated, the gravity of the north, whose severer style it adopted, it is well fitted to arouse the hearer" (Dr. W. R. Williams). "The metre so grandly devised, of which I remember no other example, fitted though it has here shown itself for bringing out some of the noblest powers of the Latin language—the solemn effect of the triple rhyme, which has been likened to blow following blow of the hammer on the anvil—the confidence of the poet in the universal interest of his theme, a confidence which has made him set out his matter with so majestic and unadorned a plainness as at once to be intelligible to all—these merits, with many more, have combined to give the *Dies Ira* a high place, indeed one of the highest, among the masterpieces of sacred song" (Archbishop Trench). (Dr. Trench is mistaken when he says that there is no other example of this metre. There are some verses of striking resemblance attributed by some to St. Bernard, but probably of much later date:

"Cum recordor moriturus
Quid post mortem sibi futurus,
Terror terret me venturus,
Quem expecto non securus.
Terret dies me terroris,
Dies iræ ac furoris,
Dies luctus ac mœroris,
Dies ultrix peccatoris,
Dies iræ, dies illa."

"Every line weeps. Under every word and syllable a living heart throbs and pulsates. The very rhythm, or that alternate elevation and depression of the voice which prosodists call the *arsis* and the *thesis*, one might almost fancy were synchronous with the contraction and the dilatation of the heart. It is more than dramatic. The horror and the dread are real; are actual, not acted" (A. Coles). "*Diess schauerliche Gedicht*," says Fred. von Meyer, "arm an Bildern, ganz Gefühl, schlägt wie ein Hammer mit drei geheimnisvollen Reimklängen an die Brust" ("This awful poem, poor in images, all feeling, beats the breast like a hammer with three mysterious rhyme-strokes"). "The *Dies Ira*," to quote from V. Cousin (*Lectures on the True, the Beautiful, and the Good*, p. 177), "recited only, produces the most terrible effect. In those fearful words every blow tells, so to speak; each word contains a distinct sentiment, an idea at once profound and determinate. The intellect advances at each step, and the heart rushes on in its turn." No wonder that literary men and secular poets have been captivated by the *Dies Ira*, as well as men in full religious sympathy with its solemn thoughts and feelings. Göthe introduces it with thrilling effect in the cathedral scene of *Faust* to stir up the conscience of poor Margaret, who is seized with horror at the thought of the sounding trump, the trembling graves, and the fiery torment. Dr. Johnson could never repeat the stanza ending, *Tantus labor non sit cassus*, without bursting into a flood of tears. The earl of Roscommon, "not more learned than good," in the moment in which he expired, uttered with the most fervent devotion two lines of his own version:

"My God, my Father, and my Friend,
Do not forsake me in my end!"

Sir Walter Scott also happily reproduced some stanzas of the *Dies Ira* for his "Lay of the Last Minstrel," and was heard repeating them on his dying bed, when

the strength of his body and mind was failing. The *Dies Ira* has also given rise to some of the grand musical compositions of Palestrina, Durante, Pergolesi, Haydn, Vogler, Winter, Cherubini, Gottfried Weber, Neukomm, and especially of Mozart, in his *Requiem*, during the composition of which he died (1791).

III. The *Authorship* of the *Dies Ira* cannot be certainly fixed. The writer evidently was unconscious about his own fame. It is now, however, pretty generally assigned to the Franciscan monk Thomas a Celano (a little town in Abruzzo ulteriore, in Italy), the biographer of his intimate friend St. Francis of Assisi's *Acta Sanctorum*, Oct., tom. ii). He was superior of the Franciscan convents of Cologne, Mayence, Wetzlar, and Speyer, and died after A.D. 1255. The oldest testimony in favor of this view is taken from Bernhardinus Albizzi of Pisa († 1401), in his *Liber consuetudinum* of 1385, where he says: "*Frater Thomas a mandato apostolico scriptis sermone posito legendam primam beati Francisci, et PROBAM DE MORTU, QUI CANTATUR IN MISSA, 'DIES IRÆ,' etc. DICITUR FICISSE.*" This proves only that at that time the *Dies Ira* was part of the Missal, and was believed by some to be the work of Thomas. Lucas Wadding, in his *Annals* of the Franciscan order (1650), defends this tradition, and Mohnike, Rambach, Daniel, Koch, Palm, Mone, Wackernagel, Coles, and other modern writers on the subject, adopt it as the most probable opinion. The rivalry of monastic orders has interfered with the question of authorship, and Dominicans and Benedictines have disputed the claims of the Franciscans. But there is no more or much less evidence for any of the other names which have been suggested, as Gregory the Great, St. Bernard, Bonaventura, Matthæus a Aquasparta, Latinus Frangipani, Felix Hemmerlin (Malleolus, of Zürich, 1389-1450), etc. It is certainly not older than Thomas a Celano, but rather of a later date. The extraordinary religious fervor which characterized the early history of the Franciscan order may be considered an argument of internal probability for the authorship of Thomas a Celano. If this be true, and if Jacopone is the author of the *Stabat Mater* (as asserted by L. Wadding), then we are indebted to the Franciscan order for the most sublime as well as for the most pathetic hymn of the Latin Church. Mone (*Lateinische Hymnen des Mittelalters*, 1853, i, 408) has suggested the idea that the *Dies Ira* arose, not, as heretofore supposed, simply from the individual contemplation of a monk in his lonely cell, but was inspired by older judgment hymns in public use, and was composed with an original view to the public service in *missa Defunctorum*. In one of them, which he found in a MS. at Reichenau from the 12th or 13th century, the passage occurs:

"*Lacrimosa dies illa,
Qua resurgens ex favilla
Homo reus iudicatus,
Justus autem coronandus.*"

The closing suspirium:

"Pie Jesu, Domine,
Dona eis requiem."

is likewise found in older hymns and Missals. Mone conjectures that the author of *Dies Ira* himself appended these lines from older sources to his poem, since they did not fit in his triple rhyme. Daniel (tom. i, 181, and v, 110) and Wackernagel (*Das deutsche Kirchenlied von der ältesten Zeit*, etc. i, 138) are disposed to adopt this view. But it seems much more probable that the original poem closed with *Gere curam mei finis*, and that the remaining six lines, with their different versification, and the change from the first to the third person (*huic* and *eis*), were added from an older funeral service already in use by the compilers of mediæval Missals, and not by the author. Thus we have a perfectly uniform production, which probably emanated from a subjective state of mind without re-

urd to public use, but which soon found its way, on account of its intrinsic excellency, into the Church service, since the deepest subjectivity in lyric poetry is the best kind of objectivity. It certainly was in public use already in the 14th century in Italy, and gradually passed into the Church service of other countries, attaining along its track "the luminous footprints of a victorious progress as the subduer of hearts."

IV. *Translations.*—No poem has so often challenged and defied the skill of the best translators and imitators. The unusually large number of translations proves that none comes up to the original. Its music, majesty, and grandeur can only be imperfectly reproduced in modern languages. "Its apparent artlessness and simplicity indicate that it can be turned readily into another language, but its secret power refuses to be thus transferred." The Germans have generally succeeded better than the English, owing to the larger number of double rhymes in the German language. But some English translations are admirable. Dr. Lisco, in a monograph on the *Dies Iræ*, A.D. 1840, counted forty-four versions, mostly German, to which, three years afterwards, he added seventeen more. There must be at least thirty English versions which Dr. Lisco did not know. There is a Greek version by Hildner, a missionary of the Church of England (*Ὁ ῥῆγῆς ἔκτιν' ἠμῆρα*, given by Daniel, ii, 105). Of German versions we may mention those of A. W. von Schlegel (*Jenen Tag, den Tag des Zorns*), Bunsen (*Tag des Zorns, o Tag voll Grauen*), Knapp (two: *An dem Zornstag, an dem hohen, and Jenen Tag, den Tag der Wehen*), Seld (*Zorn und Zittern bange Klag ist*), Daniel (two: *Tag des Zorns, du Tag der Fülle, and David und Sibylla spricht*), Toestrup (*Zornstag, schrecklichster der Tage*), Königsfeld (*An dem Zornstag, jenem ichren*), J. P. Lange (*Jener Tag des Zorns, der Tage*), Schaff (two in his *Deutsche Kirchenfreund* for 1858, p. 188 sq.: *An dem Tag der Zornesflammen, and An dem Tag der Zornesfülle*); also Herder, Fr. von Meyer, A. L. Follen, Wessenberg, Harms, Döring, Stier. One German, Lecke, wrote twelve versions. The best English translators of the hymn are Richard Crashaw (his version is the oldest, made 1646, remarkable for strength, but differing from the measure of the original, "Hear'dst thou, my soul, what serious things Both the Psalm and Sibyl sings"); the Earl of Roscommon ("The Day of wrath, that dreadful day"); Sir Walter Scott (only a part of it, but admirably done: "That day of wrath, that dreadful day"); Macaulay (1826, "On that great, that awful day"); archbishop Trench ("O that day, that day of ire"—a very close translation, though not in the double rhyme of the original); Dean Henry Alford (1845, "Day of anger, that dread day"); Mrs. Charles (in "The Voice of Christian Life in Song," 1864, "Lo, the day of wrath, the day"); Henry Mills ("Day of wrath—the sinner's doom"); Epes Sargent ("Day of ire, that day impending"); E. Caswall ("Nigher still, and still more nigh"); Is. Williams; Robert Davidson ("Day of wrath! that day is hastening"); W. G. Dix ("That day of wrath—upon that day"); Charles Rockwell ("That day of wrath! oh dreadful day"); J. H. Abrahall ("Day of wrath and tribulation," in the *Christian Remembrancer* for Jan. 1868, p. 159); W. J. Irons ("Day of wrath! O day of mourning," adopted in the "Hymnal Noted"); W. R. Williams ("Day of wrath! that day dismaying"); Edward Slosson ("Day of wrath! of days that day"); Erastus C. Benedict (two, "Day of wrath! that final day," and "Day of threatened wrath from heaven"); Gen. John A. Dix (1862, "Day of vengeance, without morrow"—an eclectic translation, the rhymes being selected from other versions, especially those of Coles and Irons). Among these translators, America is well represented by W. R. Williams, Slosson, Davidson, Rockwell, Mills, Sargent, W. G. and John A. Dix, Benedict. But the palm among translators belongs to an American layman, Abraham Coles, a physician at Newark, New Jersey, who pre-

pared no less than thirteen distinct versions, all good in their way, six of which are in the trochaic measure and double rhyme of the original; five like in rhythm, but in single rhyme; one in iambic triplets, like Roscommon's; the last in quatrains, like Crashaw's version. The first two appeared anonymously in the *Newark Daily Advertiser*, 1847, and a part of one found its way into Mrs. Stowe's "Uncle Tom's Cabin," the other into H. W. Beecher's "Plymouth Collection of Hymns and Tunes." They are all published together with an Introduction, and a photograph picture of Michael Angelo's famous Last Judgment. Of the many translations, we select in conclusion one which is less known than it deserves to be, from the pen of the Rev. Dr. W. R. Williams, a Baptist clergyman of New York, which appeared, with a valuable note on *Dies Iræ*, in his *Miscellanies*, 2d edit. N. Y. 1850, p. 88-90. The author kindly consents to its use here, with a few changes, and the modest remark: "Its imperfections are excusable only from its having preceded the more finished rendering of my friend, Dr. Abraham Coles, of Newark, N. J."

1. Day of wrath! that day dismaying;
As the seers of old were saying,
All the world in ashes laying.
2. What the fear! and what the quaking!
When the Judge his way is taking,
Strictest search in all things making.
3. When the trump, with blast astounding,
Through the tombs of earth resounding,
Bids all stand, the throne surrounding.
4. Death and Nature all agast are,
While the dead rise fast and faster,
Answering to their Judge and Master.
5. Forth is brought the record solemn;
See, o'erwrit in each dread column,
With man's deeds, the Doomsday volume.
6. Now the Sovereign Judge is seated;
All, long hid, is loud repeated;
Naught escapes the judgment meted.
7. Ah! what plea shall I be pleading?
Who for me be interceding,
When the just man help is needing?
8. Oh, thou King of awful splendor,
Of salvation free the Sender,
Grace to me, all gracious, render.
9. Jesus, Lord, my plea let this be,
Mine the woe that brought from bliss Thee;
On that day, Lord, wilt Thou miss me?
10. Wearily for me Thou soughtest;
On the crosses my soul Thou boughtest;
Loe not all for which Thou wroughtest!
11. Vengeance, Lord, then be Thy mission:
Now, of sin grant free remission:
Ere that day of inquisition.
12. Low in shame before Thee groaning;
Blushes deep my sin are owing;
Hear, O Lord, my suppliant moaning!
13. Her of old that sinned forgiving,
And the dying thief receiving,
Thou, to me too, hope art giving.
14. In my prayer though sin discerning,
Yet, good Lord, in goodness turning,
Save me from the endless burning!
15. 'Mid Thy sheep be my place given;
Far the goats from me be driven;
Lift, at Thy right hand, to heaven.
16. When the cursed are confounded,
With devouring flame surrounded,
With the best be my name sound.
17. Low, I beg, as suppliant bending;
With crushed heart, my life forth spending;
Lord, be nigh me in my ending!
18. Ah that day! that day of weeping!
When in dust no longer sleeping,
Man to God in guilt is going—
Lord, be then Thy mercy showing!

V. *Literature.*—G. C. F. Mohnike, *Kirchen- und literarhistorische Studien und Mittheilungen*, Bd. i, Heft. i (*Beiträge zur allen kirchlichen Hymnologie*, Stralsund, 1824, p. 1-100); G. W. Fink, *Thomas von Celano in Ersch und Gruber's Encyclop.* sec. i, Bd. xvi, p. 7-10; F. G. Lisco, *Dies Iræ, Hymnus auf das Weltgericht*, Berlin,

1840 (to this must be added an appendix to the same author's monograph on the *Stabat Mater*, Berlin, 1843, where he notices 17 additional translations of the *Dies Ira*); W. R. Williams, *Miscellanies* (N. Y., 1850, p. 78-90); H. A. Daniel, *Theatrum Hymnologicum* (Lips. 1855, ii, 103-181; v, 1856, 110-116); C. E. Koch, art. *Dies Ira* in Herzog's *Theol. Encyclop.* (1855), iii, 887, 888 (brief); Abraham Coles, *Dies Ira* in thirteen original versions, with Photographic Illustrations (N. Y. 4th ed. 1866). Compare also the anonymous publication, *The seven great Hymns of the Mediæval Church* (N. Y. 3d ed. 1867, p. 44-97), where seven English translations of the *Dies Ira* are given, viz. those of Gen. Dix, two of Coles, Roscommon, Crashaw, Irons, and Slosson.

Dies Luminum (*ἡμέρα φῶρος*, day of lights), an ancient name for the Epiphany; baptism being generally called *φῶς* and *φωτισμα*, light and illumination, this day, being the supposed day of our Saviour's baptism, was styled "the day of lights or illumination, or baptism." Asterius Amasenus (*Hom. iv. in Fest. Kal.* cited by Bingham) says, "We celebrate the nativity because at this time God manifested his divinity to us in the flesh. We celebrate the feast of light, because, by the remission of our sins in baptism, we are brought, as it were, out of the dark prison of our former life to a life of light and virtue."—Bingham, *Orig. Eccles.* bk. xx, ch. iv, § 7.

Diet (אֲרוּחָה, *aruchah*), rendered "allowance," 2 Kings xxv, 30; "victuals," Jer. xl, 5; "dinner" Prov. xv, 17), a fixed portion or ration of daily food (Jer. lii, 84). The food of Eastern nations has been in all ages light and simple. As compared with our own habits, the chief points of contrast are the small amount of animal food consumed, the variety of articles used as accompaniments to bread, the substitution of milk in various forms for our liquors, and the combination of what we should deem heterogeneous elements in the same dish or the same meal. The chief point of agreement is the large consumption of bread, the importance of which in the eyes of the Hebrew is testified by the use of the term *lechem* (originally food of any kind) specifically for bread, as well as by the expression "staff of bread" (Lev. xxvi, 26; Psa. cv, 16; Ezek. iv, 16; xiv, 13). Simpler preparations of corn were, however, common; sometimes the fresh green ears were eaten in a natural state (a custom practised in Palestine (Robinson's *Researches*, i, 498), the husks being rubbed off by the hand (Lev. xxiii, 14; Deut. xxiii, 25; 2 Kings iv, 42; Matt. xii, 1; Luke vi, 1); more frequently, however, the grains, after being carefully picked, were roasted in a pan over a fire (Lev. ii, 14), and eaten as "parched corn," in which form it was an ordinary article of diet, particularly among laborers, or others who had not the means of dressing food (Lev. xxiii, 14; Ruth ii, 14; 1 Sam. xvii, 17; xxv, 18; 2 Sam. xvii, 28); this practice is still very usual in the East (comp. Lane, i, 251; Robinson, *Res.* ii, 860). Sometimes the grain was bruised (like the Greek *polenta*, Pliny, xviii, 14), in which state it was termed either שֶׁרֶשׁ (Sept. *ipura*; A. V. "beaten," Lev. ii, 14, 16), or סֶרֶשׁ (Aquil. *Symm. πρισάνα*; Auth. Vers. "corn," 2 Sam. xvii, 19; comp. Prov. xxvii, 22), and then dried in the sun; it was eaten either mixed with oil (Lev. ii, 15), or made into a soft cake named עֵרֶשֶׁת (A. V. "dough," Num. xv, 20; Neh. x, 87; Ezek. xlv, 30). The Hebrews used a great variety of articles (John xxi, 6) to give a relish to bread. Sometimes salt was so used (Job vi, 6), as we learn from the passage just quoted; sometimes the bread was dipped into the sour wine (A. V. "vinegar") which the laborers drank (Ruth ii, 14); or, when meat was eaten, into the gravy, which was either served up separately for the purpose, as by Gideon (Judg. vi, 19), or placed in the middle of the meat-dish, as done by the Arabs (Burckhardt, *Notes*, i, 68), whose

practice of dipping bread in the broth, or *mebat* of the animal, strongly illustrates the reference to soup in John xiii, 26 sq. The modern Egyptians use their bread with a sauce composed of various ingredients, such as salt, mint, sesame, and chickpeas (Lev. i, 180). (The later Jews named this sauce *חֶמֶץ* [Mishna, *Pesach*, ii, 8]: it consisted of vinegar,monds, and spice, thickened with flour. It was used at the celebration of the Passover [*Pesach*, x, 3]). The Syrians, on the other hand, use a mixture of vinegar and salt for the same purpose (Russell, i, 93). When the above-mentioned accessories were wanting, fruit, vegetables, fish, or honey was used. In short, it may be said that all the articles of food which we are about to mention were mainly viewed as subordinate to the staple commodity of bread. The various kinds of bread and cakes are described under the head of BREAD; CAKE; CRACKNEL.

Milk and its preparations hold a conspicuous place in Eastern diet as affording substantial nourishment; sometimes it was produced in a fresh state (מֶלֶךְ, Gen. xviii, 8), but more generally in the form of the modern *leban*, i. e. sour milk (מֶלֶךְ, A. V. "butter," Gen. xviii, 8; Judg. v, 25; 2 Sam. xvii, 29). The latter is universally used by the Bedouins, not only as the ordinary beverage (Burckhardt, *Notes*, i, 240), but mixed with flour, meat, and even salad (Burckhardt, i, 63; Russell, *Aleppo*, i, 118). It is constantly offered to travellers, and in some parts of Arabia it is deemed scandalous to take any money in return for it (Burckhardt, *Arabia*, i, 120). For a certain season of the year *leban* makes up a great part of the food of the poor in Syria (Russell, *l. c.*). Butter (Prov. xxx, 25) and various forms of coagulated milk, of the consistency of the modern *kaimak* (Job x, 10; 1 Sam. xv, 18; 2 Sam. xvii, 29), were also used. See BUTTER; CHEESE; MILK.

Fruit (q. v.) was another source of subsistence; it stand first in point of importance; the early sorts described as the "summer fruit" (פֵּרוֹת, Amos viii, 1, 2) and the "first ripe fruit" (פֵּרוֹת בְּבִימָה, Hos. ix, 10; Mic. vi, 1), were esteemed a great luxury, and were eaten as fresh fruit; but they were generally dried and pressed into cakes, similar to the date-cakes of the Arabs (Burckhardt, *Arabia*, i, 57), in which form they were termed פֵּרוֹת מְדֻבָּבִים (*palathau*, A. V. "cakes of figs," 1 Sam. xxv, 18; xxx, 12; 1 Chron. xii, 40), and occasionally פֵּרוֹת simply (2 Sam. xvi, 1; A. V. "summer fruit"). Grapes were generally eaten in a dried state as raisins (פֵּרוֹת מְדֻבָּבִים, Vulg. *ligatura uva passæ*, 1 Sam. xvi, 1; xxx, 12; 2 Sam. xvi, 1; 1 Chron. xii, 40), but sometimes, as before, pressed into cakes, named פֵּרוֹת מְדֻבָּבִים (2 Sam. vi, 19; 1 Chron. xvi, 8; Cant. ii, 5; Hos. iii, 1), understood by the Sept. as a sort of cake, *λάγανον ἀπὸ ἤγανου*, and by the A. V. as a "flagon of wine." Caked fruit forms a part of the daily food of the Arabians, and is particularly adapted to the wants of travellers; dissolved in water it affords a sweet and refreshing drink (Niebuhr, *Arabia*, p. 57; Russell, *Aleppo*, i, 82); an instance of its stimulating effect is recorded in 1 Sam. xxx, 12. Apples (perhaps citrus) are occasionally noticed, but rather in reference to their fragrance (Cant. ii, 5; vii, 8) and color (Prov. xxv, 11) than as an article of food. Dates are not noticed in Scripture, unless we accept the rendering of פֵּרוֹת in the Sept. (2 Sam. 1) as = *φεινυες*; it can hardly be doubted, however, that, where the palm-tree flourished, as in the neighborhood of Jericho, its fruit was consumed; in Joel i, 12 it is reckoned among other trees valuable for their fruit. The pomegranate-tree is also noticed by Joel; it yields a luscious fruit, from which a species of wine was expressed (Cant. vii, 2; Hag. ii, 19). Melons were grown in Egypt (Num. xi, 5), but not in Palestine. The mulberry is

doubtedly mentioned in Luke xvii, 6 under the name *ἀμύγος*; the Hebrew מִן־בְּרִיָּה so translated (2 Sam. 23; 1 Chron. xiv, 14) is rather doubtful; the Vulg. uses it to mean *pears*. The *συκομαρία* (A. V. "sycore,") Luke xix, 4) differs from the tree last mentioned; it was the Egyptian fig, which abounded in Palestine (1 Kings x, 27), and was much valued for fruit (1 Chron. xxvii, 28; Amos vii, 14). See **APPE; CITRUS; FIG; MULBERRY-TREE; POMEGRANATE; SYCAMINE-TREE; SYCAMORE.**

Of vegetables (q. v.) we have most frequent notice of till (Gen. xxv, 84; 2 Sam. xvii, 28; xxiii, 11; Ezek. ii, 9), which are still largely used by the Bedouins in travelling (Burckhardt, *Arabia*, i, 65); beans (2 Sam. ii, 28; Ezek. iv, 9), which still form a favorite dish in Egypt and Arabia for breakfast, boiled in water and ten with butter and pepper; from 2 Sam. xvii, 28 it might be inferred that beans and other kinds of pulse are roasted, as barley was, but the second בִּרְבִּי in at verse is probably interpolated, not appearing in the Sept., and, even if it were not so, the reference to *ulse* in the A. V., as of *cicer* in the Vulg., is wholly unwarranted; cucumbers (Num. xi, 5; Isa. i, 8; Bar. i, 70; comp. 2 Kings iv, 39, where wild gourds, *cucurces arinsis*, were picked in mistake for cucumbers); eke, onions, and garlic, which were and still are of superior quality in Egypt (Num. xi, 5; comp. Wilkinson, *Anc. Egypt*, ii, 374; Lane, i, 251); lettuce, of which the wild species, *lactuca agrestis*, is identified with the Greek *σπυγίς* by Pliny (xxi, 65), and formed, according to the Sept. and the Vulg., the "bitter herbs" (מִרְרִיבִים) eaten with the paschal lamb (Exod. ii, 8; Num. ix, 11); endive, which is still well known in the East (Russell, i, 91), may have been included under the same class. In addition to the above we have notice of certain "herbs" (אֲרִיזִי, 2 Kings iv, 9) eaten in times of scarcity, which were mallows according to the Syriac and Arabic versions, but, according to the Talmud, a vegetable resembling the *brassica ruca* of Linnæus; and again of sea-purslane (מִלְחִי; *Dima*; A. V. "mallows"), and broom-root (רִיבִי, *ῥίβιον*; A. V. "juniper," Job xxx, iv), as eaten by the poor in time of famine, unless the latter were gathered as fuel. An insipid plant, probably purslane, used in salad, appears to be referred to in Job vi, 6, under the expression רִיבִי חֹמֶתֶתֶת (A. V. "white of egg"). The usual method of eating vegetables was in the form of pottage (רִיבִי), Sept. ἐψήμα, Vulg. *pulmentum*, Gen. xxv, 29; 2 Kings iv, 38; Hag. ii, 12; a meal wholly of vegetables was deemed very poor fare, Prov. xv, 17; Dan. i, 12; Rom. xiv, 2). The modern Arabians consume but few vegetables; radishes and leeks are most in use, and are eaten raw with bread (Burckhardt, *Arabia*, i, 56). See **BEAN; CUCUMBER; GARLIC; GOUBD; LEEK; LENTIL; ONION.**

The spices or condiments known to the Hebrews were numerous; cummin (Isa. xlviii, 25; Matt. xxiii, 23), dill (Matt. xxiii, 23, "anise," A. V.), coriander (Exod. xvi, 31; Num. xi, 7), mint (Matt. xxiii, 23), rue (Luke xi, 42), mustard (Matt. xiii, 31; xvii, 20), and salt (Job vi, 6), which is reckoned among "the principal things for the whole use of man's life" (Ecclus. xxxix, 26). Nuts (pistachios) and almonds (Gen. xliii, 11) were also used as *whets* to the appetite. See **ALMOND; ANISE; CORIANDER; CUMMIN; MINT; MUSTARD; NUTS; SPICES.**

In addition to these classes, we have to notice some other important articles of food: in the first place, honey, whether the natural product of the bee (1 Sam. xiv, 25; Matt. iii, 4), which abounds in most parts of Arabia (Burckhardt, *Arabia*, i, 54), or the other natural and artificial productions included under that head, especially the *dibs* of the Syrians and Arabians, i. e. grape-juice boiled down to the state of the Roman *de-*

frutum, which is still extensively used in the East (Russell, i, 82); the latter is supposed to be referred to in Gen. xliii, 11, and Ezek. xxvii, 17. The importance of honey, as a substitute for sugar, is obvious; it was both used in certain kinds of cake (though prohibited in the case of meat offerings, Lev. ii, 11), as in the pastry of the Arabs (Burckhardt, *Arabia*, i, 54), and was also eaten in its natural state either by itself (1 Sam. xiv, 27; 2 Sam. xvii, 29; 1 Kings xiv, 8), or in conjunction with other things, even with fish (Luke xxiv, 42). "Butter and honey" is an expression for rich diet (Isa. vii, 15, 22); such a mixture is popular among the Arabs (Burckhardt, *Arabia*, i, 54). "Milk and honey" are similarly coupled together, not only frequently by the sacred writers, as expressive of the richness of the promised land, but also by the Greek poets (comp. Callim. *Hymn in Jov.* 48; Hom. *Od.* xx, 68). Too much honey was deemed unwholesome (Prov. xxv, 27). With regard to oil, it does not appear to have been used to the extent we might have anticipated; the modern Arabs only employ it in frying fish (Burckhardt, *Arabia*, i, 54), but for all other purposes butter is substituted: among the Hebrews it was deemed an expensive luxury (Prov. xxi, 17), to be reserved for festive occasions (1 Chron. xii, 40); it was chiefly used in certain kinds of cake (Lev. ii, 5 sq.; 1 Kings xvii, 12). "Oil and honey" are mentioned in conjunction with bread in Ezek. xvi, 18, 19. The Syrians, especially the Jews, eat oil and honey (*dibs*) mixed together (Russell, i, 80). Eggs are not often noticed, but were evidently known as articles of food (Isa. x, 14; lix, 5; Luke xi, 12), and are reckoned by Jerome (*In Epistolam Pauli*, i, 176) among the delicacies of the table. See **HONEY; OIL.**

The Orientals have been at all times sparing in the use of animal food; not only does the excessive heat of the climate render it both unwholesome to eat much meat (Niebuhr, *Descript.* p. 46), and expensive from the necessity of immediately consuming a whole animal, but beyond this the ritual regulations of the Mosaic law in ancient, as of the Koran in modern times, have tended to the same result. It has been inferred from Gen. ix, 3, 4, that animal food was not permitted before the Flood; but the notices of the flock of Abel (Gen. iv, 2), and of the herds of Jabel (Gen. iv, 20), as well as the distinction between clean and unclean animals (Gen. vii, 2), favor the opposite opinion; and the permission in Gen. ix, 3 may be held to be only a more explicit declaration of a condition implied in the grant of universal dominion previously given (Gen. i, 28). The prohibition then expressed against consuming the blood of any animal (Gen. ix, 4) was more fully developed in the Levitical law, and enforced by the penalty of death (Lev. iii, 17; vii, 26; xix, 26; Deut. xii, 16; 1 Sam. xiv, 82 sq.; Ezek. xlv, 7, 15), on the ground, as stated in Lev. xvii, 11, and Deut. xii, 23, that the blood contained the principle of life, and, as such, was to be offered on the altar; probably there was an additional reason in the heathen practice of consuming blood in their sacrifices (Psa. xvi, 4; Ezek. xxxiii, 25). The prohibition applied to strangers as well as Israelites, and to every kind of beast or fowl (Lev. vii, 26; xvii, 12, 18). So strong was the feeling of the Jews on this point, that the Gentile converts to Christianity were laid under similar restrictions (Acts xv, 20, 29; xxi, 25). As a necessary deduction from the above principle, all animals which had died a natural death (מֵתָ, Deut. xiv, 21), or had been torn by beasts (מִבְּהֵמָה, Exod. xxii, 81), were also prohibited (Lev. xvii, 15; comp. Ezek. iv, 14), and to be thrown to the dogs (Exod. xxii, 81): this prohibition did not extend to strangers (Deut. xiv, 21). Any person infringing this rule was held unclean until the evening, and was obliged to wash his clothes (Lev. xvii, 16). In the N. T. these cases are described under the term *πυκνόν* (Acts xv, 20), applying not only to what was

strangled (as in A. V.), but to any animal from which the blood was not regularly poured forth. Similar prohibitions are contained in the Koran (ii, 175; v, 4; xvi, 116), the result of which is that at the present day the Arabians eat no meat except what has been bought at the shambles. Certain portions of the fat of sacrifices were also forbidden (Lev. iii, 9, 10), as being set apart for the altar (Lev. iii, 16; vii, 25; comp. 1 Sam. ii, 16 sq.; 2 Chron. vii, 7): it should be observed that the term in Neh. viii, 10, translated *fat*, is not **בֶּשֶׁלֶת**, but **בֶּשֶׁלֶת־בָּשָׂר**=the fatty pieces of meat, delicacies. In addition to the above, Christians were forbidden to eat the flesh of animals, portions of which had been offered to idols (*εἰδωλόθυρα*), whether at private feasts or as bought in the market (Acts xv, 29; xxi, 25; 1 Cor. viii, 1 sq.). All beasts and birds classed as unclean (Lev. xi, 1 sq.; Deut. xiv, 4 sq.) were also prohibited (see ANIMAL; BIRD); and in addition to these general precepts there was a special prohibition against "sucking a kid in his mother's milk" (Exod. xxiii, 19; xxxiv, 26; Deut. xiv, 21), which has been variously understood, by Talmudical writers, as a general prohibition against the joint use of meat and milk (Mishna, *Cholin*, cap. 8, § 1); by Michaelis (*Mos. Recht*, iv, 210) as prohibiting the use of fat or milk, in comparison with oil, in cooking; by Luther and Calvin as prohibiting the slaughter of young animals; and by Bochart and others as discouraging cruelty in any way. These interpretations, however, all fail in establishing any connection between the precept and the offering of the first-fruits, as implied in the three passages quoted. More probably it has reference to certain heathen usages at their harvest festivals (Maimonides, *Mora Nebok*, iii, 48; Spencer, *De Legg. Hebr. Rit.* p. 585 sq.): there is a remarkable addition in the Samaritan version, and in some copies of the Sept. in Deut. xiv, 21, which supports this view; **ὅτι γὰρ ποιεῖ τοῦτο, ὡς αἰ ἀσπάλα θύσει, ὅτι μίσημα ἴσθι τῆ θεῷ Ἰακώβ** (comp. Knobel, *Comment.* in Exod. xxiii, 19). The Hebrews further abstained from eating the sinew of the hip (**כֶּבֶד הַיָּד**, Gen. xxxii, 32), in memory of the struggle between Jacob and the angel (comp. ver. 25). The Sept., the Vulg., and the A. V. interpret the *ἡπαξ λεγόμενον* word *nashel* of the shrinking or becoming of the muscle (**ὁ ἐνάρκσηεν; qui emarcuit; "which shrank"**): Josephus (*Ant.* i, 20, 2) more correctly explains it as "the broad nerve" (**τὸ νεῦρον τὸ πλατὺ**); and there is little doubt that the nerve he refers to is the *nervus ischiadicus*, which attains its greatest thickness at the hip. There is no further reference to this custom in the Bible; but the Talmudists (*Cholin*, vii) enforced its observance by penalties. See MEAT.

Under these restrictions the Hebrews were permitted the free use of animal food: generally speaking, they only availed themselves of it in the exercise of hospitality (Gen. xviii, 7), or at festivals of a religious (Exod. xii, 8), public (1 Kings i, 9; 1 Chron. xii, 40), or private character (Gen. xxvii, 4; Luke xv, 28); it was only in royal households that there was a daily consumption of meat (1 Kings iv, 23; Neh. v, 18). The use of meat is reserved for similar occasions among the Bedouins (Burckhardt's *Notes*, i, 63). The animals killed for meat were—calves (Gen. xviii, 7; 1 Sam. xviii, 24; Amos vi, 4), which are farther described by the term *fattling* (**מִשְׁחָה**=*μόσχος σιευτός*, Luke xv, 23, and *σιτιστόν*, Matt. xxii, 4; 2 Sam. vi, 13; 1 Kings i, 9 sq.; A. V. "fat cattle"); lambs (2 Sam. xii, 4; Amos vi, 4); oxen, not above three years of age (1 Kings i, 9; Prov. xv, 17; Isa. xxii, 13; Matt. xxii, 4), which were either stall-fed (**מִשְׁחָה**); Sept. *μῶσχοι ἐκλεκτοί*), or taken up from the pastures (**מִשְׁחָה**); Sept. *βοῖς νομάδες*; 1 Kings iv, 28); kids (Gen. xxvii, 9; Judg. vi, 19; 1 Sam. xvi, 20); harts, roebucks, and fallow-deer (1 Kings iv, 23), which are also brought

into close connection with ordinary cattle in Deut. xiv, 5, as though holding an intermediate place between tame and wild animals; birds of various kinds (**עֻרְבֵי**; Auth. Ver. "fowls;" Neh. v, 18, and the Sept. however, gives *χίμαρος*, as though the reading were **עֻרְבֵי**); quail in certain parts of Arabia (Exod. xvi, 13; Num. xi, 32); poultry (**טְרִיפֵי**; 1 Kings i, 9); understood generally by the Sept. *ὀρνίθων ἰσλα σιευτός*; by Kimchi and the A. V. as "fatted fowls;" by Gesenius, *Theasaur.* p. 246, as geese, from the softness of their plumage; by Thenius, *Cosmos*, in loc. Guinea-fowls, as though the word represented that of that bird); partridges (1 Sam. xxvi, 20); fish, with the exception of such as were without scales and fins (Lev. xi, 9; Deut. xiv, 9), both salted, as was probably the case with the sea-fish brought to Jerusalem (Lev. xiii, 16), and fresh (Matt. xiv, 19; xv, 36; Luke xiv, 42): in our Saviour's time it appears to have been usual food about the Sea of Galilee (Matt. vii, 16); the term *ὀψάριον* is applied to it by John (vi, 9; x, 11 sq.) in the restricted sense which the word obtained among the later Greeks, as = *fish*. Locusts, of certain species only were esteemed clean (Lev. xi, 42), and were occasionally eaten (Matt. iii, 4), but considered a poor fare. They are at the present day largely consumed by the poor both in Persia (Morier's *Seven Years Journey*, p. 44) and in Arabia (Niebuhr, *Voyage*, i, 33); they are salted and dried, and roasted, when required on a frying-pan with butter (Burckhardt's *Notes*, i, 92; Niebuhr, *L. c.*). See LOCUST.

Meat does not appear ever to have been eaten itself; various accompaniments are noticed in Scripture, as bread, milk, and sour milk (Gen. xviii, 32); bread and broth (Judg. vi, 19); and with fish either bread (Matt. xiv, 19; xv, 36; John xxi, 9) or honey-comb (Luke xxiv, 42): the instance in 2 Sam. vi, 19 cannot be relied on, as the term **מִשְׁחָה**, rendered in the A. V. *a good piece of flesh*, after the Vulg., *essentia bibula carnis*, means simply a portion or measure, as may apply to wine as well as meat. For the mode of preparing meat, see COOKING; and for the time and manner of eating, MEALS; see also FISH, FOWL, &c.

To pass from ordinary to occasional sources of subsistence: prison diet consisted of bread and water administered in small quantities (1 Kings xxii, 27; Jer. xxxvii, 21); pulse and water was considered but little better (Dan. i, 12): in time of sorrow or fasting it was usual to abstain either altogether from food (1 Sam. xii, 17, 20), or from meat, wine, and even delicacies, which were described as **לֶחֶם דְּמִשְׁחָה**, literally *bread of desires* (Dan. x, 8). In time of extreme famine the most loathsome food was swallowed, such as an ass's head (2 Kings vi, 25), the ass, it must be remembered, being an unclean animal (for a parallel case, comp. Plutarch, *Artaxerz.* 24), and dove's dung (see the article on that subject), the dung of cattle (Josephus, *War*, v, 18, 7), and even possibly their dung (2 Kings xviii, 27). The consumption of human flesh was not altogether unknown (2 Kings vi, 29; comp. Josephus, *War*, vi, 3, 4), the passages quoted supplying instances of the exact fulfilment of the prediction in Deut. xxviii, 56, 57; comp. also Lam. ii, 20, iv, 10; Ezek. vi, 10. See FOOD.

With regard to the beverages used by the Hebrews we have already mentioned milk, and the probable use of barley-water, and of a mixture, resembling the modern *sherbet*, formed of fig-cake and water. The Hebrews probably resembled the Arabs in not drinking much during their meals, but concluding them with a long draught of water. It is almost needless to say that water was most generally drunk. In addition to these, the Hebrews were acquainted with various intoxicating liquors, the most valued of which was the juice of the grape, while others were described as

the general term of *shekar*, or *strong drink* (Lev. ; Num. vi, 8; Judg. xiii, 4, 7), if, indeed, the latter does not sometimes include the former (Num. iii, 7). These were reserved for the wealthy, or festive occasions; the poor consumed a sour wine V. "vinegar;" Ruth ii, 14; Matt. xxvii, 48), called to quench thirst, but not agreeable to the taste (v. x, 26).—Smith, s. v. Food. See BEVERAGE.

Diet (*dies*, day; German *Reichstag*), the assembly he states of Germany. The Diet shared with the emperor the rights of sovereignty, except in a few reserved to the emperor. It consisted of three orders — electors, princes, and free cities. To be a resolution had to be adopted by all the three orders, and to be sanctioned by the emperor. In a particular college a majority of votes was in most cases sufficient, but religious questions formed an exception. See CORPUS CATHOLICORUM and CORPUS ANGELICORUM. The elector of Mainz, as arch-bishop of the empire, was director of the Diet. The following list (taken from Buck, *Theological Dictionary*, and from Farrar, *Ecclesiastical Dictionary*) includes the chief Diets held in reference to the affairs of the Reformation.

1. *The Diet of Worms*, in 1521, in which Alexander, pope's nuncio, having charged Luther with heresy, the duke of Saxony said that Luther ought to be heard. The emperor granted, and sent him a pass, provided he would not preach on the journey. On Luther's rival at Worms, he protested that he would not repent unless they would show him his errors from the word of God alone. He was consequently ordered to depart from Worms, and, by an edict of the 26th of May, he was outlawed.

2. *The First Diet of Nuremberg*, in 1523, when Francis Chieregati, Adrian the Sixth's nuncio, demanded the execution of Leo the Tenth's bull, and of Charles the Fifth's edict, published at Worms, against Luther. He was answered that it was necessary to call a council in Germany to satisfy the nation respecting its grievances, which were reduced to one hundred articles, some of which struck at the pope's authority and the discipline of the Roman Church: they added that in the interim the Lutherans should be commanded not to write against the Romanists. All these things were brought into the form of an edict, and published in the emperor's name.

3. *The Second Diet of Nuremberg*, in 1524. Cardinal Ampeggio, pope Clement the Seventh's nuncio, entered the town incognito for fear of exasperating the people. The Lutherans having the advantage, it was decreed that, with the emperor's consent, the pope should call a council in Germany; but, in the interim, no assembly should be held at Spire, to determine that was to be believed and practised; and that, to obey the emperor, the princes ought to order the observance of the edict of Worms as strictly as they could. Charles V., being angry at this, commanded the edict of Worms to be observed very strictly, and prohibited the assembly at Spire.

4. *The First Diet of Spire*, held in 1526. Charles V., being in Spain, named his brother, archduke Ferdinand, to preside over that assembly, where the duke of Saxony and the landgrave of Hesse demanded, at first, a free exercise of the Lutheran religion, so that the Lutherans preached there publicly against Popery; and the servants of the Lutheran princes had these five letters, V. D. M. I. Æ., embroidered on their sleeves (*Verbum Dei manet in Æternum*), to show publicly that they would follow nothing but the pure Word of God. The archduke, not daring to oppose these courses, proposed two things: the first, concerning the Popish religion, which was to be observed in maintaining the edict of Worms; and the second concerning the help demanded by Louis, king of Hungary, against the Turks. The Lutherans prevailing about the first, it was decreed that the emperor should be desired to call

a general council in Germany within a year; and that, in the mean time, every one was to have liberty of conscience. Whilst they were deliberating in vain about the second, king Louis was defeated and killed in the battle of Mohacz.

5. *The Second Diet of Spire* was held in 1529. It was decreed against the Lutherans that wherever the edict of Worms was received, it should not be lawful for any one to change his opinions; but in the countries where the new religion (as they termed it) was received, it should be lawful to continue in it till the next council, if the old religion could not be re-established there without sedition. Nevertheless, the mass was not to be abolished there, and no Romanist was allowed to turn Lutheran; the Sacramentarians were to be banished out of the empire, and the Anabaptists put to death; and preachers should nowhere preach against the Church of Rome. Six Lutheran princes, namely, the elector of Saxony, the marquis of Brandenburg-Bayreuth, the two dukes of Luneburg, the landgrave of Hesse, and the prince of Anhalt, with the deputies of fourteen imperial towns, protested, in writing, two days after, in the assembly, against this decree, which they would not obey, it being contrary to the Gospel; and appealed to a general or national council, to the emperor, and to any other unprejudiced judge. From this solemn protestation came the famous name of Protestants, which the Lutherans soon adopted; and, subsequently, the Calvinists, and other Reformed churches. They also protested against contributing anything towards the war against the Turks till after the exercise of their religion was free in all Germany. The next year the emperor held the Diet of Augsburg.

6. *The First Diet of Augsburg* was called in the year 1530, by Charles V., to reunite the princes about some matters of religion, and to join them all together against the Turks. The elector of Saxony, followed by many princes, presented the confession of faith called the Confession of Augsburg. The conference about matters of faith and discipline being concluded, the emperor ended the diet by a decree that nothing should be altered in the doctrines and ceremonies of the Church of Rome till a council should order it otherwise.

7. *The First Diet of Ratisbon*, in 1541, for uniting the Protestants to the Church of Rome. The pope's legate having altered the twenty-two articles drawn up by the Protestant divines, the emperor proposed to choose some learned divines who might agree peaceably on the articles, and, being desired by the diet to choose them himself, he named three Papists, namely, Julius Pflugius, John Gropperus, and John Eckius, and three Protestants, namely, Philip Melancthon, Martin Bucer, and John Pistorius. After an examination and disputation of a month, those divines could not agree on more than five or six articles, wherein the diet still found some difficulties. The emperor, to terminate these controversies, ordered, by an edict, that the decision of these articles should be referred to a general council, or to the national council of all Germany, or to the next diet, eighteen months after; and that, in the mean time, the Protestants should keep the articles agreed on, forbidding them to solicit anybody to change the old religion, as they called it. But, to gratify the Protestants, he gave them leave, by patent, to retain their religion, notwithstanding the edict.

8. *The Second Diet of Ratisbon* was held in 1546: none of the Protestant confederate princes appeared. It was therefore soon decreed by a plurality of votes that the Council of Trent should be followed. The Protestant deputies opposed, and this caused a war against them.

9. *The Second Diet of Augsburg* was held in 1547, respecting matters of religion. The electors being divided concerning the decisions of the Council of Trent,

the emperor demanded that the management of this affair should be left to him, and it was directed that every one should conform to the decision of that council.

10. *The Third Diet of Augsburg* was held in 1548, when the commissioners appointed to examine some memoirs about a confession of faith not agreeing together, the emperor named three divines, who drew up the plan of the famous *Interim*. See *INTERIM*.

11. *The Fourth Diet of Augsburg* was held in 1550. The emperor complained that the *Interim* was not observed, and demanded that all should submit to the council, which they were going to renew at Trent: but the deputies of duke Maurice of Saxony protested that their master had agreed to submit to the council on condition that the divines of the Confession of Augsburg not only should be heard there, but should vote also, like the Romish bishops, and that the pope should not preside; but, by plurality of votes, submission to the council was agreed upon.

12. *The Fifth Diet of Augsburg* was held in 1555. At this diet the "Religious Peace of Augsburg" was concluded, which regulated the civil relations of the Evangelicals (by which term only the Lutherans were understood). According to this agreement, no state of the German empire was to be disturbed on account of its religion and ecclesiastical usages; religious controversies were to be compromised by Christian, amicable, and peaceable means; the Episcopal jurisdiction was suspended with regard to the faith and religious worship of Evangelicals; free emigration on account of religion was guaranteed. This agreement was to continue even if a religious reunion should not be effected.

13. *The Third Diet of Ratisbon* was held in 1557. The assembly demanded a conference between some famous doctors of both parties: this conference, held at Worms between twelve Papists and an equal number of Lutherans, was soon dissolved.

Dieterich, JOHN CONRAD, a learned Lutheran theologian, was born at Butzbach, Germany, Jan. 19, 1612. He became professor of Greek and history at Giessen, where he died, June 24, 1669. Among his numerous writings are, *De Peregrinatione studiorum*:—*Breviarium Hæreticorum et Conciliorum*:—*Breviarium Pontificum Romanorum* (Giessen, 1668, 8vo):—*Antiquitates Biblicæ* (Giessen, 1671, fol.):—*Antiquitates Novi Testamenti*; *sive Lexicon Philologico-Theologicum Græco-Latinum in N. T.* (Frankf. 1680, fol.).—Hoefer, *Nouv. Biog. Générale*, xiv, 146.

Dieterich of NIEM, or NEHEM, so called from his native place in Westphalia, studied theology, and became prebendary of Bonn in 1361. In 1371 he went to Avignon, where pope Gregory XI made him his secretary (*Scriptor Apostolicus*); and when that pope removed his see to Rome, Dieterich accompanied him, and obtained office as papal prothonotary and abbreviator. In 1395 (or 1396) Boniface IX offered him the bishopric of Werden, but he was not able to get possession of the see, which was held by a nominee of the anti-pope. In 1414 he attended the Council of Constance, and died about 1417. He wrote *De necessitate reformationis ecclesiasticæ in capite et membris* (Hardt, *Historia concilii Constant.* tom. i):—*De schismate libri III* (1408) (Nuremberg, 1482, folio), and republished afterwards with the addition of the four books of *Nemus unionis*, of which the *Labyrinthus* forms a part (Basel, 1506, 1566; Nuremb. 1592; Strasburg, 1608 and 1619). The latter editions bear the title *Theodorici a Niem historiarum sui temporis libri IV*. The *Nemus* was put in the *Index*. See Fabricius, *Bib. Lat. Med. et Inf. Lat.* vol. v.; Pierer, *Universal-Lexikon*, s. v.; Herzog, *Real-Encyclopædie*, iii, 388.

Dieterich, or **Dieterich**, VEIT (*Vitus Theodorus*, or *Theodoricus*), was born in 1506 at Nuremberg. He studied at Wittenberg, where he attracted the atten-

tion of Luther, and became his amanuensis and companion. Luther took him to the conferences of his burg (1529), Coburg, and the Imperial Diet of Augsburg (1580). He afterwards became assistant professor in the theological faculty at Wittenberg, and in 1585 returned to Nuremberg, where he became preacher at St. Sebaldus's church, which position he retained notwithstanding the offer of professorships in the universities of Wittenberg and Leipzig, until his death March 24, 1549. From 1584 to 1549 he was in correspondence with Luther, Melancthon, and the other leaders of Protestantism. He was more radically Lutheran than Melancthon. Dieterich had also several fiery discussions with Oslander on the subject of justification. During the latter part of his life he was sorely afflicted by the state of the Church, being suspended for a while in 1547 on account of his independence of expression. Besides editing and publishing translations of a number of the works of Luther and Melancthon, he wrote a number of sermons. An *Enarratio Lutheri in prophetam Micham*; *Apocryphicula für d. Pfarrherrn auff dem Land* (1543-1547 last ed. 1755). In 1548, while ill, he wrote a systematic exposition of the book of the prophet Isaiah, contemplated doing the same for the other prophets, but was prevented by death. The *Epistola theologicum Norimbergensium ad D. Rupertum* (1489), generally ascribed to him, was written by Oslander. Dieterich also composed several hymns. See, in the *Corpus Reformatorum*, the correspondence between Melancthon, Cruciger, and Dieterich (1537-1549); Strobel, *Norricht v. d. Leben u. d. Schriften V. Dieterichs* (Nürnberg, 1772); Herzog, *Real-Encyclopædie*, iii, 389.

Dieu, de, LOUIS (D. LODEWYK), was born at Vliessingen, April 7, 1590, where his father, Daniel de Dieu, labored in the ministry 24 years, having previously spent 22 years as minister of the Reformed Church at Brussels. Louis was at an early age devoted to the service of the Church, and placed under the care of his uncle, Daniel Colonius, regent of the Walloon College at Leyden, a competent and zealous instructor in theology. Here he made great proficiency in his theological studies. Whilst yet a candidate he was sent in Zealand by prince Maurice, who offered him the position of court-preacher, which he declined. In 1617 he became preacher to the Walloon church in Middelburg, and in 1617 he was called to the Reformed church in Vliessingen, where he preached not only in Dutch but also in French and English. In 1619 he was called to be pastor of the Reformed church in Leyden. Whilst here he declined the professorship of theology offered him in the newly-founded University of Utrecht. Had his life been spared, the same position in the University of Leyden would have been tendered him. He died December 22, 1642. De Dieu was a man of eminent gifts and attainments, and enjoyed the esteem of many of his most excellent contemporaries. His attention was specially devoted to the Oriental languages. The fruits of his study in that direction were: *Compendium Grammaticæ Hebræicæ* (Leyden, 1626, 4to); *Grammatica Trilinguis, Hebræica, Syriaca, et Chaldaica* (Leyden, 1628, 4to); *Rudiments Linguae Persicæ* (Leyden, 1639, 4to). These were all written in Latin. His Oriental studies were not subservient to the elucidation of the Holy Scriptures. In 1627 he published at Leyden his *Apocalypsis S. Johannis Syriacæ ex MS. exempl. Biblioth. Jos. Scaligeri edita, Characterè Syriaco et Hebræo, cum versione Latina Græco textu et notis*; and in 1631 his *Animadversiones sive Comment. in quatuor Evangelia, in quo collatis Syriacis, Arabis, Evangelicis Hebræis, Vulgatis, D. Erasmi et Bezae versionibus, diffinita loca illustrantur et variae lectiones conferuntur*. In this work he discussed with great impartiality and accuracy the value of these different translations. Critical and exegetical works on the Acts of the Apostles, on the Epistle to the Romans etc. succeeded. In these the various translations

also compared. All his exegetical and critical works were finally edited by professor Leydecker, and issued in folio in 1693, entitled *Critica Sacra sive adversiones in loca quaedam difficiliora V. et N. Test.* See Bayle, *Dictionary*, s. v.; Simon, *Hist. que*, N. T., chap. 58.

Digamists, a term anciently used to designate persons twice married after baptism though legally successively to two wives, one after the death of the other. The Montanists condemned all second marriages as unlawful; but, although this opinion did prevail generally, it was the common practice to see ordination to men who had been twice married. Tertullian (*de Monogam.* chap. xi) condemned second marriages even in laymen; and Ambrose, Jerome, Chrysostom, and others assumed that the injunction of the apostle 1 Tim. iii, 2, in which he directs that a bishop must be the husband of one wife, forbade an ecclesiastic to marry twice. Chrysostom, Theodoret, and others gave a contrary opinion, and interpreted the apostle's language of polygamists, or such as were tried to many wives at the same time, and such as causelessly put away their wives, and married others after divorcing the former. Numerous instances have been adduced to prove that second marriages were an impediment to ordination, e. g. Tertullian (*de Monogam.* xii) admits that there were bishops who had been twice married.—Bingham, *Orig. Eccles.* bk. iv, ch. 1-4.

Digby, SIR KENELM, was born in 1608, three years before his father, Sir Everard Digby, was executed for his share in the Gunpowder Plot. He was brought up in the Protestant faith, and in 1618 was created at Gloucester Hall, Oxford, where he gained a wonderful name for ability and scholarship. After leaving the university he spent two years in travel, returning to England in 1623, was knighted. In 1625, on the death of Dr. Allen, of Gloucester Hall, Sir Kenelm Digby inherited his collection of books and manuscripts. In 1636, when in France, he was reverted to the Roman Catholic faith, which step he justified in *A Conference with a Lady about the Choice of a Religion* (Par. 1638; Lond. 1654). He returned to England in 1638, and on the breaking out of the civil War was imprisoned as a Royalist in Winchester House, but in 1643 he was allowed to retire to France. At Paris he was received with favor by the court, and made the acquaintance of Des Cartes. After Charles I had fallen, Digby returned to England, but the Parliament forbade him the kingdom under penalty of death. Retiring to the Continent, he traveled in France and Italy; but in 1655 he was again in England, and was in frequent attendance at the court of the Protector. He went again to France, and occupied himself with the preparation of philosophical papers. He returned to England in 1661, and died there in 1665. His works are numerous, and on a great variety of subjects; we only notice, besides the one already mentioned, *A Treatise on the Soul, proving its immortality* (Par. 1644); *Mores Catholici, or Ages of the world* (anon.), reprinted in 3 vols. 8vo, Lond. 1844-47; *le Private Memoirs of Sir K. Digby, etc., written by himself*, were published in London in 1827 (8vo). See Lippis, *Biographica Britannica*, v, 184 sq.; Chambers, *encyclopædia*, s. v.

Digit (צֶמֶר, *etsba'*, the "finger"), a Jewish measure of length, being about the breadth of a finger (q. v.). It was the fourth part of a palm, and the 24th a cubit. According to Dr. Arbuthnot's tables, the digit is 0.912th of an English inch. See METROLOGY.

Dignities (δόξα, plur. of δόξα, *glory*) stands in 2 st. ii, 10; Jude 8, figuratively for persons high in honor, whom each of those apostles blames certain characters for calumniating. The term in this connection is usually referred to earthly magistrates or princes, whose claim to deference the Gospel every-

where enforces upon its followers; but it is probably better to refer it to the angels, even including those who are fallen, since the context in both passages introduces the good angels as refraining from using slanderous or abusive epithets towards them. The term is used with respect to the celestials by Philo (*Monarch.* ii, 218, ed Mang.). Similar is the usage of the terms "principalities and powers" in numerous passages of the epistles. See ANGEL.

Diké. See VENGEANCE.

Dik'lah (Heb. *Diklah'*, דִּיקְלָה, fem.; Sept. Δεκλί; Joseph. Δέκλας, *Ant.* i, 6, 4; Vulg. *Decla*), the seventh son of Joktan (B.C. post 2414); also the name of a district settled by a tribe descended from him (Gen. x, 27). As the name in Aramaic and Arabic means a palm-tree, it has been judged necessary to seek the seat of the tribe in some territory rich in palm-trees; of such there are several in Arabia (comp. Strabo, xvii, 776; Pliny, vi, 82). One famous place of palm-trees existed at the very entrance of Arabia Felix, hence called by the Greeks Φοινικίων (Ptolemy, vi, 7, 28); but this was remote from the other tribes of the Joktanids. See UZAL. Bochart (*Phaleg*, ii, 22) finds it in Southern Arabia, in the district of the *Mina*, which was also rich in palm-trees (Pliny, vi, 28), now called Yemen (Niebuhr, *Descr.* p. 201); Michaelis (*Spicileg.* ii, 176) in the region of the Tigris (from the analogy of the name *Digluth*); but where the ground of search is so uncertain, it is impossible to obtain any certain result (see Fresnel's *Lettres*, in the *Journal Asiatique*, x, 90-96, 176-200; Jomard's *Essai*, in Mengin's *Hist. de l'Egypte*, iii). As, however, there is still an Arab tribe in the region of Arabia Felix called *Diklāi*, which is probably descended from Diklah—for the Arabs have always been as retentive of family names as the Jews themselves (Forster's *Geog. of Arabia*, i, 115, 147)—we may conclude that the Diklites settled in Yemen, and occupied a portion of it a little to the east of the Hejaz. See ARABIA.

Dil'eän (Heb. *Dilan'*, דִּילְעָן, a *gourd-field* or *cucumber-patch*, suggestive of a rich soil; Sept. Δαλαίν v. r. Δαλαδ, Vulg. *Delean*), one of the cities of Judah, situated in the "valley" or maritime plain, and mentioned between Migdal-gad and Mizpeh (Josh. xv, 88). Van de Velde (*Narrat.* ii, 160) suggests that it may be the modern place *Tina* (*Beit Tina*, a Mussulman village, according to Smith, in *Robinson's Researches*, 1st edit. iii, Append. p. 118), about three miles north of Tell es-Safeh, in the maritime plain of Philistia, south of Ekron. Schwarz (*Palest.* p. 108) combines the name with Mizpeh following, against the text.

Dilherr, JOHANNES MICHAEL, a German theologian, was born Oct. 14, 1604, at Themar, in Henneberg. His father having lost his property, the young man supported himself by his own efforts, chiefly in proof-reading at Leipsic. After studying at Nuremberg and Altdorf, he became professor at Jena, first of eloquence in 1681, of history in 1684, and of theology in 1640. In 1642 he became professor of theology at Nuremberg, and in 1666 he was also made preacher at St. Sebaldus's church. He died in that town April 3, 1669. Besides a Latin history of the Augsburg Confession and some philosophical writings, he published *Ecolge Sacrae N. Test., Syriac., Gr., Lat., cum observat. philol., cum Rudimentis Grammat. Syriac.* (Halle, 1638, 1646);—*Atrium Linguae Sanctae* (1660, 8vo);—*Electorum libri tres, in quibus rituum sacr. et profan. farrago continetur* (Nürnberg, 1644).—Adelung, *Suppl.* to Jöcher, *allgem. Gelehr.-Lexikon*; Hoefler, *Nouv. Biog. Gén.* s. v.

Dill, the marginal and correct rendering at Matt. xxlii, 23, for ἀνῆθον, where in the text our translators have "anise"—misled, perhaps, by the similarity of *anethum* and *anise*. Pliny, however (xix, 52), carefully distinguishes between *anethum* and *anisum* (comp. Theophr. *Plant.* vii, 1; Dioscor. iii, 461). The *Anethum*

grævolens, or, as it is other wise called, *Anethum segetum*, on the assumption that there are two species, is a native of the warmer regions of the south, and is sometimes cultivated in English gardens under the name of "dill." It belongs to that very common natural family the *Umbellifera*, which abounds with genera and species that are warmed by a savor of aromatic pungency. The seeds are the parts that are used, whether it be for the purpose of soothing the alimentary system with a warm medicine, or of pleasing the palate with an agreeable condiment. Among the Cossacks, and in other parts of the Russian dominions, the plant is cultivated for the same use as the caraway is among us. Dill, caraway, coriander, and cummin belong to the same natural assemblage of plants, and though the seeds differ in form, and a little in flavor, yet they are employed for the same purposes, and possess virtues very nearly allied to each other. The flowers are yellow, like those of the parsnip; the leaves decomposed into hair-like divisions. The Talmudists describe the plant *שבת*, *shabath'*, as "called in the Roman language *anethum*," and add that it was tithed whether gathered green or ripe. It was tithed also both as to the seed and the herb itself. That the herb was tithed implied that it was eaten as well as the seeds, and, indeed, this is expressly said; and we are told that it was to be eaten raw, after meat, and not boiled (Kitto, *Pict. Bible*, note in loc.). See ANISE.

Dimissory Letters (*Epistola dimissoria*). (1.) In the ancient Church it was customary for any one about to travel to take with him letters of credence from his own bishop, if he wished to communicate with a Church in another country. These letters were of different sorts, according to the occasions or quality of the persons who carried them. *Epistola commendatoria* were granted to persons of quality, or to persons whose reputation had been called in question, or to clergymen who had occasion to travel in foreign countries. *Epistola communicatorie* signified that their bearers were in the peace and communion of the Church, and hence were called *pacifica*, and *ecclesiastica*, and sometimes *canonica*. *Epistola dimissoria*, at a later period, were only given to the clergy when they were to remove from their own diocese and settle in another: they were to testify that they had the bishop's leave to depart. All these went under the name of *formatæ*, because they were written in a peculiar form, with some particular marks, which distinguished them from counterfeits. They were granted by the bishop's sole prerogative. (2.) In the Church of England, dimissory letters are such as are used when a candidate for holy orders has a title in one diocese and is to be ordained in another: in such a case, the proper diocesan sends his letters, directed to the ordaining bishop, giving leave that the bearer may be ordained by him. In the Protestant Episcopal Church, certificates, or testimonials answering to the *Epistola dimissoria*, are required of clergymen passing from one diocese to another (Canon v. of 1844). Similar provisions exist in other Protestant denominations.—Bingham, *Orig. Eccles.* book ii, chap. v; Hook, *Church Dictionary* (Am. ed.), s. v.

Dim'nah (Heb. *Dimnah'*, דִּמְנָה, a *dung-hill*; Sept. Δεμνά, Vulg. *Damna*), a Levitical city of the tribe of Zebulon, assigned to the family of the Merarites (Josh. xxi, 35). Gesenius, however, suggests that in this place we ought rather to read דִּמְנָה, *Rimmonah*, the **REMMON** (q. v.) mentioned in a similar connection in Josh. xix, 13; 1 Chron. vi, 62 (see Bertheau, *Chronik*, p. 72, 73; Movers, *Chronik*, p. 72).

Di'mon (דִּימוֹן), by an interchange of letters for דִּיבוֹן, *Dibon*, for the sake of alliteration with דָּם, blood, in the same verse; Sept. Δεμῶν v. r. Πεμμῶν, Vulg. *Dibon*), a city of the Moabites, with streams

("waters") adjacent (Isa. xv, 9); elsewhere (an. ver. 2) more properly called **DIBON** (q. v.).

Dimo'nah (Heb. *Dimonah'*, דִּימוֹנָה, for דִּיבוֹנָה; Sept. Διμωνά v. r. Περγά, Vulg. *Dimon*), city in the south-east of Judah, mentioned between Kinah and Adadah (Josh. xv, 22); elsewhere (Isa. xi, 25) more properly called **DIBON** (q. v.).

Di'nah (Heb. *Dinah'*, דִּינָה, *judged*, i. e. *ruined*, from the same root as **DAN**; Sept. Δανά; Josh. Δάνα, Ant. i, 21, 1), the daughter of Jacob by Leah (Gen. xxx, 21), and therefore full sister of Simeon and Levi. Born B.C. 1918. While Jacob's camp was in the neighborhood of Shechem, Dinah, provoked by curiosity, went out "to see the daughters of the land," most probably to a festival, when she was seduced by Shechem, the son of Hamor, the Hivite chief or head-man of the town. Her age at this time, judging by the subsequent notice of Joseph's age (Gen. xxxv, 2), may have been from thirteen to fifteen, the ordinary period of marriage in Eastern countries (Lane's *Mod. Egypt.* i, 208). Partly from dread of the consequences of his misconduct, and partly, it would seem, out of love for the damsel, he solicited a marriage with her, leaving the "marriage price" or **MARRIAGE** to be fixed by her family. Such a negotiation would have been deemed sufficient under the Mosaic law (Deut. xxii, 28, 29) among the members of the Hebrew nation. But in this case the suit was by an alien, and the crown of the offense consisted in its having been committed by an alien against the favored people of God; he had "wrought folly in Israel" (Gen. xxxiv, 7). The proposals of Hamor, who acted as his deputy, were framed on the recognition of the hitherto complete separation of the two peoples; he proposed the fusion of the two by the establishment of the rights of intermarriage and commerce, just as among the Romans the *jus connubii* and the *jus commercii* constituted the essence of *civitas*. The sons of Jacob, bent upon revenge, availed themselves of the eagerness which Shechem showed to effect their purpose; they demanded, as a condition of the proposition, the circumcision of the Shechemites; the practice could not have been unknown to the Hivites, the Phenicians (Herod, ii, 104), and probably most of the Canaanitish tribes, were circumcised. Even this was therefore yielded; and Simeon and Levi took the most barbarous advantage of the compliance by falling upon the town on the third day, when the people were disabled by the effects of the operation, and slew them all (Gen. xxxiv). For this act of truly (Greek) vindictiveness no excuse can be offered, and Jacob repeatedly alludes to it with abhorrence and regret (Gen. xxxiv, 30; xlix, 5-7). To understand the matter at all, however, it is necessary to remember that it is stain upon the honor of a sister, and especially of a sister even (see Niemeyer, *Charakt.* ii, 413 sq.), as only at this day considered as an insupportable disgrace and inexpiable offence among all the nations of Western Asia. If the woman be single, her brothers more than her father—if she be married, her brothers more than her husband, are aggrieved, and are considered bound to avenge the wrong. Upon the active vengeance of Dinah's full brothers, and the comparative passiveness of her father in these transactions, Jacob's remark (ver. 30), however, does not imply merely guiltiness on the part of his sons in the transaction, but he dreaded the revenge of the neighboring peoples, and even of the family of Hamor, some of whom appear to have survived the massacre (Judg. ix, 28). His escape, which was wonderful, considering the extreme rigor with which the laws of blood-revenge (q. v.) have in all ages prevailed in the East, is ascribed to the special interference of Jehovah (xxxv, 5). Josephus omits all reference to the treachery of the sons of Jacob, and explains the destruction of the city as occurring during the celebration

ast (*Ant. i, 21, 2*). The object for which this name is introduced into the book of Genesis probably partly to explain the allusion in Gen. xlix, 5-7, partly to exhibit the consequences of any association on the part of the Hebrews with the heathens at them. Ewald (*Gesch. Isr. i, 40*) arbitrarily ascribes an actual fusion of the nomad Israelites with the rigines of Shechem, on the ground that the daughters of the patriarchs are generally noticed with an ological view. It appears from Gen. xlii, 15 that ah continued unmarried in the patriarch's family, accompanied him into Egypt.—Kitto, s. v.; Smith, . See JACOB.

Dī'na'ite (Chald. *Dinaye'*, ܕܝܢܝܝܬܝ, of unknown, but bably Median origin, used as a plur.; Sept. Δει-νοι; Vulg. *Dinæi*), one of the foreign tribes colod by the Assyrian general Asnapper in place of

the deported Samaritans, and who afterwards joined in the opposition to the efforts of the returned Jews in rebuilding their city (Ezra iv, 9). Junius (*Comm. in loc.*), without any authority, identifies them with the people "known to geographers by the name *Denna- ni*;" but there is only a *Denna* mentioned by ancient writers, and that an obscure town in Africa (Pliny, *Hist. Nat. vi, 85*). Schulthess (*Paradies*, p. 363) vaguely conjectures *Darius*, the most southerly province of Media Major (Δαρειρος χωρα, Ptolemy, vi, 2, 6; Pliny, vi, 25; comp. Mannert, V, ii, 159), or *Dera* in Susiana (Δήρα, Ptolemy, vi, 8, 5). See DURA. Ewald (*Gesch. d. Volkes Israhel*, iii, 375) suggests the Median city *Deinaber*.

Dinant, or Dinanto, DAVID OF. See DAVID OF DINANTO.

Dine (ܕܝܢܝܬܝ, *akal'*, Gen. xliii, 16; elsewhere to

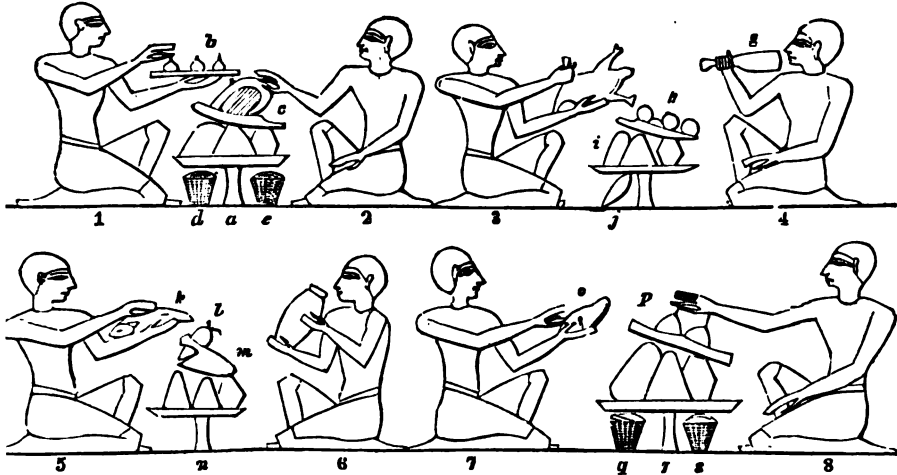

Ancient Egyptian Dinner-party.

f, m, r. Tables with various dishes, *e, h, i, m, -b, p.* *Fig.*—*d, e, and g, s.* Baskets of grapes.—*1, 3, and 8* are raising the covers; *3* is taking a wing from a goose; *4* holds a joint of meat, *g*; *5* and *7* are eating fish, *h, o*; *6* is about to drink water from an earthen vessel.—*l* is the *fig* or rufousness.



Modern Oriental State Dinner.

"*ax'*" or "*deavour*;" ἀπορώ, Luke xi, 37; John xxi, 12, 15); DINNER (דִּינָה, *aruchak'*, Prov. xv, 17; elsewhere "allowance," 2 Kings xxv, 80; "victuals," Jer. xl, 5; "diet," Jer. liii, 34; ἀπορω, Matt. xxii, 4; Luke xi, 38; xiv, 12). These Heb. terms are not expressive of any particular meal, although in the passage first cited the noon meal is referred to. The Greek terms (both kindred to ἡπι, *ear-ly*) relate properly to the morning meal, taken originally at sunrise (Homer, *Il.* xxiv, 124; *Od.* xvi, 2); in later times, the breakfast *lunch*, Lat. *prandium*, taken about the middle of the forenoon, or even so late as noon; the principal meal being the δείπνον, rendered "supper" (q. v.), taken later in the afternoon or early in the evening. See MEAL.

It appears that it was the custom in Egypt, in great families, to dine at noon, and for this purpose the meat was slaughtered on the premises only just before it was required for cooking (Gen. xliii, 16), which is still the custom in the East on account of the heat of the climate. It is probable, however, that the Egyptians, like other inhabitants of the East, as also the Greeks and Romans, took only a slight dinner about this time, the principal meal being at six or seven in the evening. Feasts at a later period among the Jews were always appointed at supper-time, for the burning heat of noon diminished the appetite for food, and suppressed the disposition to cheerfulness (Mark vi, 21; Luke xiv, 24; John xii, 2). A considerable quantity of meat was served up at these repasts, as is evident from the sculptures, which is still the custom of Eastern nations, whose *azuma*, or feast, is remarkable for the unsparing profusion of viands. A great variety of vegetables was also required on all occasions; and when dining in private, dishes of that kind seem to have been in greater request than joints, even at the tables of the rich. The tables, as at a Roman repast, were occasionally brought in and removed with the dishes on them; sometimes each joint was served up separately, and the fruit, deposited in a plate, or trencher, succeeded the meat at the close of the dinner. The Egyptians, like the Jews, were particularly fond of figs and grapes. Fresh dates, when in season, and in a dried state at other periods of the year, were also brought to table, as well as a preserve of the fruit still common in Egypt and Arabia (Wilkinson, *Anc. Egypt.* i, 179 sq., abridgm.). See BANQUET.

Din'habah (Heb. *Dinhabak'*, דִּינָהבָה, perhaps *robbers' den*, otherwise *ambush*; Sept. Δειναβα; Vulg. *Denaba*), an Edomitish city, the capital (and probably birthplace) of king Bela (Gen. xxxvi, 32; 1 Chron. i, 48). Eusebius and Jerome (*Onomast.* s. v. Δαναβα, *Damnaba*) mention a village *Damnea* (Δαννέα, Jerome *Damnaba*) eight miles from Areopolis, or Ar of Moab (Jerome, "on the road to Arnon"), and another on Mount Peor, seven miles from Esbus (Heshbon); but neither of these has claim to be the Dinhabah of Scripture. R. Joseph, in his *Targum* (on 1 Chron. i, 48, ed. Wilkins), finds a significance in the name. After identifying Balaam, the son of Beor, with Laban the Syrian, he adds, "And the name of his capital city was Dinhabah, for it was given (אֵיזִיחָרְבֵר) him as a present." The name is not uncommon among the Semitic races. Ptolemy (v, 15, 24) mentions a *Danaba* (Δαναβα) in Palmyrene Syria, afterwards a bishop's see, and according to Zosimus (iii, 27) there was a *Danabe* (Δαναβη) in Babylonia. The place in question was doubtless one of the petty localities of Mount Seir, possibly at *Dibidaba*, a little N.E. of Petra (Smith's list in Robinson's *Researches*, iii, App. p. 114, and i, *Map*).

Dinim. See TALMUD.

Dinner. See DINE.

Dinter, GUSTAV FRIEDRICH, a German theologian, was born at Borna, in Saxony, Feb. 29, 1760. He studied theology at Leipsic, and on leaving the

university was charged with the education of the of chamberlain Pöllnitz. In 1787 he became pastor at Kitzcher, near Borna, and in 1797 director of the teachers' seminary at Friedrichstadt, near Dresden. He was afterwards successively pastor at Görnitz, school inspector in 1816, and finally professor of theology at Königsberg in 1822. He died at the latter place May 29, 1831. He wrote largely on catechetical, religious education, and other practical subjects, in the interest of Rationalism. In his books for children, Dinter opens their eyes as to the imperfect notions of their fathers as to God, miracles, etc. "He gave teachers directions how to conduct themselves in such matters, and afterwards, in agreement with his principles he recommends, he lays down plans of teaching. For example, there are to be two years of catechising about Jonah: one before an audience is sufficiently enlightened, and where all remains in an old state; another for places which have more light. In the prophecies concerning the Messiah, a double explanation is given for the same reason. One is the orthodox way, and the other a more probable mystical plan. A clever teacher is to choose for himself a dull one may ask the parish clergyman how far he may go." His collected works have been published by Wilhelm, under the title *Ecegetische Werke* (1844-48, 12 vols.); *Katechetische Werke* (1840-44, 16 vols.); *Pedagogische Werke* (1840-45, 9 vols.); *Artenwerke* (1844-51, 5 vols.). He published an autobiography (*Dinter's Leben von ihm selbst beschrieben*, Weinstadt, 1829).—Kahn's, *German Protestantism*, ch. ii, § 6; Pierer, *Universal-Lexikon*, s. v.; Herzog, *Enzyklop.* iii, 397; Hurst, *History of Rationalism*, ch. iii.

Diocæsaræa. See SEPPHORIS.

Diocesan Episcopacy, that system of Episcopacy in which the bishop has jurisdiction only over a certain number of parishes, or over a certain class of country, called a *diocese*. See BISHOP; EPISCOPACY; DIOCESE.

Diocese (διοίκησις, *administration*), the territorial circuit of a bishop's *administration* where the Episcopacy is *diocesan* (q. v.).

1. *Roman Civil Dioceses.*—The origin of the diocesan division is to be traced to the ancient division of the later Roman empire. The term *diocese* is used by Cæro (*Fam.* iii, 8, 4) to designate the district of a governor's jurisdiction. Constantine divided the empire into 18 larger divisions, called *dioceses*, which were again divided into 120 *provinces*. The dioceses were governed by vicars or prefects. The civil diocesan division in the days of Arcadius and Honorius (beginning of the fifth century) was as follows: I. *Prefectus Prætorio per Orientem*: five dioceses were subject to his jurisdiction, namely, 1, the Oriental diocese, properly so called; 2, the diocese of Egypt; 3, the diocese of Asia; 4, the diocese of Pontus; 5, the diocese of Thrace. II. *Prefectus Prætorio per Illyricum*: only two dioceses were committed to his superintendance, namely, 1, the diocese of Macedonia; 2, the diocese of Dacia. III. *Prefectus Prætorio Italiae*: three dioceses were subject to the jurisdiction of this governor, namely, 1, the diocese of Italy; 2, the diocese of Illyria; 3, the diocese of Africa. IV. *Prefectus Prætorio Galliarum*: he had the command of three dioceses, namely, 1, the diocese of Spain; 2, the diocese of Gaul; 3, the diocese of Britain. The diocese of Britain included five provinces, namely, 1, *Maxima Caesariensis*; 2, *Valentia*; 3, *Britannia Prima*; 4, *Britannia Secunda*; 5, *Flavia Caesariensis*. Or this:

DIOCESE OF BRITAIN.		EXARCH OF YORK. &c.
Provinces.		Metropo- lis.
1. Maxima Caesariensis, i. e. at first, all from the Thames to the northern borders	} Eboracum (Yat.)	
2. Flavia Caesariensis, taken out of the former, and containing all from the Thames to the Humber		

itannia Prima, i. e. all south of } Londinium (London).
 e Thames..... }
 itannia Secunda, i. e. all beyond } Carleolum (Carlisle).
 e Severn..... }
 Eboracum, beyond the Picta' wall.. } Eboracum.

gham, *Orig. Eccles.* bk. ix, ch. i, where the subject
 ry fully treated.)

Ecclesiastical Dioceses.—"Some suppose the divi-
 of a church into dioceses to be the natural conse-
 ce of the institution of the office of bishop, and that
 ise of the system of diocesan division of a church
 be found in the New Testament. But this is evi-
 dly a mistake. In the times of the apostles a dio-
 and a church appear to have been the same; there
 therefore, no division of any church into dioceses.
 be said that the Church, i. e. the Catholic Church,
 thus divided, this too is a mistake. What is di-
 id must have first existed as a whole. Now the
 olic Church never existed as a whole, i. e. as one
 plete community on earth, from the time that
 stianity passed the bounds of Jerusalem. Thence-
 ard there was not *division*, but *additions* of fresh
 ches" (*Eden, Churchman's Dictionary*, s. v.). Af-
 the order of bishops had fully established itself,
 the state had become Christian, the Church took
 model of ecclesiastical territorial division from that
 te state. About the latter end of the fourth cen-
 the Church appears to have been divided in a
 lar manner with the empire, having an exarch or
 iarch in each of the thirteen great dioceses, and a
 poplitan or primate in every province. The less-
 iocese, used as the word is now, included the epis-
 ul city itself, and all the region round about it, with
 numerous congregations under the bishop's juris-
 ion; hence it was called the bishop's *παροικία*,
 ch, in its original application, meant the bishop's
 le diocese, though the word parish, or a single con-
 gregation, has flowed from it in later days. At a later
 od the word diocese was transferred to the bishop's
 l of jurisdiction, and the word *patriarchate* covered
 t of the ancient diocese.

n England, up to the twelfth century, bishops were
 l to exercise their functions within a certain geo-
 phical territory called a *parish*; the word *diocese*
 ; seldom used, nor was it at all employed in Eng-
 d, with authority from the popes, until A.D. 1138
W. and For. Evang. Review, No. 211, p. 223). The
 urch of England now includes twenty-eight dioc-
 es (including the two archbishoprics); that of Ire-
 d twelve. In the United States a diocese is a ter-
 ry under the jurisdiction of a single bishop of the
 stantant Episcopal or Roman Church, whether com-
 nding one or more states of the Union, or only
 t of a state. New dioceses can be formed in the
 stantant Episcopal Church with the consent of the
 hop, the Diocesan Convention, and the General Con-
 tion. There were in the United States, in 1867,
 rty-four dioceses of the Protestant Episcopal Church,
 d forty-four dioceses of the Roman Catholic Church.
 1868, the pope, in accordance with the proposition
 de by the "Second Plenary Council of Baltimore,"
 ublished nine new dioceses, thereby increasing the
 al number of Roman Catholic dioceses to fifty-three.
 e Bingham, *Orig. Eccles.* book ix, chap. i; Bilson,
perpetual Government of Christ's Church, chap. xiv;
 ok, *Church Dictionary*, s. v.; Ferraris, *Prompta Bib-
 theca*, s. v.; Elliott, *Delineation of Romanism*, book
 , chap. ix; Hooker, *Ecclesiastical Polity*, book vii, §
 Siegel, *Handbuch der Alterthümer*, iv, 378.

**Dioclesian, or Diocletian (DIOCLETIANUS, CA-
 ARELIUS VALERIUS)**, Roman emperor, was born
 out A.D. 245 (others say 255), near Salona, in Dal-
 atia. From the name of his mother, Dioclea, he was
 lled Diocles, which he afterwards made Diocletianus.
 e entered the army, and rose from the ranks to high
 sition. Dioclesian commanded the household or im-
 rial body-guards when young Numerianus, the son

of Carus, was secretly put to death by Aper, his
 father-in-law, while travelling in a close litter on ac-
 count of illness, on the return of the army from Persia.
 The death of Numerianus being discovered, after sev-
 eral days, by the soldiers near Calchedon, they arrest-
 ed Aper and proclaimed Dioclesian emperor, who, ad-
 dressing the soldiers from his tribunal in the camp,
 protested his innocence of the death of Numerianus,
 and then, upbraiding Aper for the crime, plunged his
 sword into his body. The new emperor observed to a
 friend that "he had now killed the boar," alluding to
 a prediction made to him by a Druidess in Gaul, that
 he should mount the throne as soon as he had killed
 the wild boar (*Lat. Aper*). He became emperor Sept.
 17, 284, and in 286 chose Maximinianus as his col-
 league in the empire (as Augustus); in 292 he added
 Galerius as Caesar, while Maximinianus chose Con-
 stantius Chlorus. The empire was parcelled out among
 them, and the theory of the system was that the young-
 er men, as Cæsars, should be trained to rule, and should
 succeed in time to the functions of Augustus. Inter-
 nal peace was secured for years by this arrangement.



Coin of Dioclesian. (British Museum. Actual size.)

The reign of Dioclesian was in many respects a noble
 and successful one, but its glory was stained by the
 terrible persecution of the Christians which he author-
 ized. "The earlier part of his reign was favorable to
 the Christians, and it was through the weakness and
 superstition of the prince, rather than his wickedness,
 that his name is now inscribed on the tablets of infam-
 y as the most savage among persecutors. Galerius
 represented to him that the permanence of the Roman
 institutions was incompatible with the prevalence of
 Christianity, which should therefore be extirpated.
 Dioclesian proposed the subject to a sort of council,
 composed of some eminent military and judicial offi-
 cers. They assented to the opinion of Galerius; but
 the emperor still hesitated, until the measure was san-
 ctioned and sanctified by the oracle of the Milesian
 Apollo. The emperor gave a tardy consent to the
 commencement of a plan into which he appears to
 have entered with the most considerate calmness,
 though it is also true that during its progress some in-
 cidents occurred which enlisted his passions in the
 cause, and even so inflamed them that, in the height
 of his madness, he certainly proposed nothing less than
 the extermination of the Christian name. The influ-
 ence of the Cæsar Galerius, who was animated, from
 whatsoever motive, by an unmitigated detestation of
 the worshippers of Christ, and who thirsted for their
 destruction, was probably the most powerful of those
 circumstances. But the second must not be forgotten.
 In the disputes, now become general, between the
 Christian ministers and the pagan priests, the teach-
 ers of philosophy are almost invariably found on the
 side of the latter; and as it is not denied—not even by
 Gibbon—that those learned persons directed the course
 and suggested the means of persecution, we need not
 hesitate to attribute a considerable share in the guilt
 of its origin to their pernicious eloquence. Dioclesian
 published his first edict in the February of 303. Three
 others of greater severity succeeded it; and, during a
 shameful period of ten years, they were very generally
 and rigorously enforced by himself, his colleagues, and
 successors. It is needless to particularize the degrees
 of barbarity by which those edicts were severally dis-

tinguished. The substance of the whole series is this (see Eusebius, *Hist. Eccl.* bk. viii): The sacred books of the Christians were sought for and burned; death was the punishment of all who assembled secretly for religious worship; imprisonment, slavery, and infamy were inflicted on the dignitaries and presidents of the churches; every art and method was enjoined for the conversion of the believers, and among those methods were various descriptions of torture, some of them fatal. During the preceding ninety years the Church had availed itself of the consent or connivance of the civil government to erect numerous religious edifices, and to purchase some landed property. These buildings were now demolished, and the property underwent the usual process of confiscation. A more degrading, but less effectual measure attended these: Christians were excluded from all public honors and offices, and even removed without the pale of the laws and the protection of justice; liable to all accusations, and inviting them by their adversity, they were deprived of every form of legal redress. Such were the penalties contained in those edicts; and though it be true that in some of the western provinces of the empire, as in Gaul, and perhaps Britain, their asperity was somewhat softened by the character and influence of the Caesar Constantius, we are not allowed to believe that their execution even there was generally neglected, and we have too much reason to be assured that it was conducted with very subservient zeal throughout the rest of the empire. In process of time the sufferings of the Christians were partially alleviated by the victories of Constantine, but they did not finally terminate till his accession" (Waddington, *Church History*, ch. iv). In the autumn of 303 Dioclesian was taken with an illness which affected him for many months, and in 305 he abdicated in favor of Galerius, and retired to Salona, in Dalmatia, where he lived quietly and greatly respected until July, 313, when he died. See *Eng. Cyclop.* s. v.; Eusebius, *Ch. Hist.* bk. viii; Gibbon, *Decl. and Fall of the Roman Empire*, ch. xlii; Mosheim, *Hist. Comment.* etc., cent. iii, § 22; Lardner, *Works*, vii, 515 sq. See PERSECUTIONS.

Diodati, Jean (*Ital.* GIOVANNI), an eminent divine of the Reformed Church, was born in Geneva in 1576, of a noble Italian family from Lucca. His progress in learning was so rapid that Beza procured him the professorship of Hebrew in the University of Geneva when he was but twenty-one. In 1608 he became pastor, or parish minister, and in the following year professor of theology. While travelling in Italy, he became acquainted with father Sarpi and his friend father Fulgenzio, and there appears to have been some talk and correspondence between them about attempting a religious reform in Italy, but Sarpi's caution and maturer judgment checked the fervor of the other two. Diodati afterwards translated into French and published at Geneva Sarpi's *History of the Council of Trent*. He was sent by the clergy of Geneva on several missions, first to the Reformed churches in France, and afterwards to those of Holland, where he attended the Synod of Dort (1618-19), and he was one of the divines appointed to draw up the acts of that assembly. He published an Italian translation of the Bible in 1607, which, though paraphrastic, is still considered one of the best in that language; and afterwards a French translation, with brief notes, which was not completed till 1644, and is not very well done. He wrote also *Annotations in Biblia* (Geneva, 1607, fol.), which were translated into English and published in London in 1648 (3d ed. 1651), and various theological and controversial works, among them *De Fictis Pontificiorum Purgatorio* (1619); *De justa Secessione Reformatorum ab Ecclesia Romana* (1628); *De Ecclesia* (1620); *De Antichristo* (1624). Senelier, *Histoire Littéraire de Genève*, gives a catalogue of Diodati's works. He died at Geneva in 1649. See Hoefler, *Nouv. Biog. Générale*, xiv, 236, and references there.

Diodati, Dominico, an Italian scholar and theologian, was born at Naples 1736, and devoted himself especially to ecclesiastical studies. He is mentioned here on account of his *De Christo Græce exercitatio, qua ostenditur Græcam sive Hæcæam linguam cum Judæis omnibus, tum ipse adeo Christo, et apostolis nativam ac vernaculam fuisse* (Naples, 1767; edited, with a preface, by Dolbin, *Loc. cit.* sm. 8vo). The work seeks to prove that Christ the apostles spoke only in Greek, and made use of the Greek version of the Scriptures. See *Asiatic Repository*, i, 814.

Diodorus, bishop of Tarsus, is supposed to have been born at Antioch. After being ordained there, and intrusted with the care of its Church, he was banished by Meletius, its head, though against the orders of the emperor, and he acted so prudently and courageously as to maintain orthodoxy in the see. After the death of Meletius he was ordained bishop of Tarsus, A.D. 302. So great was his fame that he was chosen to take care of the interests of the Eastern churches at the Council of Constantinople, A.D. 381. The date of his death is not accurately known, but it must have been before the year 394. None of his works have come down to us, except in fragments or extracts, preserved by Photius and others. He was highly esteemed by the great men of his own and after times, and his writings much commended by Theodore of Mopsuestia, who was an advocate of Nestorianism, was his pupil, and the scholar was supposed to have imbibed his heresy from his master. Chrysostom was also one of his pupils. Even the friends of orthodoxy of St. Chrysostom could not avail themselves of his name. The loss of his works is the more to be regretted, as he was the first that began to throw an allegory in the interpretation of Scripture. From a catalogue of his works mentioned by Suidas (in *Diodor.*), most of them appear to have been explications of Scripture, or controversial tracts; Photius preserved (*Cod.* 223, p. 662) much of his argument taken out of a treatise on *Fate*; and Eusebius of Cesarea (*Bib. Or.* tom. iii, p. 39), in his catalogue of the ecclesiastical writers, mentions 60 books of Diodorus, that the Arians burned, and gives the titles of eight of them. His style was clear and perspicuous, according to the testimony of Photius, and his arguments, as St. Basil (*Epist.* 167), were close and well arranged, pressed in language of the greatest simplicity (Suidas, *Hist. Eccl.* chap. vi; Theodorot, *Hist. Eccl.* etc.). See the list of his writings in Fabricius, *Bibliotheca Græca* (ed. Harles), ix, 277-282; also Leo Allatrinus, *Diatriba de Theodoris*, No. lxxvi, apud Ang. Mai, *Opuscul. Nov. Patr.* vi, 187; also given in Migne, *Patrologia Græca*, xxxiii, 1645-1627, where fragments of the Pentateuch and Psalms are given in Greek and Latin. Semisch (in *Real-Encyclopædie*, iii, 405) gives an account of the doctrinal position of Diodorus, which we condense a few words. Diodorus died not only in the odor of sanctity but with a high reputation for orthodoxy. The Nestorian controversy, after his death, robbed him of his reputation. Some of his writings against Arianism involve the principles of the later Nestorianism, e. g. the *πρός τοὺς συνοουσιαστας*, and the treatise *περὶ τοῦ ἀγίου πνεύματος* (Phot. *Bib. Cod.* 109), the former of which there are fragments in the *Patrologia Græca* (ed. Baluze, p. 349 sq.) and Leontius of Byzantium (Canisius, *Lect. Antiqq.* ed. Basnage, i, 581). Here Diodorus makes the Son of God twofold, viz. Logos of God and the Son of David, of whom the latter, not the former, was conceived by Mary through the Holy Spirit. The mystery of the incarnation consists in the assumption of a perfect humanity by the Logos. The relation of the two natures is the dwelling of the Logos in the man Jesus, as his outward investiture. Through this relation the Son of David is called the Son of God, though not in the proper and exclusive sense. This view, and

union of the two natures an external and moral rather than substantial union, naturally led, after Nestorianism arose, to the conclusion that Diodorus and school of Antioch had been its precursors, to say least. See the article of Semisch in Herzog, *Real-encyklop.* l. c.; and compare Lardner, *Works*, iv, 376

Ceillier, *Histoire Générale des auteurs ecclésiastiques*, v, 586 sq. (ed. of Paris, 1868-65); Gieseler, *Ch. hist.*, vol. i, § 82; Dorner, *Person of Christ* (Edinb. sl.), per. ii, epoch i, chap. i.

Diognētus, the Epistle to, an anonymous Greek letter to an inquiring heathen of some distinction, by the name of Diognetus, in vindication of Christianity, and one of the most precious remains of Christian antiquity, equal, both in matter and style, to the Gospels, and superior to most of the writings of the apostles, fathers and early apologists.

Contents.—It consists of twelve (or rather ten) chapters. It opens with an address to Diognetus, who is described as exceedingly desirous to learn the Christian doctrine and mode of worship in distinction from the Greeks and the Jews. The writer, rejoicing in his opportunity to lead a Gentile friend to the path of truth, exposes first the vanity of idols (ch. ii), then the superstitions of the Jews (ch. iii and iv), after which he gives, by contrast, a striking and truthful picture of Christian life, which moves in this world the invisible, immortal soul in the visible, perishable body (ch. v and vi), and sets forth the benefits of Christ's coming (ch. vii). He next describes the miserable condition of the world before Christ (ch. viii), and answers the question why he appeared so late (ch. ix).

In this connection occurs a beautiful passage on atonement, which is almost worthy of St. Paul, and is fuller and clearer on that subject than any that can be found before Irenæus. He concludes with an enumeration of the blessings and moral effects which flow from the Christian faith (ch. x). This is a fit conclusion of the epistle. The last two chapters, which are probably an addition by a later hand, treat of knowledge, faith, and spiritual life with reference to the tree of knowledge and the tree of life in Paradise.

I. Form and Value.—Within this short compass writer brings out a mine of rich thought in elegant Greek, and betrays throughout Hellenic culture and elegant taste. The epistle is acknowledged to be one of the most beautiful and valuable memorials of primitive Christianity. It belongs to the literature of apologetics, or evidences of Christianity, and forms the connecting link between the practical exhortations of apostolic fathers and the more elaborate apologies of Justin Martyr and his successors. It reflects vividly the power of Christianity in those days, which tried the hearts of believers when the profession of Christ was connected with the risk of life. It breathes the spirit of true martyrdom. "Do you not see the Christians exposed to wild beasts, and yet not overcome? do you not see that the more of them are punished, the greater becomes their number? This does not seem to be the work of man, but the power of God" (ch. vii). The picture of true Christianity, as related to the world, is a perfect gem, and as applicable to the present time as to the age of confessors and martyrs. "The Christians," says the writer (ch. v and vi), "are distinguished from other men by country, by language, nor by civil institutions; for they neither dwell in cities by themselves, nor use a peculiar mode of life. They dwell in the Grecian or barbarian cities, as the case may be; and they follow the usage of the country in dress, food, and in the other affairs of life. Yet they present a wonderful and confessedly paradoxical conduct. They dwell in their own native lands, but as strangers. They take part in all things as citizens, and they suffer all things as foreigners. Every foreign country is fatherland to them, and every native land is a foreign country to them. They marry, like others; they have children;

but they do not cast away their offspring. They have the table in common, but not wives. They are in the flesh, but they do not live after the flesh. They live upon earth, but are citizens of heaven. They obey the existing laws, and excel the laws by their lives. They love all, and are persecuted by all. They are unknown, and yet they are condemned. They are killed and made alive. They are pure and make many rich. They lack all things, and in all things abound. They are reproached, and glory in their reproaches. They are calumniated, and are justified. They are cursed, and they bless. They receive scorn, and they give honor. They do good, and are punished as evil-doers. When punished, they rejoice, as being made alive. By the Jews they are attacked as aliens, and by the Greeks persecuted; and the cause of the enmity their enemies cannot tell. In short, what the soul is in the body, the Christians are in the world. The soul is diffused through all the members of the body, and the Christians are spread through the cities of the world. The soul dwells in the body, but it is not of the body; so the Christians dwell in the world, but are not of the world. The soul, invisible, keeps watch in the visible body; so also the Christians are seen to live in the world, but their piety is invisible. The flesh hates and wars against the soul, suffering no wrong from it, but because it resists fleshly pleasures; and the world hates the Christians with no reason but that they resist its pleasures. The soul loves the flesh and members by which it is hated; so the Christians love their haters. The soul is inclosed in the body, but holds the body together; so the Christians are detained in the world as in a prison, but they contain the world. Immortal, the soul dwells in the mortal body; so the Christians dwell in the corruptible, but look for incorruption in heaven. The soul is the better for restriction in food and drink; and the Christians increase, though daily punished. This lot God has assigned to the Christians in the world, and it cannot be taken from them." Another passage on the atonement deserves to be cited. In meeting the question why Jesus Christ, if he was the author of the only true religion, appeared so late, the epistle says (chap. ix): "When our wickedness had reached its height, and it had been clearly shown that its reward, punishment and death, was impending over us; and when the time had come which God had before appointed for manifesting His own kindness and power, how the one love of God, through exceeding regard for men, did not regard us with hatred, nor thrust us away, nor remember our iniquity against us, but showed great long-suffering, and bore with us, He himself took on him the burden of our iniquities, He gave His own Son as a ransom for us, the holy One for transgressors, the blameless One for the wicked, the righteous One for the unrighteous, the incorruptible One for the corruptible, the immortal One for them that are mortal. For what other thing was capable of covering our sins than His righteousness? By what other one was it possible that we, the wicked and ungodly, could be justified, than by the only Son of God? O sweet exchange! O unsearchable operation! O benefits surpassing all expectation! that the wickedness of many should be hid in a single righteous One, and that the righteousness of One should justify many transgressors!"

III. Authorship and Time of Composition.—The writer calls himself (chap. xi) a disciple of the apostles (*ἀποστόλων γενομένος μαθητής*), and thus seems to place himself in a line with the apostolic fathers. But the eleventh and twelfth chapters are not free from the suspicion of being a later interpolation. (See the arguments well put by Semisch, *Justin der Märtyrer*, i, 174, note; Otto, 2d ed. p. 56 sq.; and Hefele, *Patr. Apost.* Proleg. p. xcii.) Nevertheless, some of the most learned historians, such as Tillamont (*Mémoires*, ii, 498), Möhler (*Patrologie*, i, 165), Hefele

(Proleg. p. xci), Werner (*Geschichte der apolog. und polem. Literatur der christl. Theol.* i, 127), put it in the first, or, at all events, in the beginning of the second century, under the reign of Trajan. Dorner places it a little later, in the reign of Hadrian, and is disposed to attribute it to the apologist Quadratus. Bunsen's conjecture of Marcion as the author has found no favor, and has been amply refuted by Otto (2d ed. p. 42 sq.). Still others name Aristides as the probable author. Cave, Fabricius, Baumgarten-Crusius, and Otto, with two of the MSS., ascribe it to Justin Martyr. Otto conjectures, on the ground solely of the accidental identity of name, that Diognetus, to whom the epistle is addressed, was the preceptor and friend of the emperor Marcus Aurelius in the middle of the second century, and exerted a happy influence on his pupil, who, however, was a pure Stoic, and a bloody persecutor of the Christians in Asia Minor and in Southern Gaul. But the epistle is superior to the genuine writings of Justin Martyr, both in clearness and force of thought, and in purity and terseness of style. It betrays the freedom of the school of St. Paul. Its whole character would rather place it somewhat earlier, between the apostolic fathers and Justin Martyr; for Christianity is represented as something new, which had but recently appeared in the world (ch. i, ii, ix), and yet repeated persecutions are already presupposed (ch. vii). For a fuller discussion of the arguments for and against the authorship of Justin Martyr, see Otto's *Prolegomena* to his second edition of the Ep. p. 9 sq., Semisch, *Justin der Märtyrer*, i, 172 sq., and Hefele, *Patr. apoc. Opera*, Proleg. p. lxxxvi sq.

IV. *Editions and Literature.*—So far there are only three manuscript copies of the epistle extant, two of which ascribe it to Justin Martyr. The first printed edition was prepared by Henry Stephanus at Paris, 1592, under the title *Ἰουστίνου τοῦ καλοσόφου καὶ μάρτυρος Ἐπιστολὴ πρὸς Διόγνητον καὶ Λόγος πρὸς Ἕλληνας—Justinus philosophi et martyris Epistola ad Diognetum, etc.* It then appeared in connection with the works of Justin Martyr. Hefele incorporated it in his edition of the Apostolic Fathers (4th ed. Tübingen, 1855, p. 296 sq.). The best edition is that of J. C. Th. Otto, *Epistola ad Diognetum Justinus philosophi et martyris nomen prae se ferens* (Jen. 1845; 2d ed. Lips. 1858, with Proleg. and Annot.). German translation by Hollenberg, *Der Brief an Diognet*, Berlin, 1858. English translations, *Christian Rev.* ix, 280; *Princeton Rev.* xxv, 44; and in *Ante-Nicene Christian Library*, Edinb. 1867, i, 303 sq. Compare also C. D. a Grossheim, *De Epist. ad Diogn.* (1828); Hoffmann, *Ueber Justinus des Märtyrers Brief an Diognet* (1851); Snoeck, *Introd. in Ep. ad Diogn.* (L. Bat. 1861); Semisch, *Justin der Märtyrer* (Breslau, 1840, p. 172 sq.), and his article *Diognet* in Herzog's *Real-Encyclop.* iii, 407-410; Werner, *Geschichte der apolog. und polem. Literatur des christl. Theologie* (Schaffhausen, 1861, i, 126 sq.).

Dionysia (Διονύσια, Vulg. *Bacchanalia*), "the feast of Bacchus" (2 Macc. vi, 7), which was celebrated, especially in later times, with wild extravagance and licentious enthusiasm (hence the term Bacchanalian). Women, as well as men, joined in the processions (*θιασοί*), acting the part of Mænads, crowned with ivy and bearing the thyrsus (comp. Ovid, *Fast.* iii, 767 sq.; Broudkh. *ad Tib.* iii, 6, 2, who gives a coin of *Maroneia* bearing a head of Dionysus crowned with ivy); and the phallus was a principal object in the train (Herod. ii, 48, 49). Shortly before the persecution of Antiochus Epiphanes, B.C. 168, in which the Jews "were compelled to go in procession to Bacchus carrying ivy" (2 Macc. vi, 7), the secret celebration of the Bacchanalia in Italy had been revealed to the Roman senate (B.C. 186). The whole state was alarmed by the description of the excesses with which the festival was attended (Livy, xxix, 8 sq.), and a decree was passed forbidding its observance in Rome

or Italy. See Smith's *Dict. of Class. Antiq.* i, 7. The fact offers the best commentary on the conduct of Antiochus; for it is evident that rites which were to be incompatible with the comparative simplicity of early Roman worship must have been precluding revolting to Jews of the Ammonian age (comp. Herod. iv, 79).—Smith, s. v. See DIONYSIA.

Dionysian Æra. See VULGAR ÆRA.

Dionysius the AREOPAGITE (ὁ Ἀρεοπαγίτης), one of Paul's converts at Athens, of whom no further account is given in the New Testament than in the Acts xvii, 19-34, viz., that Paul was brought into Areopagus (q. v.) at Athens to give account of his doctrine. The results of his speech are briefly stated in verse 34: "Howbeit, certain men clave unto him, and believed: among the which was Dionysius (Suidas, q. d. a votary of Bacchus) the Areopagite, and one named Damaris, and others with them."

Eusebius (*Hist. Eccles.* iii, 40, and iv, 23) tells us that Dionysius of Corinth names "Dionysius the Areopagite" (whom Luke has recorded in the Acts) as first bishop of the Church in Athens. Suidas gives a fuller account, according to which Dionysius, born in Athens, studied there and in Egypt, and came eminent for learning; and while at Heliopolis in Egypt, seeing an eclipse of the sun, he cried to a friend, "Either the Deity is suffering, or something with some sufferer;" and this eclipse took place at the time of the death of Christ. Returned to Athens, he became an Areopagite, was converted under Paul's discourse, and was made bishop of Athens by Paul. So far Suidas. On the authority of Aristides the Apologist he is said to have suffered martyrdom at Athens.

The name of Dionysius has become important in Church history from certain writings formerly believed to be his, but now known to be spurious, and designated as the *Pseudo-Dionysian* writings. These are: 1. *The Celestial Hierarchy* (περὶ τῆς οὐρανόθεν ἱεραρχίας); 2. *The Ecclesiastical Hierarchy* (περὶ τῆς ἐκκλησιαστικῆς ἱεραρχίας); 3. *Concerning the Name of God* (περὶ Θεῶν ὀνομάτων); 4. *Of Mystical Theology* (περὶ μυστικῆς θεολογίας); 5. *Epistles*, ten in number; 6. *A Liturgy* having the name of Dionysius given by Renaudot, *Lit. Orient. Coll.* ii, 201. The first appearance of these writings was in the sixth century. In 538 a conference was held at Constantinople between the Severians (Monophysite heretics) and the orthodox Catholics, when the Severians added these writings in support of their opinions (see Hefele, *Concilien-geschichte*, ii, § 245). Hyperius, who presided at the conference, and the Catholics with him, asserted that these writings were either interpolated or spurious. Nevertheless, from this time on, they gradually grew into repute in the East, where they soon found commentators (e. g. St. Maximus, 7th century, Georg Pachymeres, etc.), who, with the Greek liturgists of Dionysius, find place in the second volume of his works of Dionysius, in Migne, *Patrol. Græc.* iv. In the Western Church, Gregory the Great († 604) cites them as nominally the writings of Dionysius (Insa. 34). They attracted more attention in the eighth century, when Stephen II sent a copy as a present to King Pepin (A.D. 758), and the emperor Michael sent one to Louis the Pious (A.D. 827). Hilduin, abbot of St. Denis, near Paris, compiled an apocryphal collection of accounts concerning the history of Dionysius, and identified the author of these writings with Denis [see DENIS], the patron saint of Paris. From this time, for centuries, their authenticity was not questioned; and they were the subjects of translations, scholia, lectures, etc. from such men as Johannes Scotus, Hugo de St. Victor, Albertus Magnus, and Thomas Aquinas. The critical spirit of the Reformation, however, was early directed towards the Dionysian writings. Erasmus († 1536) questioned their authentic-

ness on Acts xvii); and in 1629, Sirmond (the Jesuit) denied the identity of Dionysius the Areopagite with St. Denis, and questioned also the authenticity of the writings attributed to him. The question of identity was long controverted among the Gallican theologians, but by the end of the century the Parisian writers contained two saints Dionysius instead of one. The question of authenticity was discussed and led by the great Protestant writer Daillé, in his *Scriptis Dionysii Areopagite* (Geneva, 1666), who followed on the same side by the Roman Catholic Gaspar Le Nourry (*Appar. ad. Bib. Max. Patr.* 1708, 170 sq.; given also in Migne, *Patrol. Græca*, iii, 1). Other Romanist writers (e. g. Halloix and Delwoupe) whose apologies are given in Migne, *Patr. Græc.* iv) sought to maintain the authenticity of the writings; but the greater scholars of that Church (e. g. Fillemont, Pagi, etc.) admit that they are spurious. Few modern writers (e. g. Kestner, *die Agape, od. d. eime Weltbund d. Christen*, Jen. 1819, 8vo; Darbois, *reduction to a French translation of Dionysius*) have sought again to restore the credit of the books, but the question is settled, in both Roman and Protestant circles, against their authenticity. As to the real date of the books, Daillé (*op. cit.* p. 184) fixes it as probably toward the end of the fifth and beginning of the sixth century; Pearson, who discusses the subject pretty fully in his *Vindicia Ignatiana*, cap. x, thinks the date could be before that of Jerome, in the fourth century; Tillemont, and even Tillemont, refute Pearson; usage giving the date as the end of the fifth, or beginning of the sixth century (*Hist. de l'Église*, viii, 10, ed. in Lardner, *Works*, v, 78). Cave, *Hist. Litt.* (Geneva, 1720) i, 142, gives A. D. 862 for the date, and declines to think Apollinarius (either father or son) the author. Others (e. g. La Croze) make Synesius, bishop of Ptolemais (fifth century), the author.

Connected with the question of the origin of the pseudo-Dionysian writings is that of their object and aim. Le Nourry (*op. cit.*) supposes them to have been rected against the Eutychian and Nestorian heresies; but there is not enough matter of this sort in them to justify this opinion. Baumgarten-Crusius (*Opuscula Theol.* Jena, 1836, p. 265) maintains that the object of the books was to incorporate the Grecian mysteries with Christianity, and to set up mystical theology over against Gnoeticism; and he assigns an Alexandrian origin to them (third century). But the Gnosticism combated in these books is not the early Gnosticism. Engelhardt, in his *Die angebl. Schriften Dionys. Areop. übersetzt*, etc. (Sulzbach, 1823) assigns their origin to the Neoplatonic school of Proclus († 485). Neander (*History of Christian Dogmas*, Bohn's ed. i, 268) finds in them a mystical theology "resulting from a mixture of the Platonic and Christian mind, which turned the whole constitution of the Church, its external rites, and its dogmas, into a symbol of its ideas." According to Niedner (*Kirchenrech.* cited by Neander, l. c.), there is in the Pseudo-Dionysian writings the exhibition of a pretended Athenian Gnosis, but rather Antiochian, which reconciles the pure Hellenic Neoplatonism and the Church doctrine more faithfully than the older Gnosis. We may learn from these writings, adds Neander (ii, 402), "how strongly the mystic liturgic element of the Greek Church tended to the multiplication of the sacraments. The liturgic elements of worship, and those of the hierarchy, receive in them a mystic, symbolic meaning. These writings conveyed the existing spiritual tendencies to the following period. The sacraments which they enumerate are the following: baptism (βάπτισμα), the Lord's Supper (κοινωνία συνάξεως), priestly ordination (τελειωσις ιερατικῆς), monastic ordination (τελειωσις μοναχικῆς), the rites used at the burial of believers (τά ἐπι τῶν ἱερῶν κομμειμμένων)". The doctrine of God taught is that intuition of him can only be obtained by mystical contemplation. Man

can have no absolute knowledge of God in thought; all his knowledge is relative; but man can be united to God, "lost in God" in the devotion of supreme love. In the *Celestial Hierarchy* the angels are divided into three classes, and each class into three orders (τάγματα), thus: I. 1. Θρόνοι, thrones; 2. Χερουβίμ, cherubim; 3. Σεραφίμ, seraphim; II. 4. κυριότητες, dominions; 5. ἐξουσίαι, authorities; 6. δυνάμεις, powers; III. 7. ἀρχαί, principalties; 8. ἀρχάγγελοι, archangels; 9. ἄγγελοι, angels. He nevertheless observed that the last term, as well as δυνάμεις οὐράναι, was common to all (Hagenbach, *Hist. of Doctrines*, § 181). Gross and sensuous ideas as to angels are discarded. As to the aim of the Pseudo-Dionysian as a whole, we condense the views of Vogt, in Herzog's *Real-Encyclopædie*, iii, 418, as follows: The Pseudo-Dionysian writings are an attempt to incorporate Neoplatonism into Christianity. Their author must have been penetrated with the spirit of both systems. He probably assumed the venerable name of Dionysius the Areopagite with a view, on the one hand, to gain the ear of the educated and philosophical Athenians, and, on the other, to secure the sympathy of the Christian Church. These philosophers hated Christianity, and charged those Christians who adopted Neoplatonic ideas with the crime of first stealing these ideas, and then using them as a weapon of offence against their proper owners. The Pseudo-Dionysius sought to refute this charge by maintaining that these ideas were properly and truly Christian, springing from an Athenian Christian school, and belonging to the very nature of the Christian institutions. The fact that the heathen philosophy of his time had adopted many Christian ideas, probably justified, to his mind, this mode of argument. "Why stay among the shadows of the heathen mysteries, when all the true and noble ideas of heathendom are to be found, glorified and transfigured, in the Christian Church?" As to the Christian Church, on the other hand, the author sought to bring into it a mode of thought which, in his judgment, would give it a profounder insight into real Christian truth, and elevate it above mere strifes of dogma, and above the bar of politico-ecclesiastical passions (comp. *Epist.* 6, 7, 8). He certainly succeeded in planting mystic philosophy strongly in the Church, and it has never since been completely uprooted. Moreover, as the Church had already, to some extent, paganized its form of worship, and borrowed heathen forms also for its speculation, as well as for its hierarchial government, it is not to be wondered at that a book which professed to justify all these things, by the authority of one who was converted by St. Paul himself, should find willing auditors.

Literature.—The best edition of the Pseudo-Dionysius is that of Balthazar Corderius (Paris, 1615, 1684, and 1644; and Venice, 1755, 2 vols. fol.). It is given in Migne, *Patrologia Græca* (vols. iii, iv), with Le Nourry's Introduction, the scholia of Maximus and Pachymeres, biographies of Dionysius by Halloix and others, and Delrio's *Vindicia Areopagitice*. Numerous editions of some of the single writings have been issued, of which accounts may be found in Hoffmann, *Bibliographisches Lexikon*, i, 577 sq.; and in Fabricius, *Bibliotheca Græca*, ed. Harles, vii, 7 sq. Of translations, Engelhardt's (German: Sulzbach, 1823, 2 vols.) has already been cited; in French, Darbois, *Œuvres de St. Denis trad. du Grec.* (Paris, 1844, 8vo); and a translation by the abbé Dulac, announced in 1866, which we have not seen. An English version of the *Mystical Theology* is given in Everard's *Gospel Treasures* (Lond. 1658, sm. 8vo). See, besides the works on Dionysius already cited, Usher, *Dissert. II de Pseudo-Dionysii Scriptis*, ed. Wharton, in *Usher's Works* (16 vols. 8vo), xii, 497; Hakewill, *Dissertation on the Writings of Dion. Areop.*, in his *Apology of Providence* (8d edit. Lond. 1635, 8vo); Neander, *Church History* (Torrey's), iii, 169, 466; Lardner, *Works* (Kippis's ed.), v, 72

sq.; Ritter, *Geschichte d. christl. Philosophie*, ii, 515 sq.; Montet, *Des Livres du Pseudo-Denys* (Paris, 1848, 8vo); Ceillier, *Hist. Générale d. auteurs ecclés.* (Paris, 1861-1866), x, 584 sq. 751, where an abstract of Darbois's plea is given; Milman, *Latin Christianity*, bk. xiv, ch. ii. There is a good essay on the Dionysian writings, with a brief analysis of them, by B. F. Westcott, in the *Contemporary Review*, May, 1867.

Dionysius Alexandrinus, surnamed the Great, was born a heathen, but was converted early to Christianity by the teaching of Origen. He became a catechist about A.D. 233, and succeeded Heraclas in the bishopric of Alexandria about A.D. 247. His episcopate was full of troubles, as it continued during the persecutions of Decius and Valerian, and in it a pestilence ravaged the whole Roman empire, to say nothing of the disputes and controversies which at the same time greatly disturbed the peace of the Church. He was driven, with many of his flock, by the Decian persecution, into the deserts of Libya. In about a year's time, the persecution being abated, he returned to Alexandria, A.D. 251. In 257 the Valerian persecution began, and Dionysius was banished by Emilian, prefect of Egypt, to Cephro, in Libya, where he continued at least three years. Valerian having been taken prisoner by the Persians, the persecution was again stayed, and Dionysius returned to his flock at Alexandria, where he died about A.D. 265. Dionysius was a man of learning and piety. He took an active part in the controversies of the time; and from what remains of his *Epistles*, his moderation and spirit of conciliation are sufficiently apparent. A few fragments only remain of his works.

Dionysius finally refuted the Chiliastic doctrine, against which Origen had dealt so heavy blows. See MILLENNIUM. "An Egyptian bishop, Nepos, in a work called *ἄλληγορησίων*, insisted particularly on the literal interpretation of the Apocalypse, and the description of the Millennium therein contained. Owing, no doubt, to the persecution by Decius, this view was extensively adopted by the oppressed Christians, to whom it furnished strong motives of endurance. But this having ceased, Dionysius succeeded, by personal argument and his treatise *περὶ ἐπιγγελίων*, in expelling Chiliasm from the Eastern Church" (Gieseler, *Church History*, i, 62).

In refutation of the Sabellians, Dionysius wrote a letter to Ammonius and Euphanor (see the fragments in Athanasius, *de Sentent. Dionysii*) which seems to fix upon him the Origenistic doctrine of the subordination of the Son to the Father. "The Sabellians, though they denied the hypostasis, retained the idea of the *ὁμοούσιον*; this led Dionysius to describe the Logos as foreign to the Father in his essence, as his *ποίημα*, to speak of his having a beginning, and to make use of striking comparisons to express his subordination. As the Western Church had already developed with great distinctness the idea of unity of essence, Dionysius, bishop of Rome, took offence at these expressions as derogatory to the divine nature. Dionysius of Alexandria defended himself against these imputations in an apologetic letter (*ἔλεγχος καὶ ἀπολογία*, of which fragments are preserved; see Gieseler, *Ch. Hist.* vol. i, § 62). His moderation stayed the controversy: he blamed his accusers for having laid too much stress on comparisons, since in heavenly subjects it was not possible to use comparisons that were perfectly adequate. Ποιεῖν was used to express the bringing forth of beings of the same kind. He also acknowledged the sameness of nature, only he scrupled to use the term *ὁμοούσιον*, as he did not find it in Holy Writ. He had called the Son *γεννητός*, not in order to express an origination in time, but the derivation of his being from the Father—his eternity as founded in that of the Father. He marked the unity of essence thus: an *ἀρχή* from which everything else is derived, and with which the Logos is inseparably combined"

(Neander, *History of Dogmas*, Ryland's transl. i, 111; "The Arians even asserted (see Athanasius, *Opp.* 258) that Dionysius taught like themselves: *ὅτι ὁ ἦν ὁ θεὸς πατήρ, οὐκ αἶν ἦν ὁ υἱός· ἀλλ' ἂν μὲν ἦν χωρὶς τοῦ λόγου· αὐτὸς δὲ ὁ υἱὸς οὐκ ἦν πρὸν γένεσιν· ἀλλ' ἦν πρὸς ὅτι οὐκ ἦν, οὐ γὰρ αὐτὸς ἦν αὐτῷ ὑπέρτερον ἐπιγένετον* (comp., however, the expression quoted by Athanasius, p. 254, which go to prove a contrary). But the bishop of Rome insisted that Dionysius should adopt the phrase *ὁμοούσιον*, to which he at last consented, though he did not think it was founded either upon the language of Scripture or upon the terminology till then current in the Church. Orthodox theologians of later times (e.g. Athanasius), endeavoring to do more justice to Dionysius of Alexandria, maintained that he had used the aforesaid offensive illustrations *κατ' οἰκονομίαν*, so that they might be easily explained from the sense he took against Sabellianism (Athanasius, p. 246 sq.; see on the other side, Löffler, *Kleine Schriften*, i, 111a, quoted by Heinichen on *Euseb.* i, 306)" (Hagenbach, *History of Doctrines*, § 87). Dorner holds that Dionysius had really gone too far, and was bound to recede, but yet excuses him on the ground that "he was endowed with but a small measure of scientific exactness, and hence did not fully foresee the consequences of the principles he laid down. His tendency was very different from that of Arius" (Dorner, *Person of Christ*, Edinb. transl. div. i, vol. ii, p. 179). Ball, in the *Defensio Fid. Nicæm.*, defends Dionysius against the charge of Arianism in various passages, one of which we give, as follows: "Of the heads of doctrine which his adversaries objected against him before Dionysius Romanus, the following was one: 'God was not always a Father, the Son was not always, but God was some time without a Logos. The Son himself was not before he was born, or made, but there was a time when he was not. For he was not eternal, but was made afterwards.' Athanasius expressly saith that Dionysius defended himself from these accusations. Now it appears from this accusation that the proposition, there was a time when the Son was not, was by the Catholics held to be heterodox and absurd in the times of Dionysius. But how does Dionysius defend himself? By owning the charge? No. He professes that he did from his heart acknowledge, so as they had acknowledged, the co-eternity of the Son. For in the first book of his refutation and apology, he says, 'There was not a time when God was not a Father.' And some time after he writes thus concerning the Son of God: 'Since he is the effulgence of the eternal light, he himself is altogether eternal: for since the light is always, the effulgence, it is manifest, must also be always.' Again: 'God is an eternal light, without beginning or end; therefore an eternal effulgence is projected by him, co-exists with him without beginning, and always born.' And again: 'The Son alone is always co-existent with the Father, and is filled with the existent Being, and is himself existent from the Father.' There are places parallel to these in the epistle to Dionysius, which is now extant, to Paulus Samosatenus, and in his answer to Paul's questions set after the epistle. In the epistle he writes thus of Christ: 'There is one Christ, who is in the Father, the coeternal Word.' In his answer he thus introduces Christ speaking from the prophet Jeremy: 'I who always am the Christ subsisting personally, equal to the Father, in that I differ nothing from him in substance, coeternal also with the Almighty Spirit.' Here he confesses the entire, coequal, co-eternal trinity of persons. The same Dionysius blamed Paul because he would not call Christ the co-eternal character of God the Father's person. And in the same place he thus declares the eternity of the Son: 'As then we perceive, when one takes from one of the material fires, and neither affects nor divides it in the kindling one light from another, but the fire remains

comprehensibly is the eternal generation of Christ the Father.' Lastly, that this was his constant ion, which he always held, everywhere preached professed, he affirms in these words: 'I have writ- do write, confess, believe, and preach that Christ o-eternal with the Father, the only-begotten Son,

'Word of the Father.' Let Sandius brazen his head, and boast still that the great Dionysius Al- ndrinius was of Arius's mind." It was at the close Dionysius's life that the second council was con- ed at Antioch to condemn the heresy of Paul of nosata, and to the fathers of the council Dionysius t an epistle, in which he asserts, according to bish- Bull, the true divinity of the Son of God. See Eu- nus, *Hist. Eccles.* vi, 29, 85, 40, 46; vii, 20, 26, 28; l Lardner, *Credibility*, iii, 57-132, where most of the aining fragments are noticed, and many of them nslated. His remains are published separately: *era Dion. Alex. que supersunt*, Gr. and Lat. (Romæ, 6, fol.). They are given also in Galland, *Bibl. Patr.* 481; in Routh, *Reliq. Sacra*, vols. ii and iii; and Migne, *Patrologia Græca*, x, 1237 sq. A special rk on the life and writings of Dionysius has been itten by Dittrich (Roman Catholic), *Dionysius der osse von Alexandrien* (Freiburg, 1867). See Clarke, *cc. of Sac. Lit.* i, 176; Herzog, *Real-Encyclopædie*, 410; a full account in Ceillier, *Histoire Générale s auteurs ecclésiastiques*, ii, 396 sq.; Hefele's *Conci- ngeschichte*, i, 222 sq.; and Murdock's excellent note Mosheim, *Church History*, bk. i, cent. i, pt. ii, ch. ii, 7. A translation of the remains of Dionysius is omised in the *Ante-Nicene Christian Library*, now blishing (1868) at Edinburgh.

Dionysius, bishop of Corinth, A.D. 170, of whom tle now is known, appears to have been in consider- le repute in the days of Eusebius, for eight *epistles* hich he had written: 1, to the *Luacedemonians*; 2, to e *Athenians*; 3, to the believers of *Nicomedia*, the pital of Bithynia; 4, to the Church at *Gortyna*, and e other churches of Crete; 5, to the Church in *Amas- is*, together with those throughout Pontus; 6, to the *rossians*; 7, to the *Romans*; and 8, to *Chrysephora*, a nminent Christian matron. These are all lost except few fragments preserved by Eusebius, *Hist. Eccl.* iv, 3, and ii, 25. See extracts from these fragments in ardner, *Works* (ed. Kippis), ii, 144 sq. The *Frage- ta* are given in Galland's *Bibl. Patr.* i, 675, and in outh, *Reliquie Sacra* (Oxon. 1814), i, 163 sq. See abricius, *Bibliotheca Græca*, iv, 408; xii, 175 (ed. Iarles); Ceillier, *Hist. Gén. d. auteurs sacrés* (Paris, 865), i, 461.

Dionysius, bishop of Rome, was at first a presby- er of the Church of Rome, and afterwards, on the nartyrdom of Sixtus II (Eusebius, *Hist. Eccles.* vii, 7, 17), was chosen bishop of that see A.D. 259, which he held about ten years. He died A.D. 269. Dionysius Alexandrinus (q. v.) was accused before Dionysius of Rome of error as to the person of Christ in his letter o Ammonius and Euphranon, and a synod was called by the bishop of Rome to consider the matter, and an explanation was made by the bishop of Alexandria. The only fragment we have of the writings of Diony- sius Romanus relates to this matter; it is a letter to the African bishops, of which Athanasius preserves a large part in his *De Decret. Synod. Nic.* c. 26; compare also his *De Sententia Dionysii*, c. 13. It is given also in Migne, *Patrol. Latina*, tom. v. See Hefele, *Conci- liengeschichte*, i, 222; Dörner, *Doctrines of the Person of Christ*, Edinb. transl. ii, 182 sq.

Dionysius Exiguus ("the little"), a Scythian by birth (sixth century), studied at Rome, where he became a monk, and gained high repute by his knowl- edge of Scripture and of the Greek language. Cas- siodorus, who was intimate with him, wrote his pane- gyric in his *Institut. Dicin. Literarum*, ch. xxiii. He was a vehement and unscrupulous "upholder of the

see of Rome; he is suspected to have been guilty even of forgery in its support; he first published, and very probably *wrote* the Canons of the Council of Sardica, and collected the papal decretals from Siricius to An- astasius II" (Geddes, *Tracts*, ii, 419, cited in Clarke, *Succession of Sac. Lit.* ii, 807). These were published with his *Collection of Canons*, made at the request of Stephen, bishop of Salone, which contains the 50 first *Apost. Canons* (q. v.), the Canons of Nice, Constanti- nople, Chalcedon, Sardica, and 138 of Africa (ed. Justel- ius, Paris, 1628, 8vo; also given in *Biblioth. Jur. Ca- non.* i, 97). He also wrote a number of translations from Greek writers. But his fame rests (and justly) upon his *Cyclus Paschalis*, in which he introduced the name of Christ as the starting-point of computation, and gave birth to our "Christian æra," known also as the "Dionysian æra." It "was a great thought of the 'little monk' (whether so called from his humil- ity or from his small stature is unknown) to view Christ as the turning-point of the ages, and to intro- duce this view into chronology" (Schaff, *Hist. of Chr. Church*, ii, § 67). Dionysius lived to about A.D. 550. His writings are given in Migne, *Patrol. Lat.* vol. lxxvii. See Oudin, *De Scriptor. Eccl. Antig.* i, 1405 sq.; Schröckh, *Kirchengeschichte*, xvi, 175; Cave, *Hist. Lit.* (Geneva, 1720), i, 333; Ceillier, *Hist. Générale des au- teurs sacrés* (Paris, 1862), xi, 123; and arts. CANON; CANON LAW; CHRONOLOGY.

Dionysius the Carthusian (called also Dionys. of Ryckel, from his birthplace, or Dionys. of Lewis or Lewis, from his family name), was born at Ryckel, near Liege, Belgium, in 1403; studied at Cologne, and wrote in his 20th year a treatise *de ente et essentia*. At 21 (before which age the Carthusian rule would not admit him) he entered the monastery of Roermond, in Guelders, where he remained 49 years, till his death in 1471. His life was spent in diligent study, and in self-mortification of the strictest kind. His fame as a scholar gave him great influence both within and with- out the monastery, and obtained him the title of *Doc- tor Ecstaticus*. He wrote rapidly and voluminously: over 100 works are ascribed to him, among which are commentaries on Dionysius Areop., Thomas Aquinas, Peter Lombard, etc.; but the most important, perhaps, is *Enarrationes or Commentarii in Sacr. Script.*, a com- mentary on the whole Bible, 24 vols.; and also 10 vols. fol. Cologne, said to be carefully compiled from the fathers and ecclesiastical writers. See Fabricius, *Bibliotheca Lat.* vol. iv; Cave, *Hist. Lit.* (Genev. 1720), appendix, p. 108; Wetzter u. Welte, *Kirchen-Lexikon*, iii, 166; Schröckh, *Kirchengeschichte*, xxxiv, 117 sq.

Dionysus (Διόνυσος, 2 Macc. vi, 7; xiv, 38, "Bacchus;" in classical writers sometimes Διόνυσος, of uncertain derivation), also called BACCHUS (Βάκχος, "Iakchos, the noisy god; after the time of Herodotus), was properly the god of wine. He is represented as being the son of Jupiter and Semele. In Homer he appears simply as the "frenzied" god (*Il.* vi, 132), and yet "a joy to mortals" (*Il.* xiv, 325); but in later times the most varied attributes were centred in him as the source of the luxuriant fertility of nature, and the god of civilization, gladness, and inspiration. The Eastern wanderings of Dionysus are well known (Stra- bo, xv, 7, p. 687), but they do not seem to have left any special trace in Palestine (yet comp. Lucan, *de Syria Dea*, p. 886, ed. Bened.). His worship, how- ever, was greatly modified by the incorporation of Eastern elements, and assumed the twofold form of wild orgies and mystic rites. See DIONYSIA. To the Jews Dionysus would necessarily appear as the embodiment of paganism in its most material shape, sanctioning the most tumultuous passions and the worst excesses. Thus Tacitus (*Hist.* v, 5) rejects the tradition that the Jews worshipped Bacchus (*Liberum patrem*; compare Plutarch, *Quæst. Conv.* iv, 6), on the ground of the "entire diversity of their principles"

(*nequaquam congruentibus institutis*), though he interprets the difference to their discredit. The consciousness of the fundamental opposition of the God of Israel and Dionysus explains the punishment which Ptolemæus Philopator inflicted on the Jews (8 Macc. ii, 29), "branding them with the ivy-leaf of Dionysus" (this plant being sacred to him, Plutarch, *Idæ. et Osir.* 87; Ovid, *Fasti*, iii, 767), though Dionysus may have been the patron god of the Ptolemies (Grimm on the *Macc.*). It must have been from the same circumstance that Nicanor is said to have threatened to erect a temple of Dionysus upon the site of the Temple at Jerusalem (2 Macc. xiv, 38).—Smith, s. v. See Nicolai, *De ritu antiquo Bacchanali* (in Gronovii *Theaur.* vii); Moritz, *Mythology of the Gr. and Rom.* Eng. tr. p. 108; Smith, *Dict. of Class. Mythol.* s. v. Dionysus. Comp. BACCHUS.

Diopètēs (*διοπετής*, *Ioce-fallen*, "that fell down from Jupiter"), an epithet applied to the great image of Diana at Ephesus (Acts xix, 34). It is applied in the same way by heathen writers (e. g. *ἀγάλμα διοπετής*, Herodian. i, 11; compare Plutarch, *Numa*, 18; Eurip. *Iph.* 86–88; see Wetstein, *Kuinöl* in loc.). See DIANA.

Diocorin'thius (*Διοκορινθιος*, Vulg. *Diocorus*) occurs in 2 Macc. xi, 21, as the name of a Græco-Seleucid month. Inasmuch as *Dius* (*Διος*) is the name of a well-known Macedonian month (the first of the year), which Josephus (*Ant.* i, 8, 8) says corresponds with the Jewish *Marchevan*, the name has been regarded (see Wernsdorf, *De fide Maccab.* p. 32) as a corruption (through the form *Διόκουρος*) for that month (Scaliger, *Emend. Temp.* ii, 94), and by others as an intercalary month (but see Ideler, *Chronolog.* i, 399). See MONTH.

Diocōrus (*Διοκόρος*), bishop of Hermopolis, end of the 4th century, one of the four Nitrian solitaries (the three others being Ammonius, Eusebius, and Euthymius) known as "the tall brothers" on account of their stature. See TALL BROTHERS.

Diocorus, bishop of Alexandria († 454), who succeeded Cyril in that see, A.D. 444. Inferior to his predecessor in learning, he excelled him in ambition, energy, and bitterness. Eutyches (q. v.) taught that in Jesus Christ was but *one nature*, compounded of the divine and human natures; so that our Lord was not properly either God or man, but a sort of third being between the two. He was deposed for this heresy by a local synod of bishops at Constantinople, under Flavian, A.D. 448. Diocorus took his side, and induced Theodosius II to call a council at Ephesus (A.D. 449), which, under the direction of Diocorus, acted with the most savage violence against the defenders of orthodoxy, and restored Eutyches. This council has secured the enviable title of the "Robber Council." The fourth œcumenical Council of Chalcedon (A.D. 451) condemned Diocorus and Eutyches, and established the doctrine that in our Lord Jesus Christ there are two perfect and distinct natures, the Godhead and manhood, united in one person, without mixture, change, or confusion (see CHALCEDON; CHRISTOLOGY). At this Council of Chalcedon Diocorus was accused of gross vices as well as of heresy, was condemned, deposed, and banished to Gangra, Paphlagonia, where, in three years after, he died. See Landon, *Manual of Councils*, 120; Hefele, *Conciliengeschichte*, ii, 296 sq.; Dupin, *Eccles. Writers*, 5th century; Schaff, *Hist. of the Christian Church*, iii, § 140, 141; Neander, *Church History* (Torrey's transl.), ii, 500, 522; Millman, *Latin Christianity*, i, 286–316. See EPHESUS, ROBBER COUNCIL OF.

Diocorus, anti-pope, had been sent as legate by pope Hormisdas to Constantinople. He was chosen pope Oct. 15, 529 (on the death of Felix IV), by a number of bishops; but, about the same time, Boniface II was elected and sustained by Athalaric the Goth. Di-

oscorus died within a month of his election, Nov. 2, 529, and Boniface excommunicated him, even after his death—a sentence that was annulled afterwards by pope Agapetus.—Bower, *History of the Popes*, ii, E.

Dioscūri (*Διόσκουροι*, i. e. *Ioce's boys*, "Castor and Pollux," Acts xxviii, 11), the twin sons of Jupiter by Leda (Homer, *Hymn*, 17; Hygin. *Fab.* 77; according to Homer, *Odys.* xi, 297, the sons of Leda and Zeus dareus). They were chiefly invoked by the Greek Roman sailors as tutelary deities of mariners, and worshipped by propitiatory offerings (Theocritus i, xxii, 17; Catull. lxxviii, 65; Lucian, *Deor. dial.* xvi, 2). In the heavens they were twin stars, regarded as auspicious (comp. *σωτήρες*, Homer, *Hymn*, xxxiii, 6; Elian, *Var. Inst.* i, 30; "lucidum sidus," Diodor. Sic. iv, 43; Ovid, *Fasti*, v, 720). They were sometimes thought to appear in a delivering flame at the mouth-head during storms (Plutarch, *Placit. Philos.* ii, 2). Their image formed the "figure-head" of the Alexandrian vessel (giving name to it) in which Paul sailed from Melita to Rome (Acts xviii, 11). Compare Schaff, *See Scheffer, De milit. navali vet.* p. 372 sq.; Eschsch. *De tutelis et insignib. nav.* (L. B. 1771); Hasson, *Le navib. Alexand. apostolum in Ital. deferentibus* (Berz. 1716); Kunz, *De vexillo navis Alex.* (Jen. 1734). Comp. CASTOR (AND POLLUX).

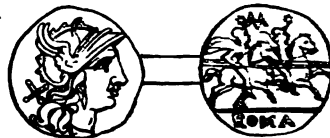

Coin with the Figure of the Dioscūri.

Diospōlis. See THEBES.

DIOSPOLIS, SYNOD OF (called by Augustine a "Council of Palestine," and which Jerome, in a letter to Augustine, calls *miserabilis Synodus Diospolitana*), a council of fourteen bishops held at Diospolis, the ancient Lydda, A.D. 415, to treat of charges of heresy brought by Heros, bishop of Arles, and Lazarus, of Aix against Pelagius. "Pelagius himself was present, but as Heros or Lazarus. Their memorial was read, containing many propositions of Pelagius; among them, the children dying without baptism are saved, and enjoy eternal life, although they do not enter the kingdom of heaven; that the grace of God is not necessary to the performance of each particular good work; that man's free will, with the law and Gospel doctrine, is sufficient; that grace is given according to our merit and depends upon man's will. Pelagius confessed some of the propositions attributed to him to be really his, but he denied the sense which his accusers put upon them, maintaining that they were capable of being understood in a sense agreeable to catholic truth" (Landon, *Manual of Councils*, 208). The synod acquitted Pelagius; but, as Augustine justly remarked of the decision, it was not "heresy that was acquitted, but the man who denied the heresy." See Schaff, *History of the Christian Church*, iii, § 148; Hefele, *Conciliengeschichte*, ii, 95 sq.

Diōt'rephēs (*Διοτρεφής*, *Ioce-nourished*), a person who seems to have been one of the false teachers condemned by the apostle John in his third epistle. A.D. cir. 90. He appears to have been a presbyter or deacon, probably the former. He refused to receive a former letter sent by John, thereby declining to submit to his directions or acknowledge his authority; moreover circulating malicious slanders against the apostle, and exercising an undue, arbitrary, and pernicious influence (*πλοσπρωτίων*) in the church (3 John 9, 10). See GALTUS. Neander suggests (*Pleading and Training*, ii, 73) that he may have been of an ultra-Pauline party, the forerunner of Marcion (q. v.).

Diphath. See RIPHATH.

Diplōma (Lat. *diploma*; Greek *δίπλωμα*, from *λῶσσαι*, to fold together), a name given to writings or documents conferring certain honors or privileges. Roman emperors were in the habit of giving charters or donations written on two leaves or tablets of wax or copper, folded together; hence the name *diploma*.

The term is now mostly applied to instruments or by universities and other learned societies, in favor of the holder having attained a certain degree, or to the licenses held by professional persons to practice their art.—*Encyclop. Metropolitana*, s. v; *Chambers, Encyclopaedia*, s. v.

Diplomatics, the science of deciphering ancient documents, and describing their origin, date, history, &c. It first took scientific shape in Mabillon's *Re Diplomatice*, 1681. See Brande, *Dictionary of Science and Art* (Lond. 1865), i, 689.

Dippel, JOHANN CONRAD, called the *Christian Moccrist*, was born Aug. 10, 1673, at Frankenstein, near Darmstadt, studied at the University of Giessen, and became professor there. His vanity, and his desire to be considered as a "reformer of theology," led him into excesses which cost him his situation, and he came a sort of literary adventurer. He was at first violent opponent of Pietism, afterwards lectured on iromancy and astrology, and in 1697 appeared in Darmstadt in the character of an alchemist and Pietist. Driven away as an impostor from Darmstadt in 1704, he fled from Berlin in 1707, we find him practicing medicine in Holland, where some cures performed by his "universal medicine" (Dippel's oil) gained him a great reputation. Obligated to flee on account of debt, he went to Altona, and was imprisoned at Bornholm from 1719 to 1725. After his liberation, he went as a physician to Sweden in 1727, but left it in December, 1737, on account of his attacks against the Church and its institutions of the country. He was afterwards known in Hesse and the Rhenish provinces as adept, uack, and herald of the "interior light," which he sought to substitute for Christianity. In theology, Dippel "attacked in particular the doctrine of the atonement of Christ, and of justification by faith. Redemption takes place through Christ in us without external means. There is no anger in God; an atonement is therefore not necessary. As Christ did not assume his humanity out of Paradise, but out of the weakened substance of fallen man, he was under the necessity, on his own account, of going through the narrow gate of self-denial to glory; not in our place, but for our good, did Christ set an example of his holy life. The Word of God, in his view, is not in Christ alone. It is an immediate efflux from the mouth of God, which communicates itself to the hearts of all men, even without the Scriptures: in every man there is a divine seed, or efflux of the divine nature. After the Fall, however, there was in man the seed of the serpent, which totally concealed the Word of God implanted in us. To the end of awakening and ripening this seed of God, the eternal Word of God was compelled to assume a luciferic body in heaven, by whose means the flesh assumed in Mary was tinged and deified, and the seed of the serpent in his flesh was killed by his sufferings and death. Through both, however, a universal tincture was prepared, through which the seed of God is awakened in us, and we are clothed with a new luciferic body for our deification. This, however, we do not receive through external means of grace. In true Christianity nothing takes place mediately: it is God's will to speak directly to our heart by inspiration; it is Christ's will to begin his process again in us, in each one separately" (Dorner, *Hist. of the Doctrine of the Person of Christ*, Edinb. transl., div. ii, vol. ii, p. 876). He died April 25, 1784, in Wittgenstein Castle. His adherents were called Dippelians (*Dippelians*). He wrote several hymns; among them the penitential hymn "*O Jesu, sieh darein*."

Under the name of *Christianus Democritus* he wrote, *Orthodoxia orthodoxorum* (1697);—*Papismus protestantium vapulans* (1698);—*Fatum fatuum* (Amst. 1710);—*Glanz des Evangeliums Jesu Christi* (Stockh. 1827);—*Der Regentenpiegel, ein lateinisches Gedicht*;—*Personalia* (an autobiography, no date). His writings were collected under the title *Eröffneter Weg zum Frieden m. Gott u. allen Creaturen* (Amsterd. 1709; new collection 1748, 8 vols.);—*Ackermann, Lebensbeschreibung* (Leips. 1781); *Hoffmann, Lebensbeschreibung* (Darmst. 1788); *Kahnis, German Protestantism*, p. 126; *Schröckh, Kirchengeschichte*, pt. ii, viii, 308 sq.; *Herzog, Real-Encykl.* iii, 42.

Diptychs, Church registers, so called because they were originally *tablets folded in two leaves* (*δίπτυχα*), wherein, among the early Christians, were recorded the names of bishops and other brethren, whether deceased or living, who were entitled to have their names mentioned in the celebration of the Liturgy from having rendered any signal service to the Church. When a member of the Church was excommunicated, his name was erased from the diptychs. They are still in use in the Greek Church.

The *diptych* of antiquity consisted of two tablets of wood, ivory, or other substance, which folded together, and contained a coating of wax on the interior. On this wax were written at first private letters. In this case the diptych was bound with a cord, and sealed with wax. Later, the emperors, consuls, and other magistrates, to celebrate their elevation to office, sent diptychs to their friends, containing on the exterior of the tablets an engraving of their portrait, or of some circumstance connected with their official promotion. They were also employed as public registers. The sacred diptychs contained on one side names of the living, on the other of the dead, which were rehearsed during sacrifices. When Christianity became triumphant, diptychs were used to contain sculptures of religious subjects and scenes. Even the poorest traveller or pilgrim used them to hold the images of sacred persons, before which he bowed in prayer several times a day. In Christian art, a diptych is an altarpainting in two pieces, which may be folded together, and which contain paintings on both the interior and exterior surfaces.—*Siegel, Christl.-kirchliche Alterthümer*, iii, 259; *Bingham, Orig. Eccles.* x, 2, 6, and xv, 8, 17; *Jamieson, History of our Lord in Art*, i, 21.

Director of the Conscience (or *spiritual director*), a title often given in the Roman Church to the priest acting as confessor, with power of absolution.

Directory, I. a set of rules for worship and ordination, drawn up to take the place of the Liturgy, or Book of Common Prayer, by the Westminster Assembly of Divines. The Directory was framed in 1648, ratified by Parliament Jan. 8, 1644, and adopted by the Scottish General Assembly in 1645. In the Act of 1844, it is entitled a *Directory for the Public Worship of God throughout the three Kingdoms of England, Scotland, and Ireland*. The same ordinance repealed the acts of Edward VI and Elizabeth, by which the Liturgy was established, and forbade the use of it within any church, chapel, or place of public worship in England or Wales, appointing the use of the Directory in its stead. This ordinance, indeed, never received the royal assent, and it was a long time before it succeeded in abolishing the established worship. In some parts the Directory could not be procured, in others it was rejected; some ministers would not read any form, others read one of their own. The Parliament, therefore, in the ensuing summer, called in all the *Books of Common Prayer*, and imposed a fine upon such ministers as should read any other form than that imposed by the Directory. The penalty for reading the Liturgy was £5 for the first offence, £10 for the second, and a year's imprisonment for the third; for non-observance of the Directory, 40s. Any one who should

preach, write, or print anything in derogation of the Directory was to forfeit not less than £5, nor more than £50, to the poor. All *Common Prayer-books* remaining in parish churches or chapels were ordered to be carried to the committee of the several counties within a month, there to be disposed of as the Parliament should direct (Rushworth, *Hist. Coll.* p. iv, i, 295, cited in *Eadie, Eccles. Cyclopaedia* s. v.).

The Directory prescribes no form of prayer, nor any responses on the part of the people, except *Amen*. It enjoins that "the people shall enter the churches reverently, and in a grave and becoming manner, without adoration, or bowing towards one place or another; that the minister is to begin with prayer, to which all present are to give due attention, and to abstain from all private conferences or salutations; that the reading of the Scriptures in the congregation, which is a part of the worship of God, be performed by the pastors and teachers; that all the canonical books of the Old and New Testament, but none of those called apocryphal, be publicly read in the vulgar tongue, and in the best allowed translation; that the portion to be read at once be left to the minister, but that commonly one chapter of each Testament be read at every meeting; that all the canonical books be read over in order, that the people may be the better acquainted with the Scriptures; that when the minister shall judge it necessary to expound any part of what is read, he is not to begin his exposition till the whole chapter or psalm be ended, and that after reading the Scripture and singing the psalm, the minister who preaches is to begin with prayer. It then prescribes heads for the prayer; enjoins that the subject of the sermon be a text of Scripture, which teaches some principle or head of religion, or is otherwise suitable to the occasion; and recommends that the introduction to the text be brief and perspicuous, and drawn from the words or context, or from some parallel passage of Scripture. In dividing the text, the minister is to regard the order of the matter rather than that of the words; he is not to burden the memory of his hearers with too many divisions, nor perplex their understandings with logical phrases and terms of art; he is chiefly to insist on those doctrines which are principally intended, and most likely to edify his hearers; he is not to propose nor answer any unnecessary objections, but to confute error, and satisfy the judgments of his audience; and he is to be very sparing in quotations from ecclesiastical or other human writers, ancient or modern, etc. The Directory recommends the use of the Lord's Prayer as a perfect model of devotion. It forbids private or lay persons to administer baptism, and enjoins it to be performed in the face of the congregation. It orders that the communion-table at the Lord's Supper be so conveniently placed that the communicants may sit about it. It enjoins that the Sabbath be observed with the greatest strictness, both in public and private; that marriage be solemnized by a lawful minister of the word, who is to give counsel to, and pray for the parties; that the minister teach the people not only in public, but in private; that the sick be visited by the minister, under whose charge they are, and who shall administer spiritual good to their souls; that the dead be buried without any prayers or religious ceremonies; that days of fasting be observed when the judgments of God are abroad in the world, or when some important blessings are desired; that days of thanksgiving for mercies received be also kept; and, lastly, that as it is the duty of Christians to praise God publicly, the whole congregation join together in singing psalms. In an *Appendix* it is enjoined that all festivals, vulgarly called holy days, be abolished, and that no day be observed except the Lord's day; and that, as no place is capable of any holiness under pretence of consecration, or subject to pollution by any superstition formerly employed, the places of worship now used be still continued."

This Directory, which is still partly, but by no means strictly, adhered to by Presbyterians in the British Islands, is given in full in Neal, *History of the Puritans*, appendix viii; see also Collier, *Church History of England*, viii, 287 sq.

II. The Presbyterian Church in the United States has a *Directory for Worship*, in fifteen chapters, which was amended and ratified by the General Assembly in 1821, and may be found appended to *The Constitution of the Presbyterian Church* (Philadelphia, Presbyterian Board).

III. In the Roman Catholic Church an annual Directory (*Directorium*) for the clergy is published, which gives rules of ceremonial according to the calendar of the year, as settled by the bishop of the diocese. The Ritualists in England have imitated this in their so-called *Directorium Anglicanum*.

Dirge, a funeral hymn, derived from the *Lat. Dirige*, the first word of the first antiphon in the office called *Officium Defunctorum*, which is *Dirige, Domine Deus meus, in conspectu tuo, viam meam*.—*Protreptic Common Prayer*, part ii, ch. v, § 5; *Rituaire Romain, Officium Defuncti, ad Matut. Antiphona*.

Discalceati, or Barefooted Monks and Nuns, is the generic name of several religious orders whose members wear only sandals of leather, without knitting-work. The Franciscans have particularly been designated by that name. The different orders are, 1. The barefooted monks of *St. Augustine*, founded at Talavera by command of Philip II, and which afterwards spread throughout France and the East and West India. 2. The barefooted nuns of *St. Augustine*, established in 1689 by a Spanish maid of honor, Francisca Grillo, in the convent of the Visitation at Madrid. 3. The barefooted *Ladies of Mercy* for the liberation of prisoners, established at Biso and Amara, Spain, in 1604, by Peter John of Baptista. 4. The barefooted *Carmelites*, male and female (barefooted monks of the Cross, at Avila), founded in 1562 by Teresa, and soon spread over the whole of Spain, Portugal, France, Italy, Germany, and India. A part of these, not belonging to Spain, are called Congregations of the barefooted *Carmelites of St. Elias*. 5. The barefooted *Trinitarians*, established at Val de Peñas in 1596, by John Baptiste de la Conception; their dress white, with a red or blue cross, and a brown cloak and hood; in the choir they wear over this a scarlet cloak. This order spread over Spain, France, Germany, Poland, Hungary, Bohemia, and Italy. 6. The barefooted *Minorites* (Minorites of the *Rigid Observance* in Spain; Minorites *capucins*, evangelical brethren), established in 1494 by John of Guadaloupe, in the province of Granada. After many difficulties with the popes, etc. they in 1517 took the name of the *Reformed Observance*, and established twelve provinces in Spain, Portugal, India, and America. 7. The *Profects Minorites of France* (les Recollets), established in 1592 by the Count de Nevers, who soon established twelve provinces in France, Flanders, and Canada. 8. The Minorites of *St. Peter of Alcantara*, established by him in 1540 at Placencia: they adhere to the strict rules of the Anachorets. The order is yet very numerous in Italy. 9. Minorites of *Hieronymus of Lazara*, established by him in 1545, but suppressed in 1562. 10. *Minorites Capuchins* (see CAPUCHINS). 11. Minorites of *John of Puebla*, founded by him in 1489 in the Sierra Morena: in the 16th century they were formally incorporated in the order of the Regular Observance. 12. Soccolanti (Cordeliers); see Minorites of the Observance. 13. Minorites *Celestines* (poor hermits Celestins), established in 1294 by some Minorites returned from a mission in Armenia. After the death of pope Celestin V they fell into disgrace, and were driven to Greece; returning finally to Apulia, they were persecuted as heretics and schismatics by the Inquisition. Many fled to France, where, with Tuscan and French

horites, they founded the Congregation of Narbonne, the Spiritual Congregation, which were suppressed 318 by the Inquisition, part of them being put to th, and the others imprisoned for life. 14. Sisters he Ave Maria. 15. Female Capuchins. 16. Clariss of the Stricter Observance, established at Albano 1631 by Francisca of Jesus Maria, and whose rule adopted in some Italian convents. 17. Female horites of St. Peter of Alcantara, established in 1676 Ja Fassa by cardinal Francis Barberini, are found y in Italy. 18. Barefooted brethren and sisters of 3d order of St. Francis (gli Scalzi), in Sicily, Daltia, Istria, etc.; established in 1540 by Jacob of gubio, in the convent of La Tropa. They extended idly, but were in 1602 united to the Congregation the 3d order of Lombards. 19. Nuns of the 3d or: of St. Francis of the Stricter Observance in France; Picpus), established in 1598 by Vincent Mussart Franconville, and endowed with the convent of pus, at Paris, in 1601. They devoted themselves to irection and management of hospitals; abolished 1789, they were reorganized by the abbé Coudrin in 14, sanctioned by pope Pius VII, and in 1838 were pointed to the missions in the islands of the Pacific. . Recollect nuns of the 3d order of St. Francis, found- in 1638 at Limburg by Johanna van Neerich, who ve them very rigid rules: they were abolished in 89. 21. Hospitalers of the 3d order of St. Francis linims, etc.), established at Madrid in 1567 by Bernrd of Obregon: they were widely disseminated in rtugal, Spain, and the Netherlands, and have but tely disappeared. 22. Female Choristers of Noli, 3d der of St. Francis, established by count Nicholas of raimi and Spoleto in 1354 for his own choristers: ess, gray, with a white belt, streamer, and gray il; the latter black on feast days. 23. Hermits of onte Luco, founded in 1012: they count only a few chorites at Spoleto in Umbria. 24. Hermits of St. hn the Baptist, established in the bishoprics of Metz, mbrai, and Bellai in 1630 by Michael of Sabina: ey soon numbered 100, but disappeared in 1789. 25. enerally, all the congregations of regular Anchorites, nd of the Minorites of the Observance.—Pierer, s. v. arfürserrmönche.

Discerning OF SPIRITS (*διακρίσις πνευμάτων*, *discrimination of spirits*, 1 Cor. xii, 10). This expression is now usually understood to mean a high faculty, njoyed by certain persons in the apostolic age, of in- utively probing the heart and distinguishing the se- ret dispositions of men (compare 1 Cor. xiv, 29; 1 ohn v, 1). It appears to have been one of the gifts ecular to that age, and was especially necessary at time when the standards of doctrine were not well established or generally understood, and when many leivers were abroad (2 John ii, 7). This faculty of upernatural insight seems to have been exercised hiefly upon those who came forward as teachers of thers, and whose real designs it was important that he infant churches should know. Authentic instances, however, do not appear to show the method of its ex- ercise, although the cases of Ananias and Sapphira (Acts v, 6, 9), of Simon Magus (viii, 21), and of Ely- mas (xiii, 9), are cases in point. See GIFTS, SPIRIT- UAL.

Disciple (Lat. *discipulus*, a scholar, from *discere*, to learn: Matt. x, 24), one who professes to have learned certain principles from another, and maintains them on that other's authority. In the New Testa- ment it is applied principally to the followers of Christ; sometimes to those of John the Baptist, Matt. ix, 14; and of the Pharisees, Matt. xxii, 16. It is used in a special manner to point out the twelve, Matt. x, 1; xi, 1; xx, 17. A disciple of Christ may now be defined as one who believes his doctrine, rests upon his sacrifice, imbibes his spirit, and imitates his example (Farrar, *Bibl. and Theol. Dict.* s. v.). "There are three

senses in which men are sometimes called 'disciples' of any other person: (1.) *Incorrectly*, from their simply maintaining something that he maintains, without any profession or proof of its being *derived* from him. Thus Augustine was a predestinarian, and so was Moham- med, yet no one supposes that the one derived his be- lief from the other. It is very common, however, to say of another that he is an Arian, Athanasian, Socin- ian, etc. which tends to mislead, unless it is admitted, or can be proved, that he learned his opinions from this or that master. (2.) When certain persons *avow* that they have *adopted* the views of another, not, how- ever, on his authority, but from holding them to be agreeable to reason or to Scripture, as the Platonic, and most other philosophical sects—the Lutherans, Zuinglians, etc. (3.) When, like the disciples of Je- sus, and, as it is said, of the Pythagoreans, and the ad- herents of certain churches, they profess to receive their system *on the authority* of their master or Church, to acquiesce in an 'ipse-dixit,' or to receive all that the Church receives. These three senses should be carefully kept distinct."—Eden, *Churchman's Diction- ary*, s. v.

Disciples of Christ, or, as they prefer to call themselves, "The Church of Christ," a body of Bap- tists sometimes called by their opponents "Campbell- ites," assumed a distinct ecclesiastical organization about the year 1827. In 1808 Thomas Campbell mi- grated from Ireland, and settled in Western Pennsylv- ania as a minister of the "Seceders." He was a con- scientious advocate of religious reform, and contended for a restoration of the Christian Church to apostolic practice and precept. See CAMPBELL, THOMAS. In 1809 he was joined by his son Alexander, who heartily sympathized with him in his views of religious reform. See CAMPBELL, ALEXANDER. The first practical movement was to form a small association of disciples for the special study of the Scriptures, with the pledge that, rejecting all creeds and confessions of faith, they would strictly conform their practice to the teachings of the divine Word. This was a practical separation from the "Seceders," and resulted in the organization of a small congregation in Washington County, Pa., known as the Brush Run Church, Sept. 10, 1810. Thomas Campbell was one of the original elders of this con- gregation, and by it his son Alexander was first or- dained to the ministry. It was not long till the ques- tion of baptism engaged their attention, and, after a thorough investigation among themselves, the father and son, with five others, reached the conclusion that the Scriptures taught the "immersion of believers." Accordingly, on the 2d of June, 1812, they were im- mersed by a Baptist minister. In 1815 they had in- creased to some five or six congregations, when they attached themselves to the Redstone (Baptist) Associa- tion, stipulating, however, in writing, that no "terms of union or communion other than the Holy Scriptures should be required." To many of the Baptist preachers this union was distasteful from the first, and it finally resulted in the withdrawal of these congrega- tions, who then joined the Mahoning (Ohio) Associa- tion, which more nearly accorded with them, and which finally became thoroughly identified with the movement.

In 1828 Alexander Campbell established the "Chri- stian Baptist." Through this monthly, and several public oral debates on baptism, and extensive tours of preaching, his views spread rapidly and widely among the Baptists. But personal opposition at last took the form of ecclesiastical action, and in 1827 the Dover Association of Virginia decreed the excommunication from Baptist fellowship of all who held and advocated the views of Alexander Campbell. This was the be- ginning of a general action among the Baptists; and the Reformers, as they were called, were compelled to associate in a separate organization, which rapidly in- creased, especially in Kentucky, Ohio, Indiana, Illinois,

Missouri, and Virginia. Churches were also formed in the British Provinces of North America, in England, Wales, Ireland, and Australia. They are increasing in all these countries, and in England are rapidly becoming numerous.

II. *Principles and Practice.*—The Disciples profess to reject all creeds and confessions of faith as of human origin and divisive in their influence, and to take the Holy Scriptures, and these alone, as the only authority in faith and practice binding upon Christians. "Faith in the testimony of God, and obedience to the commandments of Christ, are the only bond of union." The subtle speculations of theology are not to be forced upon the faith or conscience of Christians, and Bible themes are to be presented in Bible terms. For objecting to many of the terms of theology, such as "trinity," "eternally begotten," co-essential, and "consubstantial," they have been by some charged with being "Unitarians." But on this subject there is now perhaps no respectable doubt of their entire "orthodoxy." They break the loaf, in commemoration of the sacrifice of the Saviour, every first day of the week. This practice, they contend, has the warrant of apostolic example, and is therefore of divine obligation. It is claimed that it was the chief object of the meetings of the first Christians on the Lord's day, and its peculiar sanctification. They hold that faith and repentance are the divinely-appointed antecedents to baptism, and that it is the privilege and the duty of the Christian minister to say to all who believe and repent, "Be immersed, every one of you, in the name of the Lord Jesus Christ, for the remission of sins, and you shall receive the gift of the Holy Spirit." They are congregational in their organization, and recognise three classes of officers: 1, elders, presbyters, or bishops; 2, deacons; 3, evangelists. These last constitute the itinerating ministry or the missionaries of the Church, and are supported by voluntary contributions. The Disciples acknowledge the obligation to provide for the preaching of the Gospel to be of the highest kind, and are very active in evangelical labor. In questions of speculative opinion they allow the widest differences, but contend earnestly for the unity of a practical acknowledgment of one faith, one Lord, one immersion, one hope, one body, one spirit, one God and Father of all. On the subjects of the atonement, the resurrection, and the future judgment, they hold the common faith of evangelical Christians.

III. The Disciples are now estimated as about 500,000 in numbers. They are distinguished for their interest in education, and have a large number of academies and seminaries, and several colleges of high standing. Among these the most prominent are Bethany College, founded by A. Campbell, and presided over by him until his death; Kentucky University, and the North-western Christian University, at Indianapolis; Eureka College, Illinois, and Hiram College, Ohio. They have 25 periodicals, viz. 9 weeklies, 15 monthlies, and 1 quarterly. Of these, two (monthlies) are published, one in Great Britain and one in Canada; all the rest in the United States. The most representative of the latter are The Millennial Harbinger (monthly), Bethany; M. E. Lard's Quarterly, Lexington, Ky.; The Review, Cincinnati, Ohio, and The Standard, Cleveland, Ohio (weeklies).

Literature.—1. The writings of Alexander Campbell (see art.); 2. The Christian Baptist, 7 vols.; 3. The Millennial Harbinger, 38 vols.; 4. Jeter, *Campbellism Examined* (N. Y. 12mo), and Lard's *Review of Jeter*; 5. McGarvey's *Commentary on Acts*; 6. Milligan, *Faith and Reason*; 7. Lamar, *Interpretation*; 8. *Christian Review*, Jan. 1855; and 1856, p. 480; *Princeton Review*, 1845, p. 183; *American Bib. Repository*, 2d series, i, 94, 295; iii, 203.

Disciples of John. See CHRISTIANS OF ST. JOHN.

Discipline (Lat. *disciplina*, instruction, law) a term used ecclesiastically to denote the application in the Christian Church, of rules for the purity of the lives of its members; also the best rules for the government, worship, etc. of any particular Church, enacted by its authority, and generally published in a "Book of Discipline."

I. *Church Discipline.*—(1.) In the Early Church, the first rule of discipline in the N. T. is given in Matt. xviii, 15-17: "Moreover, if thy brother shall trespass against thee, go and tell him his fault between thee and him alone; if he shall hear thee, thou hast gained thy brother. But if he will not hear thee, thou shalt go with thee one or two more, that in the mouth of two or three witnesses every word may be established. And if he shall neglect to hear them, tell it unto the Church; but if he neglect to hear the Church, let him be unto thee as a heathen man and a publican." The aims are (1) the reformation of the offender; (2) that failing, (2) the purification of the Church. The method is, (a) that the offended person take the first step, and, that failing, (b) a small Church conference; and, in case of their failure, (c) the Church called in, and the obstinate offender is cut off from fellowship.

The apostolic discipline is illustrated by the case of the incestuous person (1 Cor. v, 1-11). Here he excommunicates the offender, (1) verse 3, stating his own judgment concerning the offence and its perpetrator; (2) verse 4, stating that he acts "in the name of our Lord Jesus Christ;" and, (3) associating himself the whole body of the Corinthian Church, acting also "with the power of our Lord Jesus Christ" (Compare De Wette and Stanley, in loc.; See *Apostolic Church*, § 122; Coleman, *Apostolic and Primitive Church*, chap. v). In verse 12 he implies that "judgment" lies with the Church, "Do not receive them that are within?" He enjoins strict separation from immoral professors of religion: verse 11, "now I have written unto you not to keep company with any man that is called a brother but a fornicator, covetous, or an idolater, or a railer, or a drunkard, or an extortioner: with such a one no not to eat." In the case of the incestuous person the exercise of discipline brought penitence; and the apostle (1 Cor. ii) exhorts the Church to "forgive and comfort him, and restore him to fellowship. On the apostolic discipline, both as to doctrine and morals, compare also 2 Thess. iii, 6; 1 Tim. i, 20; 2 John 9-11. "He that abideth in the doctrine of Christ, he loveth both the Father and the Son. If there come any unto you, and bring not this doctrine, receive him not into your house, neither bid him God speed, but he that biddeth him God speed is partaker of his evil deeds." The exercise of discipline (1) by reproof; (2) by censure, (3) by excommunication, was kept in the hands of the Church as a whole (not of any special class or order in the Church), during its earliest and best ages. See a summing up of the evidence on this point in Coleman, *Apostolic and Primitive Church*, chap. v. "The primitive Church never pretended to exercise discipline upon any but such as were within her pale, in the largest sense, by some act of their own profession, and even upon these she never pretended to exercise her discipline so far as to cancel or annul their baptism. But the discipline of the Church consisted in a power to deprive men of the benefits of external communion, such as public prayer, receiving the Eucharist, and other acts of divine worship. This power, before the establishment of the Church by human laws, was a mere spiritual authority, or, as St. Cyprian terms it, a spiritual sword, affecting the soul and not the body" (Hook, *Church Dictionary*, s. v.). On the so-called *secret discipline* of the ancient Church see ARCANI DISCIPLINA.

As to the exercise of discipline, it seems clear that the action of the laity was requisite, as late as the end

of the third century, in all disciplinary proceedings of the Church. By the beginning of the fourth century, however, this cardinal right, through the operation of causes which have been briefly mentioned, and which may be more fully specified hereafter, was greatly narrowed, and shortly was wholly lost. This fact rates the progress of the ecclesiastical hierarchy.

While the right of the laity is yet undisputed, the power of the bishop begins at first to be partially lost and occasionally admitted, the people occupying a neutral position between submission and open hostility. But from disuse to denial, and from denial to extinction of neglected privileges and powers, the process is natural, short, and rapid. From about the middle of the fourth century, accordingly, the bishops resumed the control of the whole penal jurisdiction of the laity, opening and shutting at pleasure the doors of the Church, inflicting sentence of excommunication, prescribing at their discretion the austerities of penance, and again absolving the penitents, and sending them to the Church by their own arbitrary measures. The people accordingly, no longer having any part in the trial of offences, ceased to watch for purity of the Church, connived at offences, and regarded the offender, not caring to interfere with the negative of the bishop, in which they had no further interest. The speedy and sad corruption of the Church but the natural consequence of this loose and arbitrary discipline. Nor was it to be doubted that this one efficient cause of that degeneracy which succeeded" (Coleman, *Apostolical and Primitive Church*, p. v). "This transition changed essentially the relations of the officers to the members of the Church, the conditions of Church membership. The office of the Church, instead of receiving authority and power from that body for their service, claim authority and commission from God for the exercise of their functions. They are now the rulers, not the servants, at the beginning they were, of the Church. As men with the Church by a public profession is a sanction not so much between the Church and the professing Christian, as between him and the people. The contracting, covenanting parties are the people and the believer. The sovereign authority of the Church is merged and lost in that of the priesthood. Ecclesiastical discipline naturally resolves itself into a system of penance administered by the laity, in whom alone authority is vested for the punishment of offences" (Coleman, *Ancient Christianity*, chap. xxii).

I. *In the Middle Ages, and in the Roman Church*, the term of *penitential discipline*, for the treatment of those confessing their sin, grew up into full proportions. See PENANCE; PENITENTIAL DISCIPLINE. In the Roman Church, and among some Protestant writers, the word discipline, standing alone, implies only penitential, and not punitive discipline.

II. *In the Modern Church*.—The exercise of punitive discipline in the modern Church is found to be possible, or nearly so, in state churches. In the Church of England, and the Protestant state churches of the Continent of Europe, it is almost unknown. Here citizens, as such, are *ipso facto* Church members, to punish the Church member is to affect a man's citizenship.

On the other hand, in Free churches, whether in Europe or America, discipline by reproof, censure, suspension, or excommunication is not only possible, but is actually practiced very generally. The following passage contains principles on which the Free Protestant churches of modern Christendom generally act with regard to discipline.

"Godly discipline has ever been regarded as one of the notes or marks of a true Church. Our Protestant fathers charged the Church of Rome with being greatly wanting in this, and scarce deserving the name of Church by reason of such want. Discipline relates

to the laws of any society, and the penalties of disobedience. All institutions must have laws in order to good government. Christ's kingdom has its laws and penalties. Many of them were expressly appointed by Christ himself. Others, in conformity with the same, have from time to time been added by the Church. To obey the powers ordained of God, whether civil or ecclesiastical, when exercised according to his revealed will, is a bounden duty. Ministers, at the time of their ordination, promise faithful obedience to those who are placed over them, and who exercise their authority according to proscribed rules. A due respect also is required to their godly admonitions and judgments. This obedience and respect are to be shown not merely to those with whom we may agree in sentiment or sympathize in theological views, but to those also from whom we differ; and this may be done without any improper sacrifice of Christian liberty or right of private judgment. As to the rules and regulations of the Church, whether the observance be specially required by rulers or not, the true Christian will hold himself bound to render it. He will not select such of them as he most approves, or as most accord with his doctrines, and scrupulously observe these, making such observance a test, and denouncing those who differ from him; but he will resolve to obey them all, out of respect to the authority enjoining them. And yet, since God himself, preferring mercy to sacrifice, allows even his holy Sabbath to be violated as to its letter, and sacrifices and offerings to be withheld, so a wise discretion has ever been conceded to God's ministers in the observance of inferior rules, or in regard to things become obsolete, having due reference to times, places, and circumstances. Wherever such discretion has not been allowed or exercised, the result has been that men have strained at the gnat and swallowed the camel; have tithed mint, anise, and cummin, and neglected the weightier matters of the law. It should always be remembered that, as the Sabbath was made for man, and not man for the Sabbath, so rubrics and canons were made for the Church, and not the Church for them" (Bishop Meade, *True Churchman*).

In Presbyterian churches, discipline is exercised by the Session (q. v.), an appeal lying to the Presbytery, and thence to Synod and General Assembly. In the "Form of Government" of the Presbyterian Church in the United States of America (book ii), the general principles of discipline are laid down as follows: "I. Discipline is the exercise of that authority and the application of that system of laws which the Lord Jesus Christ has appointed in his Church. II. The exercise of discipline is highly important and necessary. Its ends are, the removal of offences; the vindication of the honor of Christ; the promotion of the purity and general edification of the Church; and also the benefit of the offender himself. III. An offence is anything in the principles or practice of a Church member which is contrary to the word of God, or which, if it be not in its own nature sinful, may tempt others to sin, or mar their spiritual edification. IV. Nothing, therefore, ought to be considered by any judicatory as an offence, or admitted as matter of accusation, which cannot be proved to be such from Scripture, or from the regulations and practice of the Church, founded on Scripture, and which does not involve those evils which discipline is intended to prevent. V. The exercise of discipline in such a manner as to edify the Church requires not only much of the spirit of piety, but also much prudence and discretion. It becomes the rulers of the Church, therefore, to take into view all the circumstances which may give a different character to conduct, and render it more or less offensive; and which may, of course, require a very different mode of proceeding in similar cases, at different times, for the attainment of the same end. VI. All baptized persons are members of the Church, are under its care,

and subject to its government and discipline; and when they have arrived at the years of discretion, they are bound to perform all the duties of Church members. VII. Offences are either private or public, to each of which appropriate modes of proceeding belong."

In Congregational churches, discipline is administered by the Church. For the principles and methods of Congregational discipline, see Punchard, *View of Congregationalism* (1844), 177 sq.; Dexter, *On Congregationalism* (1865), 259 sq.

In the Methodist Episcopal Church an accused member is brought to trial before a committee of not less than five, who shall not be members of the Quarterly Conference. In the selection of the committee, the parties may challenge for cause. The pastor presides at the trial. If the majority find him guilty, the pastor executes the sentence of expulsion. Appeals are allowed to the Quarterly and Annual Conferences (*Discipline*, part iii, chap. i).

In the Constitutions of the Reformed churches of America (German and Dutch), the principles and rules of discipline laid down are very similar to that of the Presbyterian Church above cited. See *Constitution of the German Reformed Church* (1854), part iii, p. 32; *Constitution of the Reformed Dutch Church of North America* (Phil. 1840), chap. iv, p. 82.

Literature.—On the discipline of the ancient Church, see, besides the authors already cited, Bingham, *Orig. Eccles.* bk. xvi, chap. i; Schaff, *Hist. of the Christian Church*, i, § 114; Neander, *Church History* (Torrey's), vols. i and ii; Barrow, *On the Pope's Supremacy*, Works, iii, 282 sq. (N. Y. ed.); and the references under Penance; PENITENTIAL DISCIPLINE.

On Church discipline in general, see Hooker, *Eccles. Polity*; Watson, *Theological Institutes*, ii, 572 sq. (N. Y. ed.); Dwight, *Theology* (New Haven, 1836), iv, 886 sq.; Walker, *Church Discipline* (Bost. 1854, 18mo); Hill, *Pastoral Function in the Church* (Lond. 1855, chap. i); James, *Church-members' Guide*; Porter, *Compendium of Methodism* (N. Y. 12mo); and works on pastoral and practical theology generally. See also DISCIPLINE, BOOK OF; EXCOMMUNICATION; ECCLESIASTICAL POLITY.

Discipline, Book of, in the Methodist Episcopal Church, is a volume published quadrennially, after the sessions of the General Conference (q. v.), and entitled *The Doctrines and Discipline of the Methodist Episcopal Church*. It is divided into six parts: I. Origin, Doctrines, and General Rules; II. Government of the Church; III. Administration of Discipline; IV. Ritual; V. Education and Benevolent Institutions; VI. Temporal Economy. All but the constitutional portions (see *Restrictive Rules*, in pt. ii, ch. i, § 1) are liable to change under the authority of the General Conference. For the modifications which the book has undergone, see Emory, *History of Discipline* (N. Y. 1860, 12mo); see also Baker, *Guide to Administration of Discipline* (N. Y. 16mo).

Discipline, First Book of (in the Scottish Church), was drawn up by the Scottish Reformers in 1560, and contained the order and government of the Church of Scotland. It was prepared by Knox, Winram, Spotswood, Rosse, and Douglas. Though approved by the Assembly, it was not ratified by the Privy Council.—Eadie, *Eccles. Cyclopædia*, s. v.

Discipline, Second Book of, was sanctioned by the Assembly in 1578. Though not then ratified formally by Parliament, it is regarded as the standard book of the Scottish Kirk, and is held in high estimation for its views of administration and order by all Presbyterians. The *Second Book of Discipline* was inserted in the registers of Assembly, 1581, sworn to in the national covenant, revived and ratified by the Assembly, 1638, and by many other acts of Assembly, and according to which the Church government is est-

ablished by law, A. D. 1592 and 1690.—Eadie, *Eccles. Cyclopædia*, s. v.

Discipline of the Lash, or Scourge, the punishment given (from the instrument used) to personal correction or flagellation, inflicted generally voluntarily. "The oldest religious discipline on record was among the Egyptians, who, when they had sacrificed an ox to Isis on the day of her grand festival, the priests, stuffed the carcass with fragrant gums and incense, and burned it. During the burning," says Herodotus (ii, 40), "they all beat themselves;" and again, "a prodigious number of both sexes beat themselves with a will during the sacrifice; but I am not prepared to say in whose honor they beat themselves." The custom of the Spartans, in honor of Diana (see the next earliest discipline with which we are acquainted), was by no means voluntary. The boys were compelled to submit to it at first were freed afterwards, in wiser times, they were selected out among the children of slaves (Plut. *de Mor. Lac.* Cicerō, who was a personal witness of this savage custom, has left a fearful account of the cruelty of the tortures and the fortitude of the boys, who sometimes endured even to death (*Tusc. Quest.* ii, 14). Plutarch, in his life of Apollonius Tyanæus, has spoken of certain philosophers who were accustomed to discipline themselves; Artemidorus says the same of the Thracians, and Apuleius of the Syrians. The best illustration is given in *Lupercalia*, in which the noblest matrons willingly submitted to the thong from the hope of fertility, and lingered in the Eternal City long after the establishment of Christianity, and it was not till the close of the fifth century that pope Gelasius succeeded in expelling this last remnant of paganism.

"Before the 11th century the discipline of the lash had been confined to only a few severer individuals, but about that time the custom was sanctioned by authority, and a code was framed estimating the precise value of each separate infliction as a commutation for sin. A year of penance amounted to three thousand lashes; and the celebrated ascetic, Dominic *Leisurus*, the cuirassed, so named because, except while undergoing discipline, he always wore a shirt of mail next his skin, frequently performed a penance of 100 years, and would continue flogging himself without cessation while he repeated the Psalter twenty times over; 'which,' says his friend and biographer, cardinal Peter Damiano, 'filled me with trembling and horror when I heard it.' The self-tormenting achievements of St. Dominic may be found in Fleury, *Hist. Eccl.* xiii, 96. His usual accompaniment to each single psalm was 100 lashes; so that the whole Psalter with 15,000 stripes, equalled five years' penance. St. Dominic's allowance, therefore, amounted to the 100 years. If he was prevented by any accident from flogging himself as he wished, he used to beat his hands and legs unmercifully."

About 1260 public associations sprang up in Italy for the purpose of discipline, under the name *Fratres* (*q. v.*).

"Sometimes discipline was carried to an extent more extravagant than that of St. Dominic himself. We may judge from the laws of the Visigoths, one of which (lib. vi, tit. 5, sec. 8) bears the following formidable heading: '*Si indiscretâ disciplinâ perenni mori de flagello contigerit*'—if death should happen from undue severity. Sometimes it might be received by deputy. It was thus also, namely by proxy, that Henry IV of France was permitted to be reconciled to the Church when he abjured the errors of Protestantism. D'Ossat and Du Perron, both of whom afterwards obtained cardinal's hats, were deputed to administer the discipline from the Pope himself, who gave each one lash at every verse of the *Miserere*. They were allowed to keep their coats on, and they reported that his holiness struck lightly. The narrative of the transaction was not inserted in the bull of absolution."

s on account of some compromise between the pride and the king's honor; but it is recorded ritten process of the ceremonial. An account discipline undergone by Henry II after the of & Becket is given by Matthew Paris (*Sic. de Regn. Ital.* xix; Du Pin, *Bibl.*, xiii *Siccle*; 1, *Hist. Flugel.*).—*Encyclopædia Metropolitanana*,

'CUS (*δίσκος*, a *quois*), one of the exercises in ecian gymnasia, which Jason, the high-priest, introduced among the Jews in the time of Antiochus Epiphanes (2 Macc. iv, 9), and which he induced even the priests to practise (2 Macc. iv, 14). The discus was a circular plate of stone or metal, made for throwing to a distance as an exercise of strength and dexterity (Lucian, *Anachron.* 27). It was indeed one of the principal gymnastic exercises of the Greeks, and was practised in the heroic age (Homer, *Il.* xxxiii, 839 sq.; ii, 774; *Odyss.* viii, 129,



of a *Diacobolus* (disk-thrower) in the British Museum.

For details, see Smith's *Dict. of Class. Antiq.* Mercurial. *De arte gymnast.* ii, 12; Krause, *Gymn. Hellen.* i, 440 sq. See GAMES.

sease (properly מַחֲלֵה' *machaleh'*, *vóσoc*). Disease not unfrequently alluded to in the Old Testament; but, as no description is given of them, except one or two instances (see below), it is for the part impossible to determine much with certainty ning their nature. The same indefiniteness is to a very great degree in the mention of diseases in the New Testament, but few of which are sufficiently explicit to identify them precisely with the definitions of modern pathology. With respect to subject, it is known that there are certain words of its origin which are used in the Scriptures to express diseases of some kind or other; it will therefore prominent attempt with us to ascertain what the es are that were designed to be expressed by words, which will be noticed in their appropriate places. See also PESTILENCE. The ancients accustomed to attribute the origin of diseases, usually of those the natural causes of which they do not understand, to the immediate interference of deity (Deut. xxviii, 60; 2 Kings xix, 35; 1 Chron. 2-15; Psa. xxxix, 9-11; Acts xii, 23). Hence were frequently denominated by the ancients as *μάρτυρες*, or the *scourges* of God, a word which employed by the physician Luke himself (vii, 21), also in Mark v, 29, 34. Two of the plagues of Egypt were of this character. According to Prosperus (*De Med. Egypt.*), diseases prevalent in Egypt, and other countries of a similar climate, were the ophthalmias, or diseases of the eyes; leprosy, inflammation of the brain, pains in the joints, the hernia, the stone in the kidneys and bladder, the phthisis, the tertian, and tertian fevers; weakness of the stomach, and obstructions in the liver and the spleen. The most prevalent diseases of the East at present day are cutaneous diseases, malignant fevers, dysentery, and ophthalmia. Of the first of these, the most remarkable are leprosy and elephantiasis. The latter is usually thought to have been the disease of Job (q. v.). See LEPROSY. To the same

class also belongs the singular disease called the *mal d'Aleppo*, or "Aleppo button," a species of *felon*, which is confined to Aleppo, Bagdad, Aintab, and the villages on the Segour and Kowick (Russell's *Nat. History of Aleppo*, ii, 299). The Egyptians are subject to an eruption of red spots and pimples, which cause a troublesome smarting. The eruption returns every year towards the end of June or beginning of July, and is on that account attributed to the rising of the Nile (Volney, i, 281). Malignant fevers are very frequent, and of this class is the great scourge of the East, the plague (q. v.), which surpasses all others in virulence and contagiousness. The Egyptian ophthalmia is prevalent throughout Egypt and Syria, and is the cause of blindness being so frequent in those countries. See BLINDNESS. Of inflammatory diseases in general, Dr. Russell (*l. c.*) says that at Aleppo he has not found them more frequent, nor more rapid in their course than in Great Britain. Epilepsy and diseases of the mind are commonly met with. Melancholy monomaniacs are regarded as sacred persons in Egypt, and are held in the highest veneration by all Mohammedans. See LUNATIC.

The spermatic issue mentioned in Lev. xv, 5, cannot refer to *gonorrhœa virulenta*, as has been supposed by Michaelis and Hebenstreit, for the person who exposed himself to infection in the various ways mentioned was only unclean until the evening, which is far too short a time to allow of its being ascertained whether he had escaped contagion or not. Either, then, the law of purification had no reference whatever to the contagiousness of the disease (which is hardly admissible), or the disease alluded to was really not contagious. See ISSUE.

Hezekiah (q. v.) suffered, according to our version, from a *boil* (2 Kings xx, 7). The term here used, *שִׁחִין*, *shichin'*, means literally *inflammation*; but we have no means of identifying it with what we call *boil* (q. v.).

The disease of Jehoram (q. v.), spoken of in 2 Chron. xxi, 18 (comp. the similar case of Herod, Acts xii, 23), is probably referable to chronic dysentery, which sometimes occasions an exudation of fibrine from the inner coats of the intestines. The fluid fibrine thus exuded coagulates into a continuous tubular membrane, of the same shape as the intestine itself, and as such is expelled. This form of the disease has been noticed by Dr. Good under the name of *diarrhœa tubularis* (*Study of Med.* i, 287). A precisely similar formation of false membranes, as they are termed, takes place in the windpipe in severe cases of croup.

The malady of Nebuchadnezzar (q. v.), alluded to in Dan. iv, 33, was a species of melancholy monomania, called by medical authors *zoanthropia*, or more commonly *lycanthropia*, because the transformation into a wolf was the most ordinary illusion. Esquirol considers it to have originated in the ancient custom of sacrificing animals. But, whatever effect this practice might have had at the time, the cases recorded are independent of any such influence; and it really does not seem necessary to trace this particular hallucination to a remote historical cause, when we remember that the imaginary transformations into inanimate objects, such as glass, butter, etc., which are of every-day occurrence, are equally irreconcilable with the natural instincts of the mind. The same author relates that a nobleman of the court of Louis XIV was in the habit of frequently putting his head out of a window, in order to satisfy the urgent desire he had to bark (Esquirol, *Maladies Mentales*, i, 622). Calmet informs us that the nuns of a German convent were transformed into cats, and went mewing over the whole house at a fixed hour of the day.

On the cases of persons possessed with unclean spirits, see DEMONIAIC. For other specifications of disease in the Bible, see BLAINS; BOTCH; FLUX; HÆM-

ORRHOIDS; MURRAIN; BLOODY SWEAT; PALSY; LAME; IMPOTENT; WITHERED; LICE, etc. On the methods practised by the ancient and modern Orientals for curing diseases, see HEALING; MEDICINE; PHYSICIAN, etc. The following special treatises exist on the subject: Michaelis, *Lex Mosaiica de morbis illustrata* (Gott. 1757; also in his *Syntagma*, ii, No. 4); Ader, *De morbis in N. T.* (Tolet. 1821); Bartholinus, *De Morbis Biblicis* (F. ad M. 1697, 1705, etc.); Eschenbach, *Scripta medico-biblica* (Rost. 1779); Jordan, *De divino in morbis* (F. ad V. 1651); Mead, *Medica sacra* (Amst. 1749; in German, Leipz. 1777); Richter, *Diæsert. medica* (Gotting. 1775); Anon. *Untersuch. med. hermen.* (Leipz. 1794); Warliz, *De morbis Biblicis* (Vi-tet. 1714); Wolf, *Von den Krankheiten der Juden* (Mann. 1777). See further under SICKNESS.

Dish stands in the Auth. Vers. as the translation of the following terms in the original Scriptures: **סֶפֶסֶל** (*se'phei*, something low, a "dish" of curdled milk, Judg. v, 25; or "bowl" of water, Judg. vi, 38), probably a flat and not very deep or large vessel or pan for fluids; **צִלְחָה** (*tsallach'ath*, something to pour into, a "dish" for eating from, 2 Kings xxi, 18; incorrectly rendered "bosom" in Prov. xix, 24; xxvi, 15, in describing the slothful glutton), probably a platter, as the kindred terms (**צִלְחֹן**, "pan," 2 Chron. xxxv, 13; **צִלְחֵי**, "cruse," 2 Kings ii, 20) signify in general; but the most usual term is **קִישְׁרוֹת** (*ke'arak'*, something deep), spoken of the silver "dishes" of the Tabernacle (Exod. xxv, 29; xxxvii, 16; Num. iv, 7; rendered a "charger" in Num. vii), translated by the Sept. *ρομβαιον*, which is the term rendered "dish" in Matt. xxvi, 23; Mark xiv, 20. These last terms agree with the form of the Egyptian dish as found on the monuments. The dishes have covers, and the manner in which they are carried by the servants to the table on the reverted hand is the mode still used by Eastern servants. The other terms probably represent differ-

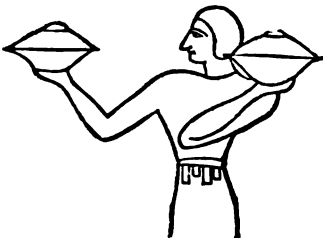

Ancient Egyptian Dinner-dish.

ent forms of dishes such as are now in use among the Eastern nations. See SNUFF-DISH. The sites of such



Modern Oriental Dishes.

ancient towns as were built of sun-dried bricks are usually covered with broken potsherds, some of them large enough to indicate the form of the entire vessel. These are remarkably similar to those in modern use, and are for the most part made of a rather coarse earthenware, covered with a compact and strong glaze, with bright colors, mostly green, blue, or yellow. Dishes and other vessels of copper, coarsely but thickly tinned, are now much used in the East, but how far this may have been anciently the case we have not the means of knowing. See CUP; BOWL; BOTTLE;

CRUSE; PAN; PITCHER; FRY-PAN, etc. Known



Ancient Assyrian Dish of bronze.

bronzed dishes have been discovered by Layard and others in the Assyrian mounds, some entire and others in fragments, which show a high degree of elegance and skill (Layard, *Nineveh and Babylon*, p. 156). In ancient Egypt, and in Judæa, guests at the table handled their food with the fingers, but spoons were used for soup or other liquid food, when required (W. Kinson, *Assyria*, i, 181, 2 ed.). The same is the case in modern Egypt. Each person breaks off a small piece of bread, dips it in the dish, and then conveys it to his mouth, together with a small portion of the meat or other contents of the dish. To pick out a delicate morsel and hand it to a friend is esteemed a compliment, and to refuse such an offering is contrary to good manners. Judæa dipping his hand in the same dish with our Lord was showing especial friendliness and intimacy (Layard, *Mod. Egypt*, i, 193; Chardin, *Voy.* iv, 53, 54; Niebuhr, *Descr. de l'Arabie*, p. 46). See BASIN; CHARGER.

Di'shan (Heb. *Dishan'*, דִּישָׁן, another form of the name *Dishon*; Sept. *Δισών*, but in 1 Chron. i, 28, *Δισών* v. r. *Δισών*), the name of the youngest son of Seir the Horite, father of Uz and Aran, and head of one of the original tribes of Idumæa (Gen. xxxvi, 28, 30; 1 Chron. i, 38, 42). B.C. cir. 1963. See DISHON.

Di'ahon (Heb. *Dishon'*, דִּישׁוֹן, *antelope*; Sept. *Δισών*, in 1 Chron. i, 41 *Δισών*), the name of two descendants of Seir the Horite. *Dishon* and *Dishon* belong to the same root, which may possibly represent the name *Deish* noticed by Abulfeda (*Hist. Arabica*, p. 196). The geographical position of the tribes descended from these patriarchs is uncertain. Knobel (*Omnia* in loc.) places them to the E. and S.E. of the Gulf of Akaba, on the ground that the names of *Dishon*'s sons, *Eshban* and *Hemdan*, may be identified with *Ushayn* and *Humeidy*, branches of the tribe of *Omran*. Such identifications must be received with caution, as similar names are found in other parts of Arabia—*Hawsh*, for instance, near *Tayf*, and again *Hawdan*, which bears a still closer resemblance to the original name near *Sana* (Burckhardt's *Arabia*, i, 156; ii, 576). See HORITE.

1. Seir's fifth son, and head of one of the aboriginal Idumæan tribes (Gen. xxxvi, 21, 30; 1 Chron. i, 38). B.C. cir. 1963. In the original of Gen. xxxvi, 21, where his four sons are mentioned, the name is: some transposition, *DISHAN*, which our translators (following the Sept. and the parallel passage 1 Chron. i, 41) have correctly changed to "Dishon."

2. His grandson, the only son of Anah, and brother of Aholibamah, Esau's second wife (Gen. xxxvi, 25. 1 Chron. i, 41). B.C. considerably post 1963.

Dishon. See PYGARG.

Dismounting. See RIDER.

Dispensation (*οἰκονομία*, management, prop. of household affairs, hence Engl. *economy*; "stewardship," Luke xvi, 2, 3, 4; "edifying," 1 Tim. i, 4, apparently reading *οἰκοδομη*).

(1.) By the *divine dispensations* are generally meant those methods or schemes which are devised and pursued by the wisdom and goodness of God in order to manifest his perfections and will to mankind, for the purpose of their instruction, discipline, reformation, and advancement in rectitude of temper and conduct, for the promotion of their be-

these have varied in different ages of the world have been adapted by the wisdom and aid of God to the circumstances of his intelligent and rational creatures. Divines designate these dispensations as the *Patriarchal*, the *Mosaic* or *the Christian*; the first commencing with the giving of the law; the second reaching to the death of Christ; the third from the death of Christ to the end of the world. All these were adapted to the circumstances of the human family of man at these different periods: all, in succession, were mutually connected, and representative to one another: all were subservient to the sign of saving the world, and promoting the glory and happiness of its rational and moral inhabitants (Watson, *Theol. Dictionary*, s. v.). "There is no part of divinity attended with so much mystery, and wherein orthodox divines so much differ, in stating the precise agreement and difference between the two dispensations of Moses and Christ" (Barrow, *On Full Communion*, Works, N. Y., 1848, p. 100). See Fye Smith, *First Lines of Christian Theology*, v, ch. iii; Fletcher, *Works* (N. Y. ed.), vols. 1 and 2, art. FEDERAL THEOLOGY.

Dispensations of Providence are any particular or special modes of visible treatment to which, under the government, mankind are subjected. They are either merciful or in judgment, though what appears to belong to the latter class are often blessings in disguise (Buck, *Theol. Dict.* s. v.). See PROVIDENCE. The word *dispensation* is used in ecclesiastical language to signify a power granted by the Church to suspend or to do or leave undone something which otherwise is not allowed. The Roman ecclesiastical law grants to the pope the right and power of dispensing with the law in certain (and numerous) cases and of deputing this power to bishops and other church officers. "The limits of the dispenser have been the subject of much discussion, especially in controversy with Protestants, but among Catholics themselves. It is held by the extreme advocates of papal power that the pope may dispense in any divine law, except the articles of the faith; by others, that his dispensing power does not extend to express precepts of the New Testament; and that his dispensation is valid only when it does not depend upon just cause; some, that it is not properly a relaxation of the law's obligation, but merely a declaration that in the particular case the law is not applicable. The usage of the Church of Rome, however, is in accordance with the opinions of her theologians in making the pope supreme in releasing from oaths and vows; the decree of the Council of Trent anathematizes all who deny the power of the Church to grant dispensations for marriages within the prohibited degrees of consanguinity; while the multiplied prohibitions of the canon law give much occasion for the frequent exercise of the same power" (Chambers).

The dispensations in the Church of Rome are divided by Roman Catholic writers into papal and episcopal, *pro foro externo et interno* (according to the nature or secret character of the impediment to be removed), *dispensationes iustitiae et gratiae*. Roman Catholics generally admit the fact that in former times it was common for bishops and provincial councils to dispense from general Church laws, and that only since the Council of Trent the canon law provides in what cases bishops and provincial councils may grant dispensations, while in all cases a special authorization by the pope is required—in cases *pro foro externo* through apostolic Dataria, and in cases *pro foro interno* through the Penitentiaria. See CURIA ROMANA. If communication with the pope is interrupted, or if there is danger in delay, and the granting of the papal dispensation be highly probable, the bishop may exceptionally grant a dispensation which ordinarily is reserved to the pope; but in such cases the papal sanc-

tion must be solicited as soon as possible. The authorization of the bishops to grant dispensations is partly renewed every fifth year (*facultates quinquennales*), and partly given as a personal distinction (*facultates extraordinariae*); but they can only exercise it as papal delegates. "The only kind of dispensations now in use in England are those granted by a bishop to a clergyman to enable him to hold more benefices than one, or to absent himself from his parish. Formerly the pope's dispensations in England, as elsewhere, prevailed against the law of the land, not in ecclesiastical matters only, but in all that large department of civil affairs which, by an interested fiction, was brought within the scope of ecclesiastical government. This abuse was swept away at the Reformation by 26 Henry VIII, c. 21. The power of the pope was then conferred on the archbishop of Canterbury, in so far as it was not contrary to the law of God. The granting of special licenses of marriage, and the like, is the only form in which it is ever exercised. In former times, the crown claimed a dispensing power in civil, similar to that of the pope in ecclesiastical matters. The power was grossly abused by James II, and was consequently abolished by the Bill of Rights. The privilege of granting pardons in capital cases is the only form in which the dispensing power of the crown still exists" (Chambers).

In the Protestant churches of the Continent of Europe, the right of dispensing with ecclesiastical laws has devolved upon the princes, who generally exercise it through the Consistories. If the prince needs an ecclesiastical dispensation himself, he usually calls for the opinion of a theological faculty.—Herzog, *Real-Encykl.* iii, 428; Wetzler u. Welte, *Kirch.-Lex.* iv, 178; Barrow, *Works* (N. Y. ed.), iii, 204 sq., 278.

Dispersed (*διασπορά*, *scattering*, John vii, 87; "scattered," James i, 1; 1 Pet. i, 1; comp. Tob. iii, 4; in Heb. usually some form of *שָׁבַר*, *saphar*, to break up, Isa. xi, 12; or *פָּצוּ*, *puts*, Zeph. iii, 10, to scatter, as often rendered) JEWS, or, as they are most frequently styled technically and simply, THE DISPERSION (*ἡ Διασπορά*, 2 Macc. i, 27; Judith v, 19; Josephus, *Ant.* xii, 13, etc.), is the general epithet applied to those Jews who remained settled in foreign countries after the return from the Babylonian exile, and during the period of the second Temple. The Hebrew word originally applied to these foreign settlers (*גֵּרִים*, *galuth*, "captivity," comp. Jer. xxiv, 5; xxviii, 4, etc., from *גָּבַר*, to strip naked; so "sons of captivity," Ezra vi, 16) conveys the notion of spoliation and bereavement, as of men removed from the Temple and home of their fathers; but in the Sept. the ideas of a "sojourning" (*μερουμεσία*) and of a "colony" (*ἀποικία*) were combined with that of a "captivity" (*αἰχμαλωσία*), while the term "dispersion" (*διασπορά*, first in Deut. xxviii, 25, for *גֵּרִים*; comp. Jer. xxxiv, 17), which finally prevailed, seemed to imply that the people thus scattered "to the utmost parts of heaven" (Deut. xxx, 4), "in bondage among the Gentiles" (2 Macc. i, 27), and shut out from the full privileges of the chosen race (John vii, 85), should yet be as the seed sown for a future harvest (comp. Isa. xlix, 6 Heb.) in the strange lands where they found a temporary resting-place (1 Pet. i, 1, *παρεπίδημοι διασπορᾶς*). The schism which had divided the first kingdom was forgotten in the results of the general calamity. The dispersion was not limited to the exiles of Judah, but included "the twelve tribes" (Jas. i, 1, *αἱ δώδεκα φυλαὶ αἱ ἐν τῇ διασπορᾷ*), which expressed the completeness of the whole Jewish nation (Acts xxvi, 7, *τὸ ἑσδὲκάφυλον*).—Smith, s. v. See TRIBE.

The distinction of an Oriental and Occidental *Dispersion*, or *Dispersion* (Otho, *Lex. Robb.* p. 76 sq.), is erroneous; but that the Jews, sometimes by constraint, sometimes voluntarily, had their residence among heathen,

cannot be denied (Dan. ix, 7; Jer. xxxiii, 3; Ezek. xxxvi, 24, etc.), as well as that the deported Jewish colonies voluntarily remained in exile during the period in question (see Groot, *De migrationibus Hebræorum. extra patriam ante Hieros. a Romanis deletam*, Gronin. 1817). In the time of our Saviour there was scarcely any land of the ancient world in which Jewish residents were not to be met with (Joseph. *War*, vii, 3, 3; *Ant.* xiv, 7, 2; Philo, *Opp.* ii, 524, 537). We may appropriately distinguish four groups of the dispersed Jews. See CAPTIVITY.

1. Those in Assyria, Media, Babylonia, and Persia, or the *Trans-Euphratean* (οἱ ὑπὲρ Εὐφράτην ἀρκεσμένοι Ἰουδαῖοι, Joseph. *Ant.* xv, 3, 1), descended from the Jews and Israelites transported to these countries by the exile, between whom and the Palestinian Jews all distinctive prejudice gradually wore away. Many thousand Jews lived in these countries (Joseph. *Ant.* xv, 2, 2; 3, 1; Philo, *Opp.* ii, 578), in good circumstances, as it would seem. With their native land (Palestine) they had religious connection through regular transmittance of the annual Temple-tax and first-tithings (Joseph. *Ant.* xiv, 7, 2; xvii, 9, 1; Philo, *Opp.* ii, 578). There was even at one time a Babylonian high-priest at Jerusalem (Joseph. *Ant.* xv, 2, 4; 3, 1); and the Talmud speaks in respectful terms (see Lightfoot, *Hor. Hebr.* p. 1031) of this branch of the Dispersion, which went under the general denomination of the *Babylonians* (ἡ διασπορὰ τῶν Βαβυλωνίων). Their freedom had been confirmed by Alexander the Great (Joseph. *Ant.* xi, 8, 5; compare *Apion*, i, 23). Under the Seleucid kings they were, for the most part, favored on account of their zealous promotion, by military service, of the undertakings of those princes; and Antiochus the Great regarded them as such approved subjects, that he planted an entire colony by means of them in Asia Minor (Joseph. *Ant.* xii, 8, 4). Nevertheless there were not wanting collisions with the native Babylonians; bloody scenes ensued; and in the Roman period, under the emperor Caligula, the Babylonian Jews were compelled to emigrate to the then flourishing Seleucia, where, however, they soon drew upon them the ill-will of the inhabitants (Joseph. *Ant.* xviii, 9). See BABYLONIA.

2. In age and importance the next to the Babylonian was the *Egyptian* colony of Jews; indeed, in influence, this even stands the highest (comp. Strabo in Joseph. *Ant.* xiv, 7, 2). On the first immigration of Palestinian Jews thither, which began with the intimacy under Solomon, and was cherished by the Egyptizing party during the latter days of the Hebrew monarchy (see 2 Kings xviii, 21, 24; Isa. xxxix, 15; xxx, 2 sq.; xxxi, 1; xxxvi, 6), and confirmed (see Gesenius, *Jesajias*, i, 826, 967) as a support against Assyria (compare Herod. ii, 141), and still more (2 Kings xviii; xxii, 29, 33) against Nebuchadnezzar (2 Kings xxiv, 7) by an actual league with Hophra (Ezek. xvii, 15), on whose subjugation of Judæa many Jews took refuge in Egypt (Jer. ii, 18; xli, 17, 42-44), as the only safe retreat (Ewald, *Geoch. Issr.* i, 268 sq.), see Von Bohlen (*Genesis*, p. 33, Einl.). Nebuchadnezzar appears, however, during his irruption into Egypt, to have carried off to Babylon the Jews who had retired thither (Joseph. *Ant.* x, 9, 7). On the other hand, Alexander the Great placed a considerable number of Jews in the Alexandria founded by him, and bestowed upon them equal rights with the Egyptian citizens (Joseph. *Apion*, ii, 4; comp. *Ant.* xix, 5, 2). Ptolemy Lagi intrusted Jews with military positions, allowed a portion of the Jewish population to settle in Cyrene (Joseph. *Apion*, i, c.), and strengthened the Egyptian colonies by the transmigration of many Palestinian Jews thither (Joseph. *Ant.* xii, 1), B.C. 320. Ptolemy Philadelphus (B.C. 284) is said to have caused the Jewish book of the law to be translated into Greek at a great expense for the Alexandrian library (Joseph. *Ant.* xii, 2; *Apion*, ii, 4). See SEPTUAGINT.

With this favor towards the Jews their inhuman treatment by Ptolemy Philopator stands in most lamentable contrast, according to the third book of *Maccabees* (q. v.). But the truth of this circumstance is very doubtful, and Josephus (*Ap.* ii, 5, only extant in Latin) ascribes this procedure to Ptolemy Philometor. Under Ptolemy Philometor (B.C. 180 sq.) and his daughter-mother Cleopatra the Jews were very favorably treated; high offices, namely in the army, were given to their hands, and the court granted them the greatest confidence (Joseph. *Ap.* ii, 5). Even the erection of a proper Jewish temple at Leontopolis was allowed (Joseph. *Ant.* xiii, 3; *War*, vii, 10, 2), and on the eastern border of the kingdom a Jewish town (Onias) was founded (Joseph. *War*, i, 9, 4; *Ant.* xiv, 8, 1), which was important in a military point of view. After Egypt fell under the Roman sway, the associates enjoyed, under the first emperors, continued prosperity (comp. also Philo, *Opp.* ii, 563) and freedom, although they experienced occasional violations of their rights on the part of the Greek inhabitants, who were, on the other hand, provoked by the encroachments of the Jews (Joseph. *Ant.* xiv, 7, 2); and even Augustus found it necessary to protect the Jews in Cyrene by a special edict (Joseph. *Ant.* xvi, 6, 1 sq.). But a terrible vengeance of the Greeks against the Jews, who were continually incurring the deepening hate of the community, took place under the emperor Caligula. The Jews in Alexandria and other parts of Egypt were attacked with bloody violence, their synagogues demolished, their rights trampled upon (including the exemption from the *bastinado* [q. v.], Philo, *Opp.* ii, 528); the Roman governor Flaccus Anilius himself was in league with the mob against the Jews. Caligula's intercessions of the Jewish king Herod Agrippa, who informed the emperor of these outrages, rescued the Jews for a moment from the persecution. The quarrel soon broke out afresh, and even an embassy which the well-known Philo headed, resulted for the Jews only in scorn; their existence in Egypt appeared to be at an end. At this juncture Caligula died (A.D. 41), and the Jews breathed more freely again under Claudius (see Joseph. *Ant.* xvi, 8, 1; especially *Philo. Adv. Flaccum*, in his *Opp.* ii, 517 sq.; also *Agrippæ ad Cæsarum*, *ib.* p. 545 sq.). Their rights and freedom were restored by a special ordinance of this emperor (Joseph. *Ant.* xix, 5, 2). But under Nero (A.D. 54) the old enmity between the Greeks and Jews in Alexandria again manifested itself; a great massacre was committed by the Roman military that became involved, the Jews were greatly reduced in number, and many came to beggary (Joseph. *War*, ii, 18, 7 sq.). To add to these misfortunes, their temple at Leontopolis was at last shut up against them (Joseph. *War* vii, 103). See EGYPT.

The Jews, however, for a long period (at the time of Philo, about a thousand years; see his *Opp.* ii, 528) enjoyed great privileges in Egypt; indeed, not infrequently they were better off there than in Palestine itself. No other colony could exhibit a temple and priesthood of their own. Alexandria contained several synagogues, one of which was very splendid (Philo, *Opp.* ii, 565; Vitrings, *De synagoga*, p. 256). Two of the five quarters of the city were occupied almost exclusively by Jews (Philo, *Opp.* ii, 525), and these made up well-nigh one half the population (*ib.* p. 525). The religious connection with Palestine, however, was not on that account abandoned, since Alexandrians had a peculiar synagogue in Jerusalem itself with the Cyrenians (Acts ix, 6); and the Egyptians, like the Cyrenian Jews, transmitted the yearly Temple-tax (Philo, *Opp.* ii, 568, 646; Joseph. *Ant.* xvi, 6, 1, 5; on the dependency of the priesthood at Leontopolis upon that of Jerusalem, see Joseph. *Apion*, i, 7; comp. *Greenwich. De philoſophia Sadduæcorum*, i, 6). The chief officer of the Egyptian Jewish colonies was an *exarch* (ἐξάρχης), probably the highest judge of his people (Strabo in

eph. *Ant.* xiv, 7, 2). He had his seat at Alexandria, and was called an *alabarch* (q. v.), ἀλαβάρχη (Joseph. *Ant.* xviii, 8, 1; xix, 5, 1; xx, 7, 3; comp. Rhennard, *Opera philol.* p. 584 sq.), with which the patriarch of the modern Oriental Christians may be compared. He was supported by a council of elders (γερουσία), according to the arrangement instituted by Augustus Philo, *Opp.* ii, 527). See SANHEDRIM. These Jews had completely adopted Greek under the Ptolemies; was their ecclesiastical as well as social language, but the Greek learning, i. e. philosophy, which flourished in Alexandria, also found admission to them: the Alexandrian Rabbins were among the most learned Jews; they formed for themselves a peculiar religious philosophy, based upon the Jewish Scriptures, and exercised with the utmost acuteness the allegorical interpretation of the Bible which was essentially connected with it. Philo's writings afford ample evidence of this system (comp. Dähne, *Geachichtl. Darstellung d. jüd. alexandr. Religionsphilos.* Halle, 1884, vol. ii; also Grossman, *De theologia Philonis fontibus et auctoritate*, Lips. 1824; and *De Pharisaismo Jud. Alex.* Lips. 1846; Mülln, *Bibl. Theol.* i, 353 sq.). The Jewish colony in Cyrene (Cyrenaica) was derived from Egypt, enjoyed like privileges with the other inhabitants, and had a synagogue likewise in Jerusalem (Acts vi, 9). Ptolemy Lagi, who subjugated Cyrene (Justin. xxii, 7), appears to have become himself the founder of this colony, and to have sought to secure this province to himself by these means (Joseph. *Ap.* ii, 4). Under the later Roman emperors of the first century, however, the Jewish population sought to acquire a pre-eminence over the other inhabitants, and thus brought on bloody contests, which ended in the expulsion of the Jews from Cyrene (see Münter, *Letzer jüd. Krieg*, p. 10 sq.; comp. generally Cless, *De colonis Judæor. in Egypt. terræque c. Egypto conjunctas post Mosen detectis*, Stuttg. 1832). See CYRENE.

3. Syria was another place to which the Jews migrated after the time of Seleucus Nicator, and here they were granted by this prince equal rights, at Antioch and other cities, with the Macedonians (Joseph. *Ant.* 3, 1). The following kings of this dynasty, likewise, with the exception of Antiochus Epiphanes (q. v.), favored the Jews (Joseph. *War.* vii, 8, 8); they lived in prosperity, could even make proselytes, had at Antioch their own ruler (*ib.*), and were in Damascus numerous (Joseph. *War.* ii, 20, 2). Nevertheless here, too, the popular hate was inflamed against them; long restrained, it finally broke out under Nero (*ib.*), when under Vespasian with great violence, and, under the patronage of the Roman arms, inflicted every imaginable evil upon the Jews (Joseph. *Life.* 6). Yet Titus, after the destruction of Jerusalem, befriended these persecuted people, and restored to them their rights (Joseph. *War.* vii, 5, 2). See ANTIOCH.

From Syria the Jews had found their way into Asia Minor (1 Pet. i, 1; Philo, *Opp.* ii, 582). As early as Antiochus Theos, the Jews in Ionia were granted the privilege of citizenship (Joseph. *Ant.* xii, 8, 2); but Antiochus the Great planted in Phrygia and Lydia, which had been overrun by him, colonies of Jews from Mesopotamia and Babylonia, amounting to 8000 families (*ib.* 3, 4). By Julius Cæsar in the later times of the Roman republic, and by Augustus, there were issued a series of decrees (Joseph. *Ant.* xiv, 10; xvi, 6) to the most of the chief cities of Asia Minor, a. g. Ephesus, Sardis, Laodicea, Halicarnassus, etc., in which the unrestricted exercise of their religious worship, generally also freedom from military service, and the privilege of sending the Temple contribution and firstlings to Jerusalem, which even Roman governors had at times interdicted (*ib.* xvi, 2, 3), were assured to the Jews. See each of these cities in their place. See ASIA MINOR.

4. From Asia Minor, too, the first Jews may have been attracted to Greece (διασπορά τῶν Ἑλλήνων, John vii, 35) and Macedonia, where, in the apostles'

time, we find in all the important cities, especially those of a maritime and commercial character, communities with synagogues or proseuchæ (Acts xviii, 20). See GREECE.

Rome and Italy had before Pompey no settled Jews; but from the Jewish prisoners of war, who had either been redeemed or dismissed on account of their impracticable habits (Philo, *Opp.* ii, 568), there now grew up in Rome, by the influx of freeborn Jews from Palestine, Greece and regions, a numerous community, who had their abode in a separate Jewish quarter across the Tiber. See ROME. They were accorded full freedom of worship, and were even successful in making proselytes. They must soon have risen to prosperity, for the yearly Temple contributions (Philo, *Opp.* ii, 568) of the Italian Jews (Cicero, *Flacc.* 28) was very considerable. They were once expelled from Rome under Tiberius, and again by Claudius (Acts xviii, 12). See CLAUDIUS. On their later fate, see Jost, *Gesch. d. Jer.* ii, 326 sq., who, however, has here, as in his antecedent sections on the extra-Palestinian Jews, failed to give exact reference to the authorities. Of intrinsic value are the expositions of the public documents bearing on this subject in the two works, *Decreta Rom. et Asiat. ad cult. Æiv. per Asiæ Min. urbes secure obœandum a Josepho collecta*, restit. a J. Gronov. (Leid. 1712), and *Decreta Romanor. pro Judæis*, etc. a J. T. Krebe (Lips. 1768). Comp. also Levyssohn, *De Judæor. sub Cæsariibus conditione* (L. B. 1828), and generally Remond, *Vers. einer Gesch. der Ausbreit. d. Juden.* (Lips. 1789); Walch, *Hist. patriarcharum Judæorum* (Jen. 1752).—Winer, ii, 727. See JEWS.

DISPERSION OF MANKIND. This event is usually held to have been occasioned by the confusion of tongues (q. v.) at the overthrow of Babel (Gen. xi, 9, where the term employed is פְּרִיט, *puta*, to "scatter"). As to the manner of the distribution of the posterity of Noah (Gen. x, 82, where the term is פָּרַד', *parad'*, to disseminate) from the plain of Shinar, it was undoubtedly conducted under the influence of the ordinary laws of colonization. The sacred historian informs us that they were divided in their lands, every one according to his tongue, according to his family, and according to his nation (Gen. x, 5; xx, 81). The ends of this dispersion were to repeople the earth, to prevent idolatry, and to display the divine wisdom and power (comp. Gen. i, 28). See DIVISION OF THE EARTH.

That all the families of man descended from the first human pair, and were by degrees—after the confusion of the Babel-builders, and the division of the earth in the days of Peleg—dispersed over the several countries of the earth, is clearly the doctrine of the Bible (Gen. xi, 9; x, 25; comp. Deut. xxxii, 8; Acts xvii, 26). The object of Moses, in the fifth chapter of Genesis, was to furnish, from the ancient documents which had descended to his time, a brief but authentic genealogical table of the descendants of Adam, in the line of Seth, unto the time of the Flood, in the days of Noah and his sons.

ADAM, created about 4004 B.C.; he lived 930 years.

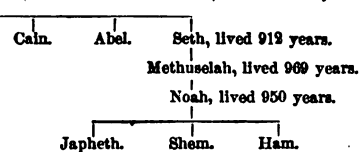

So also, in the tenth chapter, he has afforded us a survey of the principal nations of the earth, in their emigrations from the common centre of residence after the Flood. Many other nations, however, have been since formed by the union or division of some of those enumerated. The following is a synopsis of the chief tribes identified. See ETHNOLOGY.

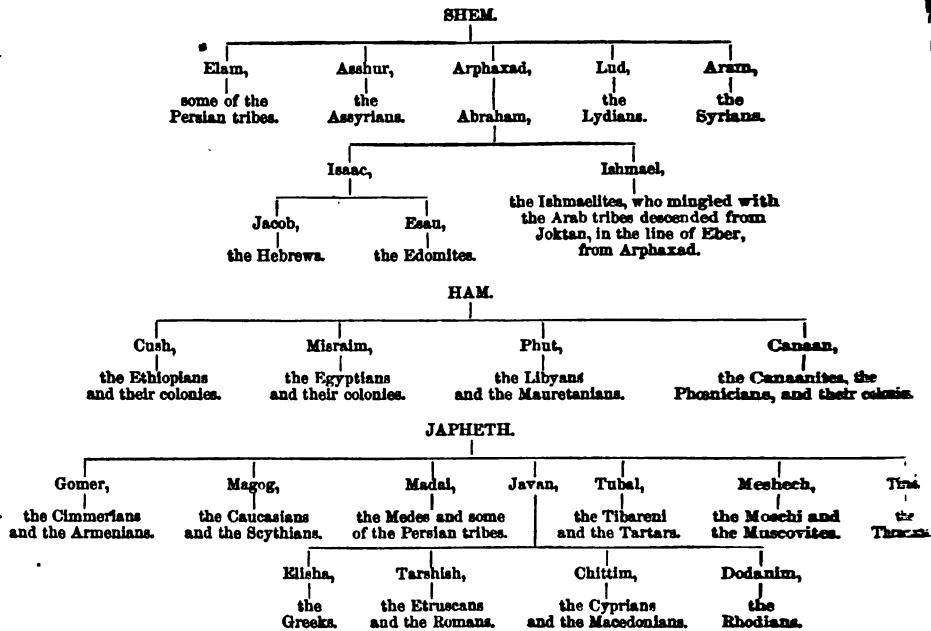

Dissenter (Lat. *dissentire*), a term properly applied to those who, in a country where a certain Church (or certain churches) is established or recognised by the state, disagree with that religion. In England, the term Dissenters appears to have come into use in the 17th century, as synonymous with *Nonconformists*; and from England its use was transferred to Scotland in the 18th century, after the Secession (q. v.) Church had been founded in that country. It is usually applied to those who agree with the established Church in the most essential doctrines, but differ from it on some minor point, or on questions of Church government, relation to the state, rites, etc. as in England to Presbyterians, Independents, and Baptists. The title is accepted by several of the Free churches in England (e. g. Congregationalists, Presbyterians); but the English Wesleyans do not call themselves *Dissenters*, as they do not share in the views above stated as the grounds of dissent. Yet they are separated, in fact, from the Church of England. See **METHODISTS**.

"The term Dissenters is not strictly legal or ecclesiastical, those to whom it applies being usually described in legal language by a periphrasis. It may be said to be a convenient term to designate those Protestant denominations which have dissented from the doctrine and practice of the Church as by law established. Immediately after the Reformation, Dissenters, or Nonconformists, as they were then called, were subjected to severe restrictions and penalties. 'During the Rebellion the laws against Protestant sectaries were repealed; but they revived at the Restoration, and the Parliament of Charles II proceeded to enforce systematically, by new measures of vigor, the principle of universal conformity to the established Church (Stephen's *Com.* iii, 53). By 1 Will. and Mary, c. 18, the restrictions on Dissenters were first relaxed, and certain denominations were suffered to exercise their own religious observances. From that period various statutes have been passed, each extending in some degree the free exercise of religious opinion. At the present time, Dissenters of all denominations are allowed to practice without restraint their own system of religious worship and discipline. They are entitled to their own places of worship, and to maintain schools for instruction in their own opinions. They are also permitted, in their character as householders, to sit

and vote in the parish vestries. A Dissenter, if a patron of a church, may also exercise his own judgment in appointing a clergyman of the Church of England to a vacant living. See on this subject Stephen's *Eccles. Law*. A similar amount of religious liberty is enjoyed in Scotland, not so much derived from a guarded by special statute; fully recognised, however, by decisions of courts, as belonging to the law of the country. Since the beginning of the 18th century the Presbyterian, Independent or Congregationalist and Baptist denominations in England, have been associated under the name of the *Three Denominations*. This association was fully organized in 1727, and enjoys—like the established clergy of London and the two great universities—the remarkable privilege of approaching the sovereign on the throne. Notwithstanding much weakness, arising from doctrinal and other differences, this association has contributed much to promote toleration and religious liberty in England (Chambers, *Encyclopædia*, s. v.). See **DEMINATIONS (THE THREE)**.

Dissenters object to the Church of England on such grounds as the following: 1. That the Church, as a law established, is the mere creature of the state, as much as the army. 2. That many of her offices and dignities are utterly at variance with the simplicity of apostolic times. 3. That the repetitions in the Liturgy are numberless and vain. 4. That the Apocrypha is read as a part of the public service. 5. That her creeds contain unwarrantable metaphysical representations relative to the doctrine of the Trinity. 6. That every baptized person is considered as regenerated. 7. That the baptismal and confirmation services, etc. have a tendency to deceive and ruin the souls of men. 8. That no distinction is made between the holy and profane, the sacraments being administered without discrimination to all who present themselves (Buck *Dict.* s. v.). Accounts of the origin and history of the different dissenting bodies will be found under the heads **BAPTISTS**; **CONGREGATIONALISTS**; **INDEPENDENTS**; **QUAKERS**; **UNITARIANS**, etc. See Bogue and Bennett, *History of the Dissenters* (Lond. 2 vols. 8vo.); Neal, *History of the Puritans*; Pierce, *Defence of the Dissenters of England* (1817, 8vo.).

Dissidentes (*Dissidentes*), a term specially applied to those non-Romanists in Poland who were allowed

he free exercise of their respective modes of worship. The privilege was accorded to Lutherans, Calvinists, Arminians, and Greeks, but not to Anabaptists, Socinians, and Quakers. In the latter part of the sixteenth century, a large part of the people, and perhaps half of the nobility, were Protestants. "The Convention of andomir, concluded in 1570, united the Lutherans, Calvinists, and Bohemian Brethren into one Church—union which had also a political tendency, and whose members obtained the same rights with the Catholics y the religious peace (*pax dissidentium*) sworn by the king in 1573. But the great mistake in not settling the mutual relations of the two religious parties gave rise to bloody contests. Although the rights of the dissidents were afterwards repeatedly confirmed, they were gradually repealed, particularly in 1717 and 1718, in the reign of Augustus II, when dissidents were deprived of the right of voting in the Diet. They lost still more some years afterwards (1738) under Augustus III; and in the Diet of Pacification, as it was called, in 1736, an old statute, requiring every Polish king to be of the Catholic Church, was revived. After the succession of the last king, Stanislaus Poniatowski, the dissidents brought their grievances before the Diet held in 1766, and were supported in their claims y Russia, Denmark, Prussia, and England. Russia, in particular, profited by the occasion to extend her influence in the affairs of Poland, supported them strongly y her mediation, in bringing about a new Convention in 1767, by which they were again placed on an equal footing with the Catholics. The Diet of 1768 repealed the decrees which had been formerly passed against them. The war against the confederates breaking out, however, and the kingdom being dismembered, nothing was accomplished until the year 1775, when the dissidents regained all their privileges, excepting the right of being elected senators or ministers of state" (Henson's *Buck, Theol. Dictionary*, s. v.). See POLAND. The name Dissidents (German Dissidenten) is also sometimes used as the collective name for all adherents of religious denominations which have no legal existence in any particular state. See TOLERATION.

Distaff (דִּסְטָף, *pe'lek*, prop. a circle, e. g. a district or quarter of a city, "part," Neh. iii, 9-18; hence the *hirl* of a spindle, with which it is put in parallelism, rov. xxxi, 19; once "staff," or crutch, Sam. iii, 29), the instrument used for twisting the thread in spinning by its whirl. See SPINDLE.

District, in the Methodist Episcopal Church, a territorial division of a Conference. Each Conference is divided into districts, including a convenient number of churches and societies (appointments); and each district is placed under the charge of a residing elder. The shops are empowered to form the districts according to their judgment. See *Discipline of the M. Church*, pt. ii, § 1; Stevens, *Hist. of Methodism*, bk. vii, c. ii; and the ART. RESIDING ELDER.

Ditch (בֶּרֶק, *geb*, a pit [as rendered in Jer. x, 81] or trench for cistern-water, 2 Kings iii, 16; מִבְּוֹהַב, *mib-vah'*, a collection or pool of water, Isa. xxii, 11; שְׁחָחָה, *shuchah'*, Prov. xxiii, 27, or שְׁחָחָה, *shach'ath*, Job ix, xxxi, a pit, as elsewhere rendered, or hole in the ground, either for holding surplus water or for catching animals; like the Greek βῆδυσος, Matt. xv, 14; Luke vi, 39). See CISTERN; POOL.

Ditheism, the worship of two gods.

(1.) This term was sometimes applied by the orthodox to the Arians, on the ground that they believed in one God, the Father, who is eternal, and one God, the Son, not eternal.

(2.) The term is also applied to the doctrine of two first principles, or gods, one good, the other evil. "The chiefest and most eminent asserters of this ditheistic doctrine of two self-existent principles in the universe were the Marcionites and the Manichæans, both of which sects, though they made some slight pretence to Christianity, yet were not by Christians owned for such. Some of the pagans also entertained the same opinion."—Cudworth, *True Intellectual System* (Andover, 1837), i, 290. See DUALISM.

Dithmar, JUSTUS CHRISTOPH, a German divine and jurist, was born March 13, 1677, at Rottenburg, in Hesse. After studying at the University of Marburg, where he applied himself to theology and the Oriental languages, he removed to Leyden, where he was offered a professorship, which he refused in order to accompany a family, in which he was tutor, to Frankfurt on the Oder, where he first became professor of history, then of the law of nature, and finally of statistics and finance. He was made a member of the Royal Society of Berlin, and a councillor of the order of St. John. He died at Frankfurt in 1787. Among his works are, *Gregorii VII Pont. Romani Vita* (Frankf. 1710, 8vo);—*Historia Belli inter Imperium et Sacerdotium* (ibid. 8vo);—*Summa Capita Antiq. Judaicarum et Romanarum in usum Praelectionum privatarum* (ibid. 4to).—Hoefer, *Nouv. Biog. Générale*, xiv, 327.

Ditmar. See THIETMAR.

Divan, the cushioned sofa running around three sides of the lewan, or raised portion of the sitting-room of an Oriental residence (Lane's *Mod. Egypt.* i, 17),



A Syrian Turk's Divan.

and serving the purpose of a seat by day and a couch by night for the male members of the family and guests. See HOUSE. It is from six inches to a foot high, a little elevated in front, and about four feet wide. The angles are the posts of honor. The common people of Palestine and Egypt have no proper bed, and domestics sleep on the floor or in the passages, wherever they can find room (Kelly's *Syria*, p. 23). See BED.

Diverse (כִּלְיִים, *kila'yim*, of two sorts, heterogeneous, Lev. xix, 19; Deut. xxii, 9) kinds of materials, animals, or products, the Jews were forbidden to bring together (comp. Joseph. *Ant.* ix, 8, 20), as being "confusion," i. e. unnatural hybridization. Among such commingling of incompatible or incongruent things are specified: 1. Not to wear garments which were woven of two kinds of stuff, particularly of wool and linen (linsey-woolsey); 2. Not to sow a field partly with one kind of seed and partly with another (see AGRICULTURE); 3. Not to yoke an ox and an ass together to the plough (q. v.); 4. Nor to pair different species of animals in breeding (e. g. to procure no mules). A legal impediment is attached, it is true, to only the second of these ordinances, namely, the rendering the produce of the field unmerchable (Deut. xix, 9); but a similar result is doubtless to be understood as applying to each prohibition, and to all other amalgamations. There is also some ambiguity in the statute itself, e. g. whether the "field" (שָׂדֵה) of the passage in Lev. be tantamount to the "vineyard" (כַּרְמֵי) of the parallel in Deut., and also in the sense of the commingling of the "seed" (זֵרַע); but the laxity of Hebrew idiom authorizes a liberal and comprehensive construction of the enactment, as designed to interdict any combination of crops (whether in separate rows or commingled broadcast) upon the same piece of tilled ground, orchard, etc.; and such was the interpretation of the Jews (Mishna, *Kilaim*, iv-vii). See SEED. The design of these prescriptions was doubtless to effect a still greater distinction between the chosen people of God and the heathen, who practised all these and other sorts of promiscuous unions, and also to engender and cultivate a nicer sense of propriety and purity in the Jewish mind, as in the case of many other apparently nice discriminations relating to daily life. See CLEAN and UNCLEAN, etc. Another reason has been thought to be the idea that Jehovah, as the author of nature, had a jealous regard to the preservation of its varied features intact and distinct (see Philippon, *Pentat.* p. 681). The Talmud contents itself (Mishna, *Kilaim*, i, 4) with giving detailed regulations upon each of the ordinances in question; of these, in connection with Josephus, it will be sufficient to notice only the most important. (a.) With regard to the prohibition of hybridizing animals (as the ass and the horse, the sheep and the goat; such only as belong to the same genus are capable of this), Josephus (*Ant.* iv, 8, 20) and Philo (*Opp.* ii, 307) imply that it had its ground in the moral effect of such irregular license upon the human beings, who were in danger thereby not only of trampling upon the Creator's ordinances (which fix a natural barrier between different species), but also of being incited to bestial commerce and unnatural appetites (comp. also the Rabbinical citations in Hottinger, *Juris Hebræorum leges*, p. 374 sq.). Mules (q. v.) may have been imported from other countries (Ewald even imagines that these were not included in the prohibition, *Israel. Alterth.* p. 222), since the Jews were only forbidden the rearing, not the use of them. (b.) Respecting the coupling of the ox and the ass as beasts of draught (Frisch, *De vero sensu legis Deut.* xx, 10, Lips. 1744, absurdly includes this under the foregoing rule), Josephus (*ut sup.*) bases the prohibition on the ground of humanity, as also Philo (*Opp.* ii, 370; so Schwabe, in the *Kir-*

chenzeitung, 1834, No. 20, on account of their inequality in strength). Michaelis (*Mos. Recht*, iv, 34; on the other hand, thinks it refers to some antique *ætia* relating to beasts of burden; but later (Berthold's *Journ.* iv, 353) he inclines to the opinion which refers it to the analogy of the copulation of the horse and ass. According to the Mishna (*Kilaim*, viii, 3), the effect of yoking together different animals (so it extends to the law, *ib.* 2 sq.) was punished with forty blows! As to the interdict of clothing composed partly of wool, Josephus (*Ant.* iv, 8, 11) gives as its ground the such garments constituted the priestly costume; but this is open to doubt, although the Mishna (*Kilaim*, ix, 1) assigns the same reason. The Talmud has many regulations and restrictions concerning this precept "Wool," according to this authority, is only sheep's wool; to weave camel's hair and linen together was permitted (*ib.* ix, 1). Towels, grave-clothes, blankets for asses, and the like—in short, whatever was merely laid on, but not woven—are interpreted as not coming within the province of the law. On the other hand, weavers and fullers must put their manufacturer's mark in cloths only by means of colors of the same kind (*ib.* ix, 10). The whole enactment would probably receive a clearer light were the meaning of the word שֵׂרָפִים (*shā'āme'z* [q. v.], rendered "linen and woolen" in Lev. xix, 19; "garment of divers sorts" in Deut. xxii, 11; Sept. κισβόηλον, i. e. adulterated, not genuine) well understood; but its etymology is obscure; that proposed by Bochart (*Hiæroz.* i, 486), and that of Buxtorf (*Lex. Talm.* col. 2483), both of whom seek the origin in the Shemitic languages, have little probability; nor is that entirely satisfactory (see Gesenius, *Thes. Heb.* p. 1456) which is suggested by Jablonsky (*Opusc.* i, 294, ed. Te Water) and by Foste (*De bysso Egypt.* c. 95), who refer it back to the Coptic word *shoutnes*, i. e. fibrous *byssus* (see Rosenmüller *Scholæ* in loc. Levit.). See LINEN. The Jews at Muscat, in Arabia, disregard this law (Niebahr, *Beich.* p. 157).—Winer, ii, 652.

Divēs. See LAZARUS.

Divination (חֲזוֹן, *hō'sem*, a lot [see below] a some kindred term; Gr. *μαντεία* [but Πνεύμα, *Psalm* in Acts xvi, 16]; used in the verb form חָזַן, *hazan'*, only of false prophets, etc., e. g. of the Hebrews, Deut. xviii, 10, 14; Mic. iii, 6, 7, 11; of necromancers, 1 Sam. xxviii, 8; of foreign prophets, as of the Philistines, 1 Sam. vi, 2, and Balaam, Josh. xiii, 22; and specifically of the three kinds of divination common among the Shemitic nations, viz. arrows, entrails, and Teraphim, Ezek. xxi, 21) is a general term descriptive of the various illusory arts anciently practised for the discovery of things secret or future. The curiosity of mankind has devised numberless methods of seeking to accomplish this result. By a perversion and exaggeration of the sublime faith which sees God everywhere, men have laid everything, with greater or less ingenuity, under contribution, as means of eliciting a *divine* answer to every question of their insatiable curiosity: e. g. the portents of the sky and sea (Pitarch, *De Superstitione*, passim); the mysteries of the grave (*νεκρομαντεία* and *σκιομαντεία*); the wonders of sleep and dreams (thought to be emanations from the gods, Homer, *Il.* i, 63; *Hymn in Mercur.* 14; Virgil, *Æn.* v, 898); the phenomena of victims sacrificed (in which the deities were supposed to be specially interested or near at hand; comp. the *ιερομαντεία* in Potter's *Gr. Ant.* ii, 14); the motions and appearance of the animal creation (such as the flight of birds, a copious source of superstition in the *ορνιθοσκοπία* of the Greeks and the *augurium* of the Latins, and the aspect of beasts); and the prodigies of inanimate nature (such as the *ενιδία σύμβολα*, omens of the sky, upon which whole books are said to have been written: the *κληθόντες*, ominous voices); and the long list of

magic arts, which may be found in Hoffmann's *Lezcon*, ii, 97, and Potter on the *Occult Sciences* (in the *Encycl. Metropol.* pt. v, which contains some thirty names ending in *-mancy*, or compounds of *μαντεια*, all branches of the magic art). Nor have these expellents of superstition been confined to one age or to a single nation. The meteoric portents, for instance, which used to excite the surprise and fear of the old Greeks and Romans, are still employed among the barbarians of Africa (e. g. *musana* of the Manika tribe, Krapf's *Trav. in E. Africa*, p. 115 sq.); and as the ancients read fearful signs in the fæces of animals (Virgil, *Georg.* i, 469), the savage Bakmains indicate the presence of the terrible alligator with their *boleo ki bo*, "there is sin" (Livingstone's *Trav. in S. Africa*, p. 225). See SUPERNATURAL. This art "of taking an aim of divine matters by human, which cannot but breed mixture of imaginations" (Bacon, *Ess.* xvii), accordingly has been universal in all ages and all nations, alike civilized and savage. It arises from an impression that, in the absence of direct, visible guiding Providence, the Deity suffers his will to be known to men, partly by inspiring those who from purity of character or elevation of spirit were susceptible of the divine afflatus (*θεομάντις, ἰθουσιαστραί, ἰκσταρικοί*), and partly by giving perpetual indications of the future, which must be learned by experience and observation (Cicero, *Div.* i, 18; Pliny, xxx, 5).

(a.) The first kind of divination was called *natural* (*ἀρεχνος, ἀδιδαστος*), in which the medium of inspiration was transported from his own individuality, and became the passive instrument of supernatural utterances (Virg. *Æn.* vi, 47; Ovid, *Met.* ii, 640, etc.). As this process involved violent convulsions, the word *μαντική, soothsaying*, is derived from *μαίνεσθαι*, to rave, and alludes to the foaming mouth and streaming hair of the possessed seer (Plato, *Tim.* 72, B, where the *μάντις* is carefully distinguished from the *προφήτης*). But even in the most passionate and irresistible prophecies of Scripture we have none of these unnatural distortions (Num. xxiii, 5; Psa. xxxix, 3; Jer. xx, 9), although, as we shall see, they were characteristic of pretenders to the gift. See SOOTHSAYER.

(b.) The other kind of divination was artificial (*τεχνική*), and probably originated in an honest conviction that external nature sympathized with and frequently indicated the condition and prospects of mankind—a conviction not in itself ridiculous, and fostered by the accidental synchronism of natural phenomena with human catastrophes (Thucyd. iii, 89; Josephus, *War*, vi, 5, 8; Foxe's *Martyrs*, iii, 406, etc.). When once this feeling was established the supposed manifestations were infinitely multiplied, and hence the numberless forms of imposture or ignorance called capnomancy, pyromancy, arithmomaney, libanomancy, botanomancy, cephalomancy, etc., of which there are abundant accounts in Cicero, *De Div.*; Cardan, *De Sapientia*; Anton. v. Dale, *De Orig. Idol.*; Fabricius, *Bibl. Antiq.* p. 409-426; Carpzov, *App. Crit.* p. 540-549; Potter's *Antiq.* i, ch. viii sq. Indeed, there was scarcely any possible event or appearance which was not pressed into the service of augury; and it may be said of the ancient Greeks and Romans, as of the modern New Zealanders, that "after uttering their karakias (or charms), the whistling of the wind, the moving of trees, the flash of lightning, the peal of thunder, the flight of a bird, even the buzz of an insect, would be regarded as an answer" (Taylor's *New Zealand*, p. 74; Bowring's *Siam*, i, 153 sq.). A system commenced in fanaticism ended in deceit. Hence Cato's famous saying that it was strange how two augurs could meet without laughing in each other's face. But the supposed knowledge became in all nations an engine of political power, and hence interest was enlisted in its support (Cicero, *De Legg.* ii, 12; Livy, vi, 27; Sophocles, *Antiq.* 1055; comp. Mic. iii, 11). It fell into the hands of a priestly caste (Gen. xli, 8; Isa. xlvii, 13;

Jer. v, 81; Dan. ii, 2), who in all nations made it subservient to their own purposes. Thus in Persia, Chardin says that the astrologers would make even the shah rise at midnight and travel in the worst weather in obedience to their suggestions. See ASTROLOGER.

The invention of divination is ascribed to Prometheus (*Æschylus, Pr. Vinct.* 492), to the Phrygians and Etrurians, especially sages (Cicero, *De Div.* 1; and Clem. Alex. *Strom.* i, 826, where there is a great deal more on the subject), or (as by the fathers generally) to the devil (Firmic. Maternus, *De Errore, Proëm*; Lactant. ii, 16; Minuc. Felix, *Oct.* 27). In the same way Zoroaster ascribes all magic to Ahriman (Nork, *Bram. und Rab.* p. 97). Similar opinions have prevailed in modern times (Sir Thomas Browne, *Vulgar Errors*, i, 11). See MAGIC.

Egypt, the cradle of arts and sciences, if she did not give it birth, seems to have encouraged the practice of divination at an early age; and, whether any of its forms had become objects of popular superstition, or were resorted to for the purposes of gain in the days of Joseph, it is well known that at the time of the Hebrew Exodus there were magicians in that country whose knowledge of the arcana of nature, and whose dexterity in the practice of their art, enabled them, to a certain extent, to equal the miracles of Moses. By what extraordinary powers they achieved those feats, how they changed their rods into serpents, the river water into blood, and introduced frogs in unprecedented numbers, is an inquiry that has occasioned great perplexity to many men of learning and piety. See JANNES (AND JAMBRES).

It is reasonable to suppose that as Moses never had been in any other civilized country, all the allusions contained in his writings to the various forms of divination were those which were practised in Egypt; and, indeed, so strong a taste had his countrymen imbibed there for this species of superstition, that throughout the whole course of their history it seems to have infected the national character and habits. Nor was it confined to the vicinity of Palestine, for as early as the time of Balaam (q. v.) we find it practised by professional characters to the very banks of the Euphrates (Num. xxii, 5, 7; see Biedermann, *De mercede divinatoria*, Vitemb. 1717). The diviners, who abounded both amongst the aborigines of Canaan and their Philistine neighbors (Isa. ii, 6), proved a great snare to the Israelites after their settlement in the promised land; and yet, notwithstanding the stern prohibitions of the law, no vigorous efforts were made to put an end to the crime by extirpating the practitioners of the unhallowed art until the days of Saul, who himself, however, violated the statute on the night previous to his disastrous fall (1 Sam. xxviii). But it was Chaldaea to which the distinction belongs of being the mother-country of diviners. See CHALDEAN. Such a degree of power and influence had they attained in that country, that they formed the highest caste and enjoyed a place at court; nay, so indispensable were they in Chaldaean society, that no step could be taken, not a relation could be formed, a house built, a journey undertaken, a campaign begun, until the diviners had ascertained the lucky day and promised a happy issue. A great influx of these impostors had at various times poured from Chaldaea and Arabia into the land of Israel to pursue their gainful occupation, more especially during the reign of the later kings (Isa. viii, 19), and we find Manasseh not only their liberal patron, but zealous to appear as one of their most expert accomplices (2 Kings xxi, 6; 2 Chron. xxxiii, 6). The long captivity in Babylon spread more widely than ever among the Jews a devoted attachment to this superstition; for after their return to their own country, having entirely renounced idolatry, and, at the same time, no longer enjoying the gift of prophecy or access to the sacred oracles, they gradually abandoned themselves, as Lightfoot has satisfac-

torily shown, before the advent of Christ, to all the prevailing forms of divination (*Comment. on Matt.*). See EXORCISM.

Superstition not unfrequently goes hand in hand with scepticism, and hence, amid the general infidelity prevalent through the Roman empire at our Lord's coming, imposture was rampant, as a glance at the pages of Tacitus will suffice to prove. Hence the lucrative trades of such men as Simon Magus (Acts viii, 9), Bar-jesus (Acts xiii, 6, 8), the slave with the spirit of Python (Acts xvi, 16), the vagabond Jews, exorcists (Luke xi, 19; Acts xix, 13), and other mountebanks (γύμνες, 2 Tim. iii, 13; Rev. xix, 20, etc.), as well as the notorious dealers in magical writings (Ἐπίσημα γράμματα), and the jugglers (περίεργα) at Ephesus (Acts xix, 19). Among the Jews these flagrant impostors (ἀπατεῶνες, Josephus) had become dangerously numerous, especially during the Jewish war; and we find them constantly alluded to in Josephus (*War*, vi, 5, 1, 2; comp. *Matt.* xxiv, 23-24; *Tacit. Hist.* v, 12; *Joseph. Ant.* xx, 5, 1, etc.). As was natural, they, like most Orientals, especially connected the name of Solomon with their spells and incantations (*Joseph. Ant.* viii, 2). The names of the main writers on this wide and interesting subject will be found mentioned in the course of this article, and others are referred to in Fabricius, *Bibl. Antiq.* cap. xii, and Böttcher, *De Inferis*, p. 101 sq. See CURIOUS ARTS.

Against every species and degree of this superstition the sternest denunciations of the Mosaic law were directed (*Exod.* xxii, 18; *Lev.* xix, 26, 31; xx, 27; *Deut.* xviii, 10, 11), as fostering a love for unlawful knowledge (comp. the *Koran*, ch. v; *Cato, De Re Rust.* 5; "vanâ superstitione rudes animos infestant;" *Columell.* ii, 1); because prying into the future beclouds the mind with superstition, and because it would have been (as indeed it proved to be, *Isa.* ii, 6; 2 *Kings* xxi, 6) an incentive to idolatry; indeed, the frequent denunciations of the sin in the prophets tend to prove that these forbidden arts presented peculiar temptations to apostate Israel (*Hottinger, Juris Hebr. leges*, p. 253, 254). But God supplied his people with substitutes for divination, which would have rendered it superfluous, and left them in no doubt as to his will in circumstances of danger, had they continued faithful. It was only when they were unfaithful that the revelation was withdrawn (1 *Sam.* xxviii, 6; 2 *Sam.* ii, 1; v, 23, etc.). According to the Rabbis, the Urim and Thummim lasted until the Temple; the spirit of prophecy until Malachi; and the Bath-Kol, as the sole means of guidance from that time downwards (*Maimonides, de Fundam. Leg.* cap. 7; *Abarbanel, Prolegg. in Daniel.*) See below.

How far Moses and the Prophets believed in the reality of necromancy, etc., as distinguished from various forms of imposture, is a question which at present does not concern us. But even if, in those times, they did hold such a belief, no one will now urge that we are bound to do so at the present day. Yet such was the opinion of Bacon, Bishop Hall, Baxter, Sir Thos. Browne, Lavater, Glanville, Henry More, and numberless other eminent men. Such also was the opinion which led Sir M. Hale to burn Amy Dunsy and Rose Cullenden at Bury in 1664; and caused even Wesley to say, that "to give up a belief in witchcraft was to give up the Bible." (For a curious statute against witchcraft [5 *Eliz.* cap. 15], see *Collier's Eccl. Hist.* vi, 366.) Much discussion, moreover, has been carried on by learned men to determine the question whether the ancient tribe of diviners merely pretended to the powers they exercised, or were actually assisted by demoniacal agency. The latter opinion is embraced by almost all the fathers of the primitive Church, who appeal, in support of their views, to the plain language of Scripture; to the achievements of Jannes and Jambres in the days of Moses; to the divine law, which cannot be chargeable with the folly of prohibiting

crimes that never existed; and to the strong presumption that pretensions to interpret dreams, to evoke the dead, etc., would never have met with credit among so many ages had there not been some known and authenticated instances of success. On the other hand, it has been maintained with great ability and erudition that the whole arts of divination were a system of imposture, and that Scripture itself frequently ridicules those who practised them as utterly helpless, and incapable of accomplishing anything beyond the ordinary powers of nature (*Isa.* xlvi, 11-13; *xliv*, 25; *Jer.* xv, 14; *Jonah* ii, 8). See WITCHCRAFT.

1. Of the many instances of divination which occur in Holy Scripture, some must be taken in a good sense. These have accordingly been classed by J. C. Wichmannshäusen (*Dissert. de Divinat. Babyl.* [ed. Hiclis et Messerer.], Viteb. 1720 sq.) as truly "divine." (See *Peucer, De præcipuis divinationum generibus, Zerth.* 1591; F. a. M. 1607.) See INSPIRATIONS.

1. *Cleromancy* (κληρομαντεία), divination by lot. This mode of decision was used by the Hebrews in matters of extreme importance, and always with solemnity and religious preparation (*Josh.* vii, 13). The land was divided by lot (לָּוּהַ, אֱלֹהִים, *sors*; *Num.* xvi, 55, 56; *Josh.* xiv, 2); Achan's guilt was detected by lot (*Josh.* vii, 16-19); Saul was elected king by lot (1 *Sam.* x, 20, 21); and, more remarkable still, Matthias was chosen to the vacant apostleship by solemn lot, and invocation of God to guide the decision (*Acts* i, 26). This solemnity and reverence it is which gives force to such passages as *Prov.* xvi, 33; xviii, 18. (See *Augustine, De Doctr. Christ.* i, 28; *Thom. Aquin.* ii, 2, qu. 95, art. 8.) Under this process of לָּוּהַ, or lot, were appointed the interesting ordinances of the scape-goat and the goat of the sin-offering for the people (*Lev.* xvi, 8-10). See LOT.

2. *Oneiromancy* (ὄνειρομαντεία), divination by dreams (*Deut.* xiii, 2, 3; *Judg.* vii, 13; *Jer.* xxiii, 32; *Joseph. Ant.* xvii, 6, 4). The interpretation of Pharaoh's dreams by the divinely-gifted Joseph (*Gen.* xli, 5-82), and the retracing and interpretation of those of Nebuchadnezzar by the inspired prophet (*Dan.* ii, 2, etc. and again iv, 19-28), as opposed to the divineness of false dreams (*Zech.* x, 2), are very prominent cases in point; and, still more, the dreams themselves divinely sent (as those in *Gen.* xx, 6; *Judg.* vii, 15; 1 *King* iii, 5; so those in *Matt.* i, 20; ii, 12, 13, 19, 22), must be regarded as instances of divination in a good sense, a heavenly oneiromancy (comp. Mohammed's dicta: "Good dreams are from God;" "Good dreams are one of the great parts of prophecy;" Lane's *Arab. Nights*, i, 68). This is clear from *Num.* xii, 6 (where dreams [to the sleeping] and visions [to the awake] are expressly mentioned as correlative divinations authorized by God), compared with 1 *Sam.* xxviii, 6. Many warnings occur in Scripture against the impostures attendant on the interpretation of dreams (*Zech.* x, 2 etc.). We find, however, no direct trace of seeking for dreams such as occurs in *Virgil, Æn.* vii, 81; *Plautus, Curcul.* i, 1, 2, 61. See DREAM.

3. The Urim and Thummim (*Num.* xxvii, 27), which seem to have had the same relation in true divination that the *Teraphim* (q. v.), or idolomancy, had in the idolatrous system (see *Hos.* iii, 4). See URM and THUMMIM. Similar to this was divination by means of the Ephod (q. v.).

4. *Phonomaney*, by means of the Bath-Kol (בַּת־קוֹל, daughter of the voice, i. e. direct vocal communication), which God vouchsafed especially to Moses (see *Deut.* xxxiv, 10). Various concomitants of revelation were employed by the Deity: as the *Rod-Serpent* (*Exod.* iv, 3); the *Leprous Hand* (*ver.* 4); the *Burning Bush* (ii, 4); the *Plagues* (vii-xii); the *Cloud* (xvi, 10, 11); but most instances are without phenomena (*Deut.* iv, 15; 1 *Kings* xix, 12, 13, 15, and perhaps *Matt.* iii, 13). This, the true Bath-Kol, must not be confounded with

be fabulous one of the Rabbis, which Dr. Lightfoot calls "a fiction of their own brain to bring their doctors and their doctrines into credit" (*Works*, iii, 132). See BATH-KOL.

5. The *Oracles*: first, of the Ark of the Testimony, or *Tabernacle* (אֲרוֹן הַבְּרִית), described in Exod. xxv, 22, and 1 Kings vi, 16-31 (comp. *Psa.* xxviii, 2); secondly, of the Tabernacle of the Congregation, or Testimony (אֲרוֹן הַתְּעוּדָה), described in Exod. xxix, 42, 48. In the account of the Temple, both in 1 Kings vi and Chron., the word בְּרִית is used fifteen times to designate the "Oracle," i. e. the Holy of Holies (see 1 Kings vi, 16), in which was placed the Ark of the Covenant (*ver.* 19), whose golden cover, called the Mercy-seat, was the actual *situs oraculi* (Hottinger, *Theol. Phil.* p. 866). That there were several oracles of heathen gods known to the Jews we may infer both from the mention of that of Baal-zebub at Ekron (2 Kings i, 2-6), and from the towns named Debir. "Debir quod nos *oraculum* sive *responsum* possumus appellare, et ut contentiosius verbum exprimamus e verbo λαλητήριον, vel locutorium dicere" (Jerome, *ad Eph.* i). The word "oracles" is applied in the N. T. to the Scriptures (*Acts* vii, 38; *Rom.* iii, 2, etc.). On the general subject of oracles, see Anton. v. Dale, *De oraculis*; Smith, *Dict. of Class. Ant.* art. *Oraculum*; Potter's *Antiq.* i, 286-826; Sir T. Browne, *Tract* xi, and *Vulg. Err.* vii, 12, etc. See ORACLE.

6. The *Angelic Voice*, דְּבַר מַלְאָךְ (e. g. *Gen.* xxii, 15; *Judg.* xiii, 8, 18). See ANGEL.

7. The *Prophetic Institution* (נְבִיאִים), see Buxtorf, *Lex. Rabb.* col. 1286). This was the most illustrious and perfect means of holy divination (as the *oracular* system in the heathen world was the most eminent perversion and imitation of it), and was often accompanied with symbolical action (2 Kings xiii, 17; *Jer.* li, 63, 64). We may learn the importance of the place it was designed to occupy in the Theocracy as a means of divination, by the express contrast drawn between it, on the one hand, and the divinations of idolatry on the other. *Comp. ver.* 14 with *ver.* 15 of *Deut.* xviii. (See Michaelis's *Laws of Moses*, art. xxxvi.) Under this head of prophecy we must, of course, include the *רוּחַ הַקֹּדֶשׁ*, as the Jews call the *Inspiration of the Holy Spirit*. The revelations of the Old Testament are most suitably included in these heavenly utterances, *Λόγια Θεοῦ*. (See *Heb.* v, 12; 1 *Pet.* iv, 11.) Such are the chief modes of divine communication to men, or inspired divination: they are referred to in *Heb.* i, 1. The antithesis there points to the Son of God as the Ultimate Oracle (the *Logos* of John), the fulfiller of the promise, which Moses gave when he prohibited all spurious divination. See PROPHECY.

8. Before we close our notice of divination in a good sense, we must adduce two instances of the Hebrew word at the head of this article, *קָסַם* (*kasm*). Of the thirty-one occurrences of this expressive term in the O. T., no less than twenty-nine bear an evil meaning. In *Prov.* xvi, 10, and *Isa.* iii, 2, we claim for it a good sense. In the former of these passages the noun *קָסַם* (*Sept.* *μαρτίον*; *Vulg.* *divinatio*) is rendered in the A. V. a *divine sentence* [*marg.* "divination"], and denotes "sagacity such as of diviners" (*Poll Synops.* in loc. Melancthon, as quoted by bishop Patrick in loc., refers to the acute wisdom of Solomon in his celebrated judgment, and of Gonzaga in his sentence on the governor of Milan, as instances of this *קָסַם*; we might add the case supposed by Solomon himself of the sagacious poor man who successfully defended the city against the mighty invader, *Ecl.* ix, 15). In *Isa.* iii, 2, the word occurs in the *Poel* form, *קָסַם* (*Sept.* *σφαχθίς*; *Vulg.* *ariolus*), and is rightly rendered in the A. V. *prudent*; the company in which the term is found requires for it a good signification. See above.

9. It only remains under this head to allude to the fact that great importance was peculiarly attached to the words of dying men. Now although the observed fact that "men sometimes, at the hour of their departure, do speak and reason above themselves" (*Relig. Medicæ*, xi), does not, of course, take away from the death-bed prophecies of Scripture their supernatural character (*Gen.* xlix; 2 Kings xiii, etc.), yet it is interesting to find that there are analogies which resemble them (*Jl.* xxii, 355; and the story of Calanus; Cicero, *De Dic.* i, 80; *Shaksp. Rich.* II, 2, 1; Daniell, *Civil Wars*, iii, 62, etc.).

II. Forms of divination expressly *forbidden* in Scripture. Allusion has already been made in this article to *Deut.* xviii, 10-12. As these verses contain the most formal notice of the subject, we will first take the seven or eight kinds of diviners there denounced in the order in which they are mentioned.

1. At the very outset we encounter in the phrase *קָסַם קְסָמִים*, *kosem' kesamim*, one *divining divinations* (*Sept.* *μαρτυρόμενος μαρτίαν*, *Vulg.* *qui ariolos sciiscitatur*, A. V. "that useth divination"), the same word which we have just noticed in a good sense. The verb *קָסַם*, like the Arabic equivalent, primarily signified to *cleave* or *divide* (*Meier, Hebr. Würtzelwörterbuch*, p. 344; Fürst, *Hebr. Wörterb.* ii, 322; Hottinger, *Lex. Heptagl.* xlii, 1); whence it acquired the sense of *deciding* and *determining*, and became a generic phrase for various kinds of divination. Rabbi David de Pomis says, "It is a word of large signification, embracing many specific senses, such as geomancy, necromancy, oneiromancy, cheiromancy, and others." Maimonides (in his treatise *עבודת כוכבים* *Ulkhor' Uker' cap.* xi, § 6) includes besides these methods, *gastro-mancy*, *lithomancy*, and *catoptromancy*; and Rashi (on *Deut.* xviii, 10) makes *קָסַם* mainly concerned with the process of *rhabdomancy*. Amid the uncertainty arising from this generic sense of the word, the *Sept.* has rendered it by the general phrase *μαρτυροῦσαν μαρτίαν*, to *discriminate a divination*; wherein it is followed by the Targum of Jonathan, as well as by the Syriac and Arabic versions (*J. Clodius, Dissert. de Magia Sagittar.* [Viteb. 1675] i, 5; and Wichmannshausen, *Dissert.* i, 4). The word is used of Balaam (*Josh.* xiii, 22), of the Philistine soothsayers (1 *Sam.* vi, 2), of the Hebrew false prophets (*Micah* iii, 8, 6, 7, 11, and in other passages), without specifying any mode of divination. We therefore regard this as a general phrase introductory to the seven particular ones which follow. The absence of the copulative *ו*, which is prefixed to every other word but *בְּטוּיִן*, confirms this view. As the word, however, involves the notion of "cutting," some connect it with the Chald. *קָסַר* (*to cut*), *Dan.* ii, 27; *iv*, 4, etc., and to be taken to mean astrologers, magi, genethliaci, etc. (*Juv. vi*, 582 sq.; *Diod. Sic.* ii, 80). Others refer it to the *αληγομαντικ* (*Schol. ad Eur. Hipp.* 1057), since the use of lots was very familiar to the Jews (*Gatakera on Lots*, ad *inf.*); but it required no art to explain their use, for they were regarded as directly under God's control (*Num.* xxvi, 55; *Esth.* iii, 7; *Prov.* xvi, 33; xviii, 18). Both lots and *digitorum micatio* (odd and even) were used in distributing the duties of the Temple (*Otho, Lex. Rab. s. v. Digitis micando*). See above.

2. *בְּטוּיִן*, *meimén'*. This word is variously derived and explained. In our A. V. it is, in two out of seven times of its occurrence (besides the *pret.* and *fut.*), rendered "observer of times" (as if from *בְּטוּיִן*, a *set time*, Fuller, *Misc. Sac.* i, 16, after Rashi). The idea is, the *assigning certain times to things*, and distinguishing by astrology lucky from unlucky days, and even months (as when Ovid [*Fasts*] says, "Mense malum maio numero vulgus ait") and years (Maimonides, *Aboda Sara*, cap. 9; Spencer, *De Leg. Hebr.* i, 387). So perhaps in

Job iii, 5, just as the Greeks and Romans regarded some days as *candidi*, others as *atri* (Hesiod. *Opp. et D.* 770; Sueton. *Aug.* 92, etc.). It is not necessary to refer Gal. iv, 10 to this *superstitio*; the Mosaic institution of sacred seasons is itself there prohibited, as being abrogated to Christians (Selden, *De ann. civit. vet. Jud.* c. 21; and Alford, in loc.). The Sept. version, by the verb and part. κληδονίζεσθαι (in four places), and the noun κληδονισμός (in two others), refers to divination by words and voices (Suidas, κληδονισμοί, αὶ διὰ τῶν λόγων παραρηθίσις). Festus derives *omen* itself (quasi *ostamen*), because it proceeds from the mouth (*quia fit ab ore*). Words of ill omen (ὄνσημια), which Horace calls *malè ominata verba*, and Plautus *obscinata* [prob. *obscavata*], were exchanged for *bona nomina*, as when Cicero reported to the Senate the execution of Lentulus and others by the word "vixerunt," they have ceased to live, instead of "mortal sunt," they are dead. So Leotychides embraced the omen of Hagesistratus (Herodot. xi, 91). Hebrew instances of this observing of words occur in Gen. xxiv, 14, and 1 Sam. xiv, 9, 10, where a divine interposition occurred; in 1 Kings xx, 33, the catching at the word of the king of Israel was rather a human instinct than a παραρηθίσις, or *marking*, in its proper (superstitious) sense. Akin to and arising from this observance of verbal omens arose the forms of *bibliomancy* called *Sortes Homerice*, *Virgilianæ*, *Biblicæ*, etc. The elevation of Severus is said to have been foretold by his opening at Virgil's line, "Tu regere imperio populos, Romane, memento." Most remarkable were the responses which it is said Charles I and Lord Falkland obtained, when they consulted their Virgils before the civil war. The former opened *Æneid* iv, where Dido predicts a violent death to *Æneas*, while the latter chanced upon *Æneid* xi, at Evander's lamentation over his son. According to Nicephorus Gregoras, the *Pealbar* was the best book for the *Sortes Biblicæ*, but Cedrenus informs us that the *N. T.* was more commonly used (Niceph. Greg. viii, Aug. Ep. 119; Prideaux, *Connect.* ii, 376, etc.; Cardan, *De Varietate*, p. 1040). This superstition became so rife that it was necessary to denounce it from the pulpit as forbidden by the divine precept, "Thou shalt not tempt the Lord thy God." The Moslems consult the Koran in similar manner, but they take their answer from the seventh line of the right-hand page (see *Occult Sciences*, p. 332). A belief in the significance of chance words was very prevalent among the Egyptians (Clem. Alex. *Strom.* i, 304; Plutarch, *De Is.* 14), and the accidental sigh of the engineer was sufficient to prevent even Amasis from removing the monolithic shrine to Sais (Wilkinson, *Anc. Egypt.* iv, 144). The universality of the belief among the ancients is known to every scholar (Cicero, *De div.* i; Herod. ii, 90; Virgil, *Æn.* vii, 116, etc.). See BRIBLOMANCY.

Another origin for טענין is found by some (comp. Vitringa, *Comment. ad Isa.* ii, 6) in the noun טען, the eye, the root of which occurs once only (1 Sam. xviii, 9) as a verb, "Saul eyed David." This derivation would point to *fascination*, the Greek βασκανία and the Latin *fascinum*. Vossius derives these words from φάσει κείναι, to kill with the eyes. Pliny (Holland's transl. i, 155) says: "Such like these are among the Triballians and Illyrians, who with their very eyesight can witch (effascinate), yea, and kill those whom they look wistly upon any long time" (comp. Aul. Gell. ix, 4, 8; Plutarch, *Sympos.* v, 7). Reginald Scot speaks of certain Irish witches as "eyebiters" (*Discovery of Witchcraft*, iii, 15). Whole treatises have been written on this subject, such as the *De Fascino*, by the Italian Vairus in 1589; the *Opusculum de Fascino*, by Gutiérrez, a Spaniard, in 1563; and the *Tractatus de Fascinatione* in 1675, by a German physician called Frommann. (See also Shaw, *Trav.* p. 212.) In Mar-
's *Description of W. Isles of Scotland*, "Molluca

beans" are mentioned as amulets against *fascinatio*. Dallaway (*Account of Constantinople* as quoted in *Cult Sciences*, p. 210) says that "nothing can exceed the superstition of the Turks respecting the evil eye of an enemy or infidel. Passages from the Koran painted on the outside of houses, etc., to divert the sinister influence." A belief in the "evil eye," ἰσχυρὸς βάσκανος (טען טען), was universal, and is often alluded to in Scripture (Deut. xxiii, 3; Matt. xx, 17; Tob. iv, 7, μὴ φθονήσῃται σου ὁ ὀφθαλμός; 1 Sam. xviii, 9, "Saul eyed David"). The passages of the ancients on the subject are collected in Potter's *Ant.* i, 383 sq. See EYE.

But the derivation of טענין which finds most favor with modern authorities deduces the word from טען, a cloud, so that the diviner would ply his art by watching clouds, thunders, lightnings (Meier, *Hebr. Wörterb.* v. 6, p. 92; First, *Wörterb.* ii, 167, who, however, finds room for all the derivations; and Gesenius, s.v. טען, leans to the figurative sense of *to cloud*, viz. *use covert arts*). Rosenmüller, *Scholæ in Levit.* ix, 26, follows Aben Ezra, who thinks this diviner obtains his omens from observation of the clouds. The notion that the terms טען, east, ארור, west, טען, south, טען, north, were derived from the position of the *Planetarius* as he faced the east, taking his celestial observations (Goodwin's *Moses and Aaron*, iv, 10), is rejected by our annotator Carpov with the greatest disgust. Jeremiah (x, 2) clearly refers to this divination, which had its counterpart in Greek and Latin literature (e. g. in *Il.* ii, 352, Nestor speaks of right-linè flashes as being lucky (see also *Odys.* xv, 804). Diodorus Siculus (iii, 340, ed. Bipont.) mentions the divination by means of thunder (κεραυνοσκοπία, and the αἰνὰ τοῖς κεραυνῶν διοσημῖαι) of the Etrurians (comp. "fulguratores—hi fulgurum inspectores," Cato, *Is. Mor. Claud. Neron.*; Nonius, lxxiii, 21; Cicero, *De Div.* ii, 58. [In Orelli, 2301, *fulgurator.*]) Pliny, in Æ 43, treats of the *physical*, and in ii, 54, of the *oracular* qualities of thunder, lightning, etc.; as does L. A. Seneca in *Natur. Quæst.* ii, 41. Statius mentions the winds for purposes of divination (*Thebaid.* iii, 512-538). See Humboldt, *Kosmos*, ii, 135, for the probable scientific adaptations by the Etrurians of their divining arts. To this class we must refer "the astrologers" (טענין) here only found; "the star-gazers, or rather star-prophets" (הדוברים בכוכבים) and "the monthly prognosticators," or rather they that make known at the new moons what will happen to thee (הדוברים לחדושים עתה עתה, טענין; see Rosenmüller, in loc.), which are all mentioned in the sublime challenge of God to the Chaldee sorcerers in Isa. xlvii, 13. Astrology retained a long hold even on the minds of astronomers; e. g. Stoffer in his evaluation predicted a deluge for 1524; Cardan his own death: Wallenstein was a great amateur of astrology; Tycho Brahe studied and practised it; so did Morinus; Kepler supposed that the planets by their configurations exercised certain influences over *sublunary nature*; Lord Bacon, moreover, thought that astrology needed only to be reformed, not rejected (Arago, *Pop. Astron.* [by Smyth and Gauss] ii, 8; Brewster, *Martyrs of Science*, 150, 211). See PROGNOSTICATOR.

In Judg. ix, 37, the expression "oak of Meonenim (enchantments)" refers not so much to the general sacredness of great trees (Homer, *Od.* xiv, 328, as to the fact that (probably) here Jacob had buried his amulets (Gen. xxxv, 4; Stanley, *Sin. and Pal.* p. 142). See MEONENIM.

3. The next word in our list (Deut. xviii, 10) is טענין, *menachesh*, "an enchanter," (Sept. οἰστροποιός; Vulg. qui observat auguria). In Gen. xlv, 3, is this somewhat general word is used of divining by the cup, or *cylicomancy* (κυλικομαντία). Primatively the

as the dinking-cup which contained the libation to the gods (Potter). This divination prevailed more in the East and in Egypt. The *kyvov*, used in the Septuagint, designate Joseph's cup, resembles both the Arabic *kuh* and the Hindu *kundli*, sacred chalice (Schleusner, *er. V. T. s. v.*; Kitto, *Bib. Illus.* i, 898). One of the Assyrian kings, in the sculptures from Nimroud, holds a *divining-cup* in his right hand (Bonomi's *Nineveh*, x. p. 306). The famous cup of Jemshid, which is the constant theme of the poetry and mythology of Persia, was said to have been discovered full of thelixir of immortality, while digging to lay the foundation of Persepolis. It possessed the property of representing the whole world in its concavity, and all things good and bad then going on in it. Homer describes Nestor's cup in similar manner; and Alexander the Great had a mystic cup of a like kind. In the storming of Seringapatam the unfortunate Tipoo Saib refused to gaze on his divining-cup; after standing a while absorbed, he returned to the fight and soon fell. The "great magicien" Merlin's cup is described (Spenser's *Faerie Queene*, iii, 2, 19), "Like to the world itself, it seem'd a world of glas." In Norden's *Travels in Egypt*, and Capt. Cook's *Voyages*, the use of divining-cups in modern Nubia and at Tongataboo, one of the Friendly Islands, is mentioned (compare Kitto, *Daily Bible Illustrat.* i, 424). The Orientals ascribe much of Solomon's wisdom to his possession of a sacred cup, a *Giameshid*, or *vase of the sun* (D'Herbelot, *s. v. Iliam*; *Occult Sciences*, p. 817). Parkhurst and others, denying that divination is intended, make it a mere cup of office (Bruce's *Travels*, ii, 657), "for which we would search carefully." But in all probability the A. V. is right. The Nile was called the cup of Egypt, and the silver vessel which symbolized it had orphetic and mysterious properties (Hävernick, *Eiml. d. Pentat.*). The divination was by means of radiations from the water, or from magically-inscribed gems, etc., thrown into it (a sort of *ύδρομαντεία*, *κατορτρομαντεία*, or *επισταλλομαντεία*, Cardan, *De rerum Variet.* cap. 93), like the famous *mirror of ink* (Lane, *Mod. Eg.* ii, 362), and the crystal divining-globes, the properties of which depend on a natural law brought into notice in the recent revivals of Mesmerism. Jul. Cærenus (*De Fato*, ix, 18) says that after certain incantations a demon was heard in the water. For illustrations of Egyptian cups, see Wilkinson, iii, 258. This kind of divination is not the same as *cythomancy* Suidas, *s. v. κορραβίζεω*), which consists in drawing omens from a common drinking-cup; much like the vulgar practice, still prevalent, of reading fortunes in the fantastic forms assumed by the grounds in a tea-cup. See *Cup*.

But the versions of the Sept. and Vulg. give quite a different turn to our *קַנְיָה*, and point to that part of the augural art which consisted of *omens from birds*, i. e. *ornithomancy* (*ὀρνιθομαντεία*, *οἰωνομοσία*, *ὀρνιθοσκοπική*). The Syriac and Arabic versions favor this view (=augurari ab animalī alato). Birds in their flight over the earth were supposed to observe men's secret actions, and to be cognizant of accidents, etc. (comp. Eccl. x, 20). Aristophanes (*Birds*) says, "None but some bird, perhaps, knows of my treasure;" so that the birds assume prerogatives of deity; "We are as good as oracles and gods to you," etc. The notes, the flight, and the feeding of birds were the main phenomena (Bochart, *ad. Leusd.* ii, 19). Homer is full of this divination (*Il.* xii, 310; *Od.* xv, 160, et passim). So the Latin classics; see Servius, *Virg. Æn.* iii, 361 ("aves oscines, præpetes"); also Cicero, *Fam.* vi, 6, 18; *De Divin.* ii, 2, etc.; and Livy, x, 40 (*tripudium solistimum*). For qualities of various birds, see Potter, xv, and *Occult Sciences*, p. 142, 148. This divination was much in vogue in the East also; so Philostratus (*Vit. Apollon.* i, 4) and Porphyry (*De Abstinent. Animal.* iii) say. Rabbinical doctors discover *augury* among king Solomon's

attainments, in such passages as Eccl. x, 20, and 1 Kings iv, 30. Rashi comments *קַנְיָהוּ דְּבַר שׁוֹן*, *learned in the tongue of birds*; so Kimchi and the *Milbar Rabba*, xix. See ENCHANTER.

The root *קנח* has the primary sense of a low hissing, *whispering sound*; from this arises the derivative *קנח*, a serpent, of frequent occurrence in the O. T. Gesenius, *Theas.* p. 876; *Lez.* by Robinson, p. 665; and Fürst, *Hebr. Wörterb.* p. 31, prefer to derive from the primary sense (q. d. *divinare vel augurari* as general terms); but Bochart, ii, 21, 22, peremptorily derives from the secondary sense of the *serpent*, and discovers in this *קנח* the divination called *ophiomancy* (*ὀφιομαντεία*). Fürst admits this as "tolerable." Classical instances of divining by serpents occur in *Iliad*, ii, 808; *Æneid*, v, 84; Cicero, *De Div.* i, 18, 86; Valer. Maxim. i, 6, 8; Terent. *Phorm.* iv, 4, 26; Clem. Alex. *Strom.* vii; Horace, *Carm.* iii, 27, 5. (According to Hesychius, *s. v. οἰωνός*, and Suidas, *s. v. οἰωνοσκοπία*, omens from serpents as well as from birds formed a usual branch of the augur's art; hence probably the general phrase employed in the Sept. and other versions.) *Serpent-charming*, referred to in *Psa.* lviii, 5, and *Jer.* viii, 17, is a part of this divination. Frequent mention of this art also occurs in both ancient and modern writers. (See Kalisch on *Exod.* vii, 12, who refers to Ælian, *Hist. Anim.* xvii, 5; *Sil. Italic.* iii, 800; Strabo, xii, 814; Gellius, *Noct. Attic.* xvi, 11; Shaw, *Travels*, p. 354; Niebuhr, *Travels*, i, 189; Bochart, *Hieros.* iii, 162; *Description de l'Égypte*, viii, 108; xviii, 1, 338 [in i, 159, there is a description of the feats of some Cairo jugglers with the *serpent Haje*]; Quatremère, *Mém. sur l'Égypte*, i, 202; Minutoli, *Travels*, p. 226; Hengstenberg, *Mos. and Egypt*, p. 97-108; Lane, *Mod. Egypt*, ii, 230). The serpent was the symbol of health and healing (Plin. *xiv.* 4, 22); Moses's brazen serpent (Num. xxi, 9), which was a symbol of deliverance (*Wisd.* xvi, 6; comp. John iii, 14), was at length made an object of idolatrous worship. Hezekiah, to destroy the charm, reduced its name to its mere material (*קַנְיָהוּ* = *קַנְיָהוּ*), 2 Kings xviii, 4. See NEHUSHTAN. These *menacheshim*, therefore, were probably *ophiomants*—people who, like the ancient Paylli (Pliny, *H. N.* vii, 2; xviii, 4) and Marmaridæ (Sil. Ital. iii, 301), were supposed to render serpens innocuous and obedient (*Exod.* vii, 9; *Jer.* viii, 17; *Eccl.* x, 11), chiefly by the power of music (Nicand. *Métriac.* 162; Lucan, ix, 891; *Æn.* vii, 753), but also, no doubt, by the possession of some genuine and often hereditary secret (Lane, *Mod. Egypt*, ii, 106 sq.; Arnob. *adv. Gent.* ii, 82). They had a similar power over scorpions (Francken's *Tour to Persia*). See CHARMER.

4. *קַנְיָהוּ*, *mekashsheph'* (Sept. *φαρμακός*; Vulg. *maleficus*; *Ant.* Ver. "witch"). This word has always a bad sense in the Old Test. in the twelve instances in which the verb [always *Piel'*] and the noun are used. The Syriac, however (*kasap*), bears the good sense of *prayer* and *public service* to God (*δένουσι*, *λειτροπυγία*, in Acts iv, 31; xiii, 2). The Arabic (*kashaf*) suggests the meaning of the missing Kal="to reveal." In *Exod.* vii, 11, this word describes (in plur.) the magicians of Pharaoh, who are also there called *קַנְיָהוּ*, *sages*, and (as also in vii, 22; comp. Gen. xli, 8, 24) *קַנְיָהוּ*, *ισογογραμματαίς* (Clem. Alex. vi, 688), or *sacred scribes* of Egypt. This latter title identifies these with the Magi, or *sacerdotes*, of the Chaldean court (see Dan. ii, 10, 27). The prophet was himself made by the king of Babylon *קַנְיָהוּ*, "master of the magicians" (Dan. v, 11). The arts of these diviners (*קַנְיָהוּ*, *Exod.* vii, 11; *קַנְיָהוּ*, ver. 22), which enabled them to withstand Moses, were doubtless imposing, but so inferior to the miracles by which they were ultimately foiled (viii, 19), and their gods

confounded (xii, 12). The conjecture of Aben Ezra, that it was "their skill in the secrets of physical science" (quoted in Carpzov, *Apparatus*, p. 543), such as is attributed to the Etrurian *fulguratores* by Humboldt (*Kosmos*, l. c.), which enabled them to sustain their impious contest, is not unreasonable. The names of two of these *chartumimim* (or חַרְטוּמִּיִּם) are given by Paul, 2 Tim. iii, 8. (For Talmudic traditions about these, see Buxtorf, *Lex. Tal.* col. 945; comp. Pliny, *Hist. Nat.* xxx, 1, who associates *Jannes* and *Jataptes* with Moses as *Jews*; Apuleius, *Apol.* 108 [ed. Casaub.], who mentions *Moses*, *Jannes*, etc., as *inter magos celebrati*; Numenius Pythag. in Eusebius, *Prep. Evang.* ix, 8, who mentions *Ἰαννῆς καὶ Ἰαυβῆς Αἰγυπτίους* and *Μουσαῖος ὁ Ἰουδαῖος*. The Moslems call these magicians *Sadur* and *Gadur*; D'Herbelot, s. v. *Moussa*; and Sale, *Koran*, p. 237; Schoettigen, *Hor. Hebr.* p. 893; Rosenmüller, on *Exod.* l. c.). How they produced the wonders which hardened the heart of Pharaoh, whether by mechanical or chemical means, or by mere legerdemain, or by demoniacal assistance (as supposed by the fathers, and Josephus, *Ant.* ii, 5), we can only conjecture. The N. T. gives us the names of other diviners also—in this respect differing observably from the reserve of the O. T.—e. g. of Simon Magus (Acts viii, 9, *μαγέωσ*); of Barjesus or Elymas (Acts xiii, 6, 8, *ὁ μάγος*); the sons of Sceva (Acts xix, 18, 14, *ἑξορκισταί*). We have alluded to the supposed scientific basis of the arts of these חַרְטוּמִּיִּם, or חַרְטוּמִּיִּים (for the identity of these, see Kalisch, on *Exod.* p. 114; and Keil and Delitzsch's *Bibl. Commentar.* i, 357). The term under consideration might no doubt involve the use of divining-rods for the purpose of finding water (aquelicism), etc., dependent on physical laws only partially understood (Mayo's *Pop. Superstitions*). See **MAGICIAN**.

By Umbreit, on *Job*, and Deyling (*Observ. Sacr.* iii, 129), the words יוֹם כְּפֹרֶיךָ יוֹם, "the blackness of the day," in *Job* iii, 5, are taken to mean certain "incantations which darken the day," practised by magicians (some think them also indicated in the 8th verse by the words אֲרִירֶיךָ יוֹם, "that curse the day") who were able, as the superstitious imagined, to change the brightest day into the darkest midnight. Popular ignorance has always connected magical power with scientific skill. The foretelling of the rise and setting of sun, moon, and stars, and the prediction of eclipses, used to invest astronomers of old with a *marvellous* reputation (Virgil, *Æn.* iv, 489; Ovid, *Metam.* xii, 263; Horace, *Epod.* v, 45; Tibull. i, 2, 42. So Shakspeare, *Temp.* v, 1). In *Exod.* xxii, 18, the feminine חַרְטוּמִּיִּת, *mekashshephak'*, occurs (also translated a *witch* in the A. V.). In the Theocratic system, where women as well as men were endued with supernatural gifts (such as Deborah, Hannah, Huldah), female pretenders were to be found—indeed, according to Maimonides (*Moréh Neb. Neb.* iii, 37), and Babyl. Gemara (*Sanhed.* in Ugolini *Thez.* xxv, 776), they were more rife even than males. Their divination is referred to in Ezek. xiii, 23, and described ver. 17-22 (comp. Triumphii *Dissert. de pulchellis et peplis prophetiss.* in *Thez. Nov. ad Crit. Sacr.* i, 972, and Ephrem Syrus, in Rosenmüller *ibid.*, who supposes the "pillows" to be amulets for divination fitted to their sleeves). See **WITCH**.

5. The next phrase in the Moesic catalogue of forbidden divination is (*Deut.* xviii, 11) חֹבֶר', *chober'*, "a charmer" (Sept. *trasiδωv*; Vulg. *incantator*). The root *chabar* denotes *binding*, or *joining together*. Gesenius (by Robinson, p. 293) refers to a species of magic which was practised by *binding magic knots* (comp. Gordian *knot*). Carpzov (*Apparatus*, p. 544) quotes Rabbinical authority, and Bochart (*Hieroz.* ii, 6), for a kind of divination which *drew together* noxious creatures (serpentes and scorpiones) for purposes

of sorcery; and in *Psa.* lviii, 6, the very phrase *incantatio* is applied to *serpent charmers*. (See above, note 8.) Gaulmin (in Carpzov) mentions *χαρμῆς* (see above) as if the very gods might be bound by magic art. In Sept. version suggests our *spell-bound*. "Spell is a kind of incantation *per sermones vel verba*," says Sæner. Hence the frequent allusions to such a charm as poetry. The refrain in the chorus of the Furies (Aeschylus, *Eumen.* 296, 318, 327), *ἀνομά* (a spell-bound) imitated by Byron (*Manfred*, i, 1). So Milton (*Gen.* 852); Jonson's witch (in the *Sad Shepherd*) is said "to rivet charms;" comp. Beaumont and Fletcher (*The Loyal Subject*, ii, 2). This last quotation directs us to the best explanation of divination by חַבַּר. Its idea is *binding together*; the ring has always been regarded as the symbol of such conjunction (comp. *wedding-ring* in the marriage service of the Church of England). In the phenomena of *dactylomancy* (ἀκτυλογαγία), a divination by ring (Potter, ii, 18; Smedley, *Gen. Sciences*, p. 37-40, 348), we have the most exact illustration of the subject before us. Josephus (*Ant.* vii, 2, 6), among the attributes of king Solomon's wisdom, ascribes to him much magical skill, and, with the respect to necromancy and spells, and goes on to specify an instance of exorcism by virtue of Solomon's magic ring. D'Herbelot (s. v. *Giam*, already quoted) calls *Jemsh' the Solomon of Persia*; and, according to Muraoka (*Reise*, p. 88), Solomon is ordinarily regarded in Mesopotamian countries as the great master of divination. See **CHARMER**.

6. חֹבֶר' אִיב, *chober' ob*, "a consulter with familiar spirits" (Sept. *ἐγγαστριμύθος*; Vulg. *qui Psalms consulit*). Most writers treat this class of diviners as *aromancers* (so Gesenius, *Thez.* p. 84). But, whatever be the close connection of the two as deducible from other passages, it is impossible to suppose that in *Deut.* xviii, 11, חֹבֶר' אִיב is synonymous with חֹבֶר' אִיב, which follows almost next. Böttcher, in *Inferis*, carefully distinguishes between the two expressions (p. 108), and then identifies the חֹבֶר' אִיב, which occurs in the plural in *Job* xxxiii, 19 (in its primary sense of a *leathern bottle*, or *water-skin*), with the *אִיב* of the same form which is found in so many other passages with a different meaning. In these the Sept. has invariably used *ἐγγαστριμύθος*, which connects our phrase with *ventriloquism*, as a branch of the divining art. (For the supposed connection between the primary and secondary senses of חֹבֶר' אִיב, see Gesenius, *Thez.* p. 84, and *Lex.* by Robinson, p. 20; also Böttcher, p. 107. The analogy is also in close consistency with the words of *Job*.—Umbreit, *ibid.* Having settled the sense of the word, Böttcher goes on to draw a noticeable distinction in certain phrases where it occurs. First, חֹבֶר' אִיב in the singular number designates the *familiar spirit* (i. e. what he calls "murmelbauch," *venter fremens* [in a correct sense], or "murmelwesen," *dæmon fremens* [in a superstitious sense]). Hence we have such phrases as חֹבֶר' אִיב *mistress* [or owner] of a *familiar spirit* (1 Sam. xxvii, 7); חֹבֶר' אִיב, a *consulter* or *questioner* of a *familiar spirit* [i. e. says Böttcher, "ventriloquus vates ipse"] (*Deut.* xviii, 11). Secondly, חֹבֶר' אִיב, when governed by the particle *בְּ*, refers not to the *vates*, or professional consulter, but to the person who requests his aid: thus, while חֹבֶר' אִיב is said of the diviner (*loc. cit.*), חֹבֶר' אִיב *בְּאִיב* (with the particle) is applied to King Saul, who sought the familiar spirit by the aid of the *vates*, or *pythonissa* (1 Chron. x, 13). "The same distinction," says Böttcher, "is also maintained by the Targumists and Talmudists." (Comp. 1 Sam. xxvii, 7. "Divine to me, חֹבֶר' אִיב, by the familiar spirit.") Thirdly, חֹבֶר' אִיב, in the plural, is used in a *concrete sense* by

cate the ventriloquists or diviners themselves, and the "familiar spirits" which were supposed to act: them (*De Inferis*, p. 101, § 205, where the learned ter adduces similar cases of metonymy from other guages: as *γαρσίεις ἀργαί*, "slow-bellies," Tit. i, so our "Wits about town"; the German "Witzfe," "Dickbäuche," etc.) By this canon we diser the general accuracy of our A. V. in such pases as Lev. xix, 31, where חַזְוֹנִים is well rendered, *hem that have familiar spirits.*" Comp. Lev. xx, 6; am. xxviii, 8, 9; 2 Kings xxiii, 24; Isa. viii, 19; 3. In Isa. xxix, 4, the same concrete rendering applied to אֱלֵי in the singular, contrary to Bött-r's first and third canons; but this rendering is rior to what Böttcher would suggest, viz. "They ce shall be as of a familiar spirit, out of the ground."

This is the only passage where the accuracy of version, thus tested, seems to be at fault; it con-sts strikingly with the Sept. in this point, which intains no distinction between the sing. and the r. of this word, other than the mechanical one of ting *ἐγγαστριμύθος* for אֱלֵי, and *ἐγγαστριμύθου* אֱלֵי. The Vulgate is more cautious, e. g. it ren-s most of the plurals *magi*, rightly, but is, on the ole, inferior to the A. V. in accuracy, for it trans-es both the sing. אֱלֵי of 2 Kings xxi, 6, and the r. אֱלֵי of 2 Kings xxiii, 24, by the same word, *thomes*, and similarly Isa. viii, 19, and xix, 8. (For description of the Delphian Pytha, or Pythonissa, d why ventriloquist faculties were attributed to her hence one of her designations, *ἐγγαστριμύθος*), see ter's *Antiq.* c. ix.) A vast amount of information iching the Hebrew *γαστρομαντεία*, and its connec-n with the witch of Endor, is contained in the trea-e of Leo Allatius, and Eustathius Antiochen., *De gastrimytho*; and the *Samuel redivivus* of Michael thard, all reprinted in *Critici Sacri*, viii, 808-458. e also St. Chrysostom, *Opera* (ed. Bened.), vii, 445. concise statement is contained in Böttcher's work, 111-115. The identity of אֱלֵי and אֱלֵי with nec-mancy, contrary to Böttcher's view, is maintained in . Millii *Dissertatio*, especially in chap. vi, whom Ge-nius follows in *Theo.* s. v. אֱלֵי. See the *Dissertatio* Ugol. *Theaur.* xxiii, 517-528. For ancient Jewish nigons on the apparition of Samuel to Saul, see Jo-phus, *Ant.* vi, 14, 2, and Whiston's note in loc.; also celesiasticus xvi, 20. On this subject, the second tr of Sir W. Scott, *On Demonology and Witchcraft*, ith the note in the appendix of the volume, is well orthy of perusal. Whatever reality God may have rmitted to this remarkable case of divination, the sort to it by Saul was most offensive to the divine eing; the king's rejection is partly ascribed to it in Chron. x, 13: somewhat similar is the reason as-gned for God's vengeance on Manasseh (2 Kings xi, 11. See the remarkable canons 61 and 65 of the rullan [*Quinisextum*] Council; Beveregii *Synod.* i, 27, 285). See FAMILIAR SPIRIT.

7. יִדְעוֹנִי, *yiddeoni*, from יָדַע, to know, is uniformly ndered in A. V. by "wizard," akin to "wise" and the German verb "wissen" (old German *wisjan*), to now. (Sept. in four places, *γινώσκω*, a knowing one; "ulg. *ariolos*, most frequently.) This Hebrew noun occurs eleven times, and in every instance is coupled rith אֱלֵי; we may thus regard it as indicating a usu-l concomitant (perhaps of cleverness and dexterity) vith ventriloquism: this view is confirmed by the lept. *ἐγγαστριμύθος*, as the rendering of יִדְעוֹנִי in Isa. ix, 3, a verse which proves the Egyptian arts of divi-ation were substantially the same as the Hebrew in hat age (comp. Böttcher, p. 115, § 281; and see Raw-inson's note on *Herod.* ii, 83, in explanation of a seem-ning discrepancy between the prophet and the histori-

an). In another passage of Isaiah (viii, 19) there oc-curs a good description of these יִדְעוֹנִים, in the two epithets *קוֹרְאֵי צִפְצִפִּים*, expressive of the *chirping, pip-ing* sounds of young birds, and *קוֹרְאֵי דוֹב*, applied to the cooing of the dove, in viii, 19. (With the former of these, compare Horace, *Sat.* i, 8, 40, and with the latter, Virgil, *Aeneid*, iii, 89. So in Homer, *Il.* xi, 101, the shade of Patroclus departs with what Shakspeare [*Hamlet*, I, 1] calls a "squeak and gibber." An un-expected illustration of these arts may be met with in Captain Lyons's *Private Journal*, p. 858, where he de-scribes the feats of the Esquimaux ventriloquist Too-lemak אֱמְגְלוֹלִיק. Compare the curious account of a modern necromancy left us by Benvenuto Cellini; both of these are narrated in Sir D. Brewster's *Letters on Natural Magic*, p. 69-75, and 176-178.) The Sept. version, much more inexact than the English, renders יִדְעוֹנִי of Deut. xviii, 11 by *ῥεπαρσκότρος*, or *ob-server of omens*; what the *prodigies* were, which, ac-cording to the extravagant belief of the Rabbinical writers, were used by these diviners, may be seen in Carpov, *Apparatus*, p. 545, 546, where, among others, are adduced the bird *Jiddoa* and the monster *Jaddua*, to account for the origin of our term. This last was, according to the Rabbis, a certain beast in shape like a man (*καταβλεπάδα*), the bones of which the diviner held in his teeth (Maimon. *De Idol.* vi, 8; Bulenger, *De Div.* iii, 88; Delrio, *Disquis. Mag.* iv, 2; Godwyn's *Mos. and Aar.* iv, 10). The Greek diviner ate certain efficacious parts of animals (Porphyr. *De Abstem.* ii). For other bone divinations, see Rubruquis's *China*, p. 65, and Pennant's *Scotland*, p. 88 (in Pinkerton). See WIZARD.

8. The last designation used by Moses in the great passage before us (Deut. xviii, 10, 11) is אֱלֵי הַמֵּתִים, *doresh' el ham-methim* (one seeking unto the dead; Sept. *ἐπερωτῶν τοὺς νεκρούς*; Vulg. *qui quarit a mortuis veritatem*). This points to the famous art of necromancy, the *νεκρομαντεία*, or (as they preferred to write it) *νεκρομαντεία* of the Greeks. This was a divination in which answers were given by the dead. It was sometimes performed by the magical use of a bone or vein of a dead body, or by pouring warm blood into a corpse, as if to renew life in it (Lucan, *Phar.* vi, 750). Sometimes they used to raise the ghosts of deceased persons by various ceremonies and invoc-ations. Ulysses, in *Odyssey*, book ix, having sacrificed black sheep in a ditch, and poured forth libations, in-vites the ghosts, especially that of Tiresias, to drink of the blood, after which they become willing to an-swer his questions. (Compare the evocation of the shade of Darius, for counsel, after the defeat at Sala-mis, in the *Persæ* of Æschylus, 680-684.) This evo-cation of spirits was called *ψυχαγωγία*; the offerings of the dead on this occasion were mild and unbloody; but Gregory Nazianzen (in *Orat. II, contra Julianum*.) speaks also of "virgins and boys slaughtered at the evocation of ghosts." From Isa. lxxv, 4, it would ap-pear that the ancient Jews increased the sin of their superstition by using *unclean* offerings on such occa-sions: "They remain among the graves, and lodge in the monuments" (קִרְיֵי, *will spend the night in these adyta*); such were the favorite haunts of the necro-mancers: "they eat swine's flesh"—an idolatrous prac-tice (comp. Ovid, *Fasti*, i, 849; Horace, *Sat.* ii, 3, 164; Varro, *De Re Rust.* ii, 4); "and broth of abominable things is in their vessels." (We are reminded of the celebrated witch scenes in Shakspeare, *Macbeth*, I, 8; III, 5; and especially IV, 1.) Rosenmüller, in loc., refers, for a like incantation, to Marco Polo, *Travels in the East*, iii, 24; and Sir J. F. Davis, in his *China* (last ed.), ii, 73, mentions certain magic spells practised by the Taou sect, "with the blood of swine, sheep, dogs, and other impure things." A curious case of necro-mancy also occurs in the story of the philosopher

Chuàng-tsze and his wife, in the same vol. p. 87, 88. In the 15th chap. of *Sketches of Imposture, etc.* (in the *Family Library*), "on Sepulchral and perpetual lamps," may be found an interesting account of the reasons which induced the Egyptians to bestow so great attention on their dead; one of them, quoted from Kircher's *History of Egyptian Antiq.*, rests on the opinion "that the souls of the deceased tarry with their bodies in the grave." This, added to the conception of the more enlarged knowledge of the dead, lay at the foundation of *necromancy*. The earliest historical tale of this sort of divination which we recollect is related by Herodotus concerning Periander of Corinth and his wife Melissa, whose spirit he consulted for information about a hidden treasure (v. 92). In one of the most interesting dialogues of Lucian, the "*Menippus*," or "*Necyomantheia*," a very good description is given of various necromantic ceremonies. (For an abstract, see *Occult Sciences*, by Smedley, etc. p. 183, 185.) In Tertullian's treatise, *De Anima*, occurs a remarkable passage on necromancy, at the conclusion of which he says, "If certain souls have been recalled into their bodies by the power of God as manifest proofs of his prerogative, that is no argument that a similar power should be conferred on audacious magicians, fallacious dreamers, and licentious poets" (c. 56, 57). We may observe, in concluding this subject, that in confining (with Böttcher) *necromancy proper* to the last phrase on Moses's list, אֱלֹהֵי הַמִּצְרַיִם, we have the authority of the A. V., which limits the word *necromancer* (αἰετα λέγόμενον in our Bible) to this phrase. See **NECROMANCER**.

III. Forms of divination merely referred to in the Bible, without special sanction or reprobation. We here find the same general phrase as in the foregoing passage of Deut. introductory to another but much shorter catalogue; for in the remarkable passage of Ezek. xxi, 21 [or 26 in the Hebrew], we have the three famous divinations of the king of Babylon. The prophet represents the monarch as standing "at the parting of the way, at the head of the two ways, to use *divination*" (קָסַם וְקָסַם בְּלָק).

1. He "made the arrows bright" (rather, *he shook them together*, *Virg. commiscens sagittas*, קָלְקַל בְּיָדָיו אֶת הַקְּסָוִים, Sept. ἀγαθρίσσαι βαβίδια), "each arrow having inscribed on it the name of some town to be assaulted. From the quiver the arrows were drawn one by one, and the city which was written on the first arrow drawn out was the first to be beleaguered" (Jerome, in loc.). In this instance Jerusalem was the ill-fated object of this divination, as we learn from the next verse, where the *divination for Jerus.* (קָסַם יְרוּשָׁלַיִם) signifies the arrow bearing the inscription of the doomed capital, as it first emerged from the divining-quiver (Prideaux, *Connect.* i, 85). Etnius says "he threw up a bundle of arrows to see which way they would light, and, falling on the right hand, he marched towards Jerusalem." We have here a case of *belomancy* (βελομαντεία). This superstition, which is prohibited in the Koran (chap. iii, 89; v, 4), was much practised by the idolatrous Arabs (D'Herbelot, *Bibl. Or.* s. v. Acdah). Their arrows, which were consulted before any thing of moment was undertaken, as when a man was about to marry, or undertake a journey, or the like, used to be without heads or feathers, and were kept in the temple of some idol. Seven such arrows were kept at the temple of Mecca, but in divination they generally used but three. On one of these was written, *my Lord hath bidden me*; on the second was inscribed, *my Lord hath forbidden me*; while the third was blank. If the first was drawn, it gave the god's sanction to the enterprise; the second prohibited it; but the third being drawn required that the arrows should again be mixed and again drawn until a decisive answer was obtained (Pococke's *Spec. Arab.* p. 324,

etc.; Gesenius, *Thes.* p. 1224; Sale's *Koran*, *Præf. disert.* p. 90; Clodius, *Dis. de Mag. Sagitt.* iii, 7). Vallæ, however, says (p. 276), "I saw at Aleppo a Mahomedan who caused two persons to sit on the ground opposite each other, and gave them *four arrows* in their hands, which both of them held with their pines downward," etc. The *two arrows* in the right hand the Assyrian king (sculptured on one of the large slabs brought from Nimroud) are conjectured to be paid that *divination by arrows* was practised in ancient times. The king is represented as attended by two attendants with fir-cone and basket, and therefore is a religious and not a martial occupation (Bononi, *Arab. et its Palaces*, 3d ed. p. 306). Three times an Eastern princess decided their claims by shooting each an arrow inscribed with his own name. The most distant arrow indicated the name of the successful competitor (Roberts's *Orient. Illustr.* p. 49). We read of a somewhat similar custom in use among the ancient Teutons (Tacitus, *German.* x), and among the Alani (Am. Marcell. xxxii); also among the modern Egyptians (Lane, ii, 111). This sort of divination of the king of Babylon must not be confounded with the arrow shot (βέλοβόλια) of Jonathan, the affecting expedient of his secret warning to David, 1 Sam. ix, 20, etc., in which, though there were three arrows, there was no uncertain divination, but an understood sign (Browne, *Vulg. Errors*, v, 28, 27). Again, in the shooting of arrows by Josiah, king of Israel, at the command of the dying prophet (2 Kings xiii, 17, 18), there is the three arrows only an accidental, not a real resemblance; moreover, we have in this action not an authorized superstition, but a symbolical prophecy (comp. the symbol with Virgil, *Æn.* ix, 52). See **ARROW**.

2. "He consulted with the images," (קָסַם בְּפִסְפֻסָּי) (Sept. ἐπερωτῆσαι ἐν τοῖς γλυπτοῖς; *Virg. nuncupat idola*), literally *teraphim*. These household gods of the Shemitic nations are often mentioned in the Old Testament from the time of the Syrian king (Gen. xxxi, 19) to this of the Chaldee Nebuchadnezzar (see Aug. Pfeiffer, *De Teraphim*, in *Ugolini's Jew.* xxiii, 666, who, unnecessarily indeed, suggests, on grammatical grounds, that the king of Babylon may have used these three divinations *prope sua domum*). Dr. Fairbairn (on Ezek. xxi, 21) says, "This is the only passage where the use of teraphim is expressly ascribed to a heathen." The form of *idolomancy* (εἰδωλομαντεία) is, however, also where named (Zech. x, 2; 1 Sam. xv, 23, &c., inquirer). These were wooden images (1 Sam. xv, 18) consulted as "idols," from which the exorcists or shippers fancied that they received oracular responses. The notion that they were the embalmed heads of infants on a gold plate inscribed with the name of an unclean spirit is Rabbi Eliezer's invention. (The Rabbis think that they mean "astrolabes, etc.") See **TERAPHIM**.

3. "He looked in the liver," (קָסַם בְּכִבְדֵי) (Sept. κατασκοπήσασθαι v. r. ἡπαροσκοπήσασθαι; *Virg. exza consuluit*). Here we have a case of a well-known branch of *splanchnomancy* (σπλαγγνομαντεία), or *divination by the inspection of entrails*, which was called *extispicium* (or art of the haruspices), practised in Rome by the Etrurian soothsayers, and much referred to in both Greek and Latin authors. Cicero (*De Divin.* i, 15) mentions the importance of the *liver* in divination of this kind; hence this branch was called *hepatomancy* (ἡπαροσκοπία, Herodian. viii, 8, 17; see also *Plut.* xi, 87; Ovid, *Metamorph.* xv, 136). Arrian (*Alc.* vi, 18) mentions an evil prognostication in reference to the deaths of Alexander and Hephaestion; and Strabo (*Aug.* xcv, 2) a happy one. Strabo also (*Alc.* vi, 18 ed. Casaub.) mentions this divination as practised by the Lusitani; not only animals offered in sacrifice to captives in war furnished these barbarians with their

his bloody divination. A still more hideous mode of divination is mentioned of the ancient Britons, who cut down at a blow of the sword one of their sacrifices, in order to observe the posture of all, his convulsions, flow of the blood, etc., and so their predictions according to the rule of their stars. This is the only instance mentioned in Scripture of this superstition. The liver was the most important part of the sacrifice for divining purposes (Enchiridion, ii, 74; Cicero, De Div. ii, 18). See ENCHIRIDION.

One of the remaining isolated terms of divination in the Scriptures is חַרְטוּמִּים, *har-tumim*, "the charmers," which occurs in Isa. xix, 3, in a passage descriptive of the idolatry and superstition of Egypt. It is derived by Gesenius and Meier from a root חַרְטוּ, *atav*, to Arab. *atta*, which signifies to utter a dull mewing sound. Meier defines the noun in question by *murmers or tippers*. If so, we have here a class of ventriloquists already described. But the Septuagint is another turn to the word, rendering by ἀγάμασας if, coming after אֱלֹהֵי לַיְלָה, *gods*, it meant their *ves*. Herodotus (ii, 88) tells us the Egyptians possessed many oracles besides that of Latona at Buto, which was most esteemed of all. He adds that "the mode of delivering the oracles (*ai mantrijai*) varied at different shrines." See above.

In Dan. ii, 2, four classes of diviners are mentioned, two of these are described above; of the others, אֲשֶׁפְּחִים, *ashshaphim* (Chald. אֲשֶׁפְּחִים, in Dan. ii, 27), probably allied by derivation with the word אֲשֶׁפְּחִי, *ashshaphi*, which we have already described (Meier's "אֲשֶׁפְּחִי = אֲשֶׁפְּחִי"). The noun אֲשֶׁפְּחִים, *ashshaphim* (a verb), from the same root, suggests the notion of *vealmnt and covering*. This, the probable meaning of our term, suits very well with the idea of divination, though it ill accords with the A. V., which, in all eight passages in Daniel where it is found, renders *astrologers*. Divination by the stars is not implied to be original. The Sept. in every place except one that is doubtful, see Trommley *Concord*, ii, 1) translates אֲשֶׁפְּחִים by μάγος, and the Vulg. generally by *magus*. This suggests the association of the אֲשֶׁפְּחִים with

magians of Matt. ii, 1 (Dutripion, *Concord. Biblic.* tr. p. 824). This, added to the fact that אֲשֶׁפְּחִים is generally coupled with the *chartumim* and the *Chaldeans*, probably influenced our translators in their use of the English word. The original, however, much less specific. Some philologists have imagined the word σόφος is no other than אֲשֶׁפְּחִים with the *t* letter dropped, and have also connected it with Persian *sophi*. Such a derivation would rather not to occult arts and cabalistic divination. See TROLOGER.

3. The expression used by Daniel in i, 20—חַרְטוּמִּים וְאֲשֶׁפְּחִים, *har-chartumimim ha-ashshaphim*, "the magicians (and) the astrologers"—is an *asyndeton*, for in several places prove the second to be a different class from the first (see above). The close conjunction of אֲשֶׁפְּחִים with the *chartumimim* indicates their participation of the qualities of the latter, the *ισογομαρτεῖς*, or sacred scribes of both Egypt and Babylon, or whom Daniel was appointed *rab* or master. In a learned *Dissertatio* D. Millii de *Chartumimim aliiue ventium magis* (Ugolini *Theos.* xxiii, 529, 538) nearly all the accomplishments of the divining art are attributed to this influential caste, beginning with the *nethiac* mysteries. The horoscope, which was much used by these γυνεθλακοί, brings us back to *astrology*, which (though not implied in the designation אֲשֶׁפְּחִים) was no doubt a part of their wisdom. Gesenius, in *Theos.* and *Lex.*, derives the word *chartumimim*

from חַרְטוּ, *che'ret*, "a graving tool," and (on the authority of Creuzer, *Symbolik u. Mythologie*, i, 245; and Jablonski, *Proleg. in Panth. Egypt.* p. 91, etc.) connects the arts of the *chartumimim* with the sacred *hieroglyphical* writings. Not less probably, from such a derivation, these diviners might be connected with the system of *talismans*, so rife in the East, and in Egypt in ancient times. See AMULET. The talisman (Arabic *talsam*, Greek *τάλασμα*) is defined (in Freytag, *Lex. Arab.* s. v. iii, 64) to be "a magical image upon which, under a certain horoscope, are engraved mystic characters, as charms against enchantment or fascination." Talismans, among other uses, are buried with treasures to prevent them from being discovered. Thus this divination appears as a counterpart against another species (in rhabdomancy) which was used for the discovery of treasure. Equally varied are the gifts ascribed to the *chartumimim* in the translations of the Sept. and Vulg. In eleven of the fifteen occurrences of the word (all descriptive of the magicians of Egypt and Babylon), *επισωδός* and *incantator* are used in these versions; *φαρμακός* and *veneficus* in two; and in the remaining two *ἐξηγητής* and *interpreter*. According to Jablonski, the name is derived from an Egyptian word *Chertom* = *thamaturgus*, wonder-worker. (For other conjectures, see Kalisch, *Gen.* p. 647; Heidegger, *Hist. Patr.* xx, 28.) Of course it must have the same derivation in Dan. i, 20, and therefore cannot be from the Chaldee *Dhardamand* = skilled in science (Jahn, *Bibl. Arch.* § 402). If their divination was connected with drawn figures, it is paralleled by the Persian *Rummal* (Calmet); the modern Egyptian *Zairgeh*, a table of letters ascribed to Idris or Enoch (Lane, i, 354), the renowned Chinese *y-King*, lines discovered by Fouhi on the back of a tortoise, which explain everything, and on which 1450 learned commentaries have been written (Huc's *China*, i, 128 sq.); and the *Jamassu*, or marks on paper, of Japan (Kempfer's *Hist.* ch. xv). See MAGICIAN.

7. אֲשֶׁפְּחִים, *Kardim* (Sept. Χαλδαῖοι; Vulg. *Chaldei*). Here, says Cicero (*De Div.* i, 1), we have a class "so named, not from their art, but from their nation." But only a section of the nation, the learned caste: "the dominant race," says Ernest Rénan, "who gave their name, though only a minority, as the Turks elsewhere, to the mass of the population, which differed from them in descent" (*Histoire des langues Sémitiques*, p. 67, 68). They are mentioned by Herodotus (i, 181) as a *sacerdotal* caste. Cicero, *l. c.*, notices their devotion to astrology, and "their working out a science by which could be predicted what was to happen to each individual, and to what fate he was born." Diodorus Siculus, after Ctesias, assigns the same office at Babylon to the Chaldeans as the priests bore in Egypt (*Hist.* ii, 29). Juvenal (*Sat.* vi, 552) and Horace (*Carm.* i, xi) refer to the Chaldean divination. The prophet Isaiah (xlvii, 12, 13) mentions several details of it in terms which we have already described. How the same appellation, אֲשֶׁפְּחִים, came to designate both the *military* and the *learned* classes of Babylon (comp. 2 Kings xxiv, 5, 10, etc., with Dan. ii, 2), and how conflicting are the views of the modern learned as to the origin of the Chaldeans, see Rénan, *l. c.*, and Sir H. Rawlinson, in note of Rawlinson's *Herod.* i, 319. See also CHALDEAN.

8. One name more (occurring in Dan. ii, 27; iv, 4; and v, 7, 11) remains to be noticed descriptive of the *savans* of Babylon—אֲשֶׁפְּחִים, *gazerim* (Sept. Γαζαρῖοι; Vulg. *aruspices*; A. V. "soothsayers"). Gesenius and Rosenmüller agree in deriving this word from גָּזַר, *gazar*, to divide, cut up, etc.; but they differ in the application of the idea, the former making it mean the heavens divided into astrological sections (of which he gives a diagram in his *Comm. zu Jes.* iii, 555); the latter (*Schol. in Daniel*, ll. cc.) supposing it to refer to the

division and inspection of the entrails of victims by *aruspices*: both these kinds of divination have been described above. Others refer to Josephus (*War*, vi, 5, 8) for astronomical portents such as the *gazerin* would interpret (see also St. August. *De Doctr. Christ.* ii, 82, etc.). Jerome, in his *Commentary* in loc., defends his own version, *aruspices*, by the authority of Symmachus. The Sept. and Theodotion translate the word Γαζαρρηνοὺς as if it were a proper noun, like מְשִׁיבֵי רֵיחַ, Chaldeans. See SOOTHSAYER.

9. In Hosea iv, 12, we read, "My people ask counsel at their stocks (or wood, מַצְעוֹ יִשְׂרָאֵל); and their staff declareth unto them" (יְהִי לָהֶם יִצְחָקוֹ). Those who hold that two separate prognostications are here referred to, generally make the former a consultation of wooden idols, or *teraphim*, which has already been treated (see Rosenmüller and Pococke, in loc.). Jeremiah reproaches the Jews for "saying to a stock (צֶדֶק), My Father" (ii, 27); and Habakkuk, "Woe unto him that saith to the wood (צֶדֶק), Awake" (ii, 19). But Pococke (on Hosea iv, 12) gives reasons for supposing that only one sort of superstition is meant in this verse, namely, *rhabdomancy* (ραβδομαντρία), divination by staves or rods. Many kinds of this are on record. Maimonides (*Precept. neg.* 81) mentions the practice of "taking a staff and striking the ground with it, and making horrid noises, while the diviners would stand in a reverie, intently looking on the ground, till they became like men struck with epileptic fits; when reduced to this frenzy they would utter their prophecy." The learned Rabbi says he saw such a case himself in Barbary. Chaikuni (quoted by Drusius on Deut. xviii, 10) adduces another method by which "the diviner measures his staff with his finger or his hand: one time he says *I will go*; another time, *I will not go*; then, if it happens at the end of the staff to be *I will not go*, he goes not." Rabbi Moses Mikkotzi (in Pococke, l. c.) mentions a divination by a piece of stick, peeled on one side, which, thrown afar out of the hand, decided a doubt, according as the peeled or unpeeled side fell uppermost. Tacitus (*Germ.* x) describes a similar prognostication among the Germans. Theophylact, after Cyril, on this passage of Hosea, mentions the use of two rods, set upright, with enchantments and muttering of verses. "The rods," says he, "falling through the influence of demons, suggested answers to inquirers, according as they fell to the right or to the left, forward or backward." Staves were sometimes carried about as the shrines of deities, says Festus. Tibullus (*I. Eleg.* xi, 15) refers to these modern deities. In allusion to the same superstition, Clement of Alexandria (*Strom.* i, 151) mentions certain tubes as the shrines of deities (comp. Euseb. *Prep. Evang.* i, 9). Another explanation is that the positive or negative answer to the required question was decided by the equal or unequal number of spans in the staff (Godwyn, l. c.). Parallels are found among the Scythians (Herod. iv, 67, and Schol. Nicandri, Σκυθία μυρικήν μαντεύονταί ἔϋλα), Persians (Strabo, xv, p. 847), Assyrians (Athen. *Deipn.* xii, 7), Chinese (Stavorinus's *Java*; Pinkerton, xi, 182), and New Zealanders (called *Niu*, Taylor's *New Zealand*, p. 91). These kinds of divination are expressly forbidden in the Koran, and are called *al Meisar* (ch. v, Sale's *Prelim. Dissert.* p. 89). Herodotus (vii, 11) describes the Alani women as gathering and searching anxiously for very smooth and straight wands to be used in this superstitious manner. Sir J. Chardin says it is common in India for diviners to accompany conquerors, to point out where treasures may be found; and he adduces a case at Surat: when Siragi went thither, he made his soothsayers use divining rods, struck on the ground, or on walls, etc. Harmer (ii, 282) supposes a reference to such a practice may be implied in Isa. xlv, 8 (see St. Chrysostom, *Opera* [ed. Bened.], xi, 518,

824). Sir J. F. Davis (*China*, ii, 101) mentions a ruse "mode of divination by certain pieces of wood, shape the longitudinal sections of a stick of wood. These are thrown by pairs, and, as they tan, judgment is formed of a future event by consulting the interpretation afforded by a Sibylline volume lying up in the nearest temple." Captain Burton, in *Eastern Africa*, mentions some not dissimilar pieces of divination; nor are these "fooleries of fidd," as he calls them, unknown among ourselves. Even miners in the south-west of England walk with a *dowsing stick* in hand over suspected spots; and we find this divining rod is in their view an infallible sign of *lode*. Similar superstitions have lately been practised in this country in searching for petroleum. E. Salchlin has written a treatise on this curious ruse, *Idolomania et Rhabdomantia anti-christiana, seu disertatio historico-theologia ad Hos. iv, 12* (Berol. 1774). A good deal of information may be obtained in Jean Lydii *Synag. Sacr. de re Mithiari*, c. 3 (Ugolin. *Ann.* xxvii, 142-146), and in Delrio, *Disquis. Magic. Etr.* c. 2, quest. 8, sect. 1, sub fin.; sect. 3, sub init. See STOCK; STAFF. Compare *Mercersbury Bazaar*, Jan. 1861. On the general subject, see Andr. Kirking (Roterd. 1651), i, 1244 sq. On the arts of divination practised by the ancient Greeks and Romans, see Smith's *Dict. of Class. Antig.* s. v. Divination.—See s. v.; Smith, s. v. See SOCCERY.

Divine, (1) of or belonging to God; (2) supernatural man; (3) a minister or theologian, as one who explains the things of God.

Divine Right, (1) in politics, the claim of sovereigns to unlimited obedience, on the ground that the sovereign power is derived directly from God. In ecclesiastical polity, the divine right (*jure divino*) has been claimed for certain forms of Church government and for certain classes of persons as administrators of it; e. g. bishops in the Roman Church long claimed divine right to exercise authority in their dioceses, while the Pope claims that their right is not directly divine, but mediately through him. This controversy has never been authoritatively settled. It was largely discussed in the Council of Trent (q. v.). (2) In the Protestant churches generally, the claim of divine right on the part of the clergy to govern is generally abandoned, and where it is held the right is maintained as a *mediate* one, derived through the Scriptures as far as they give principles and laws for Church government. See ECCLESIASTICAL POLITY.

Divinity, a term sometimes used to designate the science of theology. See THEOLOGY.

DIVINITY OF CHRIST. See CHRISTOLOGY; INCARNATION; TRINITY.

Divisions, CHURCH. See SCHISM.

Division, the rendering of the following words: 1. מַחְלוֹת, *chulukak'*, 2 Chron. xxxv, 5, or מַחְלוֹת מַחְלוֹת, *machalo' keth*, Josh. xi, 28; xii, 7; xviii, 10; 1 Chron. xxiv, 1; xxvi, 1, 12, 19; Neh. xi, 86; a regular distribution (e. g. the sacerdotal "courses" or sections). 2. פְּלִיגָה, *peluggak'*, 2 Chron. xxxv, 5, or Chald. פְּלִיגָה, *pelugga'*, Ezra vi, 18, a partition (likewise applied to the priestly ranks), but פְּלִיגָה, *pelaggak'*, Judg. v, 16, *streamlets* ("rivers," Job xx, 17). 3. פְּלִיגָה, *plidh'*, a distinction, Exod. viii, 23 (elsewhere "rebellion"). 4. διαμερισμός, *diemismos*, Luke xii, 21; ἁρσασία, *variance*, Rom. xvi, 17; 1 Cor. iii, 3; Gal. 20; σχίσμα, a split, John vii, 43; ix, 16; x, 19 ("schism," Matt. ix, 16; Mark ii, 21).

DIVISIONS IN THE CHURCH AT CORINTH (σχιζμα, 1 Cor. i, 10; xi, 18, *schisma*, as rendered 1 Cor. ii, 25), i. e. parties or factions leading to altercation (as "contention" 1 Cor. i, 11). The existence in some of the early churches of a strong tendency towards the ingrafting of Judaism upon Christianity is a fact well

to every reader of the N. T.; and though the Church at Corinth was founded by Paul and afterwards instructed by Apollos, yet it is extremely probable, as in the churches of Galatia, so in those of Corinth, this tendency may have been strongly manifested and that a party may have arisen in the Church which opposed to the liberal and spiritual system of Paul, and more inclined to one which aimed at fettering Christianity with the restrictions and outwardness of the Mosaic dispensation. The leaders of this party probably came with letters of commendation (2 Cor. i, 1) to the Corinthian Church, and it is possible they may have had these from Peter; but that party itself received any countenance from that apostle cannot for a moment be supposed. Rather we believe that they took the name of "the apostles of the circumcision" as the designation of their party for the sake of gaining greater authority to their system; at any rate, they seem to have used Peter's wedged place among the apostles to the disparagement of Paul, and hence his retort (2 Cor. xi, 5), the vehement opposition of this party to Paul, and the pointed attack upon his claims to the apostolic authority would naturally lead those who had been Paul's disciples, and who probably formed the major part of the Church, to rally round his pretensions, and the maintenance of a pure and spiritual Christianity which he taught. Closely allied with this party, and in some respects only a subdivision of it, was that of Apollos, a distinguished teacher was not only the friend of Paul, but had followed Paul's teaching at Corinth, a congenial spirit and to a harmonious result (1 Cor. iii, 5, etc.). Between the party, therefore, assuming his name, and that ranking itself under the name of the apostles, there could be no substantial ground of difference. Perhaps, as Apollos had the advantage of Paul in some respects, especially in facility of public speaking (Acts xviii, 24; comp. 2 Cor. i, 1), the sole ground on which his party may have preferred him was the higher gratification he afforded by addresses to their educated taste than was derived from the simple statements of the apostle concerning "Christ and him crucified." Thus far all, however, almost purely conjectural, is easy and probable in relation to the fourth party—that which "I am of Christ"—it has been found extremely difficult to determine by what peculiar sentiments they distinguished themselves. (See the *Stud. u. Krit.* 1865, i.) The simplest hypothesis is that of Augustine ("alii volebant edificari super Petrum, sed super petram edificavit") *Ego autem sum Christi*," *De verb. Dom.* c. 13), whom Eichhorn (*Einsleit.* iii, 107), Schott *ye in N. T.* p. 238), Pott (*N. T. Koppian.* vol. v, p. 25), Bleek (*Einsl.* p. 397), and others follow, but this party was composed of the better sort in the Church, who stood neutral, and, declining to follow any mere human leader, declared themselves to belong to Christ, the common Lord and the Leader of the Church. This opinion is chiefly based on 1 Cor. iii, 22, 23, and it is supposed the four parties are alluded to, but that of Christ alone commended. But this seemed and improbable interpretation of that passage: the words *ἡμεῖς δὲ Χριστοῦ*, "and ye are Christ's," much more naturally understood as applying to the Corinthians, than as describing only a part of the Church. This opinion, moreover, hardly tallies with the usage of the apostle concerning the Christ-party, 1 Cor. i, 12, and 2 Cor. x, 7, where he evidently speaks of them in terms of censure, and as guilty of being Christ. Another hypothesis is that suggested by Storr (*Notitia Historice epistol. ad Cor. interpret. servientes*, in his *Opusc. Acad.* ii, 242), and which is well followed, among others, by Hug (*Introd.* p. Fosdick's trans.), Bertholdt (*Einsleit.* p. 3820), and also (*Pauli ad Cor. Epistolae Græcæ. etc. Proleg.* p. 17), that the Christ-party was one which, professing to follow James and the other brethren of the Lord

as its heads, claimed to itself, in consequence of this relationship, the title *οἱ τοῦ Χριστοῦ*, those of Christ, by way of eminence. To this it has been objected that, had the party in question designed, by the name they assumed, to express the relationship of their leader to Jesus Christ, they would have employed the words *οἱ τοῦ Κυρίου*, those of the Lord, not *οἱ τοῦ Χριστοῦ*, the former being more correctly descriptive of a personal, and the latter of an official, relationship. Besides, as Olshausen remarks, "the party of James could not be precisely distinguished from that of Peter; both must have been composed of strenuous Jew-Christians. In fine, there is a total absence of all positive grounds for this hypothesis. . . . The mere naming of 'the brethren of the Lord' in 1 Cor. ix, 5, and of James in 1 Cor. xv, 7, can prove nothing, as this is not in connection with any strictures on the Christ-party, or indeed on any party, but entirely incidental; and the expression *γινώσκουσιν Χριστὸν κατὰ σάρκα*, 'know Christ after the flesh' (2 Cor. v, 16), refers to something quite different from the family-relationships of the Saviour: it is designed to contrast the purely human aspect of his existence with his eternal heavenly essence" (*Biblische Comment.* III, i, 457; comp. Billoth, *Commentary on the Corinthians*, i, 11). In an able treatise which appeared in the Tübingen *Zeitschrift für Theologie* for 1831 (part iv, p. 61), Baur has suggested that, properly speaking, there were only two parties in the Corinthian Church—the Pauline and the Petrine; and that, as that of Apollos was a subdivision of the former, that of Christ was a subdivision of the latter. This subdivision, he supposes, arose from the opposition offered by the Petrine party to Paul, which led some of them to call in question the right of the latter to the apostleship, and to claim for themselves, as followers of Peter, a closer spiritual relationship to the Saviour, the honor of being the alone genuine and apostolically-designated disciples of Christ. This opinion is followed by Billoth, and has much in its favor; but the remark of Neander, that "according to it the Christ-party would be discriminated from the Petrine only in name, which is not in keeping with the relation of this party-appellation to the preceding party-names," has considerable weight as an objection to it. Neander himself, followed by Olshausen, supposes that the Christ-party was composed of persons "who repudiated the authority of all these teachers, and, independently of the apostles, sought to construct for themselves a pure Christianity, out of which probably they cast everything that too strongly opposed their philosophical ideas as a mere foreign addition. From the opposition of Hellenism and Judaism, and from the Helleno-philosophical tendency at Corinth, such a party might easily have arisen. . . . To such the apostles would seem to have mixed too much that was Jewish with their system, and not to have presented the doctrines of Christ sufficiently pure. To Christ alone, therefore, would they professedly appeal, and out of the materials furnished them by tradition, they sought, by means of their philosophic criticism, to extract what should be the pure doctrine of Christ" (*Apostol. Zeitalt.* p. 206; i, 273 of Eng. tr.). The reasoning of the apostle in the 1st, 2d, 12th, 13th, 14th, and 15th chapters of the 1st Epistle seems clearly to indicate that some such notions as these had crept into the Church at Corinth; and, upon the whole, this hypothesis of Neander commends itself to our minds as the one which is best maintained and most probable. At the same time, we have serious doubts of the soundness of the assumption on which all these hypotheses proceed, viz. that there really were in the Corinthian Church sects or parties specifically distinguished from each other by peculiarities of doctrinal sentiments. That erroneous doctrines were entertained by individuals in the Church, and that a schismatical spirit pervaded it, cannot be questioned; but that these two stood formally connected with each other may fairly admit of

doubt. Schisms often arise in churches from causes which have little or nothing to do with diversities of doctrinal sentiment among the members; and that such were the schisms which disturbed the Church at Corinth appears to us probable, from the circumstance that the existence of these is condemned by the apostle, without reference to any doctrinal errors out of which they might arise, while, on the other hand, the doctrinal errors condemned by him are denounced without reference to their having led to party strifes.—Kitto, s. v. For further information, besides that contained in the writings of Neander, Davidson (*Introd. to N. T.* ii, 222 sq.), Conybeare and Howson, and others, the student may be referred to the special treatises of Schenkel, *De Eccl. Cor.* (Basel, 1838), Kniewel, *Eccl. Cor. Disquisitiones* (Gedan. 1841), Becker, *Partheiungen in die Gemeinde s. Kor.* (Altona, 1841), Rübiger, *Ent. Unterrsch.* (Bresl. 1847); Hilgenfeld, in *Zeitschr. für wiss. Theol.* 1866, p. 241 sq.; Beysslag, in the *Theol. Stud. u. Krit.* 1865, p. 217 sq.; but he cannot be too emphatically warned against that tendency to construct a definite history out of the fewest possible facts, that marks most of these discussions.—Smith, s. v. SEE CORINTHIANS (EPISTLES TO THE).

DIVISION OF THE EARTH. That all mankind were originally of one family—spoke but one language, that, in consequence of their being united in a design which accorded not with the views of Providence, the Almighty confounded their speech, and introduced among them a variety of tongues, which produced a general dispersion, are facts declared by the sacred writers. In Acts xvii, 26, we are told, "God made of one blood all nations of men, for to dwell on all the face of the earth; and hath determined the times before appointed, and the bounds of their habitation." In Gen. x, 25, it is said, in the days of Peleg the earth was divided. The idea was, that each nation received its allotted portion of territory from God. The same view is probably taken in Deut. xxxii, 8, 9:

When the Most High assigned an inheritance to nations—
When He divided the sons of Adam;
He fixed the bounds of peoples,
According to the number of the sons of Israel.
For the portion of Jehovah is his people—
Jacob the lot (cord) of his inheritance.

The object of the sacred historian, in the tenth chapter of Genesis, is to furnish a brief, but authentic record of the origin of the principal nations of the earth. In the form of a genealogical table, or roll, of the descendants of Noah, it contains a view of the pedigree of nations in the then known world. As such, it is a record of inestimable value, being the most ancient ethnographic document which we possess. It does not, indeed, afford to us, at this late period of the world, that degree of definite information which it doubtless conveyed in the time of Moses. A proper name is apt to assume a new form every time it is translated into a different language, and often in the same dialect at different periods. It is not, therefore, to be wondered at that many nations and peoples should have lost the names by which they were originally called, or that these names should have become so altered by time, or so distorted in being transferred into other tongues, as to make it difficult to trace their relation to those here given. But, notwithstanding the uncertainty arising from this source, far more successful results have attended the researches of learned men in this department than could have been anticipated, so that nearly all the leading nations of ancient and modern times can be distinctly traced up to their patriarchal progenitors, recited in the present catalogue. Indeed, the subject of this chapter has been so nearly exhausted by the labors of Bochart, Le Clerc, Wells, Michaelis, Sir William Jones, Hales, Faber, Rosenmüller, and others, that little is left for future gleaners, until a more minute acquaintance shall be formed with the Asiatic regions by some one who shall be master of the

various dialects spoken from the Indus to the Nile, and from the Arabic Gulf to the Caspian Sea. In considering this record, it is important to remark, 1. That the names of *individuals* are for the most part those of the nations descended from them, just as Julius of Israel, though names of single persons, are also names of whole nations. This is evident, not only from the fact that many of them are in the plural number, and those ending in *im*, but also from the terminations of many of them, especially those ending in *im*, being descriptive of *tribes*, and not of individuals. 2. Although this chapter is placed before the eleventh, in the order of time it properly belongs after it: it is the confusion of tongues at Babel, which was the principal occasion of the dispersion of mankind, and of course have preceded that dispersion. This is rendered evident from the expression, "after their tongues," implying a diversity of languages, which we know did not exist prior to the confusion of tongues mentioned in the eleventh chapter. But such transpositions are common with the sacred writers. 3. Speaking in general terms, it may be said that the three sons of Noah—Shem, Ham, and Japheth—are exhibited in the genealogical chart as the representatives of the three grand divisions of the earth, Asia, Africa, and Europe, although not precisely according to the boundaries of modern times. The descendants of Japheth peopled Europe and the north-west of Asia; those of Ham the southern quarter of the globe, particularly Africa; and the Shemites, the countries of Central Asia, particularly those around the Euphrates. In accordance with this, a tradition has long and extensively prevailed throughout the East, particularly amongst the Arabs and Persians, that Noah divided the earth among his three sons. But as this tradition rests upon no express authority of Scripture, the presumption is that it arose from some confused recollection or interpretation of Noah's prophecy mentioned in Gen. ix, 25-27. "It has often been asserted," says Hengstenberg, "that the genealogical table in Gen. x cannot be from Moses, since so extended a knowledge of nations lies far beyond the geographical horizon of the Mosaic age. This hypothesis must now be considered as exploded. The new discoveries and investigations in Egypt have shown that they maintained even from the most ancient times a vigorous commerce with other nations, and sometimes with very distant nations. But it is merely in general do the investigations in Egyptian antiquities favor the belief that Moses was the author of the account in this tenth chapter of Genesis. The Egyptian monuments, those especially which represent the conquests of the ancient Pharaohs over foreign nations, not a few names have been found which correspond with those contained in the chapter before us. It must be allowed that far more still could be effected if our knowledge of hieroglyphics were not so very imperfect." Admitting Moses to have been the writer of the book of Genesis (as is established by its known internal and external evidences), still there is no improbability in supposing that, in drawing up the genealogical table, he may have had access to the archives kept by the priests among the Egyptians, the Phoenicians, and other surrounding nations. He was, as we are informed, "learned in all the learning of the Egyptians;" and that this included historical and ethnographic knowledge appears from the fragmentary remains of Manetho, Sanchoniaton, and Berossus, and the testimony of Herodotus. For the sake of clearness and perspicuity, this ancient ethnographic catalogue may be thrown into the following tabular form, with the most probable explanations which the labors of the learned have enabled us to offer.

1. JAPHETITES.

- I. GOMER—the Cimmerians on the north coast of the Black Sea. Their descendants were,
 1. *Ashkenaz*—an unknown people, perhaps between Persia and the Black Sea.

Riphaeth—the inhabitants of the Riphaean Mountains.

Togarmah—Armenia.

MAAGOG—the inhabitants of the Caucasus and adjacent countries—Scythiana.

MADAI—the Medes.

JAVAN—the Ionians or Greeks. Their descendants were,

Etishah—the Hellenes, strictly so called.

Turashah—Tartessus, in the south of Spain.

Kittim—the inhabitants of Cyprus and other Greek islands, with the Macedonians.

Dodanim—the Dodonæi, in Epirus, or perhaps the Rhodians.

TUBAL—the Tibareni, in Pontus.

MESHECH—the Moechi (Muscovites?), in the Moschian Mountains, between Iberia, Armenia, and Colchia.

TIRAS—the Thracians, or perhaps the dwellers on the River Tiras, the Dniester.

2. HEMITES.

USH—the Ethiopians. **GAMITES** thinks that all the nations enumerated in Gen. x, 7, as sprung from Cush, are to be sought in Africa. Their descendants were,

Nimrod—the first king of Shinar, i. e. Babylon and Mesopotamia, where he founded Babel, Erech, Calneh, and Accad.

Seba—Meroe.

Havilah—the Aivaltes, dwelling on the Sinus Aivaltes, now Zella, southward of the straits of Babel-Mandeb.

Sabtah—Sabata, situated on the coast of the Arabian Gulf, not far from the present Arkiko.

Raamah—Rhegma, in the south-east of Arabia, on the Persian Gulf. Descendants or colonies were,

A. Sheba—probably a tribe in the northern Arabian desert, near the Persian Gulf.

B. Delan—Daden, an island in the Persian Gulf.

C. Sabtechah—the Zingiani, in the eastern parts of Ethiopia.

MISRAIM—the Egyptians. Their descendants were,

L. Ludim, } probably African tribes.

I. Anamim, }

K. Lehabim or Lubim—the Libyans.

L. Naphthuhim—the inhabitants of the province of Nephthys, on the Lake of Sirbo, on the borders of Egypt and Asia.

M. Pathrusim—the inhabitants of the Egyptian canton of Pathures (Pathros).

N. Casuhim—the Colchians. Their descendants or colonies were,

A. Philistim—the Philistines.

B. Caphortim—the Cretans.

P. PHUT—the Mauretanians.

CANAAN—the inhabitants of the country so called, from Sidon to the south end of the Dead Sea. Their descendants were,

1. Sidonians—on the northern borders of Canaan or Phœnicia.

2. Hehités or Hittites—in the country of Hebron, south of Jerusalem.

3. Jebusites—in and around Jerusalem.

4. Amorrites—on the east and west side of the Dead Sea.

5. Gingsites—south-east of the Sea of Galilee.

6. Hivites—at the foot of Hermon and Antilibanus.

7. Arkités—in the city of Arca, in Phœnicia.

8. Sinités—in the country of Lebanon.

9. Arvadites—on the Phœnician island of Aradus, and the opposite coast.

10. Zemarites—the inhabitants of the Phœnician town of Silyra.

11. Hamathites—the inhabitants of the Syrian town of Epliphania, on the Orontes.

8. SEMITES.

ELAM—the Persians, particularly of the province of Elyma.

L. ASSHUR—the Assyrians, founders of Nineveh, Rehoboth, Calneh, and Resen.

II. ARPAKSHAD—the inhabitants of the northern point of Assyria (Arrapachitis). A descendant was

Salah; from whom came

Eber, progenitor of the Hebrews; and from him,

A. Faleg, and

B. Joktan, called by the Arabians *Kaotjan*, ancestor of the following Arab tribes:

1. Almadad—in Southern Arabia.

2. Sheleph—the Selapenes, in Nejd or Tehama, in Southern Arabia.

3. Hazarmaveth—the inhabitants of the Arabian province of Hadramaut.

4. Jerah—the inhabitants of the Mountain of the Moon (Jebel or Gobb el-Kamar), near Hadramaut.

5. Hadoram—probably the Atramites, on the southern coast of Arabia.

6. Usal—the inhabitants of the country of Sanaa, in Southern Arabia.

7. Diklah—probably the district of the Minæi, in Arabia.

8. Obal—unknown.

9. A Bimael—the Mall, in the vicinity of Mecca.

10. Sheba—the Sabæans, in Southern Arabia.

11. Ophir—the inhabitants of El-Ophir, in the Arabian province of Oman.

12. Havilah—the Chaulotal, dwelling on the Persian Gulf.

13. Jobab—the Jobabites, on the Gulf of Salachitis, between Hadramaut and Oman.

IV. LUD—probably the Lydians in Asia Minor.

V. ARAM—the inhabitants of Syria and Mesopotamia. Their descendants were,

1. Uz—the inhabitants of a district in the north of Arabia Deserta.

2. Hul—perhaps the inhabitants of Cœlo-Syria.

3. Gether—unknown.

4. Mash—the inhabitants of a part of the Gordiean Mountains (Mons Masius), north of Nisibis.

See **ETHNOLOGY**.

Divorce, JEWISH (חִירּוּת, *kerithuth*, a cutting apart, Jer. iii, 8; ἀποστάσιον, *desertion* or separation; both usually rendered "divorcement;" the verb is

שָׁרַף, *garash'*, to *scapel*, Lev. xxi, 14; xxii, 18; Num. xxx, 9; ἀπόλυοι, to *disolvo*' or dismiss, Matt. v, 82), or repudiation (comp. *repudiium*, Sueton. *Calig.* 86) of a wife or betrothed woman (see the tract *Kiddushin*, in the Mishna, iii, 17; and the *Gemara Hieros.* Heb. and Lat. in Ugolino, xxx). There is great probability that divorces were used among the Hebrews before the law, since Christ says that Moses permitted them by reason only of the hardness of their hearts; that is to say, because they were accustomed to this abuse, and to prevent greater evils. Abraham dismissed Hagar, on account of her insolence, at the request of Sarah. We find no instance of a divorce in the books of the Old Testament written since Moses, though it is certain that the Hebrews separated from their wives on trifling occasions. Samson's father-in-law understood that, by his absence from her, his daughter was divorced, since he gave her to another (Judg. xv, 2). The Levite's wife, who was dishonored at Gibeah, had forsaken her husband, and would not have returned had he not gone in pursuit of her (xix, 2, 3). Solomon speaks of a libertine woman who had quitted her husband, the director of her youth, and had forgotten the covenant of her God (Prov. ii, 16, 17). The prophet Malachi (ii, 15) commends Abraham for not divorcing Sarah, though barren; and inveighs against the Jews, who had abandoned "the wives of their youth." Micah also (ii, 9) reproaches them with having "cast out their wives from their pleasant houses, and taken away the glory of God from their children forever."

—Calmet. As the Hebrews paid a stipulated price for the privilege of marrying (in the shape of dower presents), they seemed to consider it the natural consequence of making a payment of that kind that they should be at liberty to exercise a very arbitrary power over their wives, and to renounce or divorce them whenever they chose. This state of things was not equitable as regarded the women, and was very often injurious to both parties. Finding himself unable, however, to overrule feelings and practices of very ancient standing, Moses, in his declaration of the law, merely annexed to the original institution of marriage a very serious admonition to this effect: that it would be less criminal for a man to desert his father and mother than, without adequate cause, to desert his wife (Gen. ii, 24). He also laid a restriction upon the power of the husband so far as this, that he would not permit him to repudiate his wife without giving her a bill of divorce, in which were set forth the date, place, and cause of her repudiation, and a permission was given by it to marry whom she pleased. He further enacted that the husband might receive the repudiated wife back in case she had not in the mean while been married to another person; but if she had been thus married, she could never afterwards become the wife of her first husband—a law which the faith due to the second husband clearly required (Deut. xxiv, 1-4; Jer. iii, 1; Matt. i, 19; xix, 8). Ezra and Nehemiah obliged a great number of the Jews to dismiss the foreign women, whom they had married contrary to the law (Ezra x, 11; xii, 19). As Christ has limited the permission of divorce to the single case of adultery, he denied the equity of the Mosaic statute; and

in justification of Moses maintained that he permitted divorces for causes below adultery only for prudential reasons for the time being. Nor was this limitation by Christ unnecessary, for at that time it was common for the Jews to dissolve the union upon very slight and trivial pretences (Matt. v, 31, 32; xix, 1-9; Mark x, 2-12; Luke xvi, 18). As wives were considered the property of their husbands, they did not possess by the Mosaic statutes a reciprocal right, and were not at liberty to dissolve the matrimonial alliance by giving a bill of divorce to that effect. Josephus was of opinion (*Ant.* xv, 11) that the law did not permit women to divorce themselves from their husbands. He believes Salome, sister of Herod the Great, to be the first who put away her husband; though Herodias afterwards dismissed hers (*Ant.* xviii, 7), as did also the three sisters of the younger Agrippa, and others theirs. The following remarks are in part from Smith, s. v. See ADULTERY.

The Mosaic law regulating this subject is found in Deut. xxiv, 1-4, and the cases in which the right of a husband to divorce his wife was lost are stated xxii, 19, 29. The ground of divorce was what the text calls a *דְּבַר עֲרִירָה* (lit. *nudity of a word or thing*, i. e. *anything filthy*, some shameful act or circumstance, as in Deut. xxiii, 14), "some uncleanness" (Deut. xxiv, 1), on the meaning of which the Jewish doctors of the period of the N. T. widely differed, the school of Shammai seeming to limit it to a moral delinquency in the woman, while that of Hillel extended it to trifling causes ("for every cause," Matt. xix, 3; as among the Druses, Burckhardt, *Trav.* i, 829), e. g. if the wife burnt the food she was cooking for her husband, or merely over-salted it (*Mishna, Gittin*, ix, 16). Rabbi Akibah allows divorce if the husband merely saw a wife whose appearance pleased him better (see *Otho, Lex. Rab.* p. 502 sq.). The Pharisees wished, perhaps, to embroil our Saviour with these rival schools by their question (Matt. xix, 3); by his answer to which, as well as by his previous maxim (ver. 31), he declares that, but for their hardened state of heart, such questions would have no place. Yet, from the distinction made, "But I say unto you" (ver. 31, 32), it seems to follow that he regarded all the lesser causes than "fornication" as standing on too weak ground, and declined the question as to the interpretation of the words of Moses (see Tholuck, *Sermon on the Mount*, p. 220 sq.). We may conjecture that the Mosaic statute had reference to doubts of his bride's virginity, or of his wife's modesty and fidelity, on the part of the husband, although he might not be able to bring a definite charge of unchastity. It would be unreasonable to suppose that by *דְּבַר עֲרִירָה*, to which he limited the remedy of divorce, Moses meant "fornication," i. e. adultery, for that would have been to stultify the law "that such should be stoned" (John viii, 5; Lev. xx, 10). The practical difficulty, however, which attends on the doubt which is now found in interpreting Moses's words will be lessened if we consider that the mere giving "a bill" (or, rather, "book," *סֵפֶר*, βιβλίον, Talm. גִּטָּה וְכֵתוּבָה) "of divorcement" (comp. Isa. i, 1; Jer. iii, 8), would in ancient times require the intervention of a Levite, not only to secure the formal correctness of the instrument, but because the art of writing was then generally unknown. This would bring the matter under the cognizance of legal authority, and tend to check the rash exercise of the right by the husband. Traditional opinion and prescriptive practice would probably fix the standard of the *עֲרִירָה*, and doubtless, with the lax general morality which marks the decline of the Jewish polity, that standard would be lowered (Mal. ii, 14-16). Thus the Gemar. Babyl. *Gittin*, 9 (ap. Selden, *De uz. Heb.* iii, 17) allows divorce for a wife's spinning in public, or going out 'h head uncovered, or clothes so torn as not prop-

ly to conceal her person from sight. But the abuse of any case in point in the period which lay nearest the lawgiver himself, or in any, save a much more recent one, makes the whole question one of great uncertainty. The case of Phalti and Michal is a point, being merely an example of one arbitrary as redressed by another (1 Sam. xxv, 44; comp. 2 Sam. iii, 14-16). Selden, quoting (*De uz. Heb.* iii, 15) *Lev. Prof.* p. 8, b, etc. speaks of an alleged custom of the husband, when going to war, giving the wife the *libellus divorcii*; but the authority is of slight value, as the fact improbable. It is contrary to all known oriental usage to suppose that the right of quitting the husband and choosing another was allowed to women (Josephus, *Ant.* xv, 7, 10). Salome is noted (*ibid.*) as the first example of it—one, no doubt, derived from the growing prevalence of heathen laxity (see Wadsworth, *Hellen. Alterthum.* iii, 206). Hence also, probably, the caution given 1 Cor. vii, 10. Those are easily mistaken who suppose that a man might take back a remarried wife whom he had divorced, except in those cases when her second husband had died, or had divorced her. Such resumption is contemplated by the lawgiver as only possible in those two cases, and therefore is in them only expressly forbidden (Jer. iii, 1). The divorces of Gentile wives ordered by Nehemiah (Ezra x, 11; xii, 19) rested on entirely different grounds. For the view taken among later Jews of this subject, see Joseph. *Ant.* iv, 8, 23; xvi, 7, 3; *Lit.* 76, a writer whose practice seems to have been in accordance with the views of Hillel. On the general subject, Buxtorf, *de Sponsal. et Divort.* p. 83-85; Selden, *Uxor. Hebr.* iii, 17 sq.; Michaelis, *Lives of Jews* ii, 386; and Danz, in Menschen's *N. T. Talm.* p. 67 sq., may be consulted. For the Greek and Roman usages on the subject, see Smith's *Dictionary of Class. Antig.* s. vv. Divortium, Apodicepsos Dike. Paragraphs have been written on the passage in Deut. vii, Winkler (*Unters. schweizer Schriftstellen*, ii, 26 sq.) also on the passage in Matt. by Venema (in his *Lection. sacr.* ed. 2, append.); Wolff, *De divorcio Judaeorum* (Lips. 1789); Schindler, *Quaedam de matrimonio* (Liegn. 1795); Hommelhosius, *Utrum divorcium fit* (Jen. n. d.). See MARRIAGE.

DIVORCE, CHRISTIAN LAW OF. Under the term divorce are included several separations of married persons which are quite unlike one another. First they may have been joined in unlawful wedlock when near relationship was a bar to their union, and the law, on ascertaining this fact, declares that they never were legally married. Such was the case where Henry VIII of England was separated from his first wife by an ecclesiastical court, and was permitted to marry again; or, as it would be more proper to say, was declared never to have been married at all. Cases of this kind are properly not divorces, but annulments of marriage, or declarations of the nullity of the marriage. They occur in all societies and against them the precepts of Christ are not directed. Only it is a sin of legislation, and a snare to men, if the obstacles to marriage are, as they are in Catholic countries, made too numerous. Secondly, there are separations of persons lawfully married which involve the impossibility for either of them to marry again during the life of the other. These are often called divorces or separations *a mensa et thoro*, and sometimes separations merely. Finally, there are divorces proper, or separations *a vinculo matrimonii*, dissolutions of a marriage originally lawful, with liberty given to one or both parties to contract a new marriage. It is these two last kinds of divorce to which we shall confine ourselves in the present article.

At the time when Christ appeared in the world a very great laxity of divorce prevailed in the nations which have had the greatest influence on the progress of mankind. Among the Jews, as has been seen above, the husband could repudiate his wife for any cause

ch rendered her society distasteful to him, and was required by the law to give her a formal notice to withdraw from his house. The wife, it is true, had no liberty, and yet ladies of the higher classes among Jews were beginning to act as if they had. Among Greeks and Romans, both husband and wife had not unrestricted power of divorce in their hands; only could they separate by mutual agreement, but either party could loose the marriage bond with little or no formality. Among the Romans, originally seen in observing the laws of family morality, there had been a gradual declension through several centuries until the days of Christ. At that time the emperor Augustus attempted by a system of laws to put a stop to the alarming neglect of marriage, to the freedom of divorce in certain respects, and to the frequency of adultery. Loss of more or less dowry, or obligation to pay it back, fell on the culpable author of divorce, and severe penalties were inflicted on an adulterous wife and her paramour. But Roman manners were too corrupt to be made better by the *leges licæ* relating to these points. The higher classes practised divorce and committed adultery almost *ad vitam*, and the lower lived to a considerable extent in concubinage. The evil remained uncured. The emperor Septimius Severus, as Dion Cassius says (lib. viii, § 16), who had the records in his hands, and was consul under this sovereign, instituted three thousand prosecutions for adultery at the beginning of his reign; but manners were too strong for law, and it all went for nothing.

Meanwhile the commands of Christ in relation to divorce were a slowly-working leaven, thrown into his church to keep it pure, and, through the Church, descended, more or less, to influence legislation, and to aid those other influences by which the Gospel sought to improve family life. These precepts of the Master are contained in Matt. v, 31, 32; xix, 3-10; Mark x, 2-12, and Luke xvi, 18, to which the teaching of Paul in 1 Cor. vii, 10-15, is to be united as an important supplement. We propose to give the substance of the instructions in the New Testament concerning divorce under several heads, but have not space to defend our positions as fully as we could wish. 1. The liberty given to a man by the Mosaic law to put away his wife "because he found some uncleanness" or something offensive in her (Deut. xxiv, 1) was an accommodation to the hardness of the Jewish heart, and did not harmonize with the original declarations concerning the nature of marriage. 2. He, therefore, who puts away his wife, except on the ground of her fornication, and marries another, commits adultery (Matt. xix, 9), and he who thus puts her away leads her to commit the same crime (Matt. v, 32). 3. He who marries a woman that has been divorced commits adultery, and he who marries a woman who puts away her husband and marries another man (Mark x, 12) incurs the same kind of guilt, which is a precept that seems to look beyond the Mosaic code, under which no liberty of initiating divorce was conceded to Jewish women, to the practices of heathen lands. We may observe in regard to these passages, first, that Mark and Luke do not record the exception preserved in Matthew, "excepting for the cause of fornication," but the plain reconciliation of the passages must be found in the principle that an exception in a fuller document must explain a briefer one, if this can be done without force. Now, as divorce for that one reason was admitted by all, Mark and Luke might naturally take this for granted without expressing it. *Secondly*, by fornication is intended a sexual crime since the beginning of the marriage state committed by either of the parties with a third person, i. e. adultery begun or completed. And the exceedingly rare crime of sodomy, or bestiality, as the greater, may be fairly included in the less, adultery. *Again, thirdly*, the exception is the sole exception. It cannot be said with any honesty that Christ, in saying

"except it be for fornication," gives a sample of the causes which may dissolve the marriage union, as one of many which put an end to the state beautifully called *one flesh*. Plainly but one cause of separation with remarriage is in his thoughts, and that is one in its outward nature and grossness distinct from all others. Nor again, *fourthly*, can it be said that these precepts were intended to govern individual action, but that, where the law of the state permitted, the individual, acting under public law, might exercise the right of divorce for other reasons. For Christ set aside Jewish law. He says, let not man put asunder, i. e. *not the individual man*, but *man as opposed to God*, who established the primeval law of marriage. He gives a rule to his followers, who must follow it, whether the State allows larger liberty or not. Christians may live in a State which feels no obligation to conform its law to Christ's views in this respect, but they will, if they have influence, necessarily change legislation regarded by them as injuring society like that which opens a wide path for divorce.

We come now to the supplemental precepts of Paul, who had to guide churches gathered amid the heathen, infected by heathenish views of marriage, some of whose members, by their conversion, were brought into the trying condition of having heathen partners. The apostle contemplates two cases: the first where both partners are believers, the other where one is not (1 Cor. vii). In the former case he repeats the Lord's rule against separation, with the additional injunction that if a woman should be separated from her husband, she must remain unmarried, or be reconciled to him. Here, then, the possibility of separation *a mensa et thoro* alone, without liberty of remarriage, is contemplated; and this passage has had a vast influence on ecclesiastical legislation. Most interpreters suppose that the apostle here is thinking of withdrawal from the marriage union for comparatively slight grounds, such as do not involve unfaithfulness—and this view alone seems to reconcile what Christ says with the supplementary precepts of Paul—but Augustine strives, with great pains and ingenuity (*de conjugii adulterio*), to show that divorce for adultery is intended, and applies the interpretation to our Lord's words. Hence adultery can be condoned by the innocent partner, and can only involve separation, without liberty to either party to enter into second nuptials. This view became prevalent, and had a great effect on subsequent opinion. In the other case, where one of the partners is an unbeliever, the apostle enjoins on the believer to be passive, to take no active steps for the purpose of dissolving the marriage because it is a union with a heathen, for it is a marriage after all. If the unbeliever wishes to retain the tie, the believer must not leave him or her. But if the unbeliever depart, "let him depart." A Christian "is not in bondage" in circumstances like these. Here the question arises, What does "not in bondage" mean? The fathers, at least to some extent, the Catholic and older Protestant interpreters, understood it to mean *not in bondage* to keep up the marriage connection, and hence *at liberty* to contract a new one. This interpretation has had wide effects. In the canonical law a believing partner was allowed, if thrust away by an infidel one, to marry again; and as the early Protestant theologians extended the rule, by analogy, to *malicious desertion* in Christian lands, an entrance-wedge was here driven into the older ecclesiastical laws, and much of the shocking facility of divorce in some Protestant countries has flowed from this source. But we reject the interpretation. We hold with Tholuck (Bergpred. ed. 4, p. 258), with Neander, De Wette, Meyer, and Stanley (commentaries on 1 Cor.), that the apostle means "not in bondage" to keep company with the unbeliever at all events, without having the thought of remarriage in his mind. This must be regarded, we think, as settled by the soundest modern exegesis.

Roman law adhered, on the whole, to its fatal facility of granting divorces for very slight reasons so long as the Western empire lasted; and even the Eastern empire, after it became Christian, did not move wholly in a new track. Meanwhile, opinion within the Church, and ecclesiastical law, took an opposite course. Owing to the interpretations of Scripture mentioned above, to new views of the sanctity of marriage, and at length to the developed doctrine of the sacrament of marriage, divorce with remarriage was excluded from Christian practice, with the single very rare exception of the case where an *infidel* or a Jew had deserted a *believer*; and separation *a mensa et thoro* remained as the only kind of divorce permissible. The law of all Christian states in the West until the Reformation, and of Roman Catholic states since, has been shaped by canon law, which knows no divorce with remarriage even for the cause of adultery. After the Reformation, when the Protestants had abandoned the doctrine of the sacramental character of marriage, and the Protestant interpreters generally held that malicious desertion, according to the apostle Paul, released the innocent party from the marriage bond altogether, many ecclesiastical ordinances in Protestant Germany permitted divorce with remarriage on this account, as well as in cases of adultery. Thus the Geneva "ordonnances ecclésiastiques" of 1541 declare that "if any one maketh a business of abandoning his wife to stroll through the country, and continueth unamended, it be provided that the wife be no longer bound to such a man, who will keep neither faith with her nor company." And in the ordinance of Braunschweig-Grubenhagen for 1581 it is said that divorce shall be granted only for the two reasons which Christ and Paul in the Gospel declare to be sufficient, of which the second is "malicious desertion, running away, and abandonment, whereof St. Paul speaketh, 1 Cor. vii." Still another ordinance, that of Lower Saxony of 1585, says that "whatever other grounds besides these two (adultery and desertion) are alleged by certain emperors, as Theodosius, Valentinian, Leo, Justinian, cannot be sufficient for divorce." Some few, it is true, of the earlier Church regulations limit divorce to cases of adultery, but a few others extend its operation beyond the two grounds already mentioned. The Prussian consistorial ordinance of 1584 permits it in cases of plotting to take the life of a consort. A Zurich ordinance of 1525 goes further still, so much so as to desert the principles of Scripture entirely. Not only does it allow divorce in cases of adultery, desertion, and attempt on life, but considers these as examples, and leaves it to the judge to decide what other grounds he will add to them, among which it mentions as possible cases not only cruelty, but insanity and eruptive disease, as leprosy. For the most part only adultery and desertion were, through the 17th and into the 18th century, held to be valid grounds for divorce. But in more recent times the civil law of some German states goes far beyond these limits. We confine ourselves to the Prussian code, where plotting against the life of a consort, grave transgressions against third persons, cruelty, refusal of connubial duties, insanity, impotence, or other incurable bodily disease commencing after marriage, incompatibility of temper and permanent variance, mutual consent without discord when the marriage is childless, are allowed to put an end to the marriage tie. The laws in Baden, and for non-Romanists in Austria, come near to these. It is impossible not to see in such legislation a disregard of the religious character of marriage, a tendency to look at it on the outside and as a civil contract, to consider it as a means to gain certain earthly ends. It has forgotten the religious side of life, and thus falls under the influence of Roman law, and looks at purely secular results.

An important chapter in the modern history of divorce would treat of French legislation on that subject.

A law passed Sept. 20, 1792, at the opening of the National Convention, overthrew the ancient law which followed the Roman Catholic doctrine of marriage, and opened the way for divorce on three grounds. These are, 1, mutual consent; 2, incompatibility of temper on complaint of either consort; 3, certain determined causes or motives derived from the condition or conduct of either of the married parties, viz. derangement of reason, condemnation to an infamous crime, crime, cruelties, or grave injuries committed by either party against the other, notorious licentiousness of men, desertion for at least two years, absence for at least five without sending news, and emigration from France in certain cases, which was naturally a temporary provision. Separation of body, or *a mensa et thoro*, was thereafter to be abolished. The divorced parties could marry one another *de novo*, and could marry other persons after certain short intervals. To a good degree these enactments follow the Roman law, but one peculiarity of this statute was that the family relatives were to act in the first instance as a kind of court of conciliation, when the parties, or one of them, desired divorce without allegation of crime. Divorces were now exceedingly frequent in France, but became much more easy after the acts of 1793 and 1794, permitting a man to marry at once, and a woman ten months after divorce was granted; and, what was far worse, making separation in fact of a married pair for six months cause for pronouncing them divorced without delay, if one of them demanded it. These laws belong to the worst times of the Revolution, and were suspended in August, 1795. The original law of 1792 gave place in 1803 to the new divorce law of the Code Civil, or Code Napoleon, which continued in force until the restoration of the Bourbons. The divorce law of the Code, although, in the main, agreeing with the law of 1792 on the causes of divorce, does away with the family council, restores for the sake of Catholics the separation *a mensa et thoro*—which, however, may afterward be converted into a full divorce on the demand of the innocent married partner—provides for the punishment of the unfaithful wife, and in its minute and tedious processes in the preparatory steps, seems intended to make the obtaining of divorces by mutual consent, and on the ground of incompatibility of temper, very difficult, as well as to leave room for chicanery of mind. Moreover, the limits within which divorces by mutual consent are confined is an observable step in the right direction. The courts, and several distinguished lawyers who were consulted on the article of the Code, were against granting divorce for incompatibility of temper, i. e. on the ground of mutual consent in any cases, but they could not carry their point. After the restoration of the Bourbons, this title of the Code was abrogated, and France returned to the old system, to which it has adhered, if we are not mistaken, until the present time.

In England, until after the Reformation, divorce and sentence of nullity, and divorce *a mensa et thoro* on the ground of adultery, were within the cognizance of the ecclesiastical court, and no divorce *a mensa et thoro* was known to the law. Henry VIII was separated from Catharine by the ecclesiastical court on the plea that a marriage with a brother's wife was void *ab initio*, and therefore no marriage; Anna Boleyn and Catharine Howard were convicted of adultery, and executed as attainder of treason; and Anne of Cleves was only nominally married. There was a project under Edward VI to allow the innocent party, after sentence of divorce, to marry again, but it was never sanctioned. Still, since many, especially among the more practical clergy and laity, held such marriage to be lawful, it was more or less practised. Men divorced on sentence of a court from adulterous wives sometimes married again (although the marriage was null and void, because there was no civil law to forbid it. In the first year of James I a statute made remarriage in the

fettime of a former husband or wife a felony, yet with the provision that the act should not extend to persons divorced or to be divorced by sentence of an ecclesiastical court. The matter was still at loose ends, but several canons were passed in the same year with the intention of putting a stop to the practice, by one of which it was ordained that a sentence of divorce should not be pronounced until the parties should have given sufficient security to the court that they would not, each during the other's life, contract matrimony with any other person. This canon was violated in a most scandalous way in 1605, soon after its enactment, when Lady Rich, after being divorced from her husband on the ground of her adultery, was married to her paragon, baron Mountjoy, afterwards duke of Devonshire, by his chaplain, Laud, who afterwards professed to repent of it. From the time of James, and, indeed, since the Reformation, only a special act of Parliament could authorize divorce *a vinculo* until the passage of a new general act in 1857. By this act a new court is established, having exclusive jurisdiction in cases of marriage, with the power of issuing sentences of *separation*—equivalent to divorce *a mensa et thoro*—which may be obtained either by the husband or the wife on the ground of adultery, or cruelty, or desertion without cause for two years and upwards; and with the power of *dissolving marriage* in cases of adultery. But the two parties are not exactly on a level with respect to their crime. On the wife's part, simple adultery can have this effect, or the husband's "incestuous adultery, bigamy with adultery, rape, sodomy, or bestiality, or adultery coupled with such cruelty as, without adultery, would have entitled her to a divorce *a mensa et thoro*, or adultery coupled with desertion for two years and upwards." In the case of separation, the court can restore the parties, on their consent and petition, to the exercise of conjugal rights. In the case of dissolution, after final decision on appeal to the House of Lords, if such appeal should be made, the parties are allowed to marry again, both the innocent and the guilty party, the latter, so far as appears, to the partner in crime—a provision, in our judgment, much to be condemned. Nor is there any civil penalty for adultery. The innocent husband may, as before this act, get damages from the offenders, but the former action for criminal conversation is to cease. We forbear to go further into the act, only adding that collusion, condonation of adultery, adultery, cruelty, or desertion, on the part of the petitioning party, and unreasonable delay in presenting the petition for dissolution of marriage, free the court from the obligation to pronounce a decree of dissolution.

In the United States, the divorce laws, in different states, run along from the strictness of English law almost to the looseness of that of Rome and revolutionary France. The tendency is towards increased looseness, as is shown by the revised laws of the older states, and the laws of some of the new states. Of looser legislation, Connecticut and Indiana furnish examples. We confine ourselves to the legislation of the former state. The colonial laws allowed the court to grant divorce for adultery, fraudulent contract, wilful desertion for three years, or seven years providential absence without being heard of after due inquiry made and certified, and in all these cases the aggrieved party might marry again. This legislation remained almost unchanged for nearly two hundred years, yet not without strong remonstrances on the part of some of the clergy, who complained more especially of the loose administration of the law by the courts. In 1843 two new causes of divorce were added to the old, namely, "habitual intemperance" and "intolerable cruelty;" and five or six years afterwards the legislation on this subject reached its climax by the further addition to the causes of divorce of "imprisonment for life," "infamous crime," and any such "misconduct as permanently destroys the happiness of the petitioner, and

defeats the purposes of the marriage relation." Now first a vague subjective indeterminate cause was added to the determinate causes of former legislation, and the looseness in hearing and determining cases of divorce is so great that the worst legislation of the French Revolution could not be much more opposed to the true interests of society. The law knows no separation *a mensa et thoro*, allows immediate remarriage, does not forbid an adulterer or adulteress to be united after divorce to a partner in guilt, nor divorced persons to be remarried to one another. Divorces have, as might be expected, greatly increased with the new legislation, especially since the *omnibus* clause, as it is called, was annexed to the law. In one year, according to a recent report, they bore to marriages the ratio of one to eleven. Now, as nearly one seventh of the population are Roman Catholics, who rarely apply for divorces, and as in a certain grade of society, embracing perhaps half the people, divorces are almost unknown, it may, we think, be safely said that one quarter or one fifth of the marriages of each year, in the lower stratum of Protestant society, if we may so call it, are dissolved by act of the courts. Without question, the family life and morals of a community once most religious, and even now retaining much of steady habit, must be gradually undermined and poisoned by such a social evil (see H. Loomis, "Divorce Legislation in Connecticut," *New Englander*, July, 1866).

Our limits preclude us from adding more than a word or two in regard to the right legislation on this subject, and the duty of the Church when cases of divorce come before those to whom its discipline is intrusted. 1. A Christian legislator will strive to realize in law what he conceives to be the true conception of marriage, and the law of Christ in the Gospel. Only on this subject does Christ legislate; here he sets aside the law of Moses, and this he does in regard to an institution of life concerning which the law must speak. If the Christian legislator does not carry out Christ's principles in regard to divorce, it will be not because they are moral rather than jural, but because "the hardness of men's hearts" prevents the introduction of a perfect rule. He will consent with a good conscience to a less perfect law, for the law of divorce *permits*, and does not require, so that it need bring no Christian man into disobedience to the Gospel. 2. Among the outlines of good legislation in regard to divorce, we suggest the following: the recognition of the two kinds of divorce, mere separation and that *a vinculo*, with the reservation of the latter for graver crimes of one party against the other; punishment of the offending party by imprisonment, or deprivation of alimony, or both; prohibition of speedy marriage when it is allowed, of all marriage between one of the parties and a partner in guilt, of all remarriage after full divorce on the ground of adultery; a careful, deliberate process, perhaps before a special court, leaving room for reconciliation, preventing collusion as far as possible, and making it no slight matter to dissolve the relation. 3. When the state law is not accordant with the law of Christ as commonly received in the churches, what is their duty? One thing is clear, that a clergyman ought not to be compelled to unite in marriage to a new wife or husband a person whom he considers to be unlawfully divorced. The English law expressly relieves the ministers of the Established Church from this necessity; the Prussian, if we are not misinformed, is harsh and intolerant in this respect; the French law requires a civil marriage, and leaves it to the consciences of parties and of clergymen to go through with the religious ceremonies or not, as they see fit. On the other hand, no clergyman can with a good conscience join in marriage those whom Christ's law, according to his interpretation of it, keeps apart, as, for instance, a woman, separated from her husband for incompatibility of temper, and

another man. They are not those whom God has joined together, and the woman man has unlawfully parted from her husband, so that she commits adultery in her new marriage. Again, there are questions of discipline growing out of divorces, as when a member of the Church contracts a marriage not forbidden by state law, but forbidden by Christ. Here the rule is tolerably clear. Christ's law must be maintained, whatever the state requires or allows, and maintained in this case by discipline. Only thus can the Church be a witness on the side of Christian morality. Only thus can it guard the sanctities of family life. There is no more reason for omitting discipline for unlawful divorce permitted by the state than for drunkenness, if no state law exists against this sin. But there are cases of another sort which present serious difficulty, as when a person, having violated Christ's rule of divorce in contracting marriage, becomes a sincere Christian years afterwards, and desires to unite with the Church. Shall such a person be required to separate from his or her consort before being received into communion? The act would not have been committed with the present disposition, and state law tempted to its performance. We think that in such a case as this, at least in extreme cases of this kind, the communion may be opened to a penitent without conditions.

Diz'ahab (Heb. *Di-Zahab'*, דִּזְאָהָב [see below]), a place in the desert of Sinai, one of the boundary points of the "Arabah," or region where the Israelites wandered (Deut. i, 1). It is probably the same cape now called *Dahab* (Robinson, *Res. i*, 217; ii, 600), on the western shore of the Elicanic Gulf (Schwarz, *Palest.* p. 212), about opposite Sinai; it abounds in palms, and has traces of ruins (Burckhardt, *Syria*, p. 523). Wilson, however, doubts the identification (*Lands of Bible*, i, 285 n.). See WILDERNESS. The name is indicative of the presence of gold there, as that is the meaning of the latter half of the word (so Sept. *Καρχύσσεα*, Vulg. *ubi auri est plurimum*); but the former part of the name is foreign, either with the Aramaean expletive = *of* (literally "that which is"), or from the Arabic = *lord*, "i. e. possessor of (Gesenius, *Theo.* p. 384). With this import also agrees the description of Eusebius and Jerome (*Onomast. s. v. Καρχύσσεα*, Cata Ta Chrysea), that the mountains in that region (in *Phæno*, according to the true reading; see Le Clerc in Bonfrère's ed.) are full of gold veins; also the modern name, which is in full *Minah-el-Dahab*, "the porch of gold" (Büsching, *Erdbeschr.* XI, i, 621).

Doane, GEORGE WASHINGTON, D.D., LL.D., Protestant Episcopal bishop of the diocese of New Jersey, was born in Trenton, N. J., in 1799. He graduated at Union College, Schenectady, at nineteen years old, and then commenced the study of theology. He was ordained deacon by bishop Hobart in 1821, and priest in 1823. He served in Trinity church, New York, three years, and in 1824 was appointed professor of belles-lettres and oratory in Washington College, Ct. He resigned that office in 1828, and soon after was elected rector of Trinity church, in Boston. He was consecrated bishop of the diocese of New Jersey on Oct. 31, 1832. He founded St. Mary's Hall in 1827, and Burlington College in 1846, both of which institutions remain flourishing. His career as a bishop was one of indefatigable industry and devotion. "I look back," says the bishop of Missouri, "upon the work he accomplished during his episcopate with amazement. The work of three lives was crowded into a bishopric of twenty years." The clergy of his diocese increased in that time from 18 to 99; its parishes from 80 to 84; 58 churches were consecrated, and the number of communicants increased from 657 to 5000. His energy, however, was greater than his judgment, and his career was not without acts of imprudence, which cost him great trouble. His literary industry was

very great, and he had a genuine vein of poetry. His writings, in prose and verse, are gathered in *The Life and Writings of G. W. Doane, D.D.*, edited by his son (New York, 1860, 4 vols. 8vo.), of which vol. i contains a memoir and his poetical writings; vols. ii and iii consist of sermons and episcopal charges; vol. iv of educational writings and orations. Bishop Doane died at Riverside, April 27, 1859.—*American Quart. Christ. Review*, Oct. 1859, and April, 1861.

Dob. See BEAR.

Dober, LEONHARD JOHANN, a Moravian missionary, was born in 1706 at Münchroth. He went to Herrnhut in 1725, and in 1732 was sent as first Moravian missionary to the negroes of St. Thomas. He returned in 1735; became general elder of the congregation, labored for some time for the conversion of the Jews in Amsterdam; and in 1741 resigned his office as general elder, which at the London Conference of Sept. 16, 1741, was transferred to Christ himself. In 1747 he became bishop of the Moravians. He died in 1768. He is the author of many hymns in the Moravian Hymn-book.

Dobmayer, MARIAN, a German Jesuit and theologian, was born at Schwandorf, Oberpfalz, Oct. 21, 1753, entered the Jesuit order, and on its suppression in 1773 became a Benedictine. In 1778 he was ordained priest, and in 1781 he became professor at the Lyceum of Neuberg; in 1794 professor of theology at Ingolstadt. In 1799 he returned to the Benedictine monastery at Weissenob, and thence went to Amberg as professor of theology, in which office he died, Dec. 21, 1808. His chief works are his *Conspectus Theologicæ Dogmaticæ* (Amberg, 1789):—*Systema Theologicæ Catholicæ* (poethumous; 1807-1819, 8 vols. 8vo.) of which an abridgment was published in 1822, edited by Professor Salomon of Regensburg.—Wetzlar u. Weiz. *Kirchen-Lexikon*, iii, 186.

Dobritzhoffer, MARTIN, a Jesuit missionary, was born at Grätz, in Styria, in 1717. He was admitted to the Society of Jesus in 1736, and was sent in 1738 as missionary to Paraguay, where he spent eighteen years among the Abipones and Guaranas, when, on the expulsion of the Jesuit missionaries from Spanish South America in 1767, he was compelled to return to Europe. In 1784 he published *Historia de Abipones, equestris bellicosæque Paraguaricæ Nationis* (Vienna, 3 vols. 8vo, 1788-84). It is very ample and minute, but though it contains many curious and interesting facts, abounds in extravagant statements. Dobritzhoffer's book was a favorite with Southey, and at his suggestion Sara Coleridge translated it into English.—*An Account of the Abipones, an equestrian People of Paraguay* (1822, 8 vols. 8vo.). It has also been translated into German. Dobritzhoffer died at Vienna in 1791.—*English Cyclopædia*; Hofer, *Novæ. Biog. Geogr.* xiv, 408.

Docetæ. Docetism, which in the latter half of the second century took form in the sect of the Valentinians—so named after Valentinus—is, in fact, only a form of Gnosticism—a form, moreover, which played a most important part in the general movement of Gnosticism. Its prominent teachers, as Valentinus—a man of great depth, ingenuity, and power of imagination—Cassianus, and Bardesanes, are reckoned among the Gnostics. How Docetism is to be distinguished from general Gnosticism is not easy to be stated in a brief article; the Church histories must be consulted on this point. The dualism of the Oriental philosophy, the elements of which were extensively embraced in all forms of Gnosticism, especially the view which held the inherent evil of matter, rendered it impossible for the Gnostics to come to any right view of the union of the divine and human in Christ's person. In order to remove the author of all good from all contact with matter, which they conceived to be the same as evil, they endeavored in the aid of Oriental philosophy in order

o people the space between God and matter with a vast succession of superhuman beings as mediators between God and the world. These, emanating from the Deity, were called sons; among these the highest rank was assigned to Christ. Here, however, they seem to have split. "Many imagined that Jesus was a mere man, and maintained that the son Christ descended upon the man Jesus at his baptism, and left him immediately before his crucifixion, so that Christ was not, in fact, subjected to pain and death; while others held that the body, with which Christ appeared to be invested, was not really human and passible, but unsubstantial or ethereal, or, at least, immaterial: these last were called Docetæ" (*Waddington's Hist. of the Church*, p. 74, 75). They denied the whole humanity of Christ, regarding it only as a deceptive show, a mere vision. This the sense of the Church could not bear. "They who would make nothing but a spectre are themselves spectres—spectral men," is an expression ascribed to Ignatius. Tertullian says to the Docetæ, "How is it that you make the half of Christ a lie? He was all truth." And again, "You are offended when the child is nourished and fondled in its swaddling-clothes. This reverence shown to nature you despise; and how were you born yourself? Christ, at least, loved man in this condition. For his sake he came down from above; for his sake he submitted to every sort of degradation—to death itself. In loving man he loved even his birth, even his flesh" (*Neander, Church Hist.* ii, 869). Neander says: "One consequence of the disruption of the divine and the human by Gnosticism was Docetism, which altogether denied the real, humanly-sensuous side of Christ's life, and only acknowledged as real the revelation of the divine Being. Preparation for this view had been made among the Jewish theologians by the representation that it was one of the privileges of a superior spirit to appear in a variety of forms. Philo's explanation of the Angelophanies, and the Christology of the Clementine homilies, furnish evidence of this. According to that Docetic conception, the heavenly Being, whose nature is pure light, suddenly came forth as a sensuous apparition. All sensuousness is only an illusion practised by the divine Genius. Hence the latter by no means attached himself to the Demiurgos; only an appearance of him descended into this world" (*Neander, Hist. of Dogmas*, i, 194).

Docetism was a most subtle element, which wrought variously before it had any discernible concentration in any leading men or sects, and it infused its unreal and fantastic leaven into various Gnostic sects, and other later ones which grew out of Gnosticism. It was a deep, natural, rationalistic, pseudo-spiritualistic, anti-incarnation element. It was firmly set against the real union of the divine and human in Christ, and against all dogmas which depend upon the reality of the incarnation. Hagenbach says: "The Docetæ, whom Ignatius (*ad Eph.* 7, 8, *ad Smyrn.*, c. 1-8) already opposed, and probably even the apostle John (1 John i, 1-3; iv, 2 sq.; 2 John, 7) (on the question whether he alludes to them in his prologue to his gospel, see Lücke, *in loc.*) may be considered as the forerunners of the Gnostics (Burton, *Bampton Lect.* p. 158 sq.). They form the most decided contrast with the Ebionites, inasmuch as they not only maintain (in opposition to them) the divinity of Christ, but also merge his human nature, to which the Ebionites exclusively confined themselves, in a mere phantom (by denying that he possessed a real body). Ebionitism (Naziritism) and Docetism form, according to Schleiermacher (*Glaubenslehre*, i, 124), natural heresies, and complete each other, as far as this can be the case with one-sided opinions; but they quite as easily pass over from the one to the other (comp. Dorner, *Geschichte der Christologie*, p. 849 sq.)" (*Hagenbach, Hist. of Doctrines*, i, 48). The fathers were compelled to war with this subtle Docetism constantly, as it ever broke out in

new places, and attacked the true Christian faith at most unexpected points. Even some of them, as Clement and Hilary, were temporarily ensnared by some of its subtleties. Docetism (the speculative view of Christ's person) reappears in modern times in the mythical and spiritualistic theories which "attempt to reduce Christianity to an æsthetic religion, in which no realities are necessary but such as the human mind can supply as ideas" (*Martensen, Dogmatics*, § 128). See Schaff, *Hist. of the Christian Church*, i, § 71; Neander, *Church History* (Torrey's edit.), i, 386; ii, 717; Hase, *Church History*, § 87; Hagenbach, *History of Doctrines*; Dorner, *Doctrine of the Person of Christ* (Edinb. transl.), div. i, vol. i.

Doch. See DOCHUS.

Doohan. See MILLET.

Doctor (*διδάσκαλος*), a teacher, as the terms both signify (Luke ii, 46; v, 17; Acts v, 84). Anciently learned men among the Jews were denominated *רַבִּי*, *chakam'*, sage, as among the Greeks they were called *σόφος*, *wise*. In the time of our Saviour the common appellation for men of that description was *νομοδιδάσκαλος*, "teacher of the law," or *νομικός*, "lawyer," less exactly *γραμματεὺς*; in the Hebrew *סוֹפֵר*, *sopher'*, meaning "scribe." They were addressed by the honorary title of *רַב*, *Rab*, *רַבִּי*, *Rabbi*, *great*, or *master*. The Jews, in imitation of the Greeks, had their seven wise men, who were called *Rabboni* (q. v.), of which number Gamaliel was one. They called themselves the children of wisdom, an expression which corresponds very nearly to the Greek *φιλόσοφος*, "philosopher" (*Matt.* xi, 19; *Luke* vii, 85). The heads of sects were called fathers (*Matt.* xii, 27; xxiii, 1-9), and the disciples, *תַּלְמִידִים*, *talmidim'*, were denominated sons or children. The Jewish teachers, at least some of them, had private lecture-rooms, but they also taught and disputed in synagogues, in temples, and, in fact, wherever they could find an audience. The method of these teachers was the same with that which prevailed among the Greeks. Any disciple who chose might propose questions, upon which it was the duty of the teachers to remark and give their opinions (Luke ii, 46). See DISCIPLE.

There is a difference of opinion as to what part of the Temple it was in which our Saviour was found sitting with the doctors. There was no school in the Temple; but there was a synagogue, and several courts of council and judicature, including at this time the great Sanhedrim itself. It is very probable our Lord was offered a seat among them, from their being struck with admiration at the searching power of his questions, and the depth of knowledge which they displayed. But it is also possible that he might have sat on the floor with other young persons, while the doctors sat on raised benches, according to their custom. This was called sitting at their feet; and as the benches were often raised in a semicircle, those who sat or stood in the area might well be said to be "among" the doctors. See JESUS; TEMPLE.

Teachers were not invested by any formal act of the Church or of the civil authority; they were self-constituted. They received no other salary than some voluntary present from the disciples, which was called *τιμή*, rendered "honor" (1 Tim. v, 17), and they acquired a subsistence chiefly by the exercise of some art or handicraft. See TEACHER. According to the Talmudists, they were bound to hold no conversation with women, and to refuse to sit at table with the lower class of people (*Matt.* ix, 11; *John* iv, 27). The subjects on which they taught were numerous and of no great interest, of which there are abundant proofs in the Talmud. See SCHOOL.

Doctors of the law, frequently mentioned in the New Testament, were chiefly of the sect of the Pharisees;

but they are sometimes distinguished from that sect (Luke v, 17). See **LAWYER**.

In the schools that were established after the destruction of Jerusalem at Babylon and Tiberias, a sort of academical degree was conferred, the circumstances attending the conferring of which are thus stated by Maimonides. (1.) The candidate for the degree was examined both in reference to his moral character and his literary acquirements. (2.) Having undergone this examination with approbation, the disciple then ascended an elevated seat (see Matt. xxiii, 2). (3.) A writing tablet was presented to him, to signify that he should write down his acquisitions, since they might escape from his memory, and, without being written down, be lost. (4.) A key was presented to him, to signify that he might now open to others the treasures of knowledge (see Luke xi, 52). (5.) Hands were laid upon him; a custom derived from Numbers xxvii, 18. (6.) A certain power or authority was conferred upon him, probably to be exercised over his own disciples. (7.) Finally, he was saluted in the school of Tiberias with the title of Rabbi, and in the school of Babylon with that of Master. See **RABBI**.

DOCTOR, primarily a *teacher*. 1. The title Doctor of Theology (*Doctor Theologiae*) is the highest academical degree in theology. In England and America it is generally given under the title Doctor of Divinity (*Doctor Divinitatis*, abridged D.D.), or Doctor of Sacred Theology (S. T. D.).

2. The word was used at an early period as a general expression for a teacher of Christian doctrine, and later it was applied (before it became a special academical title) to men eminent for their knowledge in theology, and for their skill in teaching it. Pre-eminently the title *Doctors of the Church* (*doctores ecclesiae*), was given to four of the Greek fathers, viz. Athanasius, Basil, Gregory Nazianzen, and Chrysostom; and to three of the Latin, viz. Jerome, Augustine, and Gregory the Great. To a few great men among the scholastics it was given with an additional epithet to designate some special intellectual quality in gift; thus, in the 12th and 13th centuries, the following doctors of the Church were thus honored: Thomas Aquinas, Angelicus; Johannes Bonaventura, Seraphicus; Johannes Duns Scotus, Subtilis; Raimundus Lullus, Illuminatus; Alanus de Insulis (de l'Isle), Universalis; Durandus de S. Pourcain, Resolutissimus; Gregorius de Rimini, Authenticus; Johannes Taulerus, Illuminatus; Johannes Gersonus, Christianissimus; Alexander Hales, Irrefragabilis; Roger Bacon, Admirabilis; William Occam, Singularis.

3. The academical degree of doctor seems to have arisen in the 12th century [see **DEGREE**], when Irnerius of Bologna has the credit of originating the ceremonial of investiture for the doctorate of laws. The University of Paris almost immediately followed in the footsteps of Bologna, the first reception of doctors having taken place in the year 1145, in favor of Peter Lombard and Gilbert de la Porrée, the greatest theologians of the day. Subsequently to this period the emperors were accustomed to confer upon the universities the right of appointing doctors of laws by their authority and in their name. The example of the emperors was speedily followed by the popes, who conferred corresponding rights with reference to the canon law. From the 11th to the 13th century there seems reason to believe that, both in Italy and France, the terms master and doctor were pretty nearly synonymous. According to Spelman, the degree of doctor was not given in England until the time of king John, A.D. 1207.

4. In modern times, the title Doctor of Theology is conferred by universities and colleges, and also by the Pope. In France it is bestowed, after suitable examination, on any ecclesiastic who has taken the degree of doctor in a faculty of theology and in some univer-

In the faculty of theology in Paris, the time of

necessary studies is seven years: two of philosophy after which they commonly receive the cap of master of arts; three of theology, which lead to the degree of bachelor in theology; and two of licentiate, *dux*, which the bachelors are continually exercised in theses and arguments upon the sacred Scriptures, the scholastic theology, and ecclesiastical history. After further examinations, the doctorate in full is conferred. In Germany, Great Britain, and the United States, the degree is now generally conferred as an honorary one (*honoris causa*), without examination upon men having distinguished themselves as teachers of Christianity by writing or speech. In the universities of Oxford and Cambridge (England) the academical degree of doctor is still, however, given upon examination (formal, if not real) to masters of arts of eleven years' standing; in Cambridge, to masters of twelve years' standing, or to bachelors in divinity of five.

Doctors Commons, formerly the college of the doctors of civil law in London, wherein the Court of Admiralty and the principal ecclesiastical courts were held. It was founded by Dr. Henry Harvey, dean of the Arches, previous to which time the doctor had lived in Paternoster Row. The original building was burned in the great fire in 1666, when the doctors removed for a time to Exeter House. After some time the Commons was rebuilt, and the doctors returned to their former quarters. The courts which have been wont to hold their sittings at Doctors Commons are the Court of Arches, the Archdeacon's Court, the Prerogative Court, the Faculty Court, the Court of Delegates, and the Court of Admiralty. The Prerogative Court is now amalgamated in the Probate Court (q. v.) and the Court of Delegates (q. v.) is transferred to the judicial committee of the privy council. At the time when these courts were all in full operation, their times of session were regulated by terms, as in the courts of equity and common law, a certain day in the week being assigned to each court for hearing its causes. The Court of Arches, the Archdeacon's Court, the Faculty Court, and the Court of Admiralty, are now the only courts which continue to exercise their functions in this once famous spot. The Court of Arches (so called from having sat in *Arcebus*, or under the arches or bows of Bow Church, Cheapside) is the court of appeal belonging to the archbishop of Canterbury. The judge in this court is styled Dean of the Arches, and he has jurisdiction, as the archbishop's principal official, in all ecclesiastical causes within the province of Canterbury.—Chambers, *Encyclopædia*, s. v.

Doctrinal Theology. See **DOGMATIC THEOLOGY**; **THEOLOGY**.

Doctrine. See **DOGMA**.

Doctrine, Christian, MONASTIC CONGREGATIONS OR (*Doctrinaires, Doctrinarians*). 1. *Priests of the Christian Doctrine*, a congregation of secular priests, the chief object of which was to instruct the poor and the ignorant. Their founder, Caesar de Bus, was born February 8, 1544, at Cavaillon, in France. He took orders for the purpose of obtaining a rich benefice, and for some time led a dissolute life in Paris; but on his return to the quiet Cavaillon he changed his mode of life, and devoted himself with great zeal to the care of the poor and the sick. In order to extend his philanthropic activity, he united with several other priests of Cavaillon, and now added to his former labors that of catechising poor people and the children. In 1598 the association obtained a special authorization from the Pope. When the number of members had increased to twelve, they elected Caesar de Bus their superior. The new superior wished to consolidate the association by introducing the simple vest. This induced a number of members to quit; but in 1597 pope Clement VIII sanctioned the association as a society of secular priests. The founder soon after



Priest of the Christian Doctrine.

ame blind, but continued to preach and work for the extension of his society until his death in 1607. The successor of De Bus, Vigier, caused new trouble for him in the society by an attempt to convert the society to a regular "monastic congregation" (q. v.) by the reduction of solemn vows. This led pope Paul V to subject the society to the general of the Somaaskians. As a measure, however, increased the disturbance, and pope Innocent X on that account repealed the union, and subjected the priests of the Christian Doctrine to diocesan bishops. These were henceforth again a society of secular priests, who only took simple vows. At the outbreak of the French Revolution, the society had in France 3 provinces, 15 houses, and 26 colleges. The society was abolished by the French Revolution; its last superior, M. de Bonnefour, died in 1806.

2. *A Congregation of Sisters of the Christian Doctrine* is likewise founded by Cæsar de Bus. They were more commonly called Ursulines of Toulouse.

3. *A Congregation of Doctrinarians* was founded in Italy about the middle of the 16th century by Marco Sadis Cusani. The object of this society was likewise to give instruction. Benedict XIII and Benedict IV gave to this society the direction of several elementary schools in the city of Rome. The society did not extend much beyond Rome, where they still give elementary instruction in a few schools.

Doctrines, History of (Germ. *Dogmengeschichte*), a special branch of Historical Theology.

1. The conception and the definition of History of Christian doctrines depend upon the conception and definition of what constitutes a Christian doctrine (dogma). For evangelical Christians, who believe that nothing should be received as Christian doctrine but what is clearly taught in the Word of God, the history of doctrine is a history of the efforts made by theologians and religious denominations to develop and shape the substance of the Christian faith into doctrinal statements; of deviations from the pure teachings of the Bible; and of the efforts to restore and defend the theology of the Bible. Roman Catholics, who believe in the sole infallibility of their Church, and deny that he has ever added anything to the teachings of Jesus, define history of doctrine as a scientific statement of the manner in which the several doctrines of the Church have been discussed, developed, and, at last, authoritatively defined. To the Rationalist, who does not believe in the immutability of the word of the Bible, the history of doctrines is nothing but a history of the doctrinal controversies in the Christian denominations. From the stand-point of evangelical theologians, the history of doctrines has an apologetic character with regard to Bible theology; the Roman Catholic theologians make it an apology of all the doctrines defined by the

Church; while in the treatment by a Rationalistic author it will lose the character of a branch of Christian theology, and appear as simply historical. But, though conception and definition, and, consequently, mode of treatment and division of matter vary, all works on the history of doctrines embrace a history of the controversies which have been carried on in the Christian Church on doctrinal questions.

2. As regards the relation of the History of Doctrines to other branches of theological science, it is evidently a subdivision of Church history, separately treated on account of its special importance for theologians, and on account of its wide ramifications. It presupposes Biblical theology as its basis (or as its first period). As it recounts the formation and contents of public confessions of faith, and the distinguishing principles set forth in them, it forms itself the basis of symbolics, or comparative dogmatic theology, which stands to it in the same relation as Church statistics of any particular period stand to the advancing history of the Church. As the opinions of the prominent, especially the earliest, fathers of the Church are of considerable importance in the history of any Christian doctrine, it has frequently occasion to refer to the results of Patristics (q. v.). Of the "history of Heresies," the beginning will always have to be noticed in a comprehensive history of doctrine; its further progress only in so far as the heresies remain of importance for the Christian world at large. To a "general history of religion" it may have occasionally to refer; and with the history of philosophy and the history of Christian ethics it may sometimes have to travel over the same ground, though in the latter case it will treat the same subjects from a different point of view. Archæology, and the sciences auxiliary to Church history, such as universal history, ecclesiastical philology, ecclesiastical chronology, diplomatics, etc., also aid in furnishing materials.

3. The value of the History of Doctrines, in a scientific point of view, is evident. Though the history of no doctrine can have a decisive influence in determining the faith of an evangelical theologian, who to this end searches the Bible exclusively, it is for him the most important portion of the history of the Christian Church, leads him into a more minute contemplation, and frequently into a deeper insight of Biblical doctrines, and furnishes him with powerful weapons, both apologetic and polemic, against the various forms of error.

4. The periods of the history of doctrines have been differently determined by the writers on the subject. *Hagenbach* assumes the following five periods: 1. The Age of Apologetics, from the close of the apostolic age to the death of Origen (A.D. 80-254). 2. The Age of Polemics, from the death of Origen to John Damascenus (254-730). 3. The Age of Systems, from John Damascenus to the Reformation (Scholasticism in its widest sense) (730-1517). 4. The Age of Polemico-ecclesiastical Symbolism (the conflict of confessions), from the Reformation to the rise of the Philosophy of Leibnitz and Wolf in Germany (1517-1720). 5. The Age of Criticism, of Speculation, and of the antagonism between Faith and Knowledge, Philosophy and Christianity, Reason and Revelation, including the attempts to reconcile them, from the year 1720 to the present day. *Neander's* division is: 1. To Gregory the Great. 2. To the Reformation. 3. From the Reformation to the present time. *Müncher, Engelhardt, and Meier* adopt the division into Ancient, Mediæval, and Modern times. *Klee* (Rom. Cath.) coincides almost with *Hagenbach*. *Baumgarten-Crusius* (Rationalist) adopts in his Compendium six periods: 1. To the Council of Nice; Formation of the System of Doctrines by reflection and opinion. 2. To the Council of Chalcedon; Formation by the Church. 3. To Gregory VII; Confirmation of the System by the Hierarchy. 4. To the end of the 15th century; Confirmation by the Philosophy of the Church. 5. To the beginning of the 18th

century; Purification by Parties. 6. To the present time; Purification by Science. *Kliefoth* (High-Church Lutheran) divides as follows:

1. Age of Formation of Doctrines.	Greek.	Analytic.	Theology.
2. Age of Symbolical Unity.	Rom. Cath.	Synthetic.	Anthropology.
3. Age of Completion.	Protestant.	Systematic.	Soteriology.
4. " Dissolution.	?	?	Church.

Rosenkranz (in his *Encyclop.* 2d edit. p. 259) makes, according to the philosophico-dialectic categories, the following division: 1. Period of Analytic Knowledge, of substantial feeling (Greek Church). 2. Period of Synthetic Knowledge, of pure objectivity (Rom. Cath. Church). 3. Period of Systematic Knowledge, which combines the analysis and synthesis in their unity, and manifests itself in the stages of symbolical orthodoxy, of subjective belief and unbelief, and in the idea of speculative theology (Protestant Church).

5. The ideal of a history of doctrines is given as follows by Dr. H. B. Smith (*Bibliotheca Sacra*, iv, 560 sq.): "It should be the object of a history of doctrines to give in the truest possible manner the order in which divine truth has been unfolded in the history of the Church. It must trace down the whole course of doctrinal discussion, give the leading characteristics of each epoch, as distinguished from all others, and at last show just where the world now stands in the discussion of the problems which Christianity has presented to it. It should be a faithful mirror to the whole doctrinal history of the Church. It must interpret each writer according to the sense of the age in which he lived, and not bring in subsequent views and modern notions to explain the meaning which an ancient writer gave to a phrase or dogma. It must show what are the points of difference in the reiterated controversies about the same doctrine. It must carefully distinguish the theological and systematic spirit of the different ages of the Church, and not force a subsequent development upon an antecedent *æra*. It must bring out into clear relief the influential personages of each age, and, in exhibiting their systems, distinguish between the peculiar notions of the individual and the general spirit of his times. It must show how controversies about one series of doctrines have modified the views held respecting other doctrines; how each doctrine has acquired a new aspect, according to its position in the mind or system of an author, or in its relation to the leading controversies of the age. It must show when a dogma was held strictly and when loosely; when disconnected from a system and when embraced in a system. It must carefully guard against the error of supposing that when a doctrine was not carefully discussed by the inquisitive and discriminating intellect, it was not really cherished as a matter of faith. This is an error into which many have fallen. But we might as well suppose that men did not believe they had understanding until they discussed the operations of this faculty, or did not trust to their senses until they invented a theory of sensation. Such a history must show the influence which councils, confessions, and systems have had upon their respective *æras*; how preceding times led to such expositions of the faith, and subsequent times were affected by them. It must exhibit clearly the ruling ideas, the shaping notions in each system, and how each predominant idea has modified the component parts of the whole system. It will not neglect to notice the influence which national habits and modes of thought, which great civil and political changes, which the different philosophical schools have had upon the formation of dogmas; nor, on the other hand, will it fail to notice how the Christian faith has itself acted upon and influenced these in its turn, if indeed the latter be not the point of view which should have the precedence. Such a history must finally present before our eyes a picture of a real historical process just

as it has been going on, and the more faithfully and all the leading facts of the case, the more philosophical and complete will it be as a history. By such a exhibition, the whole doctrinal progress of the Christian Church being set before our eyes, we shall in comparing its results with our own systems, be able to see wherein we are defective, one-sided, and *perverse*, wherein our systems need to be reformed, filled up, chastened; how they may be animated by a new spirit and gather better nurture; and by comparing its results with the Scripture, we shall be able to see the parts of its sacred truths have been least known, what problems yet remain to be solved, what is still to be done in order that our divine system of fact be wholly reproduced in the life of the Church; and that all its truths and doctrines stand out as distinct and majestically in the history of the race as they do in that revelation which was given to control and to terminate this history."

6. The history of doctrines has been treated as a independent branch of theological science only in modern times, yet some of the earlier writers of Church history, as well as the theologians, prepared the way for it. Thus the works of Irenæus, Hippolytus, Origen, and Tertullian against the heretics furnish a valuable material. Much, too, is found scattered in the apologetical and polemical literature of the early and mediæval periods of the Church. A more direct preparation for a history of doctrines is found in the works of the Roman Catholic theologians Peter (Opus de Theologia Dogmatica, 1644-50), Thomas (*Dogmata Theologica*, 1684-89), and Duns Scotus (*Summa et Disciplina Ecclesie*, 1730), and of the Protestant theologian Forbesius a Corse (*Institutiones Theologico-theologicae de Doctrina Christiana*, 1708), who endeavored to prove, especially in opposition to cardinal Bellarmine, the agreement between the doctrines of the Reformers and the opinions of the earlier fathers. A direct transition to the treatment of the history of doctrines as a separate science may be found in the treatise by Semler to the *Evangelische Glaubenslehre* of J. Baumgarten (Halle, 1759-60). The literature of special compendiums and manuals of the history of doctrines begins at the close of the last century, and has more recently become quite copious. The large majority of these works belong to German literature, only a few original works having arisen by virtue of other countries. The most important works of the subject are the following: S. G. Lange, *dogmatische Geschichte der Dogmen* (Leipzig, 1796, incomplete); J. Ch. Wundemann, *Geschichte der christlichen Glaubenslehren*, etc. (from Athanasius to Gregory the Great, 2 vols. Leipz. 1798-99); W. Müntzer, *Handbuch der christl. Dogmengeschichte* (4 vols. Marburg 1797-1809; only to the year 604; the first treatise in the pragmatic method), and *Lehrbuch der christl. Dogmengeschichte* (Marburg, 1812; 3d edit. revised and continued by D. von Collin, Hupfeld, and Neudecker, Cassel, 1832-1833, 3 vols. 8vo; Eng. transl. Compendium) by Murdock, New Haven, 1830, 12mo); F. Meuser (Danish bishop), *Handb. of earlier Hist. of Christ. Doctr.* (1801 sq.; Germ. transl. by Evers, Gött. 1802, 2 vols. incomplete); J. Ch. W. Augusti, *Lehrb. der christl. Dogmengesch.* (edited by J. G. V. Engelhardt, Erlang. 1822-23, 2 vols.); F. G. Ruperti, *Gesch. der Dogmen* (Pfeiffer, 1831); L. F. O. Baumgarten-Crusius, *Lehrbuch der christl. Dogmengesch.* (Leipz. 1832, 2 vols. 8vo) and *Compendium der Dogmengesch.* (ed. by Hase, Leipz. 1844-45, 2 vols.); C. G. H. Lentz, *Geschichte der christl. Dogmen* (Helmst. 1834-35, 2 vols.); J. G. V. Engelhardt, *Lehrbuch der Dogmengesch.* (Neustadt, 1833, 2 vols.); F. C. Meyer, *Lehrbuch der Dogmengesch.* (Giessen, 1840, 2d edit. by G. Baur, 1854); K. R. Hagenbach, *Lehrbuch der Dogmengeschichte* (Leipz. 1840, 5th edit. 1867; Engl. transl. by C. W. Buch, Edinburgh, 1846, 3d edit. 1858; the English transl. revised, with large additions from the 4th German edit. and other sources, by H. B. Smith, 2nd ed.

ew York, 1861); F. C. Baur, *Lehrb. der christl. Dogmengesch.* (Stuttg. 1849, 3d ed. Tubing. 1867), and *Vorlesungen über die christl. Dogmengesch.* (edit. by his son, F. Baur, 8 vols. Leipz. 1866-1867); Karl Beck, *Lehrb. v. christl. Dogmengesch.* (Weimar, 1848, 2d edit. 1864); arheineke, *Christl. Dogmengesch.* (edited by Matthies id Vatke, being the 4th volume of the complete works r Marheineke, Berlin, 1849); L. Noack, *Die christl. Dogmengesch.* (Erlangen, 1852, 2d edit. 1856); J. C. L. ieseler, *Dogmengeschichte* (ed. by Redepenning, Bonn, 155, 8vo); Neander, *Christl. Dogmengesch.* (ed. by Dr. L. Jacobi, 2 vols. 8vo, Berl. 1857-8; Eng. transl. by yland, in Bohn's library, 2 vols. 12mo, Lond. 1858); . Schmid, *Lehr. der Dogmengesch.* (Nördlingen, 1860, 1 ed. 1868). The only recent works on the subject r Roman Catholic authors are those by Klee, *Lehrbuch r Dogmengeschichte* (Mainz, 1857-38, 2 vols.); and chwane, *Dogmengesch. der patriot. Zeit* (of the period om 825-787, Munster, 2 parts, 1866-67).

No copious or complete history of doctrines has been roduced in England; but the great writers of the nglish Church, in treating special topics, have large- illustrated them from history. "Though compris- ing no continuous and entire history of Christian doc- trine, and even when investigating a particular sub- ject, often doing it incidentally, the labors of Hooker ad Bull, of Pearson and Waterland, are every way orthy to be placed beside those of Baur and Dörner. he learning is as ample and accurate, the logical rasp is as powerful, and the judgment more than qual" (Shedd, Pref. vii). The writer just cited has re honor of having produced one of the first books of is class in English literature (*A History of Christian doctrines*, by William G. T. Shedd, D.D., New York, r Scribner, 3d ed. 1865, 2 vols. 8vo). This work is undid, luminous, and able throughout, though it does ot aim at a full treatment of all topics in Christian eology. "It gives the results of extensive reading, nd the analogies of a patient and devout thinker. olding firmly to the great Puritan theology, Dr. hedd shows a mastery of modern German specula- ion; and while his pages are not burdened with co- ous notes, or enriched with the laboriously collated xtracts with which Hagenbach or Gieseler favor us, he gist of all the controversies is well indicated" (*Brit- ish Quarterly*, April, 1865, p. 326). The only other ork of the class in English literature is *Historical eology, a Review of the principal doctrinal Discussions n the Christian Church since the Apostolic Age*, by Wil- iam Cunningham, D.D., principal of New College, dinburgh (2d ed. 1864, 2 vols. 8vo). This is a post- umous work, edited from Dr. Cunningham's colle- ctures by his literary executors. Of course it has ot the compactness or the finish which it might have ad if prepared for the press by the author himself; ut it is, nevertheless, a very valuable contribution to istorical theology.

The history of creeds and confessions of faith, so far s relates to the doctrinal principles set forth in them, elongs to history of doctrine; but it is now generally eated as a separate branch of historical theology, nder the name of Symbolics. See CONFESSIONS; REEDS; SYMBOLICS.

Tables exhibiting the history of doctrines have been ublished by Hagenbach, *Tabellartige Uebersicht der Dogmengeschichte bis auf die Reformation* (Basel, 1828); Vorländer, *Tabell. übersichtliche Darstellung der Dog- mengesch.* (Hamburg, 1835-1855, 8 parts); Lange, *Tab. ler Kirchl.-u. Dogmengesch.* (Jena, 1881).

In addition to the general works on the history of doctrines, there are a number on special periods (as the eology of the apostolic fathers), and also monographs n special doctrines (as the doctrine of the Person of Christ, the Trinity, etc.), all of which are noticed in he articles devoted to these special subjects. Outlines of the history of the principal doctrines are also more r less given in the general "Church histories," and

in the works on dogmatic theology and symbolics. We refer to the special articles in this Cyclopædia on these branches of scientific theology for the literature.

Do'cus (Δωκ v. r. Δωίης; Vulg. *Doch*; Syr. *Doak*), a "little hold" (rò ὀχυρωματίον; Vulg. *munitionum- lum*), near Jericho (1 Macc. xvi, 15; compare verse 14), built by Ptolemæus, the son of Abubus, and in which he entertained and murdered his father-in-law, Simon Maccabæus, with his two sons. By Josephus (*Ant.* xiii, 8, 1; *War*, i, 2, 8) it is called *Dagon* (Δαγών), and is said to have been "one of the fortresses (ἰσχυρά- τωv) above Jericho." The word is probably the Ara- mæan *Dakka*, a *watch-tower* (Grimm, *Exec. Handb.* in loc.). The name still remains in the neighborhood, attached to the copious and excellent springs of *Ain-Dük*, which burst forth in the Wady Nawá'imeh, at the foot of the mountain of Quarantania (Kuruntul), about four miles N.W. of Jericho (Robinson, *Res. ii*, 309). Above the springs are traces of ancient founda- tions, which may be those of Ptolemy's castle, but more probably of that of the Templars, one of whose stations this was (see Münter, *Statuenb. der Ord. des Tempel.* i, 419). It stood as late as the latter end of the 18th century, when it was visited by Brocardus, who calls it *Dooch* (*Descr. Terræ Sanctæ*, ch. vii, p. 178, ed. Bonfrère in *Onomast.*).—Smith, s. v.

Dod, Albert Baldwin, D.D., an eminent Pres- byterian minister and mathematician, was born in Mendham, N. J., March 24, 1805, and graduated A.B. at Princeton in 1822. In 1826 he became tutor, was licensed to preach in 1829, and in 1830 was appointed professor of mathematics in Princeton College. He filled the office with signal ability and success for fif- teen years, and died, after a short illness, Nov. 20, 1845. To a remarkable aptitude for mathematics he added an acute metaphysical turn and a taste for gen- eral literature, so that his mental culture was broad and catholic. He wrote several articles of great val- ue in the *Princeton Review*, and among them one on *Transcendentalism* (vols. xi, xii), which was afterwards reprinted as a separate pamphlet on account of its masterly treatment of the subject.—Sprague, *Annals*, iv, 787.

Dod, John, an eminent Puritan divine, was born at Shotledge, Cheshire, England, in 1647, and was educated at Jesus College, Cambridge, where he be- came fellow, and resided for sixteen years. At col- lege he acquired great reputation both as a disputant and a preacher. His first settlement was at Han- well, Oxfordshire, in 1681, where he remained twenty years, and was very popular and useful. He was sus- pended for nonconformity by Dr. Bridges, bishop of Oxford, and went to Cannons' Ashby, in Northamp- tonshire, where he was again silenced on a complaint to king James by bishop Neale. After the death of king James he gained liberty to resume his public la- bors, which he did with unremitting faithfulness and success till his death, which took place at Fawesley, Northamptonshire, a living to which he was presented in 1624. Mr. Dod was an excellent scholar, especially in Hebrew. He published *An Exposition of the Prov- erbs* (London, 1608, 4to);—*Sermons on Lamentations iii* (London, 1608, 4to);—*A Remedy against Contentions* (Lond. 1609, 4to); and, together with Robert Cleaver, *An Exposition of the Ten Commandments, with a Cate- chism* (Lond. 1632, 4to).

Do'dai' (Heb. *Doday'*, דודאי, prob. another form for *Dodo*; Sept. Δωδία v. r. Δωδία and Δωδαία, Vulg. *Dudia*), an Ahoite, the chief officer of the contingent for the second month under David (1 Chron. xxvii, 4); probably the same as *DODO* (q. v.), whose son Eleazar was one of David's three chief braves (2 Sam. xxiii, 9; 1 Chron. xi, 12). By some the words אֱלִיָּזָר בֶּן דָּוִד, "Eleazar the son of," are supposed to have acci- dentally escaped in transcription from the text in 1

Chron. xxvii, 4, making this person the father of the military character there spoken of.

Do'danim (Heb. *Dodanim*'), דודנין, deriv. unknown; Sept. *Ῥόδοι*, Vulg. *Dodanim*), a family or race descended from (the fourth son of) Javan, the son of Japheth (Gen. x, 4). The authorities vary as to the form of the name: the Hebrew text has Dodanim in Genesis, but **RODANIM** (דודנין) in the text of the parallel passage (1 Chron. i, 7, margin דודנין, Sept. again *Ῥόδοι* [v. r. *Δωδανίμ*], and Vulg. *Dodanim*, A. V. "Dodanim"); Dodanim appears in the Syriac, Chaldee, Vulgate, Persian, and Arabic versions, and in the Targum of Onkelos; Rodanim is supported by the Sept., the Samaritan version, and some early writers, as Eusebius and Cosmas. The weight of authority is in favor of Dodanim; the substitution of *Ῥόδοι*, *Rhodians*, in the Sept. may have arisen from familiarity with that name (compare Ezek. xxvii, 15, where it is again substituted for Dedan). Dodanim is regarded as identical with *Dardani* (Gesenius, *Thesaur.* p. 1266), the latter, which is the original form, having been modified by the change of the liquid r into o, as in Barmilcar and Bomilcar, Hamilcar and Hamilco (*Hall. Lit. Zeit.* 1841, No. 4). Thus the Targum of Jonathan, that on Chronicles, and the Jerusalem Talmud, give *Dardania* for Dodanim. The Dardani were found in historical times in Illyricum and Troy: the former district was regarded as their original seat. They were probably a semi-Pelasgic race, and are grouped with the Chittim in the genealogical table, as more closely related to them than to the other branches of the Pelasgic race (Knobel, *Völkertafel*, p. 104 sq.). The similarity of the name *Dodona* in Epirus (Strabo, vii, 827 sq.) has led to the identification of Dodanim with that place (Michaelis, *Spicileg.* i, 120); but a mere local designation appears too restricted for the general tenor of Gen. x. See **ETHNOLOGY**. Kalisch (*Comm. on Gen.*) identifies Dodanim with the *Dauni*, who occupied the coast of Apulia: he regards the name as referring to Italy generally. The wide and unexplained difference of the names, and the comparative unimportance of the Dauniens, form objections to this view. Those who prefer the reading Rodanim refer it to the Greek inhabitants along the river Rhone (Bochart, *Phaleg*, iii, 6), from the original *Rhodus* (Tuch, *Gen.* p. 216).—Smith, s. v.

Do'davah (Heb. only in the prolonged form *Dodava hu*, דודוהו v. r. דודוהי, beloved of Jehovah; Sept. *Δωδία* v. r. *Ῥόδια*, Vulg. *Dodan*), an inhabitant of Mareslah, and father of the Eliezer who predicted the wreck of Jehoshaphat's fleet auxiliary to Ahaziah (2 Chron. xx, 87). B.C. ante 895. In the Jewish traditions Dodavah is the putative son of Jehoshaphat, who was (in reality) his uncle (Jerome, *Qu. Heb. ad loc.*).

Dodd, Charles, an English Romanist divine, whose real name is said to have been Richard Tootle. He resided at Harvington, Worcestershire, where he died about 1745. He published a *Church History of England from 1500 to 1688, chiefly with regard to Catholics* (Brussels, 1737, eight parts, in 3 vols. fol.). It was printed in England, though dated at Brussels. It was sharply criticised by Constable, a Jesuit, in 1740, and Dodd replied as sharply (1742). Berington, in his *Memoirs of Gregorio Panzani*, speaks of Dodd as the author of other works "against the invidious conduct, as he deemed it, of the Jesuits, in their transactions with the secular clergy." His *Church History* was for a long time very scarce and dear, but a new edition was undertaken in 1839 by the Rev. M. A. Tierney, of which 5 vols. 8vo have appeared (1839-1843).

Dodd, William, LL.D., an unworthy clergyman of the Church of England, was born in 1729, at Bourn, Lincolnshire, and was admitted a sizar of Clare Hall, Cambridge, in 1745. In 1753 he was ordained, and settled in London; and from this time he continued to

obtain a succession of small preferments in the Church, holding, in the latter part of his life, two chapels in London, with a rectory and vicarage in the country, and possessing an ecclesiastical income of £800 a year. He was one of the most popular preachers of his day; was one of the king's chaplains; and in 1763 was intrusted with the education of Philip Stanhope, afterwards earl of Chesterfield. In 1775 he was deprived of his king's chaplaincy for having offered to the vicar of chancellor Apsley a bribe of £3000 if she would cure him the living of St. George's, Hanover Square. He preached his last sermon Feb. 2, 1777; two days after he forged a bond for £4200 on Lord Chesterfield, was arrested, tried, and convicted Feb. 24, and executed June 27. Strenuous efforts were made by one of the highest rank to save him, but without effect. He was a man of superficial learning, but of great literary industry. Besides minor pieces in prose and verse, he published *An Elegy on the Death of the Prince of Wales* (1751, 4to).—*Thoughts on the glorious Epiphany of our Lord Jesus Christ*, a poetical essay (Ld. 4to).—*Sermons on the Parables and Miracles* (1752, 4 vols. 8vo).—*Account of the Rise, Progress, &c. of the Magdalen Charity* (1759, 8vo).—*A familiar Explication of the poetical Works of Milton* (1762, 12mo).—*Reflections on Death* (1763, 12mo).—*Comfort for the Afflicted* (1764, 8vo).—*The Visitor* (1764, 2 vols. 12mo).—A new edition of *Locke's Compendious-book to the Bible* (1766, 4to).—*Sermons on the Duties of the Great*, transl. from Massillon (1769, 8vo).—*A Commentary on the Bible*, 8 vols. fol. (published in numbers, commenced in 1766, and completed in 1770. "In order to give greater éclat to this undertaking, it was announced that lord Masham had presented him with the MSS. of Mr. Locke, and that he had help also from the MSS. of lord Clarendon, Dr. Waterland, and other celebrated men. The ability and sound judgment with which, in the compilation of this work, Dodd availed himself of the labors of preceding commentators, foreign as well as British, have rendered this a very valuable work." It was made the basis of Dr. Coke's *Commentary*, without adequate acknowledgments).—*Sermons to young Men* (1771, 8 vols. 12mo).—*The Frequency of capital Punishments inconsistent with Justice and Policy, and Religion* (1772, 8vo).—*Thoughts in Prison, &c., with Memoirs of his Life* (posthumous). See some interesting notices of Dodd's attack on Wesley, and of Wesley's visits to him, in Wesley's *Works*, N. Y. ed., iv, 245, 466; vi, 537.

Doddridge, PHILIP, D.D., was born in London June 26, 1702. His parents were pious Dissenters, and took pains to educate their children religiously. Philip was introduced by his mother to a knowledge of the characters and scenes of the O. and N. T. history by means of some Dutch tiles that lined a corner of their sitting-room. In his childhood he was taught the rudiments of Greek and Latin, and from his tenth to his thirteenth year he attended the grammar-school at Kington-on-Thames. In 1715 he entered a private school at St. Albans, kept by Mr. Nathaniel Wood, and here he gained the friendship of Samuel Clarke, who aided him in many ways after the death of his father (1715). Doddridge repaid his benefactor by his devotion to study and to personal religion. In 1717 he received an offer from the duchess of Bedford, who lived in the neighborhood, and had heard of his character and circumstances, to send him to either of its two universities on condition of his becoming a clergyman in the Church of England. He declined the proposal. Mr. Clarke now undertook to bear the expense of his education, and Doddridge gladly embraced the offer by entering, in 1719, the academy of Kibworth, in Leicestershire, where he studied under Dr. Jennings. In 1722 he was licensed to preach, and was settled over the congregation at Kibworth as successor to Dr. Jennings. In 1729 he removed to Harborough, to be assistant to the venerable Mr. See.

the same year, Dr. Doddridge, in conjunction with Mr. Watts, Rev. Mr. Saunders, Rev. Mr. Some, and others, established an academy for preparing young men for the work of the ministry among Dissenters; and to that institution he was appointed tutor. No man was better qualified than Dr. Doddridge for that situation, and the institution soon acquired a wide celebrity. A pressing invitation from the Independent congregation in Northampton, enforced by the advice of Dr. Watts and other friends to accept it, led him to a new sphere of labor; and from December 24, 1729, he discharged in that town the double duty of pastor of a large congregation and tutor to the theological seminary. "Seldom has there been a more laborious and conscientious life than that of Doddridge. To serve his divine Master was the ruling principle of his heart; and to the advancement of the sacred cause he brought all the energies of an active mind, and all the stores of an almost boundless knowledge, daily to bear. Many students resorted to him from all parts of the kingdom, and amongst these not a few who afterwards rose to distinction, not among the Dissenters only, but in the established churches of England and Scotland, in America, and even in Holland. The University of Aberdeen conferred on him, in 1786, the degree of D.D. He was a voluminous author. His most important works are *Sermons on Regeneration*; *Sermons to Young People*; *Life of Colonel Gardner*; *Rise and Progress of Religion in the Soul*; *Family Expositor*, or *Paraphrase and Version of the N. T.* Dr. Doddridge's frame, never robust at any time, was enfeebled by his incessant labors, and severe cold having settled on his lungs, and been followed by symptoms of consumption, he was advised to try the effects of a sea voyage. On the 30th of September, 1751, he sailed from Falmouth in a vessel bound for Lisbon, where he landed on the 18th of October, and, being completely exhausted, he sank in a few days, expressing to Mrs. Doddridge, who accompanied him, his firm faith and joyful hope in Christ" (Rich, *Cyclopædia of Biography*, s. v.). The best edition of Doddridge's works is that of Leeds, 1802, 10 vols. 8vo, the first vol. containing his *Life* by Job Orton. His *Lectures on Pneumatology, Ethics, and Divinity* are stereotyped in one vol. imp. 8vo (Lond., Bohn). The *Family Expositor* has passed through many editions; a convenient one is that of Amherst (1844, royal 8vo), with memoir by Prof. N. W. Fiske.

As commentator and theologian Dr. Doddridge deserves the praise of industry and purity of aim, but in no field, except in that of practical religion, did he rise to the first rank. In the Commentary "Doddridge always writes in a good spirit. The love of Christ reigns in his heart, and pours itself out in all that he says. This is the charm of his 'Observations.' His 'Notes,' though often valuable, could not be expected to possess the highest philological merit. Dr. Doddridge had not the time, the training, nor the means to furnish a thorough critical commentary on the N. T. The paraphrase is diffuse, often needlessly so; circuitous in expression, when the straightforward simplicity and terseness of the original would be far better. It is proof enough of the comparative and absolute worth of the Observations that they are more and more read, at family devotion and in private reading, to the exclusion of other parts, and in preference to other commentators. Good sense, warm piety, flowing ease of expression, and a happy exhibition and improvement of his text, mark the Observations, and recommend them to the Christian reader" (*Comprehensive Commentary*, Phila., Supplement). As a divine, "with all his manifold excellencies, Doddridge had neither a deep theological interest nor a strenuous theological mind. He did not always conceive of nice distinctions clearly; he did not value them highly when conceived. Hence he flees to authorities, recites catalogues, and balances opinions, and continually slides from the scientific to the historical. From

one end of the lectures to the other we look in vain for a thorough, masterly, and exhaustive treatment of any one theological point. The method of the work scarcely allows such a result. Continual perusal, if, indeed, such a thing were endurable, would, we think, engender vacillation and scepticism. Such seems to have been the effect upon his students, who heard him announce every variety of opinion, without decided and weighty assertion on his own part. Great liberality and mildness are beautiful in their time; but this is not when the enemy is assailing the citadel, which was true of Nonconformist theology a hundred years ago. . . . His *sermons* are remarkable for soundness in doctrine, for rigid method and clear statement, and for earnest application to the heart and conscience of the hearer. . . . His *hymns* are, in number, three hundred and seventy-four. A few of these are likely to be preserved, such, for example, as 'Let Zion's Watchmen all Awake;' 'God of my Life, through all its Days;' 'Ye Hearts with youthful Vigor warm;' 'See Israel's gentle Shepherd stand;' 'What if Death my Sleep invade?' and 'Remark, my Soul, the narrow Bound;' but, in general, they are measured prose" (*Princeton Review*, 1857, p. 257). See also Bogue and Bennett, *History of Dissenters*, vol. ii; Orton, *Life of Doddridge*; Stoughton, *Life of Doddridge* (Boston, 1853, 12mo); Kippis, *Biographia Britannica*, vol. v; *North British Review*, xiv, 190.

Do'do (Heb. *Dodo*, דודו, *amatory*; but, according to Flurst, an abbreviation of *Dodavah*), the name of three men.

1. (Sept. *παράδελφος αὐτοῦ* v. r. *πατήρ ἀδελφοῦ αὐτοῦ*; Vulg. *patruus Ahimelech*, both apparently as a rendering of "Ahoite" inserted.) A descendant of Issachar, father of Phuah, and grandfather of the judge Tola (Judg. x, 1). B. C. considerably ante 1319.

2. (Sept. *Δουδι, Δωδαί*; Vulg. *patruus ejus*.) An Ahoite (q. v.), father of Eleazar, who was one of David's three special heroes (2 Sam. xxiii, 9, margin; 1 Chron. xi, 12). B. C. ante 1046. He seems to be the same with the *DODAI* mentioned in 1 Chron. xxvii, 4, as commander of the fourth monthly division of the royal troops under David. This latter form of the name occurs in the Hebrew text of 2 Sam. xxiii, 9 (דודי), and is favored by the Sept. as well as by Josephus (*Ant.* vii, 12, 4, *Δωδιαιος*); and is believed by Kennicott (*Dissertation*, p. 184), who has examined these lists with great minuteness, to be the correct one. The Jewish tradition (*Jerome, Qu. Hebr.* on 1 Chron. xi, 12) was that Dodo was the brother of Jesse.

3. (Sept. *Δουδι παράδελφος αὐτοῦ*, and *Δωδαί* v. r. *Δωδαί*; Vulg. *patruus ejus*.) A Bethlehemite, and father of the Elhanan who was one of David's thirty heroes (2 Sam. xxiii, 24; 1 Chron. xi, 26). B. C. ante 1046.

Dodwell, HENRY, an eminent nonjuror, critic, and theologian, was born at Dublin in 1641, and was educated at the York Free School and at Trinity College, where he obtained a fellowship, which he relinquished in 1666. He was chosen Camden professor at Oxford in 1688; but, being a nonjuror, he lost his office at the Revolution. Dodwell was a learned and a virtuous man, but addicted to paradoxes, and was so much an ascetic that during three days in the week he refrained almost wholly from food. He was a man of great obstinacy, unwearied industry, and prodigious learning. But his intellect was neither vigorous nor comprehensive. "Many of his publications were on the popish and nonconformist controversies: they have the reputation of showing, like everything else he wrote, extensive and minute learning, and great skill in the application of his scholarship, but little judgment of a larger kind. Few, if any, of the champions of the Church of England have strained the pretensions of that establishment so far as Dodwell seems to have

done; but his whole life attested the perfect conscientiousness and disregard of personal consequences under which he wrote and acted" (*English Cyclopædia*, s. v.). On leaving Oxford he retired to Cookham, Berkshire, and soon after to Shottesbrooke, where he spent the rest of his days. He possessed an estate in Ireland, but allowed a relation to enjoy the principal part of the rent, only reserving a moderate maintenance for himself. His relative at length began to grumble at the subtraction even of this pittance, and on that Dodwell resumed his property, and married. He took this step in his fifty-second year, and lived to see himself the father of ten children. The works for which he is now chiefly remembered were also all produced in the latter part of his life. Among these are his *Dissertationes Cypriacæ* (n. d. fol.):—*Dissert. in Irenæum* (Oxon. 1689):—*Scripture Account of Rewards and Punishments* (Lond. 1708, 8vo):—*Dissertations and Annotations on the Greek Geographers*, published in Hudon's *Geographia Veteris Scriptores Græci Minores* (Oxon. 1698, 1708, and 1712):—*Annales Thucydidei et Xenophontei* (1696):—*Chronol. Græco-Romano* (1692); and *Annales Velleiani, Quintilian, Statiani* (1698). These several chronological essays, which are drawn up with great ability, have all been repeatedly reprinted. Dodwell's principal work is considered to be his *De Veteribus Græcorum Romanorumque Cyclis, Obiterque de Cyclo Judæorum ac Ætate Christi Dissertationes* (Oxon. 1701, 4to). He also published in 8vo, in 1706, *An epistolary Discourse, proving from the Scriptures and the first Fathers that the Soul is a Principle naturally mortal, but immortalized actually by the pleasure of God, to punishment or to reward, by its union with the divine baptismal spirit; where it is proved that none have the power of giving this divine immortalizing spirit since the apostles, but only the bishops.* "This attempt to make out for the bishops the new power of conferring immortality raised no small outcry against the writer, and staggered many even of those who had not seen any extravagance in his former polemical lucubrations. Of course it gave great offense to the Dissenters, all of whose souls it unceremoniously shut out from a future existence on any terms. Dodwell died at Shottesbrooke June 7, 1711" (*English Cyclopædia*). See *Dodwell's Works abridged, with his Life*, by Brokesby (Lond. 1723, 2 vols. 8vo, 2d ed.); Kippis, *Biographia Britannica*, v. 320 sq.; Allibone, *Dictionary of Authors*, i, 511; Orme, *Life of Baxter*, vol. ii, ch. viii.

Doederlein, JOHANN CHRISTOPH, a celebrated Lutheran theologian, was born at Windheim, in Franconia, Jan. 20, 1745, and studied at the University of Altdorf, where he was appointed professor of theology in 1772. In 1782 he became professor of theology at Jena, where he died Dec. 2, 1792. His erudition was solid and various. His most important works are, *Esaias ex recensione text. hebr., cum notis* (1789, 8vo):—*Sprüche Salomons neu übers. etc.* (1778, 8vo):—*Institutio theologica christiana* (Altdorf, 1791, 8vo, 6th ed.). His miscellaneous writings and sermons are very numerous, and he edited the *Theologische Bibliothek* from 1780 to 1792. His *Institutio Theologica* was a very successful book. In theology, Doederlein stood at the point of transition from the old German orthodoxy to modern Rationalism.—*Saintes, History of Rationalism*, bk. ii, ch. iv.

Do'ëg (Heb. *Doëg'*, דֹּעַגַּי, *fearful*, 1 Sam. xxi, 7, Sept. Δωίγ v. r. Δωίς; or דֹּעַגַּי, Psa. lii, title, Sept. Δωίς; in 1 Sam. xxii, 18, 22, *Doëg'*, דֹּעַגַּי, after the Syrian pronunciation, Sept. Δωίγγ), an Edomite, and chief overseer of king Saul's flocks (Josephus, Δωίγκος, "keeper of the king's mules," Ant. vi, 12, 1), which is an important trust in Oriental courts. B. C. 1062. At Nob he was witness of the assistance which the high-priest Ahimelech seemed to afford to the fugitive David, by furnishing him with the sword of Goliath, and

by supplying him with bread even from the sacred table (1 Sam. xxi, 7). Of this he failed not to inform the king, who, regardless of the explanation offered by Ahimelech, and finding that the chiefs censured him and hesitated to lay their hands upon a person so sacred, commanded Doëg to slay him and his priests: the number of 85 persons), and to destroy all the families and property—a task which was executed with equal readiness and cruelty by the Edomite (1 Sam. xxii, 18 sq.). This truculent act called forth some of David's most severe imprecative prayers (Psa. li, of which divine and human justice seem alike to have required the fulfillment. See DAVID; PSALMS). A question has arisen on the nature of the business in which he was "detained before the Lord" (דֹּעַגַּי בְּפֶנֶס אֲדֹנָי, *ἰσχυρομένος Νεισοπαρῶν*; Vulgate, *istatus in tabernaculo Domini*). The difficulty which lies in the idea of Doëg was a foreigner, and so incapable of a Nazir vow (*Mischk. de Votib.* ix, 1, Surenh.), has been explained by the supposition that he was a proselyte, attending under some vow or some act of purification at the Tabernacle (compare 1 Sam. xx, 18). Theitz (*Kurzg. evng. handb.* in loc.) has corrected Gesenius's interpretation (*Thesaur.* p. 1059) of the phrase as meaning "was assembled before Jehovah." Ephraim Syriac (*Opp.* i, 876) explains the term as merely indicating that Doëg had introduced himself there secretly, whether by right or otherwise. With this agrees Fürst's rendering (*Hebr. Handb.* p. 175), that he had tarried behind (zurückbleiben) as a spy.

Dog (דָּבָר, *ke'leb*, so called from his barking; Arabic *kelb*; Greek *κύων*, whence Eng. *hound*; diminutive *κυνίον*) occurs in numerous passages both of the Old and the New Testament (see Bochart, *Hier.* i, 769 sq.). An animal so well known, whose numerous varieties come under daily observation, requires no detailed description (see the *Penny Cyclopædia*, s. v.). There is, however, in Asia still extant one, perhaps more than one, species, that never have been the companions of man, and there are races of uncertain origin, that may have been formerly domesticated, but which are now feral, and as fierce as wolves; while in accordance with Oriental modes of speech, there are others, exceedingly numerous, neither wild nor domesticated, but existing in all the cities and towns of the Levant, without owners; feeding on carrion and offal, and still having the true instinct of protecting property, guarding the inhabitants of the district or quarter where they are tolerated; and so far detested, that water and some food are not usually placed within their reach (see Jardine's *Naturalist's Library*, ix, x). The true wild species of Upper and



Wild Persian Dog.

Eastern Asia is a low, sharp-nosed, reddish cur-dog, not unlike a fox, but with less tail. In Persia and Turkey there exists a larger dog resembling a wolf, exceedingly savage. Both are gregarious, hunt in packs, but are occasionally seen alone. They are readily distinguished from a wolf by their shorter unfurnished tails. In the time of the sojourning of Israel in Egypt, there were already in existence domestic dogs of the principal races now extant—the cur-dog or fox-dog, the hound, the greyhound, and every kind of low-legged turnspit (Wilkinson, *Ancient Egypt*).

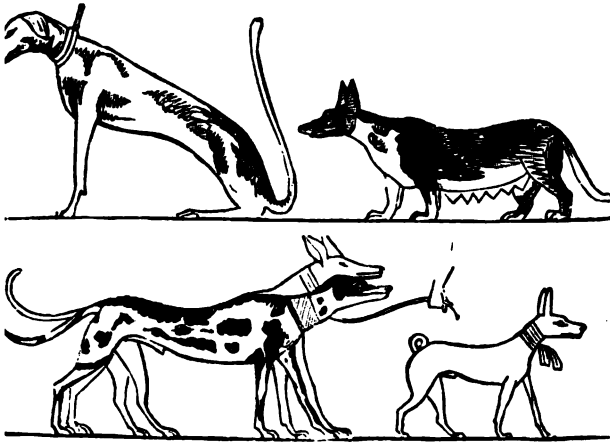

Ancient Egyptian Dogs.

ridgm. i, 230). All the above, both wild and re-aimed, there is every reason to believe, were known to the Hebrews (see Mishna, *Baba Kamma*, vii, 7), and although the Mosaic prohibition is presumed, yet inferior habits, and, in some measure, the necessity of their condition, must have caused cattle-dogs to be retained as property (Deut. xxiii, 18), for we find one of that race, or a house-dog, actually attending on shepherds (Tobit v, 16; xi, 4). It is to be presumed that practically the street-dogs alone were considered absolutely unclean; though all, as is the case among Mohammedans, were excluded from familiarity. (See Lejeune, *Dogs on Old Sculptures*, etc. Lond. 1863.) In Egypt, anterior to the Christian era, domestic dogs were venerated. See NIBHAZ. They continued to be cherished till the Arabian conquest, when they, like the unowned street-dogs, fell under the imprecation of Mohammed, who with reluctance, though with good policy, modified his denunciations and sentence of destruction in favor of hunting-dogs, and even permitted some to be killed by them to be eaten, provided they had not devoured any portion of it (comp. Exod. xxii, 31). The words of the Lord Jesus to the Syrochœnic woman, and her answer (Matt. xv, 26, 27), certainly imply a domestication and domiciliation of dogs; but complete toleration of their presence is all that can be ascribed. They lived on what they could get. Among the Moors of North Africa a similar position of the dog is occasionally seen. They "grant him, indeed, a corner of their tent, but this is all; they never caress him, never throw him anything to eat" (Poirot's *Barry*, i, 253). Besides the cattle-dog, the Egyptian hound, and one or two varieties of greyhound, were most likely used for hunting—a pastime, however, which the Hebrews mostly pursued on foot. On the Assyrian monuments they are depicted in hunting



Ancient Assyrian Hunting-dogs.—From a Slab in the British Museum.

scenes. The street-dog, without master, apparently derived from the rufous-cur, and in Egypt partaking of the mongrel greyhound, often more or less bare,

with a mangy, unctuous skin, frequently with several teeth wanting, was, as it now is, considered a defiling animal. It is to animals of this class, which no doubt followed the camp of Israel, and hung on its skirts, that allusion is more particularly made in Exod. xxi, 31, for the same custom exists at this day, and the race of street-dogs still retains their ancient habits (Prosp. Alpin. *Rer. Egypt.* iv, 8, p. 230 sq.; Russel, *Aleppo*, ii, 55; Rosenmüller, *Morgen*. iv, 76). A portion of the Cairo packs annually become *hajis*, and go and return with the caravan to Mecca, while others come from Damascus, acting in the same manner; and it is known that the pilgrims from the banks of the Indus are similarly attended to Kerbelâ: indeed, every caravan is so, more or less, by these poor animals. But with regard to the dogs that devoured Jezebel, and licked up Ahab's blood (1 Kings xxi, 23), they may have been of the wild races, a species of which is reported to have particularly infested the banks of the Kishon and the district of Jezreel. In illustration of this shocking end of Jezebel, it may be remarked that the more than half-wild street-dogs of the East, living upon their own resources, and without owners, soon make rapid clearance of the flesh of dead bodies left exposed, whether of human creatures or beasts (Bruce, *Trav.* iv, 81). Among other instances, it is recorded that a number of Indian pilgrims were drowned by the sinking of a ferry-boat in which they were crossing a river. Two days afterwards a spectator relates: "On my approaching several of these sad vestiges of mortality, I perceived that the flesh had been completely devoured from the bones by the Pariah dogs, vultures, and other obscene animals. The only portion of the several corpses I noticed that remained entire and untouched were the bottoms of the feet and insides of the hands, a circumstance that may afford a corroborative proof of the rooted antipathy the dog has to prey upon the human hands and feet. Why such should be the case remains a mystery" (Kitto's *Daily Illust.* in loc.). Stanley (*S. and P.* p. 350) states that he saw on the very site of Jezreel the descendants of the dogs that devoured Jezebel, prowling on the mounds without the walls for offal and carrion thrown out to them to consume; and Wood, in his *Journal* to the source of the Oxus, complains that the dog has not yet arrived at his natural position in the social state (compare Strabo, xvii, 821; Burckhardt, *Trav.* ii, 870). The dog was employed, however, in sacrifice by some ancient nations (Pausan. iii, 14, 9; Arnob. iv, 25; Julian, *Orat.* v, p. 176; Pliny, xviii, 69; comp. Saubert, *De sacrific.* c. 23, p. 518 sq.), and was even sometimes eaten (Plutarch, *De sollert. animal.* c. 2; Justin. xix, 1). The cities of the East are still greatly disturbed in the night by the howlings of



Eastern Street or Bazaar Dogs.

street-dogs, who, it seems, were similarly noisy in ancient times, the fact being noticed in Psa. lix, 6, 14; and dumb or silent dogs are not unfrequently seen, such as Isaiah alludes to (lvi, 10). The same passage has reference to the peculiarly fitful sleep of the dog, and his sudden start as if during a dream (see J. G. Michaelis, *Observ. Sacr.* ii, 50 sq.).

The dog was used by the Hebrews as a watch for their houses (Isa. lvi, 10; comp. *Iliad*, xxiii, 178; *Odys.* xvii, 809), and for guarding their flocks (Job xxx, 1; comp. *Iliad*, x, 188; xii, 802; Varro, *R. R.* ii, 9; Colum. vii, 12; see Thomson, *Land and Book*, i, 801). Then also, as now, troops of hungry and semi-wild dogs used to wander about the fields and streets of the cities, devouring dead bodies and other offal (1 Kings xiv, 11; xvi, 4; xxi, 19, 28; xxii, 88; 2 Kings ix, 10, 86; Jer. xv, 3; Psa. lix, 6, 14), and thus became such objects of dislike (comp. Harmer, i, 198 sq.; Hötet, *Nachr. v. Marokko*, p. 284; Joliffe, p. 827) that fierce and cruel enemies are poetically styled dogs in Psa. xxii, 16, 20 (see Jer. xv, 8; comp. Joseph. *Ant.* xv, 8, 4; Homer, *Il.* xvii, 255; xxii, 385). Moreover, the dog, being an unclean animal (Isa. lxvi, 3; Matt. vii, 6; comp. Horace, *Ep.* i, 2, 26), as still in the East (Arvieux, iii, 189; Hasselquist, p. 109), and proverbially filthy in its food (Prov. xxvi, 11; 2 Pet. ii, 22), the terms *dog*, *dead dog*, *dog's head* were used as terms of reproach, or of humility in speaking of one's self (1 Sam. xxiv, 14; 2 Sam. iii, 8; ix, 8; xvi, 9; 2 Kings xviii, 18). Knox relates a story of a nobleman of Ceylon, who, being asked by the king how many children he had, replied, "Your majesty's dog has three puppies." Throughout the whole East "dog" is a term of reproach for impure and profane persons, and in this sense is used by the Jews respecting the Gentiles (Rev. xxii, 15; compare Schöttgen, *Hor. Heb.* i, 1145), and by Mohammedans respecting Christians (Weistein, i, 424; ii, 274). The wanton nature of the dog is another of its characteristics, and there can be no doubt that קַלְבָּהּ in Deut. xxiii, 18 means a male prostitute (i. q. פְּדֵיָהּ); comp. Ecclus. xxvi, 25, "A shameless woman shall be counted as a dog" (Hesych. *κυνὴ ἀναίδεῖς*). We still use the name of one of the noblest creatures in the world as a term of contempt (comp. Athen. vi, 270). To ask an Uzbek to sell his wife would be no affront, but to ask him to sell his dog an unpardonable insult—*Suggesterosh*, or dog-seller, being the most offensive epithet that one Uzbek can apply to another. The addition of the article (τοῖς κυναίοις, Matt. xv, 26; Mark vii, 27) implies that the presence of dogs was an ordinary feature of Eastern life in our Saviour's time. When Christ says in Matt. xv, 26, "It is not meet to take the children's bread and cast it to the dogs," by the children are meant the Jews; by the dogs, the Gentiles. In the Rabbinical writings the question is put, "What does a dog mean?" and the answer is, "One who is uncircumcised." The dog and the sow are mentioned together in Isa. lxvi, 3; Matt. vii, 6; 2 Pet. ii, 22, as being alike impure and unacceptable. Paul calls the false apostles dogs on account of their impurity and love of gain (Phil. iii, 2; see Simon, *Κυνοβλαβία, a Paulo mandata*, Smalcald, 1747). Those who are shut out of the kingdom of heaven are called dogs, sorcerers, etc. (Rev. xxii, 15), where the word is applied to all kinds of vile persons, as it is to a particular class in Deut. xxiii, 18. (See Wemyss's *Symbol. Dict.*)

Dogma (Gr. *δόγμα*), a doctrine received as an article of faith. I. In the Scriptures the Greek word *δόγμα* has nowhere the meaning of doctrine. In Ephes. ii, 15, and Col. ii, 14, it denotes Jewish ordinances. In other passages (Luke ii, 1; Acts xvi, 1; xvii, 7) it designates the decrees of Roman emperors. II. This term is used by some of the earliest writers of the Christian Church, both Greek and Latin, to designate a doctrine of the Christian Church, or the whole of the Christian doctrines. Thus, by

Ignatius, in the epistle to the Magnesians (chap. xii) the Christian doctrines are called *δόγματα τοῦ κυρίου καὶ τῶν ἀποστόλων*, and by Origen (in *Math.* lib. xii, § 28), *δόγματα Θεοῦ*. In his work against Celsus (*contra Celsum*, iii, c. 89) he calls the whole of the Christian doctrines *τὸ δόγμα*, and the apostles *ἐπισκοπῶν τοῦ δόγματος*. The ecclesiastical writers of the 2d and 8d centuries also applied it to the tenets of philosophical schools. But the meaning *Christian doctrine* came to be the common use of the word in the theological and ecclesiastical language of the Greek and Latin writers, and from the Latin it has passed into most of the modern languages, especially those of Roman Catholic countries. In English, the word *Dogma*, in this theological sense, is only of late coming much in use, but *Doctrine* has generally been used instead of it.

Dogmatic Theology (Lat. *Theologia Dogmatica*; Germ. *Dogmatische Theologie, Dogmatik*) is a special branch of theology, the object of which is to present a scientific and connected view of the accepted doctrines of the Christian faith. In English theology the name has not come into general use, but dogmatics are included in Systematic Theology. In Germany it became common, particularly after Danæus and Calixt, to separate systematic theology into dogmatics and ethics, and this arrangement is now generally adopted. In the following article we speak of "Dogmatic Theology" with special reference to its cultivation in Germany, and to its place in the theological literature of Germany, reserving the English literature on the subject for the article "Theology."

I. *Idea and Scope of Dogmatics*.—The functions of dogmatic theology are twofold: first, to establish what constitutes a doctrine of the Christian faith, and to elucidate it in both its religious and its philosophical aspects; secondly, to connect the individual doctrines into a system. As regards the second function, all writers on dogmatic theology have more or less the same aim in view; but with regard to the former, there is between them the widest possible divergence. There are, in particular, three radically different views of what constitutes a doctrine, of the sources from which dogmatic theology has to derive its chief material, and of the value of the doctrines shown to be articles of the Christian faith. These views we may call the Evangelical, the Roman Catholic, and the Rationalistic.

1. From the stand-point of an Evangelical theologian the Bible alone is recognised as the rule of faith, and as the source from which we have to derive our religious beliefs. The Evangelical dogmatic theologian presupposes the divine inspiration of the Bible, which another special branch of systematic theology, Apologetics (in English literature commonly called Evidences), has to demonstrate. He does not enter into a minute interpretation of the true sense of the word of the Bible, which is the proper function of exegetical theology, but his aim is, by combining all which the Scriptures teach on one particular subject, to establish a doctrine of the Bible. Among those who accept the Bible as the inspired word of God and as the only rule of faith, there has been from the beginning of the Christian Church a wide difference of opinion as to the meaning of many passages of the Bible-word. Thus different theological parties have arisen in the Church, and different ecclesiastical organizations (churches, sects, heresies). The latter, in many instances, have adopted "symbolical books" setting forth their conception of the teaching of the Bible on the most important articles of faith, and have demanded from their members, and in particular from ministers, an acceptance of their distinctive views. Hence we have Lutheran dogmatics, Reformed dogmatics, etc. Julius Müller (in Herzog's *Encyclopædie*, a. v. Dogmatik) objects to denominational dogmatics, and asserts that Protestants should have only *Christian dogmatics*—not Reformed, Lutheran, etc. But in this

pect we think Schleiermacher is correct (*Darstellung heol. Studiums*, § 98) in stating that dogmatic theology must be written from the point of view of some church Confession, while he is entirely wrong in making it a branch of Historical Theology. Protestant dogmatics treats, not of opinions, but of doctrines acted as such by the Church.

2. The dogmatic theology of the Roman Catholic Church recognises, besides the Scriptures, the tradition of the Church as part of the rule of faith. The Scriptures are only to be understood in the sense which the Church declares to be the true one. The dogmatic theology of the Roman Catholic Church consequently contains only those doctrines which that Church has declared to be such. All other doctrines that have not received this formal definition by the Church, however clearly they may appear to be founded in the Scriptures or demonstrated by theological science, have only the value of "theological opinion" (*theologoumenon*). With regard to the Biblical proof for the doctrines, Roman Catholic writers distinguish between Biblical and ecclesiastical doctrines, the latter of which can only be proved by tradition. Other distinctions made by them are: *Dogmata implicita* and *explicita* (fully defined); pure (if they can only be known from divine revelation) and mixed (if they can also be demonstrated by reason), necessary (those a belief in which is declared to be necessary for salvation) and useful (which are not necessary for salvation).

3. The first Rationalistic writers on dogmatic theology did not refuse belief in any doctrine they found in the Bible; but, demanding that the conformity of every Biblical doctrine with reason should be demonstrated, they introduced a new interpretation of the Bible, explaining away a number of doctrines which thus far had been generally accepted both by Evangelical and Roman Catholic theologians. Subsequent schools of Rationalism denied the authenticity of most of the books of the Bible, and consequently rejected all doctrines as Biblical which could only be proved by the books rejected by them; and the authority of the Old Testament was denied *in toto*. In the New Testament a distinction was drawn between the opinions of the apostles and the words of Jesus, and infallibility claimed for the latter exclusively. Finally, schools arose which maintained the fallibility of Jesus himself, and which regarded the doctrines taught in the Bible as entitled to no more authority than any system of human opinions. See RATIONALISM.

II. *History*.—The beginnings of a systematic exhibition of Christian doctrine are seen in the Apostolic and the Nicene Creeds. Among the writers of the ancient Church, Origen, in his work *περι ἀρχῶν*, presented the first outline of what may be called a system of (dogmatic) theology. Among the works of Augustine, the following were of a similar character: *Enchiridion ad Laurentium (de fide, spe et caritate)*; *de doctrina christiana*; *de civitate Dei*; *de fide ac symbolo*; *de ecclesiis dogmatibus*. They were followed by Fulgentius of Ruspe, Gennadius, and Junilius. In the Greek Church, the Catecheses of Gregory of Nyssa (*ὁ λόγος κατηχητικὸς ὁ μίγας*) and of Cyril of Jerusalem (*Catecheses ad baptizandos et baptizatos*) belong to this class of literature, though they have chiefly a practical object. The first scientific system of dogmatic theology was written by John of Damascus (*ἰκθῶσις ἀκριβῆς τῆς ἡρθοδόξου πίστεως*), whom, however, Isidor of Hispalis (died 686) had preceded as a compiler (in his *Sententie*). Dogmatic theology in the Middle Ages finds its foremost expression in Scholasticism, which is supplemented by Mysticism. In the 9th century Scotus Erigena was distinguished as a thinker; but his principal work, *De divisione naturæ*, is not a dogmatic theology in the strict sense of the word. At the close of the 11th and the beginning of the 12th century, Anselm of Canterbury, Roscellin,

and Abelard gave a new impulse to the treatment of dogmatic theology, and aimed at a reconciliation between philosophic speculation and faith. But a strictly scientific method was for the first time introduced by the *Magister Sententiarum* (Peter Lombardus), whose followers (Robert Pulleyn, Peter of Poitiers, etc.) were called *Sententiarii*. The school of St. Victor (Victorines), on the other hand, tried to unite profound mysticism with dialectics. Scholasticism was further developed by the greater acquaintance of the theologians with the works of Aristotle, which dates from the Crusades. Alexander of Hales (*Doctor Irrefragabilis*, 1221-1245), Albertus Magnus (1222-1280), Thomas Aquinas (1221-1274, the head of a new theological school which embraces nearly all the theologians of the Dominican order), compiled works of immense extent, called *Summa*, in which every chapter was subdivided into questions, distinctions, etc. But, chiefly owing to the ascendancy of Nominalism, scholastic theology soon degenerated into absurd subtleties. In opposition to the Thomistic school, the mystic school of Bonaventura (*Doctor Seraphicus*, died 1274) and the dialectic school of Duns Scotus (*Dr. Subtilis*, died 1308) arose, both from the Franciscan order. The conflict of theological schools became a conflict of monastic orders. The *Summa* were succeeded by Quodlibets; the multiplicity of questions was infinitely increased. The liberal but sceptical Occam (died 1347) was followed by the "last of scholastic theologians," Gabriel Biel (died 1495), while Mysticism, which had taken a practical turn in the works of Master Eckart, Tauler, Ruysbroek, and Suso, was brought into a scientific shape by Gerson (*Dr. Christianissimus*, died 1429). See SCHOLASTICISM. The progress of humanistic studies secured for dogmatic theology a more complete and thorough treatment, but only externally. Its regeneration begins with the Reformation. Luther was a preacher rather than a dogmatic theologian. The foundation of evangelical dogmatics was laid by Melancthon, the *præceptor Germaniæ*, in his *loci communes* (subsequently *loci theologici*). He was followed in the Lutheran theology by Chemnitz, Egidius and Nicolaus Hunnius, and the zealous Hutter (*Lutherus redivivus*), whose *loci* were particularly opposed to the moderate school of Melancthon. One of the greatest works of this period is the *Loci theologici* of J. Gerhard; and among other great writers were Quenstedt, Calov, Hollaz, Baier, etc. In these works a new school of Scholasticism arose, which again called forth an opposing school of Protestant mysticism (Jacob Böhme, Weigel, Arnd). In the Reformed churches there was from the beginning a less strict adherence to symbolic books, and a prevalence of the exegetical treatment of theology over the dogmatic. Zuingli wrote several dogmatical works of considerable value; but the standard work of the Reformed Church is Calvin's *Institutio Christianæ religionis*. Other Reformed writers on dogmatic theology were Bullinger, Musculus, Peter Martyr, Hyperius, and, in the 17th century, Keckermann, Polanus of Polansdorf, Alsted, Alting, Wollé, Burmann, Heidanus, F. Heidegger. New methods of treating dogmatic theology were attempted by Cocceius ("Federal Theology") and Leydecker (the "economical" method, dividing the subject according to the persons of the Trinity). In the Lutheran Church, Calixtus endeavored to substitute the analytical way ("final method") for the synthetical, which had been followed since Melancthon. At the close of the 17th and in the earlier part of the 18th century, Pietism, and the philosophical systems of Des Cartes, Leibnitz, and Wolf, began to exercise a considerable influence upon dogmatic theology both in the Lutheran and in the Reformed Church. In the Reformed Church, Arminianism, represented by Limborch and the French school of Saumur, gained numerous adherents; while in the Lutheran Church new methods were attempted by Pfaff, Buddeus, Carpsov, Rambach, and J. S.

Baumgarten, the last named being wholly under the influence of the Wolfian philosophy. The new method was more fully developed by Semler, Michaelis, Teller, Töllner, Döderlein, Morus, and others, who prepared the way for Rationalism, among whose early representatives were Gruner, Eckermann, and Henke. A new epoch began with the philosophy of Kant, by which the works of Tieffrunk, Stäudlin, and Ammon were more or less influenced. The orthodox system was adhered to by Storr and Reinhard, more, however, with regard to its supranaturalistic character than to all its ecclesiastical definitions and developments. Augusti pleaded the authority of the old doctrinal system, and the same was done by De Wette, who distinguished himself for dialectical keenness, and by Daub and Marheineke, who tried a mediation between the old theology and Hegelian speculation. In opposition to these attempts, Wegscheider consistently developed the views of the former Rationalists, and gave to the Rationalistic system the last finish. Bretschneider also proceeded from a Rationalistic stand-point, but in many questions tried to mediate between Rationalism and the old Church doctrine. A powerful influence upon German theology was exercised by Schleiermacher, who undertook the bold task of not only mediating between Rationalism and Supranaturalism, but of merging the two into an entirely new system, which was to acknowledge the claims of both. He based his *Christliche Glaube* neither upon historical authorities nor upon philosophical speculation; but, regarding the Christian revelation solely as a new, divine, world-redeeming principle of life, he represented dogmatic theology as the exhibition of the Christian consciousness manifesting itself in the Church. Several theological schools sprung from Schleiermacher; and even the schools opposed to his system felt and acknowledged its importance and its influence. Some of the adherents of Schleiermacher defended from his stand-point all the essential doctrines of Biblical orthodoxy. Others attempted a middle course between the system of Schleiermacher and the symbolical books of the German Protestant Church, as Twisten (*Vorlesungen über die Dogmatik der ev.-luth. kirche*, 2 vols. Hamburg, 1826-1829; 4th edit. 1837) and Nitzsch (*System der christlichen Lehre*, Bonn, 1829; 6th edit. 1851).

A third school rejected these two as deviations from the true spirit of Schleiermacher, and claimed the fullest independence of theological investigation with regard to both the doctrines of the Bible and the Church Confessions. To this school belong Schweizer (*Die Glaubenslehre der evang.-reform. Kirche*, 2 vols. Zurich, 1844-1847) and Baumgarten-Crusius (*Grundriss der ev.-kirchl. Dogmatik*, Jena, 1830). They were succeeded by Schenkel, who developed a system of dogmatics from the stand-point of conscience (*Christliche Dogmatik*, Wiesbaden, 2 vols. 1858-59). While one school of Hegel, already referred to, claimed that the new speculative philosophy of the absolute was identical with the orthodox dogmas, another school, the Young Hegelians, proclaimed that religion, carried to its perfection by reason, is only a god worshipping himself; that a god-man, as an individual, had never an existence upon earth. From this school proceeded Dr. F. Strauss, who, after declaring in his "Life of Jesus" the Biblical account of the life of Jesus a myth, attacked in his "Christian Doctrine in its Historic Development" (*Die christliche Glaubenslehre*, Tübingen, 1840-41, 2 vols.) even the belief in the personality of God and the immortality of the soul, and tried to undermine every fundamental doctrine of Christianity by tracing its history. L. Feuerbach, in his essence of Christianity (*Wesen des Christenthums*, 1841, Leipzig), went even beyond Strauss to the extreme limit of nihilism, rejecting religion itself as a dream and an illusion. Under the influence of both Schleiermacher and Hegel, the so-called Tübingen

school, of which F. C. Baur was the founder, sought to comprehend the historic development of the dogma the dialectic process of the idea itself, and as the development of the undeveloped doctrine of the Bible into a more adequate unity of contents and form. We have no complete system of dogmatics from any prominent writer of this school. Many German theologians sustain either an eclectic or an independent relation with regard to the philosophical schools just mentioned. Thus Liebner (*Christliche Dogmatik*, Götting, 1843, 2 vols.) and Lange (*Christliche Dogmatik*, Heidelberg, 1852-1852) were called the Epigoni of speculative theology, and Hase, the Church historian, was a prominent representative of speculative rationalism (*Lehrbuch des evangel. Dogmatik* (Stuttg. 1826, 5th edit. 1860). In direct opposition to the rationalistic and speculative dogmatics, as well as to the vague supranaturalism of the 18th century, there developed itself at the beginning of the present century a school which demanded a restoration of the original theological method of the Reformed churches, as it existed in the 16th century, especially of the old Lutheran dogmatics. Among the works of this class are H. Schmid (*Dogmatik der ev.-luth. K.* Erlangen, 1843, 5th edition, 1868) and Philipp (*Kirchliche Glaubenslehre*, Stuttgart, 1854-53, 4 vols.). Ebrard wrote a manual of dogmatics from the stand-point of the evangelical school in the United Evangelical Church, which is based upon the doctrines common to the old Lutheran and old Reformed churches (*Christliche Dogmatik*, Königsberg, 1851-52, 2 vols. 3d edit. 1862-63). Previously Tob. Beck, abandoning the traditional method of theological schools, sought to bring the doctrines of the Bible, without regard to theological controversies and symbolical books, into a system, using many new terms (*Die christl. Lehranschauung*, Stuttgart, 1840).

In the Roman Catholic Church, the writers on dogmatics for a long time after the Reformation adhered to the scholastic method. Prominent among them were Bellarmin, Canisius, Maldonat, and Bossuet. Noel (Alexander Natalis, died 1724) introduced a new dogmatic method, more simple, and in many respects emancipating itself from the clumsiness of scholasticism. In Germany a number of writers appeared (e. g. Schwarz, Zimmermann, Brenner, Dobmayer), leaning on the reigning philosophical schools. Among works aiming merely at a systematic exhibition of the doctrines of the Church, those by Liebermann and Perrone (a Roman Jesuit) have acquired permanent reputation. Klee (*Kathol. Dogmatik*, Mainz, 1835, 3d ed. 1845) paid prominent attention to Biblical and patristic arguments, but neglected the philosophical development of doctrines. This feature is more conspicuous in the manuals of dogmatics by Staudenmaier (*Christl. Dogmatik*, Freiburg, 1844-54, 4 vols.) Diermer (*Lehrbuch der kath. Dogmatik*, 4th edition, 1858), and Kuhn. The establishment of a new theological school was attempted by Hermes (q. v.), who, conceiving doubt as the necessary condition of truth, sought through doubt to advance to the proof of the Roman Catholic doctrine; but his system was condemned by the Pope. The same fate happened to the system of Günther (q. v.), and to most of the works of Franz Baader (q. v.), who was largely under the influence of Schelling.

On the history of dogmatics, see Heinrich (*Versuch einer Geschichte der verschiedenen Lehrarten*, etc. Leipz. 1790); Schickedanz (*Versuch einer Gesch. der christl. Glaubenslehre*, Brunschw. 1827); Hermann (*Geschichte der protest. Dogmatik vom Melanchthon bis Schleiermacher*, Leipz. 1842); and Gass (*Geschichte der protestantischen Dogmatik in ihrem Zusammenhange mit der Theologie überhaupt*, Berlin, 1854-1866, 4 vols.); Frank (*Geschichte d. prot. Theologie* (Leips. 1862-65, 2 vols.); Dörner, *Geschichte der protestant. Theologie*, besond. in Deutschland (1867, 8vo). See also Herzog, *Real-Encyclopädie*, iii, 433; Hagenbach, *Encyclopädie*, p. 521.

man Theology (In *New American Cyclopædia*, viii, 1), and our art. DOCTRINES, HISTORY OF.

Dolino. See DULCINISTS.

Joleful creatures (אֲרִיָּוִת, *ochim'*, prop. *shrikes*, or *howling animals*; Sept. ἵξος, *noies*, Vulg. *dras*, *dragons*) is thought by most to be a general name for *hoolets*, or screech-owls, which the prophet liets will occupy the desolate palaces of Babylon (.. xiii, 21). See OWL. As the parallelism requires an animal inhabiting ruins and uttering a disconsorty to be understood, the Rabbin (with Abulwunderstand the *marten*, or kind of weasel (comp. zig, in loc.), which has a clear, short, plaintive note (Bechstein, *Naturgesch.* i, 28). But the owl is probable, as it is well known for this peculiarity (p. *gemere*, Pliny, x, 16; *queri*, Virg. *Æn.* iv, 462). OCHIM.

Dolēsus (Δολέσος), a citizen of Gadara of rank wealth, whom the inhabitants slew out of spite to the Romans on surrendering the city to Vespasian (Josephus, *War*, iv, 7, 8).

Dome (Latin *domus*, a house). In the early Middle Ages the word *domus* was applied to the house of God, and especially to the cathedral church. In this sense the derivatives of the word are still used in Italy and Germany. The word *dome* is used more generally in architecture to signify the roof to the whole or a part of a building, which roof has a circular polygonal base, and whose perpendicular section is a curved line. Such domes, or curved roofs, are found very early in the history of architecture, especially in India and Persia. The dome of modern architecture is its origin in the Roman adaptation of the Etruscan dome. The roof of the Pantheon at Rome is the finest example existing of the ancient Roman dome. In the Christian architecture, a flat dome over the centre of arch edifices, resting upon four arches, and supported below by half or quarter domes, is copied in the Christian religious architecture. A modification of the dome into the horse-shoe dome has been introduced largely into the Russian and some other Oriental branches of architecture. In the transition from Byzantine to the Romanesque style of architecture, the dome became more of a cupola. In the Gothic architecture the dome disappeared. The Baptistery at Pisa, founded in the 13th century, has a dome for a roof, though all the ornaments are Gothic. It was during the Renaissance, that the modern dome was developed. The first one built was in the church of Santo Spirito, Florence. It had a semicircle for its section, and a single dome. The dome of the cathedral of Florence has a diameter of 139 feet, the same as that of St. Peter's in Rome, and only three feet less than that of the Pantheon at Rome. This dome is considered by some to be more elegant in outline than that of St. Peter's, which others consider the most graceful dome ever built. Both rest on a cylinder, or drum, and have a double dome; that is, they have each an interior dome, surmounted by an exterior one, rising from the same base, and being more pointed. This exterior dome is only for its effect on the external architecture. They are both surmounted by a small cupola, called a lantern. All later Renaissance domes are built on this general type. Among the most famous domes are the following: Pantheon, Rome, 143 feet in diameter; Cathedral, Florence, 139; St. Peter's, Rome, 139; St. Sophia, Constantinople, 115; St. Paul's, London, 112; Mosque of Achmet, Constantinople, 92; Church of the Holy Sepulchre, Jerusalem, 80; St. Vitalis, Ravenna, 55; St. Mark's, Venice, 44.—Maigne, *Dictionnaire des origines et des arts* (Paris, 1864); Lübke, *Geschichte der Baukunst*; Viollet le Duc, *Dictionnaire de l'Architecture* (Paris, 1858).

Dominic, a saint of the Romish calendar, founder of the order of "Dominicans." His name was "Do-

mingo de Guzman, and he was born in 1170 at Calahorra, Spain. He completed his education at the University of Palencia, in 1198 was made canon of the cathedral of Osma, and in 1198 a priest and archdeacon. He subsequently became known as an eloquent preacher, and was sent on missions to various parts of Spain, and into France. Having had his zeal inflamed by the progress of the Albigenses, he bent all his energies to their conversion. Finding his own efforts insufficient, he appears to have conceived the idea of founding an order of preaching friars, whose special duty should be the conversion of heretics; and about the commencement of the 13th century he began to carry his purpose into effect. He soon found numerous volunteers to his new order, and, to disarm opposition, he and his followers adopted the rule of St. Augustine. As a distinct order, they did not, however, receive the formal verbal approval of the pope, Innocent III, till 1215. See DOMINICANS. Dominic did not, however, trust for the uprooting of heresy simply to his own preaching and that of his followers. Finding that his eloquence failed to convert the Albigenses, he, with the papal legate, Peter of Castelnau and Rainier of Raoul, obtained permission of Innocent III to hold courts, before which they might summon by authority of the pope, and without reference to the local bishops, any individuals suspected of heresy, and inflict upon them, if obstinate, capital punishment, or otherwise any lesser penalty. Peter of Castelnau, who had made himself especially obnoxious by his severity, was killed at Toulouse in 1208; and then was proclaimed by the pope, at the instigation of Dominic, that fearful 'crusade,' as it was designated by Innocent, to which all the barons of France were summoned, and which, under the captaincy of De Montfort, led to the slaughter of so many thousands of these so-called heretics. See ALBIGENSES. Dominic himself, it has been said, was not personally cruel; but towards heretics he had no compassion, and it is certain that, so far from attempting to lessen the horrible slaughter, he did what he could to stimulate it. Dominic is very frequently said to have been the founder of the Inquisition, but this is an error. He and his companions in the commission to examine and punish the Albigenses were commonly called 'Inquisitors,' but their commission was merely local and temporary. The 'Holy Office' was not formally established till 1238, when Gregory IX laid down the rules and defined the jurisdiction of the courts, which he appointed for various countries under the name of 'Inquisitorial Missions.' It is, however, worthy of notice that the chief inquisitor was a Dominican monk, Pietro de Verona, and that the governance of the Inquisition was placed pretty much in the hands of the Dominicans. The Romish accounts make Dominic a miracle-worker even to the extent of raising the dead to life, as in the case of a young nobleman named Napoleon, at Rome, on the Ash-Wednesday of 1218, and by other miracles. Dominic died at Bologna in 1221. He was canonized by pope Gregory IX on July 8, 1234: the Church of Rome keeps his festival on Aug. 4. Dominic is said to have written some commentaries upon St. Matthew, St. Paul, and the canonical epistles, but they have not come down to us.—*English Cyclopædia*; Butler, *Lives of Saints*, Aug. 4; *Acta Sanctorum*, Aug. i, 545 sq.; Lacordaire, *Vie de S. Dominique* (Bruxelles, 1848), and *Œuvres* (Paris, 1864), vol. i.

Dominica in Albis (*the Sunday of white garments*), a title anciently given to the Sunday after Easter, because on this day those persons who had been baptized at Easter appeared for the last time in the chrysumes, or white robes, which they received at baptism. These were laid up in the church as evidences of their baptismal profession.—Bingham, *Orig. Eccles.* bk. xx, ch. v, § 12.

Dominica Palmærum. See PALM-SUNDAY.

Dominicale, a white veil anciently worn by women at the time of receiving the Eucharist. It has been disputed whether the *dominicale* was not a linen cloth which women, in the sixth century, were in some churches required to take to the Eucharist, and with which they covered the hand before the bread was laid upon it. Augustine may refer to this in one of the sermons usually ascribed to him, *De Tempore*, in which he says that it was customary for men to wash their hands when they communicate, and for women to bring their little linen cloths to receive the body of Christ. In the Council of Auxerre, A.D. 590, a rule was enacted that no woman should receive the Eucharist in her bare hand, but nothing further is prescribed. The best authorities, however, are of opinion that the *dominicale* was a veil for the head.—*Farar, Eccles. Dictionary*, s. v.; *Bingham, Orig. Eccles.* bk. xv, ch. v, § 7.

Dominical Letter, the letter in our almanacs which marks the Lord's Day (*Dies Domini*), usually, printed in a capital form. In the calendar, the first seven letters of the alphabet are applied to the days of the week, the letter A being always given to the 1st of January, whatsoever that day may be, and the others in succession to the following days. If the year consisted of three hundred and sixty-four days, making an exact number of weeks, no change would ever take place in these letters. Thus, supposing the 1st of January in any given year to be Sunday, all the Sundays would be represented by A; not only in that year, but in all succeeding. There being, however, three hundred and sixty-five days in the year, the first letter is again repeated on the 31st of December, and, consequently, the Dominical, or Sunday letter for the following year will be G. The retrocession of the letters will, for the same reason, continue every year, so as to make F the Dominical letter of the third, etc. If every year were common, the process would continue regularly, and a cycle of seven years would be sufficient to restore the same letters to the same days as before. But the intercalation of a day every bissextile or leap year causes a variation. The leap-year, containing three hundred and sixty-six days, will throw the Dominical letter of the following year back two letters; so that, if the Dominical letter at the beginning of the year be C, the Dominical letter of the next year will be A. This alteration is not effected by dropping a letter altogether, but by changing the Dominical letter at the end of February, where the intercalation takes place. In consequence of this change every fourth year, twenty-eight years must elapse before a complete revolution of the Dominical letter can take place; and it is on this fact that the period of the solar cycle is founded. The rules for finding the Dominical letter for any year are given in the Book of Common Prayer.—*Hook, Ch. Dict.* s. v. See CYCLE.

Dominicans, an order of mendicants founded by Dominic (q. v.) de Guzman about the year 1215. In England they were generally called Black Friars from their garments, in France Jacobins, from the fact that their first French house was in the Rue St. Jacques, at Paris. They called themselves commonly Preaching Friars (*Fratres Prædicatorum*), from their office of preaching.

I. History.—Dominic projected the order when he was preaching against the Albigenses (q. v.); but the Council of Lateran, in 1215, declared itself against any increase of the monastic orders. Nevertheless Innocent III was prevailed upon to approve of the order on condition that it should assimilate itself as closely as possible to one already in existence. The successor of Innocent, Honorius III, was less reluctant, and confirmed the Dominicans as a new and independent order. It spread rapidly over all Christian countries. In 1221 thirteen of the friars went to England for the

purpose of establishing the order, and Stephen Langton, then archbishop of Canterbury, gave his approval, they fixed their first house at Oxford, the second house was in London. At the dissolution of the monasteries under Henry VIII there were 68 houses in England and Wales.



Dominican Monk. 1. Abroad. 2. In-land.

second general chapter was held, in 1221, at Beaulieu, where 60 convents, belonging to eight provinces, were represented, and a great many friars were sent out to establish new houses. In 1278 the number of convents amounted to 417. In 1233 the Inquisition (q. v.) was transferred to them by the Pope. This was a powerful and pernicious influence in Portugal, Italy, and France. They showed so much eagerness in hunting up and prosecuting heretics, that a popular pun changed the name *Dominicans* to *Dominicæ canes* (the dogs of the Lord). Although allowed in 1272 with all the privileges of the mendicant orders, they soon gave up begging, and, after being allowed in 1425 to accept donations, they accumulated great wealth. Together with the Franciscans, they became the chief representatives of the theological science of the Middle Ages, occupied a large number of the theological chairs at the universities, and came in most controversies not only the rivals, but also the bitter opponents of the Franciscans. Their greatest theologian among them in the Middle Ages was Thomas Aquinas (q. v.), whom they have ever since followed as a standard authority. Among the other celebrities are Albertus Magnus, Ecard, Tankard, Suso, Savonarola, Las Casas, Vincent Ferrier, and Vincent of Beauvais. As theologians, they were nominalists, Augustinians, and opponents of the immaculate Conception. In literature in general they have had great influence, as the *Magister sacri palatii* at Rome, in whose hands is the censorship of books, had always been taken from their order. They secured great popular favor not only by their preaching, but by the establishment of an order of tertians, open to laymen. The people were also gained by them especially by the spreading of the use of the Rosary (q. v.), which was introduced by them, and which became, in consequence of the many indulgences attached to it by the popes, a very popular form of worship. The Dominicans also belonged to the most zealous laborers in the foreign missions of the Roman Church. Many of their members were sent to the East; and in Armenia, in particular, they succeeded in uniting a great many Armenians with the Roman Church. After the discovery and conquest of America by the Spaniards, the Dominicans protected the natives from being enslaved, but gave, on the other hand, the first impulse to the importation of slaves from Africa. In America and in the West and East Indies, they surpassed all other

power, numbers, and riches. In Europe, on any, the reputation and influence of the order declined. The conduct of Tetzels (q. v.) in the papal indulgences brought odium upon the order, and the development of the Inquisition, under the management of the Dominicans, attached to their name a stain which will never be effaced out. In the countries which embraced the order they lost over 400 convents, while in Catholic countries they were generally superstitious confessors at the court and as teachers at universities, by the Jesuits. Several attempts to reform the order were made in the 15th and 16th centuries, but led only to the establishment of 12 reformed congregations. The whole order was never brought to its original simplicity and vigor. Yet they numbered in the 18th century more than 1000 convents and nuns in 45 provinces, 11 of which were outside of Europe. In consequence of the French Revolution, they lost all their convents in France and Germany, nearly all in Italy; and in the 19th century they were entirely suppressed in Spain, Portugal, and Sardinia. In 1832 the emperor of Russia suppressed in the sole province of Moldavia 55 Dominican convents. In Father Lacordaire's order received a member of great reputation and influence, and through him the order was re-established in France in 1845. In Austria the Dominicans recently submitted, in 1858, to certain reforms which were ordered to be introduced. According to the regulations made, all the novices are to be bound to the same rule, which will also be established in every country as soon as it will have a majority of reformed convents. The order is on the increase in the United States of North America and in France, and establishments first convent in Prussia in 1860. The Dominicans entered the United States in 1589, but their mission has been less extensive than those of the Franciscans and Jesuits. The first bishop of New York, John Jay, had been assistant general of the order. A great activity in behalf of its spreading was displayed by father (later bishop) John Jay, a native of Maryland, who entered the novitiate at Bornhem, Belgium. He established the convent of St. Rose, Springfield, Ky., which is now the head of the order in the United States.

II. Constitution.—The constitution of the order was adopted at a general chapter in 1220, and is in all essential points like that of the other mendicant orders. The head of the order is a general, who is elected by general chapter for life, and is assisted in the exercise of his office by a number of *definitores*. The order is divided into provinces, at the head of which is a provincial, who is elected at a provincial chapter by the superiors of the houses, who are called priors. Their habit consists of a white garment and scapular, with a white mantle and hood ending in a point.

III. Statistics.—The Dominicans have still convents in Italy (4 in the city of Rome, with about 100 members), France (10 in 1862), Belgium, Holland, England, Ireland (about 50 members in 1848), Austria (87 convents with 202 members in 1848), Prussia (first convent established in 1860), Poland (in 1841, 16 houses with 160 members), Spain, Russia, Turkey, Mexico, Central and South America, and the United States, where they have houses in New York, Ohio, Kentucky, and Wisconsin. In 1862 the total number of convents was estimated at 860 houses, with 4000 members. See Fehr's *Geschichte der Mönchsorden*; Helyot, *Ordres Religieux*; Malvendi, *Annales Ordinis Predicatorum* (Rome, 1746); Castillo and Lopez, *Historia general de S. Domingo y de su Orden de Predicadores* (Madrid, 1612 sq. 6 vols. fol.); Antonius Senensis, *Chronicon Fratrum Predicatorum* (Paris, 1585, 8vo). A complete list of all the saints, martyrs, writers, etc., of the order is given in *Année Dominicaine* (Paris, 1678 sq. 18 vols. 4to). The complete statutes of the order may be found

in *Holstenii Codex Regularum* (Augsburg, 1759, 6 vols. fol.).

Dominican Nuns, an order of nuns founded by Dominic (q. v.) de Guzman in 1206, at Prouille, near Toulouse. They were mostly converted Albigenses. At the time of their greatest prosperity they counted about 400 convents in Europe and America. They fell earlier into irregularities and disorders than the monks. They took part in all the reforms which were introduced among the monks, and split into similar congregations. The first convent of the order in the United States was organized by father Thomas Wilson, in Kentucky, in 1823, from which some other houses have sprung in the dioceses of Cincinnati, Nashville, and San Francisco. There are also congregations in the dioceses of Milwaukee and Brooklyn. They have also convents in most Italian states, in France, Belgium, Holland, Switzerland, Germany, England, Russia. Their house in Rome is under the immediate direction of the Dominicans, while in most other countries they are under the jurisdiction of the diocesan bishops.



Dominican Nun.

Dominicum, a term applied by ancient writers to the Lord's day, the Lord's Supper, and the Lord's house. Cyprian uses it in two meanings in the same paragraph: *Locuples et dives es, et Dominicum celebrare te credis, quæ corbonam non respicias? quæ in Dominicum sine sacrificio venis; quæ partem de sacrificio, quod pauper obtulit, sumis?*—"Are you a rich and wealthy matron, and do you think that you rightly celebrate the *Dominicum*" (Lord's day or Lord's Supper), "who have no regard to the corban? who come into the *Dominicum*" (the Lord's house) "without any sacrifice, and eat part of the sacrifice which the poor have offered?" The general application of the word was to the Lord's house. Jerome says that the famous church at Antioch, which was commenced by Constantine, and completed and dedicated by Constantius, had the name of *Dominicum aureum*, in consequence of its richness and beauty.—Ducange, *Glossarium Med. et inf. Latinitatis*, s. v.; Farrar, *Eccles. Dictionary*, s. v.; Bingham, *Orig. Eccles.* bk. viii, ch. i.

Domini De, MARC ANTONY, a learned Italian theologian, was born in 1566, of an ancient family, at Arba, on the coast of Dalmatia, and studied at the Jesuits' college at Loretto, and at the University of Padua. The authorities of the university used their influence to induce him to enter the order of Jesuits: to this he appears to have consented at first; and, while passing his novitiate, he gave instruction in mathematics, physics, and eloquence. At the same time he employed his leisure in the study of theology. The routine of a college life not suiting his taste, De Dominis quitted Padua; and, on the recommendation of the emperor Rodolphus, he was appointed bishop of Segni, much to the anger of the Jesuits. Two years afterwards he was made archbishop of Spalatro; but, while holding this dignity, he became embroiled with the pope (Paul V) by taking a part in the disputes between that pontiff and the Venetians respecting the endowment of ecclesiastical establishments. On this occasion he threw out a censure on the conduct of the pope; and he further gave offence by entering upon

the important but personally dangerous subject of reforming the manners of the clergy. He resigned his archbishopric and retired to Venice in 1615, and in 1616 he came to England, where James I appointed him dean of Windsor. He now prepared his book, *De Republicâ Ecclesiastica*, the object of which is to show that the pope has no supremacy over other bishops (Lond. part i, 1617; part ii, 1620; part iii, Hanov. 1622, fol.). He edited father Paul's *Hist. of the Council of Trent* in English. De Dominis appears to have been restless and inconstant, for after a few years he expressed a wish to return to the Roman Church, and having received from Gregory XV a promise of pardon, he set out for Rome. Soon after his arrival, some intercepted letters gave indications that his repentance was not sincere, and he was in consequence committed to the castle of St. Angelo, where, after an imprisonment of a few months, he died, September, 1624. Being convicted after his death of heresy, his body was disinterred and burnt. A pamphlet, called his *Reasons for renouncing the Protestant Religion*, appeared in London in 1827 (8vo). Dr. Newland, dean of Ferns, published in 1860 a *Life and Contemporaneous Church History of De Dominis*.—Hook, *Eccles. Biog.* iv, 474; *English Cyclopædia*; Collier, *Eccles. Hist.* vii, 434 sq.

DOMINUS VOBISCUM (*the Lord be with you*), a form of salutation used in the liturgies of several of the Christian churches. It is taken from the book of Ruth, together with the response *et cum spiritu tuo*—"and with thy spirit." It was introduced into Christian worship before the end of the second century. A canon of the first council of Braga, in 563, directed against a custom which the Priscillianists had adopted, of assigning one form of salutation to the bishops and another to the presbyters, enjoins all to use the same form, *Dominus sit vobiscum*—"the Lord be with you;" and the people to reply, *Et cum spiritu tuo—sicut ab ipsis apostolis traditionem omnis retinet oriens*—"and with thy spirit," according to apostolic and Eastern custom.—Augusti, *Christl. Archaeologie*, bk. v, ch. iii, § vi.

DOMITIAN (TITUS FLAVIUS DOMITIANUS), Roman emperor, younger son of Vespasian and Domitilla, succeeded his brother Titus as emperor A.D. 81, and reigned until A.D. 96. In the beginning of his reign he affected great zeal for the reformation of public morals, but his true character showed itself later in almost unexampled cruelties. In A.D. 95 a persecution of the Christians is recorded in the history of the Church, but it appears to have been directed particularly against the Jews, with whom the Christians were then confounded by the Romans. Suetonius (*In Domitianum*, ch. xii) ascribes the proscriptions of the Jews, or those who lived after the manner of the Jews, and whom he styles as "improphi," to the rapacity of Domitian. Eusebius (iii, 17) says that Domitian "was the second that raised a persecution against us, and established himself as successor of Nero in his hatred and hostility to God." The same writer (iii, 19, 20), following Hegesippus, tells of a summons of the grandchildren of Jude the apostle to appear before Domitian. He questioned them as to their birth, claims, property, etc. and when they answered that the kingdom of Christ, for which they looked, was purely spiritual, he dismissed them. The tyrant was not so lenient with his own relatives, Flavius Clemens and Domitilla, who were charged with "Atheism and Jewish manners," charges often brought against the Christians. Flavius was executed and Domitilla banished, A.D. 95. Domitian himself was assassinated (A.D. 96). A tradition (not now believed) speaks of St. John as having been tried before Domitian, and that, having been condemned to be plunged into a caldron of boiling oil, he came forth unburnt. See Milman, *History of Christianity*, bk. ii, ch. iv; Gibbon, *Decline and Fall*, ch. xvi, and the article **PERSECUTION**.

Domitilla, niece (or wife) of Flavius Clemens, who

was put to death under Domitian (q. v.; see 18). It is not certain that they were Christians; it is at least probable. Domitilla did not suffer martyrdom, but was banished; an unwarranted tradition says that she was afterwards burnt under Trajan, is commemorated as a saint in the Roman Calendar, May 12. See Butler, *Lives of Saints*, May 12; Mont, *Mémoires*, ii, 124; Murdoch's *Moscow Gazette History*, N. Y. ed., i, 59.

DOMUS (*house*), a designation of the church and appendages of the church, in ancient times, with distinguishing epithets attached; thus:

DOMUS BASILICÆ (*oikos Basilicæ*) (in the plural) the houses of the clergy adjoining the church.—Eusebius, *Vit. Const.* iv, 59; Bingham, *Orig. Eccles.* bk. ch. vii, § 18.

DOMUS COLUMBÆ, *the house of the dove*, used by Tertullian for a church. When writing against the Valentinians, who affected secrecy in their doctrine, he compares them to the Eleusinian mysteries, whose temple was so guarded with doors and curtains that a man must be five years a candidate before he could be admitted to the *adytum* of the deity, or *antrum* of the sanctuary. "Whereas," says he, "the house of our dove is plain and simple, delights in high mountains, affects the light, loves the figure of the rainbow, the Ghost, and the orient or morning sun, which is the figure of Christ." "The house of the dove" must here be the same as "the house of Christ." Tertullian explains it, the house of the dove-like religion, and the dove-like disciples of Christ (Tertullianus contra Valentinum, c. 3, cited by Bingham, *Orig. Eccles.* bk. ch. i, § 2).

DOMUS DEI, **DOMUS DIVINA**, **DOMUS ECCLESIE**—*the House of the Lord, the Divine House, the House of the Church*. (1.) The first of these, *the Lord's House*, was one of the earliest names of the church-building, and it is still in use. It answers to the *Greek kathedra*, which some suppose to be the origin of our word "Church." See also **DOMINICUM**. (2.) The second title, *Divine House*, was applied, among the pagans, to the emperor's palace, and it was retained in this use by some Christian emperors. It was also applied to the Church; and from this double use some confusion has arisen in interpreting ancient writers. (3.) The title *House of the Church* was applied not only to the church edifice, but also to the bishop's house after the third century.—Bingham, *Orig. Eccles.* bk. viii, ch. i.

Donaldson, JOHN WILLIAM, D.D., a modern Latitudinarian divine and scholar, was born in London, June 10, 1811. He was educated first at the University of London, and afterwards at Trinity College, Cambridge, where he graduated as B.A. in 1834, and obtained the second place in the first class of the classical tripos. In 1835 he was elected fellow. His reputation rests upon his numerous and valuable writings in philology and classical literature, e. g. his *Theater of the Greeks* (8vo, many editions).—*New Cyclopædia* (1839; 3d ed. 1859).—*Varronianus* (1844). After his ordination he became head-master of Bury St. Edmunds, where he remained several years, and published *Mastil le Sophre* (a treatise on Hebrew grammar), and finally *Jasher*, or *Fragmænta Archælogæ Cœminum Hebraicorum*, etc. (Berlin, 1854; London, 1861, 8vo), the object of which was to reconstruct the lost book of *Jasher* from the fragments scattered through the O. T. The book is full of wild and extravagant conjectures. See **JASHER**. Soon after he resigned his place at Bury St. Edmunds, and returned to Cambridge, where he gave a course of lectures on Latin synonymes, and occupied himself with tuition. Then he wrote a volume entitled *Christian Orthodoxy reconciled with the Conclusions of modern critical Learning* (Lond. 1857, 8vo), an attempt, according to the author, "to stay the plague of unbelief, which has for some

followed in the train of a dishonest Bibliolathy." He was appointed one of the classical examiners of the University of London. He died in London in 1861. Dr. Donaldson was a man of great industry, learning, and integrity, but his critical faculty not equal to the tasks he ambitiously attempted. His *Jashar* abounds in misapplied learning, unskillful criticism, and unsound exegesis, was amply attested on its appearance by Ewald and other German critics, and by Perowne and others in England. See *Journal of Sacred Literature*, July, 1855, article i, and 1860, p. 206; *Christian Remembrancer*, Oct. 1855,

Donar. See **Thov.**

Donaria (*ἀναθήματα*, Luke xxi, 5), gifts and offerings to adorn the Church. The term was also applied in later times to gifts to the Church, which were placed on pillars, and set in public view as memorials of the great mercy which men had received from God.—Bingham, *Orig. Eccles.* bk. viii, ch. viii, § 1.

Donation of Constantine, a forged imperial edict, published between A.D. 755 and 766, professing to contain a gift from Constantine, in the year 824, of the provinces of Gaul and Italy to Sylvester, then Pope. The document exists both in a Greek and Latin text, and was first produced in a letter of Pope Adrian I to Charlemagne. Baronius defended its genuineness; but its spuriousness is now generally admitted. Its substance is as follows: "We give as a free gift to our most beloved father, Sylvester, the Pope, the city of Rome, the cities of all Italy, as well as the cities of the other Western countries. To make room for him, we renounce our sovereignty over all these provinces; and withdraw from Rome, transferring the seat of our empire to Byzantium, since it is not just that a terrestrial emperor should retain any power where God has placed the head of religion." "According to the legend," says Gibbon, "the first of the Christian emperors was healed of the leprosy, and purified in the waters of baptism, by St. Sylvester, the Roman bishop; never was physician more gloriously recompensed. The emperor's royal proselyte withdrew from his seat and patrimony of St. Peter; declared his resolution of founding a new capital in the East; and resigned to the popes the sacred and perpetual sovereignty of Rome, Italy, and the provinces of the West." The fraud was exposed by Baronius and rentius Valla. For the "Donation" and its literary history, see Fabricius, *Biblioth. Græca*, ed. Harles, 597; see also Gibbon, *Decline and Fall*, ch. xlix; man, *Latin Christianity*, bk. i, ch. ii; Elliott, *Decline of Romanism*, bk. iii, ch. xiv; Münch, *Ueber die Schenkung Constantins des Grossen* (Freiburg 1847); Biener, *De Collectionibus canonum ecclesie Græcæ* (Berl. 1827).

Donatists (*Pars Donati* was the name they themselves assumed). During the last half of the third and the first half of the fourth centuries there was a combination of elements at work in the bosom of the Church, which, in consequence of and in connection with peculiar forces operative on the outside, produced a severe strain upon its stability and unity. During this period there were repeated and powerful centrifugal tendencies, which gave birth successively to the Novatian, Meletian, and the Donatist schisms. The outward history of these schisms is long, and its remote causes and outward details must be learned from Church histories.

Of these movements, that of the Donatists in North Africa was by far the most important and widest in influence. Substantially it had the same ground character as the Novatian. On this point Neander very clearly and judiciously says: "This schism (the Donatist) may be compared, in many respects, to that of Novatian in the preceding period. In this, too, we see the conflict, for example, of Separatism with Catholicism; and it is therefore important,

in so far as it tended to settle and establish the notion of the visible, outward unity of the Church, and of the objective element in things of religion and of the Church. That which distinguishes the present case is the reaction, proceeding out of the essence of the Christian Church, and called forth, in this instance, by a peculiar occasion, against the confounding of the ecclesiastical and political elements; on which occasion, for the first time, the ideas which Christianity, as opposed to the papal religion of the state, had first made men distinctly conscious of, became an object of contention within the Christian Church itself—the ideas concerning universal, inalienable human rights; concerning liberty of conscience; concerning the rights of free conviction. The more immediate and local occasion of these disputes lay in a certain spirit of fanaticism, which, ever since the spread of Montanism, had prevailed in North Africa, and also in various circumstances superinduced by the Diocletian persecution" (Neander, *Church Hist.* Bohn's ed. iii, 250). The substance of what was at issue in this movement is given thus by Dr. Schaff: "The Donatist controversy was a conflict between Separatism and Catholicism; between ecclesiastical purism and ecclesiastical eclecticism; between the idea of the Church, as an exclusive community of regenerate saints, and the idea of the Church as the general Christendom of state and people. It revolved around the doctrine of the essence of the Christian Church, and in particular of the predicate of holiness [as in the Novatian controversy it revolved, ultimately at least, more round the predicate of unity]. It resulted in the completion by Augustine of the Catholic dogma of the Church, which had been partly developed by Cyprian in his conflict with a similar schism" [the Novatian] (Schaff's *Church Hist.* ii, 865).

Donatism, starting thus in a time of persecution, when the question in regard to the restoration of the Lapsed brought up under various aspects the question of authority and freedom, and created, too, a severer and a milder theory of discipline, had its roots in the age preceding its actual rise. Embers previously scattered, but still full of latent fire, lay ready all around to create and feed a new fire. Already in the Diocletian persecution the old controversy between the rigoristic and the milder party in regard to discipline was revived. Secundus of Tigisis, the primate of Numidia, led on by one Donatus of Casæ Nigræ, wrought himself into fury on the subject of severe discipline, advocating prompt exclusion, once and forever, of all who had fled in danger, or delivered up the sacred books to the persecutors. Mensurius, with Cæcilian, his archdeacon and successor, headed the milder party, advocating moderation and discretion, and casting suspicion on the motives of the rigorists. This tension threatened schism as early as the year 305 in the matter of an episcopal election for the city of Cirta (Schaff's *Hist. of the Christ. Church*, ii, 361). The actual outbreak was in 311. Mensurius, bishop of Carthage, died in that year, whereupon the clergy and people of that district, in a hasty manner, elected the archdeacon Cæcilianus in his place, and proceeded to consecrate him without summoning or consulting the bishops of Numidia, a contiguous and subordinate province. Perhaps courtesy or custom, perhaps some real or imaginary right, was here violated; at any rate, on this ground the disaffected party hastened to resent the slight by refusing to acknowledge the new bishop. In addition to the slight of the Numidian bishops, they justified their opposition to him on the ground or pretext that Felix, one of the bishops who was prominent in the consecration, was a *Traditor*—that is, one who had delivered up the sacred books to the persecutors. In Carthage, also, the elders of the congregation, besides many others, and among them a noble lady, Lucilla, a widow and very superstitious, were opposed to him. Secundus of Tigisis,

with seventy Numidian bishops, assembled at Carthage, summoned Cæcilian to appear, which he failing to do, they deposed and excommunicated him, and elected in his place Majorinus, the chaplain and favorite of the wealthy and influential widow, Lucilla. After his death in 315, DONATUS, a gifted man, of fiery energy and eloquence, revered by his admirers as a wonder-worker, and styled THE GREAT, was made his successor. From him the now developed party took their name.

Each party now labored to secure the conquest of churches, and thus the breach was extended, and the schism in the North African Church fully effected. The emperor Constantine, who had just secured the sovereignty in this part of the Roman empire, is supposed to have been prejudiced against the friends of Majorinus, for in his first edict he expressly excluded the party from the privileges which he bestowed on the Catholic Church. Thus condemned without a hearing, the Donatists presented a petition to the emperor, who was at the time in Gaul, asking him to name judges in that country before whom the questions which had arisen in the North African Church might be laid. He "directed that Melchides (Miltiades), bishop of Rome, with five other Gallic bishops, should inquire into the affair; that Cæcilian should appear before them, with ten bishops who were to present the charges against him, and ten other bishops who were to defend him" (Neander, *Church Hist.* Bohn's ed. iii, 268). The trial took place in 313. Melchides brought fifteen other Italian bishops, and Donatus also appeared on the opposite side as chief accuser of Cæcilian, and the soul of the new party. His charges were found to be unsustainable, and "he himself was declared guilty of various acts contrary to the laws of the Church."

The Donatists were of course dissatisfied with this result. A second hearing was ordered in 314, at which the charges against Felix, the ordainer of Cæcilian, were to be investigated. Felix was declared innocent. The Donatists now appealed from this ecclesiastical decision to the emperor himself. He accepted their appeal, though he answered it with violent expressions against them, and after listening to the delegates of the two parties at Milan, in 316, he also decided against the Donatists. The matter now took a severer turn. The emperor issued penal laws against the Donatists, deprived them of their churches, and confiscated their places of assembly. This exasperated them, and fully developed their enthusiasm. The strife went forward not without the use of carnal weapons on both sides. The Donatists were in spirit unsubdued and determined. Ursacius, who was empowered to carry the laws into effect against them, used forcible measures to compel them to unite with the Church. This produced a powerful ferment, and pushed them to the point of desperation. They declared that no power on earth could induce them to fellowship with the "rascal," as they called Cæcilian. The cause of the Donatists was espoused by a band of idle, roving, fanatical ascetics, who wandered about the country among the huts of the peasants (whence they were called by their adversaries *Circumcelliones* [q. v.]). These half-crazy beggars and plunderers excited the peasants to all sorts of violence, and went forth with fire and sword as the "Christian champions" (*agonistics*). Their fury cost blood, and the military was required to suppress it. Some of the Donatists were executed, others banished, and their churches were closed or confiscated. Death, met in this way, they regarded as martyrdom, and, instead of avoiding, they coveted it. Many who did not attain to this honor at the hands of their enemies, in their fanatical zeal resorted to suicide, casting themselves from precipices or into the fire, and even hired others to kill them. The emperor saw the mistake of his violent measures, and in 321 granted to the Donatists full liberty to fol-

low their convictions in faith and worship, at the same time exhorting the Catholics to patience and moderation. This somewhat subdued, but did not end the strife.

Under the successor of Constantine, Constantius, the Donatists fared worse again. We read of a battle of Hippo, in which the Donatists were defeated, and of thirteen years of tumult and bloodshed. In general they were subjected to severe measures.

When Julian the Apostate came into power as emperor, the Donatists were much pleased that Christianity should, under a pagan ruler, cease to be the dominant religion of the state. Thus, in 361, they obtained once more their full freedom in religious matters, and rose to the highest degree of eminence that at any time was attained by them. They took possession of their own churches again with joy; repairing the edifices, and generally cleansing the walls and staves. Towards the close of the 4th century Africa was covered with their churches, and had four hundred Donatist bishops.

To be thus placed on a level merely with heathen religions and all sects was, however, after all, only a negative comfort. It by no means adjusted the difficulties of the Donatists with the Church, and only succeeding emperors their case again because *vix* Maximus, a deacon, and Primitianus, a bishop of Carthage, coming into conflict with each other, created parties, out of which grew sects taking their names the *Maximianists* and the *Primitianists*. Other divisions and difficulties followed, and there grew up among the more thoughtful and reflecting of the African bishops a desire to have the breach healed. Reason and calm disputation also now more and more took the place of violence. A powerful influence toward reconciliation began to be exerted about 396 by Augustine, first preacher, and afterwards bishop of Hippo, in Numidia. He wrote, preached, and labored privately and publicly with varied, but still generally increasing success.

From this time forward the cause of the Donatists began gradually to decline. After a three-days' attrition at Carthage in 411, attended by 286 Catholic and 279 Donatist bishops, where the old issues were rediscussed, the Donatists again stood defeated. Stringent civil laws were also again passed against them, and in 415 they were forbidden, on pain of death, to hold religious assemblies. Even Augustine, who had depended on calm and earnest discussion before, now advocated force, appealing to Luke xiv, 23—"compel them to come in"—and exhorted the hesitating officer of the law to proceed in the infliction of the appointed penalties, saying that it was "much better that some should perish by their own fires than that the whole body should burn in the everlasting flames of Gehenna, through the desert of their impious dissension" (Waddington, *History of the Church*, p. 156). A new flame of violent desperation broke out. A bishop, Gaudentius, even vindicated suicide, referring in justification to 2 Mac. xiv; and threatened "that if an attempt were made to deprive him of his church by force, he would burn himself, with his congregation, in it." In 428, when Africa was conquered by the African Vandals, the Donatists suffered no persecution from them except as adherents to the Nicene Creed; and the great and long controversy was now virtually ended by the general destruction of the Church in Africa through that invasion. Yet the Donatists continued to survive as a distinct party down to the sixth century.

As may be seen from our sketch, the Donatists were not heretical in any essential articles of faith, nor were they immoral in life, except as their fanaticism led many into excesses, yet these were always disapproved by the better class. Many of the charges of immorality made against them are regarded as unfounded, or at least as highly exaggerated. The schism began in differences of view in regard to discipline, and was

nued and widened continually more and more by and severe action on the part of the Church and and growing fanaticism, separatistic pride, and on on the part of the Donatists. A rich lesson the Church through all ages lies in the history of remarkable schism and the subsequent contro-

the above account of the Donatists, written by lamented Dr. Harbaugh, we append a few notes of views held with regard to them by writers who fix their position, more or less fully, from the non-liturgical point of view.

henkel, in Herzog's *Real-Encyclopädie* (art. *Kirche*, 568), speaks of Donatism as an attempt (similar at of the Novatians) to break the hard shell of exal ecclesiasticism, and to bring out again, from dead mass of simply baptized Christians, the pure rch of the regenerate; to substitute, in a word, Christian communion for an ecclesiastical corporation. "Augustine, in opposing the Donatists, went ar (*Epist.* clxi, 5) as to call separation from the scopal Church a crime, and to say that no separation could be saved." The question turned (Schenkel ceeds), in fact, upon that of Church and State. Donatists saw that the unity and freedom of the urch were imperilled by its union with the State, l they declared against the State-Church doctrine, n (under Constantine and his successors) a new ng. Augustine not only adopted the State-Church ory, but pushed it to its legitimate consequence, t the State is bound to put down separatists by ce. See AUGUSTINE. It is, perhaps, not too much say that the Roman Catholic ecclesiastical system ts on Augustine's doctrine of the Church as set th in his writings against the Donatists.

The Donatist doctrine was that the true Church is mposed only of pure Christians; Augustine, on the her hand, held that the "Church consists of the sum tal of all the baptized, and that the ideal sanctity of a Church is not impaired by impure elements exteri lly connected with it. He nevertheless advocated a gorous exercise of Church discipline" (Hagenbach, *istory of Doctrines*, § 135). Neander maintains that th the Donatists and their opponents confounded the isible with the invisible Church, and placed the pre dates of purity and holiness in the former. The onatists made catholicity to depend upon purity; ugustine made purity depend upon catholicity. The onatists said, "Whoever is a true Christian is to us Catholic;" Augustine said, "No man can have hrist for his head who is not a member of his body, e Church." Neander thinks, therefore, that, had the arties fully understood and recognised the "distinc on in the idea of the Church as visible and invisible" hich Augustine came near to, but did not carry out), hey might have come to an agreement with each ther (*History of Dogmas*, Ryland's transl., ed. Bohn, , 395). The subject is very well treated from this oint of view, but with stronger independent leanings, n Punchard, *History of Congregationalism*, N. Y. 1865, ol. i, ch. ii. Litton (an unprelatical Episcopalian) olds that Donatism "sprang from a principle true in itself, but pushed beyond the limits of sobriety" (Lit ton, *The Church of Christ*, London, 1851, p. 518). See also Cooper, *The Free Church of Ancient Christendom* (Lond. 1858, p. 860 sq.).

The sources for the history of Donatism are given by Dr. Schaff (*Hist. of the Christian Church*, ii, 360):—Augustine, works against the Donatists; Optatus M-levitanus (about 370), *De Schismate Donatistarum*; Du Pin, *Monumenta vet. ad Donatist. hist. pertinentia* (Par. 1700); *Excerpta et Scripta vetera ad Donatista- rum Historiam pertinentia*, at the close of the 9th vol. of the Bened. ed. of Augustine's works. The litera- ture—Valesius, *De Schismat. Donat.* (appended to his ed. of Eusebius); Walch, *Historie der Ketzerzeiten*, etc.,

vol. iv; Neander, *Church History* (Torrey's, ii, 282 sq.); Roux, *De Augustino adversario Donat.* (Lugd. Bat. 1838); Ribbeck, *Donatus u. Augustinus, oder der erste entscheidende Kampf zwischen Separatismus u. der Kirche* (Elberf. 1858); Tillemont, *Mémoires* (Bruxelles, 1782), vi, 1-98; Arnold, *Kirchen.-u.-Ketzerhistorie*, bk. i, ch. viii; and the other works cited above.

Donative, in English ecclesiastical law, is a benefice made by the king (or any subject by his license), who founds a church or chapel, and ordains that it shall be merely in the gift or disposal of the patron, and vested absolutely in the clerk by the patron's deed of donation, without presentation, institution, or induction. This is said to have been anciently the only way of conferring ecclesiastical benefices in England; the method of institution by the bishop not having been established before the time of archbishop Becket, in the reign of Henry II. All bishoprics, being of royal foundation, were originally donatives.—Hook, *Church Dictionary*, s. v.

Donato, LUIGI, an Italian cardinal, was a native of Venice, and entered the Franciscan order at an early age. He was one of the founders of the school of theology in the University of Bologna, which, in the papal schism of the 14th century, declared for Urban VI. In 1879 Urban rewarded Donato for this service by causing him to be chosen general of the Franciscan orders. In 1880 he was created cardinal of St. Mark, and in the next year was sent by Urban on a mission to Charles III, king of Naples, for his want of success in which mission the pope arrested him, Jan. 18, 1885. He was charged with conspiracy, along with five other cardinals, and was put to the torture in presence of the pope himself. He was afterwards decapitated.—Sismondi, *Hist. des Républiques Italiennes*, vii, 241; Hoefler, *Nouv. Biog. Générale*, xiv, 539.

Donatus of Casæ Nigræ. See DONATISTS.

Donatus the Great. See DONATISTS.

Donker Curtius, HENDRICK HERMAN, was born at Hertogenbosch in 1778. At the age of sixteen he entered the University of Utrecht. He applied himself faithfully to his studies, and did not allow himself to be drawn aside by the political excitements of the time. In theology he enjoyed the privilege of listening to the instructions of the able and learned Heringa, who had but a short time before been inducted into the office of professor of theology in that institution. Highly prizing and faithfully improving this privilege, he reflected honor upon his able and faithful instructor. At the age of twenty-two he entered the ministry, and after spending a year or more in places of less note, he was called to Arnhem, where he continued to labor faithfully to the time of his death, which occurred July 25, 1839. The influence of Donker on the Reformed Church of Holland was very great. He was a popular and eloquent preacher. His style was perspicuous, flowing, and vigorous. For twenty years or more he conducted the *Godgeleerde Bydragen*, a theological journal of high character. In 1827 his essay on *Jesus leer als van God zelve geopenbaard en het gezag der rede in zaken van Godsdienst* received the gold medal from the Hague Society. For many years he was either president or vice-president of the General Synod of the Reformed Church. In regulating the government and discipline of the Church, in advancing theological science, and in elevating the standard of biblical scholarship in reference to candidates for the ministry, he labored zealously and successfully.

Donne, JOHN, D.D., dean of St. Paul's, was born in London in 1578. He received the instructions of a private tutor at home until 1584, when he entered Hart College, Oxford, from whence he went to Trinity College, Cambridge, in 1587. He took no degree at either university, as his parents had brought him up in the Roman Church, and were unwilling for him to take the necessary oaths. At the age of seventeen he com-

menced the study of law at Lincoln's Inn, advancing, at the same time, in liberal education under the care of able masters. After examining the question of religion thoroughly, he decided in favor of Protestantism. At this time, and for years after, he had no design of entering the ministry; he therefore sought civil employment, and upon several occasions accompanied expeditions and embassies abroad. From his youth he exhibited powers of no ordinary character. Before he was twenty he wrote his satires, which, Hume admits, "flashed with wit and ingenuity," though he speaks of "coarseness of expression." While yet a young man he wrote the most of his poems, some of which were of a licentious nature, leading us to infer that his life at this time was impure; this conclusion is strengthened by the utterances of deep penitence in many of his sermons. When about thirty years of age he was involved in a difficulty with his father-in-law, Sir George Moore, which resulted in his committal to prison for a short time. A lawsuit for the possession of his wife followed, and so impoverished him that he was compelled to depend upon his relatives. He now applied himself to the study of the civil and canon law, the fruit of which may be seen in some of his discourses. An invitation to enter the ministry, extended by Dr. Morton, afterwards bishop of Durham, was declined. He soon began to attract the notice of the chief men of the day, and, being frequently at court, that of the king, who regarded him as a man of wit and learning. In 1610 the king was so well pleased with his remarks on supremacy and allegiance, made one day at table, that he commanded him to embody the arguments in a formal treatise. He complied, and in the same year published his *Pseudo-martyr*, in which he showed that Roman Catholics ought to take the oath of allegiance. On perusing it, the king insisted that he should enter into orders, which, after two or three years spent in the study of theology, he did. He was immediately appointed chaplain to James I, and soon after was admitted D.D. at Cambridge. For a while, in 1617, he suspended his clerical functions, from grief at the loss of his wife. Soon after resuming them he was appointed to the deanery of St. Paul's. Preferments now came, so that he was soon raised from a condition of anxious penury to one of comparative affluence, in which he forgot not his friends and the poor. He also helped his father-in-law. He died March 31, 1631. Donne's epistolary writings are models in their kind. Some of his poems are very fine. But his sermons constitute his great title to enduring reputation. With a style somewhat like that of Sir Thomas Browne, he combined a power of illustration, an artistic skill, and a "capability of administering to thought" equalled by but one or two of his great contemporaries. His sermons are remarkable for subtle trains of thought and of argument. His published works are, 1. *Pseudo-martyr* (1610, 4to):—2. *Essays in Divinity* (1651, 12mo):—3. *Ignatius, his Conclave; a Satyr, with an Apology for the Jesuits* (1658, 12mo):—4. *Paradoxes, Essays, Characters, to which is added a Book of Epigrams, in Latin, translated by J. Mairne, D.D.* (1652, 12mo):—5. *The Works of John Donne, D.D.* (1839, 6 vols. 8vo). This is the best edition of his sermons. It is compiled from the old folio of 1640, and contains, in addition to the sermons, *Devotions, Letters, and Poems*. Besides the above is an essay entitled *Biathanatos*, a declaration that suicide may not always be sin. This was published fourteen years after his death, and contrary to his wishes, expressed in a letter to the earl of Ankerum, in which he says, "It is a book written by Jack Donne, and not by Dr. Donne." See Walton, *Life of Donne*; Alford's *Life of Donne*, in *Donne's Works*, vol. vi., and Preface to same, vol. i (edit. of 1839); Hume, *History of England*, vol. iv., 524; Coleridge, *Works* (New York edit.), v., 78 sq.

Donnellan Lecture, a course of lectures founded

by the provost and senior fellows of Trinity College, Dublin, in fulfillment of a legacy of £1345 left by the late John Donnellan, dated February 22, 1794, to that college, by which it was directed that the lectures should be given by the Rev. John Donnellan, "for the encouragement of religion, learning, and good manners." The lecturer is chosen annually on the 20th of November—the subject is determined at the time of election by the board. The course consists of six sermons, delivered at the college chapel after morning service. Among the lectures printed are Graves, *Lectures on the Passions* (1807, 2 vols. 8vo, London); Sadler, *On the Depositions* (Dublin, 1822, 2 vols. 8vo); Kennedy, *On the Mosaic Record of Creation* (London, 1826, 8vo); and The Prophecies relating to Antichrist (Dublin, 1840, 2 vols. 8vo); McDonnell, *On the Atonement*.

DONOSO-CORTES, JUAN (FRANCISCO-MARIA-MARIA-DE-LA-SALUD), marquis de Valdegama, count del Valle, was a politician, statesman, public diplomatist, historian, theologian, philosopher, and one of the ablest and most eminent of recent Spanish authors. He was born May 9, 1809, at La Valera, a village of Estremadura. At sixteen he had completed his preparatory studies, which were largely occupied with history, philosophy, and literature. His education in jurisprudence was prosecuted at the University of Seville. In 1830 he married and settled in Madrid. He received some public appointments, but devoted his talents chiefly to literature. In 1831 he entered the Cortes as representative of the province of Cadiz. He took the side of Maria Christina against the Carlists, rose to high favor in the court, and was appointed private secretary to queen Isabella II. In the office he resigned in 1845 on becoming a member of the royal council. He was an earnest advocate of the French marriages. In acknowledgment of his support, he was created by his sovereign Marquis de Valdegama, Viscount del Valle, and was decorated by Louis Philippe with the Grand Cross of the Legion of Honor.

In 1848, the Revolution, long foretold by him, exploded. The reforming Pope was driven from Rome, all the nations of Europe were agitated and convulsed. On the 4th of January, 1849, he pronounced his speech in the Cortes renouncing all liberal doctrines, and demanding a dictatorship. This speech startled Europe, and was perhaps the beginning of the reaction. It was a defiant reassertion of the principles of Gregory VII and Innocent III.

Shortly after the delivery of this speech, Donoso-Cortes was sent as ambassador extraordinary to Berlin. The earlier part of the next year was occupied with the rapid composition of his only formal work, his *Essay on Catholicism, Liberalism, and Socialism*. It was published in 1851, in Spanish, at Madrid, and was speedily translated into French, Italian, and German. An English version, by Madeleine Goddard, appeared in 1862 (Phila. 12mo). Just before the appearance of this work he was sent as ambassador to France, a mission which he held till his death. His eminence and high position were, however, embittered by the imputations of heretical doctrine alleged against his brilliant essay by the abbé Gaudel and other opponents. He submitted his book without reserve to the papal judgment. He died at Paris May 3, 1855.

A collection of his works, in 2 vols., had been published at Madrid in 1849 (*Collection escogida de los escritos del Señor Don Juan D.-C.*). A more complete edition of his works was published after his death (Madrid, 1854-55, 5 vols.) by Tejada, and was republished at Paris, in French, by M. Louis Veillet. The *Essay on Catholicism* forms three volumes of the collection. The other two volumes contain Parliamentary Addresses; Letters on France in 1842, and in 1851-2; Observations on Prussia in 1849; a few contributions to political and literary journals; letters to distinguished correspondents; and some unfinished sketches of historical and political topics.

The single work on which his reputation will rest

Essay named above. He is throughout a polemic after the order of Hooker, whose periods he alone of moderns rivals, with great precision, correctness, and elegance. The book is a rant on Protestantism and Liberalism; next, unquestioning advocacy and eulogy of Roman Catholicism, and all its ancient usages, doctrines, and policy. Yet it affords a bright exhibition of pure intellect and lofty sentiment. The writer is a logician, a mystic by his heart, ever present to his mind, and the redemption is never on his lips. Life is no independent, tain, arbitrary human evolution. It is the dread acted on earth by responsible beings in the ice of heaven and of hell, with the certainty of ne as a recompense or of the other as a doom. ns as well as individuals are on their trial in the arena, which is presided over by the Almighty, red to issue his eternal judgments. The course ight in the *Essay* is about as follows: Man, cren the image of his Maker, falls by disobedience. atered into the world, and death by sin. The curse lized in the alienation of the sinner from God, and e introduction of disorder and violence into all bases of human life, and into the whole constitu- of nature. "Discord on the music fell, and dark- on the glory." "The whole world groaneth un- w." Helpless, apparently discarded, and turned to the counsels and passions of his own depraved ; man falls into all the corruptions and aberrations athenism. Redeemed at last by divine grace and ine expiation, the work of regeneration and resion commences. Christianity changes the spir- the world, and recreates society. It changes relation of man to his Creator and to his fellow-

The little leaven ferments, and leaveneth the le lump, and civilization slowly becomes Christian oughout instead of pagan. The range of man's emplation is enlarged and his sympathies ex- pand- his reason is strengthened, his knowledge aug- ted, his dominion over thought and matter is in- sed; but, in the pride of intellect, he claims again knowledge of good and evil; he speculates about hings; he drags revelation and the ordinances of before the tribunal of his own understanding; he ntains the sovereignty of his own caprices, phanta- and passions; he inaugurates on earth a new re- ; similar to that which cast the rebellious angels of heaven. The passionate vacillations or vaga- of the individual or of the mass are substituted the decrees of the Almighty and beneficent Father ll. The furious appetencies of pride, greed, jeal- y, and lust are taken to be canons of political and ial wisdom, instead of the precepts of the moral and of obedience to constituted authorities, "since powers that be are ordained of God." Hence an of revolutions and of social disturbances prepares way for the long agony of a material and debasing otism. All that is right, and wholesome, and en- bed with promise is founded on voluntary submission the will of God. All revolt from his ordinances is ; and is followed by the consequences of sin—disor- , crime, war, wretchedness, impotency, ending in po- cal and social dissolution. The law of the Gospel is e law of perfect liberty. The carnal mind is enmity to God; and the law of man is enslavement to the sions, provoking, inviting, necessitating, and mar- ring the tyranny of force on earth, and eternal torts hereafter.

Such, in general terms, and divested of its partisan coloring, is the substance of this splendid essay, which longs to the same general type of speculation as the and or graceful productions of Bossuet, De Maistre, hateaubriand, and Montalembert. But the author's litical absolutism was a bad inference from the sound eology of his *Essay*; and while the direct influence of his book is conservative, its ultimate effect doubt-

less was to increase the atheistic tendency in Europe by confounding Christianity with despotism. See a discriminating essay in *The Catholic World*, April, 1867, art. i.; also *Bibliotheca Sacra*, Oct. 1866, p. 679. A life of Donoso-Cortes was written by Tejada, and is embraced in the edition of his works.

Donum Superadditum, or **Supernaturalè**, a designation of the scholastic doctrine of "superadded grace" given to Adam, in addition to his natural powers, and which grace he lost by the Fall. According to some of the scholastic divines (Scotus Erigena, Bonaventura, etc.), original righteousness (*justitia originalis*) was added to man's natural powers (*pura naturalia*) as a *donum superadditum*. Aquinas held (pt. i, qu. 95, art. 9) that man was created in possession of original righteousness, still, however, as a grace superadded to his natural powers.

Möhler thus states the doctrine: "No finite body can exist in a living moral communion with the deity save by the communion of the Holy Spirit. This relation of Adam to God, as it exalted him above human nature, and made him participate in that of God, is hence termed a supernatural gift of grace, *superadditum* to the endowments of nature. This is not merely a private opinion of theologians, but a dogma" (*Symbolism*, bk. i, pt. i, § 1, N. Y. 1844, 8vo; see also the *Catechismus Romanus*, i, 2, 19; Bellarmin, *Gratia primi hominis*, 2; citations in Winer, *Comparat. Darstellung*, 4). Dr. J. H. Newman, while yet in the Church of England, taught this doctrine: "What Adam lost in sinning was a supernatural endowment" (*Lectures on Justification*, 177); so also archdeacon Wilberforce: "The likeness of God must have been some divine presence *superadded* to primitive nature (*On Incarnation*, p. 71, London edit.). The Roman Church further holds that this supernatural presence is restored by baptism, so that a baptized person stands in the condition of Adam before the Fall. If he goes astray, he is to be restored by confession, absolution, and the sacrament of penance. See Bird, *Sacramental System* (London, 1854), § 4; Hagenbach, *History of Doctrines* (Smith's edit.), § 175, 245; Jackson, *Works*, ix, 8 (Oxford); Neander, *History of Dogmas* (Bohn's edit.), ii, 654. See IMAGE OF GOD; SIN, ORIGINAL.

Doollittel (or **DOOLITTLE**), THOMAS, M.A., a Nonconformist divine, was born at Kidderminster, England, in 1680; was educated at Pembroke Hall, Cambridge, and became minister of St. Alphage, London. Ejected in 1662, he taught school in Moorfields, and afterwards at Woodford Bridge. Returning to London after the plague, he had a meeting-house built in Monkwell Street, London, where he continued his ministry (with some interruptions from persecution) until his death, May 24, 1707. His writings became very popular; the principal are, *A Treatise concerning the Lord's Supper* (Lond. 9th edit. 1675, 12mo);—*Love to Christ necessary to Escape the Curse at his coming* (London, 1830, 18mo);—*Captives bound in Chains made free by Christ* (on Isa. lxi, 1);—*A Rebuke for Sin* (1678);—*A complete Body of Divinity* (1723, fol.), etc.—Darling, *Cyclopædia Bibliographica*, i, 945; Calamy, *Nonconformists' Memorial*, i, 80 (ed. of 1778).

Door (usually דַּלְתוֹת, *da'leth*, strictly the *valve* or part that swings on the hinges; while פֶּתָח, *pe'thach*, designates the entrance or *door-way*; שַׁעַר, *sha'ar*, is rather a *gate*; Gr. *θύρα*). From a comparison of various passages of Scripture, we learn that anciently doors were suspended and moved by means of pivots of wood, which projected from the ends of the two folds, both above and below. The upper pivots, which were the longest, were inserted in sockets sufficiently large to receive them in the lintel; the lower ones were secured in a corresponding manner in the threshold. The pivots or axles are called פֶּתוֹת, *pothoth*; the sockets in which they are inserted, צִירִים, *tsirim*'

(Prov. xxvi, 14). Doors were fastened by a lock (Cant. v, 5), or by a bar (Judg. xvi, 3; Job xxxviii, 10). Those made of iron and brass were not used except as a security to the gates of fortified places or repositories of valuables (Isa. xlv, 2, 3). The lock was nothing more than a wooden slide attached to one of the folds, which entered into a hole in the door-post, and was secured there by teeth cut into it, or catches. Two strings passed through an orifice leading to the external side of the door. A man going out, by the aid of one of these strings moved the slide into its place in the post, where it was so fastened among the teeth, or catches, as not to be drawn back. The one coming in, who wished to unlock, had a wooden key, sufficiently large, and crooked, like a sickle. It was called *מִפְתָּח*, *miphthach'* (Judg. iii, 25). He thrust the key through the orifice of the door, or key-hole, lifted up the slide so as to extricate it from the catches, and, taking hold of the other string, drew it back, and thus entered. Keys were not made of metal, except for the rich and powerful, and these were sometimes adorned with an ivory handle. A key of this kind, in the days of the Hebrew monarchs, was assigned to the steward of the royal palace as a mark of his office, and he carried it on his shoulder (Isa. xxii, 22). The key-hole was sometimes so large as to admit a person's finger through it, and enable him to lift

but if they were really locks, they were probably on the principle of those now used in Egypt, which are

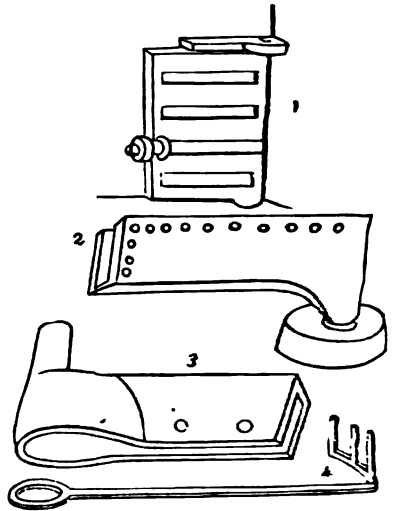

Ancient Egyptian Bolt, Hinges, and Key to a Door.

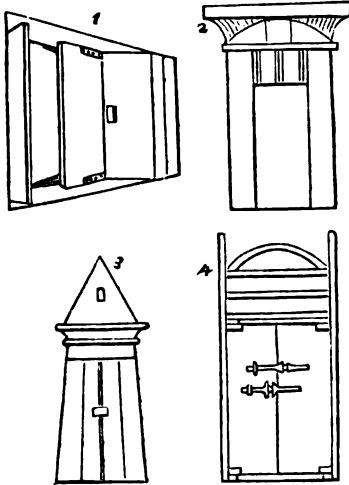

Ancient Egyptian Doors.

the slide; in that case he stood in no absolute need of a key to enter (Cant. v, 4). See KEY. Among the ancient Egyptians doors were frequently stained so as to imitate foreign wood. They were either of one or two valves, turning on pins of metal, and were secured within by bars and bolts. Some of the bronze pins have been discovered in the tombs of Thebes, and two of them, after Wilkinson, are figured below (2, 3). They were fastened to the wood with nails of the same metal. See HINGE. The stone lintels and floor behind the threshold of the tombs and temples still exhibit the holes in which the pins turned, as well as those of the bolts and bars, and the recess for receiving the opening valves. The folding doors had bolts in the centre, sometimes above as well as below; a bar was placed across from one wall to the other, and in many cases they were secured by wooden locks passing over the centre (above cut, fig. 4) at the junction of the two folds. "It is difficult (remarks Sir J. G. Wilkinson) to say if these last were opened by a key, or merely slid backward and forward like a bolt;

wood, and opened by a key furnished with several pins answering to a smaller number that fall down into its hollow movable tongue, into which the key is introduced when they open or fasten the lock." See LOCK. For greater security, they are also occasionally made with a mass of clay. This was also a custom of the ancient Egyptians, as appears from Herodotus (ii, 101) from tombs actually so closed at Thebes, and from the sculptures, as in the first cut above, fig. 3, where the door is thus closed and sealed. To this custom there is an allusion in Job. See CLAY. At a later period, when iron came into general use, keys were made of that metal, of the shape shown in the above cut, fig. 4. Of the kind thus indicated were probably the lock and key which fastened the summer-parlor of King Aha (Judg. iii, 28, 25). In this case Ehud locked the door and took away the key; but when the servants became alarmed they easily opened it with another key, which suggests that the lock, as in ancient Egypt or the modern East, was nothing more than a peculiarly constructed open bolt of wood, which the wooden or metal key was adapted to raise and thrust back. The forms of the Egyptian doors may be seen from the cuts. (See Wilkinson, *Anc. Egypt.* abridgm. i, 7-23.) The chief entrance to houses was through a pyramidal pylon on a projecting porch of columns, whose capitals were often ornamented with ribbons. Over the doorway was sometimes a brief hieroglyphical legend (Wathen, p. 101). This last circumstance reminds one of the writing on their doors recommended to the Israelites, as noticed below. A comparison of the

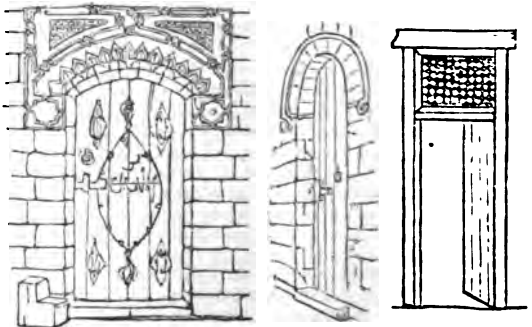

Modern Oriental Street-doors.

cient Egyptian doors with those now used in the East will probably suggest no incorrect notion of the division among the ancient Hebrews in this respect. A sort of intermediate idea arising from this comparison will be found to furnish very satisfactory illustrations of most of the passages of Scripture which relate to the subject. (See Lane's *Mod. Eg.* i, 9, 18.) Doors

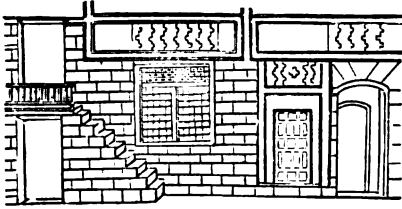

Oriental Door in the Interior Court.

are generally unpainted throughout Western Asia and Egypt. In the interior of houses it is not unusual to see curtains instead of doors, especially in summer. This helps to keep the apartment cool, and also enables servants to enter without noise. This custom originated in the use of tents. Accordingly we find that all the entrances of the tabernacle had curtains, although the framework was of wood (Exod. xxvi, 31-33, 86, 87);



Common Oriental Door.

and even in the Temple a curtain or "vail" formed the separation between the holy and the most holy place. See HOUSE. The word "door," in reference to a tent, expresses the opening made by dispensing with the cloths in front of the tent, which is then supported only by the hinder and middle poles (Gen. xviii, 2; Burckhardt, *Notes on Bed.* i, 42).

Among the figurative allusions to doors, it may be mentioned that, in Hosea ii, 15, the valley of Achor is called "a door of hope," because there, immediately after the execution of Achan, the Lord said to Joshua, "Fear not, neither be dismayed;" and from that time Joshua carried on his conquests with uninterrupted success. Paul, in 1 Cor. xvi, 9; 2 Cor. ii, 12; Col. iv, 1, uses the symbol of a door opened, to signify the free exercise and propagation of the Gospel. Our Lord applies the term to himself, "I am the door" (John x, 9). The "door opened in heaven" signifies the beginning of a new kind of government (Rev. iv, 1); and in general the opening of anything is said when it may act suitably to its quality; the shutting of anything is the stopping of its use (Wemyss, *Symbol. Dict.* v.). See GATE.

DOOR-KEEPER (שַׁרְיָן, *shar'yan*, 1 Chron. xv, 23, 24, *gate-tender*, or "porter," as elsewhere rendered; but in Psa. lxxxviii, 11, שַׁרְיָן, *saphar'yan*, to sit at the threshold; Sept. παραπιστρεῖσθαι; Vulg. *abjectus esse*; Gr.

Συραρός, John xviii, 16, 17; elsewhere likewise "porter"), a person appointed to keep the street-door leading by an alley-way to the interior entrance of an Oriental house (q. v.). This was originally doubtless a male, but in later times, in imitation perhaps of Greek and Roman usages (see Kitto, *Pict. Bible*, note on John i. c.; no such custom, however, appears in classical writers; see Smith's *Dict. of Class. Antiq.* p. 514 b, 527 b), a female janitress or portress often held this post (John xviii, 16; Acts xii, 13). See PORTER. In Psa. lxxxiv, 10, the word "door-keeper" does not convey the proper meaning of the original, because the preference of the Psalmist was evidently given to a very humble situation, whereas that of a door-keeper, in Eastern estimation, is truly respectable and confidential. The gods are always represented as having door-keepers, who were of great dignity and power, as they also fought against other deities. In the heathen temples there are images near the entrance called *kaval kavan*, guards, or door-keepers. See ANUBIS; ASR. Kings and great men, also, have officers whose business it is to stand at the door or gate as keepers of the entrance. The most dignified native of Ceylon is the *maha modeliar* of the governor's gate, to whom all others must make obeisance. The word door-keeper, therefore, does not convey the idea of humility, but of honor. The marginal reading of our version, however, to "sit at the threshold," at once strikes an Eastern mind as a situation of deep humility. See the poor heathen devotee; he goes and sits near the threshold of his temple. Look at the beggar; he sits or prostrates himself at the threshold of the door or gate till he shall have gained his suit. "I am in great trouble; I will go and lie down at the door of the temple." "Friend, you appear to be very ill." "Yes." "Then go and prostrate yourself at the threshold of the temple." The Psalmist therefore probably refers to the attitude of a beggar or suppliant at the threshold of the house of the Lord as being preferable to the splendid dwellings of the wicked. See BEGGAR.

DOOR-KEEPERS (*ostiaris*), in the ancient Church, a class of church officers forming the lowest clerical order. Their duties were to open and close the doors, not only at the termination of religious worship, but during the services, especially after the *missa catechumenorum* (q. v.). In later times, in the Roman Church, their duties became nearly those of the modern sexton, viz. to take care of the church ornaments and vessels, to ring the bell, to sweep the church, etc. The customary forms of ordination are prescribed in the fourth council of Carthage; and the keys were delivered to them by the bishop, with the injunction, "Behave thyself as one who must give account to God of the things that are kept locked under these keys." Their ordinary name was *πυλωποι, ostiarii*, and sometimes *mansuetarii* and *janitores*.—Bingham, *Orig. Eccles.* bk. iii, ch. vi.

DOOR-POST (שַׁרְיָן, *saph*, Ezek. xli, 16, the *pill* or "threshold," as elsewhere usually rendered; שַׁרְיָן, *mashekoph*, Ezek. xli, 7, the *lintel*, as elsewhere rendered). In Deut. vi, 9, Moses enjoined upon the Israelites to write the divine commands upon the posts (שַׁרְיָן, *mezuzoth*, invariably so rendered) of their doors, a practice which is understood literally by the modern Jews (Thomson, *Land and Book*, i, 141). It is at this day customary in Mohammedan Asia for extracts from the Koran, and moral sentences, to be wrought in stucco over doors and gates, and as ornamental scrolls to the interior of apartments. The elegant characters of the Arabian and Persian alphabets, and the good taste with which they are applied in running scrolls, the characters being usually white, raised on a blue ground, and intermixed with gilding, have a very pleasing effect, particularly in interior ornament. This custom must have been very ancient, for Moses

here very evidently alludes to it. We understand the injunction not as imperative upon the Hebrews to write on their doors, but as enjoining them, if they did write at all, to write sentences of the law. He suggests this as a means of inculcating the law upon their children, whence it seems that he took it for granted that the children would be taught to read. "Among us," says Michaelis, "where, by the aid of printing, books are so abundantly multiplied, and may be put into the hands of every child, such measures would be quite superfluous; but if we would enter into the ideas of Moses, we must place ourselves in an age when the book of the law could only come into the hands of a few opulent people." The later Jews have exercised



Modern Jewish Mezuzah.

their usual ingenuity in misunderstanding this injunction. They conceive the observance to be imperative, and they act on it as follows: Their *mezuzoth*, or door-schedules, are slips of parchment, on which are written the passages Deut. vi, 4-9, and xi, 13-20; these slips are rolled up, and on the outside is written the Hebrew word שְׁמַרְתֶּם , *shaddai*, or "the Almighty," one of the names appropriated to God. This roll they put into a reed or hollow cylinder of lead, in which a hole is cut for the word *shaddai* to appear, and the tube is then fastened to the door-post by a nail at each end. As the injunction is in the plural form, they conceive that a *mezuzah* should be placed on every door of a house. It is usually fixed to the right-hand door-post, and those Israelites who wish to be considered particularly devout usually touch or even kiss it as they pass. The Talmud ascribes great merit to having the *mezuzah* fixed on the door-post, and describes it as a preservative from sin. See MEZUZOTH.

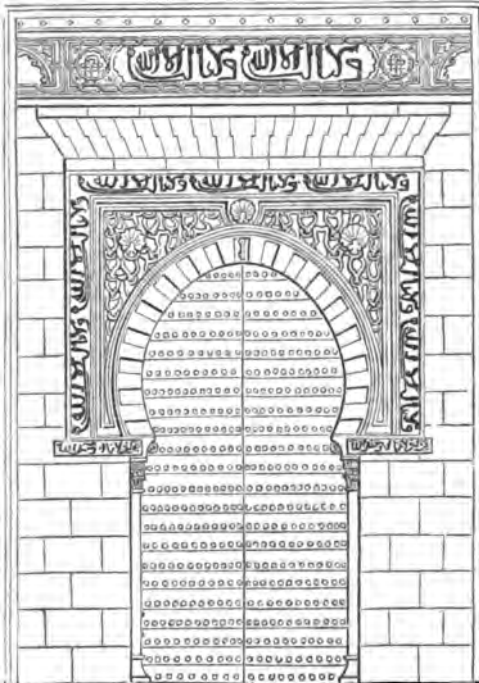

Eastern Door inscribed with Passages from the Koran.

DOORS OF THE CHURCH. To insure secrecy in worship, the ancient Christians constructed the doors of their churches with peculiar care. The early fathers, from this usage, derived abundant metaphors, relating to admission to the church, to heaven, etc. There were generally three principal entrances, in im-

itation of the Jewish Temple. Sometimes the terms *πύλη*, *porta*, and *θύρα*, *janua*, were interchanged; as for the most part, the principal entrance, at the west end, over against the altar, was called, by way of eminence, *πύλη*, and *πύλη ὡραία*, or *βασιλική*. Men and women entered by different doors. The doors were constructed of the most durable wood, or of brass richly ornamented. The date of the building or dedication of the church was usually inscribed on the door. Sometimes the doors bore inscriptions of various kinds of which the following may be taken as a specimen. On the outside,

"*Pax tibi sit, quicumque Dei penetralia Christi
Factor pacifico candidus ingrederis.*"

On the inside,

"*Quisquis ab aede Dei, perfectis ordine votis,
Egrederis, remes corpore, corde manet.*"

It was customary, in early times, to place on the door the names of all excommunicated persons; at a later period, the names of persons intending marriage were posted up in like manner. This was also the place for affixing all proclamations and decisions of the Church, as well as all public notices.—Riddle, *Christian Antiquities*, bk. vi, ch. v, § 6; Coleman, *Christian Antiquities*, ch. ix, § 10.

Doph'kah (Heb. *Dophkah*, דּוֹפְקָה , according to Gesenius, a knocking; accord. to Fürst, cattle-driving; Sept. *Παφακά*, by error of ק for ך ; Vulg. *Dopari*) the eighth place of encampment of the Israelites in coming out of Egypt (Num. xxxiii, 12). It was situated in the desert of Sin, on the eastern shore of the western arm of the Red Sea, probably at the mouth of Wady Feiran. See EXODE. Pococke (*East. i, 25*) thinks it lies east of *Thor*, in Wady Hibran; but this is apparently conjecture. Fürst (*Heb. Hands. i, v, 1*) after Seetzen (*Zach's Correspond. xxvii, 71*), says it is the modern *el-Tobbacha*; by which they apparently mean the *el-Tubukah* mentioned by Dr. Robinson as lying in a very different region (*Res. ii, 388, 640*), and probably identical with the *Tagoba* (q. v.) of early Church writers.

Dor (Heb. id., דּוֹר , a dwelling, but דּוֹר in Josh. xvii, 11; 1 Kings iv, 11; Sept. $\Delta\omega\rho$, but joins with preceding word $\Gamma\epsilon\upsilon$ or $\Gamma\epsilon\upsilon\epsilon$, in Josh. xi, 2 *Nephtoi*; in Josh. xii, 22 [second clause] *Naphathur*, in 1 King iv, 11 *Nephathur*; Vulg. *Dor*; the *Dora*, or *Delta*, of the Apocrypha and Josephus, who, as well as Greek writers, also calls it *Dorus*, $\Delta\omega\rho\sigma$, an ancient royal city of the Canaanites (Josh. xii, 23), whose ruler was an ally of Jabin, king of Hazor, against Joshua (Josh. xi, 1, 2). It was probably the most southern settlement of the Phœnicians (Scylax, p. 42, ascribes it to the Sidonians) on the coast of Syria (*Joseph. Life. p. 8; Ant. xv, 9, 6*). Josephus describes it as a maritime city (*War, i, 21, 6*) on the west border of Manasseh and the north border of Dan (*Ant. v, 1, 22; vii, 2, 3; War, i, 7, 7*), near Mount Carmel (*Ap. ii, 10*). One old author tells us that it was founded by Dorus, a son of Neptune, while another affirms that it was built by the Phœnicians, because the neighboring rocky shore abounded in the small shell-fish from which they got the purple dye (Reland, *Palest. p. 739*). It appears to have been within the territory of the tribe of Asher, though allotted to Manasseh (Josh. xvii, 11; Judg. i, 27). The original inhabitants were never expelled, but during the prosperous reigns of David and Solomon they were made tributary (Judg. i, 27, 28), and the latter monarch stationed at Dor one of his twelve purveyors (1 Kings iv, 11). Reland (*Palest. p. 744*) thinks it is the *Dura* ($\Delta\omega\upsilon\rho\alpha$) mentioned by Polybius (v, 409) as the scene of the victory of Antiochus Epiphanes over Ptolemy Philometor. Tryphon, the murderer of Jonathan Maccabæus and usurper of the throne of Syria, having sought an asylum in Dor, the city was besieged and captured by Antiochus Si-

(1 Macc. xv, 11, 13, 25; Joseph. *Ant.* xiii, 7, 2; i, 2, 2). It was granted the privilege of nomenclature by Pompey (Joseph. *Ant.* xiv, 4, 4; i, 7, 7), and was rebuilt by Gabinius, the Roman, along with Samaria, Ashdod, and other cities destined (Joseph. *Ant.* xiv, 5, 8), and it remained an important place during the early years of the Roman rule in Syria. Its coins are numerous, bearing the legend "Sacred Dora" (Vaillant, *Nouv. Imp.*). It became an episcopal city of the province of *Palæstina Prima*, but was already ruined and deserted in the fourth century (Jerome, in *Epitaph. Paula*). According to Ptolemy (v, 15, 5), it was situated in long. 80°, lat. 32° 40'; according to the *Peutinger Table*, miles from Ptolemais; and according to Eusebius Jerome (*Onomast.* s. v. *Ἀσὺρ τοῦ Ναφάθ*, Dornath), it lay on the coast, "in the ninth mile from area, on the way to Ptolemais." Just at the point cated is the small village of *Tantúra* (or *Tortura*, ocke, ii, 84; Arrievu, ii, 11; Gesenius thinks, *Theor.* p. 331, either form equal to the Arabic for *hill of a*), consisting of about thirty houses, wholly consisted of ancient materials, and inhabited by Mohammedans (Mangles, *Trav.* p. 190; Schwarz, *Palæst.* 77, 91, 149; Thomson, *Land and Book*, ii, 248). One hundred yards north are low rocky mounds protruding into the sea, covered with heaps of rubbish, and fragments of columns. The most conspicuous ruin is a section of an old tower, 80 feet or more in height, which forms the landmark of the town. On the south side of the promontory, opposite the village, is a little harbor, partially sheltered by two or three small islands. A spur of Mount Carl, steep and partially wooded, runs parallel to the east-line, at the distance of about a mile and a half. Between its base and the sandy beach is a rich and fertile plain—this is possibly the "border," "coast," or "region" (ἄκρη, Symmachus *παράλια*) of (Josh. xi, 2; xii, 28; 1 Kings iv, 11). The district is now almost wholly deserted, being exposed to the raids of the wild Bedouins who pasture their flocks in the rich plain of Sharon.—Smith, s. v. See also AMATHÉ-DOR; EN-DOR.

DORÁ (1 Macc. xv, 11, 13, 25). See **DOR**.

DORCAS (Δορκάς, a female *antelope*; explained in the text as equivalent to Syr. דֹּרְכָא, a gazelle, a charitable and pious Christian widow of Joppa, whom Peter restored to life (Acts ix, 36–41). The sacred writer mentions her as "a certain disciple named Tabtha, which by interpretation is called Dorcas," the reason of which probably is that she was a Hellenistic Jewess, and was called *Dorcas* by the Greeks, while to the Jews she was known by the name of **TABITHA** (q. v.). See **GAZELLE**.

DORCAS SOCIETY, "a name given to an association of ladies who collect and dispose of garments with the benevolent object of giving aid to necessitous families. Sometimes the ladies connected with a congregation unite to form a Dorcas society, in order to afford employment to poor needlewomen. Societies of this kind are so called from what is recorded in Acts ix, 39: 'And all the widows stood by him weeping, and showing the coats and garments which Dorcas made while she was with them.'"—Chambers, *Encyclopædia*, s. v.

DORCHESTER, DANIEL, a Methodist Episcopal minister, was born at Vernon, Conn., Jan. 25, 1790. He was drafted for service in the war of 1812, and soon after his term of military duty expired he was licensed to preach. In 1816 he entered the travelling ministry in the New England Conference, and served as minister and presiding elder until his final superannuation in 1850. In 1858 he went to the West; in 1854 was made librarian of the public library and reading-room in Chicago, and died near that city August 6, 1854.

Mr. Dorchester was a man of clear intellect and decided character. He ably defended Methodism in a time when it was "much spoken against." On many of his circuits there were extensive revivals.—*Minutes of Conferences*, v, 512.

DORIS (Δορίς), a Jewess of low descent, the first wife of Herod the Great (Josephus, *Ant.* xiv, 12, 1), by whom she had Antipater (*War*, i, 28, 4); she was expelled from court on account of alleged complicity in the treason of Pheroras (*War*, i, 80, 4).

DORĀ (Δορά), a town whose ancient name and site was discovered by Seetzen from an inscription found by him in the modern village *ed-Dur*, in the region of the Hauran, south of the Lejah, and a little south of Wady Kanamat (Ritter, *Ersk.* xv, 868).

DOROTHĒUS (Δορθῆος, *God-given*), the deputy appointed by Nicanor, the royal steward of Ptolemy Philadelphus, to entertain the seventy learned persons sent from Jerusalem to translate the Old Testament into Greek (Joseph. *Ant.* xii, 2, 12, 13). See **SEPTUAGINT**.

Dorotheus, a presbyter of Antioch, mentioned by Eusebius as "a man of fine taste in sacred literature, who was much devoted to the study of the Hebrew language, so that he read the Hebrew Scriptures with great facility. He also was of a very liberal mind, and not unacquainted with the preparatory studies pursued among the Greeks, but in other respects a eunuch by nature, having been such from his birth; so that the emperor, on this account, as if it were a great miracle, received him into his house and family, and honored him with an appointment over the purple dye establishment of Tyre. Him we have heard in the church expounding the Scriptures with great judgment." As Eusebius says that he flourished under Cyril, who is supposed to have been bishop of Antioch from A.D. 280 to 300, the date of Dorotheus may be given as about A.D. 290.—Eusebius, *Hist. Eccles.* bk. vii, c. 32; Lardner, *Works* (10 vols. 8vo), vol. iii, 159.

Dorotheus of Tyre, supposed to have been bishop of Tyre about A.D. 800. He is said (not by contemporary writers, but by later martyrologists) to have suffered greatly in the persecutions under Dioclesian, and to have suffered martyrdom under Julian, A.D. 363. There is extant under his name a *Synopsis de vita et morte Prophetarum, Apostolorum, et Discipulorum Domini* (given in *Biblioth. Max. Patrum*, iii, 421). "It is now generally allowed to be fabulous, and of little or no value."—Lardner, *Works* (10 vols. 8vo), iii, 161; Fabricius, *Bibl. Græca* (edition Harles), vii, 452; Cave, *Hist. Lit.* (Geneva, 1720), i, 103; Oudin, *Script. Eccles.* i, 1877.

Dorotheus, bishop of Marcianople, in Mœsia, in the fifth century, was a strong advocate of Nestorianism. He pronounced anathema against all who asserted that Mary was the mother of God. He attended, as a bishop, the Council of Epheesus (opened June 22, 431), which denounced the Nestorians as schismatics; and he was banished to Cappadocia by order of the emperor Theodosius. Four letters of his are preserved in the collection of P. Lupus, entitled *Ad Ephestianum Concilium variorum Patrum Epistolæ* (Louv. 1682, 2 vols. 4to).—Cave, *Hist. Lit.* (Genev. 1720), i, 269.

Dorotheus, archimandrite of Palestine, 7th century, a disciple of Joannes the Abbot, wrote *Διδασκαλικά διάφορα, Doctrina Diversæ*, given (Gr. and Lat.) in Migne, *Patrologia Græca*, 88, p. 1611 sq., and in the other great collections of the fathers. See Fabricius, *Bibliotheca Græca* (ed. Harles), xi, 103 sq.; Cave, *Hist. Lit.* (Genev. 1720), i, 878.

DORSCHÉ, JOHANN GEORG, a Lutheran theologian, was born at Strasburg, Nov. 18, 1597; became professor of theology at Strasburg in 1627, and was called to the same chair at Rostock in 1654. He died January 25, 1659. Dorsche (Latin form *Dorscheus*) was a voluminous writer in theology and Biblical literature.

Among his works are *Dissertationes Theologicae* (8d ed. Frankf. 1698, 4to):—*Biblia Numerata* (Frankf. 1674, fol.):—*Commentarius in quat. Evangelistas* (Hamburg, 1706, 4to):—*Comm. in Ep. Pauli ad Hebraeos* (Frankf. 1717, 4to):—*Fragment. Comm. in Ep. Juda.* with Gebhardt, *Comm. in Ep. Juda.* (Frankfort and Leips. 1700, 4to).—Winer, *Theol. Literatur*, ii, 495; Kitto, *Cyclopaedia*, i, 696.

Dort, Synod of (SYNODUS DORDRACENA), a national synod of the United Provinces, held at Dort (Dordrecht; Lat. *Dordracum*) in 1618-19.

I. *Origin of the Synod.*—The opposition of James Arminius to the Augustinian and Calvinistic doctrines on predestination gave rise to a bitter controversy, for an account of which, see ARMINIANISM. After the death of Arminius († 1609), the strife increased, and with added bitterness. The clergy and laity of Holland were arrayed in two hostile armies—Gomarists and Arminians, the former being the most numerous, but the latter including the leading scholars and statesmen. In 1610 the Arminians presented a petition to the States of Holland and West Friesland, which was called a "Remonstrance" (*Remonstrantia, libellus supplicis adhibitus Hollandiae et West Frisiae ordinibus*). They were named REMONSTRANTS (q. v.) in consequence; and, as the Calvinists presented a "Counter-Remonstrance," they were called Counter-Remonstrants. The "Remonstrance" sets forth the Arminian theory over against the Calvinistic in five articles (for which, see ARMINIANISM). Attempts were made by the authorities to reconcile the two contending parties by a conference between them at the Hague in 1611, a discussion at Delft in 1613, and also by an edict in 1614, enjoining peace. The Remonstrants desired a provincial synod for the province of Holland, where the two parties were nearly equal in numbers and influence; or else a general synod of all Protestant Christendom, to which Lutherans as well as Reformed should be summoned. Grotius, especially (1617), argued in favor of a general Protestant council.

Unfortunately, political interests aided to increase the difficulty. The great patriots and statesmen, Grotius and Barneveldt, were advocates of toleration for all opinions, and the former was also one of the literary pillars of the Remonstrant party. The stadholder, Maurice of Nassau, was a great soldier, but a narrow and ambitious politician. The pensionary Barneveldt succeeded, against the wishes of Maurice, in obtaining, in 1609, a twelve-years' truce with Spain, and for years held Maurice in check in his attempts to secure for himself and his family a hereditary sovereignty over the States. Maurice, though himself said to have been an Arminian in sentiment, placed himself at the head of the Gomarists, who constituted the majority of the clergy and people; while the leading statesmen and patriots, as has been said, were on the other side. One of his measures was to change the municipalities of the cities wherever the Arminians were in power, and to substitute Calvinistic burgo-masters and governors. Another was to imbue the popular mind with the belief that Barneveldt, Grotius, and the Arminians were secretly aiming to deliver the country up to Spain. By means of the changes thus effected, the States-General came finally to be strongly in favor of Maurice, and willing to carry out all his measures, whether political or religious.

James I of England was greatly interested, on political grounds, in the peace and prosperity of the United Provinces. Moreover, his pride and pedantry were involved in securing the condemnation of Vorstius, who had been elected to fill the chair of Arminius, and who was charged with Socinianism. See VORSTIUS. In 1613 (March 6) he wrote an autograph letter to the States-General, urging that the difficult question of predestination should be kept out of the

pulpit, and that there should be "mutual toleration, especially as the "opinions of neither party were consistent with Christian truth and with the saving of souls" (*Epist. Praes. et Erudit. eorum*, Amst. 1614, p. 393). But on the 20th of March, 1616, he went again to the States-General, urging that the "idle and pestilent opinions" should be put down and a national synod could be summoned to decide and settle the question (see the letter in *Epist. Praes. supra*, p. 490. See also the reply of the [Arminian] States of Holland to king James, in the same collection of letters, p. 492).

The States of Zealand, Friesland, Groningen and Guelderland demanded a national synod. The States of Utrecht, Holland, and Overijssel were opposed to it, although some of their chief cities (e. g. Amsterdam) favored it. The States, under the guidance of Maurice, resolved, Nov. 11, 1617, to convocate a national synod, to be held May 1 the following year. All opposition to the convocation was at last forcibly put down by the arrest and imprisonment of the great leaders of the Arminians—Barneveldt, Grotius, and Hogerbeets (Gieseler, *Ecc. Hist.*, ed. by Smith, vi, iv, § 43)—who maintained, in advance of their time, the doctrine that the State had no right to interfere in questions of religious doctrine, and therefore had a right to order a national synod whose decisions should be authoritative. Opposition in various quarters called a further decree of the States that the national synod should be summoned for Nov. 1, 1618, for the time and at Dordrecht for the place. Letters of the States-General, dated June 25, 1618, invited the Reformed churches of England, France, the Palatinate, Hess. Switzerland, Bremen, Embden, Brandenburg, Geneva, and Nassau to send as delegates some of their members to aid the deputies of the Belgic churches in "settling the controversies." The Reformed Church of Anhalt was not invited, nor were the Lutheran churches. The aim of the States-General was to constitute a body holding Calvinistic views on the points in dispute. The British deputies were George Carlton, bishop of Llandaff; John Davenant, professor of theology at Cambridge; Samuel Ward, of Sidney College, Cambridge; and Joseph Hall, afterwards bishop of Norwich. These took their seats at the beginning of the synod; but Dr. Hall returned to England on account of sickness, and was replaced by Thomas Good, of St. Paul's, London. Walter Balcanquhall, a Scotch presbyter, was also deputed by king James to represent the Scottish Church. He wrote minutes which are published with Hales's Letters, mentioned below. John Hales, of Eton, "the ever-memorable," was the chaplain to Sir Guy Carlton, English ambassador at the Hague, and in that capacity attended many of the sessions, taking minutes, which he regularly transmitted to the ambassador. These minutes are to be found in Hales's *Golden Remains*.

II. *Organization of the Synod.*—The States-General ordered the delegates to the synod to be chosen as follows. Each province was to call a provincial synod from which six persons, of whom three or four should be pastors, were to be chosen as delegates to the synod. Holland and Utrecht, in which the Arminians were numerous, were excepted from this provision. It was ordered that the provincial synod of Holland should be made up of four ordinary delegates from each Classis in which no separation on account of the dispute had taken place; while each Classis in which such separation had taken place should send two Calvinists and two Arminians. The provincial synod, thus constituted, was to select its delegates to the national synod. In Utrecht and South Holland several Arminians & vines (among them Uitenbogaert) were deposed from the ministry before the selection of delegates was allowed. Nevertheless, three of the delegates from Utrecht were Arminians, and "they were the only Arminians who had seats in the synod." They ven-

red to sit on condition "that while the affairs of Remonstrants were under discussion they should disturb the proceedings of the synod by unseasonable interruptions, and not acquaint their party with anything done or said in the synod which concerned their cause." These three, moreover, did not remain in the synod.

The synod, when organized, consisted, first, of the deputies from the States, who properly constituted the general synod, viz. 89 ministers, 5 professors, and 18 lay elders; and, secondly, of 24 foreign divines. The States-General were represented by lay commissioners, of whom Daniel Heinsius was secretary. The Protestant kingdom in Europe that sent deputies to the synod was Great Britain. Besides these, and divines of the United Provinces, there were delegates from Switzerland, the Palatinate, Hesse, Wetuu, Emden, and Bremen. The Lutheran churches were not represented. No delegates from France were present, as Louis XIII forbade Rivet and Duulin, who were chosen as deputies by the French Protestants, to attend.

This synod was, therefore, not a council of the Protestant churches of Europe, nor even of the Reformed Church of Europe, but a Dutch national synod, to which Reformed theologians were invited from various parts of Europe. "Whosoever casts his eye over the list of the foreign divines that composed this last Protestant councils will find scarcely one man who did not distinguish himself by his decided opposition to the doctrine of conditional predestination, and who was not consequently disqualified from acting the part of an impartial judge of the existing religious differences, or that of a peace-maker."

III. *Acts of the Synod.*—The synod was opened Nov. 18, 1618, with public worship in the church of Dort. At the second session, John Bogermann, a pastor in Friesland, was chosen president, with Jacobus Rolandus, of Amsterdam, and Herman Fankelius, of Middleburg, as assistants, or vice-presidents. Sebastian Dammann, of Zutphen, and Festus Hommius, of Leyden, were appointed secretaries. We cannot go into detail as to the course of procedure; the sources of information are announced at the end of this article. A summary account, from the Calvinistic point of view, may be found in Dr. Miller's *Introductory Essay to Scott's Synod of Dort* (Presbyt. Board of Publication); and another, from the Arminian point of view, in Watson, *Theological Dictionary*, s. v. Dort (chiefly taken from Nichols, *Protestantism and Arminianism*). The following short statement is partly from the sources just named, and partly translated from Heppel, in Herzog's *Real-Encyclopädie*, iii, 486 sq.

At the third session the credentials of the deputies were received. In the fourth it was ordered that Episcopius and twelve other Remonstrants should be cited to appear in a fortnight to state and defend their views. "In the mean time the Remonstrants, without knowing the resolution of the synod, had deputed three of their body from Leyden, to obtain leave for their appearance at the synod, in a competent number and under safe-conduct, to defend their cause. On making their request known to the lay commissioners, they were informed of the resolution which had passed the synod only the preceding day. To which they replied that it was unreasonable to cite those to justify themselves who were both ready and willing to come of their own accord; and that, if they persisted in proceeding with their plan of citation, they would by that act furnish just cause, not only to them, but to all good men, to entertain strange notions and suspicions of the synodical proceedings. Not being permitted to choose those men from their own body whom they deemed the best qualified to state and defend their cause, they accounted it an additional hardship that their enemies should assume that unlawful authority to themselves. But neither at that time nor afterward, when they

wished to add two of the most accomplished of the brethren to their number, were their representations successful."

During this fortnight the synod considered various matters apart from the Remonstrant question, ordered the preparation of a new version of the Bible, ordained rules for catechization, and prepared instructions for the Dutch missionaries in the East Indies, etc.

At the twenty-second session the Remonstrants appeared, with Episcopius at their head. After some delay, Episcopius defended the Arminian doctrine in a discourse which produced a profound impression. Disputes arose in subsequent sessions as to the topics to be treated, and the order in which they should be taken up. In the session of December 10 the Remonstrants gave great offence by reading a document from the pen of Episcopius, in which it was declared that "the Remonstrants did not own the members of the synod for lawful judges, because the great majority of them, with the exception of the foreign divines, were their professed enemies; and that most of the inland divines then assembled, as well as those whose representatives they were, had been guilty of the unhappy schism which was made in the churches of Holland. The second part contained the twelve qualifications of which the Remonstrants thought a well-constituted synod should consist. The observance of the stipulations proposed in it they would gladly have obtained from the synod, averring that they were exceedingly equitable, and that the Protestants had offered similar conditions for the guidance of the Papists, and the Calvinists for the direction of the Lutherans." On January 14 the Remonstrants were dismissed from the synod. Their views, as gathered from their own writings, were subsequently passed upon and condemned.

The doctrinal discussion in the synod showed that its members were not so fully at one in their positive views of doctrine as in their opposition to Arminianism. The question whether, according to Ephes. i, 4, Christ is the ground of election (*fundamentum electionis*), gave rise to strong debates, the Anglicans and the Germans taking the affirmative, while other deputies, in view of the divine decree, maintained the negative; the Melancthonian element was obviously not yet uprooted. It was found difficult at last to harmonize the various views of election in one formula. The deputies from Hesse, Bremen, Nassau, and England seemed to favor a doctrine on the extent of the atonement similar to Baxter's so-called Universalism. See ATONEMENT. The *Canones Synodici* (sess. 186, April 28, 1618) set forth clearly the doctrine of predestination, but not in the supralapsarian sense.

After the condemnation of the Arminian tenets, it remained to punish those who upheld them. The Hessians and Anglicans opposed the infliction of personal penalties. Nevertheless, the synod "deposed the Arminian ministers, excluded them and their followers from the communion of the Church, suppressed their religious assemblies, and, by the aid of the civil government, which confirmed all their acts, sent a number of the clergy of that party, and of those who adhered to them, into banishment" (Miller, *Introductory Essay to Scott's Synod of Dort*, p. 29).

In the later sessions the Heidelberg Catechism and the Belgic Confession were adopted as orthodox statements of doctrine, in full harmony with the Word of God. In the 144th session the synod read before a large concourse, in the great church of Dort, the *Canon* on the five articles, and the *Censura Ecclesiastica* passed against the Remonstrants. The 164th and last session was held on May 9. Five days after (May 14) the great Barneveldt was beheaded at the Hague.

Fabricius, *Bibliotheca Græca*, xi, 723 (Hamb. 1705, 14 vols.), gives an account of the Synod of Dort, from which we extract the following statement (translated by Nichols) as to the publication of its *Acta* (Journals). "For the publication of the Acts, the divines chosen out

of various districts of the United Provinces were John Polyander, Anthony Walsens, Anthony Thysius, Daniel Heinsius, Festus Hommius, Daniel Colonius, and John Laets. But Dr. Wm. Bates informs us, in his *Life of A. Walsens*, that the 'chief merit of the publication is due to Festus Hommius, who was a ready and elegant writer, and, as secretary to the synod, had noted with greater diligence than the others the matters that had been transacted.' These Acts were published at Dort in the year 1620, in folio, in the neat types of Elzevirs at Leyden, and were soon afterwards executed with greater correctness, in the same year, at Hanover, in quarto, with the addition of a copious index. Prefixed to the Acts stand the epistle of their high mightinesses the States-General, addressed to the monarchs and kings, to the princes, courts, cities, and magistrates (of the Christian world), and vouching for the fidelity and authority of these Acts; and likewise the ample preface of Daniel Heinsius, addressed to the Reformed churches of Christ, concerning the origin and increase of the Dutch controversies, for the purpose of appeasing which the synod had been convened. The Acts themselves consist of three parts: (1.) The rules for holding the synod; the form of the synodical oath; decrees and judgments concerning the translation of the Bible, catechising candidates for the sacred ministry, and concerning the removal of the abuses of printing; the canons against the five points of the Remonstrants; the Confession of the Dutch churches; the approbation of the Palatine Catechism; the judgment passed on the doctrine of Conrad Vorstius; a writing of the Remonstrants respecting the conditions on which the synod ought to be held; the theses of the Remonstrants on the five points, and the various exceptions and protestations against the synod; a writing by Simon Episcopius, in which he defends himself; the confession of the two brothers Geistereen; and, lastly, the orations of those very celebrated men, Balthasar Lydius, Martin Gregory, Joseph Hall, John Polyander, John Aconius, and of the memorable Episcopius. (2.) The judgments of the foreign divines on the five points of the Remonstrants. (3.) The judgments of the Dutch divines on the same points."

The *Canons of Doctrine* are given under five heads: I. Of predestination, 18 articles. II. Of the death of Christ, and of the redemption of men thereby, 9 articles. III and IV. Of man's corruption, and of his conversion, 17 articles. V. Of the perseverance of the saints, 15 articles. They may be found, in English, in *Scott's Synod of Dort*, and in the *Constitution of the Reformed Dutch Church* (Philadel. 1840, Appendix, p. 72 sq.). They were officially received by Holland, France, the Palatinate, and Switzerland, but were merely countenanced by England and Brandenburg. The English Church afterwards "rejected the decisions of the synod, and a royal mandate of James I, who favored Arminianism as strongly in his later years as he had favored Calvinism before, in 1622, forbade the preaching of the doctrine of predestination" (Shedd, *History of Doctrine*, ii, 477; Neal, *History of the Puritans*, Harpers' ed., i, 272). The Reformed churches of other countries did not consider them as binding. They received legal authority in no other country but France. The divines of Bremen were very moderate at the synod, and afterwards, headed by Martinus, they rejected its decisions. Martinus wrote: "O Dort, Dort, would to God I had never seen thee." Hales, of Eton, was converted from Calvinism to Arminianism at the synod. See HALES.

IV. No Church council has given rise to more bitter controversy than the Synod of Dort. Arminian writers have denounced it in the strongest language as unworthy the name of a Christian synod, while, on the other hand, Calvinistic writers have extolled its fairness and impartiality. All depends upon the point of view, and upon the notion of the true purpose of the synod which is adopted. If this celebrated as-

sembly is conceived as a deliberative body, designed for the discussion of the five points of theology in question, then all that the Arminians have said of it will be well deserved. If, on the other hand, it be conceived as a body of divines holding Calvinistic views, believing those views to be true, and called for the purpose of condemning and prohibiting the contrary opinions in the Belgic churches, the course of the synod was consistent throughout. And this we believe to be the true view. It was not a free assembly for the discussion of controverted points in theology, or a national ecclesiastical court for the trial of alleged heretics. The judgment of Moses Stuart will probably be generally acquiesced in: "That the Synod of Dort should have been highly celebrated by these contemporaries who sympathized with it in feeling and doctrine, was natural. Hence we find that, on the other hand, it has been eulogized as the most perfect of ecclesiastical councils that have ever been held: but a one might also expect, on the other hand, its opponents have been more loud, if possible, in their complaints than its friends in their praises. A deep sense of injury and persecution of course remained in the minds of the Remonstrants, and of all who sympathized with them; and this feeling was greatly aggravated by the appeal made to the civil power to carry into execution the decrees of the synod, by imprisonment, by imprisonment, and by fine. Both parties undoubtedly went too far in their praise of their blame. The *Expositio* of the synod is unquestionably an able paper; yet I cannot see that, compared with other declarations of the like nature, it calls for any very extravagant eulogy. Certainly the Westminster Confession is superior, as a whole. Men of great talent, much learning, warm piety, and well-meaning intentions belonged, no doubt, to the Council of Dort, and perhaps an unusual number of such men; but a one of them has ever been so distinguished as a theologian and a writer as many other men who can be easily named among the Reformed churches. The measures of force which the spirit of dispute of the day urged them to take were mingled with a hurtful tendency, and against the true spirit of prudence and Protestantism, I suppose no one in our time and in our country will venture to call in question. But, at the same time, their opponents were more concerned in the blame of these measures than they were willing to allow. They were violent, heated, arrogant, contemptuous. They felt a deep sense of injury, and they gave vent to it in no very measured terms. They had reason to complain that the principles of religious liberty were violated in respect to them: but their opponents might well complain also that the principle of Christian moderation, and lenity of manner, and respect for differing sentiments, had not frequently been violated on the part of the Remonstrants. Nor can there be any room to doubt that if the latter had been the dominant party they would have taken as effectual measures to carry their cause as the Gomarists did, although, perhaps, not in the same way" (*American Biblical Repository*, i, 258).

Literature.—The official Acts—*Acta Synodi Nationalis Dordrechtii habitæ* (1620, 4to); soon translated into Dutch, also into French, *Les Actes de la Synode de Dort* (Leyden, 1624, 4to); *Judicium Synodi Nationalis Belgicæ Eccles. Belg. habit. Dordrechtii* (Dort, 1619, 4to); translated into English by Bill, 1619); Remonstrant collection of minutes—*Acta et Scripta Synodalia Dordrechtii Ministrorum Remonstrantium* (Harderwick, 1620, 8vo); Hales, of Eton, *Letters*, in his *Golden Remains* (London, 1678, 4to); translated into Latin, with notes and additions, by Mosheim, *Historia Concilii Dordrechtii* (Hamburg, 1724); Balcanqual's *Letters*; the account in *Epistolæ Præstant. ac Erudit. Virorum* (Amst. 1690, p. 512 sq.); and many letters of that collection; Hales's and Balcanqual's *Letters*, in German, by D. Hartzeck (Leipzig, 1672, 12mo); G. Brandt (Remonstrant), *Historie*

ormatis (Amsterd. and Rotterd. 1668-1704, 4 vols.; incl. into English by Chamberlayne, Lond. 1720-28, 6 vols. fol.; also abridged, 1725, 2 vols. 8vo.); Leyker (Calvinist), *Eere van de Nationale Synode van d'regt* (2 parts, Amst. 1705-1707, 4to), a reply to G. indt; to which reply his son, Joh. Brandt, replied *Verantwoording van de historie van G. Brandt* (Amst. 5); *Letters of the Hessian Delegates* (Literar. Delegationum), ed. by Heppel, in *Zeitschrift für historische Theologie*, xxiii, 226 sq.; Neal, *History of the Puritans*, pt. ii, ch. ii; Collier, *Ecclesiastical History Great Britain* (Lond. 1841, vii, 404 sq.); Nichols, *Unitarianism and Arminianism* (Lond. 1824, 2 vols. 8vo.), xliii, and ii, 576 sq.; Mosheim, *Ecclesiastical History*, cent. xvii, sec. ii, pt. ii, ch. iii; Gieseler, *Ch. Hist.*, Smith, iv, § 48; Schröckh, *Kirchengeschichte seit Reformation*, v, 246 sq.; Scott, *Articles of the Synod Dort*, transl. with notes (Phila. Presb. Board: severely reviewed in Nichols, *Calvinism and Arminianism*, vol. i; favorably reviewed in *Christian Observer*, iii, 794, and in *Spirit of the Pilgrims*, iv, 256). The *Notes of Doctrine*, in Latin, are given in the *Syllabus confessionum* (Oxon. 1804, p. 364 sq.); in Niemeyer, *Uctio Confessionum* (1840, p. 690); in Augusti, *Corpus Librorum Symbolicorum* (Elberfeld, 1827, p. 198-0); in English, in Scott's *Synod of Dort*, cited above; and in the Appendix to the *Constitution of the Reformed Church* (Phila. 1840, 18mo); and in Hall, *Harmony of the Protestant Confessions* (Lond. 1842, p. 589). See also Gass, *Geschichte der protestantischen dogmatik*, i, bk. ii and iii; Cunningham, *Reformers and Theology of the Reformation*, Essay vii; Cunningham, *Historical Theology*, ch. xxv, § 1, 2; and the articles ARMINIANISM; EPISCOPIUS; GROTIUS; VORSIUS; REMONSTRANTS.

Dortus (Δόρτος), a leading Jew, charged before Quadratus, president of Syria, with inciting his countrymen to revolt against the Romans (Josephus, *Ant.* x, 6, 2).

Dorym'ènes (Δορυμίνης), father of Ptolemy, unnamed Macron (1 Macc. iii, 88; 2 Macc. iv, 45), is this Ptolemy was in the service of Ptolemy Philometor, king of Egypt, before he deserted to Antiochus Epiphanes, it is possible that his father is the same Dorymenes who fought against Antiochus the Great (Polyb. v, 61).

Dositheans. See DOSITHEUS.

Dosithe'us (Δοσίθεος), the name of several men in the Apocrypha.

1. "A priest and Levite," who, according to the apocryphal additions to the book of Esther, carried the letter of Mordecai respecting the feast of Purim to Egypt (*Esth.* xi, 1, 2). It is scarcely likely that he is identical with the Dositheus who is mentioned by Josephus (*Ap.* ii, 5) as one of the "commanders of the forces" of Ptolemy VI Philometor, though he probably lived in the reign of that monarch. Josephus also speaks of a Dositheus who betrayed to Herod a hostile letter of Hyrcanus (*Ant.* xv, 6, 2).

2. One of the generals of Judas Maccabæus (2 Macc. xii, 19, 24).

3. A cavalry soldier in the army of Judas Maccabæus, of the company of Bacenor (2 Macc. xii, 35).

4. A renegade Jew in the camp of Ptolemy Philometor (3 Macc. i, 8).

Dositheus, a Samaritan, in the first century, who claimed to be Messiah, or the prophet promised in Deut. xviii, 18. The Church fathers ascribe to him peculiarly many doctrines which had always been held by the Samaritans. He was chiefly distinguished by an ascetic life, and an over-scrupulous observance of the Sabbath (Origen, *De princ.* iv, c. 17: Quo quique corporis situ in principio sabbathi inventus fuerit, in eo ad vesperum usque ipsi permanendum esse), which originated evidently in a verbal interpretation of Exod. xvi, 29. As late as the year 588 the followers

of Dositheus were engaged in a controversy with the other Samaritans concerning the passage, Deut. xviii, 18 (*Eulogius ap. Phot. bibl. cod.* p. 280; Gieseler, *Ch. History*, i, § 18). Instead of being included in the class of heretics, he ought to be classed among those lunatics who have fancied themselves divine messengers. His impious claims caused an order from the Samaritan high-priest for his apprehension; and Dositheus took refuge in a cave, where he is said to have starved to death (Epiphanius, *Hæres.* xiii, cited by Mosheim, *Hist. Comment.* N. Y. 1851, i, 240 note).

Dositheus, the founder of the Russian sect called after him Dositheowschtschins. He taught that it was sufficient to confess one's sins and to receive the Lord's Supper once every ten years, and at the close of one's life.—*Allgem. Real-Encyclop.* iv, 817.

Dositheus, Greek patriarch of Jerusalem. He assembled, in 1672, a synod at Jerusalem for the purpose of rooting out Calvinism, which, in his opinion, had been introduced into the Greek Church by the patriarch Cyril Lucaris. He died in 1706.—*Allgem. Real-Encyclop.* iv, 817.

Do'thaim (Judith iv, 6). See DOTHAN.

Do'than (Heb. *Dothan*, דֹּתָן, contracted for דֹּתָן, two cisterns, which occurs with ת directive, *Dotha'genah*, דֹּתָן גֵּנָה, "to Dathan," Gen. xxxvii, 17 [first clause]; Sept. *Δωδαίτη* and *Δωδαίτη*, the latter in Judith; Vulg. *Dothain*), the place where Joseph found his brethren, who had wandered thither with their flocks from Shechem, and where he was treacherously sold by them to the Ishmaelites (Gen. xxxvii, 17). It next appears as the residence of Elisha, and the scene of a remarkable vision of horses and chariots of fire surrounding "the mountain" (דֹּתָן) on which the city stood, while the Syrians were smitten with blindness at the word of Elisha (2 Kings vi, 18). It is not again mentioned in the O. T. (Reland, *Palest.* p. 739); but later still we encounter it—then evidently well known—as a landmark in the account of Holofernes's campaign against Bethulia (Judith iv, 6; vi, 8, 18; viii, 3). In the Vat., and Alex., and Vulg. text—it is also mentioned in Judith iii, 9, where the A. V. has "Judæa" (*Ioudaia* for *Dwraia*). This passage was a great puzzle to the old geographers, not only from the corrupt reading, *Ioudaia*, but also from the expression, still found in the text, *τὸ πρὸς τὸ μέγαλον*; A. V. "the great strait;" literally, "the great saw." The knot was cut by Reland, who conjectured most ingeniously that *πρὸς* was the translation of מִצְרַיִם, *Masor*—a saw, which was a corruption of מִצְרַיִם, *Mishor*—"the plain" (*Palest.* p. 742 sq.). All these passages testify to its situation being in the centre of the country, near the southern edge of the great plain of Esdraelon. Dothan is placed by Eusebius and Jerome twelve Roman miles north of Sebaste, or Samaria (*Onomast.* s. v. *Δωδαίτη*, Dothaim). The well into which Joseph was cast by his brothers, and consequently the site of Dothan, has, however, been placed by tradition in a very distant quarter, namely, about three miles south-east from Safed, where there is a khan called *Khan Jubb Yunuf*, the Khan of Joseph's Pit, because the well connected with it has long passed among Christians and Moslems for the well in question (Robinson, *Res.* iii, 317). The true site of Dothan was known to the Jewish traveller Rabbi ha-Parchi, A. D. 1300 (see Zunz's extracts in notes to Benjamin of Tudela, Asher's ed. ii, 484), and to Schwarz, A. D. 1845 (*Palest.* p. 168); but neither of these travellers gives any account of the site. It was accidentally discovered in 1852 by Van de Velde (*Narrative*, i, 364-369). Dr. Robinson, in his last visit to Palestine, likewise identified the true site of Dothan in the modern name *Dothain*, a place which he found in the middle of a beautiful plain extending south-westerly from

Kefr Kûd (Capharcotia) to Attil, south-east of Lejjûn. He thus speaks of it: "It is now a fine green *tell* (knoll), with a fountain on its southern base, corresponding entirely to the position assigned to it by Eusebius. We were told at Ya'bad that the great road from Beisân and Zer'in to Rameh and Egypt still leads through this plain, entering it west of Jenin, passing near Kefr Kûd, and bending south-westward around Ya'bad to the western plain. It is easy to see, therefore, that the Midianites, to whom Joseph was sold in Dothan, had crossed the Jordan at Beisân, and were proceeding to Egypt along the ordinary road. It is obvious, too, that Joseph's brethren well knew the best places for pasturage. They had exhausted that of the Mukna by Shechem (Nâblus), and had afterwards repaired to the still finer pastures here around Dothan" (*Bibliotheca Sacra*, 1858, p. 122, 123).

Doty, ELIHU, was born in 1812, graduated at Rutgers College in 1835, and from the Theological Seminary of the Reformed Dutch Church, New Brunswick, N. J., in 1836, and was licensed and ordained as a missionary to the heathen in the same year. He was a member of the first mission sent by the Reformed Dutch Church and the American Board of Commissioners for Foreign Missions to Java, where he labored from 1836 to 1840, when he was transferred to Borneo, and labored among the Dyaks until 1844. Thence he was removed to China, and was connected with the Amoy Mission until his decease, which occurred at sea on his return from China in March, 1865, but four days before the arrival of the ship at New York. Mr. Doty was an excellent Chinese scholar and preacher; an indefatigable, courageous, self-denying laborer; a man of singular frankness, piety, and zeal; and was closely identified with the celebrated mission at Amoy from its origin, and through all the steps of its remarkable success. Few men have surpassed him in the toils and faithfulness of an evangelist. For years he was regarded as the father of what has been termed "the model mission" of the American Board and of the Reformed Dutch Church.

Douai, or **Douay**, a town in France, of the Department of Nord; it formerly belonged to Flanders. Philip II, in 1561, founded a university here after the model of that of Louvain. In 1568 a Jesuits' college was founded in connection with the university by Jean Lenteuilleur, head of the neighboring abbey of Auchin, who devoted part of the revenues of the abbey to the support of the college, which soon became very powerful. Cardinal William Allen (q. v.) established also a college at Douai for the education of Roman Catholic English youth.—Ranke, *History of the Papacy*, bk. vi. For the *Douai Bible*, see **VERSIONS**.

Double (represented by several Heb. and Greek words) has many significations in Scripture. "A double garment" (Exod. xxxix. 9) may mean a lined habit, such as the high-priest's pectoral, or a complete habit or suit of clothes, a cloak and a tunic, etc. **Double heart**, **double tongue**, **double mind**, are opposed to a simple, honest, sincere heart, tongue, mind, etc. **Double**, the counterpart to a quantity, to a space, to a measure, etc., which is proposed as the exemplar. "Double money"—the same value as before, with an equal value added to it (Gen. xliii, 12, 15). If a stolen ox or sheep be found, the thief shall restore double, that is, two oxen or two sheep. For the right understanding of Isa. xl. 2, "She hath received of the Lord's hand double for all her sins," read the *counterpart*, that which fits, the commensurate quantity, extent, or number of her sins; that which is adequate, all things considered, as a dispensation of punishment. This passage does not mean twice as much as had been deserved, double what was just, but the fair, commensurate, adequate retribution. The same is the meaning of this phrase in other places (Isa. lxi, 7; Jer. xvi, 18; xvii, 18.—Calmet, s. v.

DOUBLE SENSE OF SCRIPTURE. In certain pathetic passages there is a double import or twofold application, a lower and a higher, a nearer and a more remote. The former relates to the present and immediate, while the latter usually refers to the Messianic period and spiritual deliverance. This distinction, however, has been contested by many. It is undeniable that several of the fathers maintained the so-called *double sense* of prophecy, particularly Theodoret of Iustetia; and there is little doubt that numbers in later times have rejected it on account of the unfortunate appellation. *Twofold reference* would be a more appropriate; but the name is of little consequence. A recent writer asks, "How could such positions form part of a *revelation* when, after we have ascertained their meaning, we are still left as ignorant as ever of their import, since under these words another deeper meaning still lies hidden? Besides, how and upon what principle, can we ever be sure that we have arrived at the true secondary meaning, or that we have perfectly exhausted the burden of these passages, or that our work as commentators is accomplished? There may be a third, fourth, fifth, or six the Rabbis maintain—seventy meanings lurking all deeper under these very words" (Wolfe, *Messiah in the Psalms*, p. lxxiv). But neither the single nor the double sense of prophecy can justly be argued on *priori* grounds. Thus Arnold (*Sermons*, i, 42) tries to show that "a double sense appears to be a necessary condition of the very idea and definition of prophecy, as having, so to speak, a human as well as a divine author." This language applies to all inspired composition, and would therefore imply a double sense in all Scripture. The true and only philosophical method is to consider the actual phenomena of prophecy as they lie before us in the Scriptures, and see whether the one-sense theory meets all the exigencies in every case.

At the outset it is proper to deny that the theory of double-sense rests wholly upon the construction put upon the formulae by which the N.-T. writers frequently introduce the quotations from the O. T., e. g. Mat. i, 22, *iva πληρωσθῆ*, "that it might be fulfilled," as the like (Wolfe, p. lxxvi). See **FULFIL**. The basis of this method of interpretation lies far broader and deeper than this; it is founded in part on the specific character of the O.-T. institutions, and on symbolical transactions and teachings; it is derived from the language of many individual passages, which is both historical and hyperbolic; it is inherent in the nature of a theocracy like that of the Jews, which was elementary, symbolical, typical, preparatory to a better and a spiritual economy. It is freely allowed that a double sense should not be admitted when another explanation is more probable. No doubt it has been assumed in some cases too hastily; but there are cases which cannot be fairly interpreted without it. See **QUOTATION** (of O. T. in the New).

The language of prophecy is generally vague and obscure; the ideas of the seers—their visions and dreams, were tinged with darkness. In many instances, it would seem that they had not themselves a clear perception of all the meaning of what they were prompted to utter (1 Pet. i, 11). Some of their predictions, therefore, are fairly susceptible of various references, and were doubtless intended to be so taken. Indeed, it is a good rule, in the interpretation of Scripture generally, to adopt that signification which is the most comprehensive, and which frequently includes two or more senses upon which commentators have generally been divided; but this, of course, cannot be done when these meanings are diverse in principle, but only where, as in the case of the double references now spoken of, they are but branches of the same wider extension, or applications coming under the same analogy. That one event in this manner frequently adumbrates another in Scripture is unquestionable, and the

uage is often adapted to such a twofold import. remarkable instances of this may be seen even in the Test., as, for example, in our Lord's blended pronouncement of the destruction of Jerusalem and the end of world (Matt. xxiv); and a similar ambiguity runs through all the O.-T. utterances respecting "the latter days," the details of which are applicable in various degrees to the Restoration and to the Messianic æra.

ESCHATOLOGY. Indeed, more recent expositors strongly inclining, in the case of the Apocalypse, to that system of exposition which regards its language, its visions, and its symbols as designed to refer so much to any specific event or series of events as to various historical occurrences and periods; that wherever general agencies appear in operation, as distinguished from individual transpirations—wherever general causes and influences exist, there the Apocalyptic prophecies apply; that they comprehend various events and periods, because they speak of general influences or agencies producing similar results. See **REVELATION (BOOK OF)**. Hence the scenery is largely borrowed from Daniel and Ezekiel, not in a sense foreign to its original import, but merely as a fresh application or extension to cognate incidents. According to Alexander (*Commentary on Isaiah*, Introd. p. 1), "all predictions, or prophecies in the restricted sense, are not specific and exclusive, i. e. limited to one occasion or emergency, but many are descriptive of a sequence of events which has been often realized. Thus, in some parts of Isaiah there are prophetic pictures of the sieges of Jerusalem which cannot be exclusively applied to any one event of that kind, but in terms and images of which are borrowed partly from one and partly from another through a course of ages. Thus the threatening against Babylon contained in Isa. xliii, xlv, if explained as a specific and exclusive prophecy of the Medo-Persian conquest, seems to represent the downfall of the city as more sudden and complete than it appears in history. . . . It is a panorama of the fall of Babylon, not in its first inception merely, but through all its stages till its consummation." It therefore depicts different and distinct occurrences, separated by intervals of time from one another. Each is a certain grade and stage of fulfilment. If referred to one occurrence, or to a series of occurrences taking place together, the prophecy certainly applies to them—it has its meaning in them; but it has not its *full sense* or entire fulfilment till applied to other occurrences. The sense of it is *springing or germinating*; coming to widen till it embraces various references—allusions and applications to various events. See **PROPHECY**.

A still more striking instance of this twofold reference is found in Isa. xlix, which nearly throughout alludes more palpably to the Messiah, yet under the more immediate imagery of the return and restoration of the Babylonian exiles. Thus Jehovah's "Servant" (see Umbreit, *Knecht Gottes*, Hamb. 1840), chosen from his birth for the redemptive and evangelizing work (ver. 1, 2), is explicitly styled "Israel" (ver. 8), and a similar blending of the national and the Messianic references is continued through the chapter. That the speaker is not Isaiah himself, nor the prophets as a class, is evident from the fact that neither of these were ever intrusted with a message to the Gentiles. That the address is put into the mouth of the chosen people is favored by various considerations, but there are at the same time clear indications that the words are those of the Messiah. These two interpretations can only be reconciled by assuming that in this passage (as in others that might be cited) the ideal speaker is the Messiah considered as the head of his people, and as forming with them one complex person, according to the canon of Tichonius, quoted by Augustine: "Mention is often made in Scripture of Christ and his body the Church as of one person, to whom some things are attributed which reside only in the Head,

some which belong only to the Body, and some again which pertain to both" (Alexander, *Later Prophecies of Isaiah*, p. 170). See **ISALAH (BOOK OF)**.

Another example is Psalm xvi, which, although in the first instance, as explained by all good commentators (e. g. Calvin, De Wette, Ewald, Hengstenberg, Alexander, Olshausen, Hupfeld), describes a pious sufferer in peril of death, either David himself or some other, yet in a higher sense passes through one stage of fulfilment in every pious sufferer; while its highest fulfilment is in Christ, as is proved by the quotations of Peter and Paul in the Acts of the Apostles. The same may be said of Psalm xxii: few will deny that it has reference, chiefly or in its highest import, to Christ, the head of the righteous afflicted; but verses 6, 9, 10 demonstrate that it has a literal application to the writer's own sacred sorrows. We may also point to Isaiah xl-lxvi as a more extended example. We cannot doubt that this portion of the book refers primarily to a historical object, the exile, and the deliverance of Israel from Babylon. But along with the description of this restoration there is a deeper and higher reference, namely, to the time of the Messiah, in which comes spiritual deliverance. The two are spoken of together, and blended in the description given. The prophecy was *fulfilled* in the last; it had an *incipient* fulfilment, if we may be allowed the phrase, in the first. It matters not whether the prophet himself distinctly intended to speak of both; it is highly probable that he had no very clear perception of the manner in which his language would be verified by history in its highest sense. The descriptions are of such a kind as to forbid their *exclusive* application either to the New dispensation or to events in the Old; both must be combined in order to bring out the true interpretation; they relate both to historical events under the Old, and spiritual ones under the New economy. Nor are the references to the historical and the spiritual kept apart; the one merges into the other; in some parts the descriptions point to the two as successive, while in others they embrace both together. See **PSALMS**.

A common objection to this mode of interpretation is that it is arbitrary to apply one part of a prophecy to a historical person or place, and another part of the same passage spiritually; to interpret one verse literally and another emblematically; for example, to say that David is meant in this clause, and Christ in that. Those who do not explain the same prophecy throughout in one consistent method are justly liable to this objection: the two methods, the historical and the spiritual, or the nearer and more remote, should be adopted together and applied throughout the same passage, except that in certain parts a preponderance may be allowed to one or the other import; while those who prefer the historical alone, or the spiritual alone, should adhere to each respectively: it is wrong to run from one to another in the same prophecy, unless there be evident marks of a transition. This objection, therefore, does not lie against the legitimate use of the twofold-reference scheme, but against its abuse.

As to the other objection urged against this method of interpretation, that it opens the door for many, even an indefinite number of senses, as well as two, it may be sufficient to reply, in the first place, that if there be evidence of several senses inhering in a given prophecy, they ought, of course, all to be admitted, however numerous they may be. But, secondly, there will rarely, if ever, be found to exist more than two such senses, and these not really distinct, but related to each other as special and general, as local and universal, or as primary and secondary, as germinal and complete, as historical and spiritual, etc. In short, one event is to be viewed as the *type* of another, because involving the same principle in the divine economy; e. g. the "Man of Sin" (q. v.) is Antichrist as a

spiritual antagonist, whether in the form of the Seleucid persecutors, pagan Rome, or the papacy. See LITTLE HORN. See Davidson, in Horne's *Introduction*, new ed. ii, 458 sq.; on the other side, Stuart, in the *Biblic. Repos.* 1881, p. 68 sq.; in the *Bibliotheca Sacra*, 1852, p. 459 sq.; comp. Stier, *Words of Jesus*, i, 481 sq., Am. ed.; *Met. Quart. Review*, April, 1867, p. 195 sq. See HERMENEUTICS.

Doubt (*dubito*, to go two ways). "Man knows some things and is ignorant of many things, while he is in *doubt* as to other things. *Doubt* is that state of mind in which we hesitate as to two contradictory conclusions, having no preponderance of evidence in favor of either. Philosophical *doubt* has been distinguished as *provisional* or *definitive*. *Definitive doubt* is *scepticism*. *Provisional* or *methodical doubt* is a voluntary suspending of our judgment for a time, in order to come to a more clear and sure conclusion. This was first given as a rule in philosophical method by Des Cartes, who tells us that he began by doubting everything, discharging his mind of all preconceived ideas, and admitting none as clear and true till he had subjected them to a rigorous examination. *Doubt* is some degree of belief, along with the consciousness of ignorance, in regard to a proposition. Absolute *disbelief* implies knowledge: it is the knowledge that such or such a thing is not true. If the mind admits a proposition without any desire for knowledge concerning it, this is *credulity*; if it is open to receive the proposition, but feels ignorance concerning it, this is *doubt*. As knowledge increases, doubt diminishes, and belief or disbelief strengthens (Taylor, *Elements of Thought*)."—Fleming, *Vocabulary of Philosophy*, Phila. 1860. See DES CARTES; SCEPTICISM.

Doubts, DISSOLVING OF, Chald. מְשַׁרְבֵּת קִטְרִין, *mesharab' kitrin'*, to *unwind knots*, i. e. solve problems; a form of speech still commonly employed in the East for the determination of difficult questions (see Roberts, Burder, Bush, *Illustra.* in loc.).

Dough (פַּת, *batek'*, so called from *swelling* in fermentation, Exod. xii, 34, 39; Jer. vii, 18; Hos. vii, 4; "flour," 2 Sam. xiii, 8; מְרִיסוֹת, *arisoth'*, *grits*, so called as being *poinded*, Num. xv, 20, 21; Neh. x, 37; Ezek. xlv, 80). See COOK. The dough, we are told, which the Israelites had prepared for baking, and on which it appears they subsisted after they left Egypt for a month, was carried away by them in their kneading-troughs on their shoulders (Exod. xii, 34). See KNEADING-TROUGH. In Oriental countries, and indeed in all tropical climates, the process of preparing the materials for baking is very expeditious, and generally performed in the house for each meal, including grinding the meal. See BREAD. The fermentation is

often dispensed with altogether. See LEAVEN. In Hos. vii, 8, it appears that the dough had to be *tried* in the process of baking, in order to be well done. In BAKE.

Dougharty, GEORGE, a Methodist Episcopal minister of the South Carolina Conference. The date of his birth is wanting. He entered the itinerancy in 1823, was presiding elder 1802-6, became superannuated in 1807, and died March 23, 1807, at Wilmington, N. C. Mr. Dougharty was one of the greatest preachers of the Conference. His mind and memory were capacious; he had a large fund of knowledge, was indefatigable in labor and study, and "totally dead to the world." He was far in advance of his associates with regard to education, and labored in 1803 to establish a Methodist academy in South Carolina. In 1801 he was attacked by a mob, gathered in the interest of slavery in Charleston. They dragged him to a pump and pumped water on him till he was nearly exhausted, when a heroic woman interfered and kept the mob at bay till help arrived and saved him from probable death.—Stevens, *History of the Methodist Episcopal Church*, vols. iii and iv; *Minutes of Conferences*, i, 131; Doerns, *Annals of Southern Methodism*, p. 228; Sprague, *Annals*, vii, 290.

Doughty, John, was born at Martley, near Worcester, England, about 1598; was educated at Oxford, and became fellow of Merton College. About 1631 he was made rector of Lapworth, Warwickshire; and after the restoration of Charles II he was appointed prebendary of Westminster and rector of Chesham, Surrey. He died at Westminster, Dec. 25, 1672. He published, under the Latinized name Doughters, *Hebraea Sacra, sive excursus philologici breves super S. Scripturae locis* (Lond. 1658-60, 2 vols. 8vo); 2d ed. with Knatchbull's *Animadver.* in *N. T.* (Amst. 1758, 8vo); *De Calicibus eucharisticis vel Christianis* (Bremæ, 1694, 8vo).—Darling, *Cyclopaedia Bibliographica*, i, 949; Orme, *Bibliotheca Biblica*.

Doughty, Samuel, a Methodist Episcopal minister of the Philadelphia Conference, was born in Philadelphia in January, 1794, was converted in 1816, entered the itinerancy in 1823, was stationed successively at New Brunswick, N. J., and at St. George's, Philadelphia, and died at Wilmington, Del., Sept. 17, 1852. Mr. Doughty was one of the most popular, useful, and eloquent preachers of his time. He was an eloquent advocate for the benevolent institutions of the Church, especially for Sunday-schools, of which he was a distinguished promoter, both before and after his entrance into the regular ministry. His literary and theological requirements and talents were of a high order, as his published *Sermons* in the *Methodist Magazine* sufficiently attest, especially one upon "Instability in Religion."

He was rapidly rising in influence and usefulness when he was suddenly cut down.—*Minutes of Conferences*, ii, 38; Sprague, *Annals*, vii, 672.

Douglas, Gawin, or **Gavin**, bishop of Dunkeld, Scotland, was the third son of Archibald, earl of Angus, and was born at Brechin in 1474, or the beginning of 1475. He received his education first in his own country, and then on the Continent. On his return to Scotland he was made provost of the collegiate church of St. Giles, at Edinburgh, and afterwards abbot of Aberbrothach. He was also nominated by the queen regent to the archbishopric of St. Andrews, but this dignity he never obtained, owing to the refusal of the pope to confirm the



Arab Women grinding Grain with a Hand-mill, rolling out the Dough, and baking the Bread.

ntment. He was, however, confirmed as bishop unkindled through the interest of Henry VIII with Leo X. His administration fell in a troubled and after many vexations he retired to England, e Henry VIII granted him a pension. He died e plague at London in 1522. Bishop Douglas lated the *Aeneid* of Virgil into Scottish verse, ed at London in 1558, 4to. His other works are a called *The Palace of Honor*, 4to, and *King Hart*, ed in 1786. His *Virgil* was reprinted at Edin- h in folio, with a glossary, in 1710.—Kippis, *Bi- hica Britannica*, v, 338.

ouglas, John, D.D., bishop of Salisbury, was in 1721 at Pittenweem, Fifeshire, and was educa- at Balliol College, Oxford. He was chaplain in the rds at the battle of Fontenoy, became canon and t of Westminster in 1762, was made bishop of Car- in 1787, and in 1791 was transferred to Salisbury. died May 18, 1807. Dr. Douglas was intimate t Dr. Johnson, and all the most celebrated of his temporaries. He was an accurate scholar and ic, and exposed Lander in his *Milton no Plagiary*, ably attacked Hume in his *Criterion of Miracles*. h these essays are given in Douglas's *Select Works* libury, 1820, 4to. He also wrote largely against hibald Bower, aiming to show that he was a liter- and religious impostor, in his *Six Letters to Shel-* (Lond. 1756, 8vo), and in his *Bower and Tillemont* pared (London, 1757, 8vo). A new edition of his ersion appeared from the Clarendon Press (1838). Elliott, *Delineation of Romanism* (Lond. 1851), p. ; Van Mildert, *Boyle Lectures*.

Douglass, THOMAS LOGAN, an eminent Methodist iscopal minister of the Virginia Conference, and af- wards of the Tennessee Conference, was born in rson County, N. C., July 8, 1781, entered the Vir- ia Conference on trial in 1801, traveled on impor- t circuits and districts until 1813, was then tran- sferred to the Tennessee Conference, and died near anklin, Tenn., April 9, 1848. Mr. Douglass was in- initely useful both as a preacher and presiding el- r, and his influence was very great in the Confer- ces with which he was connected during more than irty years. His sermons were pregnant with thought, d his appeals were full of pathos. Few preachers his time had such command of their hearers. He is an excellent disciplinarian, and thoroughly versed the history and economy of Methodism. "His pie- was uniform and deep, his temper sweet," and his d age was bright and blessed. He was several times ected a delegate to the General Conference.—*Min- es of Conferences*, iii, 457; Sprague, *Annals*, vii, 852; ummers, *Biographical Sketches*, p. 108.

Dove (דָּוָה, *yonah*), prob. referring to the sexual arms of that bird; *περισσέρα*; both terms occa- sionally rendered "pigeon"). There are probably veral species of doves or pigeons included in the lebrew name with its Greek equivalent. It may obtain all those that inhabit Palestine, exclusive of e turtle-doves properly so called. See TURTLE-

DOVE. In modern systems, the doves are included in the natural family of *Columbidae*, or pigeon tribe, which comprises the pigeons, doves, and turtles; but natural- ists are still divided as to the proper place of the fam- ily, and the limits of the respective subdivisions (see Bochart, *Hieroz.* ii, 542 sq.). Syria possesses several species of pigeon: the *Columba aenas*, or stock-dove; *C. palumbus*, or ring-dove; *C. domestica*, *livia*; the common pigeon in several varieties, such as the Bar- bary, Turkish or Persian carrier, crisp, and shaker. These are still watched in their flight in the same manner as anciently their number, gyrations, and other manœuvres were observed by soothsayers. The wild species, as well as the turtle-doves, migrate from Palestine to the south, but stock and ring-doves are not long absent. In the wild state, doves generally build their nests in the holes or clefts of the rocks, or in excavated trees, but they are easily taught submis- sion and familiarity with mankind, and, when domes- ticated, build in structures erected for their accommo- dation, called "dove-cotes" (comp. Cant. ii, 14; Jer. xlviii, 28; Isa. lx, 8). Doves are kept in a domesti- cated state in many parts of the East. The pigeon- cot is a universal feature in the houses of Upper Egypt. In Persia pigeon-houses are erected at a dis- tance from the dwellings, for the purpose of collecting the dung as manure. The allusion in Isa. lx, 8, is to the immense compact masses of these birds that Eastern travellers describe, as they are seen flying to their cotes or places of general resort. They sometimes re- semble a distant heavy cloud, and are so dense as to obscure the rays of the sun. Stanley (*Syr. and Pal.* p. 257), speaking of Ascalon as the haunt of the Syrian Venus, says: "Her temple is destroyed, but the sac- red doves—sacred by immemorial legends on the spot, and celebrated there even as late as Eusebius— still fill with their cooings the luxuriant gardens which grow in the sandy hollow within the ruined walls." See below. The dove has been by some considered (though in an obscure passage) as an early national standard (Psa. lxxviii, 13), being likewise held in pagan Syria and Phœnicia to be an ensign and a divinity, resplendent with silver and gold, and so venerated as to be regarded as holy, and forbidden as an article of food. (See Engel, *Kypros*, ii, 184; Kreuzer, *Symbol.*



Syrian pink-and-white Carrier-dove, and Phœnician sacred Ensign of the Dove.

ii, 70-77.) It is supposed that the dove was placed upon the standards of the Assyrians and Babylonians in honor of Semiramis. This explains the expression in Jer. xxv, 88, "from before the fierceness of the dove," i. e. the Assyrian (comp. Jer. xlv, 16; l, 16). There is, however, no representation of the dove among the sculptures of Nineveh, so that it could hardly have been a common emblem of the nation at the time when they were executed; and the word in the above three passages of Jeremiah admits another interpretation (Gesenius, *Thesaur.* p. 601 a). By the Hebrew law, however (see Mishna, *Yom Tob*, i, 3; *Baba Batra*, ii, 5 sq.; *Bab-kamma*, vii, 7), doves and turtle-doves were the only birds that could be offered in sacrifice, and they were usually selected for that purpose by the less wealthy (Gen. xv, 9; Lev. v, 7;



Rock-dove.

xli, 6; Luke ii, 24); and, to supply the demand for them, dealers in these birds sat about the precincts of the Temple (Matt. xxi, 12, etc.). The brown wood-dove is said to be intended by the Hebrew name; but all the sacred birds, unless expressly mentioned, were pure white, or with some roseate feathers about the wing coverts, such as are still frequently bred from the carrier-pigeon of Scanderoon. It is this kind which Tibullus notices (i, 7). The carrier-birds are represented in Egyptian bas-reliefs, where priests are shown letting them fly on a message. All pigeons in their true wild plumage have iridescent colors about the neck, and often reflected flashes of the same colors on the shoulders, which are the source of the silver and gold feathers ascribed to them in poetical diction; and thence the epithet of purple bestowed upon them all, though most applicable to the vinous and slaty-colored species. This beauty of plumage is alluded to in Psa. lxxviii, 19, where the design of the Psalmist is to present, in contrast, the condition of the Hebrews at two different periods of their history: in the day of their affliction and calamity they were covered as it were with shame and confusion, but in the day of their prosperity they should resemble the cleanest and most beautiful of birds. The dove was the harbinger of reconciliation with God (Gen. viii, 8, 10, etc.), when Noah sent one from the ark to ascertain if the waters of the Deluge had assuaged. The association of the dove and the olive is not only natural, but highly emblematical (Thomson, *Land and Book*, i, 69). The dove is frequently mentioned in the Scriptures as the emblem of purity and innocence, and so it doubtless was viewed by the Psalmist (Psa. lv, 6-8), although with a special allusion to the swiftness of that bird's flight (comp. Sophoc. *Œd. Col.* 1081; Eurip. *Bacch.* 1090). By an almost anthropomorphic extension of this idea, the dove is, figuratively, next to man, the most exalted of animals, symbolizing the Holy Spirit, a sentiment that appears to be couched in the description of creation (Gen. i, 2), where the Spirit is represented as brooding ("moved") over the surface of chaos. (See treatises on this point by Augusti, *Die Taube*, in Geseler and Lücke's *Zeitschr.* iii, 56-64; Moller, *De columba*, Frih. 1721; Schmid, *De columbis*, Helmst. 1711, 1781; Schwebel, *De columbarum cultu*, Onold. 1767; E. F. Wernsdorf, *De simularo columba*, Viteb. 1778; Id. *De columba sancta Syrorum*, Helmst. 1761; J. C. Wernsdorf, *De columba*, Helmst. 1770; Ziebach, *De columba pentecostalis*, Viteb. 1787.) The Holy Spirit descended, as a dove descends, upon our Saviour at his baptism—visibly with that peculiar hovering motion which distinguishes the descent of a dove (Matt. iii, 16; Mark i, 10; Luke iii, 22; John i, 82). (See the treatises on this incident, in Latin, by Adler [Sorav. 1822], Böhmer [Jen. 1727], Christ [Jen. 1727], Riess [Marb. 1786], Rechenberg [Cob. 1741], Varesmus [Kil. 1671; Viteb. 1718, 1728], Ziebach [Ger. 1772]; in German by Schulthess [in Winer's *Krit. Jour.* iv, 257-294].) The dove is also a noted symbol of tender and devoted affection, especially in the Canticles (i, 15; ii, 14, etc.). The conjugal fidelity of the dove has been celebrated by every writer who has described or alluded to her character (Cant. i, 15). She admits but of one mate, and never forsakes him until death puts an end to their union. The black pigeon, when her mate dies, obstinately rejects another, and continues in a widowed state for life. Hence among the Egyptians a black pigeon was the symbol of a widow who declined to enter again into the marriage relation. These facts have been transferred, by later authors, to the widowed turtle, which, deaf to the solicitations of another mate, continues, in mournful strains, to deplore her loss until death puts a period to her sorrows. (On the emblematical uses of the dove, see further Wemyss, *Symbol. Dict.* s. v.) The cooing of the dove, when solitary, is often alluded to in Scripture (Isa. xxxviii, 14; lix, 11; Nah. ii, 7). Comp. PIGEON.

In Christian art, the dove is employed as the emblem of the Holy Ghost, following the literal interpretation, which is doubtless the true one, of Matt. iii. After images and pictures began to be allowed in churches, the Holy Ghost was represented by the image of a silver dove hovering over the altar, and in baptistery had the same. The place over the altar where it was suspended was called *peristrium*, *ἀναπεριστέρα*, a dove (Bingham, *Orig. Eccles.* bk. viii. c. vi, § 19).

"From the dove being a symbol of purity, it is generally represented white, with its beak and claws as they occur in nature. In the older pictures the nimbus surrounds its head, the nimbus is frequently divided by a cross, either red or black. In stained-glass windows we see the dove with seven rays proceeding from it, terminating in seven stars, significative of the seven gifts of the Holy Spirit. Holding an olive-branch, the dove is an emblem of peace. When seen issuing from the lips of dying saints and martyrs, it represents the human soul purified by suffering. A dove with six wings is a type of the Church of Christ; and when so employed, it has the breast and belly of silver, and the back of gold, two wings being attached to the head, two to the shoulders, and two to the feet. The pyx or box containing the Host (q. v.) in Roman Catholic churches is sometimes made in the form of a dove, and suspen-

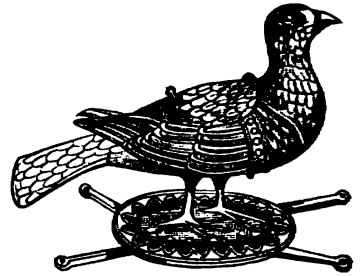

Pyx in the form of a Dove.

ed over the altar, and the dove is often placed on the covers of fonts. In this position it may still be seen in parish churches in England" (Chambers, *Encyclopædia*, s. v.). See also Martigny, *Dict. des Antiquités Chrétiennes* (Paris, 1865, p. 164; Didron, *Christian Iconography* (Bohn), p. 451; Jehan, *Dict. des Origines et Christianisme* (Paris, 1856), art. *Columbe*.

DOVE-COT. Isaiah (lx, 8) clearly refers to such structures in describing the final restoration of Israel after their long exile: "Who are these that fly as a cloud, and as the doves to their windows?" (אֵלֵינוּ כְּדֹבִים לְרִשְׁתֵּיהֶן, *like the doves to their lattices*). The doubtless derived their Heb. name from their lattice or window-like form. See WINDOW. Morier illustrates this comparison from what he observed in Persia. "In the environs of the city, to the westward near the Zainderood, are many pigeon-houses, erected at a distance from habitations, for the sole purpose of collecting pigeons' dung for manure. They are low round towers, rather broader at the bottom than the top, and crowned by conical spiracles, through which the pigeons descend. Their interior resembles a honey-comb, pierced with a thousand holes, each of which forms a snug retreat for a nest. More care appears to have been bestowed upon their outside than upon that of the generality of the dwelling-houses, for they are pointed and ornamented. The extraordinary flight of pigeons which I have seen alight upon one of these buildings afford, perhaps, a good illustration of the passage in Isa. lx, 8. Their great numbers, and the compactness of their mass, literally look like a cloud at a distance, and obscure the sun in their passage. (*Second Journey through Persia*, p. 140). Not only at



Modern Persian Dove-cote.

se birds profitable as food, but both Porter and rier assure us that their manure is used in Persia. According to the latter, "the dung of pigeons is the best manure that the Persians use; and as they rely it almost entirely for the rearing of melons, it is probably on that account that the melons of Ispahan are so much finer than those of other cities. The revenue of a pigeon-house is about a hundred tomanas per annum" (*Second Journey*, p. 141). Porter says "so hundred tomanas" (*Travels*, i, 451). See below.

DOVES' DUNG occurs in 2 Kings vi, 25, as a literal translation of חֲרֵרֵי יוֹנִים (*charey'-yonim*'), which in the margin is written דִּבְיוֹנִים (*div'-yonim*'), both meaning the same thing. By many the expression is considered to signify literally the dung of pigeons for food in the last degree of human suffering by famine: "And there was a great famine in Samaria, and they held they besieged it, until an ass's head was sold for threescore pieces of silver, and the fourth part of a lb of doves' dung for four pieces of silver." Different opinions, however, have been entertained respecting the meaning of the words which are the subject of this article, namely, whether they should be taken literally, or as a figurative name of some vegetable substance. The strongest point in favor of the former view is that all ancient Jewish writers have understood the term literally, and generally as an article of food. That this interpretation is not forced appears from similar passages in Josephus (*War*, v, 13, 7): "Some persons were driven to such terrible distress as to search the common sewers and old dunghills of cattle, and to eat the dung which they got there, and what they of old could not endure so much as to look upon they now used for food;" see also Eusebius (*Eccles. Hist.* iii, 6): "Indeed necessity forced them to apply their teeth to every thing; and, gathering what was no food even for the filthiest of irrational animals, they devoured it." Celsius, who is strongly in favor of the literal meaning, quotes the following passage from Bruson (*Memorabil.* ii, c. 41): "The Cretans, during the siege by Metellus, on account of the scarcity of wine and drinks, allayed their thirst with the urine of cattle;" and one much to the point from a Spanish writer, who states that in the year 1316 so great a famine distressed the English that "men ate their own children, dogs, mice, and pigeons' dung." As an additional argument in favor of the literal interpretation of the passage in question may be adduced the language of Rabshakeh to the Jews in the time of Hezekiah (2 Kings xviii, 27; Isa. xxxvi, 12). Other and more modern instances have been adduced, and among them the famine in England during the reign of king Edward II, A.D. 1316, when "pigeons' dung" is mentioned as being eaten by the poor (*Edinburgh Christian Instructor*, No. 122). It may be, however, that the sacred writer means only to say that the famine was so severe, and every thing so exorbitantly dear,

that an instance occurred when an ass's head was sold for eighty pieces of silver, and a cab of doves' dung for five; so that the passage may be understood literally, since it is not incredible that persons oppressed by severe famine should devour even the excrements of animals. In the account of the famine and pestilence in Egypt, A.D. 1200, 1201, written in Arabic by the physician Abd-allatif, we have a remarkable illustration of this passage. He says, "The poor, already pressed by the famine which increased continually, were driven to devour dogs, and the carcasses of animals and men, yea, even the excrements of both." Taking the term, however, in a literal sense, various other explanations have been given of the use to which the doves' dung was applied. Some of the Rabbins were of opinion that it was used for fuel, and Josephus (*Ant.* ix, 4) that it was purchased for its salt. Mr. Harmer (*Observ.* iii, 186) has suggested that it might have been a valuable article, as being of great use for quickening the growth of esculent plants, particularly melons; and he shows, what is well known, that the Persians live much on melons in the summer months, and use pigeons' dung in raising them. All travellers describe the number of pigeon-houses in Persia. See above. Mr. Edwards, as cited by Dr. Harris, remarks that it is not likely they had much ground to cultivate in so populous a city for gardens; and is disposed therefore to understand it as meaning the offals or refuse of all sorts of grain, which was wont to be given to pigeons, etc. Dr. Harris, however, observes that the stress of the famine might have been so great as to have compelled the poor among the besieged in Samaria to devour either the intestines of the doves, after the more wealthy had eaten the bodies, or, as it might perhaps be rendered, the crops, with the undigested contents, as suggested by Fuller (*Miscell. Sacr.* vi, 2, p. 724). Bochart, indeed, has shown (*Hieroz.* ii, 573) that the term "pigeons' dung" was applied by the Arabs to different vegetable substances. He quotes Avicenna as applying the term *stercus columbarum* to two different plants or substances. One of these is described by Avicenna and other Arab authors under the names *kuz-kundem* and *joug-kundem*, as a light substance like moss. Secondly, this name was given to the *ashnan* or *unana*, which appears to be a fleshy-leaved plant, that, like the *salsolas*, *salsicornias*, or *mesembryanthemums*, when burnt, yields alkali in its ashes. From this Bochart has been led to consider it as identical with another plant, which occurs under the name of *kali* both in the Hebrew and Arabic languages, and which was used in ancient times, as at the present day, as an article of food. See PARCHEL CORN. Celsius, however (*Hieroz.* ii, 32), has shown that Bochart was mistaken in affirming that the article of food known among the Arabs by the epithet doves' or sparrows' dung was pulse or chick-peas, and therefore the connection between the Hebrew and Arabic terms *kali* falls to the ground. Still it remains certain that the Arabs call the maritime plant *kali*, from the ashes of which soda (hence called *al-kali*) is obtained, by the epithet sparrows' dung. But this, if accessible at all in Samaria, would hardly be a regular article of food, even in a siege, much less be stored up for the purpose of sale, as the article in question appears to have been. We may also compare the German *Teufelsdröck* ("devil's dung") as expressive of the odor of *asafoetida* (see Gesenius, *Theaur.* p. 516). Linnæus suggested (*Prolectiones*, ed. P. D. Giseke, p. 287) that the Heb. term may signify the *Ornithogalum umbellatum*, "Star of Bethlehem." On this subject the late Dr. Edward Smith remarks (*English Botany*, iv, 180, ed. 1814): "If Linnæus is right, we obtain a sort of clew to the derivation of *ornithogalum* (birds' milk), which has puzzled all the etymologists. May not this observation apply to the white fluid which always accompanies the dung of birds, and is their urine? One may almost perceive a similar combination of col-

ors in the green and white of this flower, which accords precisely in this respect with the description which Dioscorides gives of his *ornithogalum*." Sprengel (*Comment. on Dioscorides*, ii, 173) is inclined to adopt the explanation of Linnæus. The late Lady Callcott,



Star of Bethlehem (*Ornithogalum Umbellatum*).

in her *Scripture Herbal* (1842, p. 180) infers that the pigeons' dung which has been mentioned above as being eaten in England in the famine of 1816 was the roots of this plant. It is a native of that country, and also of Taurus, Caucasus, and Northern Africa. Dioscorides states that its bulbs were sometimes cooked with bread, in the same way as the *melanthium*, and also that it was eaten both raw and roasted. The roots were also commonly eaten in Italy and other southern countries at an early period. If the besieged had communication with the exterior, or even if any of their body could have dug in the neighborhood of the walls, for the kind of "earth-nut" offered by the bulbs of the *ornithogalum*, or Star of Bethlehem, which is said to be abundant in the neighborhood of Samaria, there does not appear any good reason why it should not be the substance alluded to. But it does not seem so likely to have been stored up; and no distinct reference has been found in the Arab authors to such a plant under the name of *stercus columbarum*.

None of the above explanations of the difficult term in question appear satisfactory. Those that proceed upon the supposition that the substance designated was not intended as an article of food, give us only other purposes which are too petty to deserve such emphatic notice as marks of famine in a siege, and the rest fail to identify any substance with the terms employed. Nevertheless, having seen that the name "pigeons' dung" has been, and probably still is, applied by the Arabs to different vegetable substances, we are not disposed to adopt the literal meaning of the term, since doves' dung, being devoid of nutriment, was not likely to have served as food, even during the famine, especially as we find that an ass's head was sold for sixty pieces of silver. Now, if any asses remained for sale, or ass-loads of corn, as the expression has been interpreted, there is no reason for supposing that other substances may not have remained stored up in secret for those who had money to buy. But it is not easy to say what vegetable substance, serving as an article of diet, is alluded to by the name of "doves' dung." We must therefore rest, for the present, with the conclusion that it was a preparation from some plant, which, as being popularly known by this repulsive name, was not ordinarily resorted to for food, and of which, therefore, there has been no occasion elsewhere to make mention. Future naturalists may hereafter succeed in determining the point more definitely. Or it may be true that several species of

plants and vegetable productions were anciently designated by this and similar terms, as the instance produced above seem to show; and analogous cases in the popular nomenclature of modern nations go far to justify this assumption (see Thomson, *Land and Sea*, ii, 200).

Dove, JOHN, commonly called "the Hebrew scholar," on account of his trade, was distinguished as a Hutchinsonian. He possessed a good knowledge of the Hebrew language, and was considered a man of learning, but intemperate in his language. He died in 1772. His principal works are, *The Importance of Rabbinical Learning*, etc. (Anon.) (Lond. 1744, 8vo); *A Creed founded on Truth and Common Sense*, etc. (Lond. 1750, 8vo); *An Essay on Inspiration* (Lond. 1751, 8vo); *Plain Truth; or, Quakerism unmasked* (Lond. 1756, 8vo); *A Dissertation upon the supposed Error of a Moral Law of Nature, and upon the Being of a True God* (Lond. 1757, 8vo); *Miscellaneous Dissertation on Marriage, Celibacy, Covetousness, Virtue*, etc. (Lond. 1769, 8vo); *Darling, Cyclop. Bibliographica*, &c.

Dow, Daniel, D.D., a Congregational minister, was born in Ashford, Conn., Feb. 19, 1772. He graduated at Yale in 1798; entered the ministry May, 1798, and was installed pastor at Thompoen, April 29, 1799, where he labored until his death, July 19, 1848. He was chosen fellow of Yale in 1824, and was made D.D. by Williams' College in 1840. Among his publications were *Familiar Letters to Rev. John Sherman* (1805); *The Pædo-Baptist Catechism* (1807); *A Dissertation on the Sinaitic and Abrahamic Covenants* (1811); *An Election Sermon* (1825); *Free Inquiry recommended as the Subject of Freemasonry* (1829); *Sprague, Annals*, ii, 369.

Dow, John G., a Methodist Episcopal minister, was born at Gilmanton, N. H., June 15, 1785; entered the New England Conference in 1822; in 1833 he made presiding elder; in 1839 was agent of Newbury Seminary; was superannuated in 1857; and died at Chelsea, Mass., May 18, 1858, having preached thirty-six years. Mr. Dow was "an excellent man and minister, sound in doctrine, deep in experience, and faithful in piety. His preaching was full of thought, and a demonstration of the Spirit."—*Minutes of Conference*, 1859, p. 141.

Dow, Lorenzo, an eccentric American preacher, was born in Coventry, Conn., Oct. 18, 1777. He began travelling and preaching in the Methodist Episcopal Church in 1798, and in 1799 he was appointed to Essex Circuit, but soon departed for Europe, under the impression that he had a special mission to Ireland. He was "dropped" by the Conference, and ever after continued to travel and preach independently, although still adhering to Methodist doctrines. He rose at the rate of forty to fifty miles a day, and preached often four or five times daily. In his sermons he particularly "argued against Atheism, Deism, Universalism, and Calvinism." His final efforts were directed against the Jesuits, whose influence he thought would be fatal to the country. He died suddenly at Washington, Feb. 2d, 1834. Dow figured considerably as a writer. Among his publications are, *A short Account of a long Travel; with Beauties of Wesley* (Phila. 1822, 8vo); *History of a Cosmopolite; or the Writings of the Rev. Lorenzo Dow, containing his Experiences and Travels in Europe and America up to near his fifth Year: also his Polemic Writings* (often reprinted; latest, Cincinnati, 1851, 1855, 8vo); *The Stranger in Charleston; or the Trial and Confession of Lorenzo Dow* (Phila. 1822, 8vo); *Polemical Works* (N. Y. 1814, 12mo), etc. See Peck, *Early Methodism* (New York, 1860, 12mo, p. 197); *Dealings of God, Man, and the Devil*, containing Dow's *Life and Miscellaneous Writings* (N. Y. 1854, 2 vols. in 1, 8vo); Stevens, *History of the Methodist Episcopal Church*, iii and iv.

Dowdall, GEORGE, archbishop of Armagh, a native of Lowth, was appointed to the see of Armagh in 1711 by Henry VIII. The pope refused to confirm his nomination, but Dowdall, nevertheless, retained the see. He was a zealous papist, and introduced the Mass into Ireland. He resisted the introduction of the English Prayer-book in 1551, and the viceroy (Sir James Crofts) summoned him to a conference with the pope at Meath. Their curious colloquy on points of doctrine is given in Hook, *Eccles. Biography*, iv, 498 sq. Dowdall was deprived of his primacy, which was given to John Rowne, archbishop of Dublin (q. v.). He fled to the Continent, but was restored to his see by queen Elizabeth in 1553, and labored earnestly to re-establish the English Church. He died in London in 1558.—Mant, *History of the Church of Ireland*; Hook, *Eccles. Biography*, i, 205. *New Biog. Dict.* s. v.

Down, a town in Ireland, forming part of the territory of the diocese of Down, Connor, and Dromore, of which Robert Bent Knox (consecrated in 1849) is at present bishop (1868). The see of Dromore, a town in the west of the County Down, was founded in the 12th century, but is now united with Down and Connor. The Roman Catholic Church has one bishop of Down and Connor, and another of Dromore.

Downname, or Downham, GEORGE, D.D., a learned English divine, was born at Chester (of which city his father was bishop), studied at Cambridge, and was elected fellow of Christ College in 1585. He was afterwards professor of logic, and was finally made bishop of Derry in 1616. He died in 1634. His principal works are: *A Treatise of Justification* (London, 1619, fol.);—*An Abstract of the Duties commanded in the Law of God* (London, 1635, 8vo);—*The Christian's Freedom* (reprinted Lond. 1836, 18mo);—*A godly and learned Treatise of Prayer* (Lond. 1640, 4to);—*A Treatise concerning Antichrist* (London, 1608, 4to);—*Papa Antichristus* (1620).

Downe, JOHN, a minister of the Church of England, was born in 1570, in Devonshire, and was educated at the University of Cambridge, where he passed his degree in 1600. He was first presented to the vicarage of Winsford, and afterwards to the living of Instow, worth about a hundred pounds a year, where he spent many days in diligent and useful pastoral labor. His skill in the languages, particularly Hebrew, Greek, Latin, French, and Spanish, was extraordinary. He was diligent in expounding, catechising, and preaching the Scriptures: in his ministry he went through the whole body of the Bible, from the beginning of Genesis to the end of Revelation. He died at Instow in 1631.—Middleton, *Evangelical Biography* (London, 1816), iii, 36.

Downham. See **DOWNNAME**.

Dowry (דוּוּרָה, *mo'har*, prop. price paid for a wife, Gen. xxxiv, 12; Exod. xxii, 17; 1 Sam. xviii, 25; מַגֵּן, *ze'bed*, a gift, Gen. xxx, 20; φερώνυ, 2 Macc. i, 4). Nothing distinguishes more the nature of marriage among us in Europe from the same connection when formed in the East than the different methods of proceeding between the father-in-law and the intended bridegroom. Among us, the father usually gives a portion to his daughter, which becomes the property of her husband, and which often makes a considerable part of his wealth; but in the East the bridegroom offers to the father of his bride a sum of money, or value to his satisfaction, before he can expect to receive his daughter in marriage. The sum which the bridegroom was required to pay to the father of his bride as a nuptial present or dowry was to be according to the rank she sustained, and such as the fathers of virgins of the same rank were accustomed to receive for their daughters. Of this procedure we have instances from the earliest times. When Jacob had nothing which he could immediately give for a wife,

he purchased her by his services to her father Laban (Gen. xxix, 18; xxx, 20; xxxiv, 12; 1 Sam. xviii, 25; Exod. xxii, 16, 17; Josh. xv, 18; Hos. iii, 2). (See Senkenberg, *De jurebus dotium*, Giessen, 1729; Walch, *De privilegio dotis Judææ*, Jena, 1785.) See **MARRIAGE**.

Doxology (δοξολογία, a praising, giving glory), an ascription of glory or praise to God.

1. *Doxologies in N. T.*—Short ascriptions, which may be called doxologies, abound in the Psalms (e. g. xvi, 6; cxii, 1; cxiii, 1), and were used in the synagogue. We naturally, therefore, find the apostles using them; e. g. Rom. xi, 36; Ephes. iii, 21; 1 Tim. i, 17. The Apocalypse (xix. 1) gives, as a celestial doxology, "Alleluia! Salvation, and glory, and honor, and power unto the Lord our God;" and another (v, 18), "Blessing, and honor, and glory, and power be unto him that sitteth upon the throne, and unto the Lamb, forever and ever." The song of the angels, Luke ii, 14, is a doxology (see below, No. 2). The doxology at the close of the Lord's Prayer—"for thine is the kingdom, and the power, and the glory, forever. Amen"—is thought by most critics to be an interpolation. It is not used in the Roman liturgy in repeating the Lord's Prayer, but is used in the worship of the Greek Church, and in all Protestant churches. See **LORD'S PRAYER**.

2. *Liturgical Doxologies.*—There are three doxologies of special note, which have been in use in Church worship from a very early period, viz.: (1.) *The Lesser Doxology*, or *Gloria Patri*, originally in the form, "Glory be to the Father, and to the Son, and to the Holy Ghost;" to which was added later, "world without end;" and later still the form became what it is now: "Glory be to the Father, and to the Son, and to the Holy Ghost, as it was in the beginning, is now, and ever shall be, world without end. Amen." The use of this noble doxology has been a constant testimony to the Church's faith in the Holy Trinity. In the Church of England it must be said or sung at the end of the reading of every psalm; in the Protestant Episcopal Church it may be said or sung at the end of every psalm, but either it or the greater doxology must be said or sung at the end of the whole portion of Psalms for the day. For further details, see **GLORIA PATRI**. (2.) *The Greater Doxology*, or *Gloria in Excelsis*, called also the *Angelic Hymn* (q. v.), a doxology of praise and thanksgiving founded on the song of the angels, Luke xi, 14 ("Glory be to God on high," etc.). For its form and history, see **GLORIA IN EXCELSIS**. It is used in the eucharistic services of the Church of England, the Methodist Episcopal and Protestant Episcopal churches, and, in fact in most Protestant churches. (3.) *The Trisagion* (Latin *Tersanctus*), a doxology as old as the second century, beginning with the words "Therefore, with angels and archangels, and with all the company of heaven, we laud and magnify thy glorious name." It is used in the communion service of the Church of England, the Methodist Episcopal, Protestant Episcopal, and some other Protestant churches. For its form and history, see **TRISAGION**.

3. *Metrical Doxologies.*—It is usual in Protestant churches, at the end of the singing of a hymn, or at least at the end of the last hymn in the service, to sing the doxology in the same metre. The hymn-books of the churches, therefore, contain a collection of versions of the *Gloria Patri* in various metres, adapted to all the metres of the hymns. See Bincham, *Biog. Eccles.* bk. xiv, ch. ii; Siegel, *christl. Alterthümer*, i, 515 sq.; Procter, *On Common Prayer*, p. 212; Palmer, *Orig. Liturg.* iv, § 23.

Doyle, JAMES WARREN, a bishop of the Roman Catholic Church in Ireland, was born in 1786 at New Ross, near Wexford, and was appointed bishop of Kildare in 1819. He was a copious writer on con-

traversal topics, and in the Emancipation movement was one of the most valuable coadjutors of O'Connell. He died June 15, 1834. For his testimony before the Lords Commissioners, March 21, 1825, as to the symbolical books of the Roman Catholic Church, see Elliott, *Delineation of Romanism*, bk. i, ch. i; and for some severe criticisms on bishop Doyle, see the same work (Lond. edit.), bk. iii, ch. iii. His *Life*, by Fitzpatrick, was republished in Boston in 1862.

Doyle, GEORGE, D.D., an eminent divine of the Church of England, was born in London Oct. 18, 1778, and graduated B.A. at Benedict College, Cambridge, in 1800, as second wrangler and second Smith's prizeman, and M.A. in 1803. In 1811 he was made Christian advocate, and D.D. in 1821. He became rector of Buxted in 1815, rector of Lambeth, and of Sundridge, Kent, in 1820, and died January 8, 1846. He was a frequent contributor on theological subjects to the *Quarterly Review*. Among his other numerous writings are *Life of Abp. Sancroft* (Lond. 1821, 2 vols. 8vo; 1840, 8vo);—*Sermons, chiefly doctrinal* (London, 1827, 8vo);—*Sermons at St. Mary, Lambeth* (London, 1847, 2 vols. 8vo). He also, with bishop Mant, edited *Notes explanatory and practical on the authorized Version of the Bible* (Lond. 1845, 3 vols. royal 8vo). There is a good American edition of this work, which, as a judicious compilation from the best annotators, has a special value for popular use, as well as for theological students (edited by bishop Hobart, 1818-20, 2 vols. 4to, with additional notes).

Drabicius (Drabiz, or Drabich), NICOLAUS, a Mystic of the 17th century, was born at Stradteiss, in Moravia, in 1585 (according to Bayle, in 1587; according to Moreri, in 1588). He became an evangelical preacher in 1616, but, in consequence of difficulties with the Protestant clergy, was obliged to leave his native country. In 1629 he went to Lednitz, in Hungary, where he supported himself by mercantile pursuits. In the mean time he turned his attention to theosophy, and claimed, after February, 1638, to have visions. He prophesied that the imperial house of Austria would end in 1657, and that in 1666 Louis XIV of France would succeed as Roman emperor. This was to be followed by the downfall of papacy, a great reformation of the Church, and the conversion of all heathen and unbelievers. By order of the Austrian authorities, he was arrested at Presburg as a political offender in 1671, and executed July 17th. His corpse and his book of prophecies were burned by the executioner. J. A. Comenius (q. v.) published the prophecies of Drabicius, together with those of other enthusiasts, under the title *Lux in tenebris* (1657); the second edition (1659) appeared under the title *Historia revelationum Chr. Kotteri, Chr. Pomiatovic, Nic. Drabicii, etc.* A third edition appeared under the original title in 1665. See Bayle, *Dictionary*, s. v.; Arnold, *Kirchen-u. Ketzehist.* (Schaffh. ed., ii, 353-56); Köler, *Disp. de Nic. Drabicio* (Alt. 1791); Schröckh, *K. G. seit d. Ref.* iv, 688; vii, 508-9; Herzog, *Real-Encyclop.* iii, 493.

Drachma (δραχμή, "drachm," 2 Macc. iv, 19; x, 20; xii, 48; "piece of silver," Luke xv, 8, 9), a Greek silver coin, consisting of 6 oboli (Böckh, *Staatshaus.* i, 16 sq.), but varying in weight on account of the use of different talents. The Jews must have been acquainted with three talents—the Ptolemaic, used in Egypt, and at Tyre, Sidon, and Berytus, and adopted for their own shekels; the Phœnician, used at Aradus and by the Persians; and the Attic, which was almost universal in Europe, and in a great part of Asia. The drachmæ of these talents weigh respectively, during the period of the Maccabees, about 55 grs. Troy, 58.5, and 66 (see De Romé de l'Isle, *Métrologie*, Paris, 1789, p. 81 sq.). The drachms mentioned in 2 Macc. are probably of the Seleucidæ, and therefore of the Attic standard; but in Luke *denarii* seems to be intended, for the Attic drachma had been at that time reduced

to about the same weight as the Roman *denarius* (v.) as well as the Ptolemaic drachma, and was probably or almost superseded by it. This explains the remark of Josephus that "the shekel was worth four Attic drachmæ" (*Ant.* iii, 8, 2), for the four Ptolemaic drachmæ of the shekel, as equal to four denarii of the Roman, were also equal to four Attic drachmæ; and the Attic drachm (q. v.) was equivalent to the sacred half shekel (*War.* vii, 6, 6; *Matt.* xvii, 24) of the Temple. (See Böckh, *Métrolog. Unters.* Berl. 1838.)—Smith. See DRAM; DARGIC; SILVER, PIECE OF.

Draconites, JOHANN (otherwise *Drack*, or *Drack*, or, according to his native town, *Carlstadt*), was born at Carlstadt in 1494. He became professor at Erfurt, and canon of the church of St. Severin. His long shown great friendship for Luther, particularly when the reformer passed through Erfurt in 1522 on his way to Worms, he lost his situation and went to Wittenberg. Here he was made D.D. in 1523, and then became pastor at Mildenberg. He returned to Wittenberg in 1524. In 1534 he accepted a call as preacher and professor of theology at Marburg. He died at Wittenberg April 18, 1566. He prepared *Biblia pentapla*, of which only fragments have been published (1563-65); he also wrote *Commentarius de Peccatis*, on several chapters of *Genesis* (1561); on *Obadiah* (1537);—*A Latin Translation of the Psalms* (Strasb. 1538);—*Commentary on Daniel* (1541);—*Commentariolum ev. de Jesu Christo, lib. ii* (Basel, 1545);—*Oratio de pia morte D. M. Luikeri* (1545), &c. See *Adami Vita theol. Germ.*; Striegel, *Historische Gelehrte und Schriftstellergeschichte* (3 vols.); Strobel, *Verträge zur Literatur, besonders des 16 Jahrhunderts* (vols.).—Herzog, *Real-Encyclopædie*, iii, 495.

Dracontius, a Spanish priest, lived about the year 450. He is the author of a poem describing the history of the six days of creation (*Hexameron, or six days of creation*). In its original form this poem had 12 verses, and is followed by an elegy addressed to the emperor Theodosius the Younger, consisting of 9 verses. In the 7th century, bishop Eugen of Trier revised the poem, and added a description of the seventh day. In this new shape the *Hexameron*, or rather *Heptameron*, contains 634 verses. The original poem of Dracontius was published in *Patrum Corpus christ. Poetarum* (Basel, 1564), and with one by Weitz, at Frankfort (1610); also in the *Magna Bib. Patrum*, vol. vi, and in the *Bibl. Patrum*, vol. viii. A revised and enlarged by bishop Eugen, it has been published by Rivin (Leips. 1651), Arevall (*Rome*, 1775), Carpzov (Helmstadt, 1794), in the *Bibliotheca Mæcens. Patrum*, vol. ix.—Hoefler, *Novæ Biog. Germ.* xiv, 20.

Draeseke, JOHANN HEINRICH BREYHER, one of the most brilliant and popular of modern preachers in Germany. Born at Brunswick, Jan. 18, 1774, he was educated at Helmstadt, where he was greatly influenced by Henke, and devoted himself to the humanistic literature then prevalent, especially to the drama. In 1804 he became pastor at Ratzburg, and in 1810 at Bremen. His patriotic labors during the Napoleonic wars gave him great reputation, and his great talents spread his name far and wide. In 1833 he succeeded Westermeyer as bishop of the province of Saxony. He died at Potsdam Dec. 8, 1849. His practical sermons are very numerous. The earlier ones are rationalistic, the later more orthodox and full of Christian feeling. The most celebrated of them are *Andenken für denkende Verehrer Jesu*, of which the 2d edition is that of 1836, 2 vols. edited by his son. He published also *Glaube, Liebe, Hoffnung* (6th ed. 1834); *Deutschlands Wiedergeburt* (2d edit. 1818); *Genesius d. Heil. Schrift* (4 vols. 1821-28). His *Andenken an seine Predigten* appeared at Magdeburg, 1850 (2 vols.). See *Saintes, History of Rationalism*, chap. xxi.

Drag (דַּרַג, *mikmo'rah*, Heb. i, 15, 16; i,

נֶזֶן, *mālmō' rēth*, Isa. xix, 8, "net"), a *scine* or *ng-net*. See FISH; NET.

ragon (from the Greek δράκων, as in the Apoc-
ta and Rev. frequently), an imaginary serpent of
quity, especially in mythology, supposed to be sup-
l with feet and often with wings, stands in our
ion usually as a translation of two Heb. words of
rent signification, but common derivation—*tan*,
and *tammim'*, תַּמִּימַי (according to Gesenius, from
to *extend*, with reference to the great length of
or both of them). The similarity of the forms of
words may easily account for this confusion, espe-
ly as the masculine plural of the former, *tammim*,
ally assumes (in Lam. iv, 8) the form *tammim*, and,
he other hand, *tammim* is evidently written for the
gular *tammim* in Ezek. xxix, 8; xxxii, 2. But the
ds appear, to be quite distinct in meaning; and the
inction is generally, though not universally, pre-
ved by the Sept. Bochart, however, proposes (*Hie-*
ii, 429) to read uniformly *tammim* as the plur. of
and thus merge both terms into one. See WHALE.
The former (always "dragon" except Ezek. xxxii,
'whale") is used, always in the plural, in Job xxx,
; Isa. xxxiv, 18; xliii, 20 (Sept. *σείρητες*); in Isa.
i, 22 (*ἐχίνου*); in Jer. x, 22; xlix, 38 (*στρουθοί*); in
a. xlv, 19 (*τόπιφ κατώσεως*); and in Jer. ix, 11,
7, 6; li, 87; Mic. i, 8 (*δράκοντες*). The feminine
ural תַּמִּימַי, *tammoth'*, is found in Mal. i, 8; a passage
together differently translated by the Sept. It is
ways applied to some creatures inhabiting the des-
; and connected generally with the words תַּמִּימַי
ostrich") and נֶזֶן ("jackal"?). We should con-
ide from this that it refers rather to some wild beast
an to a serpent, and this conclusion is rendered al-
ost certain by the comparison of the *tammim* in Jer.
v, 6, to the wild asses snuffing the wind, and the re-
ference to their "wailing" in Mic. i, 8, and perhaps in
b xxx, 29. The Syriac renders it by a wolf which,
ccording to Pococke, means a "jackal" (a beast whose
eculiarly mournful howl in the desert is well known),
ad it seems most probable that this or some cogate
species is to be understood whenever the word
s occurs. This interpretation, however, although
vored by the grammatical forms, is supported by lit-
e more than conjecture as to the identification with
e *jackal*, or wild dog of the desert, which the Arabs
all *awi*, plur. *awin* (corresponding to the Hebrew
נֶזֶן, "wild beasts of the islands," Isa. xliii, 22;
xxiv, 18; Jer. l, 39, i. e. *jackals*), so called from their
awling; although they call the *wolf* by the name *tay-*
an, which is somewhat like תַּמִּימַי. See JACKAL.

2. The word *tammim'*, תַּמִּימַי (plur. תַּמִּימַי), is always
endered by δράκων in the Sept. except in Gen. i, 21,
where we find *κίτρος*. It generally occurs in the plu-
al, and is rendered "whale" in Gen. i, 21; Job vii,
12; "serpent" in Exod. vii, 9-12; "sea-monster" in
Lam. iv, 8. It seems to refer to any great monster,
whether of the land or the sea, being indeed more usu-
ally applied to some kind of serpent or reptile, but not
exclusively restricted to that sense. When referring
to the sea it is used as a parallel to לֵוִיָּאֲתָן ("levi-
athan"), as in Isa. xxvii, 1; and indeed this latter word
is rendered in the Sept. by δράκων, in Psa. lxxiv, 14;
civ, 26; Job xl, 20; Isa. xxvii, 1; and by μέγα κίτρος
in Job iii, 8. When we examine special passages we
find the word used in Gen. i, 21, of the great sea-mon-
sters, the representatives of the inhabitants of the
deep. The same sense is given to it in Psa. lxxiv, 18
(where it is again connected with "leviathan"), Psa.
cxlviii, 7, and probably in Job vii, 12 (Vulg. *cetus*).
On the other hand, in Exod. vii, 9, 10, 12; Deut. xxxii,
38; Psa. xci, 13, it refers to land-serpents of a power-
ful and deadly kind. It is also applied metaphorically

to Pharaoh or to Egypt (Isa. li, 9; Ezek. xxix, 8;
xxxii, 2; perhaps Psa. lxxiv, 13), and in that case, es-
pecially as feet are attributed to it, it most probably
refers to the crocodile as the well-known emblem of
Egypt. When, however, it is used of the king of
Babylon, as in Jer. li, 84, the same propriety would
lead us to suppose that some great serpent, such as
might inhabit the sandy plains of Babylonia, is in-
tended. See LEVIATHAN.

8. In the New Test. *dragon* (δράκων) is only found
in the Apocalypse (Rev. xii, 8, 4, 7, 9, 16, 17, etc.), as
applied metaphorically to "the old serpent, called the
Devil, and Satan," the description of the "dragon"
being dictated by the symbolical meaning of the im-
age rather than by any reference to any actually ex-
isting creature. Of similar personification, either of
an evil spirit or of the powers of material Nature as
distinct from God, we have traces in the extensive
prevalence of dragon-worship, and existence of dragon-
temples of peculiar serpentine form, the use of dragon-
standards both in the East, especially in Egypt, and
in the West, more particularly among the Celtic tribes.
The most remarkable of all, perhaps, is found in the
Greek legend of Apollo as the slayer of the Python,
and the supplanter of the serpent-worship by a higher
wisdom. The reason, at least of the scriptural sym-
bol, is to be sought not only in the union of gigantic
power with craft and malignity, of which the serpent
is the natural emblem, but in the record of the ser-
pent's agency in the temptation (Gen. iii). For the
ancient allusions to these fabulous or monstrous ani-
mals, see Smith's *Dict. of Class. Antiq.* s. v. DRACO.
A well-known story of one of these occurs in the me-
diæval legend of "St. George (q. v.) and the Dragon,"
and a still earlier one is named below. See MONSTER.

DRAGON AT BABYLON. In the Sept. version of
Daniel there occurs, as chap. xiv, an account entitled
Bel and the Dragon (q. v.), which states that at Baby-
lon, under Cyrus, an enormous dragon (δράκων μέγας)
was worshipped (? by *lectisternia*, i. e. by spreading vi-
ands on a couch as an offering). This serpent-worship,
however, is certainly not of Babylonian origin (see Sel-
den, *De diis Syr.* ii, 17, p. 865 sq.), since the two silver
serpents mentioned by Diodorus Siculus (ii, 9) as be-
ing in the temple of Belus (q. v.) were not forms of
divinities, but only emblems of the gods there repre-
sented; yet possibly the conception had reference to
the Persian symbol of the serpent, which signified
Ahriman (*Zendavesta*, by Kleuker, i, 6). Accordingly
the serpent appears also in later Jewish representations
as an evil dæmon (Rev. xii, xiii; comp. Gen. iii). See
SERPENT.

DRAGON-WELL (יַרְדֵּן הַתַּמִּימַי, *eyn hat-tammim'*,
fountain of the dragon; Sept. πηγή τῶν οὐκῶν; Vulg.
fons draconis), the name of a fountain situated oppo-
site or near the valley gate of Jerusalem (Neh. ii, 13).
It is probably identical with the modern "Upper Pool
of Gihon," on the north-western side of the city, and
also with the "Serpent's Pool" mentioned by Josephus
(*War*, V, iii, 2). (See Strong's *Harmony and Expos.*
of the Gospels, Append. ii, p. 8.) See JERUSALEM.

Dragon (in *symbolism*). The dragon, in Christian
art, is the emblem of sin in general and of idolatry in
particular. Its usual form is that of a gigantic winged
crocodile. "It is often represented as crushed under
the feet of saints and martyrs, and other holy person-
ages. Sometimes its prostrate attitude signifies the
triumph of Christianity over paganism, as in pictures
of St. George and St. Sylvester; or over heresy and
schism, as when it was adopted as the emblem of the
Knights of the order of the Dragon in Hungary, which
was instituted for the purpose of contending against
the adherents of John Huss and Jerome of Prague."
—Chambers, *Encyclopædia*, s. v.; Jamieson, *Sacred*
and Legendary Art, i, 26.

Dragon, Order of the, was founded in 1408 by

the emperor Sigismund, chiefly for fighting against the infidels. The members wore on the breast a cross, on which hung a killed dragon.

Dragonnaades, or Draconings, one of the modes of persecution employed against the Protestants of France after the revocation of the Edict of Nantes by Louis XIV; so called because the chief soldiers engaged in the service were *dragoons*. See FRANCE; PERSECUTIONS.

Dram (1 Chron. xxix, 7; Ezra ii, 69; viii, 27; Neh. vii, 70, 71), or **Drachm** (Tobit v, 14; 2 Macc. iv, 19; xii, 43). The term rendered thus in our version (Sept. δραχμή and χρῆσις, Vulg. *drachma* and *solidus*; דַרְכֻמוֹןִי, *darkemonim'*, Ezra ii, 69; Neh. vi, 70-72; or with a letter prefixed דַרְכֻמוֹןִי, *adar-konim'*, 1 Chron. xxix, 7; Ezra viii, 27) is usually thought to denote the **DARIC** (Δαρεικός) of the Persians (from the Persic *dara*, a king, whence perhaps the title *Darius*), and seems to be etymologically connected with the Greek **DRACHMA** (δραχμή). The *daric* is of interest not only as the most ancient gold coin of which any specimens have been preserved to the present day, but as the earliest coined money which, we can be sure, was known to and used by the Jews; for, independently of the above passages, it must have been in circulation among the Jews during their subjection to the Persians. It even circulated extensively in Greece. The distinguishing mark of the coin was a crowned archer, kneeling on one knee, stamped on one side, and on the other a deep irregular cleft.



Gold Daric of Persia. Actual size.

Harpocration says that, according to some persons, the daric was worth twenty silver drachmæ, which agrees with the statement of Xenophon (*Anab.* i, 7, 18), who informs us that 8000 darics were equal to ten talents, which would consequently make the daric equal to twenty drachmæ. The value of the daric in our money, computed thus from the drachma, is 16s. 3d. sterling, or \$3.93; but, if reckoned by comparison with our gold money, it is much more. The darics in the British Museum weigh 128.4 grains and 128.6 grains respectively. Hussey (*Anc. Weights*, vii, 8) calculates the daric as containing on an average about 128.7 grains of pure gold, and therefore equal to £1 1s. 10d. 1.76 gr., or \$5.29. There are also silver coins which go by the name of darics, on account of their bearing the figure of an archer; but they were never called by this name in ancient times. See **DARIC**.

The *drachma* (δραχμή, "piece of silver," Luke xv, 8, 9) was a coin of silver, the most common among the Greeks, and which, after the Exile, became also current among the Jews (2 Macc. iv, 19; x, 20; xii, 48). The earlier Attic drachmæ were of the average weight of 66.5 grains, and in a comparison with the shilling would be equal to 9.72d., or about 19 cents. After Alexander's time there was a slight decrease in the weight of the drachma, till, in course of time, it weigh-



Athenian Drachma. Actual size.

ed only 63 grains, and specimens of the later times are in some cases even of less weight than this. In this state the drachma was counted equal to the denarius,

which was at first worth 8½d., and afterwards 7½d., or about 15 cents, which may therefore be considered as the value of the drachma in the New Testament—that is, the nominal value, for the real value of money was far greater in the time of Christ the present. That the drachma of Alexandria was to two of Greece is inferred from the fact that it makes the Jewish shekel equivalent to two drachmæ [see **DIDRACHMA**]; and, in fact, an Alexandrian drachma weighing 126 grains has been found. It was also the tetradrachm, or four-drachma piece, later times called the *stater* (q. v.). (See *Smith's Dict. of Class. Antiq.* s. v. *Drachma*.) See **DRACHMA**.

Draught occurs in our version as a translation of ἀφιδραῦν (literally a *place of sitting apart*), a *misprision* (Matt. xv, 17; Mark vii, 19).

DRAUGHT-HOUSE similarly occurs as a translation of מַכְרַחֲזִי (macha'ra'ah, literally an *empty vessel*, 2 Kings x, 27 for which in the margin, by a phemism, מוֹלֵטֵאֵךְ, *molta'ah*, an *outrigging*, a *pry*; *sewer*). Jehu, in order to show his contempt for the worship of Baal, ordered his temple to be destroyed and the place converted to a vile use, that of receiving offal or ordure. On this mode of degradation, see Ezra vi, 11; Dan. ii, 5.

Drawer of WATER (שׂוֹבֵר מַיִם, *shob'er mayim*; Sept. ὑδροφόρος, i. e. *water-carrier*) occur in Deut. xxix, 11; Josh. ix, 21, 23; and in both instances it is spoken of as a hard and servile employment: for the crafty Gibeonites were condemned. In the East water must be fetched from the river or the wells. In towns this is rarely done by the household themselves, or by their servants. There are persons who make a trade of it to supply every day, to regular customers, the quantity required. They carry about the water in a well-prepared goat-skin, which is slung over the back; the neck is usually brought under the chin



Oriental Water-carrier.

and compressed by the hand, serving as the mouth of this curious but very useful vessel. Those who derive a great trade have an ass, which carries two skins at once, borne like panniers. These men, continuing to pass to and fro with their wet bags through the narrow streets, are great nuisances in the towns.

difficulty of avoiding contact with them. There are no vehicles of draught in Asiatic towns; the warriers with their bags, and the "hewers of wood," using large fagots on their backs, or the backs of asses or mules, form the only obstructions in the streets. In a time of public calamity the water-carriers are the last to discontinue their labor; and their being so is a sure indication that the distress has become intense and imminent. See WATER.

Dream (חֲלוֹם, *chalom*; Sept. ἐνύπνιον; but καθ' ὕπνον and καθ' ὄναρ in Matthew are generally used "in a dream"). Dreams have been the subject of much curious speculation in all ages. The ancients had various theories respecting them, the most able of which for our present purpose is that of Mercurius (Hicad, i, 68), who declares that "they come from Jove." The most philosophic opinion of antiquity respecting dreams was that of Aristotle, who taught that every object of sense produces upon the human soul a certain impression, which remains for some time after the object that made it is removed; and which, being afterwards recognised by the perceptive faculty in sleep, gives rise to the varied images which present themselves. This view nearly approaches that of modern mental science, which teaches that dreams are ordinarily the re-embodiment of thoughts which have before, in some shape or other, occupied our minds (Elwin, *Operations of the Mind in Sleep*, Lond. 1843). They are broken fragments of our former conceptions revived, and heterogeneously put together. If they break off from their connecting chain and become loosely associated, they exhibit oftentimes absurd combinations, but the elements are still *substant*. If, for instance, any irritation, such as pain, fever, etc., should excite the perceptive organs while the reflective ones are under the influence of sleep, we have a consciousness of objects, colors, or sounds being presented to us, just as if the former organs were actually stimulated by having such impressions communicated to them by the external senses; whilst, in consequence of the repose of the reflecting power, we are unable to rectify the illusion, and conceive that the scenes passing before us, or the sounds that we hear, have a real existence. This want of mutual co-operation between the different faculties of the mind may account for the *disjointed* character of dreams. This is in accordance with the theory of dreams alluded to in Eccles. v, 7; Isa. xxxix, 8.

"The main difference between our sleeping and waking thoughts appears to lie in this, that in the former case the perceptive faculties of the mind (the sensational powers [not their organs; see Butler, *Analogy*, pt. i, c. 1], and the imagination which combines the impressions derived from them) are active, while the reflective powers (the reason or judgment by which we control those impressions, and distinguish between those which are imaginary or subjective and those which correspond to, and are produced by, objective realities) are generally asleep. Milton's account of dreams (in *Par. Lost*, v, 100-113) seems as accurate as it is striking. Thus it is that the impressions of dreams are in themselves vivid, natural, and picturesque, occasionally gifted with an intuition beyond our ordinary powers, but strangely incongruous and often grotesque; the emotion of surprise or incredulity, which arises from a sense of incongruity, or of unlikeness to the ordinary course of events, being in dreams a thing unknown. The mind seems to be surrendered to that power of association by which, even in its waking hours, if it be inactive and inclined to 'musing,' it is often carried through a series of thoughts connected together by some vague and accidental association, until the reason, when it starts again into activity, is scarcely able to trace back the slender line of connection. The difference is that, in this latter case, we are aware that the connection is of our own

making, while in sleep it appears to be caused by an actual succession of events. Such is usually the case; yet there is a class of dreams, seldom noticed, and, indeed, less common, but recognised by the experience of many, in which the reason is not wholly asleep. In these cases it seems to look on as it were from without, and so to have a double consciousness: on the one hand we enter into the events of the dream, as though real; on the other we have a sense that it is but a dream, and a fear lest we should awake and its pageant should pass away. In either case the ideas suggested are accepted by the mind in dreams at once and inevitably, instead of being weighed and tested, as in our waking hours. But it is evident that the method of such suggestion is still undetermined, and, in fact, is no more capable of being accounted for by any single cause than the suggestion of waking thoughts. The material of these latter is supplied either by ourselves, through the senses, the memory, and the imagination, or by other men, generally through the medium of words, or, lastly, by the direct action of the Spirit of God, or of created spirits of orders superior to our own, or the spirit within us. So also it is in dreams. In the first place, although memory and imagination supply most of the material of dreams, yet physical sensations of cold and heat, of pain or of relief, even actual impressions of sound or of light will often mould or suggest dreams, and the physical organs of speech will occasionally be made use of to express the emotions of the dreamer. In the second place, instances have been known where a few words whispered into a sleeper's ear have produced a dream corresponding to their subject. On these two points experience gives undoubted testimony; as to the third, it can, from the nature of the case, speak but vaguely and uncertainly. The Scripture declares, not as any strange thing, but as a thing of course, that the influence of the Spirit of God upon the soul extends to its sleeping as well as its waking thoughts. It declares, that God communicates with the spirit of man directly in dreams, and also that he permits created spirits to have a like communication with it. Its declaration is to be weighed, not as an isolated thing, but in connection with the general doctrine of spiritual influence, because any theory of dreams must be regarded as a part of the general theory of the origination of all thought" (Smith).

Whatever may be the difficulties attending the subject, still we know that dreams have formed a channel through which Jehovah was pleased in former times to reveal his character and dispensations to his people. This method of divine communication is alluded to in Job xxxiii, 14. The most remarkable instances recorded in the Old Testament are those of Abimelech with regard to Abraham (Gen. xx, 8), Jacob on his way to Padan-Aram (Gen. xxviii, 8), and again on returning thence (Gen. xxxi, 10), Laban in pursuing Jacob (Gen. xxxi, 24), Joseph respecting his future advancement (Gen. xxxvii, 6-11), Gideon (Judg. vii), and Solomon (1 Kings iii, 5). In the New Testament (as was predicted, Joel ii, 28) we have the equally clear cases of Joseph respecting the infant Jesus (Matt. i, 20; ii, 12, 13, 19), Paul (Acts xvi, 9; xviii, 9; xxvii, 28), and perhaps Pilate's wife (Matt. xxvii, 19).

"It must be observed that, in accordance with the principle enunciated by Paul in 1 Cor. xiv, 15, dreams, in which the understanding is asleep, are recognised indeed as a method of divine revelation, but placed below the visions of prophecy, in which the understanding plays its part. It is true that the book of Job, standing as it does on the basis of 'natural religion,' dwells on dreams and 'visions of deep sleep' as the chosen method of God's revelation of himself to man (see Job iv, 13; vii, 14; xxxiii, 15). But in Num. xii, 6; Deut. xiii, 1, 3, 5; Jer. xxvii, 9; Joel ii, 28, etc., dreamers of dreams, whether true or false, are placed below 'prophets,' and even below 'diviners;' and sim-

larly in the climax of 1 Sam. xxviii, 6, we read that 'the Lord answered Saul not, neither by dreams, nor by Urim [by symbol], nor by prophets.' Under the Christian dispensation, while we frequently read of trances (*ἰκράσεις*) and visions (*ὄρασιαι, ὁράματα*), dreams are not referred to as regular vehicles of divine revelation. In exact accordance with this principle are the actual records of the dreams sent by God. The greater number of such dreams were granted, for prediction or for warning, to those who were aliens to the Jewish covenant. Thus we have the record of the dreams of Abimelech (Gen. xx, 8-7); Laban (Gen. xxxi, 24); of the chief butler and baker (Gen. xl, 5); of Pharaoh (Gen. xli, 1-8); of the Midianite (Judg. vii, 18); of Nebuchadnezzar (Dan. ii, 1, etc.; iv, 10-18); of the magi (Matt. ii, 12), and of Pilate's wife (Matt. xxvii, 19). Many of these dreams, moreover, were symbolical and obscure, so as to require an interpreter. Again, where dreams are recorded as means of God's revelation to his chosen servants, they are almost always referred to the periods of their earliest and most imperfect knowledge of him. So it is in the case of Abraham (Gen. xv, 12, and perhaps 1-9), of Jacob (Gen. xxviii, 12-16), of Joseph (Gen. xxxvii, 5-10), of Solomon (1 Kings iii, 5), and, in the N. T., a similar analogy prevails in the case of the otherwise uninspired Joseph (Matt. i, 20; ii, 18, 19, 22). It is to be observed, moreover, that they belong especially to the earliest age, and become less frequent as the revelations of prophecy increase. The only exception to this (at least in the O. T.) is found in the dreams and 'visions of the night' given to Daniel (ii, 19; vii, 1), apparently in order to put to shame the falsehoods of the Chaldean belief in prophetic dreams and in the power of interpretation, and yet to bring out the truth latent therein (comp. Paul's miracles at Ephesus, Acts xix, 11, 12, and their effect, 18-20).

"The general conclusion therefore is, first, that the Scripture claims the dream, as it does every other action of the human mind, as a medium through which God may speak to man either directly, that is, as we call it, 'providentially,' or indirectly in virtue of a general influence upon all his thoughts; and, secondly, that it lays far greater stress on that divine influence by which the understanding also is affected, and leads us to believe that as such influence extends more and more, revelation by dreams, unless in very peculiar circumstances, might be expected to pass away" (Smith). (See the [Am.] *Christ. Rev.* Oct. 1857.)

The Orientals, and in particular the Hebrews, greatly regarded dreams, and applied for their interpretation to those who undertook to explain them. Such diviners have been usually called *oneirocritics*, and the art itself *oneiromancy*. We see the antiquity of this custom in the history of Pharaoh's butler and baker (Gen. xl, 1-28); and Pharaoh himself, and Nebuchadnezzar, are also instances. See DIVINATION. It is quite clear from the inspired history that dreams were looked upon by the earliest nations of antiquity as premonitions from their idol gods of future events. One part of Jehovah's great plan in revealing, through this channel, his designs towards Egypt, Joseph individually, and his brethren generally, was to correct this notion. The same principle is apparent in the divine power bestowed upon Daniel to interpret dreams. Jehovah expressly forbade his people from observing dreams, and from consulting explainers of them. He condemned to death all who pretended to have prophetic dreams, and to foretell events, even though what they foretold came to pass, if they had any tendency to promote idolatry (Deut. xiii, 1-4). But they were not forbidden, when they thought they had a significant dream, to address the prophets of the Lord, or the high-priest in his ephod, to have it explained (Num. xii, 6; compare the case of Saul, 1 Sam. xxviii, 6, 7). False and true dreams are expressly contrasted in Jer. xxiii, 25, 28. See NIGHT-VISION.

Dregs (שְׂרָפִים, *shemarinim*, lees of wine [שְׂרָפִים where rendered except in] Psa. lxxv, 8; שְׂרָפִים, where rendered settling or being kept; שְׂרָפִים, *shemarinim*, 17, 22, means a goblet-cup merely). See LEAS. The best wines of the East are much mixed with dregs, the vessels in which they are preserved, so that commonly when drawn out the liquor is strained. It is to this condition of the wine that the Psalmist appears to refer: "He poureth out of the same; but the dregs thereof, all the wicked of the earth shall wring them out and drink them" (Psa. lxxv, 8). This probably intended to denote that the pure and best wine should be given as a wine of blessing to the righteous, while the wicked should drink the thin and turbid residue. The punishments which God inflicts upon the wicked are compared to a cupful of fermenting wine mixed with intoxicating herbs, of which those to whom it is given must drink the dregs as punishment. The same image occurs in several Arabic poets. Thus Taabbata Sharran says, "To thee of the tribe of Hodail we gave the cup of death, and the dregs were confusion, shame, and reproach." See WINE.

Drelincourt, CHARLES, an eminent minister of the Reformed Church of France, was born at Saumur, July 10, 1595. He was educated at Saumur, and in 1618 became pastor near Langres. In 1630 he was called to the pastorate of the church at Charenton near Paris, where he served faithfully, and with excellent reputation. He died at Paris Nov. 2, 1657. Drelincourt was a very voluminous writer. Lists of all his writings, see Nicéron, *Mémoires*, vol. xii, Haag, *La France Protestante*, iv, 382. Among these are, *Préparation à la Sainte Cène*, 3 vols. 8vo, (1st reprint:—*Consolations contre les frayeurs de la mort* (40 editions); translated, *The Christian's Duty against the Fears of Death* (13th ed. London, 1732) with memoir);—*Les Visites Charitables pour toutes sortes de personnes affligées* (Charenton, 1669, 5 vols. 12mo, translated into six languages).—Bayle, *Dictionnaire*, v.; Hoefler, *Nouv. Biog. Générale*, xv, 746.

Dress (does not occur in Scripture in the sense of clothing, but only in the older acceptance of property or tilling). See COSTUME.

1. *Materials*.—These were various, and multiplied with the advance of civilization. The earliest and simplest robe was made out of the leaves of a tree (אֵזָוָה, "A. V. fig-tree"—and comp. the present Arabic name for the fig, *fa*), portions of which were sewed together so as to form an apron (Gen. iii, 7). Ascetic Jews occasionally used a similar material in later times. Josephus (*Life*, 2) records this of Banus (*ἵματιν ἀπὸ δένδρων χρώμηνος*); but whether it was made of the leaves or the bark is uncertain. After the Fall, the skins of animals supplied a more durable material (Gen. iii, 21), which was adapted to the rude state of society, and is stated to have been used by various ancient nations (Diod. Sic. i, 43; ii, 36; Arabian, *Ind.* 7, 8). Skins were not wholly discarded in later periods: the *addē reth* (אֲדֵרֶת) worn by Elijah appears to have been the skin of a sheep or some other animal with the wool left on (in the Sept. the word is rendered *μυλωτή*, 1 Kings xix, 13, 19; 2 Kings ii, 13; *δορά*, Gen. xxv, 25; and *δέρμα*, Zech. xiii, 4; and may be connected with *δορά* etymologically, *Sachutz*, *Archæol.* i, 19; Gesenius, however, prefers the notion of *amplitude*, אֲרָץ, in which case it is = אֲרָץ Mic. ii, 8; *Theozaur.* p. 29). The same material is applied in the description of Elijah (אֵזָוָה אֲדֵרֶת Sept. *ἀνήρ δασύς*; A. V. "hairy man," 2 Kings i, 10), though these words may also be understood of the hair of the prophet; and in the comparison of Esau's skin to such a robe (Gen. xxv, 25). It was characteristic of a prophet's office from its mean appearance

h. xiii, 4; comp. Matt. vii, 15). Pelisses of sheep-still form an ordinary article of dress in the East (Reckhardt's *Notes on Bedouins*, i, 50). The sheep-coat is frequently represented in the sculptures (Chorsabad: it was made with sleeves, and was worn over the tunic: it fell over the back, and terminated in its natural state. The people wearing it have been identified with the Sagartii (Bonomi's *Nineveh*, 93). The *addereth* worn by the king of Nineveh (i. iii, 6), and the "godly Babylonish garment" worn at Ai (Josh. vii, 21), were of a different character: either robes trimmed with valuable furs, or the robes themselves ornamented with embroidery. The art of weaving hair was known to the Hebrews at an early period (Exod. xxvi, 7; xxxv, 6); and the sackcloth used by mourners was of this material [see SACKCLOTH], and by many writers the *addereth* of the prophets is supposed to have been such. John the Baptist's robe was of camels' hair (Matt. iii, 4), and a similar material was in common use among the poor that day (Joseph. *War*, i, 24, 3), probably of goats' hair, which was employed in the Roman *clivium*. At that period the use of wool, and of still more artificial textures, such as cotton and linen, became known, is certain: the first of these, we may presume, was introduced at a very early period, the flocks of the pastoral families being kept partly for their wool (Gen. cxviii, 12): it was at all times largely employed, particularly for the outer garments (Lev. xiii, 47; eut. xxii, 11; Ezek. xxxiv, 8; Job xxxi, 20; Prov. xvii, 26; xxxi, 13). See WOOL. The occurrence of the term *ketoneth* in the book of Genesis (iii, 21; xxvii, 3, 23) seems to indicate an acquaintance, even at that early day, with the finer materials; for that term, though significant of a particular robe, originally appears to have referred to the material employed (the robe being preserved in our *cotton*; comp. Bohlen's *Enod*, ii, 51; Saalchütz, *Archæol.* i, 8), and was applied by the later Jews to flax or linen, as stated by Josephus (*Ant.* iii, 7, 2, *Χεθρομένη μὲν καλιτραί. Λίνεον οὐτο σημαίνει, χίθον γὰρ τὸ λίνον ἡμεῖς καλοῦμεν*). To conclusion, however, can be drawn from the use of the word: it is evidently applied generally, and without any view to the material, as in Gen. iii, 21. It is probable that the acquaintance of the Hebrews with linen, and perhaps cotton, dates from the period of the captivity in Egypt, when they were instructed in the manufacture (1 Chron. iv, 21). After their return to Palestine we have frequent notices of linen, the finest kind being named *sheeth* (שֵׁט) and at a later period *buts* (בִּט), the latter a word of Syrian, and the former of Egyptian origin, and each indicating the quarter whence the material was procured: the term *chûr* (חִיר) was also applied to it from its brilliant appearance (Isa. xix, 9; Esth. i, 6; viii, 15). It is the *bysus* (βύσσος) of the Sept. and the N. T. (Luke xvi, 19; Rev. xviii, 12, 16), and the "fine linen" of the A. V. It was used in the vestments of the high-priests (Exod. xxviii, 5 sq.), as well as by the wealthy (Gen. xli, 42; Prov. xxxi, 22; Luke xiv, 19). See LINEN. A less costly kind was named *bad* (בָּד; Sept. *λίνας*), which was used for certain portions of the high-priest's dress (Exod. xxviii, 42; Lev. xvi, 4, 28, 32), and for the ephods of Samuel (1 Sam. ii, 18) and David (2 Sam. vi, 14): it is worthy of notice, in reference to its quality and appearance, that it is the material in which angels are represented (Ezek. ix, 3, 11; x, 2, 6, 7; Dan. x, 5; xii, 6; Rev. xv, 6). A coarser kind of linen, termed *ómolion* (Ecclus. xl, 4), was used by the very poor. The Hebrew term *sadin*' (סַדִּין = *σινδών*, and *satín*) expresses a fine kind of linen, especially adapted for summer wear, as distinct from the *saraballa*, which was thick (Talmud, *Menach.* p. 41, 1). What may have been the distinction between *sheeth* and *sadin* (Prov. xxxi, 22, 24) we know not: the prob-

ability is that the latter name passed from the material to a particular kind of robe. Silk was not introduced until a very late period (Rev. xviii, 12): the term *mesit*' (מֵשִׁי; Sept. *τρίχαπρον*; Ezek. xvi, 10) is of doubtful meaning. See SILK. The use of a mixed material, *shaatnez*' (שְׂאֵתֶזֶז; Sept. *κισβήλον*, i. e. *sermionius*; Aquila, *ἀντιδιακείμενον*; Ven. Gr. *ἐριδιών*), such as wool and flax, was forbidden (Lev. xix, 19; Deut. xxii, 11), on the ground, according to Josephus (*Ant.* iv, 8, 11), that such was reserved for the priests, or as being a practice usual among idolaters (Spencer, *Leg. Heb. Rit.* ii, 82), but more probably with the view of enforcing the general idea of purity and simplicity. See DIVERSE.

2. *Color and Decoration*.—The prevailing color of the Hebrew dress was the natural white of the materials employed, which might be brought to a high state of brilliancy by the art of the fuller (Mark ix, 3). Some of the terms applied to these materials (e. g. שָׁבֵץ, גָּבֵץ, רִוּוּ) are connected with words significant of whiteness, while many of the allusions to garments have special reference to this quality (Job xxxviii, 14; Psa. civ, 1, 2; Isa. lxiii, 8): white was held to be peculiarly appropriate to festive occasions (Eccl. ix, 8; comp. Horace, *Sat.* ii, 2, 60), as well as symbolical of purity (Rev. iii, 4, 5; iv, 4; vii, 9, 13). It is uncertain when the art of dyeing became known to the Hebrews; the שֵׁטֶרֶץ קִרְבָּתָי, *ketso' neth passim'* worn by Joseph (Gen. xxxvii, 3, 28) is variously taken to be either a "coat of divers colors" (Sept. *ποικίλος*; Vulgate *polymia*; comp. the Greek *πάσσαι*, *Il.* iii, 126; xxii, 441), or a tunic furnished with sleeves and reaching down to the ankles, as in the versions of Aquila, *δοτραγάλιος*, *καρπωτός*, and Symmachus, *χειριδωτός*, and in the Vulg. (2 Sam. xiii, 18) *talarius*, and as described by Josephus (*Ant.* vii, 8, 1). The latter is probably the correct sense, in which case we have no evidence of the use of variegated robes previously to the sojourn of the Hebrews in Egypt, though the notice of scarlet thread (Gen. xxxviii, 28) implies some acquaintance with dyeing, and the light summer robe (שֵׁטֶרֶץ; Sept. *θέριστρον*; A. V. "veil") worn by Rebekah and Tamar (Gen. xxiv, 65; xxxviii, 14, 19) was probably of an ornamental character. The Egyptians had carried the art of weaving and embroidery to a high state of perfection, and from them the Hebrews learned various methods of producing decorated stuffs. The elements of ornamentation were, (1) weaving with threads previously dyed (Exod. xxxv, 25; compare Wilkinson's *Egyptians*, iii, 125); (2) the introduction of gold thread or wire (Exod. xxviii, 6 sq.); (3) the addition of figures, probably of animals and hunting or battle scenes (comp. Layard, ii, 297), in the case of garments, in the same manner as the cherubim were represented in the curtains of the tabernacle (Exod. xxvi, 1, 31; xxxvi, 8, 35). These devices may have been either woven into the stuff, or cut out of other stuff and afterwards attached by needlework: in the former case the pattern would appear only on one side, in the latter the pattern might be varied. Such is the distinction, according to Talmudical writers, between *cutting-work* and *needlework*, or as marked by the use of the singular and dual number, *קִרְבָּתָי*, *needlework*, and *בִּימֵי קִרְבָּתָי*, *needlework on both sides* (Judg. v, 30), though the latter term may after all be accepted in a simpler way as a dual = *two embroidered robes* (Bertheau, *Comm.* in l. c.). The account of the corslet of Amasis (Herod. iii, 47) illustrates the processes of decoration described in Exodus. Robes decorated with gold (רִוּוּ בְּזָהָב, Psa. xlv, 18), and at a later period with silver thread (Josephus, *Ant.* xix, 8, 2; comp. Acts xii, 21), were worn by royal personages: other kinds of robes were worn by the wealthy both of Tyre (Ezek. xvi, 13) and Palestine (Judg. v, 30; Psa. xlv, 14). The art does not appear

to have been maintained among the Hebrews: the Babylonians and other Eastern nations (Josh. vii, 21; Ezek. xxvii, 24), as well as the Egyptians (Ezek. xxvii, 7), excelled in it. Nor does the art of dyeing appear to have been followed up in Palestine: dyed robes were imported from foreign countries (Zeph. i, 8), particularly: from Phœnicia, and were not much used on account of their expensiveness: purple (Prov. xxxi, 22; Luke xvi, 19) and scarlet (2 Sam. i, 24) were occasionally worn by the wealthy. The surrounding nations were more lavish in their use of them: the wealthy Tyrians (Ezek. xxvii, 7), the Midianitish kings (Judg. viii, 26), the Assyrian nobles (Ezek. xxiii, 6), and Persian officers (Est. viii, 15), are all represented in purple. The general hue of the Persian dress was more brilliant than that of the Jews: hence Ezekiel (xxiii, 12) describes the Assyrians as כְּלִימָהּ לִי, lit. *clothed in perfection*; according to the Sept. *εἰς ἀπόφα*, wearing robes with handsome borders. With regard to the head-dress in particular, described as כִּיבִיטִים (Sept. *χιβίτις βαρταί*; A. V. "dye'd attire;" comp. Ovid, *Met.* xiv, 654, *mitra picta*), some doubt exists whether the word rendered dyed does not rather mean *flowing* (Ges. *Thesaur.* p. 542; Layard, ii, 308).

3. *The Names, Forms, and Mode of wearing the Robes.*—It is difficult to give a satisfactory account of the various articles of dress mentioned in the Bible: the notices are for the most part incidental, and refer to a lengthened period of time, during which the fashions must have frequently changed; while the collateral sources of information, such as sculpture, painting, or contemporary records, are but scanty. The general characteristics of Oriental dress have indeed preserved a remarkable uniformity in all ages: the modern Arabs dress much as the ancient Hebrews did; there are the same flowing robes, the same distinction between the outer and inner garments—the former heavy and warm, the latter light, adapted to the rapid and excessive changes of temperature in those countries; and there is the same distinction between the costume of the rich and the poor, consisting in the multiplication of robes of a finer texture and more ample dimensions. Hence the numerous illustrations of ancient costume, which may be drawn from the usages of modern Orientals, supplying in great measure the want of contemporaneous representations. With regard to the figures which some have identified as Jews in Egyptian paintings and Assyrian sculptures, we cannot but consider the evidence insufficient. The figures in the painting at Beni Hassan, delineated by Wilkinson (*Ancient Egypt.* ii, 296), and supposed by him to represent the arrival of Joseph's brethren, are dressed in a manner at variance with our ideas of Hebrew costume: the more important personages wear a double tunic, the upper one constructed so as to pass over the left shoulder and under the right arm, leaving the right shoulder exposed: the servants wear nothing more than a skirt or kilt, reaching from the loins to the knee. Wilkinson suggests some collateral reasons for doubting whether they were really Jews; to which we may add a further objection that the presents which these persons bring with them are not what we should expect from Gen. xliii, 11. Certain figures inscribed on the face of a rock at Behistun (q. v.), near Kermanshah, were supposed by Sir R. K. Porter to represent Samaritans captured by Shalmaneser: they are given in Vaux's *Nineveh*, p. 372. These sculptures are now recognised as of a later date, and the figures evidently represent people of different nations, for the tunics are alternately short and long. Again, certain figures discovered at Nineveh have been pronounced to be Jews: in one instance the presence of hats and boots is the ground of identification (Bonomi, *Nineveh*, p. 197; compare Dan. iii, 21); but if, as we shall hereafter show, the original words in Daniel have been misunderstood by our translators, no conclusion can be drawn from

the presence of these articles. In another instance the figures are simply dressed in a short tunic, the sleeves reaching nearly to the elbow, and covering the waist by a girdle, a style of dress which was widely spread throughout the East that it is impossible to pronounce what particular nation they may belong to: the style of head-dress seems a confirmation to the supposition that they are Jews. Their names are given in Bonomi's *Nineveh*, p. 381.

The costume of the men and women was very similar; there was sufficient difference, however, to mark the sex, and it was strictly forbidden to a woman wear the appendages (כִּבִּיטִים; Sept. *κίβιτις*), such as the staff, signet-ring, and other ornaments, or, according to Josephus (*Ant.* iv, 8, 45), the weapons of a man: as well as to a man to wear the outer robe (כִּיבִיטִים) of a woman (Deut. xxii, 5): the reason of the prohibition, according to Maimonides (*Mor. Nebok.* iii, 4, 1), being: that such was the practice of idolaters (comp. *Carpius Appar.* p. 514); but more probably it was based on the general principle of propriety. (See Mill, *Dissect.* p. 196 sq.; Carpius, *De mundo mulieris curi & deridictio*, Rost. 1752.)

a. Robes common to the sexes. (1.) The *ketseh* (כֵּתֶשֶׁת) whence the Greek *χιτών* was the most essential article of dress. It was a closely-fitting garment resembling in form and use our *skirt*, though unfortunately translated "coat" in the A. V. The material of which it was made was either wool, cotton, or linen. From Josephus's observation (*Ant.* iii, 7, 4) with regard to the *meil* (that it was *οὐκ ἐκ ὀστέων προσημαίνετο*) we may probably infer that the ordinary *ketseh* tunic was made in two pieces, which were sewn together at the sides. In this case the seamless *skirt* (*χιτών ἀρραφος*) worn by our Lord (John xix, 23) was either a singular one, or, as is more probable, was the upper tunic or *meil*. The primitive *ketseh* was without sleeves, and reached only to the knee, like the Doric *χιτών*; it may also have been, like the latter, partially opened at one side, so that a person in rapid motion was exposed (2 Sam. vi, 20). Another kind, which we may compare with the Ionian *χιτών*, reached to the wrists and ankles: such was probably the *ketheoneth passim* worn by Joseph (Gen. xxxvii, 3, 25) and Tamar (2 Sam. xiii, 18), and that which the priests wore (Josephus, *Ant.* iii, 7, 2). It was in either case kept close to the body by a girdle (q. v.), and the fold formed by the overlapping of the robe served as an inner pocket, in which a letter or any other small article might be carried (Joseph. *Ant.* xvii, 5, 7). A person wearing the *ketheoneth* alone was described as כִּבִּיטִים *stripped*: we may compare the use of the term *χιτών* as applied to the Spartan virgins (Plut. *Lyc.* 14), of the Latin *nudus* (Virgil, *Georg.* i, 299), and of our expression *stripped*. Thus it is said of Saul, after having taken off his upper garments (כִּבִּיטִים, 1 Sam. xix, 24); of Isaiah (Isa. xx, 2) when he had put off his *sub-cloth*, which was usually worn over the tunic (comp. Jon. iii, 6), and only on special occasions next the *skirt* (2 Kings vi, 30); of a warrior who has cast off his military cloak (Amos ii, 16; comp. Livy, iii, 23, *armis nudique*); and of Peter without his fisher's coat (John xxi, 7). The same expression is elsewhere applied to the poorly clad (Job xxii, 6; Isa. lviii, 7; James i, 15).

The annexed wood-cut (fig. 1) represents the simplest style of Oriental dress, a long loose shirt or *ketheoneth* without a girdle, reaching nearly to the ankle. The same robe, with the addition of the *girdle*, is shown in fig. 4. In fig. 2 we have the ordinary dress of the modern Bedouin; the tunic overlaps the girdle at the waist, leaving an ample fold, which serves as a pocket. Over the tunic he wears the *abba*, or striped plaid, which completes his costume.

(2.) The *sachin* (שָׂכִין) appears to have been a wrap-



Fig. 1. An Egyptian. Fig. 2. A Bedouin.

of fine linen (Sept. *σινδών*), which might be used various ways, but especially as a night-shirt (Mark 51; comp. Herod. ii, 95; Schleusner's *Lex. in N. N.* v.). (The Hebrew term is given in the Syriac T. as = *σουδάριον*, Luke xix, 20, and *λέντιον*, John i, 4.) The material or robe is mentioned in Judg. i, 12, 13 ("sheet," "shirt"), Prov. xxxi, 24, and i, iii, 28 ("fine linen"); but in none of these passages is there anything to decide its specific meaning. The Talmudical writers occasionally describe the *tallith* der that name, as being made of fine linen: hence nightfoot (*Exercitations* on Mark xiv, 51) identifies a *σινδών* worn by the young man as a *tallith*, which had put on in his haste without his other garments.

(3.) The *meil* (מַעֲיָה) was an upper or second tunic, the difference being that it was longer than the first. It is hence termed in the Sept. *ὑποδύτης ποδήρης*, and obviously in this sense the term is applied to the *kethoth passim* (2 Sam. xiii, 18), implying that it reached down to the feet. The sacerdotal *meil* is elsewhere ascribed. See PRIZER. As an article of ordinary dress it was worn by kings (1 Sam. xxiv, 4), prophets (1 Sam. xxviii, 14), nobles (Job i, 20), and youths (1 Sam. ii, 19). It may, however, be doubted whether the term is used in its specific sense in these passages, and not rather in its broad etymological sense from *כָּבַד*, to cover, for any robe that chanced to be worn over the *kethaneth*. In the Sept. the renderings vary between *ἐπενδύτης* (1 Sam. xviii, 4; 2 Sam. xiii, 8; 1 Sam. ii, 19, Theodot.), a term properly applied to an upper garment, and specially used in John xxi, 5, for the linen coat worn by the Phœnician and Syrian fishermen (Theophyl. in l. c.), *διπλοῖς* (1 Sam. ii, 9; xv, 27; xxiv, 4, 11; xxviii, 14; Job xxix, 14), *μάτια* (Job i, 20), *σφόλη* (1 Chron. xv, 27; Job ii, 12), and *ὑποδύτης* (Exod. xxxix, 21; Lev. viii, 7), showing that, generally speaking, it was regarded as an upper garment. This further appears from the passages in which notice of it occurs: in 1 Sam. xviii, 4, it is the "robe" which Jonathan first takes off; in 1 Sam. xviii, 14, it is the "mantle" in which Samuel is enveloped; in 1 Sam. xv, 27, it is the "mantle," the skirt of which is rent (comp. 1 Kings xi, 80, where the *מַעֲיָה*, *samlak'*, is similarly treated); in 1 Sam. xxiv, 4, it is the "robe" under which Saul slept (generally the *ἄβδα*, *be'ged*, was so used); and in Job i, 20; ii, 12, it is the "mantle" which he rends (comp. Ezra ix, 3, 5); in these passages it evidently describes an outer robe, whether the *samlak'*, or the *meil* itself used as a *samlak'*. Where two tunics are mentioned (Luke iii, 11) as being worn at the same time, the second would be a *meil*; travellers generally wore two (Joseph. *Ant.*

xvii, 5, 7), but the practice was forbidden to the disciples (Matt. x, 10; Luke ix, 8).

The dress of the middle and upper classes in modern Egypt (fig. 8) illustrates the customs of the Hebrews. In addition to the shirt, they wear a long vest of striped silk and cotton, called *kaftan*, descending to the ankles, and with ample sleeves, so that the hands may be concealed at pleasure. The girdle surrounds this vest. The outer robe consists of a long cloth coat, called *gibbeh*, with sleeves reaching nearly to the wrist. In cold weather the *abba* is thrown over the shoulders.

(4.) The ordinary outer garment consisted of a quadrangular piece of woollen cloth, probably resembling in shape a Scotch plaid. The size and texture would vary with the means of the wearer. The Hebrew terms referring to it are — *samlak'* (סַמְלָק), occasionally *מַעֲיָה*, which appears to have had the broadest sense, and some times is put for clothes generally (Gen. xxxv, 2; xxxvii, 34; Exod. iii, 22; xxii, 9; Deut. x, 18; Isa. iii, 7; iv, 1), though once used specifically of the warrior's cloak (Isa. ix, 5); *be'ged* (בֵּגֶד), which is more usual in speaking of robes of a handsome and substantial character (Gen. xxvii, 15; xli, 42; Exod. xxviii, 2; 1 Kings xxii, 10; 2 Chron. xviii, 9; Isa. lxiii, 1); *kesuth'* (כֶּסֶת), appropriate to passages where covering or protection is the prominent idea (Exod. xxii, 26; Job xxvi, 6; xxxi, 19); and, lastly, *tebush'* (טֵבֹשֶׁת), usual in poetry, but specially applied to a warrior's cloak (2 Sam. xx, 8), priests' vestments (2 Kings x, 22), and royal apparel (Esth. vi, 11; viii, 15). A cognate term, *malbush'* (מַלְבֹּשֶׁת), describes specifically a state dress, whether as used in a royal household (1 Kings x, 5; 2 Chron. ix, 4) or for religious festivals (2 Kings x, 22); elsewhere it is used generally for robes of a handsome character (Job xxvii, 16; Isa. lxiii, 8; Ezek. xvi, 18; Zeph. i, 8). Another term, *mad* (מַד), with its derivatives *מִדְיָה*, Psa. cxxxiii, 2, and *מִדְיָה*, 2 Sam. x, 4; 1 Chron. xix, 4), is expressive of the length of the Hebrew garments (1 Sam. iv, 12; xviii, 4), and is specifically applied to a long cloak (Judg. iii, 16; 2 Sam. xx, 8), and to the priest's coat (Lev. vi, 10). The Greek terms *ἱμάτιον* and *σφόλη* express the corresponding idea, the latter being specially appropriate to robes of more than ordinary grandeur (1 Macc. x, 21; xiv, 9; Mark xii, 38; xvi, 5; Luke xv, 22; xx, 46; Rev. vi, 11; vii, 9, 13); the *γίτων* and *ἱμάτιον* (A. V. "coat," "cloak," *Vulg. tunica, pallium*) are brought into juxtaposition in Matt. v, 40, and Acts ix, 39. The *be'ged* might be worn in various ways, either wrapped round the body, or worn over the shoulders, like a shawl, with the ends or "skirts" (סִרְטָוִת; Sept. *περύγια*; *Vulg. anguli*) hanging down in front; or it might be thrown over the head so as to conceal the face (2 Sam. xv, 30; Esth. vi, 12). The ends were skirted with a fringe, and bound with a dark purple ribbon (Num. xv, 38): it was confined at the waist by a girdle, and the fold (סִרְיָה; Sept. *κόλπος*; *Vulg. sinus*) formed by the overlapping of the robe served as a pocket in which a considerable quantity of articles might be carried (2 Kings iv, 39; Psa. lxxix, 12; Hag. ii, 12; Niebuhr, *Description*, p. 56), or as a purse (Prov. xvii, 28; xxi, 14; Isa. lxxv, 6, 7; Jer. xxxii, 18; Luke vi, 38).



Fig. 8. An Egyptian of the upper classes.

The ordinary mode of wearing the outer robe, called

abba or *abáyek*, at the present time, is exhibited in figs. 2 and 5. The arms, when falling down, are completely covered by it, as in fig. 5; but in holding any weapon, or in active work, the lower part of the arm is exposed, as in fig. 2.



Figs. 4, 5. Egyptians of the lower Orders.

b. The dress of the women differed from that of the men in regard to the outer garment, the *kethometh* being worn equally by both sexes (Cant. v, 8). The names of their distinctive robes were as follows: (1) *mitpach'ath* (מִטְפַּח'אֵת; Sept. περιζώμα; Vulg. pallium, *lincomen*; A. V. "veil," "wimple"), a kind of shawl (Ruth iii, 15; Isa. iii, 22); (2) *maataphah'* (מַאֲטָפָה; Vulg. palliolum; A. V. "mantle"), another kind of shawl (Isa. iii, 22), but how differing from the one just mentioned we know not: the etymological meaning of the first name is *expansion*, of the second *enveloping*; (3) *isa'iph* (יֵסָאִיפ; θήριον; "veil"), a robe worn by Rebekah on approaching Isaac (Gen. xxiv, 65), and by Tamar when she assumed the guise of a harlot (Gen. xxxviii, 14, 19)—it was probably, as the Sept. represents it, a light summer dress of handsome appearance (περιβάλε τὸ θήριον καὶ ἐκάλωπισατο, Gen. xxxviii, 14), and of ample dimensions, so that it might be thrown over the head at pleasure; (4) *radid'* (רָדִיד; "veil"), a similar robe (Isa. iii, 23; Cant. v, 7), and substituted for the *tsaph* in the Chaldee version—we may conceive of these robes or shawls as resembling the *peplum* of the Greeks, which might be worn over the head (as represented in Smith's *Dict. of Ant.* p. 753), or again as resembling the *habarah* and *milyek* of the modern Egyptians (Lane, i, 73, 75); (5) *pethigil'* (פֶּתִיגִיל; χιτών μεσοπρόσθιος; "stomacher"), a term of doubtful origin, but probably significant of a gay holiday dress (Isa. iii, 24)—to the various explanations enumerated by Gesenius (*Theaur.* p. 1187), we may add one proposed by Saalchutz (*Archæol.* i, 81), פֶּתִיגִיל, *wide* or *foolish*, and גִּיל, *pleasure*, in which case it = *unbridled pleasure*, and has no reference to dress at all; (6) *gilyonim'* (גִּלְיוֹנִים, Isa. iii, 23), also a doubtful word, explained in the Sept. as a transparent dress, i. e. of gauze (διφανή λακωνικά)—Schroeder (*De Vest. mul. Heb.* p. 311) supports this view, but perhaps the word means, as in the A. V., "*glasses*." The garments of females were terminated by an ample border or fringe (שֵׁבֶל; σκίρθα; *skirts*), which concealed the feet (Isa. xlvi, 2; Jer. xlii, 22).

Figs. 6 and 7 illustrate some of the peculiarities of female dress: the former is an Egyptian woman (in



Fig. 6. An Egyptian Woman. Fig. 7. A Woman of the southern province of Upper Egypt.

her walking dress); the latter represents a dress probably of great antiquity, still worn by the women of the south of Europe: the outer robe, or *kethometh*, is a large piece of woollen stuff wound round the body, the upper parts being attached at the shoulders; another piece of the same stuff is used for the *basin*, or *tarhah*.

c. Having now completed our description of Hebrew dress, we add a few remarks relative to the selection of equivalent terms in our own language. It must be once struck every Biblical student as a great defect in our Auth. Vers. that the same English word should represent various Hebrew words; e. g. that "veil" should be promiscuously used for *radid'* (Isa. iii, 23), *tsaph* (Gen. xxiv, 65), *mitpach'ath* (Ruth iii, 15), *isa'iph* (Exod. xxxiv, 83); "robe" for *meil* (1 Sam. xiv, 4), *kethometh* (Isa. xxii, 21), *addereth* (Jon. iii, 6), *amah* (Mic. ii, 8); "mantle" for *meil* (1 Sam. xv, 2), *addereth* (1 Kings xix, 18), *maataphah'* (Isa. iii, 23), and "coat" for *meil* (1 Sam. ii, 19), *kethometh* (Isa. iii, 21); and conversely that different English words should be promiscuously used for the same Hebrew one, as *meil* is translated "coat," "robe," "mantle," *addereth* "robe," "mantle." Uniformity would be desirable, in as far as it can be attained, so that the English reader might understand that the same Hebrew term occurred in the original text where the same English term was found in the translation. Beyond uniformity, correctness of translation would also be desirable: the difficulty of attaining this in the subject of dress, with regard to which the customs and associations are so widely at variance in our own country and in the East, is very great. Take, for instance, *kethometh*: at once an under garment, and yet not so frequently worn without anything over it—a *skirt*—being worn next the skin, and a *coat*, as being the upper garment worn in a house: deprive the Hebrew of his *kethometh*, and he was positively naked; deprive the Englishman of his *coat*, and he has under garments still. So again with the *beged*: in shape probably a Scotch *plaid*, but the use of such a term would be unintelligible to most English readers: in use with any garment with which we are familiar, for we do wear a *great-coat* or a *cloak* in bad weather, whereas the Hebrew and his *beged* were inseparable. With such difficulties attending the subject, any attempt to render the Hebrew terms must be, more or less, a compromise between correctness and modern usage, and the English terms which we are about to propose must be regarded merely in the light of suggestions. *Kethometh* answers in many respects to "frock": the sailor's "frock" is constantly worn next the skin as

er with or without a coat over it; the "smock-k" is familiar to us as an upper garment, and still of kind of undress. In shape and material these correspond with *kethonet*, and, like it, the term "cloak" is applied to both sexes. In the sacerdotal a more technical term might be used: "vest-it," in its specific sense as = the chasuble, or *casu*- would represent it very aptly. *Meil* may perhaps best rendered "gown," for this too applies to both sexes; and, when to men, always in an official sense, he academic gown, the alderman's gown, the barber's gown, just as *meil* appears to have represented official, or, at all events, a special dress. In sacerdotal dress "alb" exactly meets it, and retains still, the Greek Church, the very name, *podetis*, by which *meil* is described in the Sept. The sacerdotal *od* approaches, perhaps, most nearly to the term all," the *ὑμφορόσιον* of the Greek Church, which may compare with the *επιμύτις* of the Sept. *Adde* answers in several respects to "pédise," although term is now applied almost exclusively to female ss. *Sadim* = "linen wrapper." *Simlah* we would der "garment," and in the plural "clothes," as of broadest term of the kind; *bege* "vestment," as of superior quality; *lebus* "robe," as still superior; *mad* "cloak," as being long; and *malbus* dress," in the specific sense in which the term is not frequently used as = *fine* dress. In female costume *tpachath* might be rendered "shawl," *maatpapha* nantle," *tsaph* "handsome dress," *radid* "cloak." *d*. In addition to these terms, which we have thus extracted from the Bible, we have in the Talmud writers an entirely new nomenclature. The *tal* (טלית) is frequently noticed: it was made of fine linen, and had a fringe attached to it, like the *bege*; was of ample dimensions, so that the head might be developed in it, as was usual among the Jews in the t of prayer. The *kolbin* (קולבין) was probably other name for the *tallith*, derived from the Greek *λόβιον*; Epiphanius (i, 15) represents the *σρολαι* of e Pharisees as identical with the *Dalmatica* or the *lobism*; the latter, as known to us, was a close tunic without sleeves. The *chaluk* (חלוק) was a wool-n shirt, worn as an under tunic. The *mactoren* (מקטרן) was a mantle or outer garment (comp. *ightfoot*, *Exercitation* on Matt. v, 40; Mark xiv, 51; uke ix, 3, etc.). Gloves (קפזים or קפז) are also noted (*Chelim*, xvi, 6; xxiv, 15; xxvi, 8), not, however, as worn for luxury, but for the protection of the and in manual labor.

With regard to other articles of dress, see GIRDLE; [ANDKERCHIEF; HEAD-DRESS; HEM OF GARMENT; ANDALS; SHOES; VEL; also the several words above used in the A. V.

e. The dresses of *foreign nations* are occasionally referred to in the Bible; that of the Persians is described in Dan. iii, 21 in terms which have been variously understood, but which may be identified with the statements of Herodotus (i, 195; vii, 61) in the following manner: (1) The *earbalim* (ארבלים; A. V. "coats") = *ivaξpύδες*, or *drawers*, which were the distinctive feature in the Persian as compared with the Hebrew dress; (2) the *pattish* (פטיש; A. V. "hosen") = *τιθών τοδρηνης λινος*, or inner tunic; (3) the *karbela* (קרבלה; A. V. "hat") = *ἄλλος εἰρίνεος κίθων*, or upper tunic, corresponding to the *meil* of the Hebrews; (4) the *lebus* (לבש; A. V. "garment") = *χλανιδιον λευκόν*, or cloak, which was worn, like the *bege*, over all. In addition to these terms, we have notice of a robe of state of fine linen, *talrik* (תלריק; *διάδημα*; *sericum pallium*), so called from its ample dimensions (Esth. vii, 15). The same expression is used in the Chaldee for *purple garments* in Ezek. xxvii, 16.

The references to Greek or Roman dress are few; the *χλαμύς* (2 Macc. xii, 85; Matt. xxvii, 28) was either the *paludamentum*, the military scarf of the Roman soldiery, or the Greek *chlamys* itself, which was introduced under the emperors (Smith's *Dict. of Ant. s. v. Chlamys*); it was especially worn by officers. The travelling *cloak* (*φιλόνυξ*) referred to by Paul (2 Tim. iv, 13) is generally identified with the Roman *paenula*, of which it may be a corruption; the Talmudical writers have a similar name (קלמן or קלמן). It is, however, otherwise explained as a travelling case for carrying clothes or books (Conybeare, *St. Paul*, ii, 499).

4. The customs and associations connected with dress are numerous and important, mostly arising from the peculiar form and mode of wearing the outer garments. The *bege*, for instance, could be applied to many purposes besides its proper use as a vestment; it was sometimes used to carry a burden (Exod. xii, 34; Judg. viii, 25; Prov. xxx, 4), as Ruth used her shawl (Ruth iii, 15); or to wrap up an article (1 Sam. xxi, 9); or again as an *improptu* saddle (Matt. xxi, 7). Its most important use, however, was a coverlet at night (Exod. xxii, 27; Ruth iii, 9; Ezek. xvi, 8), whence the word is sometimes taken for bed-clothes (1 Sam. xix, 13; 1 Kings i, 1); the Bedouin applies his *abba* to a similar purpose (Niebuhr, *Description*, p. 56). On this account a creditor could not retain it after sunset (Ezek. xxii, 26; Deut. xxiv, 12, 13; compare Job xxii, 6; xxiv, 7; Amos ii, 8). The custom of placing garments in pawn appears to have been very common, so much so that *קבוצ*, *pledge* = a garment (Deut. xxiv, 12, 13); the accumulation of such pledges is referred to in Hab. ii, 6 (*that loadeth himself with קבוצים*, i. e. *pledges*; where the A. V. following the Sept. and Vulg. reads קבוצ, "thick clay"); this custom prevailed in the time of our Lord, who bids his disciples give up the *imátiou* = *bege*, in which they slept, as well as the *χιτών* (Matt. v, 40). At the present day it is not unusual to seize the *abba* as compensation for an injury; an instance is given in Wortabet's *Syria*, i, 298.

The loose, flowing character of the Hebrew robes admitted of a variety of symbolical actions: rending them was expressive of various emotions, as grief (Gen. xxxvii, 29, 34; Job i, 20; 2 Sam. i, 2) [see *MDURNING*], fear (1 Kings xxi, 27; 2 Kings xxii, 11, 19), indignation (2 Kings v, 7; xi, 14; Matt. xxvi, 65), or despair (Judg. xi, 85; Esth. iv, 1); generally the outer garment alone was thus rent (Gen. xxxvii, 34; Job i, 20; ii, 12), occasionally the inner (2 Sam. xv, 32), and occasionally both (Ezra ix, 3; Matt. xxvi, 65, compared with Mark xiv, 63). Shaking the garments, or shaking the dust off them, was a sign of renunciation (Acts xviii, 6); spreading them before a person, of loyalty and joyous reception (2 Kings ix, 18; Matt. xxi, 8); wrapping them round the head, of awe (1 Kings xix, 18) or of grief (2 Sam. xv, 30; Esth. vi, 12; Jer. xiv, 3, 4); casting them off, of excitement (Acts xxii, 28); laying hold of them, of supplication (1 Sam. xv, 27; Isa. iii, 6; iv, 1; Zech. viii, 28).

The length of the dress rendered it inconvenient for active exercise; hence the outer garments were either left in the house by a person working close by (Matt. xxiv, 18), or were thrown off when the occasion arose (Mark x, 50; John xiii, 4; Acts vii, 58), or, if this was not possible, as in the case of a person travelling, they were girded up (1 Kings xviii, 46; 2 Kings iv, 29; ix, 1; 1 Pet. i, 18); on entering a house the upper garment was probably laid aside, and resumed on going out (Acts xii, 8). In a sitting posture, the garments concealed the feet; this was held to be an act of reverence (Isa. vi, 2; see Lowth's note). The proverbial expression in 1 Sam. xxv, 22; 1 Kings xiv, 10; xxi, 21; 2 Kings ix, 8, probably owes its origin to the length of the garments, which made another habit more natural (comp. Herod. ii, 85; Xenoph. *Cyrop.* i,

2, 16; Ammian. Marcell. xxiii, 6); the expression is variously understood to mean the *loveliest* or the *youngest* of the people (Ges. *Thesaur.* p. 1897; Jahn, *Archäol.* i, 8, § 120). To cut the garments short was the grossest insult that a Jew could receive (2 Sam. x, 4; the word there used קָצַץ is peculiarly expressive of the length of the garments). To raise the border or skirt of a woman's dress was a similar insult, implying her unchastity (Isa. xlvii, 2; Jer. xiii, 22, 26; Nah. iii, 5).

The putting on and off of garments, and the ease with which it was accomplished, are frequently referred to; the Hebrew expressions for the first of these operations, as regards the outer robe, are לָבַשׁ , *labash'*, to put on, אָחַז , *atah'*, קָסַח , *kasah'*, and אָטַף , *ataph'*, lit. to cover, the latter three having special reference to the amplitude of the robes; and for the second פָּתַח , *pathach'*, lit. to expand, which was the natural result of taking off a wide, loose garment. The ease of these operations forms the point of comparison in Psa. cii, 26; Jer. xliii, 12. In the case of closely-fitting robes the expression is חָגַר , *chagar'*, lit. to gird, which is applied to the ephod (1 Sam. ii, 18; 2 Sam. vi, 14), to sackcloth (2 Sam. iii, 31; Isa. xxxiii, 11; Jer. iv, 8); the use of the term may illustrate Gen. iii, 7, where the garments used by our first parents are called חֲגוֹרֹת , *chagoroth'* (A. V. "aprons"), probably meaning such as could be wound round the body. The converse term is פָּתַח , *pathach'*, to loosen or unbind (Psa. xxx, 11; Isa. xx, 2).

The number of suits possessed by the Hebrews was considerable; a single suit consisted of an under and upper garment, and was termed $\text{שְׂרָדִים וְעִטָּה}$ (Sept. $\sigma\tau\omicron\lambda\eta\ \iota\mu\alpha\tau\iota\omega\nu$, i. e. *apparatus vestium*; Judg. xvii, 10). Where more than one is spoken of, the suits are termed $\text{שְׂרָדִים וְעִטָּה$ (*ἀλλασσόμενα στολαί*; A. V. "changes of raiment;" compare Homer, *Od.* viii, 249, *εἴματα ἔημοιῦσά*). These formed in ancient times one of the most usual presents among Orientals (Harmer, *Observations*, ii, 379 sq.); five (Gen. xiv, 22) and even ten changes (2 Kings v, 5) were thus presented, while as many as thirty were proposed as a wager (Judg. xiv, 12, 19). The highest token of affection was to present the robe actually worn by the giver (1 Sam. xviii, 4; comp. Homer, *Il.* vi, 280; Harmer, ii, 388). The presentation of a robe in many instances amounted to installation or investiture (Gen. xli, 42; Esth. viii, 15; Isa. xxii, 21; comp. Morier, *Second Journey*, p. 98); on the other hand, taking it away amounted to dismissal from office (2 Macc. iv, 38). The production of the best robe was a mark of special honor in a household (Luke xv, 22). The number of robes thus received or kept in store for presents was very large, and formed one of the main elements of wealth in the East (Job xxvii, 16; Matt. vi, 19; James v, 2), so that to *have clothing* = to be wealthy and powerful (Isa. iii, 6, 7). On grand occasions the entertainer offered becoming robes to his guests (Trench on *Parables*, p. 281). Hence in large households a wardrobe (בֵּית הַבְּגָדִים) was required for their preservation (2 Kings x, 22; compare Harmer, ii, 382), superintended by a special officer, named $\text{שֹׁמֵר הַבְּגָדִים}$, *keeper of the wardrobe* (2 Chron. xxxiv, 22). Robes reserved for special occasions are termed $\text{בְּגָדֵי מַעֲשֵׂה אֱלֹהִים}$ (A. V. "changeable suits;" Isa. iii, 22; Zech. iii, 4), because laid aside when the occasion was past.

The color of the garment was, as we have already observed, generally white; hence a spot or stain readily showed itself (Isa. lxiii, 3; Jude 23; Rev. iii, 4); reference is made in Lev. xiii, 47 sq. to a greenish or reddish spot of a leprosy character. Jahn (*Archäol.* i, 8, § 185) conceives this to be not the result of leprosy, but the depredations of a small insect; but Schilling (*De Lepra*, p. 192) states that leprosy taints clothes,

and adds "the spots are altogether indelible, and rather to spread than lessen by washing" (*Ann. Comm.* in l. c.). Frequent washings and the application of the fuller's art were necessary to preserve the purity of the Hebrew dress. See SOAP; FELLS.

The business of making clothes devolved upon women in a family (Prov. xxi, 22; Acts ix, 39); but it was required in what we may term the *tailoring* department; the garments came forth for the most part ready made from the loom, so that the weaver employed the tailor. The references to sewing are therefore few: the term תָּפַח *taphar'* (Gen. iii, 7; Job v, 15; Eccles. iii, 7; Ezek. xiii, 18) was applied by the later Jews to *mending* rather than making clothes.

The Hebrews were liable to the charge of extravagance in dress; Isaiah in particular (iii, 16 sq.) denounces the numerous robes and ornaments worn by the women of his day. The same subject is referred to Jer. iv, 30; Ezek. xvi, 10; Zeph. i, 8, and Eccl. i, 4, and in a later age 1 Tim. ii, 9; 1 Pet. iii, 3.—*see* s. v. COMP. APPAREL; ATTIRE; CLOTHING; GARNMENT; RAIMENT, &c.

DRESS OF CLERGY. See VESTMENTS.

Drew, SAMUEL, A.M., an English Methodist preacher and metaphysical writer, was born March 1, 1765, in the suburbs of St. Austle, of a poor family and learned the shoemakers' trade. In 1786, under the preaching of Adam Clarke, he became a Methodist and in 1788 he became a local preacher. Drew received no early instruction, but the passion for reading was natural to him, and he early became himself an author. But his gains from literature did not suffice for his maintenance till 1809, when he finally quit the shoe-bench. In 1819 he was invited to Liverpool to take the management of the *Imperial Magazine*, published by the Caxtons. He accepted it, and in his hands the enterprise was very successful. He drew continued to edit the magazine, after its removal to London, up to the year of his death. In 1823 he received the degree of A.M. from Marischal College, Aberdeen. His literary labors were very various; apart from the journal; he took no rest till the "wheel of life stood still," at Helston, March 29, 1833. His principal work is entitled *Treatise on the Existence and Attributes of God* (Lond. 1820, 2 vols. 8vo). Among other works are *Remarks upon the first part of the "Life of Reason,"* by Thomas Paine (1799, 3d ed.; 1820, Lond. and N. Y. 1831, 12mo);—*Observations upon the Accidents of Methodism in Pölschle* (1800);—*Essay upon the Immateriality and Immortality of the Soul* (1802; 3d ed. 1803, and N. Y. 1829, 12mo);—*Essay on the Resurrection of the Body* (1809, 8vo; 2d ed. 1822);—*Life of Le Coke* (1816, 8vo), and *History of Count Cornwallis* (1820-24, 2 vols. 4to). See *Life of Drew* by his eldest son (N. Y. 1835, 12mo); Stevens, *History of Methodism*, ii, 290; iii, 491; S. Dunn, in *The Methodist*, N. Y. Nov. 24, 1866.

Drexelius, JEREMIAS, a Jesuit, was born at Augsburg in 1581, entered the order of Jesuits at 17, was for 29 years preacher at the court of the elector Maximilian I, and died at Munich in 1658. The people worshipped him as a saint. He wrote a number of works on practical religion, which have been used even by Protestants. Collections of his works have been several times published, and some of his productions have been translated into different languages. His works, in complete editions, appeared at Cologne, 1715; Mainz, 1645; Munich, 1628; Antwerp, 1657-60. There is a new edition of his *Reflections on Eternity* (Lond. 1844, 12mo).

Drey, JOHANN SEBASTIAN VON, a Roman Catholic theologian of Germany, was born Oct. 16, 1777, at Klingen. He was ordained priest May 30, 1801; was appointed in 1806 professor at the Roman Catholic school of Bottswil, and in 1812 professor of dogmatic theology

newly-established university of Ellwangen. In he was transferred, with the whole theological y, to the University of Tübingen, at which he ed on dogmatic theology, history of doctrines, getics, and theological encyclopædia (from 1838 on the two last-named branches). He resigned 16, and died at Tübingen on February 19, 1853. was one of the ablest scholars of Roman Catholic any. He is especially known for his great work ologetics (*Christliche Apologetik*, Mainz, 1838-47, s.). He also wrote an Introduction to the Study eology (*Einführung in das Studium der Theologie*, ng, 1819), *Researches on the Apostolical Constitu- and Canons* (*Untersuchungen über die Constitutionen amones der Apostel*, Tübingen, 1832), and several works. He established, with Gratz (q. v.) and Hir- (q. v.), in 1819, the *Theologische Quartalschrift*, h is still (1868) one of the ablest journals of scient- eology published in the Roman Catholic Church. also contributed a large number of articles to the *hen-Lexikon* of Wetzer and Welte. See Hefele, *Wetzer u. Welte, Kirch.-Lex.* xii, 307.

Driedo, or Dridoens, JAN, a Roman Catholic was born at Turnhout, in Brabant. He stud- at the University of Louvain, where he was a pu- of Adrian Florent, afterwards Adrian VI, and be- e professor of theology there. In the controversy een the Lutherans and Roman Catholics he took active part; and, according to the testimony of smus, in one of his letters, disputed both coolly eadly. He died at Louvain in 1536. He te *Lib. IV de Scripturis et Dogmatibus Ecclesiasti- Lib. II de Gratia et Libero Arbitrio:—De Con- tia Liberi Arbitrii et Predestinationis:—De Captiv- e et Redemptione Generis Humani; and De Libertate istiana.*—Moreri, cited by Hook, *Eccle. Biog.* iv, 501.

Driessen, ANTONIUS, was born in the year 1684 at ard, was successively settled as pastor at Maest- and Utrecht, and was in 1717 inaugurated as fessor of theology in the University of Groningen. is position he held till released by death, Nov. 11, 8. He was a man of sincere piety and eminent ring, and was ardently attached to the doctrines e Reformed Church. He was, withal, a man of an- cholie temperament, and of an intolerant spirit. s zeal for truth, or what he regarded as such, in- vled him in many unpleasant controversies, and it, too, with some of the most eminent divines of his y—with Wittichius, his colleague, and, as a conse- quence of that, with Taco van den Honert, professor Leyden, both of whom he accused of Spinozism; th Lampe, and professor Ode, of Utrecht, whom he used of Roëllism, or heterodox views respecting e eternal generation of the Son, and the procession the Holy Spirit from the Father and the Son, the arge being founded upon Lampe's interpretation of hn v, 26, and xv, 26; with the celebrated Venema, om he charged with Arminianism; and with the rned Schultens, because he endeavored to eluci- te the Hebrew by the aid of the kindred dialects, pecially by that of the Arabic. These controversies ere all carried on in Latin, and were on both sides aracterized by the acrimony common to theological spates in those days. His writings are very volu- inous, chiefly of a polemic character, and mostly in atin. His treatise on *Evangelical Morality, or the ristian Virtues*, is written in Dutch.

Drink (the verb is expressed in Heb. by the cog- ate terms שָׁקַח, *shakah'*, and שָׁחַח, *shachah'*; Greek *ivw*). The drinks of the Hebrews were: 1. *Water* (q. v.); 2. *Wine* (q. v.); 3. *Artificial liquor* (שָׂרֵב, *si- rpa*, "strong drink" [see SHEKAR]; 4. *Vinegar* (q. v.). As drinking utensils, they made use of various rms of vessels: 1, the *cup* (q. v.), the most general rm (כַּס); 2, the *goblet* (כַּסֵּי, *covered tankard*) or

"basin" (q. v.), from which the fluid was poured into the chalice (שִׁבְרֵי, *bumper*, comp. Jer. xxxv, 5) and bowl (שִׁבְרֵי, *mixing-cup, cratera*); 3, the *jug* (שִׁבְרֵי, "cruse" or pitcher; and, 4, the *saucer* (שִׁבְרֵי, *patra*) or shallow libation dish (q. v.) Horns were probably used in the earliest times. See BEVERAGE.

The term "drink" is frequently used figuratively in the Scriptures (see Thomson, *Land and Book*, i, 496). The wise man exhorts his disciple (Prov. v, 15) to "drink water out of his own cistern;" to content himself with the lawful pleasures of marriage, with- out wandering in his affections. To eat and drink is used in Eccles. v, 18, to signify people's enjoying them- selves; and in the Gospel for living in a common and ordinary manner (Matt. xi, 18). The apostles say they ate and drank with Christ after his resurrection; that is, they conversed, and lived in their usual manner, freely, with him (Acts x, 41). Jeremiah (ii, 18) reproaches the Jews with having had recourse to Egypt for muddy water to drink, and to Assyria, to drink the water of their river; that is, the water of the Nile and of the Euphrates; meaning, soliciting the assistance of those people. To *drink blood* signifies to be satiated with slaughter (Ezek. xxxix, 18). Our Lord commands us to drink his blood and to eat his flesh (John vi): we eat and drink both figuratively in the Eucharist. To drink water by measure (Ezek. iv, 11), and to buy water to drink (Lam. v, 4), denote extreme scarcity and desolation. On fast-days the Jews ab- stained from drinking during the whole day, believing it to be equally of the essence of a fast to suffer thirst as to suffer hunger. See FAST.

DRINK, STRONG, stands in the A. V. as the render- ing of the Heb. word שָׂרֵב, *shekar'* (Græcized *oixera*, Luke i, 15), which, in its etymological sense, applies to any beverage that had *intoxicating* qualities: it is generally found connected with wine, either as an ex- haustive expression for all other liquors (e. g. Judg. xiii, 4; Luke i, 15), or as parallel to it, particularly in poetical passages (e. g. Isa. v, 11; Mic. ii, 11); in Num. xxviii, 7, and Psa. lxxix, 12, however, it stands by itself, and must be regarded as including wine. The Bible itself throws little light upon the nature of the mixtures described under this term. We may in- fer from Cant. viii, 2 that the Hebrews were in the habit of expressing the juice of other fruits besides the grape for the purpose of making wine: the pomegran- ate, which is there noticed, was probably one out of many fruits so used. In Isa. xxiv, 9 there may be a reference to the *sweetness* of some kind of strong drink. In Num. xxviii, 7, *strong drink* is clearly used as equivalent to wine, which was ordered in Exod. xxix, 40. With regard to the application of the term in later times we have the explicit statement of Jerome (*Ep. ad Nepot.*), as well as other sources of information, from which we may state that the following beverages were known to the Jews: 1. *Beer*, which was largely consumed in Egypt under the name of *zythus* (Herod. ii, 77; Diod. Sic. i, 84), and was thence introduced into Palestine (Mishna, *Peasah*, iii, 1). It was made of bar- ley; certain herbs, such as lupin and skirrett, were used as substitutes for hops (Colum. x, 114). The *boozah* of modern Egypt is made of barley-bread, crum- bled in water and left until it has fermented (Lane, i, 131): the Arabians mix it with spices (Burckhardt's *Arabia*, i, 213), as described in Isa. v, 22. The Mishna (*l. c.*) seems to apply the term *shekar* more especially to a Median drink, probably a kind of beer made in the same manner as the modern *boozah*; the Edomite *cho- mets*, noticed in the same place, was probably another kind of beer, and may have held the same position among the Jews that bitter beer does among ourselves. 2. *Cider*, which is noticed in the Mishna (*Terum.* xi, 2) as *apple-wine*. 3. *Honey-wine*, of which there were two sorts, one like the *oivomela* of the Greeks, which is no-

ticed in the Mishna (*Shabb. xx, 2*; *Terum. xi, 1*) under a Hebraized form of that name, consisting of a mixture of wine, honey, and pepper; the other a decoction of the juice of the grape, termed *debaash* (honey) by the Hebrews, and *dihs* by the modern Syrians, resembling the *εψημμα* of the Greeks and the *defrutum* of the Romans, and similarly used, being mixed either with wine, milk, or water. 4. *Date-wine*, which was also manufactured in Egypt (*ὄλιος φοινικίτιος*, Herod. ii, 86; iii, 20). It was made by mashing the fruit in water in certain proportions (Plin. xiv, 13, 3). A similar method is still used in Arabia, except that the fruit is not mashed (Burckhardt's *Arabia*, ii, 264): the palm wine of modern Egypt is the sap of the tree itself, obtained by making an incision into its heart (Wilkinson, ii, 174). 5. Various other fruits and vegetables are enumerated by Pliny (xiv, 19) as supplying materials for *factitious* or home-made wine, such as figs, millet, the carob fruit, etc. It is not improbable that the Hebrews applied *raisins* to this purpose in the simple manner followed by the Arabians (Burckhardt, ii, 377), viz., by putting them in jars of water and burying them in the ground until fermentation takes place.—Smith, s. v. See WINE.

DRINK-OFFERING (דְּרִיבָה, *ne'sek*, or דְּרִיבָה, *na-sik*; σπονδή, compare σπίνδισθα, Phil. ii, 17). One form of this consisted, according to the ritual law, of wine (Num. xv, 5; Hos. ix, 4; Sirach i, 15 [17]; compare Curt. vii, 8, 18; Pliny, xiv, 14; *Iliad*, i, 463; x, 579; *Olys.* xii, 362; on the best sorts of wine for this purpose, see the Mishna, *Menach.* viii, 6 sq.), which, according to Josephus (*Ant.* iii, 9, 4), was poured around the altar (*περὶ τὸν βωμὸν*, i. e. the burnt altar, Exod. xxx, 9), and not, as the Jews understand it (Mishna, *Succah*, iv, 9), in a channel or tube of it. Drink-offerings were commonly joined with meat-offerings (Num. vi, 15, 17; 2 Kings xvi, 13; Joel i, 9, 13; ii, 14), an addition to the burnt and thank offerings (not the sin and trespass offering), which consisted of quadrupeds (Num. vi, 17; xv, 5, 10; 1 Chron. xxix, 21; 2 Chron. xxix, 35), and were, like these, presented, sometimes by private persons and sometimes in the name of the people, daily (Exod. xxix, 40; Num. xxviii, 7), on the Sabbath (Num. xxviii, 9), and on feast-days (Num. xxviii, 14; xxix, 6, 16, 24), in such proportion that one lamb was reckoned to require one fourth of a hin of wine, one ram a third of a hin, and one bullock a half hin (Num. xv, 5 sq.; xxviii, 7, 14). In the (second) Temple liquors were kept ready for drink-offerings (Joseph. *War.* x, 13, 6), and were dispensed (Mishna, *Shekal.* v, 1, 3 and 4) by the prefect of libations (שַׁלְטַן הַדְּרִיבָה). The Israelites frequently devoted drink-offerings also to foreign deities (Isa. lvii, 6; lxx, 11; Jer. vii, 18; xix, 13; xlv, 17; Ezek. xx, 28), as throughout antiquity libations of wine were made to heathen gods (see Smith's *Dict. of Class. Antiq.* s. v. Sacrificium, p. 846). On the water-libation at the festival of booths, see TABERNACLES, FEAST OF. Libations of water occur in individual cases even prior to the exile (2 Sam. xxiii, 16; 1 Sam. vii, 6). On the other hand, Elijah poured water on the altar (1 Kings xviii, 34 sq.) merely to heighten the effect of his miracle in contrast with his idolatrous competitors (Josephus, *Ant.* viii, 13, 5). On the oil-libation of Gen. xxxv, 14, see STONE. Psalm xvi, 6 (but probably not Zech. ix, 7) appears to contain an allusion to heathenish drink-offerings consisting of wine mingled with blood (*vinum caesivatum*), which, especially when persons bound themselves to a fearful undertaking, it was customary to drink (Sallust, *Catil.* xxii, 1; Sil. Ital. ii, 426 sq.).—Winer, ii, 629. See OFFERING.

Dromedary stands in the A. V. for the following Heb. words: דְּרִיבָה, *be'ker*, Isa. lx, 6 (Sept. κάμηλος, Vulg. *dromedarius*), fem. דְּרִיבָה, *bikrah'*, Jer. ii, 23

(Sept. mistranslates *δελφί*, as if reading דְּרִיבָה, *cursor levis*), a young camel (see Bochart, *Hier.* sq.; Gesenius, *Thesaur.* p. 206); דְּרִיבָה, *levis*, i, iv, 28 (Sept. ἄμμα; Vulg. *jumentum*; A. V. *camel*, Esth. viii, 10, 14; "swift beast" in Mic. i, 10, or fleet courser (see Bochart, *Hier.* i, 95); דְּרִיבָה, *rammak'*, Esth. viii, 10 (Sept. and Vulg. *mare* paraphrase), a mare (fully דְּרִיבָה בְּנֵי דְּרִיבָה, *ha-achasterania beney ha-rammakim*, the *mare mares*, A. V. "young dromedaries"). See MULE. The dromedary is properly the Arabian species of camel (*Camelus dromedarius*), having only one hump (Wellsted, i, 204), in distinction from the Bactrian (Aristotle, *Anim.* ii, 2; Plin. 26; Apulej. *Asia.* vii, p. 152, Bip.), which has two humps (Isa. xxx, 6). It is thus the kind most spoken of in Scripture (Heb. דְּרִיבָה, *gama'*, and East Arabic *jaml*), where it is a widely-spread and exceedingly useful animal. It has a slender frame, long neck, small head and ears, and is of gray or brown (very seldom black) color of skin, usually 6½ feet high. (The Talmud, *Shabbat*, speaks of a peculiar variety, *אמרי*, which the Arabians interpret to mean the *white* camel.) The one-humped (called also *Turkish*) camel is the largest and strongest (being capable of carrying from 800 to 1,000 pounds), but is so much affected by the heat of the sun as to be unserviceable during the summer months. The one-humped camel, or proper dromedary, which everywhere met with in Syria and Palestine (Nez. xviii, 448), is the one referred to in Isa. lvi, 2; Gesenius, *Comment.* in loc.) by the term דְּרִיבָה, *karoth'* (the versions all vague or wrong: Sept. *corra dia*, Vulg. *corraeae*, A. V. "swift beasts"), which is very rapid (Burckhardt, *Bedouins*, ii, 71), and is sometimes accelerated by musical instruments (Gulist. p. 190). Its greater speed is in consequence

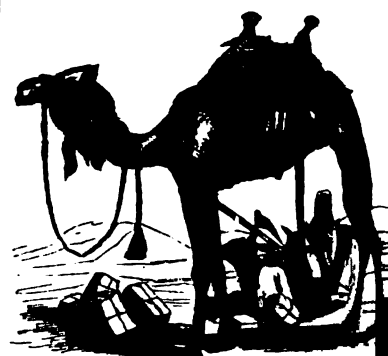

Camel of the Hammad

of a finer and more elegant structure (Nez. ii, 44; Prosp. Alp. *Res. Eg.* iv, 7, p. 200; *Trav.* i, 369), so that it can not only walk 10 miles per hour (Shaw, *Trav.* p. 149), but maintain this for a great number of days together (Pococke, *Trav.* 809; Volney, ii, 260; Huet, *Nachr. a. Mercur.* 289). They carry only 500 to 700 pounds. A dromedary is properly a camel, distinguished from the mule and horse only by its breed and training, as a mule or horse is distinguished from a cart-horse. This camel is called *swift* with respect to other camels, not with respect to other animals; for the camel is not so much a swift animal, and those most renowned for their fleetness are not in any way comparable to the horse. The best-trained camels cannot sustain a gallop above half an hour, in which, at forced speed, they may make about eight or nine miles. This is the

rest exertion. A forced trot is not so contrary to camel's nature, and it will support it for several rs without evincing any symptoms of fatigue; but a here the utmost degree of celerity of the very bred dromedary does not exceed about twelve as an hour; and it is therefore in this pace also expeditious than a moderately good horse (Kitto, *Bible*, note on Jer. ii, 23). "It is not therefore," Burckhardt, to whom we owe this statement, "by mere celerity that the *hejeins* and *delouls* are distinguished, however surprising may be the stories rd on this subject both in Europe and the East; but y are perhaps unequalled by any quadrupeds for ease with which they carry their rider through an interrupted journey of several days and nights, n they are allowed to persevere in their own favor- pace, which is a kind of easy amble, at the rate of ut five miles or five miles and a half in the hour" *Notes on the Bedouins*, p. 262). In proportion to its ght, the camel takes but little nourishment (Phi- r. Apol. i. 41): it eats in twenty-four hours a sin- meal of barley or beans (husks, Mishna, *Shabb.* 4; comp. Minutoli, *Nachtr.* p. 259; see Wellsted, i,); also dough or cakes; and in the want of all these, ss and thistles, about a pound's weight; it drinks wly (Cotovic, *Itiner.* iii, 21), after it has made the r muddy with its feet, and can go even 16 (some 20) days without drinking (Aristotle, *Anim.* viii, and Pliny, viii, 26, give only four days; but this ably means its ordinary intervals between drink- times: see Russel, *Aleppo*, ii, 84); although the bs wet with dew in the desert constantly supply isture; besides, the camel's double cell-formed stom- apparently serves as a receptacle of water, from ich it moistens its usually dry fodder, and by means rumination can even assuage its thirst. Travellers fering from want of water in the desert not unfre- quently slaughter a camel, and allay their thirst with water from its stomach, which is clear and pure. n the diseases of the camel, see Browne, *Trav.* p. 5.) Camels were in use as early as the patriarchal es (Gen. xii, 16; xxiv, 10 sq.; xxx, 43; xxxi, 17; xii, 7; compare Job i, 3; xlii, 12; see Aristotle, *Anim.* ix, 10), and in later times these animals were a ry valuable possession to the Israelites (1 Chron. xvii, 30; Tob. x, 11; Ezra ii, 67; comp. Harmer, 855); although they appear to have been less pre- vious than with the neighboring Arabic tribes (Judg. 5; vii, 12; 1 Sam. xv, 3; xxvii, 9; Gen. xxxvii, ; Jer. xlix, 32; comp. Mishna, *Shabb.* xxiv, 3; see

of wares and baggage (Gen. xxxvii, 25; Judg. vi, 5; 1 Chron. xii, 40; 1 Kings x, 2; 2 Chron. xiv, 14; 2 Kings viii, 9; Isa. xxx, 7; lx, 6; comp. Josephus, *Life*, 24; Curt. v, 6, 9), since they carry a large load (Volney, ii, 311; Lorent, *Wand.* p. 120; Russel, ii, 84; see Diod. Sic. ii, 54), and are more sure-footed in hilly regions than the ass (Wellsted, i, 205; ii, 68). They were also used for riding (Gen. xxiv, 64; 1 Sam. xxx, 17; comp. Troilo, *Trav.* p. 455; Niebuhr, *Trav.* i, 215), and women, seldom males, generally sat in a kind of basket or sedan-chair (רָגֵל, see Gesenius, *Theas.* p. 715), which was fastened on the back of the camel (Gen. xxxi, 34), being spacious, and covered on all sides (see Kämpfer, *Amoen.* p. 147; Pococke, *East*, 1, pl. 58). On account of its long but slow stride, and its light gait (Tischendorf, *Reis.* i, 258), the beast has a regular rocking motion, not disagreeable in itself to the rider, but so uniform as at length to become wearisome (Lorent, *Wander.* p. 119). Cyrus trained camels to fight (in order to make the horses of the enemy



Ancient Assyrians pursuing an Arab on a Dromedary.

turn, Herod. i, 80; Elian, *Anim.* iii, 7; comp. Pliny, viii, 26; Polyæn. vii, 6, 6), and had even a camel troop (camels ridden by horsemen, Isa. xxi, 7; comp. Xenoph. *Cyrop.* vi, 2, 8; vii, 1, 27, 48 sq.; Herod. vii, 86; on the military use of camels among other people, see Diod. Sic. ii, 54; iii, 45; Livy, xxxvii, 40; Appian, *Syr.* 32; Pollux, *Onom.* x, 8; Herodian, iv, 15, 4; Veget. iii, 23; comp. Gesen. *Comment. z. Jes.* i, 661; and Judg. vii, 12). Bonaparte, when commanding the French army in Egypt, formed a military corps mounted on dromedaries. In loading or mounting the camel, it is made, on a given signal, to fall on the knees and breast (כָּרַע וְרָגֵל; comp. Arnob. *Adv. genti.* ii, 25), and receive the burden, which hangs over the back on both sides; and when it is too heavy the animal utters a mournful cry (Pliny, viii, 26; compare Schweigger, *Reise*, p. 264; Höt, *Marokko*, p. 288; Cotovic, *Itiner.* p. 404). On the Assyrian monuments a kneeling



Loading a Camel. From the Sculptures at Kouyunjik.

camel receiving its load is found, designed with considerable truth and spirit: the legs bent under, the tail raised, the foot of the man on the neck of the animal to keep it from rising, while a second adjusts the burden from behind, form a group seen every day in the Desert and in an Eastern town (Layard, *Nin. and Bab.* p. 495). They are often stubborn and vicious, although generally tractable, except in the time of



Saddling a *Deloul*, or Dromedary.

so Afric. *Descr. Afr.* ix, p. 145; *Descr. de l'Egypte*, vi, 186). They were generally used, however (especially in the caravans of the desert), for transportation

heat (Leo Afric. ix, 80; Chardin, *Voyage*, iii, 378; comp. Jer. ii, 28); among the Arabs they are regarded as very revengeful (compare Olear. *Trav.* p. 300; hence also their name, from דָּרָא, to treat evil; see Gesenius, *Thesaur.* p. 293). They are taught to go by a touch (Kämpfer, *Amoen.* p. 724), and are guided by certain (guttural) sounds; and their necks are hung with ornaments (Judg. viii, 21, 26; see Wellsted, i, 209). Camel-drivers are called in the Talmud גַּמְלָאֵי, *gam-malin* (*Mishna*, ii, 101; iii, 74). Camels' milk has always been highly esteemed in the East as a cooling drink (Pliny, xi, 96; xxviii, 33; Aristotle, *Anim.* vi, 25; Diod. Sic. iii, 45; Niebuhr, *Trav.* i, 814; Russel, *Aleppo*, ii, 46; Buckingham, *Mesopot.* p. 142; Höst, *Marokko*, p. 288; Tischendorf, *Reise*, i, 258); when fermented it has an intoxicating quality (Pallas, *Russ.* i, 240). The flesh, especially of the hump (Freitag, *Darstell. d. Arab. Verkunst.* p. 55), is eaten by the Arabs with great relish (Aristotle, *Anim.* vi, 26; Diod. Sic. ii, 54; Herod. i, 123; Jerome, in *Jovin.* ii, 6; Höst, *Marok.* p. 288; Russel, ii, 82 sq.; Rosenmüller, *Morg.* ii, 163 sq.); to the Hebrews it was forbidden (Lev. xi, 4; see Rosenmüller in Bochart, i, 12; Michaelis, *Mos. Recht.* iv, 202). Of the hair (Talmud, *wool*, מַיְוֵה מִיַּד מִיֵּה, *Mishna*, *Chil.* vii, 1), which in the spring falls off of itself, are made coarse cloths and garments (Matt. iii, 4), and tent-covers (Buckingham, *Trav.* ii, 86; *Mesop.* p. 142; Russel, *Aleppo*, ii, 47; Harmer, iii, 856; Otho, *Lex. Rabb.* p. 114; yet fine textures of camels'-hair are also mentioned, Eilian, *Anim.* xvii, 84). Of the hide, sandals and water-skins are made, and the dung serves as fuel (Volney, i, 296). The proverb of Matt. xix, 24 also occurs in the Koran (Sur. vii, 88), and the Talmudists employ in the same sense מְיֵה דְרָא בְּקִיטָה דְרָא, *an elephant entering a needle's eye* (Buxtorf, *Lex. Talm.* col. 1722). On Matt. xxiii, 24, and other Arab and Rabbinic proverbs which are spoken of the camel, see Bochart, *Hieroz.* i, 25. See generally Bochart, i, 3 sq.; Fabri *Evagat.* ii, 381 sq.; Burckhardt, *Bedouins*, p. 167 sq.; 357 sq.; Oken, *Naturgesch.* III, ii, 704 sq.; Tilesius in the *Hall. Encyclop.* xxi, 28 sq. —Winer, i, 645. Compare CAMEL.

Drontheim (Danish *Tromdhjem*), a city in Norway, with a population in 1865 of 19,287 inhabitants. About 1020 the first episcopal see of Norway was established at Drontheim, which was thenceforward the centre of the missionary efforts for the Christianization of the country. At first the bishopric belonged to the episcopal province of Hamburg-Bremen; on the elevation of Lund to be an archiepiscopal see, Drontheim, with all the Scandinavian dioceses, became subordinate to the archbishop of Lund. In 1152 Drontheim was made the metropolitan see for all Norway, and as such it embraced seven suffragan bishops, namely, Bergen, Stavanger, Hammer, and Anslø (Opslo) in Norway, Södren in the Orkney Islands, Holum in Iceland, and Garde in Greenland. The cathedral of Drontheim contained the relics of king Olav the Saint, who was venerated by the whole kingdom as its patron, and whose grave was consequently visited by numerous pilgrims. It was also the capital of Norway, and had before the Reformation ten churches and five convents. Since the Reformation it has remained the seat of a Lutheran bishop. See NORWAY. A list of the bishops of Drontheim is given in Torfæus, *Historia Norvegiæ.* —Wetzer u. Welte, *Kirchen-Lexikon*, iii, 805.

Dropsy, a well-known disease (mentioned only in Luke xiv, 2, in the case of the dropsical man, ὄψομακός, cured by our Saviour on the Sabbath), manifested by a morbid collection of watery secretion in any of the cavities of the body. See DISEASE.

Dross (דֹּרֵס, *sig*, once [Ezek. xxii, 18, text] סיג, *sig*, what goes off in refining), the scoria or impurities of silver separated from the ore, or rusted or adultera-

ted forms, by the process of melting (Prov. xv, xxvi, 28; Psa. cxix, 119); also the base metal, a nature itself prior to smelting (Isa. i, 22, 25; Ezek. ix, 18, 19). See METAL.

Droste zu Vischering, CLEMENS AUGUSTUS, archbishop of Cologne, was born at Bister, Westphalia, January 21, 1773. He studied theology and philosophy at Münster, and was early introduced into the literary circle of the prince-archbishop of Gallitzin (q. v.). After travelling for some time in Italy, where he devoted himself to the study of art, he was consecrated a priest at Münster on May 14, 1797, by his brother Kaspar Maximilian, who had been since 1795, assistant bishop (weibbischop) of Münster. In 1807 he was elected by the chapter vicar general, and as such, administered the diocese until 1814, when Napoleon appointed the baron von Spiegel bishop of Münster. In order to avoid a schism, Droste conferred the administration of the diocese upon the new bishop. During the Congress of Vienna he went to Rome, to make a report on the situation of the Church of Cologne in Germany. On his return, March, 1815, he published a papal brief, which dissolved the chapter established by Napoleon, and relieved the baron von Spiegel from the administration of the diocese. The papal decree was recognised by the king of Prussia, who had been the sovereign of Münster; but soon conflicts arose between the Prussian government and Droste, who had again taken charge of the administration of the diocese. He forbade Roman Catholic theological students to study at the new Prussian University of Bonn. After the conclusion of the concordat between Prussia and the pope, Droste again retired into private life, and devoted himself wholly to the extension of a new association of Sisters of Charity which he had founded. In 1827 he was consecrated assistant bishop of Münster. In 1835 he was elected archbishop of Cologne, he having previously promised to adhere to an agreement concluded between the Prussian government and the late archbishop of Cologne concerning marriage between Roman Catholics and Protestants. But soon after his enthronization, the new archbishop was involved in serious conflicts with the government. He maintained that he had been deceived by the Prussian government as to the true meaning of the agreement between the government and archbishop Spiegel in which all the other bishops of Prussia had also given their adhesion), and declared that he would strictly carry out the views of the pope. He also proceeded with great rigor against the Hermetians (q. v.), whose views had been repeatedly condemned in Rome, but who were patronized by the Prussian government. Repeated efforts of the government to prevail upon Droste to abdicate having failed, he was, on Nov. 20, 1838, arrested and sent to the fortress of Minden. Soon after the accession of Friedrich Wilhelm IV to the throne of Prussia, the difficulties between the State and Church of Rome were settled by a compromise, and Droste restored to liberty. He had, however, to accept a coadjutor (bishop Geissel, of Spire), to whom he wholly left the administration of the diocese. He also refused a cardinal's hat which was offered to him by the pope. He died at Münster on Oct. 19, 1845. He published several pamphlets on the relation between Church and State, one ascetical book, and a volume of sermons, none of which are of permanent value. —Wetzer u. Welte, *Kirchen-Lexikon*, iii, 806; Herzog, *Real-Encyclop.* iii, 506. See DUNIN; COLEGE; PROMILA.

Drought (דְּרוֹחַ, *batstso'* *roth*, restraint of rain. Gen. xlvii, 8; "dearth," xiv, 1; דְּרוֹחַ, *cho' reb*, dryness. Gen. xxxi, 40; Jer. i, 38; Hag. i, 11; elsewhere "heat," etc.; or דְּרוֹבוֹן, *charabon'*, the same, Psa. xxxiii, 4; מַצְחָאֲחוֹת, *tsachtachoth'*, dry places, Isa. lviii, 11; דְּרוֹחַ, *teigal'*, Job xxiv, 19; Jer. ii, 6, a dry land, as elsewhere usually rendered; דְּרוֹחַ, *trismam'*, a peri-

Deut. viii, 15; "dry ground," Psa. cvii, 38; "irsty land," Isa. xxxv, 7; תַּבְּוּחַ, *tabbah'*, t, Hos. xiii, 5). See DESERT; PALESTINE. In ea, during the months of April, May, August, and ember, before and after the height of summer, and the early and before the latter rains, the earth is ashed with dews so copious as in a great measure apply the place of showers. But, however copious dews, they nourish only the more robust or hardy ts; and, as the season of heat advances, the grass iers, the flowers fade, every green herb is dried up he roots and dies, unless watered by the rivulets y the labor of man. To this appearance of the is during an Eastern summer the sacred writers n allude (Psa. xxxii, 4; Isa. xl, 6, 7). Should at season a single spark fall upon the grass, a confia- ion immediately ensues, especially if there should any briars or thorns, low shrubs, or contiguous ds (Psa. lxxxiii, 14; Isa. ix, 18; x, 71, 18; Jer. , 14). From the middle of May to the middle of gust, therefore, the land of Judæa is dry. It is the ight of summer (Gen. xxxi, 40; Psa. xxxii, 4). parched ground is often broken into chasms (Psa. 4). The heavens seem like brass, and the earth iron, and all the land and the creatures upon it er (Deut. xxviii, 28); and nothing but the very ht dews of the night preserve the life of any living ag (Hag. i, 11). See DEW.

Drove (דֶּרֶךְ, *e' der*, a *fleet* or herd, Gen. xxxii, 16, מַחֲמֵחַ, *machameh'*, a *troop* or army, Gen. xxxiii, See CATTLE.

Drown (שָׁטַף, *shataph'*, Cant. viii, 7, to *overflow*, elsewhere usually rendered; שָׁטַף, *shata'*, to *sub-* e or be submerged, Amos ix, 5; viii, 8; elsewhere "ench," "sink," etc.; טָבַע, *taba'*, to *immerse*, od. xv, 4; elsewhere "sink;" βυθίζω, *whelm*, 1 n. vi, 9; "sink," Luke v, 7; καταβύω, Heb. xi, to *swallow*, as elsewhere rendered; καταβυζομαι, itt. xviii, 6, to *be sunk*, as in Matt. xiv, 3). Drown- g was a mode of punishment in use among the Syr- s, and was well known to the Jews in the time of r Saviour (Matt. xviii, 6), though we have no scrip- tural evidence that it was practised by them. It was use also among the Greeks and Romans. The em- per Augustus punished certain persons who had been ily of rapacity in the province of Syria or of Lycia causing them to be thrown into a river, with a avy weight about their necks. Josephus also tells that the Galilæans revolting, drowned the partisans Herod in the sea of Genesareth (*Ant.* xiv, 15, 10). This mode of capital punishment Christ alludes in att. xviii, 6. It is still practised in India: a large ne is tied around the neck of the criminal, who is at into the sea or into deep water. See PUNISH- ENT.

Droz, François Xavier Joseph, a French writer philosophical and religious subjects, was born at esançon Oct. 31, 1773. After serving for three years the army of the French republic, he was for some ars teacher at the central school of the department ubs. In 1808 he went to Paris, where he devoted is whole time to literary studies. He became first own by his work *Essai sur l'art d'être heureux* (Par. 306). In 1823 he wrote the work *De la Philosophie vrale, ou des differents Systemes sur la science de la vie id ea*, Par. 1843, which obtained the Monthony prize, nd opened to the author the way into the French cademy, of which he became a member in 1824. His ost important work is a *Histoire du règne de Louis VI* (Par. 1838-42, 8 vols.), on which he worked thirty ears. Being in his earlier years a sensualist and Epi- orean, Droz in the latter part of his life became an utspoken Roman Catholic. He then wrote *Pensées ur le Christianisme* (Paris, 1842; 6th edit. 1844). He died Nov. 5, 1850.—Brockhaus, *Concours-Lex.* s. v.

Drum. See MUSICAL INSTRUMENTS.

Drunk (this and its related words, "drunken," "drunkard," etc., are represented in Hebrew by some form of the verbs שָׁכַר, *shakar'*, to *become intoxicated*; שָׁתָּה, *shathah'*, to *drink* simply; רָשָׁח, *rasah'*, to *drink* to satiety; סָבָא, *saba'*, to *drink* to excess; Gr. μεθύω). The first instance of intoxication on record is that of Noah (Gen. ix, 21), who was probably ignorant of the effects of the expressed juice of the grape. The sin of drunkenness is most expressly condemned in the Scriptures (Rom. xiii, 13; 1 Cor. vi, 9, 10; Eph. v, 18; 1 Thess. v, 7, 8). See TEMPERANCE. The use of strong drink, even to excess, was not uncommon among the Jews. This is inferred from the striking figures with which the use and effects of it have furnished the sacred writers, and also from the various express prohibitions and penalties (Psa. cvii, 27; Isa. v, 11; xxiv, 20; xlix, 26; li, 17-22; Prov. xxi, 1; Hab. ii, 15, 16). See DRINK, STRONG. Men are sometimes represented as drunk with sorrow, with afflictions, and with the wine of God's wrath (Isa. lxiii, 6; Jer. li, 57; Ezek. xxiii, 38). (See Wemyss, *Symbol. Dict.* s. v.) Persons under the influence of superstition, idolatry, and delusion are said to be drunk, because they make no use of their natural reason (Isa. xxviii, 7; Rev. xvii, 2). *Drunkenness* sometimes denotes abundance, satiety (Deut. xxxii, 42; Isa. xlix, 26). To "add drunkenness to thirst" (Deut. xxix, 19) is to add one sin to another; i. e. not only to pine in secret after idol-worship, but openly practise it (see Stuart's *Heb. Chrest.* on this passage).

Druids (Lat. *Druidæ* or *Druides*; Gr. Δροῦδαί or Δροῦδαί). Various etymologies have been given of this word, all indicative of some characteristic of Druidism, viz. (1.) the Greek word δρῦς, *an oak*; (2.) the Celtic words *deru* or *derw*, an oak, and *udd*, *lord* or *master*, or *hud*, *an incantation*; (3.) the Celtic compound *deruyd* or *derawydd*, from *de*, *God*, and *royyd* or *rawydd*, *speaker*, i. e. *God's speaker* or *theologian*; (4.) the old British word *deruidhou*, *very wise men*; and (5.) the Hebrew *derussim*, *contemplators*. Compare also the Anglo-Saxon *dry*, the Irish *drui*, the Romance *drudo*, and the German *drude*.

The Druids were an order of ecclesiastical nobility among the ancient Celts in Gaul and Britain, enjoying high prerogatives, and living in a sort of monastic way in communities, under the presidency of an arch-druid appointed for life, who exercised the chief authority among them, and whose successor was designated by virtue of superior dignity, or chosen by suffrage when there were several of equal rank. Sometimes, however, this choice was decided by an appeal to arms. Like other ancient hierarchies, they were divided into several classes; but there is some difference of opinion as to the exact number of such, as well as the character and offices of each. Strabo and Ammianus Marcellinus mention three, viz. Bards, Vates, and Druids; Diodorus Siculus only two—Bards and Druids, which latter class embraced apparently the Vates. To the Druids proper was assigned the highest rank, and they exercised in some sense government and superintendence over the others; were the depositaries of the will of the gods, the judges and religious teachers, who, as Strabo says, πρὸς τῇ φυσιο- λογίᾳ καὶ τῇ ἠθικῇ φιλοσοφίᾳ ἀσκούσι. The vates were, according to the same authority, priests and physiologists; according to Marcellinus, only the latter, seeking to discover the order and secrets of nature. Strabo says the bards were minstrels and poets. Marcellinus states that they "sang the brave deeds of illustrious men in heroic verses, with sweet modulations of the lyre;" and Diodorus, that "they sang songs of praise or invectives to the accompaniment of a sort of lyre."

Very little is known with certainty of their origin or history. If in their secret archives the ancient

Druids kept any written or other records of their order, none survived the overthrow of their power and influence by the Romans, while the few extant notices of them by Greek and Roman authors are very brief and unsatisfactory, especially in this respect. The views of modern writers can claim no higher authority than speculations based on grounds more or less probable, yet not certain. Some fragmentary Welsh poems, known from the peculiar form of composition as the *Triads*, are supposed to preserve some of the traditions current among the Welsh bards in regard to the history, doctrines, and customs of the Druids; and, according to these triads, they came into Gaul from the East, during the first invasion or migration of the Kymry under Hu-Cadarn, or Hu the Mighty. The opinion that they were of Eastern origin, and made their appearance in Britain and Gaul at a very early period, is supported by the similarity of their doctrines, rites, and architectural monuments to those of certain early Oriental nations. The Druidical order has been by various authors connected with the Persian, the Hindoo, the Egyptian, and the Phœnician priestly caste, and the Pythagorean fraternity; while their choice of groves, especially of oak, as places of residence and worship, and their pillars and altars of rough stone, are deemed, by some, striking coincidences with the usages of patriarchal times as described in the Pentateuch. Cæsar speaks of Britain as the parent seat of Druidism, affirming that those in Gaul who sought a fuller knowledge of it went thither to learn. This statement accords well with the theory of their Phœnician origin, since opportunity and motive for their early appearance in Britain may be found in that early and extensive commercial intercourse between the British Isles and Phœnician merchants in search of tin, to which we probably owe the name of Britain, i. e. the land of tin—according to some, from the Celtic *bruit*, tin, and *tan*, land; according to others, from a Phœnician word, whose modern representative is found in the Arabic *beret-anic*, or *barat-anic*. It is stated that the Druids held to the belief in one supreme God, the Creator and Ruler of all things, in the fall of man, and a future state of rewards and punishments. To these esoteric doctrines was added the public worship of the sun and moon, and of fire, as well as of divinities corresponding in functions with those of Greece and Rome, e. g. Mercury as Teutates, Mars as Hesus, Jupiter as Taranis, Apollo as Belin, probably the Baal of the East, Minerva as Belisama, and Hercules as Ogmius. We are told that "another remarkable principle of primitive Druidism appears to have been the worship of the serpent, a superstition so widely extended as to evince its derivation from the most ancient traditions of the human race;" and Pliny has left us a curious account of the anguinum, or serpent's egg, worn by the Druids as a distinguishing badge, its marvellous origin fully agreeing with the wondrous virtues ascribed to it. The same author testifies to their veneration for the mistletoe and its parent oak, and thus describes the ceremony of gathering (on the sixth day of the moon) of the sacred parasite, which was called by them the all-healer: "When preparations for the sacrifice and feast under the tree have been duly made, they bring up to it two white bulls, whose horns are then for the first time bound. The priest, clothed in white, ascends the tree, and with a golden sickle cuts off the mistletoe, which, as it falls, is caught in a robe, also white. The victims are then immolated, with the prayer that God would make his gift propitious to its recipients." In another place Pliny also makes mention that a sacrament of bread and wine formed part of the ceremonies observed in gathering the plant selago. We have also the rite of baptism reckoned among their ceremonies.

From other classic authors we learn that they held the doctrine of the immortality of the soul, which, as

they taught, does not perish, but passes after death into other bodies, either directly or after a certain time. They used this belief as an incentive to war among their countrymen, since death was only the entrance-way to a higher and better life for the hero, and in keeping with this faith they put of a settlement of accounts and the exaction of debts to the future meeting in another life, and also buried the dead articles useful to the living, of which practice we find proof in the contents of their burrows or tombs, exhumed in recent times. Cæsar's account here implies a recognition of the vicarious nature of sacrifices. Strabo says that they taught that this material world would never be annihilated, but undergo a succession of revolutions through the agency of fire and water: this latter element, it would appear from our accounts, they also held sacred, and in some sort worshipped. Diogenes Laertius sums up their ethical system with that of the Hindoo gymnosophists, in this favorite triad form, "to honor the gods, to do no evil and to practice manliness." According to Higgins the characteristics of Druidism in all ages and nations were "the worship of one supreme Being, the doctrine of metempsychosis and future rewards and punishments, hatred of images, open circular temples, the worship of fire as the emblem of the sun, the celebration of the most ancient Tauric festival, and the possession of a seventeen-letter alphabet, although the instructions were always orally given."

In their character of priests they had control of all matters pertaining to divine worship, officiated at the public and private sacrifices and other ceremonial rites. In the gloomy recesses of their deeply-shaded oak-grove temples, human victims writhed under the barbaric cruelty of their forms of sacrifice. Sometimes the victim was stabbed above the diaphragm, so that during a lingering death auguries might be drawn from the contortions of the sufferer, and the current and flow of his blood. Some were crucified; some shot to death with arrows. Sometimes huge images of wicker-work were filled with living men, or men and animals, and then set on fire, so that all perished together. Diodorus states that criminals were kept under ground for five years, and then sacrificed to the gods by being impaled and burned in great fires together with vast quantities of other offerings; and the prisoners taken in war were immolated, and with the captured cattle destroyed. Cæsar says that they held criminals to be the more acceptable offering to the gods, but in default of such victims they sacrificed the innocent. We may suppose that in some of these cases civil and not religious ends were sought—punishment and not sacrifice.

In the capacity of judges they took cognizance of all questions, civil and criminal, public and private, enforcing their decrees by the terrible power of a verdict applied to communities as well as individuals, which excluded the recusants from the sacrifices, and consequently from the association or sympathy of the others, who shunned the excommunicated as being shut out the pale of human or divine protection, and interfering with their guilt and pollution all who held intercourse with them. According to Cæsar, each year at a stated period, the Gallic Druids were wont to meet in a consecrated place within the territories of the Carnutes, whither all litigants repaired to have their controversies decided. This would seem to have been a high court of appeals, and perhaps a like one for Britain met at Stonehenge, or in the island of Anglesey, the ancient Mona.

They were also the teachers of youth, and possessed some knowledge of Astronomy, Geography, Geometry, Botany, Medicine, Physics, Mathematics, Rhetoric, and other polite arts. This, in addition to their religious doctrines, was imparted to the pupils who thronged their schools. Attracted by the honors and privileges belonging to their order, many even of noble rank

ly sought admission into it, though a rigid novitiate, sometimes lasting twenty years, was required. A vast number of verses, in which doubtless the histories, doctrines, and precepts of the order were condensed, had to be committed to memory, for the Druids made the writing out of these instructions, although, according to Cæsar, they were acquainted with written characters, and used them for other purposes. While no sanction was requisite in all undertakings, they had no taxes, and were exempt from the dangers of war, and we are told that their highest order enjoyed great revenues, and lived in more than regal splendor, receiving the homage of the people seated on golden thrones.

The Druidesses are divided by Borlase into three classes: "1. Those who vowed perpetual virginity, and were constant attendants on the sacred rites. Those who were married, but only saw their husbands once a year, that they might have children. 3. Those who were married, and performed all conjugal duties" (Fosbroke). The priestesses of Dionysus, located by Strabo on an island near the mouth of the Loire, and by Pomponius Mela on the isle of Iona, in the British Sea, were doubtless Druidesses of the 1st and 2d class. Notwithstanding the severe edicts of the emperors Augustus, Tiberius, and Claudius against the Druids, the order seems not to have been entirely suppressed until a much later period. The vast structures, of which remains still exist at Avebury and Avebury, in Wiltshire, England, and Carnac, in Brittany, together with numerous smaller ones in Great Britain and France, are supposed to be of Druidical origin. (See illustrations, under ALTAR, in this Cyclopædia, i, 178, and ARK, p. 401.) Similar ones are also found in various parts of Europe and Asia.

Literature.—Cæsar, *De Bel. Gall.* vi, 18-18; Pliny, *et. Nat.* xvi, 95; xxiv, 62; xxx, 4; Lucan, *Pharsal.* 144 sq.; iii, 899 sq.; Tacitus, *Annals*, xiv, 30; Amianus Marcellinus, xv, 9, 8; Pomponius Mela, *De situ orbis*, iii, 2 and 6; Suetonius, *De vita Cæsarium*, v, 25; odoratus Siculus, *Biblioth. Hist.* ii, 47; v, 81; Strabo, *Geographica*, iv, § 197-8; Diogenes Laertius, *De vitis philosophorum*, Præmium, i, 1 and 3; Frickius, *Comm.*

Druidis (Ulm, 1744, 4to); *Iconographic Encyclopædia*, iv, 74-79 (N. Y. 1851); Godwin, *History of France*, 44-53 (N. Y. 1860); *Bibliotheca Sacra*, July, 1854, 6-470; *Edinburgh Review*, July, 1863, 20-36 (Amer. ed.); *Pictorial History of England*, vol. i, chap. ii, v; night, *Popular History of England*, i, 3-10; 1b. *Old England*, vol. i, chap. i; Mountain, *Ancient Gaul* (in *History of Roman Empire*, *Encyclopædia Metrop.* crown 8vo ed., p. 5-10); Brand, *Popular Antiquities* (see INDEX); Chambers, *Book of Days* (see INDEX); Fosbroke, *Encyclopædia of Antiquities* (see INDEX); Maurice, *Irish Antiquities*, vol. vi, pt. i; Higgins, *Celtic Druids* (London, 1829, 4to); Davies, *Celtic Researches, and Rites and Mythology of British Druids*; Borlase, *Antiquities of Cornwall*; Rowland, *Mona Antiqua*; Smith, *Religion of Ancient Britain* (London, 1846, 2d ed.); Toland, *Critical History of the Celtic Religion* (n. d.); Barth, *Leber d. Druiden der Kelten* (Erlang, 1826); Burton, *History of Scotland*, vol. i (Edinburgh, 1867, 4 vols.); Richards, *Welsh Memorial and Essay on Druidism* (London, 1820, 8vo); Alger, *Future Life*, p. 88. See CELTIC RELIGION.

Drummond, ROBERT HAY, D.D., archbishop of York, son of the earl of Kinnoul, was born in London in 1711. He studied at Westminster School and Christ Church, Oxford, and became rector of Bothal, Northumberland, in 1735. He was made bishop of St. Asaph in 1748, and was translated to Salisbury in 1761. In the same year he was appointed archbishop of York. He died in 1776. His sermons, published separately during his lifetime, obtained great celebrity, and have been collected and published under the title *Sermons on Public Occasions, with a Letter on Theological Study;*

and *Memoirs of his Life*, by George Hay Drummond, A.M. etc. (Edinburgh, 1803, 8vo).—Darling, *Cyclopædia Bibliographica*, s. v.

Druses, the name of certain tribes of Syria (Asiatic Turkey), inhabiting a tract of land on the southern side of Mount Lebanon and the western side of Anti-Lebanon, between Beirut and Sur, and extending from the shores of the Mediterranean to Damascus. They exclusively inhabit 37 villages in the Lebanon and 69 in the Anti-Lebanon. The Maronites are mingled with them in about 210 villages. They are said to be about 100,000 in number. The name Druse is derived from that of Mohammed Ben Israel Darasi (see below), although the Druses do not acknowledge him as the founder of their religion, and many of their writers even call him by opprobrious names, e. g. Satan, the Impostor, etc.

I. History.—Their origin dates back to the tenth century, where they are found under the government of their founder, Hakim (996-1021). "After the second captivity of Israel, Esarhaddon (7th century B.C.) re-peopled the wasted strongholds of Samaria with certain fierce tribes, some of whom, called in the Scriptures Cuthites, and known in subsequent times to the Greeks as Carduchi, and familiar to us as Kurds, settled in Lebanon. From them the present Druses are supposed to have originally sprung. More than a thousand years later a fresh colonization took place. The Mardi, a warlike tribe who dwelt to the north of the Caspian, originally of Persian extraction, were transplanted thither by Constantine IV, in A.D. 686, to the number of 12,000, to act as a bulwark against Mohammedan invasion. The Arabs also, in sweeping through the mountain fastnesses, left a permanent impression there. Thus Cuthites, Mardi, and Arabs, or rather Mohammedans of various races, have combined to form that strange being, the modern Druse. It has also been supposed by some that there runs in his veins not a little of the blood of the Crusaders, but this is doubtful. No immigrations, however, of any importance into the country of the Druses took place after the close of the 10th century; and this period seems naturally to conclude the first great section of Druse history. The nationality of these mountaineers having now been consolidated, their peculiar and mysterious religion began gradually to be developed" (Chambers's *Encyclopædia*, s. v.). Hakim Biamrillah succeeded as caliph of Egypt in 996, and distinguished his reign by cruel persecutions of the Christians; it is said that 80,000 churches and monasteries were destroyed by his command. Some years before his death (about A.D. 1026), "Mohammed Ben Israel Darasi, a teacher belonging to the Batinites who had come from Persia, entered his service, and became an especial favorite at the palace. In return for the favors received from the caliph, he publicly ascribed to his master divine honor and majesty; but when he attempted to teach this doctrine in the mosque, from a book he had written, he was violently assaulted, and escaped with difficulty from the hands of the enraged worshippers. By the advice of Hakim he fled to Syria, and began to propagate his doctrines among the races dwelling on Lebanon, near the sources of the Jordan. In less than ten years, nearly all the Arab tribes that had become located here professed the religion of the Druse. Living at a distance from the place of Mohammed's power, and their fathers never having joined in the forays of the Prophet, or reaped the pillage of his battles, they were less attached to his faith than its other adherents. It is supposed that Darasi perished in a battle with the orthodox Moslem from the plain, as they resolutely opposed him, and he had to defend himself constantly from their attacks. There was a turban-maker, called Hamsa, and surnamed Hadi, the Leader, from whom Darasi received the instructions that induced him to deify the caliph. It is not improbable, however, that

Hakim himself was the real author of this impious assumption, and that the others became his agents of proselytism by the promise of a royal reward. The sect grew in influence, until the *cadi*, when in the mosque, was summoned to embrace the new faith; but the attempt was fatal to the neophyte who made it, as he and his attendants were slain. The presumption of the caliph was equal to the credulity of his disciples. When the divine name was ascribed to him, he willingly received it, and openly proclaimed himself to be the creator and ruler of the beneficent Nile, from which the land received all its luxuriance, and the people all their prosperity" (*London Review*, Jan. 1860, p. 159). He was slain at last; but Hamsa, the apostle, survived, and wrote books which are still regarded as the oracles of the Druses.

From the tenth century onward the Druses maintained their separate religion and a quasi nationality. They lived under the orders of separate chieftains, or sheiks, without any supreme authority, and committed depredations on the neighboring Turkish countries. Frequent complaints were presented against them to the Porte for depredations committed, and Murad III finally sent an expedition against them in 1588, under the orders of Ibrahim Pacha. The Turks were successful, established one of their own emirs as king over the Druses, and exacted tributes from them. The emirs then united against the common enemy, and became dangerous to the Porte, particularly the emir Fakir Eddin, who, in the 17th century, became so strong that the Porte determined on taking the most active measures against him. Fakir Eddin fled to Italy, leaving his son Ali as regent in his place. The latter drove the Turks away, and restored peace; but Fakir Eddin having returned, after imbibing the love of splendor which distinguished the court of the Medici, laid such heavy taxes on the people that a revolution broke out. The Porte sent another expedition against him in 1632. His son Ali fell in battle, a second son was made prisoner, and Fakir Eddin himself was obliged to flee to the mountains. He was betrayed by his own followers in October, 1638, and was strangled at Constantinople in 1635. His descendants held their position as emirs in subjection to the Porte. After the extinction of this family, that of the *Schebabs*, originally from Mecca, became emirs. The powerful Melhem (1740-1759) restored to the Druses some of the power they had lost after the downfall of Fakir Eddin. Emir Beschir, born in 1763, is one of the most noted of the recent emirs. In 1819 he took part in the insurrection of Abdallah, and was deposed in consequence, but was pardoned by the Porte in 1823, through the influence of Mehemet Ali. An insurrection of the Druses against the viceroy took place in 1834, but was subdued by Ibrahim Pacha in 1835, and the Druses of Lebanon were disarmed. Emir Beschir then sided with the Egyptians until 1840, when he was deposed. After Ibrahim Pacha had retired from Syria, the land of the Druses passed again under the direct dominion of the Turks. At the same time bloody conflicts broke out between the Druses and the Christian Maronites. To put an end to these troubles, the emirs of both parties were called to Constantinople in 1842, deposed, and Omar Pasha was appointed Turkish administrator in their place. He was sent to Lebanon to consult with the principal chiefs of the Druses and the Maronites, who were to form a permanent council of administration. But the two parties soon united against Omar Pasha, and open conflict speedily followed. The battle of Ehden, Oct. 13, 1842, proved a success for the malcontents. An edict of Dec. 7, 1842, granted to the Druses and Maronites the right of self-government, and the Mohammedan Kaimakam to reside at the south, the Christian at the north. Yet, as the population are not thus geographically divided, but, on the contrary, rather mixed up, the edict did not satisfy either party. New troubles breaking out,

the Porte sent Halil Pacha and 1000 soldiers into the land. An assembly of the mountain chieftains having been called by Halil Pacha, an arrangement was made; but hardly had Halil Pacha left the country when troubles broke out among the Maronites themselves, arising from religious differences. A mob of peasants drove the patriarch from his residence. At the same time, the old hatred of the Druses against the Maronites was revived. The Porte at last sent 12,000 men to Lebanon, where some forty chiefs of the Druses and Maronites were taken prisoners. One of the principal Maronites, Zahle, was suddenly deposed Oct. 16, 1845, and the others followed without any successful resistance being made. In the spring of 1846 the Porte granted the country a new Constitution, whereby a permanent council was added to each of the two Kaimakams. These councils are to be composed of members of the different sects inhabiting Lebanon (2 Maronites, 2 Druses, 2 United Greeks, 2 Non-united Greeks, 2 Turks, and 1 Mutual). The strife between the Druses and the Maronites ceased, however, and another appeal was made to the European powers in 1847, yet without any result on account of the contending claims of the Roman Catholic clergy as possessors of many conventual domains of the other religious parties, of the rich landowners, and of the Turkish officials. A terrible outbreak again occurred in May, 1860. Throughout the Lebanon the Druses attacked the Maronites, plundered and burnt their villages, and massacred a large number of persons without distinction of age or sex. The Turkish authorities made no efforts to stop these outrages, and in some instances Turkish troops even took part in the massacres and pillages. The war continued throughout the month of June; the Maronites suffered terribly, and in Damascus some 6000 Christians were reported to have perished. Upon the news of this massacre France sent a corps of 12,000 men to Syria, while England increased its fleet on the coast, in order to assist, if necessary, the French in re-establishing order. The commander of the French troops prevailed upon Fuad Pasha, who had been sent by the Turkish government to Syria as extraordinary commissioner, to order the execution of 168 of the chief accomplices of the massacre. Soon after even Achmet Pasha, the governor of Damascus, and a number of prominent Turkish officers, were executed. Several chiefs of the Druses were also sentenced to death, but this sentence was for most of them commuted into long imprisonment. On the 5th of October an international commission of plenipotentiaries of European powers met at Beirut to investigate the causes of the late disturbances, and to secure the punishment of the guilty and indemnification of the sufferers. In the way of punishment and indemnification little was obtained; but the representatives of the great powers prevailed upon the Turkish government to agree on June 9, 1861, to a special treaty concerning the administration of the Lebanon. According to this agreement, the administration of the whole mountain was placed for a term of three years under one Christian governor, who was to reside at Deir el-Kamar, and to be directly dependent upon the Turkish government. The government appointed for this position Daud-Heffendi, a Roman Catholic Armenian, who, after the expiration of his first term of office, was reappointed for five years. No disturbance took place under his administration, as far as the Druses were concerned.

II. *Usages, Religion, etc.*—The Druses are of Caucasian extraction. They are violent, cunning, treacherous, covetous, warlike, love independence, and have successfully defended their liberty. If they have the faults of Eastern nations, they also possess their best virtues: they are hospitable, obliging to a certain extent, careful, clean, and industrious, but with hardly any intellectual culture. Reading and writing are almost unknown among them; they look upon the

ge for bloodahed as a sacred duty. They raise n, wine, tobacco, and silk. Their language is a ect of the Arabic; their religion, a mixture of idol- ; Judaism, Mohammedanism, and Christianity. y make no secret of their doctrines, and yet they but little known. They look upon the caliph Ha- , of Egypt, as holy; teach metempsychosis and the nd advent of the prophet (incarnation of God); r permit polygamy, but it is only practised by the er classes. There is no regular order of priest- d, the office being filled by consecrated or learned sons called *Akkals*, comprising especially the emirs sheiks, who form a secret organization divided , several degrees, keep the sacred books, and hold ret religious assemblies. The great mass of the ple are almost ignorant of any principles of relig- . They recognise neither ceremonies, festivals, , fasts.

The following summary of their doctrines is given the *London Review*, Oct. 1860, p. 161: "We are told t there is one God, unknown and unknowable; the ator, Preserver, and Judge of the universe. We not speak of him by comparison or by negation. e is, 'is all we can say of him; and if we go further in this, we bring in the human element, and there e fail to set forth the truth. There can be no rep- entation of God beside the form of man, who re- cts the image of God, as the mirror reflects the ject before which it is placed; and man is chosen to the veil of God, as being the noblest work of his natures. There have been nine avatars of the one d, who has appeared in the form of men, but with- out man's impurity or corruption. They were not opefly incarnations. God did not become flesh, but sumed the veil of flesh, as the man who puts on a be is still distinct from the robe. The Druses admit e doctrine of free will in opposition to Islam, and ink that predestination is irreconcilable with eternal justice. There are five invisible intelligences of a su- rior order, all of whom have been impersonated in many Druse teachers, of whom Hamsa was the chief. These intelligences are regarded as mediators t behalf of those who in earnest seek wisdom. The uls of men migrate into other human bodies, and se to higher grades of intelligence by an attention to ter duties and submission to the divine will. In e religions that appeared in the ages preceding Ham- im there was a mixture of truth; but these were only ; starlight revelations, all of which were to be over- veyed by the radiance of the full-orbed sun, which se in its perfect majesty when the system of the Druses was proclaimed to the world. They have sev- n great precepts: 1. To speak the truth. 2. To ren- er to each other mutual assistance. 3. To renounce ll error. 4. To separate entirely from the wicked nd the ignorant. 5. To assert on all occasions the verlasting unity of God. 6. To be submissive under- rial. 7. To rest contented in whatever situation they ay be placed, whether of joy or sorrow. The first is e principal precept. But these obligations are not o be regarded as in force when intercourse is held with the unbeliever. Of their outward forms and ceremonies we have little or no information of a char- acter upon which we can rely. In their temples there re no ornaments, and their sacred edifices are found among the shadows of high trees, or on the summit of the mountain. They have no prescribed rites, and do not offer prayer. When outwardly conforming to the practices of other sects, they refrain from the prayer of the heart. There are instances in which a spirit more in accordance with man's weakness is manifest; but even then there is inconsistency between the pro- fession and the practice. An *akkal*, on visiting Da- mascus, as we learn from colonel Churchill, having alighted at the house of a sheik of Islam, the two friends entered into conversation, when the sheik asked the Druse if there were any true Mussulmans

in his country. He replied that there were, and that they read the Koran. He was requested to show how they prayed. 'Who is without prayer?' was the re- ply. But the sheik then wished to know in what manner prayer ought to be presented to God. The *okkal* proceeded to say: 'When I enter the house of God, I endeavor to do so with pure thoughts and a clean heart, and call out, "There is no God but God, and Mohammed is the prophet of God." I listen to the words of the book with an earnest and teachable spir- it. I look down in contrition and penitence, and, bowing down my head, kiss the earth, praying that I may be enabled to walk in humility and the fear of God, and to resign myself in all things to his will and decrees; to think that heaven is on my right hand and hell on my left; and to bear in mind that, wher- ever I go, I am always in the presence of God, and that he is ever before me. That is enough.' His host of the city, turning to those present, said, 'All your prayers, compared to that, are useless.' The *akkals* are the more devoted professors of the Druse religion, and they may be of either sex. They are not priests, and neither teach nor exercise discipline. They must remain a year on trial before they can be admitted to the secrets of the fraternity; after that they may wear a white turban as an emblem of the purity they are to cultivate. They dress in plain gar- ments, wearing no ornament, and are required to be simple in their manners, and careful in their mode of speech. At their funerals they receive marks of great respect; and their tombs are afterwards visited by the superstitious, who worship the departed spirit, and de- posit candles or ornaments in the vault of the de- ceased. Hymns are sung in the Druse temples, and the people listen to the reading of the sacred books; they eat figs and raisins together at the expense of the community; and all matters of public interest are brought before a select council. They thus combine in one service the religious, social, and political ele- ments. They have a golden calf covered with secret characters, which is kept in a sacred chest, but wheth- er it symbolizes some object of veneration, or, as some say, is intended to remind them of the dangers attend- ant on the errors of Daraai, whom they call in derision 'the Calf,' is not ascertained with certainty. The Druses are extremely sensitive when inquiries are made of them respecting their religious practices, and usually parry the question by some evasive reply. A Druse, met with by Dr. Wilson at Hasbeiya, told him that there is little difference between their creed and observances and those of the orthodox Mussulmans, while others tell us that they respect Christ and abhor Mohammed. No one has been more favorably situa- ted than colonel Churchill for learning their real sen- timents and customs, but even he was not permitted to penetrate into the mysteries of their faith. 'Two objects,' he says, 'engrossed my attention—the religion of the Druses, and the past history of the races which now occupy the mountain range of the Lebanon. In vain I tried to make the terms of extreme friendship and intimacy which existed between myself and the Druses available for the purpose of informing myself on the first of these points. Sheiks, *akkals*, and peas- ants alike baffled my inquiries, either by jocose eva- sions or by direct negation.'

At a meeting of the Royal Asiatic Society, London, March 20, 1865, the Rev. A. Tien read a paper entitled "Druse Religion Unveiled," which throws light upon the present doctrines and usages of the Druses. "Out- wardly the Druses conform to the observances of Mo- hammedanism, though they entertain really the ut- most aversion to that religion. They believe they are the descendants of Jacob, and in many respects they adhere to Jewish rites. Their Sabbath commences af- ter sunset on Friday, when they assemble in places of worship that are guarded from intrusion. They chant an invocation to the deity, a translation of which was

read by Mr. Tien, resembling a lamentation of the Israelites in captivity, imploring for the restoration of power in Jerusalem, to which they add a prayer for the destruction of Mecca. Their sacred books are contained in a silver casket carefully preserved, which is considered like the ark. They are inveterate to the Mohammedans and to Christians, though professing the religion of the former and attending the mosques. The doctrine of metempsychosis is strongly believed in, with some curious modifications. The deity whom they worship, under the title of El Hakim, is supposed to have appeared on the earth at two different periods, with different names and attributes, and his principal agent, also, is believed to have assumed different forms. At the creation of the world, it is assumed that a certain number of souls was created which has not since been added to nor diminished; every soul, whether in human or in animal form, having been on death transferred to some other body, either more elevated or more debased, according to the conduct of the individual or animal during life. In one of the seven books there is a catechism, from which Mr. Tien read several questions and answers, containing an exposition of the principal articles of faith of the Druses. The books are written in Arabic of very ancient character. The Druses are divided into three classes or castes, according to religious distinctions. To enable one Druse to recognise another, a system of passwords is adopted as by Freemasons, without an interchange of which no communication is made that may give an idea of their religious tenets."

III. *Literature*.—Wolff (Phillip), *Die Drusen und ihre Vorläufer*; Gibbon, *Decline and Fall* (Boston, 1850, 12mo), v, 631 (and especially Milman's note); De Sacy, *Exposé de la Religion des Druses* (Paris, 1838, 2 vols.); G. W. Chasseaud, *The Druses of the Lebanon; their Manners, Customs, and History* (London, 1855, 8vo); Churchill, *St. Lebanon; a Ten Years' Residence, from 1842-52*, with supplementary volume on *The Druses and the Maronites under Turkish Rule* (Lond. 1855-62, 4 vols. 8vo); *Foreign Quarterly Review*, xxix, p. 205; Pierer, *Universal-Lexikon*, s. v.; Robinson, *Biblical Researches* (Lond. 1840); *Bibliotheca Sacra*, 1843, p. 205; *Journal of Sacred Literature*, xix, 489; *New Englander*, January, 1861, art. ii.; Kelly, *Syria and the Holy Land* (compiled from Burckhardt and others, London, 8vo, n. d.), chap. xii.; Thomson, *Land and Book*, i, 246, 249); Caernarvon, *Recollections of the Druses of the Lebanon, and Notes on their Religion* (Lond. 1860); H. Guys, *La Nation Druse* (Paris, 1863); H. Guys, *Théologie des Druses ou abrégé de leur système religieux, traduit de l'arabe, avec notes explicatives et observations critiques* (Paris, 1863); G. de Alaux, *Le Liban et Daud Pasha, in the Revue des Deux Mondes*, 1865, July 1, and 1866, May 1; *Allgem. Real-Encyklopädie*, s. v.

Drusilla (Δρούσιλλα), youngest daughter of Herod Agrippa I by his wife Cypros, and sister of Herod Agrippa II, was only six years old when her father died in A. D. 44 (Josephus, *Ant.* xix, 9, 1; xx, 7, 1 and 2). Being celebrated for her beauty, she had already been promised in marriage to Epiphanes, son of Antiochus, king of Comagene, but the match was broken off in consequence of Epiphanes refusing to perform his promise of conforming to the Jewish religion. Hereupon Azizus, king of Edessa, obtained Drusilla as his wife, and performed the condition of becoming a Jew (Josephus, *Ant.* x, 7, 1). Afterwards Felix, the procurator of Judæa, fell in love with her, and induced her to leave Azizus, a course to which she was prompted not only by the fair promises of Felix, but by a desire to escape the annoyance to which she was subjected by the envy of her sister Berenice, who, though ten years older, vied with her in beauty (ib. 2). She thought, perhaps, that Felix, whom she accepted as a second husband, would be better able to protect her than Azizus, whom she divorced. In the Acts

(xxiv, 24) she is mentioned in such a manner that she may naturally be supposed to have been present when Paul preached before Felix in A. D. 56. Felix and Drusilla had a son, Agrippa, who perished in an eruption of Vesuvius (Josephus, *Ant.* xix, 7; xx, 5). It is thus (Hist. v. 9) said that Felix married Drusilla, a granddaughter of Cleopatra and Anthony. The Drusilla he refers to, if any such person ever existed, may have been a daughter of Julia and Cleopatra born for the names and fate of all the other descendants of Cleopatra and Anthony are known from other sources. But the account given by Josephus of the marriage of Drusilla is more consistent than that of Tacitus in the notice in the Acts, by which it appears that she was a Jewess. Some have supposed that Felix married in succession two Drusillæ; and some have lent to this otherwise improbable conjecture the expression of Suetonius (*Claud.* xxviii), who calls Felix "the husband of three queens." (See Nodding, *Hist. Idum.* p. 464 sq.; Walch, *De Felice, Jen. Lit.*, p. 1 sq.) See FELIX.

Drusius, JOHANNES (DRIESCHER, JAN), an eminent critic and Orientalist, was born at Oudenaarde in Flanders, June 28, 1650, and was educated at Ghent and Louvain. "His father, having been outlawed in 1656, and deprived of his estate, retired to England, and Drusius soon followed him. His mother, who continued a Roman Catholic, did all she could to prevent him. His studies were taken care of, and money provided for him; and he had soon an opportunity of learning Hebrew under Anthony Crevellier, who came over to England, and taught that language publicly in the University of Cambridge. Drusius went to his house, and had a great share in his studies. He did not return to London till 1671, and, while he was preparing to go to France, the news of the massacre on St. Bartholomew made him change his resolution. Soon after this he was invited to Cambridge by Cartwright, the professor of divinity and the oriental languages there, at the age of twenty-two. He taught at Oxford four years with great success; after which, being desirous of returning to his own country, he went to Louvain, where he studied the civil law. The troubles on the account of religion obliged him to come back to his father at London, but upon the pacification of Ghent, 1676, they both returned to Louvain" (*New Gen. Dictionary*, iv, 506). He was made professor of Oriental languages at Leyden in 1677, and of Hebrew at Franeker 1685, where he died Feb. 21, 1618. His works, which are held in great esteem, have been for the most part incorporated into the *Crœci Sacri*. Among the most important are *Verborum interpretum Græcorum in totum veteris Testamentum synonyma* (Arnhem, 1622, 4to);—*Annotationum in Iosue Jesu Christi Testamentum libri decem* (Frankf. 1624, 4to);—*Ecclesiasticus, Græce et Latine* (Frankf. 1624, 4to);—*Proverborum Sacrorum classes due* (Frankf. 1590, 4to);—*Parallela Sacra, seu comparatio veteris Test. cum iis, quæ in Novo citantur* (Frankf. 1624, 4to);—*Libri decem Annotationum in totum Iosue Testamentum* (Amst. 1692, 4to). For a list of his writings, see Nicéron, *Mémoires*, xxii, 63; see also Bishard Simon, *Histoire Crit. du N. T.* (Paris, 1690); Coriander, *Vita Drusii* (Franf. 1616); Bayle, *Dictionnaire*, s. v.; Herzog, *Real-Encyklop.* iii, 629.

Druthmar, CHRISTIAN, a monk in the abbey of Corbey in the ninth century, was born in Aquitaine and afterwards taught in the monasteries of Sarrebourg and Malmedy, in the diocese of Liège. He left a commentary on St. Matthew (Strasbourg, 1514; Haguenau, 1530, fol.). "It contains some opinions respecting transubstantiation decidedly opposed to those of modern Romanism, though they were regarded as orthodox at the time of his writing. He commenced a commentary on St. Luke and St. John, which he did not live to finish. For St. Mark he refers his pupil

a commentary of Bede." His commentary on St. ke and St. John was printed at Haguenau in 1530, the *Bibliotheca Patrum* (t. xv, p. 86). The edition Haguenau was edited by Johann Secer, a Lutheran, i Wetzler und Welte (*Kirchen-Lexikon*, iii, 321) say it he perverted and garbled the text so as to make oppose transubstantiation. His text runs: "Hoc corpus meum, i. e. in sacramento . . . transferens rituabiter corpus in panem, in vinum sanguinem." the other hand, Sixtus of Siena asserts that he ind a MSS. in the Franciscan monastery at Lyons, which the words run: Hoc est corpus meum, hoc vere in sacramento subsistens . . . transferens mem in corpus et vinum in sanguinem. See Wetzler Welte, *Kirchen-Lexikon*, l. c.; Dupin, *Ecclesiastical Writers*, cent. ix.; Mosheim, *Ch. History*, cent. ix, chap. n. 46; Ceillier, *Auteurs Ecclésiastiques*, Paris, 1862, i, 419 sq.; Herzog, *Real-Encyclop.* iii, 581.

Dryander. See ENZINAS, FRANCISCO DE.

Drydale, JOHN, D.D., an eminent divine of the hurch of Scotland, was born in 1718; entered the niversity of Edinburgh in 1732; became minister of ukliston in 1749; appointed minister of the Tron urch, and also king's chaplain, in 1765; and died in 188. He was one of the leaders of the moderate par in the Church of Scotland, and was supposed to be elined to Arminianism. See his *Sermons, with Life & Dalzel* (Edinb. 1798, 2 vols. 8vo).

Dualism, in philosophy, is that system which explains the phenomena of the universe by assuming wo *primal principles* instead of one (Monism). In heology, Dualism explains evil by assuming two original principles or beings, one good, the other evil. The doctrine of two primal causes, one good and the ther evil, constantly warring with each other, lay at he foundation of the system of Zoroaster (q. v.). It as also developed later in Manichæism (q. v.); and among the Slavonians, who, during the interval be- tween their undisturbed faith in their national mythol- ogy and their conversion to Christianity, added to the vorship of the good being that of a supremely evil ne, viz. Czernebog (the Black God) (*London Review*, April, 1855, p. 11). It was in this Slavonic soil that he Oriental dualism found a congenial home, and from it seems to have originated the dualism of the Cathari and other sects during the Middle Ages. See CATHARI.

Its root is always found in imperfect speculation on the relation of God to the world, and on the origin of evil. It is apt to spring up, also, in the practical sphere, from the sense of personal sin, which seeks relief in a transfer of guilt from the real self—the man—to some- thing outside of him, e. g. to the physical side of his own nature, or to the general laws of nature.

1. **Oriental Dualism.**—The Chinese, at a very early period, adopted a dualistic philosophy and theology. The ordinary speech of their philosophers was dualistic, implying two primal essences, "one a power or cause, the other a more passive something on which that power or cause could operate. The former may be styled the ultimate *immaterial* principle of the universe (*Le*); the second, consisting of ethereal matter, is the ultimate *material* principle (*Ke*). The latter, again, is dual (*yang* and *yin*), viz. the paternal and maternal principles in nature. Man is the product of the marriage of the male and female principles in nature. *Yang* and *yin*, coexisting as the material ground in which the ultimate principle (*Ke*) takes effect, enter into the composition of rational as well as of irrational beings. In moral speculation, however, this dualism passed into a sort of pantheism" (Hardwick, *Christ and other Masters*, pt. iii, chap. i).

The **Persian Dualism.** The Persian system, whether originated by Zoroaster, or, what is more likely, modified by him from older doctrines, taught that there is "a supreme Being, all powerful and eternal, from

whom have eternally proceeded, by his creative word (*Honofer*), two principles, *Ormuzd* and *Ahriman*; Ormuzd (*Oromusdes*) being pure and infinite Light, Wisdom, and Perfection, the Creator of every good thing; Ahriman the principle of darkness and evil, opposed to Ormuzd, either originally or in consequence of his fall. To this belief are attached fables respecting the conflicting efforts and creations of these two powers; on the universal dominion ultimately reserved for the good principle, and the return of Ahriman during four periods, each of which is to last three thousand years; on the good and the evil spirits (*Amehaspands*, *Izeds*, *Ferfers*, and *Dives*), and their differences of sex and rank; on the souls of men (*Ferfers*), which, created by Ormuzd before their union with the body, have their habitation in the heavens; and which ultimately, according as in this world they have served Ormuzd or Ahriman, pass after death into the dwellings of the blessed, or are precipitated into obscurity; finally, respecting the future resurrection of the bodies of the wicked after the victory of Ormuzd and the restoration of all things" (Tennemann, *Manual Hist. of Philosophy*, § 71; see also Hardwick, *Christ and other Masters*, pt. iii, ch. iii). The Oriental Dualism first sets the Hyle (ἄλη, matter) as an original principle over against the divinity. The Eastern philosophers soon found it necessary to run into Pantheism; for, the necessity of unity pressing on them, they found no other way of escape except to make God the soul of the world. But, the gulf between matter and divinity still remaining, they had to fall upon two principles, the material and spiritual; and, not willing to identify the original spiritual principle with matter, darkness, and evil, they fell upon the idea of two antagonistic beings or gods, a good and an evil one, the god of light and the god of darkness, the god of matter and the god of spirit—Ahriman the evil principle, and Ormuzd the good.

2. **Dualism in the Christian Age.**—This Oriental Dualism, carried out into the various departments of nature and mind, and embellished by innumerable beautiful fancies, had a great charm for the imagination of even the primitive Christian mind; and it seemed also to form a certain kind of natural and easy alliance with the doctrines of good and evil, God and Satan, spirit and matter, in the human constitution, as these are unfolded in the Christian revelation, so that this dualistic mode of thinking failed not to insinuate itself largely into the thinking of many in the primitive Church. It has also revealed itself, more or less, in various sects and systems in every period of Christian history, and its false theories have often troubled the mind of the Church in the development and statement of its dogmas. Thus in Gnosticism, and especially in the Docetic phase of it, Dualism enters as a ruling element. The Gnostics found it difficult to explain the existence of the sensible world, and especially the existence of evil, on the direct assumption of one absolutely good Being. Hence they mixed into their theory some elements of the Oriental philosophy. "They thought themselves compelled to combine with the doctrine of emanation that of Dualism, in order, by the commixture of two hostile realms, by the products of two opposite principles, to explain the origin of a world not answering to the divine idea, with all the defects cleaving to it, all the evils it contains" (Neander, *Hist. of the Chr. Church*, Bohn's ed. ii, 14). For the Manichæan Dualism, see MANICHÆISM; and for that of the Cathari, see CATHARI.

That the ascetic tendencies of the early Christian age were strongly stimulated, if not unconsciously caused by a leaven of Dualism, can hardly be doubted. "A dark instinct of a state of abnormal and dangerous antipathy to God leads the devotee to take vengeance in time upon that part of himself which is outside, and which may be hardly treated, and even tortured, at far less cost than the renewal of the spirit of his mind, and the bringing of his whole inner man back to grav-

itate towards God instead of turning upon itself. Manes endeavored to unite Christianity and the noblest form of Oriental paganism in his brilliant and elaborately-constructed speculative system. The Church repulsed the heresiarch because of his personal pretensions, his rival hierarchy, and his too open importations from the religion of Persia; but it was not the less profoundly modified by the tendencies which it nominally rejected. Monasticism in Syria and Egypt was the direct result of the contact of degenerating Christianity with pagan habits of thought. The idea that abstinence from food was meritorious in itself, the notion of impurity attached to the sexual relation, the growing tendency to look upon marriage as a state less holy than celibacy—these were so many triumphs of the invading pagan conception. The errors and extravagancies of the ascetic life were especially prevalent in the Eastern Church. Schmid quotes authorities to show that remembrances of Manicheism were long kept up in Oriental convents, and also that sundry Greek monks, in their solitude, imagined they had constantly to struggle with the devil, whose power they magnified until they put him almost on a rank with God" (*London Review*, April, 1855, p. 10; see also *Lea, Sacerdotal Celibacy*, Phila. 1867, p. 42 sq.).

The progress of philosophy and theology in all Christian ages has been a continuous struggle to overcome Dualism, to bring God and the world, the infinite and the finite, heaven and earth, spirit and matter together, and to do this without violence to the essential nature of either, by, on the one hand, confusing them, or, on the other, annihilating one or the other by identification of them. Pantheism, as it has sprung up on the arena of modern theological investigation, has been an earnest, though mistaken effort to overcome Dualism. Much as Pantheism is to be abhorred and dreaded, yet ought its service to be acknowledged in helping philosophy and theology to master Dualism. It has both suggested and stimulated the movement that aims at the creation of a christological theology, and we may also say philosophy, which professes, not without hope of success, to overcome that mischievous Dualism which knows only to negate, and which, in a cowardly manner, has only given up the great fundamental problems. It holds that the great gulf can be, and can only be, bridged by the God-man in whose mysterious person all dualism is overcome—the centre and perennial source of all life and thought, the principle of all unities and the unity of all principles, the whole of all that is divided, the harmony of all manifoldness and diversity, the centre of all science, and the imperial, incarnate Word of all authority and truth, the final rest of all minds, as he is also of all hearts.—Hardwick, *Christ and other Masters* (Lond. 1863, 2 vols. 12mo); Dörner, *Doctrines of the Person of Christ* (see Index); Hagenbach, *Hist. of Doctrines*, Smith's ed., § 51, 127; *Theol. Stud. u. Kritiken* (1887), p. 357; Lange, *Life of Christ* (Edinb. 1864, 6 vols. 8vo), i, 185 sq.; H. Schmid, in *Herzog, Real-Encycl.* xix, 482.

Du Bartas, GUILLAUME, DE SALLUSTE, a French Protestant poet of the sixteenth century, born about 1544, near Auch, in France; died 1590. His poem on the *Creation* obtained so great celebrity that in the course of six years more than thirty editions of the first "Semaine" were published. It was translated into Latin, Italian, Spanish, German, and English. The English version is entitled *Du Bartas, his Divine Weekes and Workes*, translated by J. Sylvester (Lond. 1641, fol.).

Dublin, the capital of Ireland, on the river Liffey.

1. *Synods of Dublin*.—Several important synods have been held at Dublin. 1. In A. D. 1186, chiefly to rebuke the drunkenness and incontinence of the clergy. 2. In 1513, under William Rokeby, archbishop of Dub-

lin, at which ten canons were published for reformation of manners and discipline, one of them "forbidding the clergy to play at tennis upon pain of a fine of twenty-four pence for each offence—half to be paid to the bishop, and the other half to the church of the place where they play" (*Wilkins, Concilia*, iii, 67, 8. In 1615, by the archbishops, bishops, and clergy of Ireland in convocation, Thomas Jones, archbishop of Dublin, being speaker of the House of Bishops, in this synod certain articles of religion, framed by Fisher, in one hundred and four sections, under various heads, conveying the Calvinistic doctrine, were drawn up and approved. These articles included the celebrated "Lambeth Articles" (q. v.). By the consent of the synod, any minister, of whatsoever degree or quality, publicly teaching any doctrine contrary to the Articles, was ordered, after due admonition, to be silenced (*Wilkins, Concilia*, iii, 447). 4. In 1684 composed of the archbishops, bishops, and clergy of Ireland, to adopt the 39 Articles of the Church of England. "No formal abrogation, however, of the Calvinistic articles of 1615 was made, which led to very inconvenient results; some, among whom was Prichard, justly considering that the adoption of the English articles *ipso facto* annulled those of 1615, viz. Usher and many others, who favored the doctrine contained in the Irish Articles, maintained that both sets of articles were to be observed, and, in consequence, some few bishops, for a time, required subscription to both the English and Irish, discordant as they were. This unhappy state of things appears to have continued until 1641, when the Irish rebellion broke out. On the restoration of the Church, no attempt was made to revive the Irish articles, which fell into entire disuse." At this synod 100 canons were adopted, which received the royal assent (*Man. Irish Church*, p. 483 sq.; *Wilkins, Concilia*, iii, 496).—*London, Manual of Councils*, p. 211 sq.

2. *University*.—The University of Dublin (Trinity College) was founded in 1592. It is, in fact, a college with the powers of a university. "Trinity College indeed, was intended merely as the nucleus of a university, but, as no colleges have since been added, it remains in undisputed possession of all university privileges. Queen Elizabeth provided the charter, the corporation of Dublin bestowed the ground and ruins of the suppressed monastery of All-Hallows, and the Irish gentry supplied by subscription the funds necessary for the erection of the buildings. The income of the college was very limited and very precarious till James I endowed it with certain estates in the province of Ulster, and a yearly pension of £500 15s. English money, from the public purse" (*Chambers, Encyclopædia*, s. v.). The college has in its gift twenty-one Church livings.

3. *Hierarchy*.—An episcopal see was established at Dublin in 1088 by king Sitric, and in 1152 it was made the see of an archbishop. In the Established Church Dublin is now (1868) the head of a province, including six bishoprics, viz. Dublin, Ossory, etc., Cashel, etc., Limerick, etc., Killaloe, etc., and Cork, etc. The present archbishop is Richard Chenevix Trench, D. D., primate of Ireland and metropolitan, consecrated 1843. The Roman Catholic Church has also an archbishop at Dublin, at present (1868) Paul Cullen, consecrated 1850, and a cardinal since 1866. The suffragans of the Roman Catholic archbishop are the bishops of Ossory, Kildare-Leighlin, and Ferns. See *Neher, Irish Statistik*, i, 27.

Dublin Manuscript (CODEX DUBLINENSIS DESCRIPTIUS), so called from Trinity College, Dublin, is the library of which it was discovered by Dr. John Barrett in 1787, written under some cursive Greek extracts made in the tenth century from Chrysostom, Epiphanius, etc. It is itself much older, probably of the sixth century, and of Alexandrian origin, and is one of the most important uncial palimpsests of the

pels, of which it is designated as Codex Z. Thirty-
of the leaves contain a large part of the Gospel of
:thew in twenty-two fragments (i, 17-ii, 6; ii, 18-
iv, 4-13; v, 46-vi, 16; vii, 16-viii, 6; x, 40-xi, 18;
43-xiii, 11; xiii, 67-xiv, 18; xv, 18-23; xvii, 9-
xvii, 26-xviii, 6; xix, 4-12; 21-28; xx, 7-xxi, 8;
, 23-45; xxii, 16-25; xxii, 37-xxiii, 8; xxiii, 18-
xxiv, 15-25; xxv, 1-11; xxvi, 21-29; 62-71).
se were published in fac-simile, with a (not very
rate) decipherment in ordinary type by Dr. Bar-
(Dublin, 1801), and they have since been carefully
ored by a chemical process by Dr. Tregelles. Each
e contains but one column, generally of 22 lines, in
rto. The Ammonian sections are given, but not
Eusebian canons; the *τιτλοι* are written at the
of the pages, the numbers being set in the margin.
writing is continuous, the *stigma* point either rarely
nd or quite washed out; the abbreviations are very
; and there are no breathings or accents. A space
portionate to the occasion is usually left where there
a break in the sense, and the capitals extend into
margin when a new section begins. The letters
in a plain, steady, beautiful hand, some 18 or 20
a line.—Tregelles, in Horne's *Introd.* iv, 180 sq.;
ivener, *Introd.* p. 119 sq. See MANUSCRIPTS, BIB-
:AL.

pupil, and for that end connived at all his excesses.
Finally he succeeded, in 1692, in inducing the duke to
marry Mademoiselle de Blois, a legitimized daughter
of Louis XIV, who rewarded him for this service by
giving him the abbey of St. Just. We now find him
mixed in all the political events of the time. Two
years after the death of Louis XIV he was made coun-
cillor of state by the regent, and soon found himself
at the head of the government. Intent only on fur-
thering his own interests, Dubois's policy was the pre-
cise opposite of Louis XIV's, and he became the obedi-
ent agent of England, with which power and Holland
he concluded the treaty called the Threefold Alliance,
at Hague, Jan. 14, 1717. Appointed minister of fore-
ign affairs, Dubois wished to be also archbishop, and
especially cardinal, as Richelieu and Mazarin had been.
He had caused, for that end, the bull *Unigenitus* to be
registered in France, but had obtained nothing but
promises from Clement XI. The archbishopric of
Cambrai becoming vacant, Dubois applied for it, al-
though he had only received the tonsure, without be-
ing in holy orders. The regent acceded to his de-
mand, and after receiving all the necessary ordina-
tions in one day, Dubois was consecrated June 9, 1720,
all the most eminent members of the French clergy,
with the exception of the cardinal de Noailles, tak-

ΑΝΟΙΓΩΣΙΝ ΟΙ ΟΦΘΑΛΜΟΙ ΗΜΩΝ
ΟΙ ΤΩΝ
ΣΤΡΑΓΧΝΙΘΕΙΣ ΔΕ ΟΙ
ΗΨΑΤΟΤΩΝ Ο ΤΩ
ΑΥΤΩΝ ΚΑΙ ΕΥΘΕΩΣ

specimen of the Codex Dublinensis (Matt. xx, 33, 34): ανοιγωσιν οι οφθαλμοι ημων | Στραγχνισει δε ο ιψησατο των
οι των | αυτων και ευθεωσ]

Dubno, SALOMO BEN-YOEL, born Oct. 12, 1738, at
Dubno, Russia, is best known by his Masoretic labors
on the Pentateuch, and by his efforts to advance poetic
literature among his countrymen. The great reformer
in Judaism and Hebrew literature, which had
commenced under the leadership of Mendelssohn, at-
tacked Dubno to Berlin, where he at one time lived
and labored with the great Jewish reformer. At the
age of 26 he edited Salomo ben-Moses's (also called
Emberger) work on the accents of Job, Proverbs, and
the Psalms, which he published in 1765, under the title
שְׁפָרַי נְעִימָה, *Porte Jucunditatis* (2d ed. 1777). In
1768 he commenced, in Hebrew, a commentary on the
Pentateuch, which Mendelssohn translated into Ger-
man. Some misunderstanding having sprung up be-
tween himself and Mendelssohn, he discontinued this
work, after having completed only סֵפֶר עַל סֵפֶר
בְּרֵאשִׁית, *Commentary on Genesis* (Berl. 1781-83; Vi-
enna, 1791, 1806, etc.). The remaining books were
finished by Mendelssohn, with the aid of other learn-
ed men. See MENDELSSOHN. He wrote also תִּקְוַת
סֵפֶר, a Masoretic Commentary on *Genesis and Ex-
odus*, printed with Mendelssohn's translation in 1831-
3. He died in Amsterdam June 26, 1831.—Etheridge,
Introduction to Hebrew Literature, p. 395, 421; Kitto,
Cyclopædia, i, 707.

Dubois, GUILLAUME, a French prelate and states-
man, was born at Brives-la-Gaillarde Sept. 6, 1656.
He studied at the college of St. Michael, at Paris, and
afterwards became tutor in the family of the marquis
de Pleuvant, and later of the duke of Orleans. He
pared no pains to obtain the full confidence of his

ing part in the ceremony. He was made a card-
inal in 1721 by Innocent XI (q. v.), whom, it is said,
he helped with large sums of money at the time of
his election. Dubois finally became prime minister
in 1722, and president of the assembly of the French
clergy. In this position he proved a capable and in-
telligent administrator, but ambitious and thorough-
ly unprincipled. He died at Versailles August 10,
1723. The duchess of Orleans, mother of the regent,
wrote of him: "If abbot Dubois had as much honesty
and religion as he has wit, he should be an excellent
man; but he believes in nothing, and regards neither
manners nor truth. He is very learned; he has taught
my son, but yet I could wish that he had never seen
him." Dubois, besides the archbishopric of Cambrai,
had seven abbeys, and his revenues amounted to two
millions, not counting a million he was said to have
received from England for his secret services. See
Duclos, *Mém. secrets sur les règnes de Louis XIV et de
Louis XV*; Saint-Simon, *Mémoires*, xviii-xx; G. Brunet,
Mémoires de la Princesse Palatine; Sismondi, *Hist.
des Français*, xxvi to xxviii; Sévelinges, *Mém. secr.
et Corresp. inéd. du Cardinal G. Dubois*, etc. Paris, 1814;
Hoefler, *Nouv. Biog. Générale*, xiii, 859 sq.

Dubosc, PIERRE THOMINES, a French Reformed
minister, was born in 1628 at Bayeux, in Normandy,
and became minister of the Protestant church at Caen,
and afterwards at Rotterdam, where he died in 1692.
Having, in 1688, addressed Louis XIV on the subject
of an edict directed against the Protestants, the king
said that "Dubosc was the finest orator of the whole
kingdom." He had a grand and elevated genius, a
happy imagination, a discriminating and solid judg-

ment. His constant aim in his sermons was to enforce the inseparable connection between faith, and holiness, and final salvation. He published *Sermons sur l'épître aux Ephésiens* (Rott. 1699, 8 vols. fol.):—*Sermons sur divers textes* (Rott. 1692-1701, 4 vols. 8vo). See *Vie de Du Bois* (Rott. 1794, 8vo); Darling, *Cyclop. Bibliographica*; Haag, *La France Protestante*, t. iii; Vinet, *Histoire de la Prédication*, Paris, 1860, 350 sq.

Dubourg, ANNE, one of the most interesting characters of French Protestantism, is noteworthy on account of his accomplishments, his lovely character, and his tragical end. He was born in the year 1521, of one of the best families in the Auvergne. In early life he devoted himself to the study and practice of law, and afterwards became a professor of civil law in the University of Orleans. At this period Calvin's writings were universally read, and Marot's psalms were upon every lip. Dubourg conscientiously examined the Protestant doctrines in order to arrive at the truth. He was well versed in the Scriptures, and acquainted with the early fathers and with the history of the Church, as his replies to his judge clearly show. On Easter, 1557, he still belonged to the Roman Church, and communion in it. On Oct. 19 of that year he was appointed as a spiritual counsellor to the Parisian Parliament, which exercised the immediate supervision over the University of Orleans. His learning had procured him this position without cost, which was rare in those days. His religious convictions were unknown; but, in order to enter upon his position, he was ordained subdeacon and deacon. His real views, however, soon became apparent. During Easter, 1558, he attended mass for the last time, and soon afterwards he took part in Protestant assemblages, and communion with them. The choicest members of the Parliament, including the presidents Harlay and Seguier, sympathized with him. The Roman Catholic party, finding the Parliament likely to be at least just, if not kind, towards Protestantism, appealed to the king (Henry II), representing to him the danger which threatened the faith. He appeared in Parliament attended by a large train, and in a short and violent speech expressed his desire that the Parliament would be more zealous in its support of the Church. When it was Dubourg's time to speak, he pointed out the wrong involved in permitting great criminals, as blasphemers, adulterers, etc., to go unpunished, while the most severe measures were adopted against innocent persons. Henry II was highly offended, and Dubourg was dragged to the Bastille, and his trial was at once ordered. Contrary to the laws, by which members of Parliament could only be tried by the assembled chamber, the king appointed a commission, made up of avowed enemies of Protestantism, and Dubourg was ordered to acknowledge this tribunal, if he did not desire to be condemned without a trial. Dubourg appealed in vain to the archbishops of Paris, Sens, and Lyons, who had jurisdiction over him as a spiritual councillor. The death of Henry II brought the Guises into power, who were still more zealous in the persecution of Protestants. Dubourg openly avowed his connection with the new Church, but could not be induced to discover the names of its members, or the time and place of their assemblages. He intended to hand a strongly evangelical and scriptural confession of faith to his judges, but some of his friends induced him to compose and transmit another, which was less objectionable to the Catholics. A letter from Marlorat, at that time pastor of the evangelical church at Paris, induced him, however, to forward the first confession, and he thus sealed his doom. According to law, an avowal of Protestantism was punishable with death. The cardinal of Lorraine urged the prosecution of Dubourg because he had ascertained that elector Frederick III of the Palatinate intended to secure Dubourg as a professor for Heidelberg. The president Minard was assassinated on Dec. 12, and

this was construed into a conspiracy in favor of it accused. Sentence was pronounced by Parliament against Dubourg on the 21st of December, to the effect that he was to be hanged and then burnt. His voice was raised in his favor. Two days later the sentence was executed (December 23, 1560). Dubourg was the first French Protestant of the upper class who sealed his confession with his blood. His end (noticed above) sides completely with the teaching of Calvin as contradicting distinguished from the Lutheran traditions.—*La vraye histoire contenant l'unique rapport contre Anne Dubourg* (Anvers, 1561, 12mo); Haag, *La France Protestante*, vol. iv; Schott, in Herwig's *his. Encyclop.* xix, 487.

Duc, FRONTON DU (Latin form FRONTO DUCES), a French Roman Catholic theologian, was born at Bodeaux in 1558, and entered the order of Jesuits at an early age. In 1604 he was made librarian of the college of Clermont, in Paris, in which office he spent the rest of his life, devoted to literature, especially Patristics. He died at Paris, September 25, 1624. Among his numerous publications are *Opuscula Gregoriana* (Ingolstadt, 1596, 8vo); *Laudatio Sanctissimi Hieronymi* (Paris, 1606, 4to); *S. Joannis Chrysostomi Opera Omnia* (Paris, 1609-1624, 6 vols. fol.), a work which is very creditable to the editor's erudition and industry; *Bibliotheca Veterum Patrum, seu Scripturae Ecclesiasticorum* (Paris, 1624, 2 vols. fol.); *Nicophori Callisti Ecclesiastica Historia libri xviii* (Paris, 1630, 2 vols. fol. posthumous). See Dupin, *Ecclesiastical Writers*, cent. xvii; Hoefer, *Novv. Biog. Générale*; Nicéron, *Mémoires*, xxxviii, 103.

Ducange, CHARLES DU FRESE, an eminent French scholar, was born at Amiens December 14, 1610. His name was really Du Frese; but as he was sieur Du Cange, he is generally named by the latter title. He studied at the Jesuits' College in Amiens, and afterwards pursued law studies at Orleans. He was received as *advocat au parlement* at Paris in 1631. In a few years he abandoned the bar, returned to Amiens, and devoted himself to the study of history and philology. In 1668 he was driven back to Paris by the plague, and died there October 23, 1688. "His works, which in number and extent are almost incredible, abundantly prove his right to be considered a consummate historian, an exact geographer, and a good lawyer, genealogist, and antiquary. He knew nearly every language, and derived, from his researches into an infinite number of ancient monuments, a singular acquaintance with the manners and usages of the Middle Ages." Among his publications are *Histoire de l'Empire de Constantinople sous les Empereurs François* (Paris, 1657, fol.):—*Trésor historique et critique de S. Jean Baptiste* (Paris, 1666, 4to):—*Glossarium ad scriptores mediae et infimae Latinitatis* (Paris, 1678, 3 vols. fol.; Frankfurt, 1681, and again in 1710; Benedictine edition, 6 vols. fol., 1733-86, to which Peter Carpentier published a Supplement, Par. 1766, 4 vols. fol.; new edition, by Heneschel, Paris, 1840-48, 7 vols. 4to; also supplementary vol. by Diefenbach, Frankfurt, 1857; abridgment by Adelung, Halle, 1772, 6 vols. 8vo):—*Glossarium ad scriptores mediae et infimae Graecitatis* (Paris, 1688, 2 vols. fol.). The *Glossarium Latinitatis* is the most useful work for the understanding of the numerous writers of the Dark or Middle Ages, when, for many centuries, a corrupt and barbarous Latin was the ordinary literary language of Europe. All the words used by these writers, which are not found in classical Latin, are ranged in alphabetical order, with their various meanings, their etymology, and references to the authorities. This work is also useful for understanding old charters, and other legal documents of an ancient date. The labor and research required for the compilation of such a work can be best appreciated by those who have frequent occasion to consult it" (*Engl. Cyclopædia*, s. v.). Many MS. works of Ducange are preserved in the royal library at Paris. See *France*

sur la vie et les ouvrages de Ducange (Par. 1852); *refer, Nouv. Biog. Générale*, xiv, 911.

Duchal, JAMES, D.D., an Independent divine, was born in Ireland in 1697, and was educated at the University of Glasgow. He served an Independent congregation at Cambridge for ten years, and afterwards other at Dublin, where he died in 1761. He published *Ten Sermons; Presumptive Arguments for the truth of the Christian Religion* (Lond. 1758, 8vo); also *athousand Sermons* (London, 1765, 8 vols. 8vo).—*urling, Cyclopaedia Bibliographica*, i, 968.

Duchatel, PIERRE (CASTELLANUS), a French prelate, was born at Arc, in Burgundy (date unknown), and was educated at Dijon, where he distinguished himself by his successful study of Greek. "He assisted Erasmus in his translations from the Greek, and became corrector of the press in Frobenius's office at Basle. He next studied the law at Bourges, after which he went to Rome, where he found little enjoyment except in contemplating the remains of antiquity. The corruption of morals in the Church of Rome filled him with indignation, and he appears to have conceived as an opinion of it as any of the Reformers, and expressed himself respecting it with as much severity as they did. From thence he travelled to Venice, and next visited Cyprus, where he read lectures for two years with great success. He afterwards went to Egypt, Jerusalem, and Constantinople, and on his return home was appointed reader to Francis I, who made him bishop of Tulle, and afterwards of Maçon. Henry II translated him to Orleans, where he died in 1552. He was a strenuous defender of the liberties of the Gallican Church, and exceedingly liberal to the protestants. He wrote an oration on Francis, and a Latin letter for that king to Charles V. In his funeral oration on Francis, he hinted that the soul of the king had gone to heaven, which excited the ire of the doctors of the Sorbonne, who thought that by so doing he opposed the doctrine of purgatory" (Hook, *Eccles. Biography*, s. v.); see also Jortin, *Life of Erasmus*; Bayle, *Dictionary*, s. v. Castellanus.

Duché, JACOB, D.D., a minister of the English Church in America, was born in Philadelphia in 1737, and graduated at the University of Pennsylvania. He went soon after to England, and spent some time at Cambridge. In 1759 he became an assistant minister in Philadelphia, having been licensed by Dr. Sherlock, then bishop of London. He was appointed shortly after professor of oratory in the College, and in 1762, after his return from a second visit to England, he was received as "one of the ministers of the United Churches." He was appointed chaplain to Congress, and continued in this office a short time. His political views, however, underwent a change, to which he incautiously gave expression, so that in 1777 he found himself under the necessity of retiring to England, where he was appointed to preach in the Lambeth Asylum, London. In 1790 he returned to Philadelphia, where he died Jan. 8, 1798. His publications comprise *Sermons* (1780, 2 vols. 8vo); *Observations, Moral, etc., by Casparina* (1778); and four detached *Sermons*.—*Sprague, Annals*, v, 180.

Duchobortzi, the name of a Russian sect, not certainly known to have existed before the 18th century. The word is the plural of Duchobozetz, meaning *Spirit Wrestler*. It is the name of one of the many sects of the Russo-Greek Church. The designation was adopted by themselves upon their separation from the sect called Molokans, or *Duchowny Christians*, "Spiritual Christians."

No records being kept by these people, it is impossible to ascertain the true time when the separation took place. It is, however, known that a certain Ilarion Pobirochin originated it by teaching—1. That God was not an essential being, but existed only in the generation of the righteous. 2. That the soul of

the righteous at death passes over into another human being, and that of the wicked into an animal. 3. That there are no higher beings of any kind. 4. That to read the Bible is needless trouble, for the spirit of God will teach every one his duty. Krazinski, in his work named at the end of this article, gives the following summary of a creed delivered by the Duchobortzi to a provincial governor at the time of Catharine's persecution: "God is one, but one in the Trinity. This holy Trinity is an inscrutable being. The Father is light, the Son is life, the Holy Ghost is peace. They are manifested in man—the Father by *memory*, the Son by *reason*, the Holy Ghost by *will*. The human soul is the image of God; but this image is nothing but memory, reason, and will. The soul existed and had fallen before the creation of the visible world; it is this fall that is recounted in the story of Adam and Eve, which, like most other portions of the Bible, should be taken allegorically. . . . In the beginning the soul's fall was occasioned by the circumstance that it *contemplated itself*, and commenced to love itself alone, thereby abandoning the contemplation and the love of God through *wilful pride*. . . . The soul is placed in the present life as in a place of purification, in order that, clothed in the flesh and abandoned to its will and reason, it may choose between good and evil, and thus obtain pardon of its primary sin, or incur eternal torment. When a body is prepared for us in this world, our soul descends from above, comes to take possession, and the man is then called into existence. Our body is the house in which the soul is received, and in which we lose all memory and feeling of what we had been before incarnation," etc. (p. 271, note).

Pobirochin considered and called himself one of the righteous, and a son of God. Of his followers he selected twenty-four of the most trustworthy and able-bodied; twelve of them he called archangels, and the other twelve mortiferous angels. The duty of the latter was to dispose of such as would backslide. They refused to serve in the army, on which account they were much persecuted under the czarina Catharine II, and exiled in the days of the emperor Paul. Alexander granted them a settlement on the banks of the Moloshna, near the Sea of Azof, where they numbered about two thousand. In 1839, the real or alleged discovery that a secret tribunal had existed among them caused their banishment to the other side of the Caucasus. At present this sect exists principally in the districts along the Caucasus, but in smaller numbers, and less attached to the peculiarity of the sect. They are to be found wherever there is a community of the Duchowny Christian, or Molokans. An effort was made in 1861 by a certain Ivan Gregorieff to found the sect among the Molokans residing at Tultscha, in Bulgaria, but failed, whereupon he returned to Russia. For the usages of the sect, see **MOLOKANS**. See Lenz, *de Duchobortzi* (Dorpat, 1829, 8vo); Seeborn, *Life of Stephen Grellet*, i, 456; Krasinski, *Histoire Religieuse des Peuples Slaves* (Paris, 1858, 8vo).

Duchowny (Spiritual), the name of a Russian sect which arose among the Duchowny Christian, or Molokans, on the Caucasus, in the following manner. In the year 1838 a certain aged man came from Jerusalem to the Caucasus, and taught that he possessed the power of bringing down the Holy Spirit, and of bestowing new tongues. He proved his commission by teaching his nearest friends a song which he said was in the language of Jerusalem, and the sense of which could be comprehended only by those who had received the Holy Spirit. The principal founder of this sect was, however, Maksim Rudometkin Komar, who also organized congregations in the surrounding places among the Molokans, and enjoyed the highest estimation from them. The sect adopted the creed of the Molokans, with the following addition: 1. The Holy Spirit descends upon the elect either directly or indi-

rectly by being breathed upon. 2. Jumping, shaking, contortions, etc., are infallible signs of the presence of the Spirit. 3. The swooning from exertion, and consequent unintelligible speaking, is considered as the new language, which none understand except the select, whose duty it is to explain the muttering of the enthusiasts. 4. The expectation of the near end of all things, and consequent inutilty of labor beyond extreme necessity, is matter of faith. 5. The literalism of the holy Scriptures is assumed, even so far that Komar once, for the sake of punishing his followers for their slothfulness, went to the nearest mountain, pretending to ascend and to leave them alone; the mass of the people fell on their knees, and prayed him not to leave them, and promised to be obedient. 6. Repentance consists in the payment of such amounts of money as the leader estimates their sins to be worth, for which he grants indulgence in the shape of pieces of muslin on which are embroidered signs of mysterious signification. The Duchowny are found principally in the Caucasus, but almost every community of Molokans has a few of them among its members. See MOLOKANS.

Duchowny Christiany. See MOLOKANS.

Dudaïm. See MANDRAKE.

Dudgeon, DAVID, a Scotch sceptic, was born in 1706. Little is known of his early history. In 1782 he published a treatise entitled *The Moral World*, which teaches that "there is no evil in the moral world but what naturally ariseth from the nature of imperfect creatures, who always pursue their good, but cannot but be liable to error or mistake, and that evil or sin is inseparable in some degree from all created beings, and most consistent with the designs of a perfect Creator." He was called to answer for it before the Presbytery, Synod, and General Assembly, but no decision appears to have been reached. His most important work is *Philosophical Letters concerning the Being and Attributes of God* (1787). "These letters were written in the midst of pressing agricultural cares, to the Rev. Mr. Jackson, author of a work written in the spirit of Clarke, *The Existence and Unity of God*. In these letters Dudgeon reaches a species of refined Spinozism, mingled with Berkeleyanism. He denies the distinction of substances into spiritual and material, maintains that there is no substance distinct from God, and that 'all our knowledge but of God is about ideas; they exist only in the mind, and their essence and modes consist only in their being perceived.' In 1789 he published *A Catechism founded upon Experience and Reason, collected by a Father for the Use of his Children*; and in an 'Introductory Letter' he wishes that natural religion alone was embraced by all men, and states that though he believes there was an extraordinary man sent into our world seven hundred years ago to instruct mankind, yet he doubts whether he 'ever commanded any of those things to be written concerning him which we have.' The same year he published *A View of the Necessitarian or Best Scheme, freed from the Objections of M. Crousas, in his Examination of Pope's Essay on Man*. Dudgeon died at Upeattlington, on the borders, Jan. 1748. His works were published in a combined form in 1765, in a volume without a printer's name attached, showing that there was not as yet thorough freedom of thought in Scotland. His writings had for a time a name in the district (the Catechism reached a third edition), but afterwards passed away completely from public notice."—McCosh, in *Brit. and For. Ev. Review*, July, 1865, p. 552.

Dudith, ANDREAS SBARDELLATI, was born at Buda, in Hungary, in 1583, and became bishop of Tina, in Dalmatia, in 1560. He was afterwards appointed successively bishop of Csanad, then of Fünfkirchen, secretary of the Hungarian chapter, and in 1562 was sent to the Council of Trent as the representative of

the Hungarian clergy. Here he advocated the wearing of the cap to the laity very strenuously, and opposed the celibacy of the clergy. A secret marriage he had contracted led him to resign his office in 1567. He then resided for some time at Csanad, where he openly professed the Protestant religion; afterwards he lived on his estates in Moravia, and died at Breslau in 1589. In one part of his works he inclined to Socinianism, but in the latter years of his life he professed the evangelical doctrine. None of his writings were published at Offenbach in 1811. In respect to toleration, Dudith was in advance of his age. He writes to Beza, "You try to justify the banishment of Ochino, and the execution of others, as you seem to wish Poland would follow your example. God forbid! When you talk of your Augsburg Confession, and your Helvetic Creed, and your unanimity, as your fundamental truths, I keep thinking of the sixth commandment, *Thou shalt not kill*' (Benedict, *History of the Baptists*). The speeches made by him at Trent were published by Schwarz under the name of Lucidus Samuelfy (Halle, 1743). See Mosheim, *Church Hist.* (N. Y. 1854), iii, 231, note; Stiefel, *Geschichte des Lebens Dudith's* (Breslau, 1756).

Duel. See COMBAT.

Duffield, GEORGE, D.D., an eminent Presbyterian minister, was born in Lancaster Co., Pa., Oct. 7, 1712, and graduated at Nassau Hall in 1732, after completing his theological studies, he became pastor two years. He was licensed in 1756, and having accepted a call from the united churches of Carlisle, Pa., Spring, and Monahan, Pennsylvania, was ordained in 1761. He was a very popular preacher, and a successful promoter of revivals. In 1766 he undertook an important mission along the frontiers of Pennsylvania to the Potomac, with a view to the organization of churches. Some time after he was called to the Second Presbyterian Church, Philadelphia, and became chaplain to the Colonial Congress for part of a year. He attended the American army through New Jersey in the darkest hours of the Revolution, and manifested himself on all occasions the uncompromising advocate of civil and religious freedom. He died Feb. 2, 1797. He published *An Account of his Tour along the Frontiers of Pennsylvania:—A Thanksgiving Sermon*, Edin.—Sprague, *Annals*, iii, 186.

Du Fresno. See DUCANGE.

Dugdale, SIR WILLIAM, an English antiquary, was born in Warwickshire, September 12, 1606, and devoted his life chiefly to the study of English antiquities. He died February 10, 1686. Among his writings, the most notable is the *Monasticon Anglicanum* (1655-78, 8 vols. fol. London; new ed. of vol. i, 1863; 3d edit. 1817-29, 8 vols. fol.), containing an account of the religious houses of England, with abundant illustrative plates; an English version (probably by James Wright), abridged, appeared in 1692, and another in 1718 (fol.), probably by John Stevens; he also published *The History of the Ancient Monasteries, Hospitals, etc.*, being two additional volumes to Dugdale's *Monasticon* (2 vols. fol. 1722-28). Dugdale also wrote a *History of St. Paul's Cathedral* (1716, fol.; 2d edit. by Ellis, London, 1818).—Kippis, *Biographia Britannica*, v, 479.

Duguet, JACQUES JOSEPH, an eminent Jansenist divine, was born at Montbrison, Dec. 9, 1648. He was ordained priest in 1677. He belonged to the Congregation of the Oratory till 1686, when the Congregation declared against Cartesianism and Jansenism. He then went to Brussels to enjoy the society of his friend Antoine Arnauld, with whose doctrinal views he thoroughly sympathized. Duguet returned to France very shortly afterwards, and spent the remainder of his life in retirement. He died at Paris Oct. 25, 1738. His life was embittered by the theological disputes of the

; and his opposition to the bull *Unigenitus*, his attachment to Quésnel, whose piety and talents were not to his own, with his general adhesion to the principles of Jansenism, caused him great annoyance from the ruling Church party. Among his works are *Exposition du livre de la Genèse selon la méthode des saints Pères* (Paris, 1732, 6 vols. 12mo):—*Explication du livre de Job* (Paris, 1732, 4 vols. 12mo):—*Traité de croix de notre Seigneur Jésus-Christ* (Paris, 1713, 9 s.):—*Traité dogmatiques sur l'Eucharistie* (1737, no):—*Conférences Ecclésiastiques* (Paris, 2 vols. no):—*Explication des xxv premiers chapitres d'Isaïe* (Paris, 1734, 6 vols. 12mo).—Herzog, *Real-Encyclop.* 535.

Du Halde, JEAN BAPTISTE, a learned Jesuit, was born at Paris, 1674, and entered the Jesuit order in 1698. His superiors gave him the task of editing the letters of missionary Jesuits, especially of those in China. The fruit of his labors appeared in his *Description géographique et historique de l'empire de la Chine* (Paris, 1735, 4 vols. fol.); translated, *The general History of China* (London, 1736, 4 vols. 8vo). After the death of Legobien (q. v.), Du Halde continued the publication of the celebrated *Letters Edifiantes et Curieuses écrites des missions étrangères, depuis le 9^{me} recueil jusqu'au 26^{me}*. He died at Paris August 18, 1743.

Duke (from the Latin *dux*, a leader) stands in our version for two Heb. terms: מְלִיכָא (see a dissertation on this word by Sprenger, in the *Zeitschr. f. deutsch. orgenl. Gesellschaft*, XII, ii, 316), *aluph'*, a leader, which, besides its ordinary sense of *guide* or *friend*, is used technically of the *phylarch*, or head of a tribe or nation, especially of the Edomitish chieftains (Gen. xxvi, 15-43; Exod. xv, 15; 1 Chron. i, 51-54), rare of the Jews ("governor," Zech. ix, 7; xii, 5, 6), and once of chiefs in general ("captain," Jer. xiii, 21); also מְלִיכָא, *nasik'*, one *anointed* (usually in poetry), spoken of the *magmates* of Sihon, perhaps by a periphrase for that king himself (Josh. xiii, 21), elsewhere of other "princes" (Psa. lxxiii, 11; Ezek. xxxii, 30; Dan. xi, 8; "principal men," Mic. v, 5).

Dukiphath. See LAPWING.

Dul'cimer (Chald. מְלִיכָא, *sumponyah'*; Sept. *συμφωνία*, Vulg. *symphonia*), a musical instrument, not in use among the Jews of Palestine, but mentioned in Dan. iii, 5, 15, and at ver. 10 under the shorter form of מְלִיכָא (*syphonya'*, where the text correctively reads מְלִיכָא), along with several other instruments, which Nebuchadnezzar ordered to be sounded before a golden image set up for national worship during the period of the captivity of Judah. Luther translates it *ute*. Grotius adopts the view of Servius, who considers *symphonia* to be the same with the crooked trumpet (*tibia obliqua*, *πυλαυλος*); he also quotes Isidore (ii, 22), who speaks of it as a long *drum*. Rabbi Saadia Gaon (*Comm. on Dan.*) describes the *sumponyah* as the *bag-pipe*, an opinion adopted by the author of *Schilth hag-giborim* (in Ugolini's *Theaur.* xxxii, 39-42; see Joel Brill's Preface to Mendelssohn's version of the Psalms), by Kircher, Bartholocius, and the majority of Biblical critics. The same instrument is still in use among peasants in the N.W. of Asia and in Southern Europe, where it is known by the similar name *symponna* or *sampogna*. With respect to the etymology of the word a great difference of opinion prevails. Some trace it to the Gr. *συμφωνία* (whence Eng. *symphony*), and Calmet, who inclines to this view, expresses astonishment that a pure Greek word should have made its way into the Chaldee tongue: it is probable, he thinks, that the instrument dulcimer (A. V.) was introduced into Babylon by some Greek or Western-Asiatic musician who was taken prisoner by Nebuchadnezzar during one of his campaigns on the coast of the Mediterranean. Gesenius adopts this deriva-

tion (*Theo. Heb.* p. 941), and cites Polybius (*ap. Athen.* x, 52, p. 489, ed. Casaub.) and Isidore (*Orig.* iii, 21) in confirmation. Others regard it as a Schematic word, and connect it with מְלִיכָא, "a tube" (Fürst). The word מְלִיכָא occurs in the Talmud (*Sukka*, 36 a), where it evidently has the meaning of an air-pipe, with a case (*Chelim*, xvi, 8); but the explanation (*Chelim*, ii, 6) by מְלִיכָא is not clear (Rosenmüller on *Dan.* l. c.). Landau (*Aruch*. Art. מְלִיכָא) considers it synonymous with *siphon*. Ibn Yahia, in his commentary on Dan. iii, 5, renders it by אֵרְגָנִיתָא (*organ*), the well-known powerful musical instrument composed of a series of pipes. Rabbi Elias, whom Buxtorf quotes (*Lex. Talm.* col. 1504), translates it by the German word *Leier* (lyre). The old-fashioned *spinnet*, the precursor of the harpsichord, is said to have resembled in tone the ancient dulcimer. The modern dulcimer is described by Dr. Busby (*Dict. of Music*) as a triangular instrument, consisting of a little chest, strung with about fifty wires cast over a bridge fixed at each end; the shortest wire is 18 inches in length, the longest 36; it is played with two small hammers held in the hands of the performer.—Smith, s. v. See MUSICAL INSTRUMENTS.

Dulcinists, followers of Dolcino, or Dulcinus, a priest and native of Novara, Italy, who followed Segarelli (q. v.) as leader of the Apostolici (q. v.), about A.D. 1200. He and his followers, being put under the ban, fortified a mountain in Novara, where they were taken prisoners. "He was charged with contempt of the Catholic hierarchy; also with asserting a succession of three theocracies—that those under the Father and the Son were already passed; that the third, under the Holy Spirit, was then in operation. His followers called themselves 'The Spiritual Congregation and the Order of the Apostles.' 'We alone (they said) are in the perfection in which the apostles were, and in the liberty which proceeds immediately from Jesus Christ. Wherefore we acknowledge obedience neither to the pope nor to any other human being; nor has he any power to excommunicate us. . . . The pope can give no absolution from sins unless he be as holy as St. Peter, living in entire poverty and humility. . . . so that all the popes and prelates since St. Sylvester, having deviated from that original holiness, are prevaricators and seducers, with the single exception of pope Celestine, Pietro di Morone, etc.' (See Fleury, liv. xci, sec. xxiii.) Lastly, to consummate his odium, his followers, who were not very numerous, were assailed with the primitive and accursed calumny of promiscuous prostitution" (Waddington, *Church History*, chap. xxii). Extracts from two of the writings of Dolcino are given in the *Historia Dulcini*, and in the *Additamentum ad Historiam Dulcini* in Muratori, *Script. Rer. Ital.* ix, 426 sq., cited in Herzog, *Real-Encyclop.* iii, 468 sq., from which we condense the following statements.

After strongly asserting his orthodoxy, Dolcino predicted that in the year 1303 his opponents should be destroyed; that he and his followers should then, without molestation, preach publicly, and in these last days all Christians should embrace his doctrines. As this prophecy was not fulfilled in 1303, he postponed its fulfilment to 1304, under the pretence that God had especially called him, and made known to him the import of the Bible prophecies. He distinguished four epochs in the history of the divine life, each of which was good in the first instance, but had been superseded as it became degenerate. The patriarchs of the old covenant belonged to the first epoch. In the second, Christ appeared with his apostles, to supersede the degenerated Judaism by new virtues, especially celibacy, poverty, and the giving up of earthly goods. The third epoch began with pope Sylvester and the emperor Constantine, when the Christians, in order to edu-

cate the newly-converted masses of heathen in Christian life and duty, were obliged to accept riches, and show the heathen how to apply the goods of this world to the honor of God. But zeal waxed cold, and the love of the world increased, until a reaction appeared in the Order of St. Benedict. As this effort to induce self-denial in the clergy and the monks failed, the more stringent rules of the Dominicans and Franciscans followed. But these also were of no effect. The fourth epoch, according to Dolcino, was the renewal of apostolic life by Segarelli and himself, to continue to the end of the world. This apostolical life demands self-denial and renunciation of earthly possessions, and consists in the unity of the brethren in the love of the Holy Ghost, without external forms, usages, or regulations. From these doctrines it would appear that the teachings of the abbot Joachim (q. v.) had had a certain effect upon Dolcino, and that the views which Joachim cherished in regard to the era of the Holy Ghost were embraced by Dolcino, although this is generally denied. Aside from the apocalyptic prophecies, the doctrines of Dolcino seem to be penetrated by a mysticism which repudiated external things, considering them as the cause of evil. Love, in its perfection, was to be realized as the inner bond of souls, supreme over all law. All human relations, especially that of man and wife, were to be founded upon a merely spiritual union; all law, as well as all right of property, were to be removed, so that nothing should prevent man from enjoying the highest state of perfection. Dolcino lived himself with a former nun, Margaretha, whom he called his *dilectissima soror*, in voluntary poverty. The dangerous tendency of such doctrines is obvious. That Dolcino perceived the true nature and causes of certain abuses in the Church, and that he honestly desired to correct them, can hardly be questioned. His memory was long cherished by the common people; to them he seemed a hero and martyr, while to the armies which persecuted him he seemed a false prophet, punished by the powerful arm of God. Dante compares Dolcino to Mohammed (*Inferno*, xxviii, 56, etc.). Dolcino was tortured to death at Vercelli by order of Clement V. See Mosheim (Murdoch's ed.), *Church History*, bk. iii, c. xiii, pt. ii, ch. v, § 14; Krone, *Fra Dolcino und die Patavener* (Leips. 1844); Mariotti, *Fra Dolcino and his Times* (Lond. 1853); Gieselser, *Church History*, ii, § 87; and APOSTOLICAL; SEGARELLI.

Dulia (δουλία), worship paid to saints and angels. In the Greek Church, a distinction is made between λατρεία, worship due only to God, and τιμητική προσκύνησις, adoration which may be rendered to images. Authority for this distinction is found in a decision of the second Council of Nicæa, A. D. 787 (sess. vii), as follows: "We decide that the holy images, whether painted or graven, or of whatever kind they may be, ought to be exposed to view, whether in churches, upon the sacred vessels and vestments, upon walls, or in private houses, or by the roadside, since the oftener Jesus Christ, his blessed mother, and the saints are seen in their images, the more will men be led to think of the originals, and to love them. Salutation and the adoration of honor ought to be paid to images, but not the worship of *latría*, which belongs to God alone; nevertheless, it is lawful to burn lights before them, and to incense them, as is usually done with the cross, the books of the Gospels, and other sacred things, according to the pious use of the ancients; for honor so paid to the image is transmitted to the original which it represents. Such is the doctrine of the holy fathers, and the tradition of the Catholic Church; and we order that they who dare to think or teach otherwise, if bishops or other clerks, shall be deposed; if monks or laymen, shall be excommunicated" (London, *Manual of Councils*, 487; Labbe and Cossart, *Concil. vii*, 1-963; Mansi, *Concil. xiii*, 874 sq.; Hefele, *Concilien-geschichte*, § 864).

In the Roman Church a distinction is made between *latría* (λατρεία), worship due to God; *doctis* (δοξασ), adoration or invocation of saints and angels; and *προσκύνησις* (προσκύνησις), due to the Virgin Mary and (Council of Trent, sess. xxv). Protestants, of course, reject all these distinctions. See Hagenbach, *History of Doctrines*, § 188; Haag, *Histoire des Dogmes Catholiques*, ii, 77; Burnet, *On the Articles*, art. xxxi; and the articles IDOLATRY; IMAGE WORSHIP; LIVING OF SAINTS.

Du'mah (Heb. *Dumah*, דומה, *silence*), the name of a (person and) district and also of a town.

1. (Sept. Δουμά, Ἰδομά, Ἰδομαία; Vulg. Dum.) The fourth son of Ishmael (B. C. post 2064), and the tribe descended from him, as hence of the region inhabited by them in Arabia (Gen. xxv, 14; 1 Chron. i, 28). In Isaiah (xxi, 11), the "burden of Dumah" is coupled with Seir, the forest of Arabia, and Kedar. It is doubtless the same called at this day *Stow* or *Srin* *Duma*, situated on the confines of the Syrian desert and Arabia, with a fortified castle (Niebuhr, *Arabia*, p. 344), marked on D'Anville's map under lat. 24°; long. 68°; the *Dumath* lying 5 or 7 days journey from Damascus, and 13 from Medina, in the district *Jed* or *Sirhân* (Abulfeda, *Tab. Arab.* ed. Gagner, p. 36); probably also the *Dumatha* of Ptolemy (v, 15). This identification (see Freytag, *Hist. Halebi*, p. 55) with the name of a town in the north-western part of the peninsula is strengthened by Arab traditionists, who have the same belief (see the MS. *Mir'at al-Zaman*). The lexicographers and geographers of their nation expressly state that it is correctly "*Dumat el-Jendel*" or "*Duma el-Jendel*," signifying "Dumah of the stones or blocks of stone," of which it is said to have been built (MS. *Sihak*, *Marasid*, and *Mushtarak*, s. v.). *el-Jendel* is said by some to mean "stones such as a man can lift" (see the *Kamûs*), and seems to indicate that the place was built of unhewn or Cyclopean masonry, similar to that of very ancient structures. The town itself, which is one of the "Kureiyât" of *Wady el-Kura* (see the *Marasid*, s. v. *Dumah*), appears to be called *Duma*, and the fortress which it contains to have the special appellation of "*Marid*." See ARABIA.

2. (Sept. *Πεμνά* v. r. *Πουμά*; Vulgate *Duma*.) A town in the mountain district of Judah (Josh. xv, 25), in the group west by south of Hebron (Keil, *Comment.* in loc.). Eusebius and Jerome (*Onomast.* s. v. *Sepse*, *Duma*) say it was then a large village (ὄψις μεγάλη), 17 miles from Eleutheropolis (Beit-Jibrin), in the district of Daroma (i. e. "the south," from the Hebrew דרומה). Dr. Robinson passed the ruins of a village called *ed-Daumeh*, 6 miles south-west of Hebron (ib. i, 814), and this is probably the same place. (See also Kiepert's *Map*, 1856; and Van de Veldt's *Memoir.* p. 808).

Dumb (דָּמָם, *illem'*; but in Heb. ii, 9, דָּמָם, *illem'*; Gr. κωφός, which also signifies *deaf*, since the two defects generally accompany each other; also δόλιχος, *speechless*, Mark vii, 37; ix, 17, 26; ἀφωτος, *speechless*, Acts viii, 32; 1 Cor. xii, 2; 2 Pet. ii, 16; and *mutus*, Luke i, 20), has the following significations: (1.) One unable to speak by reason of natural infirmity (Exd. iv, 11). (2.) One unable to speak by reason of want of knowing what to say, or how to say it; what proper mode of address to use, or what reasons to allege in his own behalf (Prov. xxxi, 8). (3.) One unwilling to speak (Psa. xxxix, 9). We have a remarkable instance of this venerating dumbness, or silence, in the case of Aaron (Lev. x, 8), after Nadab and Abihu, his sons, were consumed by fire. "Aaron held his peace;" did not exclaim against the justice of God, but saw the propriety of the divine procedure, and humbly acquiesced in it. Christ restored a man who was dumb from diabolical influence (Matt. ix, 32; Luke xi, 14), and another who was both blind and

b from the same cause (Matt. xii, 22). The man was deaf and had an impediment in his speech (rk vii, 32-35), whom Christ restored, was not dumb, probably deaf by nature, but was one who had a real impediment to enunciation, or who, having lost his hearing, gradually lost much of his speech, and had become a stammerer. Such an impediment is either *natural*, arising from what is called a tumor, or ulcer, by which any one is, as we say, *tongue-tied*, or brought on when, from an early loss of hearing, the membrane of the tongue becomes rigid and ble to perform its office. See DEAF; SILENCE.

Dumont, GABRIEL, was born at Crest, in Dauphiny, Aug. 10, 1680. His first settlement was over Walloon church in Leipzig. In 1720 he was called to Rotterdam. Here he was held in very high estimation. He was also for a time chaplain to the French embassy at Paris. His essays, included in *Sauvages Découvertes sur la Bible*, and also in Masson's *Histoire critique de la république des lettres*, bear witness to his extensive knowledge, and especially to his acquaintance with the Oriental languages. A volume of valuable sermons from his pen was published after his death by his colleague, De Superville (Rotterdam, 1749, 8vo). He died Jan. 1, 1748.

Du Moulin, Charles. See MOULIN, DU.

Du Moulin, Pierre. See MOULIN, DU.

Dumplers, a name of reproach given to the Dutch, or German Baptists. See BAPTISTS, GERMAN.

Dunash ben-Labrath ha-Levi, an eminent Jewish scholar, was born in Bagdad about A.D. 920, and died at Fez, and died at Cordova about A.D. 960. His writings contributed largely to the development of Hebrew lexicography and Biblical exegesis. These writings are chiefly in the form of controversies with Saadia (q. v.) and Menachem ben-ruk (q. v.). His criticisms of the grammatical and exegetical works of Saadia are entitled *ספר השביר* (*Book of Animadversions*), only fragments of which remain. They show that he was a better grammarian, especially as to knowledge of the verb, than Saadia. These fragments are preserved in the *ספר חרוב*, work of Aben Ezra (q. v.) written in defence of Saadia, published with a critical commentary by Lippmann, and with a preface by Joet (Frankf. a. M. 1843). A criticism of Menachem's Hebrew Lexicon comes, according to Fürst, 200 articles, each concluding with some terse remark or saying in rhyme. It was embellished with notes by H. Filipowski, and with remarks by Leopold, Dukes, and Kirchheimer, by the London Antiquarian Society (Lond. and Edinb. 1855). The principal points may be summed up in the following: 1. Dunash classifies *verbs* and *adverbs* separately, and objects to the derivation of the former from the latter. 2. Distinguishes the *servile* letters of verbs from nouns similar in form by grammatical rules. 3. Shows the advantage of the application of the Chaldee and Arabic in the explanation of Hebrew words. 4. Divides parts in more than twenty-four different verses in the Masoretic text, which by many are thought to yield a better sense. Fürst says of this work that it is "of great interest in relation to a knowledge of Hebrew philology, of the new Hebrew poetry, and of the state of Jewish culture in Spain in the tenth century." The influence which Dunash exercised over Jewish grammarians and expositors of the Bible is seen in the frequent quotations made from his works by the principal lexicographers and commentators, such as Rashi, Joseph Cara, Aben-Ezra, and Kimchi.—*ukes, Liter. Mittheil. über die ältest. hebräischen Exegeten, Grammatiker u. Lexicographen* (Stuttg. 1844), 149, etc.; Steinschneider, *Cat. Libr. Heb.*; Etheridge, *Introduction to Hebr. Literature*, p. 878 and 879; Fürst, *Hebrew and Chaldee Lexicon* (Leips. and Lond. 1871), Preface, xxv sq.; Kitto, *Cyclop.* i, 709.

Dunash (ADONIM) ben-Tanim, the Babylonian, born at Irak about A.D. 900, was educated at Keirawan by the celebrated Isaac Israeli (q. v.), and died about 960. At the age of twenty he had become so proficient in Hebrew learning that he was able to write an elaborate critique of the works of Saadia, besides writing also a special Hebrew grammar containing a comparison of the linguistic characteristic of the Hebrew and Arabic languages, and a commentary on the *Book of Creation*. His writings (mostly yet in manuscript) are often referred to by Aben-Ezra and other expositors. Dunash was the first who maintained that the Hebrew language has diminutives, which are effected by the endings *ון* and *ין*; e. g. *אֲרִיִּים*, 2 Sam. xiii, 20. Aben-Ezra opposes this opinion, and asserts that the Hebrew language has no diminutives; but Ewald, in his *Grammar* (c. 167), has espoused Dunash's opinion.—Kitto, *Cyclopædia*, i, 710; Fürst, *Hebrew and Chaldee Lexicon*, Preface, p. xxv.

Dung (prop. *דִּינָה*, *tsophi'a*, Ezek. iv, 15, spoken exclusively of animals, such as the cow or camel; also *דִּינָה*, *do'men, ordure*, as spread on land, 2 Kings ix, 37; Psa. lxxxiii, 10; Jer. viii, 2; ix, 22; xvi, 4; xxv, 88; while *דִּינָה*, *pe'resh*, signifies *feces* as contained in the entrails of victims, Exod. xxix, 14; Lev. iv, 11; viii, 17; xvi, 27; Num. ix, 6; Mal. ii, 3. On the other hand, human excrement is specially denoted by *דִּינָה*, *tsa'ah*, Deut. xxiii, 18; Ezek. iv, 12; a sense also applied to *גָּלָל*, *ge'el*, Job xx, 7; Ezek. iv, 12, 15; Zeph. i, 17; but not necessarily to *גָּלָל*, *galal*, 1 Kings xiv, 10. The Greek word is *κόπρος*, whether of men or brutes; used in the Sept. for all the above, but found in the N. T. only in the form *κοπρία, manure*, Luke xiii, 8; while *ἀνὴρβαλον*, Phil. iii, 8, properly signifies *refuse*). The use of such substances among the Jews was twofold.

1. *As manure*. This consisted either of straw steeped in liquid manure (*בְּמַיִם שֶׁבַדְמָיִם*, lit. *in dung-water*, Isa. xxv, 10), or the *sweepings* (*סִינִינָה*, Isa. v, 25) of the streets and roads, which were carefully removed from about the houses and collected in heaps (*הַמְּטָה*) outside the walls of the towns at fixed spots (hence the *dung-gate* at Jerusalem, Neh. ii, 18), and thence removed in due course to the fields (Mishna, *Shabb.* 8, § 1-3). See below. The mode of applying manure to trees was by digging holes about their roots and inserting it (Luke xiii, 8), as still practised in Southern Italy (Trench, *Parables*, p. 856). In the case of sacrifices the dung was burned outside the camp (Exod. xxix, 14; Lev. iv, 11; viii, 17; Num. xix, 5); hence the extreme opprobrium of the threat in Mal. ii, 3. Particular directions were laid down in the law to enforce cleanliness with regard to human ordure (Deut. xxiii, 12 sq.): it was the grossest insult to turn a man's house into a receptacle for it (*מִיִּצְיֹאֵי*, 2 Kings x, 27; *חֵרֶב*, Ezra vi, 11; Dan. ii, 5; iii, 29, A. V., "dung-hill"); public establishments of that nature are still found in the large towns of the East (Russell's *Alppo*, i, 84). The expression to "cast out as dung" implied not only the offensiveness of the object, but also the ideas of *removal* (1 Kings xiv, 10), and still more *exposure* (2 Kings ix, 37; Jer. viii, 2). The reverence of the later Hebrews would not permit the pronunciation of some of the terms used in Scripture, and accordingly more delicate words were substituted in the margin (*צִיֹּאֵה*, *tsa'ah*, for *חֵרֶב*, *charaim*, or *חֵרֶב*, *charim*, 2 Kings vi, 25; x, 27; xviii, 27; Isa. xxxvi, 12). The occurrence of such names as Gilgal, Dimnah, Madmenah, and Madmannah, shows that these ideas of delicacy did not extend to ordinary matters. The term *ἀνὴρβαλα* (A. V., "dung," Phil. iii, 8) is applied by Josephus (*War*, v, 13, 7) to ordure (comp. *Eccles.* xxvii, 4). See MANURE.

2. *As fuel.* In a district where wood is scarce, dung is so valuable for this purpose that little of it is spared for the former. The difficulty of procuring fire-wood in Syria, Arabia, and Egypt has therefore made dung in all ages highly prized as a substitute: it was used for heating lime-kilns (Theopr. *Lap.* 69), ovens, and for baking cakes (Ezek. iv, 12, 15), the even heat which it produced adapting it peculiarly for the latter operation. Cows' and camels' dung is still used for a similar purpose by the Bedouins (Burckhardt's *Notes*, i, 57): they even form a species of pan for frying eggs out of it (Russell, *Aleppo*, i, 89); in Egypt the dung is mixed with straw and formed into flat, round cakes, which are dried in the sun (Lane, *Mod. Eg.* i, 252; ii, 141). This use of dung for fuel by the ancient Israelites, however, is collected incidentally from the passage in which the prophet Ezekiel, being commanded, as a symbolical action, to bake his bread with human dung, excuses himself from the use of an unclean thing, and is permitted to employ cows' dung instead (Ezek. iv, 12-15). This shows that the dung of animals, at least of clean animals, was usual, and that no ideas of ceremonial uncleanness were attached to its employment for this purpose. The use of cow-dung for fuel is known to European villagers, who, at least in the west of England, prefer it in baking their bread "under the crock," on account of the long-continued and equable heat which it maintains. It is there also not unusual in a summer evening to see aged people travelling the green lanes with baskets to collect the cakes of cow-dung which have dried upon the road. This helps out the ordinary fire of wood, and makes it burn longer. In many thinly-wooded parts of south-western Asia, the dung of cows, camels, horses, asses, whichever may happen to be the most common, is collected with great zeal and diligence from the streets and highways, chiefly by young girls. They also hover on the skirts of travellers, and there are often amusing scrambles among them for the droppings of the cattle. The dung is mixed up with chopped straw and made into cakes, which are stuck up by their own adhesiveness against the walls of the cottages, or are laid upon the declivity of a hill, until sufficiently dried. It is not unusual to see a whole village with its walls thus garnished, which has a singular and not very agreeable appearance to a European traveller. Towards the end of autumn, the result of the summer collection of fuel for winter is shown in large conical heaps or stacks of dried dung upon the top of every cottage. The usages of the Jews in this matter were probably similar in kind, although the extent to which they prevailed cannot now be estimated. (See Kitto, *Pictorial Hist. of the Jews*, ii, p. cccxlix.—Smith, s. v.; Kitto, s. v. See FUEL.

DUNG-GATE (דַּנְגָה הַשְּׂפֹתָיִם, *sha'ar ha-ashpoth'*, Neh. iii, 14, or דַּנְגָה הַשְּׂפֹתָיִם, *sha'ar ha-shephoth'*, iii, 13, i. e. *gate of the dung-hills*; Sept. ἡ πόλις [v. r. in xii, 81, τὸ τειχος] ἡ γης *keriatic*; Vulg. *porta sterquilinis* or [ii, 13] *stercoris*; A. V. "dung-port" in ii, 13), a gate of ancient Jerusalem on the south-west quarter, 1000 cubits from the Valley Gate (Neh. iii, 13) toward the south (Neh. xii, 81); a position that fixes it at the S.W. angle of Mt. Zion (see Strong's *Harm. and Expos. of the Gosp.* App. ii, p. 11). It was doubtless so called from the piles of garbage collected in the valley of Tophet (q. v.) below. See BETHSO. (Compare the *Esquiline Hill* at Rome.) Josephus (*War*, v, 4, 2) calls it the *Gate of the Essenes* (ἡ Ἐσσηνῶν πόλις). See JERUSALEM.

DUNGHILL (דַּנְגָה הַשְּׂפֹתָיִם, *ashpoth'*, 1 Sam. ii, 8; Psa. cxlii, 7; Lam. iv, 5; מַדְמֵנָה, *madmenah'*, a heap of *compost*, Isa. xxv, 10; Chald. נִבְלָה, *nevalu'*, Ezra vii, 11, or נִבְלָה, *nevali'*, Dan. ii, 5; iii, 29, a *sink*; Greek *σπία*, Ecclus. xxii, 2; Luke xiv, 35). From Isa.

xxv, 10, we learn that the bulk of manure was increased by the addition of straw, which was, of course, as with us, left to rot in the dunghill. Some of the regulations connected with this use of dung we learn from the Talmud. The heaping up of a dunghill in a public place exposed the owner to the repair of any damage it might occasion, and any one was at liberty to take it away (*Baba Kama*, i, 8, 3). Another regulation forbade the accumulation of the dunghill to be removed in the seventh or sabbatic year to the vicinity of any ground under culture (*Shabb.* iii, 1), which was equivalent to an interdiction of the use of manure in that year; and this must have occasioned some increase of labor in the year ensuing. See AGRICULTURE. To sit on a dung-heap was a sign of the deepest dejection (1 Sam. ii, 8; Psa. cxlii, 7; Lam. iv, 5; comp. Job ii, 8, Sept. and Vulg.). We are informed by Plutarch (*De Superstitiōe*) that the Syrians were affected with a particular disease characterized by violent pains of the bones, ulcerations over the whole body, swelling of the feet and abdomen, and wasting of the liver. This malady was in general referred to the anger of the gods, but was supposed to be more especially inflicted by the Syrian goddess on those who had eaten some kinds of fish deemed sacred to her (Menander *apud* Porphyr.). In order to appease the offended divinity, the persons affected by this disorder were taught by the priests to put on sackcloth or old tattered garments, and to sit on a dunghill; or to roll themselves naked in the dirt as a sign of humiliation and contrition for their offence (Persius, *Sat.* v; Martial, *Epigr.* iv, 4). This will remind the reader of Job's conduct under his affliction, and that of other persons mentioned in Scripture as rolling themselves in the dust, etc. See DUST.

Dungal, a writer of the 9th century, of whose origin and history little is known, but who is supposed to have been of Scotch or Irish birth. According to Irish accounts, he was abbot of Glendolough, and after the destruction of his monastery by the Danes he fled to France. He calls himself "a recluse," and the *Hist. Litt. de la France* (iv, 498) notes him as a monk of the abbey of St. Denis, in France. Muratori, however (*Ret. Ital.* iv, 611), describes him as a monk of Pavia, in Italy. He wrote against the reforming movements of Claudius of Turin (q. v.), in 827, *Depravata contra perversas Claudii Taurinensis Episcopi sententias*, in which he defends the invocation of saints, the adoration of relics, etc., but seeks to guard these usages from superstitious abuse. The book was first published by Papirius Masson (Paris, 1608), and may be found in *Bibliotheca Max. Patrum* (Lyons), xiv, 16-238; also in Migne, *Patrologia Latina*, tom. 103. He was also celebrated as an astronomer.—Moore, *History of Ireland*; Wetzer u. Welte, *Kirchen-Lexikon*, iii, 53; Schröckh, *Kirchengeschichte*, xxiii, 414.

Dungeon (בֵּוֹר, *bor*, Gen. xl, 15; xli, 14, etc.) is often rendered; fully דַּבְּרוֹר הַבֵּוֹר, *house of the pit*, Exod. xii, 29; Jer. xxxvii, 16), is properly distinguished from the ordinary prison (שְׁבִיטָה or שְׁבִיטָה, also מַבְרָה or מַבְרָה as being more severe, and usually consisting of a deep *cell* or cistern (Jer. xxxvii, 6; hence the propriety of the Heb. word which indicates a *hole*), like the Roman inner prison (ἡ ἐσωτερικὴ φυλακή, Acts xvi, 24). Incarceration, a punishment so common in Egypt (Gen. xxxix, 20 sq.; xl, 8 sq.; xli, 10; xlii, 19), was also in use among the later Israelites (comp. Ezra vii, 26). But it is nowhere mentioned in the law, perhaps because among a people every man of whom was a landed proprietor, it was easily dispensed with, a fine being always easy to inflict; partly, too, because it seemed improper to take cultivators of the earth from their land for any length of time. (Other reasons are suggested by Michaelis, *Mos. Recht*, v, 45 sq.) Arrest is mentioned, indeed (Lev.

iv, 12), but not as a punishment. The guilty was aply kept in ward to await sentence (comp. 2 Chron. iii, 26; Wachsmuth, *Hellen. Alterth.* II, i, 186). So was a legal principle in Rome that a prison was to used only to keep men, not to punish them. Under the later kings imprisonment was used as a penalty, yet, as it seems, not by judicial sentence, but at the will of the sovereign, especially in the case of too unspoken prophets (2 Chron. xvi, 10; Jer. xx, 2; xii, 2 sq.; xxxiii, 1 sq.; xxxvii, 15). After the lle it became very customary (Matt. xi, 2; Luke iii, 1; John iii, 24), and was sometimes used to punish igious offences (Acts v, 18, 21; viii, 8; xii, 4; xxii, xxvi, 10), and in cases of debt (Matt. xviii, 80; mp. Arvieux, i, 411). The most ancient prisons were nply water-cisterns, out of which, since the sides me together above, one could not easily escape with- aid (Gen. xxxvii, 20, 22). Imprisonment in these s often made the more unpleasant by deep mud er. xxxviii, 6). There were at the gates, or in the uth-houses at the palaces of kings, or the houses of e commanders of the body-guard, who were the ex- utors of criminal sentences, especial state-prisons er. xx, 2; xxxii, 2; Gen. xxxix, 20 sq.; xl, 4; mp. Jer. xxxvii, 15, 20; Harmer, *Obs.* iii, 260 sq.). rison of the kind last named is called *prison-house* 'מִסְבֵּת הַשְּׂבִי' 2 Chron. xvi, 10). The prisoners er kept in chains (Judg. xvi, 21; 2 Sam. iii, 84; r. xl, 1). Under the Roman empire they were ained, by one or both hands, to the soldiers who atched them (Acts xii, 4; xxi, 33; Pliny, *Ep.* x, 65; neca, *Ep.* v, and *De tranquill. An.* x; Athen. v, 218; eoph. *Ant.* xviii, 6, 7), as is still the custom in Abyn- ia (Rüppell, *Abyss.* i, 218). Sometimes the Israelites ained them by the feet to a wooden block (Job xiii, 7; xxxiii, 11; Acts xvi, 24; comp. Wetstein in loc.; eob, *ad* Lucian. *Toxar.* p. 104), or by the neck (comp. ristophanes, *Clouds*, 592), or by the hands and feet at ce. Such severe imprisonment is to be understood Jer. xx, 2; xxix, 26, where our version has "in the ocks" (comp. Symmach. βασιανστήριον, στριβλωτή- ον; and the Greek κύβων, Schol. in Aristoph. *Phil.* 476). Poor and meagre fare seems to have added to e severity of the penalty (2 Chron. xviii, 26). An ample of lax state imprisonment appears in 1 Kings .87. Visits to prisoners are allowed with compara- e freedom in the East (Matt. xxv, 86; Jer. xxxii, 1; see Rosenmüller, *Morgenland*, v, 101). Roman pris- i discipline appears especially in the Acts of the postles. The keeper of the prison is called in Greek ομοφύλαξ (Acts xvi, 23; xxvii, 86), but once πρέ- ον (Luke xii, 58), and was armed (Acts xvi, 27). omp. ΠΡΑΚΤΟΡΙΟΥ. See in general A. Bombardini, e *carcere et antiquo ejus usu* (Padua, 1718).—Winer, 402. See PRISON.

Dung-gate; Dunghill; Dung-port. See UR- DUGA.

Du'ra (Chal. *Dura'*, נְרָבָה, *the circle*, i. q. Hebrew נְרָבָה, so the Sept. renders, τὸ περίβολον, but v. r. Δε- ρα; Vulg. *Dura*), the plain where Nebuchadnezzar t up his golden colossus to be adored (Dan. iii, 1). terpreters usually compare *Dura* to a city mention- l by Ammian. Marcell. (xxv, 6), situated near the Ti- ris (Mannert, v, 462); or another of the same name lepard) in Polybius (v, 48, 16) and Ammian. Marcell. (xiii, 5), on the Euphrates, near the mouth of the haboras, 7 miles from Carchemish; or, finally, one of similar name (Δερα) in Susiana (Ptol. vi, 8, 8). But ese quarters are all too distant from Babylon to have en historically possible, as it is clear from the con- act that "the plain of Dura" could be no other than at plain (or some part of it) in which Babylon itself as situated (Herod. i, 178), i. e. *Shinar* (Gen. xi, 2). ven against the first of these locations, the tract a kile below Tekrit, on the left bank of the Tigris (Lay-

ard, *Nin. and Bab.* p. 469), where the name *Dur* is still found, there are the following objections: (1) this tract probably never belonged to Babylon; (2) at any rate, it is too far from the capital to be the place where the image was set up, for the plain of Dura was in the province or district of Babylon (בְּמִדְיָנִי בָבֶל), and therefore in the vicinity of the city; (3) the name *Dur*, in its modern use, is applicable to any plain. M. Oppert places the plain (or, as he calls it, the "val- ley") of Dura to the south-east of Babylon, in the vi- cinity of the mound of *Dowair* or *Duaisir*. He has dis- covered on this site the pedestal of a colossal statue, and regards the modern name as a corruption of the ancient appellation. The Talmudical notice (*Sanhedr.* fol. 92, 2: מְנַחֵם אֵשֶׁל עַד רַבָּה בְּקֶצֶר דְּרוּרָא) is ob- scure (Buxtorf, *Lex. Talm.* col. 520). See Lakemach- er, *Observ. philol.* vii, 28 sq. See BABYLON.

Dunham, DARIUS, one of the pioneers of Episco- pal Methodism in Canada. He entered the itinerant ministry in 1788, and located in 1800. Mr. Dunham was a man of strong character, great practical ability, and abundant wit and satire. See Wakeley, *Heroes of Methodism* (N. Y. 12mo); Coles, *The Supernumerary* (N. Y. 18mo); Stevens, *Hist. of the Methodist Episcopal Church*, vol. iii, ch. vi.

Dunin, MARTIN VON, archbishop of Posen, was born Nov. 11, 1774, at Wat, near Rawa. He studied theology at Bromberg and at Rome, in the *Collegium Germanicum*, and was ordained priest in 1797. In 1829 he was made administrator of the archdiocese of Posen; as such he warned, in a pastoral of Dec. 8, 1830, the Polish members of the diocese against taking part in the Polish Revolution. On July 10, 1831, he was consecrated archbishop of Gnesen and Posen. In 1834 he reorganized the episcopal seminaries of those two cities. At the beginning of the year 1837 arch- bishop Dunin found his mind troubled by the devia- tions from the strict rules of the Church of Rome which had gradually come to be established in his dio- cese with regard to "mixed" marriages (between Ro- man Catholics and Protestants). He therefore asked the Prussian government to allow him either to pub- lish in his diocese the brief on the subject by pope Pius VIII, or to ask in Rome for new instructions, or to proceed according to the bull of pope Bene- dict XIV of the year 1748. All these requests were refused by the Prussian government, and Dunin therefore, on February 27, 1838, by a pastoral letter, forbade the clergy of his diocese, under penalty of sus- pension, to solemnize any mixed marriage at all. A royal rescript (*Cabinetorder*) demanded of him a re- call of this letter; and, when he declined this, a mi- nisterial rescript declared it null and void. Against the archbishop himself criminal proceedings were begun. Before the sentence was published, the king, in March, 1839, called him to Berlin to attempt a compromise. When it was found impossible to effect this, the arch- bishop was sentenced on April 25 to six months' im- prisonment in a Prussian fortress. The king pardoned him, and again summoned him to Berlin to make propo- sitions for a compromise; but when the archbishop suddenly, without informing the government, left Ber- lin on Oct. 4, he was rearrested on Oct. 6, and removed to the fortress of Colberg. There he remained until August, 1840, when the new king, Friedrich Wilhelm IV, desirous to end the conflict between the State and the Church of Rome, set him at liberty, after Dunin had signed certain declarations. He now instructed his clergy to desist from demanding any promises from persons about to conclude a "mixed" marriage, but also to refrain from anything that might imply an approval of such marriages. Another pastoral letter of February, 1842, provided that in the case of persons who, contrary to the provisions of the Church, had concluded a mixed marriage, the priests must, in each individual case, judge by the disposition of the parties

whether they might admit them to the sacraments or not. The archbishop died Dec. 26, 1842. See PAUSIA. A life of archbishop Dunin was published by F. Pohl (*Martin von Dunin*, Marienburg, 1848). The conflict of archbishop Dunin and of archbishop Droste (q. v.), of Cologne, with the Prussian government, is treated of in a special work by the Church historian K. Hase (*Die beiden Erzbischöfe*, Leips. 1839).—Herzog, *Real-Encycl.* iii, 549; Wetzlar und Walte, *Kirch.-Lex.* iii, 834.

Dunkers. See BAPTISTS (GERMAN).

Dunn, THOMAS, a Methodist Episcopal minister, was born in Virginia in 1774; while young emigrated to Ohio; entered the Ohio Conference in 1835, and died at Cincinnati in April, 1850. "In 1837 Mr. Dunn addressed a note to the *Western Christian Advocate*, in which he called attention to the condition of the Germans in this country, suggested the importance of a German press, and forwarded a subscription for that purpose." This was the first public movement towards the important work of German Methodism. He was "a good man, a fervid and persuasive preacher, a devoted pastor, a courteous gentleman, and a great peace-maker. His understanding was solid, his impulses generous, and his influence strong and sweet." He died April, 1850.—*Minutes of Conferences*, iv, 498; Thomson, *Biographical Sketches*, p. 176.

Duns Scotus, JOHANNES (*Doctor Subtilis*), one of the most eminent of the Scholastic theologians, was born, according to one account, about 1265, at Dunstons, near Alnwick, Northumberland; according to another, at Duns, or Dunse, in Berwickshire, Scotland. In fact, both the place and the date of his birth are unknown. At an early age he joined the Minorite Friars, and was sent by them to Oxford, where he became fellow of Merton College. In 1301 he was appointed to the theological chair in Oxford, which he filled with so great reputation that it is said more than 80,000 scholars came to Oxford to hear him. In 1304 he removed to Paris, where he was made doctor of theology, and soon rose to the head of the theological schools. He here distinguished himself especially by his advocacy of the immaculate conception (q. v.) of the Virgin Mary against Thomas Aquinas and the Dominicans. He influenced the University of Paris to adopt this heresy. In 1308 Duns Scotus was ordered by Gonsalvo, the general of the Minorites, to Cologne, to oppose the Beguines. On the road he was met in solemn pomp, and conducted into the town by the whole body of citizens. He died of an apoplexy at Cologne Nov. 8, 1308. Paul Jovius relates that, when he fell from apoplexy, he was immediately interred as dead; but that afterwards coming to his senses, he languished in a most miserable manner in his coffin, beating his head and hands against its sides till he died.

His philosophical views are thus stated by Tennemann: "His celebrated attack on the system of Thomas Aquinas drew this skilful reasoner very frequently into vain and idle distinctions, but in all his dialectic disputes he maintained a steady zeal for the promotion of real knowledge. He endeavored to ascertain some certain principle of knowledge, whether rational or empirical, and applied himself to demonstrate the truth and necessity of revelation. As a Realist, he differed from Thomas Aquinas by asserting that the universal is contained in the particular, not merely *in posse*, but *in actu*; that it is not created by the understanding, but communicated to it; and that the nature of things is determined in particular or universal by a higher or absolute principle. In Psychology he opposed the belief that the faculties of the soul are distinct. The object of Philosophy was, in his opinion, to become cognizant of the nature of things, or what is. Although human philosophy teaches the sufficiency of reason, and that supernatural disclosures

are superfluous, the theologian regards a certain prenatural revelation as necessary, because man can never attain to certain truth by inspecting effects or secondary causes, whether ideas or sensations. The object of theology is God, an infinite Being, and the first principle of all things. Yet he is not to be regarded in the light of his infinity, but of his finitude; the latter idea being more perfect than the former, because God cannot be conceived apart from ideas; though infinity can be conceived without God. He attributed indeterminate freedom to God, and hence regarded the subjective will of God as the principle of morality. Sometimes he expressed doubts as to the possibility of a rational theology. Duns Scotus was the founder of a school, the *Scotists*, who distinguished themselves for subtlety of disputation, and for incessant disputes with the *Thomists*. Their disputes were so frequently mixed up with human passions that science derived from them little benefit and it very frequently happened that the points in question, instead of being elucidated, were obscured through their controversies" (Tennemann, *Manual History of Philosophy*, § 268). See SCHOLASTIC.

As to the will, Duns Scotus maintained its freedom, without any *determinism*. In fact, "the leading distinction between the Thomist and the Scotist psychology respects the relation of thinking and willing, which, although they are found united, *scilicet*, in the soul, are really (*formaliter*) distinct, as well from each other as from the soul (*Op. Oxon.* ii, d. 16). The determinism of Thomas, according to which the will necessarily chooses what the thought presents to it as the best, Duns combats most emphatically. Not only the will has the power to determine itself entirely alone (*ibid.* d. 25), and, under certain circumstances, to act against the reason (*Disput. subtil.* 9 and 16), but in decided opposition to Thomas, it may be said to be in very many cases the reason is determined by its will, e. g. when I will to think. It is most judicious to distinguish two different modes of thinking—the first, which precedes the will; the second, which follows it; but even the former does not determine the will, for *voluntas est superior intellectus* (*Op. Oxon.* i, d. 42, qu. 4). With Duns the will is entirely identical with *liberum arbitrium*; what it does is *contingens* and *evitable*, while the intellect obeys necessity (*Op. Oxon.* ii, d. 25). The function of the latter is to furnish to the will the material which it combines, the possibility being given to it of willing entire opposites" (*Op. Oxon.* i, *dist.* 39)" (Erdmann, translated by Stueber, *Amer. Presb. Review*, April, 1866, p. 299).

On the *Theology of Scotus*, we take the following from Erdmann's article just cited: "The peculiarities of Duns's psychology, as well as his deviations therefrom, from Thomas, reflect themselves in the manner in which he views the essence of God and the destiny of man, and, therefore, in his theology and ethics. As to his theology: since the existence of God might be known without supernatural illumination, there is, therefore, *ex parvis naturalibus*, a knowledge of the divine essence. But just as the former could not be proved *à priori*, the latter also cannot be derived from the highest metaphysical idea of the *ens* (*Theorem.* 11), but we raise ourselves to it by proceeding from the *vestigium* and the *imago* of God. Our knowledge of the essence of God is therefore not intuitive, but abstractive (*Rep. Paris.* Prol. qu. 2). The distinction is the human soul between the *intellectus*, whose essence is the memory and the will, must, and that *essentia* be found in the original ground of man, in God. Accordingly, in God, understanding and will must be distinguished, of which the former acts *naturaliter*, the latter *libere*; the former is the ground and sum of all necessity, the latter of all contingency, and therefore may be named the possibility of the contingent in fact (*Rep. Paris.* ii, d. i, qu. 8; *ibid.* i, d. 40). Inasmuch as, now, as these two determinations (*Bestimmungen*);"

foundation of Duns's doctrine of the Trinity, since Son, as *Verbum*, has his ground in the *memoria facta*, the Holy Ghost, on the other hand, in the ratio operated through the will (*Rep. Paris. i, d. 13*; *Oxon. i, d. 10* et al.), he does not hesitate to ascribe to the natural man such capacity as that he may owe the Trinity (*Quodl. qu. 14*). These intra-divine relations (*notionalia*) through which the three persons are the first deductions resulting from the essence of God, and are therefore to be derived from the own *essentialibus* (*ibid. qu. 1*). The case is otherwise with every relation of *God ad extra*. For, since out of God proceeds from the divine will, and this act *contingenter* (*Op. Oxon. i, d. 89*), it can by means be proved that anything out of God must exist, and that it must exist as it is. Truly his own being does God know and will of necessity; all else is *ly secundario volitum* (*Rep. Paris. i, d. 17*). That God might have created all things other than he has, that he might do all things otherwise than he does, cannot be proved a logical impossibility, an *impossibilitas contrariorum*; we can therefore only say, in the course of the established order chosen by God, that this will or will not happen (*Rep. Paris. iv, d. 49*, *xi*). Such an established order, limits which God is voluntarily fixed for himself, is postulated by us, because he distinguishes creation and preservation, i. e. bringing out of nothing into being, and out of being into being, as two essentially distinct relations of God to things, or, rather, of things (*Quodl. qu. 2*) to God. (*Op. Oxon. i, d. 80 qu. 2*.) But it must never be forgotten that the ground why this particular order was established is to be found purely in the pleasure of God. Therefore, although it is true that God has created all things according to ideas which preceded the things in his intelligence, yet these archetypal forms have by no means determined his creating; as of all has he chosen any one form because it was the better. Rather it is only the better for the very reason that God has chosen it (*Op. Oxon. ii, d. 19*). Here is, therefore, a scientific knowledge of the Trinity; of the creation there is none. It is with the incarnation precisely as it is with the creation. Had God willed, we might have become stone; there is no more impossibility in that than there was in his becoming man. Precisely the same is true of redemption through the death of Christ. A proof of the necessity of this is not possible. It is simply the pleasure of God that the death of the guiltless one should become the ransom for the guilty (*Op. Oxon. iii, d. 7, u. 1*; *d. 20*; *iv, d. 16*). (Around this point revolve the controversies of the Scotists and Thomists respecting the merits of Christ.) Precisely as it must be said of these dogmas that they are certain, not through scientific proofs, but through the *fides infusa* (*ibid. d. 24*), even so must we say of the moral commandments which are given us. It is not because it is evil that God has forbidden us this or that, but it is evil because God has forbidden it. Had he commanded murder or other transgressions, they would have been no transgressions and no sin (*ibid. d. 87*). The last adduced principle forms a convenient transition to his *ethics*. Whoever, like Thomas, lays the greater stress on the heretical side of the soul, must, with Aristotle, put theory above practice, and with such a one, if the Christian idea of blessedness be added, it must assume a peculiar form. Here, therefore, blessedness is conceived as the knowing and beholding of God, as *delectatio* in God, and therefore, as a *theoretic* enjoyment. With Duns, who allows to the will precedence over the thinking power, the matter must naturally take another form. The authority of Aristotle alarms him not; it is, in his view, only the philosopher, with his temporal blessedness, who is opposed to him, when he himself maintains, as the Christian and theological view, that love, therefore the will, confers the highest blessedness, so that it seems to him almost too quiet-

tistic to call it *delectatio* (*Rep. Paris. iv, d. 49, qu. 1* and *2*). How he disposes of the Biblical authority, according to which eternal life consists in knowing God, has been mentioned above. As, through his stronger emphasizing of the will, he separates himself from Aristotle's deification of theory, naturally with him the Augustinian will-lessness must disappear. Duns is a decided synergist. To be sure, the will is not sufficient for salvation; it needs to be assisted through the infusion of the theological virtue of *caritas* (*ibid. qu. 10*); but it must be remembered also that Christ only names himself the Door, but the door does not render entrance superfluous. Entrance requires the co-operation of man (*Op. Oxon. iii, d. 19*). He does not scruple, therefore, to name the appropriation of salvation through faith a merit which will be rewarded. It is no contradiction to say that when God shows himself compassionate only, he, when just, also decides the act of man (*Rep. Paris. iv, d. 46*).

"The admirers of Scotus extol his acuteness and subtlety as unrivalled, and he has always been accounted the chief glory of the Franciscans, as Thomas Aquinas has been of their rivals, the Dominicans. If in his short life he actually wrote all the works that are commonly attributed to him, his industry at least must have been prodigious. His fame during his lifetime, and long after his death, was not exceeded by that of any other of the Scholastic doctors. From him and Aquinas two opposing sects in theology took the names of Scotists and Thomists, and divided the schools down almost to the last age. The leading tenet of the Scotists was the immaculate conception of the Virgin, and they also differed from the Thomists on the subjects of free-will and the efficacy of divine grace. In philosophy the Scotists are opposed to the Occamists, or followers of William Occam, who was himself a pupil of Scotus, but differed from his master on the subject of universals, or general terms, which the Scotists maintained to be expressive of real existence, while the Occamists held them to be nothing more than names. Hence the Scotists are called Realists, the Occamists Nominalists. It is a favorite opinion of Bayle's that this doctrine of the Scotists was nothing less than an undeveloped Spinozism (*Dict. Crit. art. Abelard, note C, and André Cispalin, note B*). It may be added that the English term 'dunce' has been commonly considered to be derived from the name of the subtle doctor—'perhaps,' says Johnson, 'a word of reproach first used by the Thomists, from Duns Scotus, their antagonist'" (*English Cyclopædia, s. v.*)

The collected works of Duns Scotus first appeared at Lyons under the title of *Joannis Duns Scoti Opera omnia quæ hucusque reperiri potuerunt collecta, etc.*, edited by the Irish Minorite, Wadding (Lugd. 1689, 12 vols. fol.). It does not contain all the works of Scotus, but only those designated as his *Opera Speculativa*: the contents are, vol. I, *Wadding Vita Scoti, with Grammatica speculativa; In universam logicam Questiones*; vol. II, *Comment. in libros Physic. Aristotelis; Questiones in libros Aristotelis De Anima*; vol. III, *Tractatus de Rerum Principio; Tractatus de primo Principio; Theoremata subtilissimæ; De Cognitione Dei*; vol. IV, *Expositio in Metaphysicam Aristotelis; Conclusiones Metaphysicæ; Questiones in Metaphysicam*; vols. V, VI, VII, VIII, IX, X, *Distinctiones in quatuor libros Sententiarum*; vol. XI, *Reportariorum Parisiensium Libri IV*; vol. XII, *Questiones quodlibetales. The Commentarii Sacr. Script.* were to be given in a later publication by the same editor, which never appeared. Wadding's *Vita Joannis Duns Scoti* was reprinted at Mons (1644, 12mo). There is also a *Tractatus de Joannis Scoti Vita, etc.*, Auctore R. F. Joanne Colgano, *Ord. Minor.* (Antw. 1655, 12mo). A summary of his theology is given in Albergoni, *Resolutio Doctrinæ Scoticæ* (Lugd. 1648, 8vo). Baumgarten-Crusius wrote a treatise on his theological system (*De Theologia Scoti*, Jena, 1826, 4to). See also Neander, *History of Dogmas* (Bohn's ed.), II,

544-590; Hagenbach, *History of Doctrines* (Smith's ed.), i, 396 et al.; Hoefst, *Nouv. Biog. Générale*, xv, 250; *Christian Examiner* (Boston), 1849, art. i; *N. Brit. Rev.* May, 1855, art. iii; Mosheim, *Church Hist.* bk. iii, c. xiv, pt. ii, ch. ii, § 88; Haureau, *Philosophie Scolastique*, ch. xxv; Brucker, *Historia Critica*, t. iii, p. 825; Erdmann (translated in *Amer. Presbyt. Review*, April, 1865, cited above).

Dunstan, archbishop of Canterbury, monk and statesman, was born at Glastonbury A.D. 925. He early entered into holy orders, and by means of his relative, archbishop Athelm, was introduced at court, where he acquired great influence over the kings Athelstan and Edmund. He was afterwards, however, persecuted on account of his independent spirit, and an austerity which had excited the anger of king Edwin and of Ethelred. He was exiled for some time in Flanders, but was, on his return, made bishop of London, and finally archbishop of Canterbury in 961. He died May 19, 988. He was canonized as a saint, and is commemorated on the 19th of May. He was well versed in the arts and sciences. The *Congregation of Benedictines of St. Dunstan*, which he founded, spread rapidly after 957. Writers differ greatly in their estimates of Dunstan's character. It is clear, however, that he was "a man of extraordinary talents, of great energy, stern self-will, and unscrupulous purpose; and that he exerted all his talents, energy, and unscrupulousness to advance the ecclesiastical power, and to subject all to papal supremacy. The grand designs of his life, viz. the complete subjugation and conformity of the Anglo-Saxon Church to that of Rome, and the extension and multiplication of ecclesiastical interests, are not such as excite the admiration of modern times, and all discerning people will regret the success that attended the unpatriotic labors of the saint. That he was successful there can be no manner of doubt. Though personally out of favor at court in the latter years of his life, his efforts to spread his official influence were unceasing. At an early period in his career he had introduced a new order of monks into the land, the Benedictines, whose strict discipline had changed the character and condition of ecclesiastical affairs, and in spite of the confusion and even opposition thus caused, he persevered to the end. Monasteries continued to be founded or endowed in every part of the kingdom; and such were the multitudes who devoted themselves to the cloister, that the foreboding of the wise Bede was at length accomplished—above a third of the property of the land was in possession of the Church, and exempted from taxes and military service" (Chambers, *Encyclop.* s. v.). See *Acta Sanctorum* (May 19); Hume, *Hist. of England* (10th cent.); Churton, *Early English Church*; Southey, *Book of the Church*, p. 67 sq.; Smith, *Relig. of Ancient Britain*, p. 436 sq.; Turner, *Hist. Anglo-Saxons*, vol. ii; Wright, *Biographia Literaria, Anglo-Saxon Period*, p. 443 sq.; Wharton, *Anglia Sacra*, tom. ii.

Dunster, HENRY, a Congregational minister, the place and date of whose birth are unknown. He was a native of England, and was a student at Emanuel College, Cambridge, where he became B.A. 1630, and M.A. 1634. He fled to New England on account of his non-conformity in 1640, and was appointed president of Harvard, being the first master of the college called president, Aug. 27, 1640. He filled the chair until 1654, when he resigned on account of his views in regard to infant baptism. He spent the remainder of his life in the ministry at Scituate, where he died Feb. 27, 1659.—Sprague, *Annals*, i, 125.

Dunton, JOHN, a bookseller and miscellaneous writer, was born at Graffham, Huntingdonshire, in 1659. After being in business some twenty years as a bookseller, he failed, and then devoted himself to authorship. He died in 1738. His principal works are, *The Devil's Martyrs*; to which is added the High-

Church Martyrology (Lond. 1716, 8vo).—*Admissionacle, and young Student's Library* (Lond. 1784, 4to, 8vo).—*The Hazard of a Death-bed Repentance* (Lond. 1780, 8vo), etc.—Darling, *Cyclopaedia Bibliographica*.

Dunwoody, SAMUEL, a minister of the Methodist Episcopal Church, was born in Chester County, Aug. 3, 1780. In 1806 he entered the itinerant ministry in the South Carolina Conference, and in 1811 he organized the first Methodist Church in Savannah, Ga. In 1812 he was made presiding elder of the Mississippi District, and was elected to the General Conference, in which body he served also at the session of 1844, at which the Church was divided on the slavery question. In 1846 he was made superintendent, and died July 8, 1854. He was a very successful preacher, and one of the founders of Methodism in the Southern States.—Deems, *Annals of Southern Methodism*, 154, p. 352; Sprague, *Annals*, vii, 435.

DUPERRON, JACQUES DAVY, a French cardinal, was born of Protestant parents at St. L , Normandy, Nov. 15, 1556. His father was a Protestant minister, and was compelled during the persecutions to take refuge in Switzerland, where the son was carefully educated. In 1576 he was presented at the court of France, where Henry III gave him an office. Fearing that the Roman Church would open to him a more brilliant career, he joined it, and took priest's orders, devoting himself to polemics and to preaching. He took an active part in the conversion of Henry IV, and, in co-operation with cardinal D'Osset, secured from the Pope absolution for the king in 1595. On this occasion he was made bishop of Evreux by the Pope at the suggestion of the king. He also secured the divorce of Henry from Margaret of Valois, against his most formidable opponents was Du Plessis (q. v.). In 1604 he was made cardinal, two years after grand almoner of France, and finally archbishop of Bourges. He was also a member of the *Congregatio de studiis* (q. v.), and suggested the decision of Clement VII on the subject. He died at Paris Sept. 5, 1617. His works were published a few years afterwards (Paris 1620-22, 8 vols. fol.). The first volume contains his *Traiti sur l'Eucharistie* against Du Plessis; and the collection contains a number of poems. See *Dict. Ecclesiastical Writers*, cent. xvii; *Hoefst, Nouv. Biog. G n rale*, xv, 286; *Wetzer u. Welte, Kirch.-Lex.* iii, 39.

Dupin, LOUIS ELLIES, a learned doctor of the Sorbonne, eminent as an ecclesiastical historian, was born at Paris June 17, 1657. In 1684 he became doctor of the Sorbonne, and was afterwards lecturer in moral philosophy, and devoted his life chiefly to the study of ecclesiastical history and literature. He died at Paris June 6, 1719.

Dupin rendered himself conspicuous as an opponent of the bull *Unigenitus*, and by his moderation gained the friendship of several Protestant divines, such as archbishop Wake. It is especially as the historian of ecclesiastical literature that Dupin has rendered valuable service to theology. He had an unusual talent for analyzing the works of an author; he gives not only a history of the writers, but also the substance of what they wrote, in his *Biblioth que des auteurs eccl siastiques contenant l'histoire de la vie, des ouvrages, la critique et la chronologie de leurs ouvrages* (Paris, 1688 (47 vols. 8vo); reprinted at Amsterdam (19 vols. 4to); translated into English under the title *A new History of Ecclesiastical Writers*, etc., including the 17th century (Lond. 1698-1707, 17 vols. fol., 1707 in 7). There is a Dublin edition without the 17th century (1722-24, 8 vols. fol.). No theological library is complete without Dupin, although many of his comments must be corrected by the additional light of modern research has thrown upon Church history. The freedom and general impartiality of Dupin's views brought upon him attacks from the Benedictine

l from Bossuet, with whom he maintained a very successful controversy.

Dupin was also brought into trouble by the celebrated Case of Conscience. This Case of Conscience is a paper signed by forty doctors of the Sorbonne in 1702, which allows latitude of opinion with respect to the sentiments of the Jansenists. It occasioned a great controversy, and most of those who signed it were censured or punished. Dupin was not only deprived of his professorship, but banished to Chatelleuil. At length, by the interest of friends, he was permitted to return; but his professorship was not restored. Clement XI sent formal thanks to Louis XIV bestowing this chastisement upon Dupin; and in a brief which he addressed to the king on that occasion, characterized him as 'a man who held very pernicious opinions, and who had been guilty of a criminal opposition to the proper authority of the apostolical See.'

Dupin afterwards met with trouble under the agency on account of the correspondence which he carried on with Dr. Wake, archbishop of Canterbury, which was for its object the formation of a union between the Church of England and the Church of France. He drew up a *Commonitorium*, and discussed in it the thirty-nine Articles. He insisted on the necessity of uniformity, on the infallibility of the Church in faith and morals, and contended that the sacrifice of the Mass was not a simple sacrament, but a continuation of the sacrifice of the cross. The word transubstantiation he seemed willing to give up if the Roman Catholic doctrine, intended to be expressed by it, were retained. He proposed that communion under both kinds, or under bread alone, should be left to the discretion of the different churches, and consented that monks in holy orders should retain their state, with such provisions as would place the validity of their vows beyond exception. The marriage of priests in those countries in which such marriages were allowed, and the recitation of the divine service in the vulgar tongue, he allowed; and intimated that no difficulty would be found in the ultimate settlement of the doctrine respecting purgatory, indulgences, the veneration of saints, relics, or images. He seems to have thought that the pope can exercise no immediate jurisdiction within the dioceses of bishops, and that primacy invested him with no more than a general supervision of the deposit of the faith, a right to enforce the observance of the sacred canons, and the general maintenance of discipline. He allowed, in general terms, that there was little substantially wrong in the discipline of the Church of England; he deprecates all discussion on the original merit of reformations, and he professed to see no use in the pope's intervention till the basis of the negotiation should be settled (Hook, *Eccles. Biography*, iv, 512 sq.). The correspondence is given in Maclaine's 8d Appendix to his translation of Mosheim, *Ecclesiastical History*.

Besides his great work on *Ecclesiastical Writers*, Dupin published *De antiqua Ecclesie Disciplina* (Paris, 6, 4to);—*Liber Psalmorum, cum notis* (Paris, 1691, 8vo);—*Le Livre des Psaumes, traduit selon l'Hebreu* (Paris, 1, 12mo);—*S. Optati Aferi Milevitani episcopi, De unitate Donatistarum, cum notis* (Paris, 1700, fol.);—*De Pentateuchum* (Paris, 1701, 8vo);—*La juste déduction du sieur Dupin* (Cologne, 1698, 12mo);—*Défense la censure de la Faculté de théologie de Paris contre Mémoires de la Chine* [du P. Lecomte jésuite] (Paris, 1, 8vo);—*De la Nécessité de la Foi en Jésus Christ tirée de sa vie* (Paris, 1701, 8vo);—*Dialogues posthumes du sieur de La Bruyère sur le quatrième* (Paris, 1699, 8vo);—*Traité de la Doctrine chrétienne et orthodoxe* (Paris, 1708, 8vo);—*Joannis Gersonii, doctoris et canonicus Parisiensis, Opera* (Amst. 1708, 5 vols. fol.);—*Histoire d'Apollone de Tyane convaincu de fausseté et d'imposture* (Paris, 1705, 12mo);—*Traité de la puissance ecclésiastique et temporelle* (Paris, 1707, 8vo);—*Bibliothèque universelle des Historiens* (Paris, 1707,

8vo);—*Lettre sur l'ancienne Discipline de l'Eglise touchant la célébration de la Messe* (Paris, 1708, 12mo);—*Histoire des Juifs depuis Jésus-Christ jusqu'à présent* (Paris, 1710, 12mo);—*Dissertations historiques, chronologiques, et critiques sur la Bible* (Paris, 1711, 8vo);—*L'Histoire de l'Eglise en abrégé* (Paris, 1712, 12mo);—*Histoire profane, depuis son commencement jusqu'à présent* (Paris, 6 vols. 12mo);—*Analyse de l'Apocalypse, contenant une nouvelle explication simple et littérale de ce livre, avec des dissertations sur les Millénaires* (Paris, 1714, 12mo);—*Traité historique des excommunications* (Paris, 1715, 12mo);—*Méthode pour étudier la théologie* (Paris, 1716, 12mo);—*Défense de la Monarchie de Sicile contre les entreprises de la cour de Rome* (Amsterdam, 1716, 12mo);—*Traité philosophique et théologique sur l'amour de Dieu* (Paris, 1717, 12mo);—*Bibliothèque des Auteurs séparés de la communion romaine du sixième et du dix-septième siècle* (Paris, 1718, 8vo).

Du Plessis-Mornay (PHILIPPE DE MORNAY), a statesman and controvertist, and one of the most eminent French Protestants in the latter part of the 16th century, was born at Buhy, Nov. 5, 1549. His father, James de Mornay, was a zealous Roman Catholic, but his mother, who inclined to the Protestant doctrines, gave her son a tutor who held the same views. His father, to counteract this influence, sent him in 1557 to the college of Lisieux, but died in 1559. Philip was now called home to his mother, who had openly embraced the cause of the Reformation. After completing his studies, he visited Italy and Germany from 1565 to 1572. On his return he addressed a memoir to admiral Coligny on the state of the Netherlands, and the expediency of a French expedition in that country. Coligny, struck by the memoir, contemplated sending the author on a mission to the prince of Orange, but in the massacre of St. Bartholomew, in August, 1572, the admiral was murdered. Mornay, saved by a Roman Catholic, fled to England, where he was well received. He, however, returned to France in the following year, and took an active part in the efforts made by the Protestants to strengthen their cause by connecting it with that of the duke of Alençon. At Sedan he married Charlotte Arbalette de Feuquières, Jan. 8, 1576, and attached himself to the king of Navarre, who sent him on divers missions to England and Flanders. After his return to France (1582) he took part in the national synod of Vitry, where he proposed a general union of the Protestant churches of France, which proved unsuccessful, but yet greatly increased his consideration among the French Protestants. "From that time until his master ascended the throne of France," say Messrs. Haag, "Mornay was the chief man in his councils; he rendered him important services as a skillful warrior, a good administrator, a deep politician, and an indefatigable writer. If there was help to be asked from Protestant nations, or explanations to be given to foreign princes of the sometimes doubtful conduct of Henry, it was Mornay who drew up the instructions of the envoys when he was not sent himself. When churches had to complain of the non-execution of edicts, it was Mornay who had to draw up the account of their grievances. In short, nothing was done without him." One of his most important acts was his bringing about, in 1589, a reconciliation between Henry III and the king of Navarre. He was rewarded for this service by being appointed governor of Saumur. A short time after, Henry III was assassinated. Mornay then joined the king at Tours, and fought valiantly at Ivry. Henry appointed him one of his councillors, but, as he foresaw that he would be obliged to become a Romanist, the zeal of Mornay for Protestantism was now troublesome to him. He still used him, however, as his chief agent with the Protestants and with the foreign powers. Mornay thought this a favorable time to renew his attempts at conciliating the different Protestant churches among themselves, and even with

the Roman Catholics, by means of reciprocal concessions discussed and accepted in a sort of grand council. Henry IV seemed to approve of this plan, and even advised Mornay to consult with the most learned Protestant ministers. But, while the zealous Protestant was calling even the English theologians to his aid in the coming council, Chiverny, the chancellor of Henry IV, wrote to the bishop of Chartres "to come on, only without worrying about theology." Mornay saw now, but too late, that he had been duped, and that the abjuration would take place regardless of any discussion, yet he did not refuse being the mediator between the king and the envoys of the churches. But he insisted on the edict of Nantes (1598), which gave securities to the Protestants, and prepared the way for the edict of Nantes. Mornay had no part in framing the latter, but he carefully watched over its execution. Notwithstanding the coolness with which Henry IV treated him during the later years of his reign, he sincerely mourned the king's death, as he foresaw that persecution would soon break forth again. Under Louis XIV he attempted to soften the strict measures proposed against the Protestants, and was on that account deprived of his governorship in 1621. He died in 1623, at Laforêt-sur-Sèvre, in Poitou. He wrote: *Discours de la Vie et de la Mort* (Lausanne, 1586, 8vo); *Remonstrances aux Etats de Blois pour la paix* (Lyon, 1578, 12mo); *Traité de l'Eglise, où l'on traite des principales questions qui ont été mises sur ce point en nostre temps* (Lond. 1578, 8vo); *Traité de la vérité de la religion chrétienne, contre les athées, épicuriens, payens, juifs, mahomédistes et autres infidèles* (Anvers, 1581, 4to; several times reprinted, last edition 1617); *Advertissement sur la réception et publication du concile de Trêves* (Paris, 1588); *Déclaration du roi de Navarre sur les calomnies publiées contre lui* (Orthez, 1585, 8vo); *Lettre d'un gentilhomme catholique françois, contenant brève réponse aux calomnies d'un certain prétendu anglois* (1588, 8vo); *Déclaration du roi de Navarre au passage de la Loire* (1589, 8vo); *De l'Institution, Usage et Doctrine du saint sacrement de l'Eucharistie en l'Eglise ancienne, comment, quand, et par quels degres la messe s'est introduite en sa place, en six livres* (La Rochelle, 1598, 4to); *Response à l'examen du docteur Bulenger, par laquelle sont justifiées les allegations par lui prétendues fausses et vérifiées les calomnies contre la préface du livre De la sainte Eucharistie* (La Rochelle, 1599, 4to); *Vérification des lieux impregnez de faux, tant en la préface qu'aux livres De l'Institution de la sainte Eucharistie par le sieur Dupuy* (La Rochelle, 1600, 8vo); *Sommaison du sieur Duplessis-Mornay à M. l'Evêque d'Evreux, sur la sommaison à lui faite prièvement* (1600, 8vo); *Discours véritable de la conférence tenue à Fontainebleau, le 4 may 1600, où sont traitées les principales matières controversées* (Saumur, 1612, 4to); *Discours et méditations chrétiennes* (Saumur, 1619, 2 vols. 12mo; 3d vol. 1624, 8vo); *Le mystère d'iniquité, c'est-à-dire l'Histoire de la papauté, par quels progrès elle est montée à ce comble, et quelles oppositions les gens de bien lui ont fait de temps en temps. Or aussi sont défendus les droicts des empereurs, rois et princes chrétiens, contre les assertions des cardinaux Bellarmin et Baronius* (Saumur, 1611, fol.); *Testament, Codiçile et dernières heures de P. de Mornay, auxquelles a été joint son Traité de la Vie et de la Mort, ses larmes sur la mort de son fils unique, et le discours de la mort de Dame Charlotte Arbaletie, son épouse* (La Forest, 1624, 8vo); *La Haye, 1656, 8vo*; *Mémoires de Messire Philippe de Mornay, seigneur du Plessis-Marlé, etc.* (vols. i and ii, La Forest, 1624, 1625, 4to; vols. iii and iv, Amsterdam, 1652, 4to). These *Mémoires* were reprinted, with some additions, under the title *Mémoires, Correspondances et Vie de Duplessis-Mornay, etc.*, par M.M. de La Fontenelle, de Vaudoré et Auguis (Paris, 1624-1625, 12 vols. 8vo).

See Mornay de la Villetterte, *Vies de plusieurs anciens seigneurs de la maison de Mornay* (1699, 4to); Crusius, *Singularia Plessica, seu memorabilia de vita,*

meritis, factis, controversiis et morte Phil. Mornay à Paris, etc. (Hamb. 1724, 8vo); Sismondi, *Hist. de France*, vol. xix-xxii; Henry Martin, *Hist. de France*, ix and x; H. Duval, *Éloge de Phil. Duplessis-Mornay* (Paris, 1809, 8vo); J. Imbert, *Duplessis-Mornay* (Paris, 1847, 8vo); Garrison, *Revue des Deux Mondes*, Feb. 1848; Haag, *La France Protestante*; Eugène Paris, *Revue d'Anjou*, 1855; Hoefer, *Nov. Biog. Pars* xxxvi, 617; Herzog, *Real-Encyclopædie*, iii, 66.

DUPPA, BRIAN, bishop of Winchester, was born in 1588 at Lewinham, in Kent, and was educated at Westminster and Christ Church. He was elected dean of All Soul's in 1612, and in 1629 he was appointed dean of Christ Church. In 1634 he was elected chancellor of the church of Sarum, and soon after made chaplain to Charles I. In 1638 he was elected to the bishopric of Chichester, and in 1641 translated to the see of Salisbury. At the Revolution he repaired to the king at Oxford, and, after that he was surrendered, attended him in other places, particularly during his imprisonment in the Isle of Wight. He was a great favorite with Charles. When the Restoration took place, Dr. Duppa was translated the bishopric of Winchester, and was also made almoner. He died at Richmond in 1662. On his death king Charles visited him, and, kneeling by the bedside, begged his blessing, which the king took with one hand on his majesty's head and the other to heaven, gave with fervent zeal. He wrote: *Soul's Soliloquy, and Conference with Conscience* (1640);—*Angels rejoicing for Sinners repenting a year on Lake xv, 10* (1648, 4to);—*A Guide for the Poor* (1660, 8vo).—*New Gen. Biog. Dictionary*, v, 5; Neal, *History of the Puritans* (Harper's edit.), i, 7; Kippis, *Biog. Britannica*, v, 514.

DURÆUS. See DURY.

DURAN, the name of a family originally of Provence, afterwards settlers in Spain, and afterwards in Algiers, which produced several men who were regarded as ornaments to Rabbinical learning. SAMUEL DURAN, 1891, wrote a *Commentary on Job*, with an introduction on the principles upon which it should be expounded (Ven. 1590); and SALOMON, who distinguished himself as a zealous apologist for Judaism. His brother ZEMACH is the author of a bold epistle, Shealoth vateshuvoth, on various subjects of Talmudic law and metaphysical philosophy (Ven. 1782), and of several other Rabbinical works.—RIDGE, *Introd. to Hebrew Literature* (Lond. 1856), p. 1.

DURAND, DAVID, a French Protestant divine, born in 1681 at St. Pargoire, in Languedoc. He entered the ministry at Basle in 1708; afterwards he went to Holland, and became chaplain of a regiment of refugees. Being taken prisoner, he narrowly escaped death, and was subsequently in equal danger from the Inquisition in Spain. He escaped, however, through the influence of the duke of Berwick, and in 1714 became preacher to the Savoy, in London; in this office he died in London, Jan. 16, 1763. He wrote many books, among which are *Sermons sur divers sujets* (Lond. 1728, 8vo); *La Religion des Mahométans* (Lond. 1728, 8vo); *La Religion des Mahométans*, par M. de Reland (La Haye, 1721, 12mo); *La Vie de Jacobinini* (Rott. 1717, 12mo).—Haag, *La France Protestante*, vol. iv.

DURAND, FRANÇOIS JACQUES, a French Protestant minister, was born at Semalé, near Alençon, in 1727, of a Roman Catholic family. As soon as he completed his preparatory studies at Paris, he applied himself to the study of theology, and returned in 1775 to Lausanne to embrace the Reformed religion. He was licensed to preach in January, and soon acquired an enviable reputation as preacher. In 1768 Durand was appointed director of the seminary at Berne and pastor of the French church at that place. At the same time he continued to be engaged in ecclesiastical history, statistics, civil history,

Christian morals at Lausanne, where he died, April, 116. Besides a number of miscellaneous works, Durand published *L'Esprit de Saurin, ouvrage utile à toutes les familles chrétiennes* (Lausanne, 1767, 2 vols. 8mo).—*Sermons sur les solennités chrétiennes* (Lausanne, 1767, 8 vols. 8vo; Avignon and Paris, 1776).—*Année évangélique, ou sermons pour tous les dimanches et fêtes de l'année* (Lausanne, 1780, 7 vols. 8vo; and 10th Supplement, Lausanne, 1792, 2 vols. 8vo). A sketch of his life, with certain *Sermons nouveaux*, by Durand Delille, appeared at Valence (1805, 2 vols. 8mo).—Hofer, *Nov. Biog. Générale*, xv, 423.

Durand or Duranti (DURANDUS or DURANTUS), hullaume, surnamed *Speculator*, was born about A. D. 1230 at Puimisson, in France. Studying at Bologna and Modena, he became a learned ritualist, and great favorite of popes Clement IV and Gregory X. He was appointed by the latter pope legate to the Council of Lyons in 1274, and bishop of Mende in 1287. He died in Rome Nov. 1, 1296. His principal works are *Speculum juris* (Strasbourg, 1475, 4 parts, and many editions later).—*Rationale divinarum officiorum* Mayence, 1459, fol.; Angsb. 1470, fol.; Rome, 1478, 477, fol.; Ulm, 1478, 1475, fol.). The first book of the *rationale* has been translated, under the title *The Symbolism of Churches and Church Ornaments*, by J. M. Neale and B. Webb (Leeds, 1848, 12mo).

Durand, De Saint-Pourçain (DURANDUS à SAINT-PORCIANO), one of the most eminent of the later scholastic divines, was born at Saint-Pourçain, Auvergne, about 1280. From early years a member of the Dominican order, he was made doctor in 1318. His great abilities were soon manifest. John XXII called him to Rome, and appointed him master of the palace. In 1318 Durand recrossed the mountains, and accepted the bishopric of Puy-en-Velay. He became bishop of Meaux in 1326, and died in 1382. He is known among the great scholastics by the distinctive title *Doctor Resolutionis*. His principal writings are, *In Sententias Lombardi commentariorum libri xv* (Lugd. 1569; Venice, 1586, fol.).—*De Origine Jurisdictionis, sive de jurisdictione ecclesiastica et de legibus* (Paris, 1564, 4to).—*Statuta synodi diocesis Ancienensis*, in a work of P. Gisey entitled *Discours historiques de la dévotion à N. D. du-Puy* (Lyon, 1620, 8vo).

In philosophy and theology Durand was naturally a Thomist, but the course of his studies led him far away from the ground of Aquinas. He was a thorough Nominalist in philosophy. See NOMINALISM. He held theology to be a practical science, the object of which is, not the knowledge of God, but the life of faith. He pronounced the scientific knowledge of God to be beyond the reach of the human mind. Our knowledge of God rests on faith, and faith on the authority of the Church. Nevertheless, in his *Comment. in Sentent. Lombardi* (i, dist. 8, qu. 1, cited by Hagenbach, *History of Doctrines*, § 164), he speaks of a threefold way which leads to the knowledge of God: 1. *Via eminentiæ*, which ascends from the excellencies of creatures to the idea of the highest excellency, i. e. to the perfect God. 2. *Via causalitatis*, which ascends from the phenomena of creation to the first cause. 3. *Via remotiōnis*, which begins with changeable and dependent existence, and ends with necessary and absolute existence (*esse de se*). This is apparently in contradiction to his fundamental principle; but he clears it up by declaring that it is not the nature of God which is thus demonstrable, but his relation to the external world which can be thus demonstrated. It will be seen that the question of the relativity of knowledge is here involved; and that Sir W. Hamilton and Mansell, in our days, almost reproduce the theory of Durand. As to the *sacraments*, Durand declared that they are "not necessary nor sufficient in themselves for the salvation of men, since God has not so necessarily connected with these elements the power by

which he upholds and redeems men in nature and in grace that he cannot work without them. They are instruments and means of grace, however, since, according to an appointment of God, every one who receives the sacrament receives also grace (provided he offers no impediment), but not from the sacrament, but from God. He makes use of the illustration that occurs elsewhere of a king who promises to bestow an alms on condition of the receiver bringing a leaden penny. The sacrament can impart no *character spiritualis*, for it is absurd to suppose that material things can effect such a communication to the spirit" (Neander, *History of Dogmas*, Bohn's ed., ii, 618). On *transubstantiation* he helped to prepare the way for the Lutheran view. Durand remarks: "It appears to be a reflection on the divine power to maintain that the body of Christ cannot be present at the Supper otherwise than by transubstantiation. The words of the institution also admit the view that the body of Christ was really contained in the sacrament (*Corpus Christi realiter contentum esse in elemento*). Yet the decision of the Church is enshrined in which we are not allowed to suppose an error" (Neander, l. c.; see also Hagenbach, *Hist. of Doctrines*, § 196); Hofer, *Nov. Biog. Générale*, xv, 481; Herzog, *Real-Encyclopædie*, iii, 895; Tenemann, *Geschichte der Philosophie*, Leipzig, 1811, vol. viii, pt. ii, 808 sq.; Oudin, *De Scriptor. Eccles.* iii, 792 sq.; Haureau, *Philosophie Scolastique* (Paris, 1850, ii, 411 sq.); Schröckh, *Kirchen-geschichte*, xxx, 898; xxxiv, 191 sq.

Durrell, David, D.D., was born in the Isle of Jersey in 1728, and was educated at Oxford, where he was afterwards fellow of Hertford College, and then principal. In 1764 he took his degree of D.D., and in 1767 was made prebendary of Canterbury. He died in 1775. He published *The Hebrew Text of the parallel Prophecies of Jacob and Moses relating to the twelve Tribes* (Oxford, 1764, 4to).—*Remarks on Job, Proverbs, Psalms, Ecclesiastes, and Canticles* (Oxford, 1772, 4to).—Kippis, *Biog. Britannica*, v, 618.

Dürer, ALBRECHT, a German painter and engraver, was born in Nuremberg May 20, 1471. When fifteen years of age he was placed by his father with Michael Wohlgemuth, the leading painter of Nuremberg. With him he remained four years, after which he travelled through Germany and the Netherlands, studying his own art and the collateral branches. In 1494 he established himself permanently at Nuremberg, and shortly after married the beautiful daughter of Hans Fritz, a distinguished artisan. The union, on account of the shrewish temper of his wife, was not a happy one, and, it is thought, even shortened his life. In 1506 Dürer was enabled, by the aid of his celebrated friend, Willibald Pirckheimer, to make a journey to Venice, Bologna, and other places of Northern Italy, where he was considerably influenced by the Italian art, especially by the works of Giovanni Bellini. With his return to Nuremberg in 1507 began the period of his great celebrity. The emperor Maximilian was one of the first to recognize his merits, and he, as well as his successor, Charles V, successively appointed Dürer court painter, while many of the great cities contended for the possession of his works. In 1518 he was at the Diet of Augsburg, where he painted the portraits of many princes and prominent men. In 1520 and 1521 he made a journey to the Netherlands, where he was received with great honors. He was considerably influenced by the Dutch art, and found fault with his former pictures as being void of that simplicity of nature which now appeared to him as the greatest charm of art. The works which he produced under the influence of this changed conception of art exhibit a refinement of the exuberant fancy in which he formerly delighted, and the two pictures, in particular, which he produced in 1526, containing figures of the size of life of four apostles, are numbered

among the greatest works which Christian art has ever produced. Dürer was an enthusiastic adherent of the Reformation, though it is doubtful if he ever fully separated from the Church of Rome. He died April 6, 1528.

Both as an engraver and as a painter Dürer belongs among the greatest artists of all ages. His works reflect the nobility of his character, to which many of his eminent contemporaries, as Melancthon, Camerarius, and Pirckheimer, bear testimony. Though a tendency to the fantastic, a peculiarity of old German art, somewhat obstructed the full development of his artistic power, especially in his youth, he surpassed all artists of his age in grandeur of conception. Among the best paintings of Dürer belong the Assumption of the Virgin Mary (1509), which in 1674 was destroyed at the burning of the palace at Munich; the exhibition of the Holy Trinity, together with many saints and blessed (1511), now at Vienna; Adam and Eve, in figures of full size of life (1507), now at Madrid. Engraving he found in its infancy, and carried it to a perfection never since surpassed. Among his best copper-plate engravings belong "St. Jerome in his Cell," "Melancholy," and "the Knight, Death, and Devil." The most noted of his wood-cuts are the "Greater" and "Lesser Passion," and the "Life of the Virgin." Dürer also wrote several works in the German language, which had a great influence, and were translated into Latin and several modern languages. On the tercentenary of his birth the corner-stone of a monument to Dürer was laid in his native city, Nuremberg, where his memory has always been held in great veneration. The work was completed by the addition of a bronze statue of the artist by Rauch. See Heller, *Leben u. Werke A. Dürers* (Leipz. 2 vols.); Von Eye, *Leben und Werke Albrecht Dürers* (Nördlingen, 1860); H. Grimm, *Albrecht Dürer* (Berlin, 1866); *Dürer-Album* (Nuremberg, 1867); *Dürers Kupferstiche, Radirungen, Holzschnitte, und Zeichnungen* (Hanover, 1861); *Dürers Handzeichnungen, etc.*, in 16 photogr. u. photolithograph. Nachbildungen (Vienna, 1864).

Durham, James, a Scotch divine, was born in West Lothian about 1622, and was educated at St. Andrews. He was ordained at 80, and was a popular preacher and (from 1650) professor of divinity in Glasgow. He died in 1658. He published *An Exposition of the Book of Job* (Glasgow, 1649, 12mo);—*An Exposition of the Song of Solomon* (London, 1669, 4to);—*A Commentary on the Book of Revelation* (Amst. 1660, 4to; Glasgow, 1788, 4to);—*A Commentary on the 58d Chapter of Isaiah* (2 vols. 8vo);—*Exposition of the Commandments* (London, 1675, 4to);—*Christ Crucified* (7th ed., Glasgow, 1769, 8vo);—*Sermons on the Riches of Christ* (Berwick, 1794, 12mo).—Howie, *Scots Worthies*, p. 888.

Dursians. See DRUSES.

Dury (DURJUS), JOHN, an eminent Protestant divine, was born in 1595 or 1596 at Edinburgh. His father had been a monk, but becoming a Protestant, he had to flee to Holland, and became minister to the English and Scotch at Leyden. Here John Dury was educated for the ministry. He visited Oxford in 1624 for the sake of the libraries. In 1628 he became pastor to the English factory at Elbing, Prussia, where he became acquainted with Dr. Godemann, one of the councillors of Gustavus Adolphus. Godemann suggested to Dury that whoever should bring about a reconciliation between the great parties into which Christendom was divided would be the greatest of peacemakers. From that time forward the greater part of his life was devoted to this object. He was invited to England in 1680 through the influence of Sir Thomas Rowe, English ambassador to the court of Gustavus Adolphus. He was well received, and his first plans were approved by archbishop Abbot, by Laud (then bishop of London), bishop Bedell, and bish-

op Hall. In 1631 he laid his plans before Gustavus Adolphus, who was greatly interested in them, and gave him letters patent recommending them to his Protestant princes. From the Lutherans he turned to the Calvinists, and visited Hanau, the Palatinate, and other places. When Gustavus fell in 1632, the Protestant (and especially the Lutheran) ascendancy was with him. But Dury's cause and plans gained ground throughout Europe. In 1638 he returned to England, and at the suggestion of Laud was ordained priest at bishop Hall (with no obligation of residence) in 1641. Armed with letters from Laud and other English prelates, he attended the meeting of Protestant States at Frankfurt (1639). His life was thenceforward an incessant round of journeyings, colloquies, lectures, and publications; all futile, so far as his great aim was concerned. He died at Cassel Sept. 23, 1684.

A summary account of them is given in the *British Remembrancer*, January, 1855, art. i, from which we take the following account of the chief source of information as to Dury: "1. *A brief Relation of a Peace which hath lately been attempted to procure ecclesiastical Peace among Protestants*, published by Samuel Hart (Leond. 1640). 2. *A summary Account of Matter in Dury's former and latter Negotiations for the procuring of true Gospel Peace, with Christian Moderation and charitable Unity among the Protestant Churches of Academies* (London, printed for the author in 1642). These two are identical down to page 32 of the latter which is the same as page 23 of the latter. The *brief Relation* has three more pages, containing a sort of epilogue, which concludes that portion of Dury's labors. 3. *The unchanged and single-hearted Peacemaker* (Leond. 1650). 4. *Consultationum Irenicorum synopsis* (Amst. 1664). Of biographies, the best are: L. G. Arnoldus, *Historia Johannis Duri*, a university thesis delivered under the presidency of J. C. Kohler, and usually quoted as that of Colerus (Wittenberg, 1717). 2. C. J. Benzellus, *Comm. Hist. Theol. de Jo. Duro maxime de actis ejus Suecicis, cum prof. I. L. Mabusii* (Helms. 1744). The proceedings of Dury at Marburg are said to be related by Schenk in his *Five Professorum Theologiae Marburgensium*, p. 207, but the book the writer has not been able to see. Jablonski has recorded his attempts in Prussia and Poland in his *Historia Consensus Sandomiriensis*. His journey in the Palatinate, Switzerland, and Denmark are related in Seelen's *Deliciae Epistolares*; in the *Museum Historicum*, and in the *Fasciculus Epistolarum Theologicarum* of Elswitch." His Latin writings include *Hy pomnematia de Studio Pacis Ecclesiasticae* (Amst. 1641, 4to);—*Consultatio Theol. super Negotio Pacis Eorn. Promovendo* (Leond. 1636, 4to);—*Capula de Pace Evangelica* (Leond. 1657, 4to);—*Irenicorum Tractatum Prodromus* (Amst. 1662, 8vo).

"Dury unfolds his scheme at length in the Declaration of his *Irenicorum Tractatum Prodromus*. In every national church there was to be a *Collegium Pauperum*, constituted of some theologians and persons of high position; these colleges were to confer together upon the condition and means of union, and come into correspondence with one another. The main conditions were these: 1. *Negotium per disputationem scholasticam nunquam esse agendum*. 2. *Ad praxim pietatis omnia concordia consilia et media esse referenda*. 3. *Per concessa in libris symbolicis semper esse procedendum*. 4. *Omnia esse subordinanda fundamentibus et irrefragabilibus Christianismi dogmatibus, quae ipsi Pontificii negare non possent*. 5. *De Syncretismo; i. e. de nova quadam religionum miscella, non esse deliberandum, sed de fundamentali concordia*. 6. *Nunquam agendum de factione aliqua politica contra Pontificios formanda, sed de Protestantium innocentia manifestanda, ut pateat, haereseos crimen his nullo jure a Pontificiis imputari*. 7. *Postquam in fundamentibus inter partes consensum esse apparebit, in reliquis tolerantiae innoxiae locum esse dandum*. 8. *Prophet*

di libertatem secundum s. Scripturas regulatam et a personalia non tractet concedendam esse. 9. Iniarum præteritarum amnestiam esse faciendam, nec vne admittendum, ut illi se novis injuriis læssant. Regimen Ecclesiarum utriusque parti liberum esse inquendum, ut illud, prout ex usu suo utilissimum licabit Ecclesia quælibet, constituat. The means commended were, the setting aside of the prejudices the parties against one another, the publication of s. to recommend the union, and correspondence ween the parties." Gieseler, *Church History* (ed. Smith, iv, § 51). See also (besides the works cited the course of this article) Mosheim, *Church History* ew York, 1854, 8 vols. 8vo), iii, 360; Bayle, *Diction-*, s. v.; Reid, *Westminster Divines*; Arnold, *Kirchen-*-Ketzler *Historie*, xvii, xi, § 23; Dowding, *Life of listus* (Lond. 1864, 12mo).

Dust (usually אֶפְרַיִם, *aphar'*; but אֶבָרָא, *abak'*, *pul-*verence, in Exod. ix, 9; Isa. v, 24; xxxix, 5; Ezek. vi, 10; Nah. i, 8; "powder," Deut. xxxviii, 24; אֶבְרָא, *shach'ak*, or impalpable dust, Isa. xl, 15; אֶבָרָא, *dakak'*, to *tristate*, 2 Chron. xxxiv, 4; Gr. κοκκός, *kokkos*, but χόσος, *chos*, in Mark vi, 11; Rev. xviii, 1). In the immediate vicinity of Judæa there are st plains or deserts of fine sand, which, when agized by a violent wind, makes most terrific and desolating storms. Eastern travellers describe them particularly, and think them more dreadful than storms sea. This affords us a striking illustration of the ture and horrors of the plague, mentioned in Exod. ii, 16, 17, when the extremely fine and penetrating ist of the land of Egypt was converted into *gnats*. Among the various fearful punishments denounced in e event of their forsaking Jehovah, the Hebrews are estained that the rain of their land shall become powder and dust" (Deut. xxviii, 24). See **STORM**. Among the Hebrews, to cast dust or ashes upon the ad was a sign of mourning (Josh. vii, 6), and sitting he dust was a sign of extreme affliction (Isa. xlvii, ; Lam. iii, 29). See **GRÆF**. The term "dust" is ten used figuratively, sometimes to denote the grave (ob vii, 21) or death itself (Gen. iii, 19; Psa. xxii, 15), metimes to express a numerous people (Num. xxiii,), and sometimes a low or mean condition (1 Sam. , 8; Nah. iii, 18). See **Wemyss**, *Symbol. Dict.* s. v. o shake or wipe off the dust of a place from one's et marks the renouncing of all intercourse with it in ture (Matt. x, 14; Acts xiii, 51). To "lick the dust" gnifies the most abject submission (Psa. lxxii, 9). In lmost every part of Asia those who demand justice gainst a criminal throw dust upon him. Thus Shi-el cast dust at David (2 Sam. xvi, 18), signifying by at action that David ought to be put to death. This ew is confirmed by the conduct of the Jews to Paul; hen they seized him in the Temple they cried out, Away with such a fellow from the earth, for it is not t that he should live; and as they cried out, and cast ff their clothes, and threw dust into the air, the chief aptain commanded him to be brought into the castle" Acts xxii, 28). See **ASHES**.

Dutch Reformed Church. See **REFORMED CHURCH**.

Dutens, Louis, was born at Tours, France, Janu-ry 16, 1730. When he was about eighteen his sister ras put into a convent by order of the archbishop of Tours. This violence so irritated the young man that e left his country and settled in England, where he ntered the ministry of the Established Church, and became rector of Elsdon, in Northumberland. He died n London, March 23, 1812. Dutens was a man of aried culture; was a member of the Royal Society, and had the title of historiographer to the king. Besides writing numerous works in science and literature, e edited the works of Leibnitz, *Opera Omnia nunc pri-*-um collecta, etc. (Geneva, 1769, 6 vols. 4to); *Le Toc-*

sin, 1769 (against the infidels of the 18th century; re-rinted under the title, *Appeal to Good Sense* (Lond. 1777, 8vo); *De l'église, du Pape*, etc. (Geneva, 1781, 8vo); *Recherches sur l'origine des découvertes attribués aux modernes* (Paris, 1766, 8vo; 4th edition, 1812, 8vo; translated, *An Inquiry into the Origin of the Discoveries attributed to the Moderns*, London, 1769, 8vo).—Hoefer, *Novv. Biog. Générale*, xv, 496.

Dutoit, JEAN PHILIPPE, also called Dutoit-Mem-brini, was born at Moudon (Switzerland) in 1721. He devoted himself at an early age to the study of theolo-gy at the academy in Lausanne, and in 1747 became a candidate for the ministry, but he never took a pas-toral charge. In 1750 he had a severe illness, during which he underwent a thorough religious change. He was accustomed to preach extemporaneously, and al-though his sermons were generally long, he always at-tracted large audiences. It was not unusual to see, at the close of his discourses, men who had lived in en-mity with each other be reconciled. In 1754, having accepted the appointment of missionary preacher and catechist, he resigned it after fourteen days. In 1759 impaired health obliged him to desist from preaching, and he caused his name to be stricken from the list of clergymen. He now devoted himself with all his en-ergy to the study of the Church fathers, especially the Mystics. He himself became a strong representative of Mysticism in the French Reformed Church. His opposition to Voltaire, as well as his seclusion, made him many enemies, and on the 6th of January, 1769, while on a bed of sickness, he was suddenly visited by the police, and, by order of the authorities, his papers and manuscripts were seized and forwarded to Berne; but, as his books were found to be of a very innocent character, nothing came of the affair. Upon Dutoit these proceedings made a lasting impression, much greater than could have been supposed of so pious a man. He never recovered from the shock, and died surrounded by a circle of friends and admir-ers, January 21, 1798. Dutoit is highly spoken of by the historians Monnard and Oliver, and of late atten-tion has been called to his writings by a memoir of his life and works by Jules Chavannes, in the *Chrétien évangélique*, 1861, p. 269, 369, 684. The most impor-tant works of Dutoit are *Philosophie divine*, etc., par Keleph ben Nathan, 8 vols. 1798; *Philosophie chré-tienne*, 4 vols. 1800; and an edition of the *Letters of Madame Guyon*, with additional reflections.—*Harzog, Real-Encyklop.* xix, 441 sq.

Dutton, Aaron, a Congregational minister, was born at Watertown, Conn., May 21, 1780. He gradu-ated at Yale College in 1803, entered the ministry 1805, and was ordained pastor of the First Church, Guilford, Dec. 10, 1806. He resigned June 8, 1842, and a year after was sent as missionary to Iowa by the Amer. Home Miss. Society. He accepted a call in 1848 from the church in Burlington, and returned to prepare for his removal, but was taken ill, and re-mained in New Haven until his death, June, 1849. He was not only a successful minister, but an efficient educator. Many of his pupils were distinguished in college, and afterwards became eminent in the learned professions. His publications consist of some occa-sional discourses.—*Sprague, Annals*, ii, 489.

Dutton, Matthew Rice, a Congregational min-ister, was born at Watertown, Conn., June 30, 1783. He graduated at Yale in 1808. In 1810 he was made tutor at Yale; and in 1814 became pastor in Stratford, Conn., where he remained until 1821, when he was called to Yale College as professor of mathematics and natural philosophy. He entered on his duties with great vigor; but his health soon failed, and he died in July, 1825.—*Sprague, Annals*, ii, 592.

Dutton, Samuel W. S., a Congregational min-ister, son of the Rev. Aaron Dutton (q. v.), was born at Guilford, Conn., March 14, 1814, and graduated at

Yale College in 1838 with distinguished honor. After three years of teaching, first at Baltimore, and then as rector of the Hopkins Grammar School at New Haven, he became one of the tutors at Yale College, prosecuting at the same time his studies in the theological department of the University. He was ordained pastor of the North Church, in New Haven, in June, 1838. He has been widely known by his valuable contributions to the *New Englander*, and by other occasional publications. His *Concio ad clerum*, preached and published in 1855, on 'The relation of the atonement to holiness' (the subject being assigned to him by the General Association of Connecticut), was a very able and timely theological treatise, and was highly commended by critics of various schools and denominations." The degree of D.D. was conferred upon him by Brown University in 1856. Dr. Dutton was a faithful and successful pastor, and a distinguished preacher. For the *New Englander* he wrote about two articles a year from its commencement to the year of his death. He died pastor of the North Church, Jan. 27, 1866.—*The Independent*, Jan. 1866; *Congregational Quarterly*, April, 1866.

Duty (דָּבָר, *dabar'*, lit. a word or matter; Gr. *ὀφείλω*, to owe). For "duty of marriage" (דְּבַר יְבִי, *onah'*, dwelling together, Exod. xxi, 10; used in the Talmud for connubial right; i. q. ἡ ὀφειλόμενη ἐννοια, "due benevolence," 1 Cor. vii, 8), see COHABITATION. For "the duty of a husband's brother" (דְּבַר יָבֵן, *yobas'*, Deut. 25, 5, 7, to marry a deceased brother's childless wife, Gen. xxxviii, 8), see LEVIRATE LAW. See ETHICS.

Duvell, CHARLES MARIA, D.D., a converted Jew of the 17th century, of the facts of whose life little is known. He was born at Metz, Lorraine. Carefully educated, his studies led him to abandon Judaism; and, as the Roman Church was the first Christian society with which he was brought into contact, he entered its communion and ministry, and received the title of D.D. While a Romanist he published a *Commentary on Matthew and Luke*. But his further studies led him to Protestant views, and he passed from France into England, where he was well received by Stillingfleet, Tillotson, and other eminent men of the Church of England, and was admitted to orders. He died about 1700. Among his writings are *Explicatio Literalis Cantici Canticoorum* (London, 1679, 8vo);—*Literal Exposition of the Minor Prophets* (London, 1680). Soon after this publication he became a Baptist, and wrote in Latin a *Comment. in Acta Apostol.*, which was translated under the title *A literal Explanation of the Acts of the Holy Apostles* (Lond. 1685, 8vo; new ed., edited by F. A. Cox for the Hansard Knollys Society [Lond. 1851, 8vo]). In this commentary Duvell vindicates the principles and usages of the Baptists.—*Duvell, Commentary on Acts, Historical Introduction*.

Duvergier or Duverger, JEAN DE HAURANNE, abbot of St. Cyran, was born at Bayonne, France, in 1581. He studied theology at Louvain. Here he made the acquaintance of Jansenius, with whom he went to Bayonne to continue their studies together from 1611 to 1616. In 1609 he began to distinguish himself as a casuist by his treatment of the *Question royale*. In 1617 he wrote in defense of his friend the bishop of Poitiers, who had been blamed for heading the troops sent against the Protestants. After going to Paris, where he carried on an extensive correspondence with Jansenius, who had returned to Louvain, and continuing to apply himself still more to the study of the fathers, especially of St. Augustine, he was called to England by Henrietta of France, wife of Charles I. He then conceived the idea of organizing the Roman Catholic Church of England on the plan of the Gallican Church. This brought him into conflict with the Jesuits, against whom he wrote (1631), under the assumed name of Petrus Aurelius, a book,

which the *Assemblée Générale* of the French clergy approved and ordered to be printed (*Petri Aurelii de logi opera, jussu et impensis cleri gallicani dem in a com edita*, Parisii, 1641; new edit. 1646). *Duvorg* and Jansenius soon after decided to form a congregation of their own. They attempted to win over the fathers of the Oratory, and had made some progress in that direction, when, in 1635, Duvergier was appointed spiritual director of the abbey of Port Royal (q. v.). Here the effect of his principles was apparent in the pure morals of his charge, which contrasted strongly with the general laxity of the time. He soon, however, incurred the displeasure of Richelieu (q. v.), who had him arrested and transferred to Vincennes, May 14, 1638. He was released in February, 1643, after Richelieu's death. He continued to labor as confessor and writer until his death, Oct. 11, 1643. Parts of his body were preserved in the abbey of Port Royal a sacred relic. Besides the above-mentioned works, he wrote also *Somme des fautes* (1626, against the Jesuit Garasse, who had accused the casuists of atheism), and other occasional pamphlets. See *Sainte Beuve, Hist. de Port Royal*; Herzog, *Real-Encyclop.* iii, 571; *Huck. Nouv. Biogr. Générale*, xv, 542.

Dwarf (דָּבַד, *dak*, becom small, as in Lev. xvi, 13), an incorrect rendering (Lev. xxi, 20; Sept. ἄπλα, Vulg. *hippus*) for a lean or emaciated person, i. e. a disease (as in Gen. xli, 8-24; Lev. xiii, 30). See BLEMISH.

Dwell (expressed by various Heb. and Gr. words often differently rendered, e. g. דָּוַן, דָּוַן, דָּוַן, דָּוַן; κάθμα, οίκος, μένος, σκηνώσ). It has been thought, both from Scripture and from profane authors, that the first abodes of men were caves and clefts in the rock; these abound to a remarkable degree in those countries which we know to have been the earliest peopled, and still serve as ordinary habitations. See CAVE. In succeeding ages they abate generally in tents, as the Arabs of the desert do to this day. The invention of these is ascribed to Japhet the son of Lamech, who is termed "the father of tents" as dwell in tents" (Gen. iv, 20); though, from comparing this verse with the 17th, we may be led to suppose that men lived in houses of some kind before they lived in tents. See TENT. The art of building stories in a building is very ancient, as we gather from the construction of Noah's ark and the tower of Babel. The houses in Babylon, according to Herodotus, were three or four stories high, and those in Thebes, or Diospolis, in Egypt, four or five stories. They appear to have been low in Palestine in the time of Joshua; an upper story, although it may have existed, is not mentioned till a more recent age. Buckingham states that the houses at Mousal are mostly constructed of small unhewn stones, cemented by mortar, and plastered over with mud, though some are built of burnt and unburnt bricks." Our text alludes to houses built of mud at the close of his sermon on the mount (Matt. vii, 26, 27), which was calculated to resist the effects of the impetuous winds that descended from the mountains of Edom. In India, nothing is more common than for the poorest dig or break through these mud walls while the unsuspecting inhabitants are asleep, so as to plunder them. To similar depredations our Saviour appears to allude when he exhorts his disciples not to lay up their treasure where thieves break through and steal (Matt. vi, 19, 20). Job also seems to refer to the same practice (xxiv, 16). In the holes of these walls serpents sometimes conceal themselves, which is alluded to by the prophet Amos (v, 19). It appears from Exod. v, 7, that in Egypt straw anciently entered into the composition of bricks; they were a mixture of dirt, mud, and straw, slightly blended and kneaded together, and afterwards baked in the sun. Philo, in *Life of Moses*, says that they used straw to bind the

icks. In the remains of Egyptian edifices, the straw preserves its original color, and is a clear proof that they were never burnt in stacks or kilns. Dr. Chardson found near the ruins of Tentyra huts built sun-dried brick made of straw and clay. See WELLING.

God, it is said, "dwells in light," in respect to his dependent possession of his own glorious attributes Tim. vi, 16; 1 John i, 7). He dwells in heaven in respect to his more immediate presence there (Psa. xliii, 1). He dwells in his Church in the continued stowal of his ordinances, and of his gracious support and comforting influences (Psa. ix, 11; 1 John iv, 7). Christ dwelt among men in his state of humiliation on earth (John i, 14). He dwells in our hearts of faith, he is united to us as our head; his righteousness is imputed to us, and applied to our consciences; his spirit and grace are fixed in our hearts; he loves and delights in us (Ephes. iii, 17-19). The Holy Spirit dwells in us, and sheds abroad his gracious influence Rom. viii and ix; 1 Cor. iii, 16; 2 Tim. i, 14). The Word of God dwells in us richly, when it is carefully studied, firmly believed, and diligently practised (Psa. xix, 11; Col. iii, 16). Wickedness, vengeance, or judgment is said to dwell in or upon a person or land when it long continues there (Job xi, 14; xviii, 15; sa. xxxii, 16). See Wemyss, *Symbol. Dict.* s. v.

DWELL DEEP (דְּבַר לְשֹׁבֵת, *debar la-she'beth*, take deep for dwelling; Sept. βαθύναντες εαυτοίς εις άστυα, Vulg. descendite in cavernam), a phrase that occurs in Jer. xlix, 8, and seems to refer to the custom still common in the East of seeking retreat from anger in the recesses of rocks and caverns. When the wandering Arabs have drawn upon themselves the resentment of the more fixed inhabitants of those countries, and think themselves unable to stand against them, they withdraw into the depths of the great wilderness, where none can follow them. "Always on their guard against tyranny," says M. Savary, "on the least discontent that is given them, they pack up their tents, load their camels, ravage the flat country, and, loaded with plunder, plunge into the burning sands, whither none can pursue them, and where they alone can dwell." See ARABIA.

Dwelling (דְּבַר לְשֹׁבֵת, זבול, בית, חדר, חדר, חדר, etc.; κατοικησις, etc.). The dwelling-houses of Palestine (see generally Harmer, i, 152 sq.; Faber, *Archaeol.* i, 865; on Egyptian architecture, Rosellini, *Monum. civ.* ii, 378 sq.) were usually (Harmer, i, 165) built of burnt or merely dried bricks,

(Niebuhr, *Trav.* ii, 287; Pococke, *East.* ii, 178; Tavernier, *Trav.* i, 167, 287; Robinson, *Res.* ii, 681-687; iii, 514, 580), and therefore very perishable (Matt. vii, 25; comp. Ezek. xii, 5, 7; xliii, 18 sq.; Tavernier, i, 287; Wellsted, i, 280); but frequently of stone (Lev. xiv, 40, 42; comp. Robinson's *Res.* iii, 818, 420, 496, 720), and palaces of squared stone (1 Kings vii, 9; Isa. ix, 9; Josephus, *Ant.* viii, 5, 2; compare Robinson, i, 854), or even of marble (שֹׁבֵת, שֹׁבֵת, comp. 1 Chron. xxix, 2; Josephus, *Ant.* xv, 11, 8; *War.* v, 4, 4; of different building-stone, see the Mishna, *Baba Bathra*, i, 1; the laying the foundation was an occasion of ceremony and festival, Zech. iv, 7; compare Ezra iii, 10; Job xxxviii, 7). These were held together by a cement (mortar, שֹׁבֵת, Jer. xliii, 9; see Rosenmüller in loc.) of lime (רָבָה, Isa. xxvii, 9) or plaster of Paris (gypsum, שֹׁבֵת, Isa. xxxiii, 12; comp. Deut. xxvii, 4; Theoph. *Lapid.* 68 sq.), perhaps also bitumen (asphaltum, שֹׁבֵת, compare Gen. xi, 8; Faber, i, 398 sq.). The exterior (and probably also the interior over the plaster) was usually whitewashed (שֹׁבֵת, *kovia*, Lev. xiv, 41 sq.; Ezek. xlii, 10 sq.; Dan. v, 5; Matt. xxiii, 27; Sirach, xxii, 17), bright wall-colors being used for royal residences (Jer. xxii, 14). The beams (2 Chron. xxxiv, 11; on שֹׁבֵת, Hab. ii, 11, see Gesen. *Thesaur.* p. 705, and Delitzsch in loc.) were of sycamore (Isa. ix, 9), sometimes of olive-wood, sandal, or cedar (1 Kings vii, 2 sq.; Isa. ix, 9; Jer. xxii, 14). Elegant mansions were adorned externally with columns (of marble, Cant. v, 15; 1 Kings vii, 15 sq.; 2 Kings xxv, 18; Faber, *Archaeol.* i, 414 sq.), and often whole porticoes (שֹׁבֵת, *stoa*, 1 Kings vii, 6; comp. Josephus, *War.* iv, 4). See TEMPLE. The houses of the gentry (Niebuhr, *Trav.* ii, 298; Shaw, *Trav.* p. 182 sq.) were of several stories (1 Kings vii, 2 sq.; comp. Acts xx, 9; but see Korte, *Suppl.* p. 177), generally built in a quadrangle (comp. Kämpfer, *Amoen.* p. 194; Burckhardt, *Trav.* i, 120), and enclosing (Luke v, 19) a spacious court-yard (שֹׁבֵת, 2 Sam. xvii, 18; Neh. viii, 16; comp. Esth. i, 5; v, 1; the *impluvium* or *aula*, Matt. xxvi, 69; see Harmer, i, 177), which, surrounded by colonnades and galleries (Shaw, p. 355), paved (Harmer, i, 175), and containing fountains (2 Sam. vii, 18; comp. Joseph. *Ant.* xii, 4, 11; Harmer, i, 175), baths (2 Sam. xi, 2), and trees (Harmer, i, 175), formed the guest-chamber or drawing-room for the reception of visitors (Shaw, *Trav.* p. 183; Faber, i, 401; Harmer, i, 174; comp. Esth. i, 5 sq.), being often screened from the sun's rays by an awning (Rosenmüller, *Morg.* iii, 297). The flat roof, covered on the top with tiles, earth, or stone, and surrounded by a low parapet, was used sometimes for household or religious purposes, at others as a place of meeting or recreation. See ROOF. In connection with it (2 Kings xxiii, 12) was an upper room (שֹׁבֵת, *upper room*), which was used (comp. Niebuhr, *Trav.* i, 880, 400; Shaw, p. 188 sq.) as a private chamber (2 Sam. xviii, 38; Dan. vi, 11; Judith viii, 5); also as a spare bedroom (2 Kings xxiii, 12; Tobit iii, 12; Acts i, 18; xx, 8), a sleeping apartment especially for guests (2 Kings iv, 10), and as a sick-chamber (1 Kings xvii, 19; Joseph. *Ant.* xviii, 8, 2), or room for laying out a corpse (Acts ix, 87, 89), but in summer resorted to for fresh air (Judg. iii, 20); and was often furnished with two modes of exit, one leading within the house, the other by a staircase directly to the street. Larger residences had an additional front court (שֹׁבֵת, *προαύλιον*, *prōdyron*, *pylōn*, *aulē*; Jer. xxxii, 2; Mark xiv, 88; Luke xvi, 20; John xviii, 16; Acts x, 17, etc.), which served as an anteroom (so the Rabbins understand שֹׁבֵת, Judg. iii, 28;

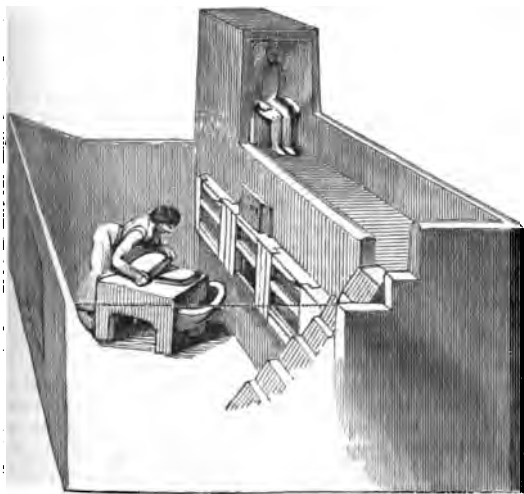

Model of a small Ancient Egyptian House (now in the British Museum), showing the interior Court and upper Chamber.

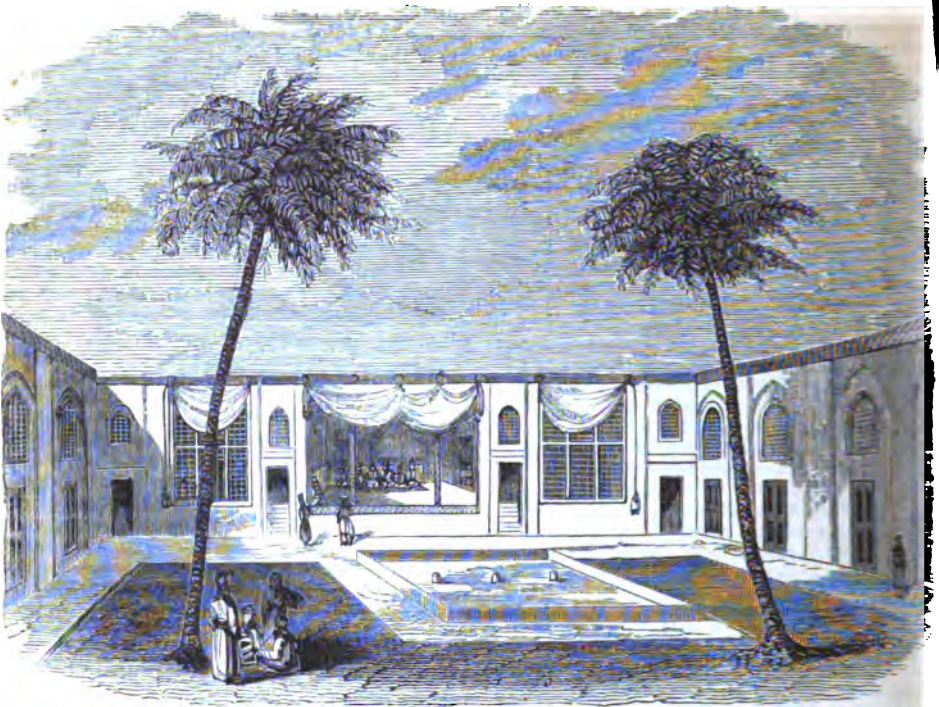

A modern Persian Mansion.

see Faber, p. 440), and from which, by means of stairs (רוֹבֵץ, 2 Chron. ix, 11; a winding staircase, בֵּלַל, 1 Kings vi, 8), often finished with costly wood (2 Chron. ix, 11), persons passed to the roof or upper story. A door led from the fore-court to the inner court, and from the latter was the entrance to the rooms on the ground floor of the house proper. These last were variously decorated with wainscoting (1 Kings vii, 7; Jer. xxii, 14; Hag. i, 4), ivory (1 Kings xxii, 39; Am. iii, 15; compare Psa. xlv, 9; Homer, *Odyss.* iv, 72 sq.; Horace, *Od.* ii, 18, 1 sq.; Pliny, xxxvi, 5; Harmer, i, 168 sq.; ii, 171 sq.; Faber, p. 399 sq.; also with precious metals inlaid or plated, Tibull. iii, 8, 16; Horace, *Od.* ii, 18, 1 sq.; Cicero, *Parad.* vi, 3; comp. 1 Cor. iii, 12), and carving (Josephus, *Ant.* viii, 5, 2; comp. Tavern. i, 168), since the splendor of Oriental houses was lavished rather upon the interior than the exterior (Pococke, *East*, i, 49); the floor was laid sometimes with a coating of gypsum, at others with tessellated blocks of variegated marble (Tibull. iii, 8, 16; Cicero, *Parad.* vi, 8) or other kinds of stone (Harmer, i, 172 sq.; compare Esther i, 6). The doors (Deut. vi, 9), seldom high in private houses (Prov. xvii, 19), sometimes of stone (Burckhardt, i, 122), swung (comp. Shaw, *Trav.* p. 186) on morticed pivots (צִיר, Prov. xxvi, 14; in sockets, בִּרְזִית, 1 Kings vii, 50; comp. *cardo fenestræ*, Vitruv. ix, 6), and were commonly fastened with wooden bolts (בִּנְעָל, בִּנְעָלָה, which were opened (Judg. iii, 25; Isa. xxii, 22; comp. Harmer, i, 188) by means of a key (בִּנְעָלָה), but only from the inside (Cant. v, 5; Luke xii, 7; comp. Faber, p. 427). In the better class of houses there was a door-keeper (Joseph. *Ant.* xvii, 5, 2) or female porter (John xviii, 16 sq.; Acts xii, 13; comp. Plaut. *Curcul.* i, 1, 76; Sept. 2 Sam. iv, 6), who, in case any one knocked outside (Luke xii, 86; xiii, 25; Acts xii, 18; compare Matt. vii, 7; Rev. iii, 20; Thilo, *Apocryph.* p. 218; see Becker, *Charicles*, i, 280), and gave their name (Acts xii, 14; Rev. iii, 20; comp. Plutarch, *Gen. Soc.* p. 51; Lucian, *bis. Accus.* p. 29; Apul. *Asin.* i, p. 19 Bip.),

opened the door to them (Acts, xii, 13; comp. *Athen.* xiv, 614). (See Stuck, *Antiq. comite.* p. 249; *Sagitt. De januis vet.* Jen. 1694, ch. 16; also Elsner, *Oberr.* 411 sq., in Graevii *Thesaur.* vi.) Princes, however, had guards at the palace gates (1 Kings xiv, 27). The windows (חַלֹּנֹת), on account of the street dust, generally face the court-yard (Schubert, iii, 291), although anciently this rule does not appear to have so extensively prevailed (Judg. v, 28; Prov. vii, 6); they were closed by a lattice (Judg. v, 28). The most interior, or back rooms of all, were devoted to the special occupancy of the female members of the household, as is still universally the case in the East, under the name "harem," and no male dars intrude within their precincts (Chardin, vi, 6 sq.; Hartmann, *Hebr.* ii, 399 sq.; Hoffmann in the *Hall. Encyclop.* ii, 1, p. 396 sq.). The more distinguished Hebrews early had separate summer and winter residences (בֵּית הַחֹרֶף and בֵּית הַקֵּץ, Amos iii, 15; Jer. xxxvi, 22; comp. Judg. iii, 20; see Harmer, i, 200; Prosp. Alp. *Med. Egypt.* i, 6. Niebuhr, *Trav.* ii, 394). The latter were warmed (if which they had the more need, as glass windows are unknown in the East) by means of a fire-pot (כַּד, Jer. xxxvi, 32), which is merely a vessel of burnt clay (Niebuhr, *Beschr.* p. 56) placed in a round hole in the middle of the room, over which, when the fire is burnt down, the inmates place a four-cornered frame, and next a carpet over this, and then gather around to enjoy the warmth (Tavernier, i, 276; Niebuhr, *Trav.* i, 154; ii, 394). The furniture of the rooms (2 Kings iv, 10) consisted of a sofa or couch (בִּנְיָן, compare Ezek. xxiii, 41; Amos vi, 4; compare Josephus, *Ant.* xv, 9, 8), which luxury was often adorned gorgeously (Amos vi, 4; Cant. vii, 16), and furnished with pillows (Ezek. xiii, 10); and besides this, only chairs (כִּסֵּא), a table (שֻׁלְחָן), and lanterns or lamp-stands (2 Kings iv, 10). See all the above parts and articles in their alphabetical order. Compare *Hous.*

The *house-leprosy* described in *Lev.* xiv, 33-57 was

corrosion of the saltpetre found in the lime used as mortar and the limestone used for building (see *Misaelis, Mos. Reclit*, iv, 264 sq.; *Mishna, Neqaim*, xii), and is still common in walls in Egypt (Volney, *Trav.* 55).—Winer, i, 466. See LEPROSY.

Dwight, Holden, a minister of the Methodist Episcopal Church, was born in Thompson, Conn., Aug. 28, 1810, was converted in 1828, studied in Dudley Academy, Mass., in the Wesleyan Academy at 'Ibraham, and graduated in the Wesleyan University at Middletown in 1835. After this he taught in academies of the South and in Louisiana College, and as some time agent for Macon Female College, Ga., until 1841, when he removed to Norwalk, O., and was principal of the seminary there, and of the Baldwin Institute at Berea till his death in 1847. Mr. Dwight as a man of strong mind and generous feeling, a thorough classical and general scholar, and an eminently successful teacher. As a preacher he was dignified, forcible, and convincing.—*Minutes of Conferences*, iv, 159.

Dwight, Louis, a Congregational minister, was born at Stockbridge, Mass., March 25, 1798, and graduated at Yale College in 1818. He studied theology at Andover, but, fearing that his feeble health would not fit him for the pastorate, he accepted in 1819 an agency of the American Tract Society. In 1828 he became agent of the American Education Society. In 1824, his health failing seriously, he undertook a long journey on horseback, and combined with this pursuit of health a mission of mercy in supplying Bibles to prisoners in the various jails. He visited for this purpose the prisons of New York, Philadelphia, Baltimore, Washington, and as far south as South Carolina. On his return to Boston in 1825, his reports of his mission gave rise to the American Prison Discipline Society, of which he was the first secretary, in which service he remained for thirty years. For years he reached the Gospel to the insane poor at South Boston. He died July 12, 1854; and the epitaph on his tomb sums up his labors in the phrases "a benefactor of man; a friend to the prisoner; a reformer of prisons; a preacher of the Gospel."—*Sprague, Ann.* ii, 17.

Dwight, Sereno Edwards, D.D., an eminent Congregational minister, was born at Greenfield, Conn., May 18, 1786. He graduated at Yale College in 1808, and in 1806 was chosen tutor, in which post he continued until 1810, when, having completed his law studies, he entered upon practice at the bar. He entered the ministry in October, 1816, and was elected chaplain of the United States Senate. On Sept. 3, 1817, he was installed pastor of Park-street Church, Boston, where he remained until his resignation, April 9, 1826. In 1838 he was elected to the presidency of Hamilton College, and entered upon the office in August, and resigned in 1835. In 1838 he moved to New York. He died in Philadelphia, Nov. 30, 1850. Dr. Dwight published *Memoirs of David Brainard* (1822):—*An Address on the Greek Revolution* (1824):—*The Death of Christ: the Substance of several Sermons delivered at Park-street Church* (1826):—*The Life of President Edwards*, accompanying a new edition of Edwards's works (1830):—*The Hebrew Wife* (1836); and a few occasional sermons. His discourses were published in a volume with memoir in 1851 by W. T. Dwight.—*Sprague, Annals*, ii, 629.

Dwight, Timothy, D.D., LL.D., grandson of Jonathan Edwards the elder, was born at Northampton, Mass., May 14, 1752, and was graduated at Yale College at a very early age in 1769. Two years after his graduation he was elected a tutor in his college, and held the office during six years. Near the end of his tutorage he was licensed to preach, and soon joined the army of the Revolution as a chaplain to General Parsons's brigade. After a year spent in this

service, he was called home by the news of his father's death in 1778, to take care of his mother and the family, being the eldest child of thirteen. Relinquishing his part of the family property, he taught school and preached for his own family's support. So highly was he thought of by his fellow-citizens that they called him into public life, solicited him to give himself permanently to politics, and promised to secure for him a place in the Continental Congress. But he preferred to preach the Gospel, and, after several flattering calls which he declined, accepted one from the parish of Greenfield, in Connecticut, to become their pastor. Here he spent twelve years, from November, 1788, onward. As his salary was inadequate to the expenses which his family and his hospitality obliged him to incur, he established an academy, the oversight of which he took upon himself, which was distinguished for the advanced and thorough training of its scholars, and in which upwards of a thousand young persons of both sexes came under his instruction. His reputation as an instructor and as a preacher led the corporation of Yale College in 1795 to elect him to the presidency of that institution, which had lately become vacant by the death of President Stiles.

It was during his residence at Greenfield that his two poems, one on the "Conquest of Canaan" by Joshua, an epic in rhyme, the other entitled "Greenfield Hill," and describing the scenery and the events of the neighboring country, were given to the world. These poetical works, which are not without glow and fire, are now forgotten; but some of the versions of the Psalms which he inserted in a revision of Dr. Watts's Psalms, with hymns annexed, published by direction of the General Association of the state in 1800, have stood their ground, and probably will never go out of use; we refer especially to those whose first lines are, "I love thy kingdom, Lord" (Psa. cxxxvii), and "Shall man, O God of life and light" (Psa. lxxxviii).

The state of Yale College at his accession to the presidency was far from being satisfactory, but his vigor, ability, and wisdom ere long infused into it a new life. With great wisdom, he selected young men for the several professional chairs. He himself preached, and with very great acceptance, in the college chapel; he instructed in morals, mental philosophy, natural theology, and the evidences of revelation; and the religious interests of the students found in him a director and a guide. Soon after he came to Yale College he found that many students were tainted with infidelity. He was among the first, and one of the very ablest defenders of the Christian faith in this country, and by his preaching, as by his sermons on "The nature and danger of infidel philosophy" published at the time, he may be fairly said to have driven infidelity from the college. On the whole, his administration of the college was a very successful one. To him more than to any other man Yale College is indebted for its highly respectable position among the seats of learning in this country.

President Dwight's death (1817), when he was not quite sixty-five, was occasioned by a cancer in the neck of the bladder. He had a commanding person, a noble voice, great pathos, an ardent temper, an excellent judgment, and sincere piety. His conversational powers were of the highest order. His style in his extempore addresses and in his written discourses was fervid and eloquent, but somewhat too rhetorical. He entered with great interest into the politics of the day, as an adherent of the principles of Washington and of the Federal party. His theology was Calvinism as modified by the two Edwardses, his grandfather and uncle. In his youth he preached it with warmth, but as he advanced in years he laid little stress on any doctrines except those in which all evangelical Christians were agreed. His life was full of acts of hospitality and benevolence, and his sympathies were of the tenderest sort. During a great part of his life his

eyes were too weak to be used, and his works were principally written by an amanuensis. His principal works published under his name, besides those which have been already mentioned, were *Theology explained and defended* (Middletown, Conn., 1818, 5 vols.; and in a multitude of editions afterwards in 4 vols., both in the United States and in England):—*Travels in New England and New York* (New Haven, 1821, 4 vols., which contained the record of journeys on horseback undertaken for his health during vacations), and *Sermons of an occasional character* (New Haven, 1828). See *Life* prefixed to his *Theology*, and Dr. Sprague's life of him in *Sparks's American Biography*, vol. xiv, or new series, vol. iv.

Dwight, William T., D.D., a Congregationalist minister, was a son of President Dwight, and was born at Greenfield Hill, Conn., in 1796. He graduated at Yale College in 1818, and was distinguished for his scholarship in a class of many able scholars. From 1817 to 1819 he was a tutor in the college, and then removed to Philadelphia, where he practiced law until 1831. In that year he was awakened under a lecture of Dr. Skinner, and, abandoning the law, he was licensed by the Third Presbytery of New York, and accepted a call to the Third Church in Portland, Maine. His ministry of above thirty years was eminently successful. He was an overseer of Bowdoin College and president of the Maine Missionary Society. In 1852 he was president of the Albany Convention of Congregational churches. "As a preacher he is entitled to a foremost rank among American divines for sound and varied learning, clear and polished diction, graceful and effective delivery, and eminent success." He died at Andover Oct. 22, 1865. He published a *Life of Sereno E. Dwight, with a Selection from his Discourses* (1851).

Dye (דָּוַם, *adam'*, in the phrase "rams' skins dyed red," Exod. xxv, xxvi, xxxv, etc., to be "ruddy," Lam. iv, 7, or "red," Nah. ii, 3; Isa. i, 8; Prov. xliii, 81; דָּוַם, *chamets'*, brilliant in color as wine-stained garments, Isa. lxiii, 1). The art of dyeing is undoubtedly of great antiquity, and is, perhaps, nearly coeval with that of weaving. The Egyptians particularly excelled in the brilliancy of their dyed stuffs; and from them the Hebrews, while dwelling among them, learned the art of dyeing. This is evident from the curtains of the tabernacle and the sacerdotal robes which were manufactured in the desert (Exod. xxvi, 1; xxviii, 5-8). The skill of the Egyptian linen-manufacturers in employing the metallic oxides and acids, or mordants, is placed beyond dispute by ocular proof. The various processes of dyeing and printing, or imparting the pattern, by blocks (the origin of calico printing), are exhibited in Rosellini's plates in all their minute details; and even the printing-blocks engraved with phonetic letters, and with the dye upon them, may be seen in the British Museum. Pliny's testimony is interesting as illustrating, though not wanted to corroborate the fact. "They dye cloth," he says, "in an extraordinary manner. It appears quite white before it is dipped; they then imbue it with drugs (mordants), which do not alter its appearance, but which absorb and retain a new and permanent color, varied according to the application of the drug." This is the modern process. Experimental investigation and chemical analysis have shown demonstratively that in the dyes which the linen and cotton manufacturers employed to produce certain results of which the relics are extant, they must have employed acetates of alum and of iron, and vegetable and mineral dyes, both substantive and adjective, as they are termed by the modern dyers. It is as easy as invidious to ascribe these applications to accident rather than to chemistry. Evidences drawn from all the other arts and trades prove that the Egyptians were good chemists. The long stripes of linen which the

Hebrews worked in the desert for the tabernacle were separately blue, scarlet, and white (Exod. xxxv). The last was probably the effect of bleaching; but the whole of the colors and cloth so dyed have been fast as well as the yellow, to evince chemical knowledge. It appears that the linen-printers and dyers used *corthamus tinctorius*, which grows in Egypt, for wood for blue, and the *reseda luteola*, also a native of Egypt, for yellow. Now none of these operations could have been effected without a practical chemical knowledge. The system of bleaching now practiced in this country, but recently introduced, has been used from time immemorial in the East, and doubtless, therefore, in ancient Egypt, viz. by immersion in a regenerated muriate of lime, after subjection to the action of steam or boiling water. The three other colors, blue, red, and yellow, are adjective colors, i. e. fugitive without the use of mordants. They could not be fixed, as we find them fixed, without their proper mordants, namely, oxides of tin, arsenic, and iron. Occasionally the muslin, beautifully dyed and patterned, was interwoven with silver and gold thread, and specimens of which can be traced up to the early period of Thothmes I, and even of Osirtasen. Indeed, the richly-painted walls and palaces, as well as the unmatched gilding, as fresh as when first laid on, show a perfect familiarity among the ancient Egyptians, not with mineral and vegetable colors only, but the perfect use of the metallic oxides in their composition.

The colors of the Egyptians were principally blue, red, green, black, yellow, and white. The red was an earthy bole; the yellow an iron ochre; the green was a mixture of a little ochre with a pulverulent glass, made by vitrefying the oxides of copper and iron with sand and soda; the blue was a glass of like composition with the ochreous addition; the black was blue or ivory black, and the white was a very pure chalk. They were mixed with water, and apparently a little gum, to render them tenacious and adhesive. With the Egyptians, the favorite combination of color was red, blue, and green; when black was introduced, yellow was added to harmonize with it; and in like manner they sought for every hue its congenial companion. They also guarded against the false effect of two colors in juxtaposition, as of red and blue, by placing between them a narrow line of white or yellow. They had few mixed colors, though purple, pink, orange and brown are met with, and frequently on papyrus. The blue, which is very brilliant, consists of fine particles of blue glass, and may be considered equivalent to our smalt; it seems to be the same that Vitruvius describes, which he supposes to have been first made at Alexandria; and it also agrees with the artificial *kyanus* of Theophrastus, invented in Egypt, which he says was laid on thicker than the native (or lapis lazuli). The thickness of the blue on the ceilings in Belzoni's tomb confirms his remark. The green is also a glass in powder, mixed with particles of colorless glass, to which it owes its brightness (Wilkinson. *Asc. Eg.*, abridgm., ii, 292).

The following statements are from Winer, i, 32. There are many kinds of hues, both natural and artificial, mentioned in the Bible as fashionable or known among the Hebrews; besides white (לָבָן) and black (שָׁחוֹר), there were: 1, principally red (אָדָם, brownish-red), crimson (צָרְבָרִיב, purple or violet-red (אַרְבָּנָה), orange or vermilion (שָׁשִׁי); 2, next green (יָרֹקֶק); 3, pale yellow (יָהוּדִי); 4, azure or ceruleine (purplish) blue (תְּכֵלֶת); 5, brown or fox-colored (שָׁרִי). Many of these are no doubt properly, at least originally, the designation of the coloring materials. See CRIMSON; VERMILION; PURPLE. It is evident that each of these principal colors had a special significance among the Israelites, according to which it would be selected whenever there was an op-

n; and it could not but be that some colors would preferred to others, e. g. white garments as the thing of the respectable (as among us black is the rical color), but dignitaries were arrayed in purple (dg. viii, 26; Esth. viii, 15; Dan. v, 7, 16, 29; comp. nt. vii, 6), which hue was probably so appropriated account of its costliness (comp. the purple sails of Syrian ships, Ezek. xxvii, 7). See APPAREL. ight, dazzling colors (צִבְצִימִים) further indicated, as ght naturally be supposed, hilarity and joy (2 Sam. 24; comp. Jer. iv, 80), while dark (black) and dull es were expressive of grief and dejection (Mal. iii, ; Zech. vi, 2, 6; comp. Plutarch, *Pericli*. 38; Mish., *Middoth*, v, 8; Apulei *Metam.* ii, p. 40 Bip.; see nerally Götze, *De vestium nigrar. usu*, Helmst. 1726). uth and age also constituted a distinction in this spect. White, moreover, was assumed as the color whatever form came from heaven (as being that of e purest light); hence angels were clad in glittering hite robes (Mark xvi, 5; John xx, 12, etc.). The mbolical use of colors is clearly exhibited in the ophetic visions. In Rev. vi, 2 sq., the rider upon e white horse is emblematical of one bringing prosperity like victorious champions, the red horse signifies bloodshed, the black denotes the distress of dearth id scarcity, the pale one (χλωρός) death. So when Rev. xii, 3) the great dragon (Satan) is depicted red, appears altogether congruous with the character of the riginator of death and of every ruin (Isa. i, 18; comp. er. 18; see Bähr, *Symbol.* i, 385 sq.; also Rev. xvii,). More difficult of interpretation are the colored eeds of Zech. i, 8; vi, 2 sq., which passages certainly served as a model to the revelator. In matters of orship (Krause, *De colore sancto*, Viterb. 1707), colorymbols take a wider range (Crenzer, *Symbol.* i, 125 q.). The priests in general wore white vestments, to ndicate the purity of the divine Being whom they erved. When idols were painted with vermilion

Rom. 98), this color was not only selected for its brilliancy, but as that with which even the Romans, in early times, decorated their triumphant warriors (Plin. xxxiii, 36). Hence purple robes were used for robing the statues of the gods (Jer. x, 9; Crenzer, *Symbol.* i, 126; ii, 358). In the Israelitish cultus the four principal colors occur: dark (or purplish) blue, purple-red, crimson, and white (the three essential colors, white, blue, and red, also occur in Rev. xviii, 16); they appear connectedly in the decorations (tapestry and veils) of the tabernacle (Exod. xxv, 4; xxvi, 1, 81, 86; xxxv, 6 sq.; xxxvi, 8 sq.), and in the sacerdotal garments (Exod. xxviii, 5 sq., 15; xxxix, 1). Moreover, scarlet and deep blue cloths are prescribed for the transportation of the sacred furniture (Num. iv), and scarlet wool for certain purificatory purposes (Lev. xiv, 4, 6, 51 sq.; Num. xix, 6); and the tassels to the four corners of the covering, which had a religious significance, were to be made of dark blue materials (Num. xv, 38). Perhaps these four colors were selected not merely on account of their beauty and costliness (God demands the best that man has), but with reference to their special mystical import, which in the last instance (the ritual of purification) is more evident. Philo (*Opp.* i, 586; ii, 148) and Josephus (*Ant.* iii, 7, 7) too have already an explanation of the four sacred colors (comp. *Stud. u. Krit.* 1844, ii, 815 sq.). See Friederich, *Symbol. d. mos. Stifftshütte* (Leipz. 1841). Comp. COLOR.

DYED ATTIRE stands in our version of Ezek. xxiii, 15, as a translation of טְבִילִים (tebulim', usually regarded as from טָבַל, to dip, and so to dye with colors; but Gesenius prefers the derivation from an Ethiopic verb signifying to wind or wrap around, and so giving the sense of), head-bands or tiaras. The Sept. and Vulg. combine both significations (τιάραι βαπτῆαι, tiaras tinctas). See PANT.

Dysentery. See FLUX.

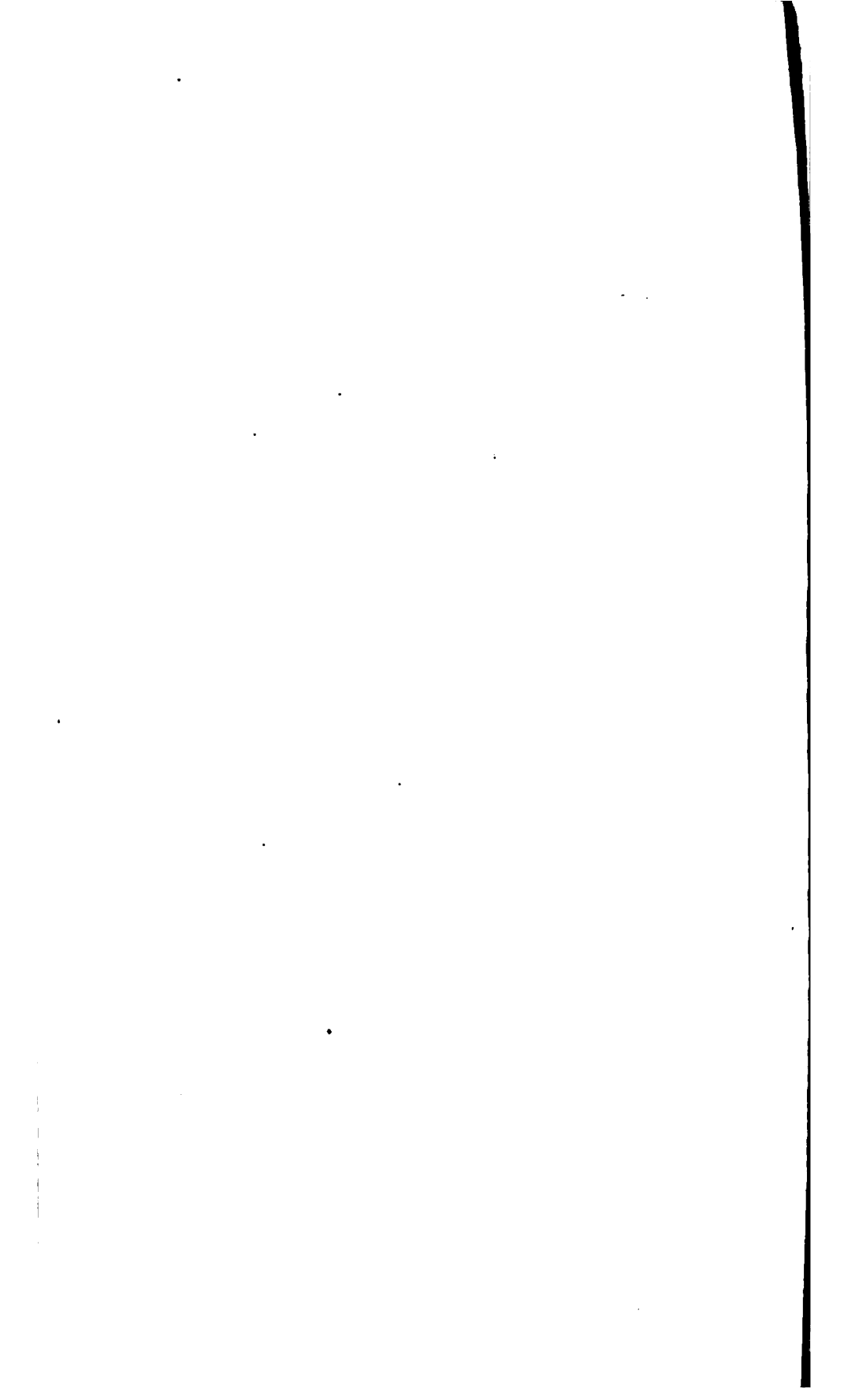

Calde-Syria.....	Page 899	Commune.....	Page 441	Cononites.....	Page 488	Corinth.....	Page 507	Covetousness.....	Page 546
Calicolas.....	400	Communicants.....	441	Conrad.....	484	Corinthian.....	510	Cow.....	547
Calnobites (A.J.S.).....	400	Communicatio Idiomatum.....	441	Conring.....	484	Corinthian Order.....	510	Coward.....	547
Caloffer.....	400	Communicative Life.....	442	Consalvi.....	484	Corinthians, First.....	510	Cowl.....	547
Caloffin.....	400	Communio Laica.....	442	Consanguinity.....	484	Corinthians, Second.....	512	Cowles.....	547
Caloffin (modern).....	401	Communio Peregrina.....	442	Conscientiarum (A.J.S.).....	484	Epistle to.....	510	Cowper.....	548
Caloffin, Charles.....	401	Communio.....	442	Consecration.....	484	Corinthians, Apocryphal Epistles to and from.....	514	Cox, F. A.....	548
Calogran.....	401	Communio, Close.....	443	Consecration (Christian).....	485	Corn.....	514	Cox, Melville B.....	548
Calogwell.....	401	Communio in both kinds.....	443	Consensus Genevensis.....	486	Cornelius (D.D.).....	514	Cox, Richard.....	548
Calohabitation.....	401	Communio of Saints.....	444	Consensus Tigurinus.....	486	Cornelius (bishop).....	517	Cos.....	548
Calohort.....	402	Communio Service.....	444	Consilia Evangelica.....	486	Cornelius et Lapide.....	517	Cosbri.....	548
Calohin.....	402	Communio-table.....	444	Consistory.....	486	Cornelius, Elias.....	518	Crackling.....	548
Calohin MS.....	408	Communio(J.N.P.).....	444	Console.....	486	Cornelius, Elias.....	518	Cracknel.....	548
Calohin Fragments.....	408	Communio of goods.....	447	Constant.....	487	Cornelius, Elias.....	518	Cracknell, Samuel.....	549
Caloke (A.S.).....	403	Compass.....	447	Constantine, Emperor.....	487	Cornelius, Elias.....	518	Craddock, Walter.....	549
Calola.....	404	Compel.....	447	Constantine, Pope (A.J.S.).....	488	Cornet.....	519	Craftman.....	549
Calolabarus (A.J.S.).....	404	Complegne.....	447	Constantinople (G.F.C.).....	488	Cornice.....	520	Craig.....	549
Calolbert, Charles J. N.....	404	Compestes.....	447	Constantinople, Councils of.....	490	Corona.....	521	Craikanthorp.....	549
Calolbert, Jacques N.....	404	Completorium.....	447	Constellation.....	490	Coronati.....	521	Cramer.....	549
Calolbert MS.....	406	Compostella, Order of (A.J.S.).....	448	Constitutions and Canons, Books of.....	492	Corporal.....	521	Crane.....	550
Calolbert, William.....	406	Comprehension.....	448	Constitutions and Canons, Books of.....	492	Corporal Inflictions.....	521	Crane, John.....	550
Calole, Henry.....	406	Compton.....	448	Consubstantial.....	492	Corporation.....	522	Cranmer.....	550
Calole, Thomas.....	406	Comstock.....	448	Consubstantiation.....	492	Corpus.....	522	Crassus.....	558
Caloleridge.....	406	Comte (G.F.H.).....	448	Consubstantiation.....	492	Corpus Catholicorum (A.J.S.).....	522	Crates.....	558
Caloles, Eliza.....	407	Conanah, 1.....	451	Consubstantiation.....	492	Corpus Christi.....	522	Crato v. Crafftheim (A.J.S.).....	558
Caloles, George.....	407	Conanah, 2.....	451	Consubstantiation.....	492	Corpus Doctrinae (A.J.S.).....	522	Cravens.....	558
Calolet.....	407	Conception of Christ.....	451	Consubstantiation.....	492	Corpus Doctrinae (A.J.S.).....	522	Crawford, Elijah.....	553
Calohoseah.....	407	Conception of Mary.....	451	Consubstantiation.....	492	Corpus Doctrinae (A.J.S.).....	522	Crawford, John.....	553
Calolign.....	407	Conchla.....	451	Consubstantiation.....	492	Corpus Doctrinae (A.J.S.).....	522	Creagh.....	553
Calolius.....	408	Concellabule.....	451	Consubstantiation.....	492	Corpus Doctrinae (A.J.S.).....	522	Creation (J.F.H.).....	554
Caloliar.....	408	Concellation.....	451	Consubstantiation.....	492	Corpus Doctrinae (A.J.S.).....	522	Creacionism (P.S.).....	557
Caloliation.....	409	Conclave (J.W.M.).....	451	Consubstantiation.....	492	Corpus Doctrinae (A.J.S.).....	522	Creature.....	557
Calollect.....	410	Concomitant.....	452	Consubstantiation.....	492	Corpus Doctrinae (A.J.S.).....	522	Creatures, Living.....	558
Calollection.....	410	Concord, Formula of (A.J.S.).....	453	Consubstantiation.....	492	Corpus Doctrinae (A.J.S.).....	522	Credence-table.....	558
Calollector.....	410	Concordance.....	454	Consubstantiation.....	492	Corpus Doctrinae (A.J.S.).....	522	Creditor.....	558
Calollege.....	410	Concordat (A.J.S.).....	454	Consubstantiation.....	492	Corpus Doctrinae (A.J.S.).....	522	Credner.....	558
Calollege (literary).....	410	Concubinage.....	456	Consubstantiation.....	492	Corpus Doctrinae (A.J.S.).....	522	Creed.....	558
Calollegia Pontificia (A.J.S.).....	411	Concubine.....	456	Consubstantiation.....	492	Corpus Doctrinae (A.J.S.).....	522	Creed, Athanasian.....	560
Calollegial Church.....	411	Concupiscences.....	459	Consubstantiation.....	492	Corpus Doctrinae (A.J.S.).....	522	Creed, Nicene.....	562
Calollegial System (A.J.S.).....	411	Conder.....	461	Consubstantiation.....	492	Corpus Doctrinae (A.J.S.).....	522	Creed of Pius IV.....	563
Calollegians.....	411	Condescension.....	461	Consubstantiation.....	492	Corpus Doctrinae (A.J.S.).....	522	Creek.....	563
Calollier, Jeremy.....	411	Condict (W.J.R.T.).....	462	Consubstantiation.....	492	Corpus Doctrinae (A.J.S.).....	522	Creeching Thing.....	563
Calollier, Joseph A (W.J.R.T.).....	411	Condignity.....	462	Consubstantiation.....	492	Corpus Doctrinae (A.J.S.).....	522	Creighton.....	563
Calollier, William.....	411	Conducit.....	463	Consubstantiation.....	492	Corpus Doctrinae (A.J.S.).....	522	Urell, Johannes.....	564
Calolins, Anthony.....	412	Conduite.....	463	Consubstantiation.....	492	Corpus Doctrinae (A.J.S.).....	522	Urell, Nicholas.....	564
Calolins, John.....	412	Cone.....	464	Consubstantiation.....	492	Corpus Doctrinae (A.J.S.).....	522	Urell, Samuel.....	564
Calolins, John A.....	412	Coney.....	464	Consubstantiation.....	492	Corpus Doctrinae (A.J.S.).....	522	Urescens.....	564
Calolins, Judson D.....	412	Coney.....	464	Consubstantiation.....	492	Corpus Doctrinae (A.J.S.).....	522	Urescens (philosopher).....	564
Calolins, Wellington H.....	412	Confection.....	465	Consubstantiation.....	492	Corpus Doctrinae (A.J.S.).....	522	Urescent.....	564
Caloln (A.J.S.).....	412	Confection.....	465	Consubstantiation.....	492	Corpus Doctrinae (A.J.S.).....	522	Urepsin.....	564
Calolops.....	413	Confession.....	465	Consubstantiation.....	492	Corpus Doctrinae (A.J.S.).....	522	Urepsin.....	564
Calolpyridians.....	413	Confession, Free-Will Baptist.....	465	Consubstantiation.....	492	Corpus Doctrinae (A.J.S.).....	522	Urepsin.....	564
Calolman (D.D.).....	413	Confession, Hampton-Court.....	466	Consubstantiation.....	492	Corpus Doctrinae (A.J.S.).....	522	Urepsin.....	564
Calolman, Benjamin.....	413	Confession, Methodist.....	466	Consubstantiation.....	492	Corpus Doctrinae (A.J.S.).....	522	Urepsin.....	564
Calolone (A.J.S.).....	413	Confession, Pastoral (A.J.S.).....	466	Consubstantiation.....	492	Corpus Doctrinae (A.J.S.).....	522	Urepsin.....	564
Calolonna.....	414	Confession, Roman Catholic (A.J.S.).....	466	Consubstantiation.....	492	Corpus Doctrinae (A.J.S.).....	522	Urepsin.....	564
Calolonna, Giovanni.....	415	Confession, Savoy.....	466	Consubstantiation.....	492	Corpus Doctrinae (A.J.S.).....	522	Urepsin.....	564
Calolony.....	415	Confession.....	466	Consubstantiation.....	492	Corpus Doctrinae (A.J.S.).....	522	Urepsin.....	564
Calolor.....	415	Confession of Faith.....	466	Consubstantiation.....	492	Corpus Doctrinae (A.J.S.).....	522	Urepsin.....	564
Calolora, Christian Symbolism of (G.F.C.).....	419	Confessional (A.J.S.).....	468	Consubstantiation.....	492	Corpus Doctrinae (A.J.S.).....	522	Urepsin.....	564
Calolossa.....	419	Confessor.....	468	Consubstantiation.....	492	Corpus Doctrinae (A.J.S.).....	522	Urepsin.....	564
Calolossians, Epistle to.....	420	Confirmation.....	468	Consubstantiation.....	492	Corpus Doctrinae (A.J.S.).....	522	Urepsin.....	564
Calolot.....	423	Confirmation.....	468	Consubstantiation.....	492	Corpus Doctrinae (A.J.S.).....	522	Urepsin.....	564
Calolouba (D.D.).....	423	Confirmitas.....	470	Consubstantiation.....	492	Corpus Doctrinae (A.J.S.).....	522	Urepsin.....	564
Calolumbanus (D.D.).....	424	Confirmitas.....	470	Consubstantiation.....	492	Corpus Doctrinae (A.J.S.).....	522	Urepsin.....	564
Calolun.....	425	Confirmitas.....	470	Consubstantiation.....	492	Corpus Doctrinae (A.J.S.).....	522	Urepsin.....	564
Calolombas.....	425	Confirmitas.....	470	Consubstantiation.....	492	Corpus Doctrinae (A.J.S.).....	522	Urepsin.....	564
Calolomber, Thomas, 1.....	426	Confirmitas.....	470	Consubstantiation.....	492	Corpus Doctrinae (A.J.S.).....	522	Urepsin.....	564
Calolomber, Thomas, 2.....	426	Confirmitas.....	470	Consubstantiation.....	492	Corpus Doctrinae (A.J.S.).....	522	Urepsin.....	564
Calolomenta.....	426	Confirmitas.....	470	Consubstantiation.....	492	Corpus Doctrinae (A.J.S.).....	522	Urepsin.....	564
Calolomer.....	426	Confirmitas.....	470	Consubstantiation.....	492	Corpus Doctrinae (A.J.S.).....	522	Urepsin.....	564
Caloloming of Christ.....	426	Confirmitas.....	470	Consubstantiation.....	492	Corpus Doctrinae (A.J.S.).....	522	Urepsin.....	564
Calolommandary (A.J.S.).....	426	Confirmitas.....	470	Consubstantiation.....	492	Corpus Doctrinae (A.J.S.).....	522	Urepsin.....	564
Calolommandments, the Five (A.J.S.).....	426	Confirmitas.....	470	Consubstantiation.....	492	Corpus Doctrinae (A.J.S.).....	522	Urepsin.....	564
Calolommandam.....	427	Confirmitas.....	470	Consubstantiation.....	492	Corpus Doctrinae (A.J.S.).....	522	Urepsin.....	564
Calolommandone (A.J.S.).....	427	Confirmitas.....	470	Consubstantiation.....	492	Corpus Doctrinae (A.J.S.).....	522	Urepsin.....	564
Calolommentary.....	427	Confirmitas.....	470	Consubstantiation.....	492	Corpus Doctrinae (A.J.S.).....	522	Urepsin.....	564
Calolommerce.....	427	Confirmitas.....	470	Consubstantiation.....	492	Corpus Doctrinae (A.J.S.).....	522	Urepsin.....	564
Calolommination.....	427	Confirmitas.....	470	Consubstantiation.....	492	Corpus Doctrinae (A.J.S.).....	522	Urepsin.....	564
Calolommissionary.....	427	Confirmitas.....	470	Consubstantiation.....	492	Corpus Doctrinae (A.J.S.).....	522	Urepsin.....	564
Calolommission.....	427	Confirmitas.....	470	Consubstantiation.....	492	Corpus Doctrinae (A.J.S.).....	522	Urepsin.....	564
Calolommissioner.....	427	Confirmitas.....	470	Consubstantiation.....	492	Corpus Doctrinae (A.J.S.).....	522	Urepsin.....	564
Calolommodianus (A.J.S.).....	427	Confirmitas.....	470	Consubstantiation.....	492	Corpus Doctrinae (A.J.S.).....	522	Urepsin.....	564
Calolommodus (A.J.S.).....	427	Confirmitas.....	470	Consubstantiation.....	492	Corpus Doctrinae (A.J.S.).....	522	Urepsin.....	564
Calolommon.....	427	Confirmitas.....	470	Consubstantiation.....	492	Corpus Doctrinae (A.J.S.).....	522	Urepsin.....	564
Calolommon-house.....	427	Confirmitas.....	470	Consubstantiation.....	492	Corpus Doctrinae (A.J.S.).....	522	Urepsin.....	564
Calolommon Prayer.....	427	Confirmitas.....	470	Consubstantiation.....	492	Corpus Doctrinae (A.J.S.).....	522	Urepsin.....	564
Calonites.....	Page 488	Cononites.....	Page 488	Corinth.....	Page 507	Covetousness.....	Page 546		
Conrad.....	484	Conrad.....	484	Corinthian.....	510	Cow.....	547		
Conring.....	484	Conring.....	484	Corinthian Order.....	510	Coward.....	547		
Consalvi.....	484	Consalvi.....	484	Corinthians, First.....	510	Cowl.....	547		
Consanguinity.....	484	Consanguinity.....	484	Epistle to.....	510	Cowles.....	547		
Conscientiarum (A.J.S.).....	484	Conscientiarum (A.J.S.).....	484	Corinthians, Second.....	512	Cowper.....	548		
Consecration.....	484	Consecration.....	484	Epistle to.....	512	Cox, F. A.....	548		
Consecration (Christian).....	485	Consecration (Christian).....	485	Corinthians, Apocryphal Epistles to and from.....	514	Cox, Melville B.....	548		
Consensus Genevensis.....	486	Consensus Genevensis.....	486	Corn.....	514	Cox, Richard.....	548		
Consensus Tigurinus.....	486	Consensus Tigurinus.....	486	Cornelius (D.D.).....	514	Cos.....	548		
Consilia Evangelica.....	486	Consilia Evangelica.....	486	Cornelius (bishop).....	517	Cosbri.....	548		
Consistory.....	486	Consistory.....	486	Cornelius et Lapide.....	517	Crackling.....	548		
Console.....	486	Console.....	486	Cornelius, Elias.....	518	Cracknel.....	548		
Constant.....	487	Constant.....	487	Cornelius, Elias.....	518	Cracknell, Samuel.....	549		
Constantine, Emperor.....	487	Constantine, Emperor.....	487	Cornelius, Elias.....	518	Craddock, Walter.....	549		
Constantine, Pope (A.J.S.).....	488	Constantine, Pope (A.J.S.).....	488	Cornet.....	519	Craftman.....	549		
Constantinople (G.F.C.).....	488	Constantinople (G.F.C.).....	488	Cornice.....	520	Craig.....	549		
Constantinople, Councils of.....	490	Constantinople, Councils of.....	490	Corona.....	521	Craikanthorp.....	549		
Constellation.....	490	Constellation.....	490	Coronati.....	521	Cramer.....	549		
Constitutions and Canons, Books of.....	492	Constitutions and Canons, Books of.....	492	Corporal.....	521	Crane.....	550		
Consubstantial.....	492	Consubstantial.....	492	Corporal Inflictions.....	521	Crane, John.....	550		
Consubstantiation.....	492	Consubstantiation.....	492	Corporation.....	522	Cranmer.....	550		
Consubstantiation.....	492	Consubstantiation.....	492	Corpus.....	522	Crassus.....	558		
Consubstantiation.....	492	Consubstantiation.....	492	Corpus Catholicorum (A.J.S.).....	522	Crates.....	558		
Consubstantiation.....	492	Consubstantiation.....	492	Corpus Christi.....	522	Crato v. Crafftheim (A.J.S.).....	558		
Consubstantiation.....	492	Consubstantiation.....	492	Corpus Doctrinae (A.J.S.).....	522	Cravens.....	558		
Consubstantiation.....	492	Consubstantiation.....	492	Corpus Doctrinae (A.J.S.).....	522	Crawford, Elijah.....	553		
Consubstantiation.....	492	Consubstantiation.....	492	Corpus Doctrinae (A.J.S.).....	522				

Crown.....	Page 688	Dabbesheth.....	Page 688	Daughter.....	Page 684	Deleada.....	Page 732	Diaz, Francisco I	Page 732
Crown of Thorns.....	686	Dabereth.....	688	Davenport, Christo-	684	Delegates, Court of.....	732	Diaz, J.S.....	Page 732
Crucifix (G.F.C.).....	686	Dabria.....	688	Davenport, Christo-	684	Delfau (A.J.S.).....	732	Diaz, Pedro (A.J.S.)	Page 732
Crucifixion.....	688	Dach.....	688	pher.....	684	Delliah.....	732	Dibdin.....	Page 732
Cruciger (A.J.S.).....	692	Dacobi.....	688	Davenport, John.....	684	Dellus.....	732	Diblahim.....	Page 732
Cruden.....	698	Da Costa.....	689	David.....	685	Deluge.....	732	Dibbath.....	Page 732
Crumbaugh (H.H.).....	698	Daddues.....	689	David, City of, 1.....	699	Delus.....	740	Diblahaim.....	Page 740
Crusades (A.J.S.).....	698	Dadmon.....	689	David, City of, 2.....	699	Demas.....	740	Dibon, 1.....	Page 740
Cruse.....	695	Dadmoniac.....	640	David, St.....	700	Demetrius Soter.....	740	Dibon, 2.....	Page 740
Crused.....	696	Dagger.....	642	David, Christian.....	700	Demetrius Nicator.....	741	Dibon-gad.....	Page 741
Crusius.....	696	Daggett, Herman.....	642	David of Dinanto.....	700	Demetrius Eucerus.....	741	Dibrell.....	Page 741
Cryer.....	696	Daggett, Naphthali.....	642	David of Mt. Libanus.....	700	Demetrius Phalereus.....	742	Dibri.....	Page 742
Crypt.....	696	Dagon.....	643	David of Augsburg.....	700	Demetrius, 5.....	742	Dick, John.....	Page 742
Crypto-Calvinistic		Dagon's House.....	643	David's, St.....	700	Demetrius, 6.....	742	Dick, Thomas.....	Page 742
Controversy.....	597	Dalley.....	644	Davidson (R.D.).....	700	Demetrius, 7.....	742	Dickey, John M.....	Page 742
Crystal.....	597	Dallo.....	644	Davies.....	701	Demetrius, 8.....	742	Dickey, William.....	Page 742
Cubit.....	598	Dally.....	644	Davis, Charles A.....	701	Demetrius of Alex-		Dickies (A.S.).....	
Cuckoo.....	598	Dally Offering.....	644	Davis, John.....	701	andria.....	743	Dickinson, Austin.....	
Cucumber.....	599	Dally Service.....	645	Davis, Noah.....	701	Demetrius Cydonius		Dickinson, Jonathan.....	
Cud.....	599	Dalibert (A.J.S.).....	645	Davison.....	701	(A.J.S.).....	743	Dickinson, Peart.....	
Cudworth.....	599	Dalsan.....	645	Dawes.....	701	Demilusion.....	742	Dickson.....	
Cujaciua (A.J.S.).....	600	Dalalah.....	645	Dawn.....	701	Demirurge.....	742	Dictates of Gregory.....	
Culbertson.....	600	Dalberg.....	645	Day.....	702	Demme (M.L.S.).....	742	Dictionaries, Biblical.....	
Culdees (B.H.N.).....	600	Dale (J.P.W.).....	645	Day's Journey.....	703	Demophon.....	743	Dictionaries, Etymol-	
Culon.....	602	Dales.....	645	Day, Jeremiah.....	704	Dempster, John.....	743	ogical.....	
Culverwell.....	602	Dalietes.....	646	Daysman.....	704	Dempster, Thomas.....	743	logical.....	
Cumanus.....	602	Dalmanutha.....	646	Day-spring.....	704	Den.....	743	Dierrot.....	
Cumberland.....	602	Dalmatia (A.J.S.).....	646	Day-star.....	704	Denarius.....	744	Didier (A.J.S.).....	
Cumi.....	602	Dalmatic.....	646	Deacon.....	704	Denderah.....	744	Didier, St. (A.J.S.).....	
Cumin.....	602	Dalphon.....	646	Deaconess.....	707	Denial of Christ.....	745	Didymus the Blind.....	
Cumming.....	603	Dam.....	646	Head.....	709	Denle, St.....	745	Didymus of Alexan-	
Cuneiform.....	603	Damages.....	646	Dead Sea.....	709	Denlis, St., Abbey of.....	745	dria.....	
Cunigunda.....	604	Damaris.....	647	Dead, Prayers for the	710	Denlis, Michael.....	745	Didymus, Gabriel.....	
Cunningham.....	604	Damasceum.....	647	Deaf.....	711	Denk.....	745	Diefenbacher.....	
Cup.....	606	Damasus.....	647	Deal.....	711	Denmark (A.J.S.).....	745	Diepenbrock (A.J.S.)	
Cup-bearer.....	607	Damasus (A.J.S.).....	652	Dealtry.....	711	Denominations, the		Dies Absolutis.....	
Cupboard.....	607	Damasus I (A.J.S.).....	652	Dean.....	711	Three.....	747	Dies Cinerum.....	
Curcellenus.....	607	Damasus II (A.J.S.).....	652	Dean of the Chapel		Dens.....	748	Dies Coenae Dominice	
Curate.....	608	Damian (A.J.S.).....	652	Royal.....	712	Deontology.....	748	Dies Dominicis.....	
Cure.....	608	Damianists (A.J.S.).....	653	Death.....	712	Dependence.....	748	Dies Ire (P.S.).....	
Cureton.....	609	Dammation.....	653	Death, Theological		Deposit.....	748	Dies Luminum.....	
Curia Romana (A.J.		Dan, 1.....	653	Aspects of.....	713	Deposition.....	749	Dies (food).....	
S.).....	609	Dan, 2.....	653	Death, Brothers of.....	713	Depravity.....	749	Diet (assembly) (A.	
Curio.....	610	Dan, Tribe of.....	653	Debr, 1.....	715	Deprivation.....	749	J.S.).....	
Curious Arts.....	610	Dan, 3.....	655	Debr, 2.....	715	Deputy.....	749	Dieterich.....	
Curse.....	610	Dana, Daniel.....	656	Debr, 3.....	718	Derbe.....	750	Dietrich of Nunn.....	
Curtain.....	611	Dana, James.....	656	Debr, 4.....	718	Derreser (A.J.S.).....	750	Dietrich, Veit.....	
Curtius.....	611	Danaba.....	656	Debr, 5.....	718	Derham.....	750	Dien, De (J.P.W.).....	
Cusa (A.J.S.).....	612	Dansus.....	656	Debra.....	718	Dering.....	750	Digameta.....	
Cush, 1.....	612	Dance.....	657	Deborah, 1.....	718	Derodon (A.J.S.).....	750	Digby.....	
Cush, Land of.....	612	Dancers.....	657	Deborah, 2.....	718	Derrishes (H.G.).....	750	Dight.....	
Cush, 2.....	616	Dancing.....	660	Debt.....	717	Des Cartes (G.F.H.).....	752	Dignities.....	
Cushan.....	616	Dandini (A.J.S.).....	660	Debtor.....	717	Desert.....	752	Dikhah.....	
Cushi, 1.....	616	Dandini (A.J.S.).....	660	Decalogue.....	718	Desire.....	752	Dillan.....	
Cushi, 2.....	616	Danforth, Calvin.....	660	Decapolis.....	721	Desk.....	753	Dill.....	
Cushi, 3.....	616	Danforth, Joshua N.....	661	Decapolis.....	721	Desmares (A.J.S.).....	753	Dilbert.....	
Cushman.....	617	Danforth, Samuel, 1.....	661	Dechant (H.H.).....	722	Desolation.....	759	Dimitroff Letters.....	
Custom.....	617	Danforth, Samuel, 2.....	661	Dechant, Valley of.....	722	Desperati.....	759	Dinnaah.....	
Cuth.....	617	Daul, 1.....	661	Declus.....	722	Dessau.....	759	Dimon.....	
Cuthbert.....	617	Daul, 2.....	661	Declamation.....	722	Destroyer.....	759	Dimonah.....	
Cutler, Benjamin C.		Daniel, Book of.....	663	Declaration Thoru-		Deservants.....	759	Dinah.....	
(C.J.F.).....	618	Daniel, Apocryphal		ensis.....	722	Destruction of Bel		Dinnate.....	
Cutler, Manasseh.....	618	Additions to.....	671	De Courcy.....	722	and Dragon.....	760	Dine.....	
Cutler, Timothy.....	618	Daniel, 3.....	672	Decree.....	723	Determinism (A.J.		Dinhabah.....	
Cutting in the Flesh		Daniel the Stylite.....	672	Decrees of the Coun-		S.).....	760	Dinter.....	
Cutty-stool.....	620	Daniel of Winchester		cil of the Apostles.....	723	Detraction.....	761	Diocesan Episcopate.....	
Cuyler (W.J.R.T.).....	620	Dante.....	673	Decretals (A.J.S.).....	724	Detel.....	761	Diocese.....	
Cyamon.....	620	Dante of Winchestor		Decretals, Pseudo-		Deurhoff.....	761	Diocletian.....	
Cyaxares, 1.....	620	Dannah.....	673	Isidorian (A.J.S.).....	724	Deusdedit.....	761	Diodati, Jean.....	
Cyaxares, 2.....	621	Dannhauer.....	673	Decuriones.....	724	Deus miseretur.....	761	Diodati, Dominicus.....	
Cycle (A.J.S.).....	621	Dantius (A.J.S.).....	673	Decan, 1.....	725	Deusing (J.P.W.).....	762	Diodorus.....	
Cymbal.....	621	Danz, Johann A. (A.		Decan, 2.....	725	Deuteronomy.....	762	Diognetus, Epistle to	
Cypress.....	623	J.S.).....	674	Dedanim.....	725	Deuteronomy.....	767	(P.S.).....	
Cyprian.....	624	Danz, Johann T. L.		Dedicate.....	725	Devay (A.J.S.).....	773	Dionysia.....	
Cyprian MS.....	624	(A.J.S.).....	674	Dedication, Feast of		Development.....	773	Dionysius the Aro-	
Cyprian, St. (H.H.).....	624	Daphne, 1.....	674	Deep.....	727	Development, 4 (H.		pagite.....	
Cyriach.....	626	Daphne, 2.....	674	Deer.....	727	H.).....	775	Dionysius Alexan-	
Cypros, 1.....	626	Daphne, 3.....	674	Defence.....	727	Devil.....	776	drinus.....	
Cypros, 2.....	626	Daphne, 4.....	674	Defender of the Faith		Devotee.....	777	Dionysius of Corinth.....	
Cypros, 3.....	626	Dara.....	675	Defensor matrimonii		Devotion.....	777	Dionysius of Rome.....	
Cypros, 4.....	626	Darda.....	675	Defile.....	728	Dew.....	778	Dionysius Exiguus.....	
Cypros, 5.....	626	Daric.....	675	Degradation.....	728	De Witt (W. J. R.		Dionysius the Ca-	
Cyprus.....	626	Darius.....	675	Degree.....	728	T.).....	778	thasian.....	
Cyprus, Christianity		Darius of Mede.....	676	Degrees, Song of.....	728	Deviling.....	779	Dionysus.....	
in (A.J.S.).....	628	Darius of Persia.....	677	Degrees, honorary.....	729	Diabolus.....	779	Diopetes.....	
Cyrene.....	628	Darius the Persian.....	679	Dehavites.....	729	Diaconicum.....	779	Diocorinthius.....	
Cyrenian.....	629	Darkness.....	680	Dehon (H.C.W.).....	729	Diadem.....	779	Diocorus of Hecop-	
Cyrenius.....	629	Darikon.....	681	Dei Gratia.....	730	Diadochus (A.J.S.).....	780	olis.....	
Cyria.....	629	Darling.....	681	Delpara.....	730	Dial.....	780	Diocorus of Alexan-	
Cyriacus (pope) (A.		Darom.....	681	Delem.....	731	Diamond.....	780	dria.....	
J.S.).....	638	Dart.....	681	Deity.....	731	Diana.....	782	Diocorus, anti-pope.....	
Cyriacus (patriarch)		Dartius.....	681	Deity of Jesus Christ		Dias, Manoel, 1 (A.J.		Diocuri.....	
Cyrl of Alexandria		Dathe.....	682	Dekar.....	731	S.).....	784	Diocypolis, Synod of	
(J.W.M.).....	638	Date.....	682	Delalah, 1.....	731	Dias, Manoel, 2 (A.J.		Diotrophus.....	
Cyrl of Jerusalem.....	638	Dathan.....	683	Delalah, 2.....	731	S.).....	784	Diploma.....	
Cyrl (Constantine).....	634	Dathema.....	683	Delalah, 3.....	731	Dias, Manoel, 3 (A.J.		Diplomatics.....	
Cyrl Lucar (A.J.S.).....	634	Dathenus (J.P.W.).....	683	Delalah, 4.....	731	S.).....	784	Dippel.....	
Cyprus.....	636	Daub.....	688	Delalah, 5.....	731	Diaspora.....	784	Diptychs.....	
		Daubeny.....	684	Delancey.....	731	Diataxeis.....	784	Director of the Con-	
Dabarah.....	638	Daubus.....	684	Delany.....	731	Diatestamon.....	784	science.....	

Directory.....	818	Dodad.....	849	Doris.....	869	Dragon (in symbol- ism).....	888	Dulcimer.....	909
Dirge.....	814	Dodanah.....	850	Doroa.....	869	Dragon, Order of the (A.J.S.).....	888	Dulcinists.....	909
Discalceati (A.J.S.).....	814	Dodavah.....	850	Dorotheus the Egyp- tian.....	869	Dragonnades.....	884	Dulia.....	910
Discerning of Spir- its.....	815	Dodd, Charles.....	850	Dorotheus of Anti- och.....	869	Dram.....	884	Dumah, 1.....	910
Discipline.....	815	Dodd, William.....	850	Dorotheus of Tyre.....	869	Draught.....	884	Dumah, 2.....	910
Discipline of Christ (W.V.K.P.).....	816	Dodo, 1.....	851	Dorotheus of Pales- tine.....	869	Draught-house.....	884	Dumb.....	910
Discipline.....	816	Dodo, 2.....	851	Dort, Synod of.....	870	Drawl of water.....	884	Dumont.....	911
Discipline, Book of.....	818	Dodo, 3.....	851	Dorsche.....	869	Dream.....	885	Dumplers.....	911
Discipline, First Book of.....	818	Doderlein.....	852	Dort, Synod of.....	870	Dress.....	885	Dunash ben-Labrath (J.H.W.).....	911
Discipline, Second Book of.....	818	Doeg.....	852	Dortus.....	873	Dress, 2.....	886	Dunash ben-Tanin (J.H.W.).....	911
Discipline of the Lash.....	818	Dog.....	852	Dorymenes.....	873	Dress, 3.....	886	Dung.....	911
Disease.....	819	Doga.....	854	Dotheus, 1.....	873	Dress, 4.....	886	Dung-gate.....	912
Dish.....	820	Dogmatic Theology (A.J.S.).....	854	Dotheus, 2.....	873	Dress, 5.....	886	Dunghill.....	912
Dishon, 1.....	820	Doleful creatures.....	857	Dotheus, 3.....	873	Dress, 6.....	886	Dungl.....	912
Dishon, 2.....	820	Doleus.....	857	Dotheus, 4.....	873	Dress, 7.....	886	Dunham.....	912
Dishon, 3.....	820	Dome (G.F.C.).....	857	Dotheus the Sa- maritan.....	873	Dress, 8.....	886	Dunham.....	912
Dispensation.....	820	Dome (A.J.S.).....	857	Dotheus the Rus- sian.....	873	Dress, 9.....	886	Dunham.....	912
Dispersed Jews.....	821	Dominica in Albis.....	857	Dotheus of Jerusa- lem.....	873	Dress, 10.....	886	Dunham.....	912
Dispersion of Man- kind.....	823	Dominical.....	858	Dotheus of Jerusa- lem.....	873	Dress, 11.....	886	Dunham.....	912
Dissent.....	824	Dominical Letter.....	858	Dotheus of Jerusa- lem.....	873	Dress, 12.....	886	Dunham.....	912
Disidents.....	824	Dominicans (A.J.S.).....	858	Dotheus of Jerusa- lem.....	873	Dress, 13.....	886	Dunham.....	912
Distaff.....	825	Dominican Nuns (A.J.S.).....	859	Dotheus of Jerusa- lem.....	873	Dress, 14.....	886	Dunham.....	912
District.....	825	Domine.....	859	Dotheus of Jerusa- lem.....	873	Dress, 15.....	886	Dunham.....	912
Ditch.....	825	Domine.....	859	Dotheus of Jerusa- lem.....	873	Dress, 16.....	886	Dunham.....	912
Dithesam.....	825	Domine.....	859	Dotheus of Jerusa- lem.....	873	Dress, 17.....	886	Dunham.....	912
Dithmar.....	825	Domine.....	859	Dotheus of Jerusa- lem.....	873	Dress, 18.....	886	Dunham.....	912
Divan.....	825	Domine.....	859	Dotheus of Jerusa- lem.....	873	Dress, 19.....	886	Dunham.....	912
Diverse.....	826	Domine.....	859	Dotheus of Jerusa- lem.....	873	Dress, 20.....	886	Dunham.....	912
Divination.....	826	Domine.....	859	Dotheus of Jerusa- lem.....	873	Dress, 21.....	886	Dunham.....	912
Divine.....	826	Domine.....	859	Dotheus of Jerusa- lem.....	873	Dress, 22.....	886	Dunham.....	912
Divine Right.....	826	Domine.....	859	Dotheus of Jerusa- lem.....	873	Dress, 23.....	886	Dunham.....	912
Divinity.....	826	Domine.....	859	Dotheus of Jerusa- lem.....	873	Dress, 24.....	886	Dunham.....	912
Division.....	826	Domine.....	859	Dotheus of Jerusa- lem.....	873	Dress, 25.....	886	Dunham.....	912
Divisions in Corin- thian Church.....	826	Domine.....	859	Dotheus of Jerusa- lem.....	873	Dress, 26.....	886	Dunham.....	912
Division of Earth.....	826	Domine.....	859	Dotheus of Jerusa- lem.....	873	Dress, 27.....	886	Dunham.....	912
Divorce, Jewish.....	826	Domine.....	859	Dotheus of Jerusa- lem.....	873	Dress, 28.....	886	Dunham.....	912
Divorce, Christian Law of (T.W.).....	826	Domine.....	859	Dotheus of Jerusa- lem.....	873	Dress, 29.....	886	Dunham.....	912
Dizahab.....	844	Domine.....	859	Dotheus of Jerusa- lem.....	873	Dress, 30.....	886	Dunham.....	912
Doane.....	844	Domine.....	859	Dotheus of Jerusa- lem.....	873	Dress, 31.....	886	Dunham.....	912
Dober.....	844	Domine.....	859	Dotheus of Jerusa- lem.....	873	Dress, 32.....	886	Dunham.....	912
Dobnayer.....	844	Domine.....	859	Dotheus of Jerusa- lem.....	873	Dress, 33.....	886	Dunham.....	912
Dobritzhofer.....	844	Domine.....	859	Dotheus of Jerusa- lem.....	873	Dress, 34.....	886	Dunham.....	912
Docets (H.H.).....	844	Domine.....	859	Dotheus of Jerusa- lem.....	873	Dress, 35.....	886	Dunham.....	912
Doctor.....	845	Domine.....	859	Dotheus of Jerusa- lem.....	873	Dress, 36.....	886	Dunham.....	912
Doctor (academic).....	846	Domine.....	859	Dotheus of Jerusa- lem.....	873	Dress, 37.....	886	Dunham.....	912
Doctors Commons.....	846	Domine.....	859	Dotheus of Jerusa- lem.....	873	Dress, 38.....	886	Dunham.....	912
Doctrine, Christian Congregations of (A.J.S.).....	846	Domine.....	859	Dotheus of Jerusa- lem.....	873	Dress, 39.....	886	Dunham.....	912
Doctrines, History of (A.J.S.).....	847	Domine.....	859	Dotheus of Jerusa- lem.....	873	Dress, 40.....	886	Dunham.....	912
Docus.....	849	Domine.....	859	Dotheus of Jerusa- lem.....	873	Dress, 41.....	886	Dunham.....	912
Dod, Albert B.....	849	Domine.....	859	Dotheus of Jerusa- lem.....	873	Dress, 42.....	886	Dunham.....	912
Dod, John.....	849	Domine.....	859	Dotheus of Jerusa- lem.....	873	Dress, 43.....	886	Dunham.....	912
		Domine.....	859	Dotheus of Jerusa- lem.....	873	Dress, 44.....	886	Dunham.....	912
		Domine.....	859	Dotheus of Jerusa- lem.....	873	Dress, 45.....	886	Dunham.....	912
		Domine.....	859	Dotheus of Jerusa- lem.....	873	Dress, 46.....	886	Dunham.....	912
		Domine.....	859	Dotheus of Jerusa- lem.....	873	Dress, 47.....	886	Dunham.....	912
		Domine.....	859	Dotheus of Jerusa- lem.....	873	Dress, 48.....	886	Dunham.....	912
		Domine.....	859	Dotheus of Jerusa- lem.....	873	Dress, 49.....	886	Dunham.....	912
		Domine.....	859	Dotheus of Jerusa- lem.....	873	Dress, 50.....	886	Dunham.....	912
		Domine.....	859	Dotheus of Jerusa- lem.....	873	Dress, 51.....	886	Dunham.....	912
		Domine.....	859	Dotheus of Jerusa- lem.....	873	Dress, 52.....	886	Dunham.....	912
		Domine.....	859	Dotheus of Jerusa- lem.....	873	Dress, 53.....	886	Dunham.....	912
		Domine.....	859	Dotheus of Jerusa- lem.....	873	Dress, 54.....	886	Dunham.....	912
		Domine.....	859	Dotheus of Jerusa- lem.....	873	Dress, 55.....	886	Dunham.....	912
		Domine.....	859	Dotheus of Jerusa- lem.....	873	Dress, 56.....	886	Dunham.....	912
		Domine.....	859	Dotheus of Jerusa- lem.....	873	Dress, 57.....	886	Dunham.....	912
		Domine.....	859	Dotheus of Jerusa- lem.....	873	Dress, 58.....	886	Dunham.....	912
		Domine.....	859	Dotheus of Jerusa- lem.....	873	Dress, 59.....	886	Dunham.....	912
		Domine.....	859	Dotheus of Jerusa- lem.....	873	Dress, 60.....	886	Dunham.....	912
		Domine.....	859	Dotheus of Jerusa- lem.....	873	Dress, 61.....	886	Dunham.....	912
		Domine.....	859	Dotheus of Jerusa- lem.....	873	Dress, 62.....	886	Dunham.....	912
		Domine.....	859	Dotheus of Jerusa- lem.....	873	Dress, 63.....	886	Dunham.....	912
		Domine.....	859	Dotheus of Jerusa- lem.....	873	Dress, 64.....	886	Dunham.....	912
		Domine.....	859	Dotheus of Jerusa- lem.....	873	Dress, 65.....	886	Dunham.....	912
		Domine.....	859	Dotheus of Jerusa- lem.....	873	Dress, 66.....	886	Dunham.....	912
		Domine.....	859	Dotheus of Jerusa- lem.....	873	Dress, 67.....	886	Dunham.....	912
		Domine.....	859	Dotheus of Jerusa- lem.....	873	Dress, 68.....	886	Dunham.....	912
		Domine.....	859	Dotheus of Jerusa- lem.....	873	Dress, 69.....	886	Dunham.....	912
		Domine.....	859	Dotheus of Jerusa- lem.....	873	Dress, 70.....	886	Dunham.....	912
		Domine.....	859	Dotheus of Jerusa- lem.....	873	Dress, 71.....	886	Dunham.....	912
		Domine.....	859	Dotheus of Jerusa- lem.....	873	Dress, 72.....	886	Dunham.....	912
		Domine.....	859	Dotheus of Jerusa- lem.....	873	Dress, 73.....	886	Dunham.....	912
		Domine.....	859	Dotheus of Jerusa- lem.....	873	Dress, 74.....	886	Dunham.....	912
		Domine.....	859	Dotheus of Jerusa- lem.....	873	Dress, 75.....	886	Dunham.....	912
		Domine.....	859	Dotheus of Jerusa- lem.....	873	Dress, 76.....	886	Dunham.....	912
		Domine.....	859	Dotheus of Jerusa- lem.....	873	Dress, 77.....	886	Dunham.....	912
		Domine.....	859	Dotheus of Jerusa- lem.....	873	Dress, 78.....	886	Dunham.....	912
		Domine.....	859	Dotheus of Jerusa- lem.....	873	Dress, 79.....	886	Dunham.....	912
		Domine.....	859	Dotheus of Jerusa- lem.....	873	Dress, 80.....	886	Dunham.....	912
		Domine.....	859	Dotheus of Jerusa- lem.....	873	Dress, 81.....	886	Dunham.....	912
		Domine.....	859	Dotheus of Jerusa- lem.....	873	Dress, 82.....	886	Dunham.....	912
		Domine.....	859	Dotheus of Jerusa- lem.....	873	Dress, 83.....	886	Dunham.....	912
		Domine.....	859	Dotheus of Jerusa- lem.....	873	Dress, 84.....	886	Dunham.....	912
		Domine.....	859	Dotheus of Jerusa- lem.....	873	Dress, 85.....	886	Dunham.....	912
		Domine.....	859	Dotheus of Jerusa- lem.....	873	Dress, 86.....	886	Dunham.....	912
		Domine.....	859	Dotheus of Jerusa- lem.....	873	Dress, 87.....	886	Dunham.....	912
		Domine.....	859	Dotheus of Jerusa- lem.....	873	Dress, 88.....	886	Dunham.....	912
		Domine.....	859	Dotheus of Jerusa- lem.....	873	Dress, 89.....	886	Dunham.....	912
		Domine.....	859	Dotheus of Jerusa- lem.....	873	Dress, 90.....	886	Dunham.....	912
		Domine.....	859	Dotheus of Jerusa- lem.....	873	Dress, 91.....	886	Dunham.....	912
		Domine.....	859	Dotheus of Jerusa- lem.....	873	Dress, 92.....	886	Dunham.....	912
		Domine.....	859	Dotheus of Jerusa- lem.....	873	Dress, 93.....	886	Dunham.....	912
		Domine.....	859	Dotheus of Jerusa- lem.....	873	Dress, 94.....	886	Dunham.....	912
		Domine.....	859	Dotheus of Jerusa- lem.....	873	Dress, 95.....	886	Dunham.....	912
		Domine.....	859	Dotheus of Jerusa- lem.....	873	Dress, 96.....	886	Dunham.....	912
		Domine.....	859	Dotheus of Jerusa- lem.....	873	Dress, 97.....	886	Dunham.....	912
		Domine.....	859	Dotheus of Jerusa- lem.....	873	Dress, 98.....	886	Dunham.....	912
		Domine.....	859	Dotheus of Jerusa- lem.....	873	Dress, 99.....	886	Dunham.....	912
		Domine.....	859	Dotheus of Jerusa- lem.....	873	Dress, 100.....	886	Dunham.....	912

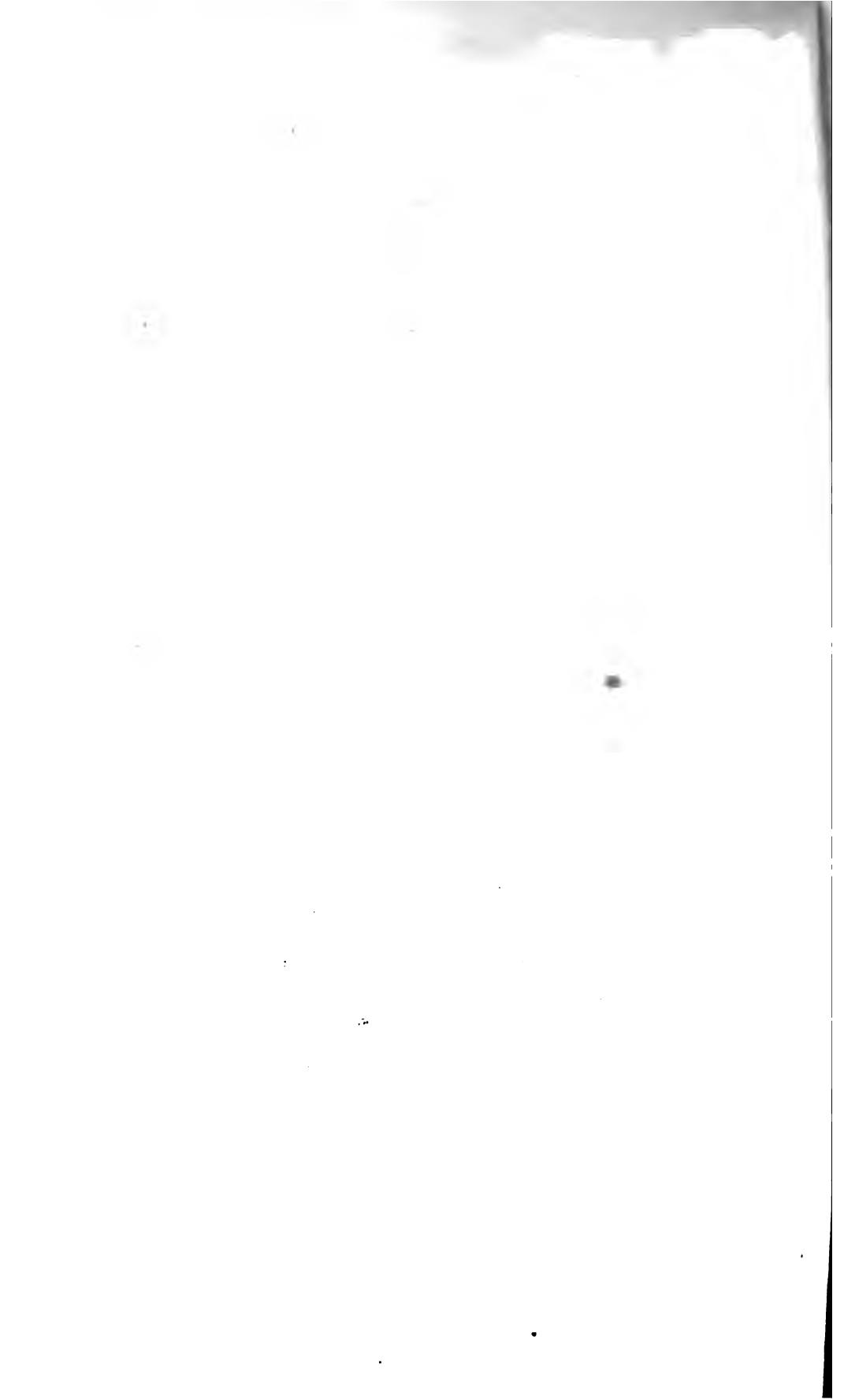

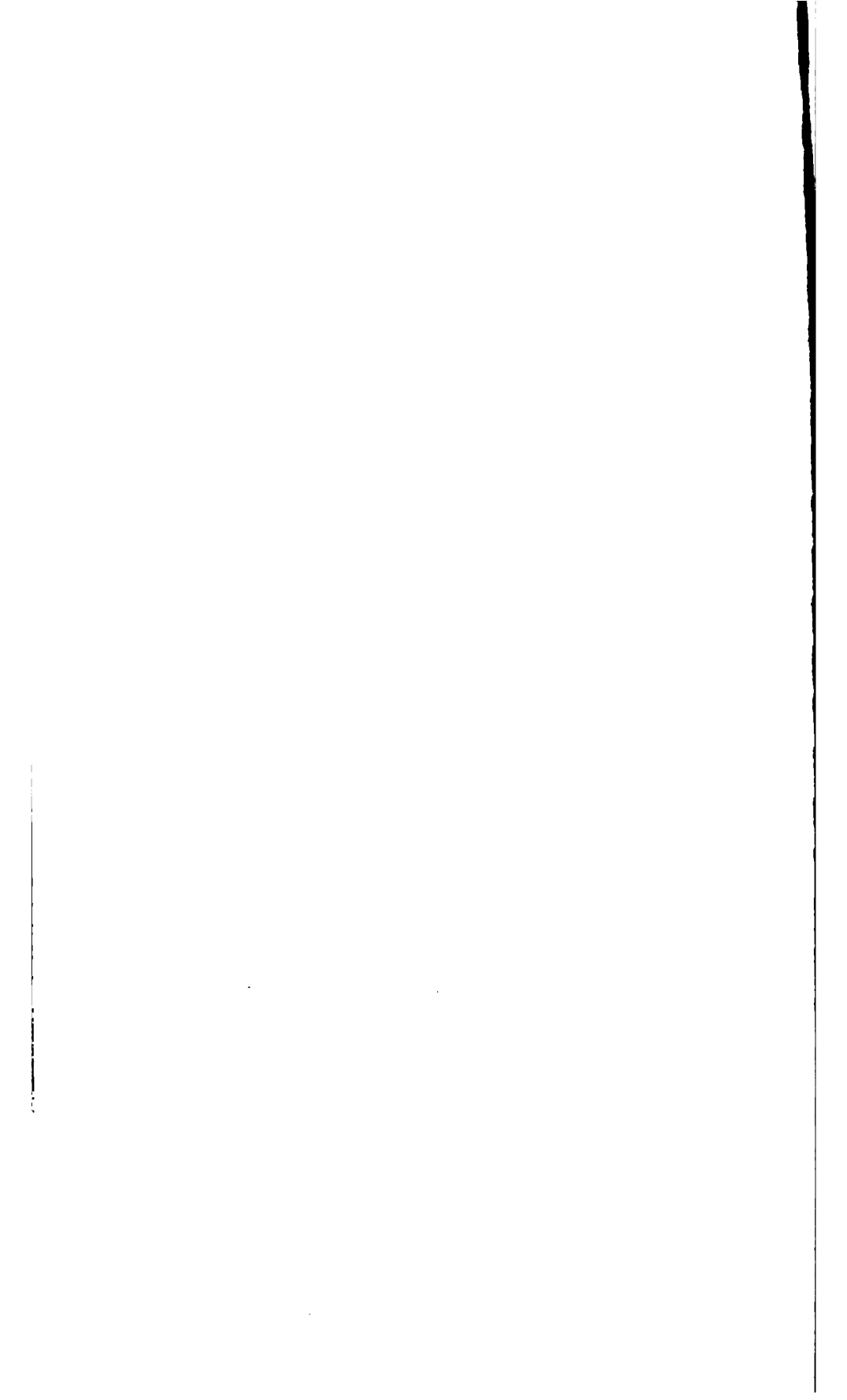

89094564549



B89094564549A

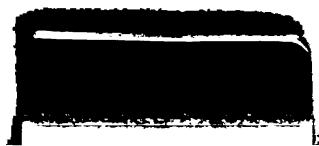

89094564549



b89094564549a